

Instruction manual ■■■

SmartDate X30



Printer overview



Start/Stop the printer



Selecting a job



Printer Menus



Printhead maintenance



Consumables



Troubleshooting -
Information



markem·imaje

a **DOVER** company

Printer overview

■ Printer Components

1

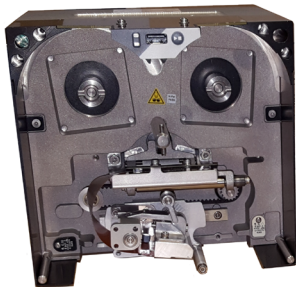

2



1 Printer

2 Ribbon Cassette

■ User Interface

1



2



1 Hand-Held Terminal (HHT)

2 Remote User Interface (RUI)



■ Printer Type

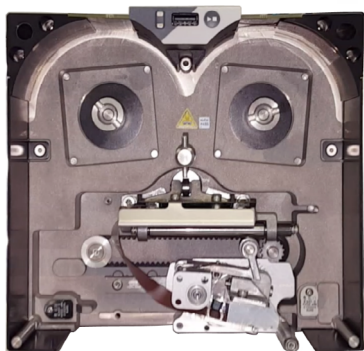

SmartDate X30 Continuous

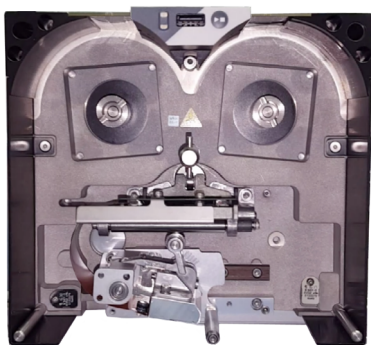

SmartDate X30 Intermittent



Power connection

■ Connecting the Power

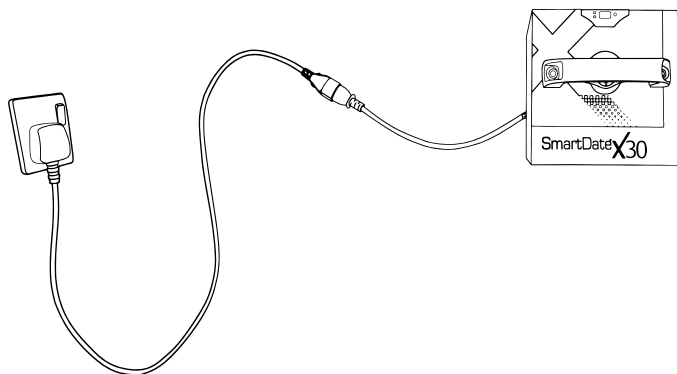

Power On

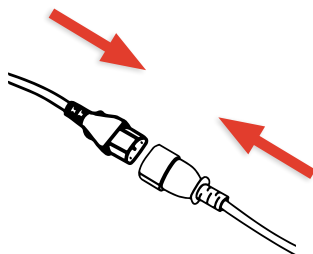

Power Off

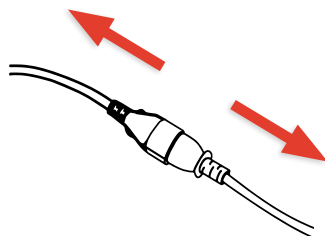



Hand-held terminal (HHT)

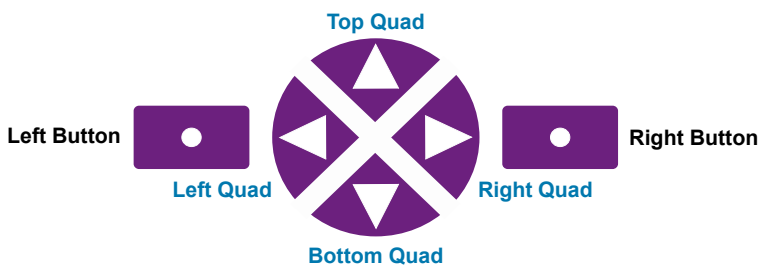
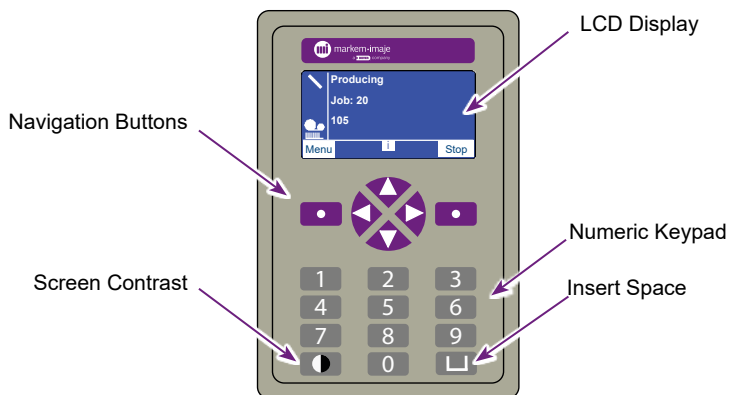

Remote user interface (RUI)

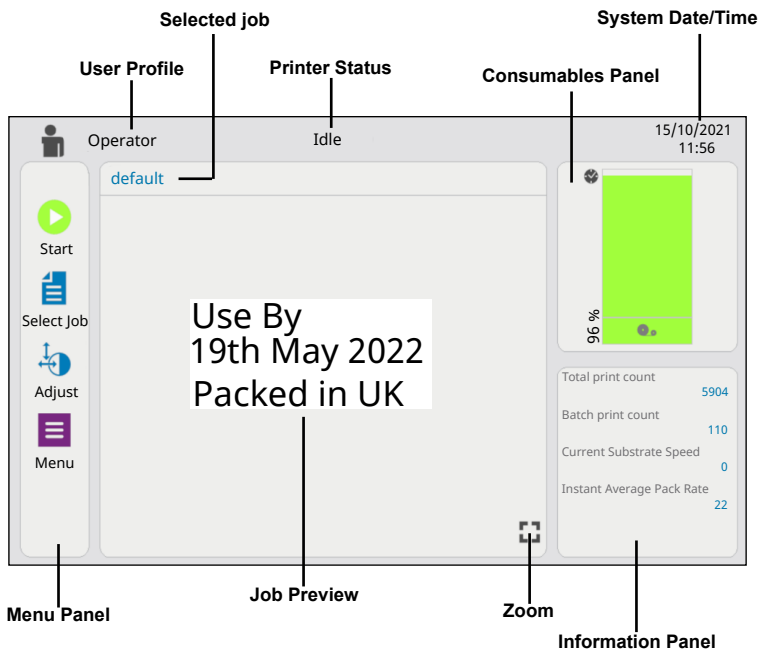

Printer Start/Stop

Starting the Printer

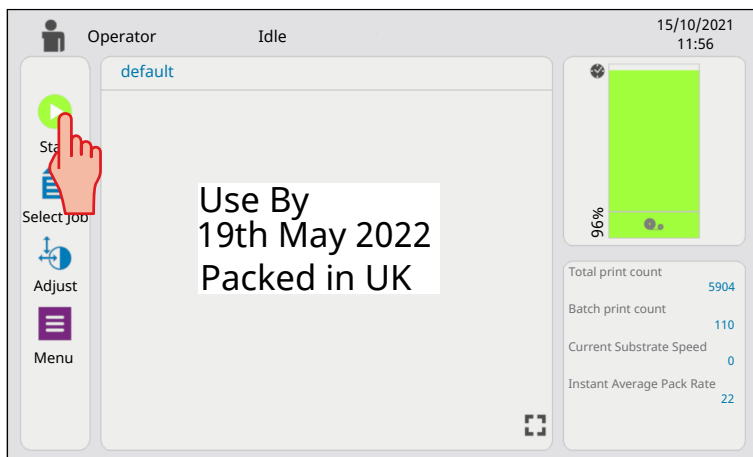
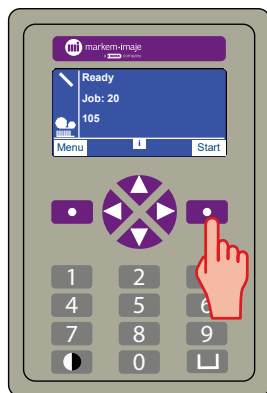

■ Stopping the Printer

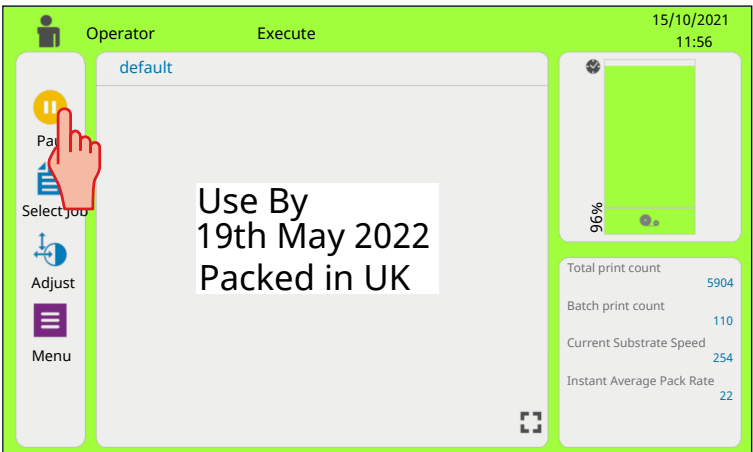
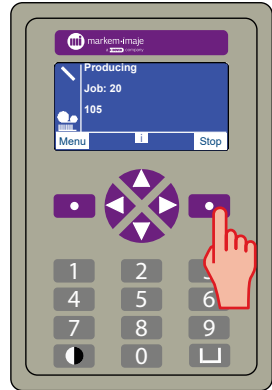

Selecting a job (HHT)

■ Using the Smartdate X30 Database

1



2

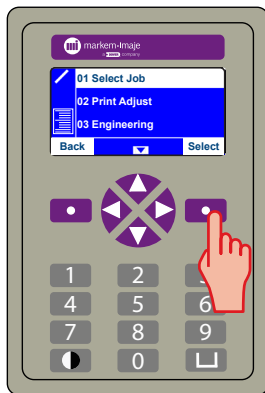

3

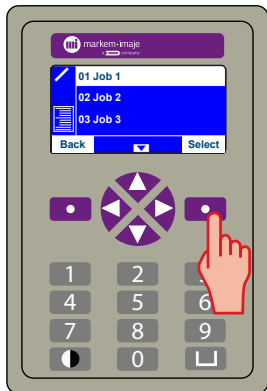

4

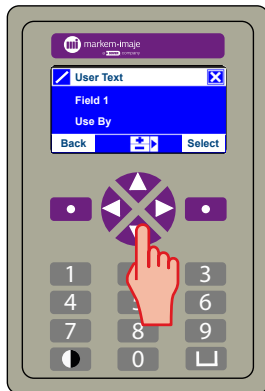

Selecting a job (HHT)

5

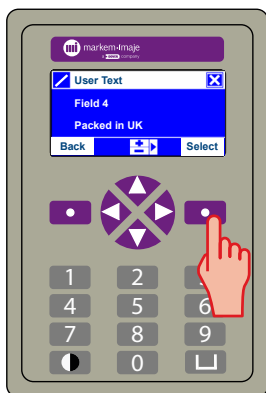

6



■ Using a USB Memory Stick Database

Note: The SmartDate X30 must be configured to use the USB memory stick database.

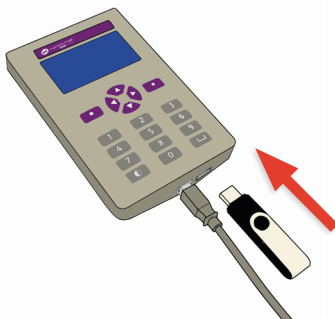

Insert the USB memory stick into the hand-held terminal and select a job following the same procedure as above.



Selecting a job (RUI)

1

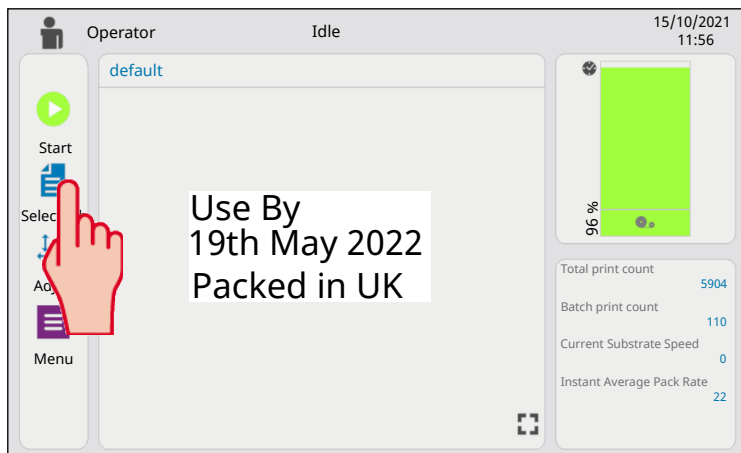

Operator Idle 15/10/2021 11:56

default

Start

Select

Acc

Menu

Use By
19th May 2022
Packed in UK

96 %

Total print count 5904

Batch print count 110

Current Substrate Speed 0

Instant Average Pack Rate 22

2

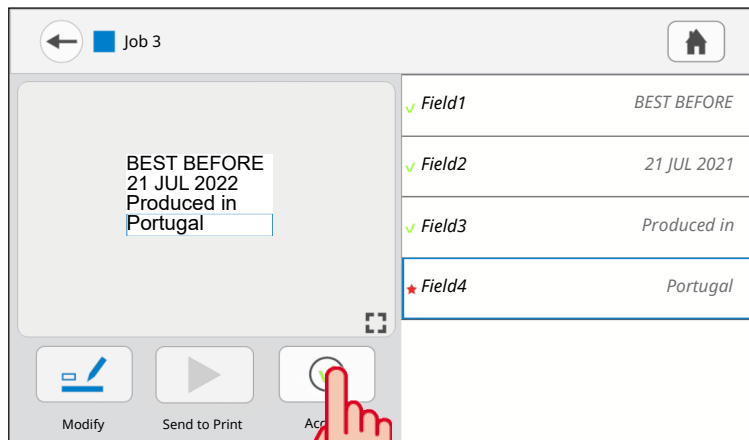

Job 3

BEST BEFORE
21 JUL 2022
Produced in
Portugal

✓ Field1	BEST BEFORE
✓ Field2	21 JUL 2021
✓ Field3	Produced in
★ Field4	Portugal

Modify Send to Print Acc



Selecting a job (RUI)

3

Job 3

BEST BEFORE
21 JUL 2022
Produced in
Portugal

✓ Field1	BEST BEFORE
✓ Field2	21 JUL 2022
✓ Field3	Produced in
✓ Field4	Portugal

Modify Send Accept

4

Information

Job selection in progress...

Progress bar: 10 segments, 5th segment is black.



Printer Menu (HHT)

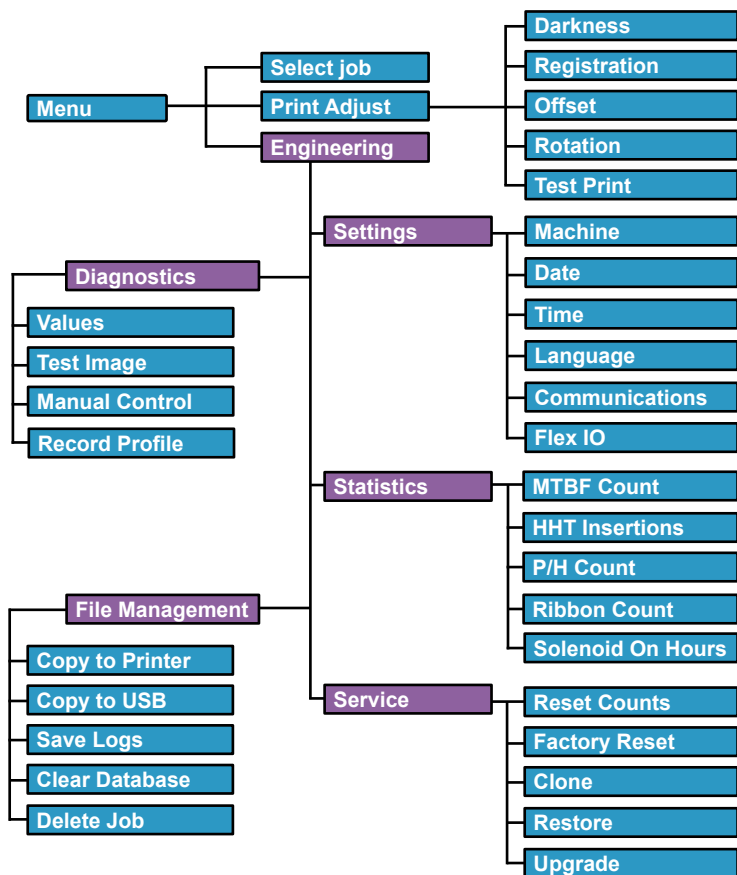

Printer Menu (RUI)

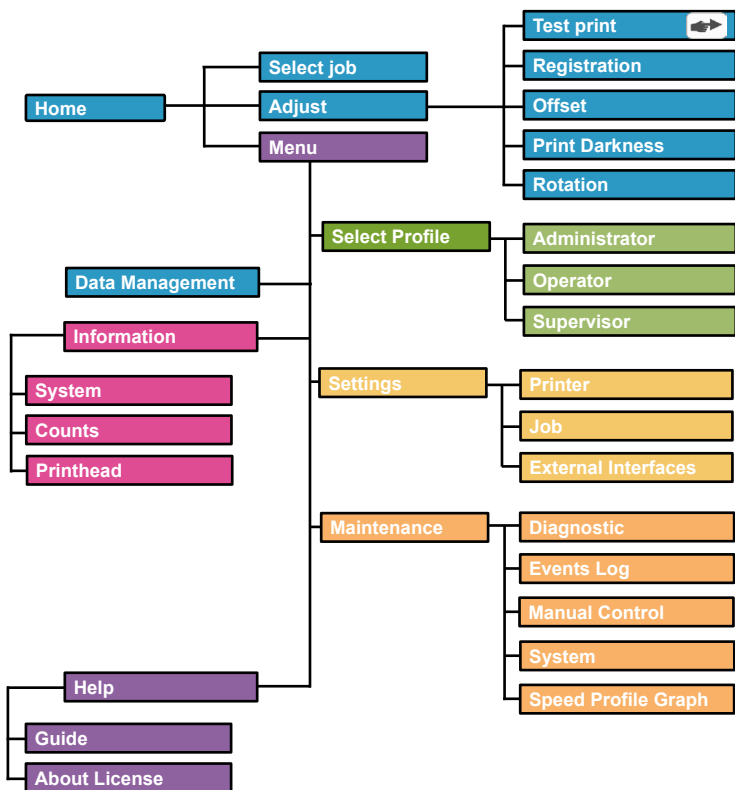

www.markem-imaje.com



Cleaning the Printhead



Clean the printhead regularly using Markem-Imaje printhead wipes.

1 Remove the cassette and allow the printhead to cool to normal room temperature.

2 Use a Markem-Imaje printhead cleaning wipe to remove any residue from the printhead as shown.

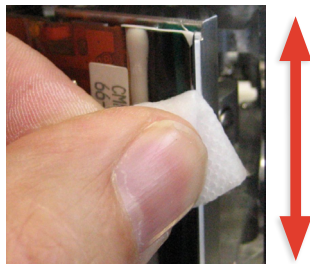

Do not use abrasive materials or Menu such as screwdrivers or knives to clean the printhead.



Changing the ribbon

1

Opening the cassette



Do not use force or Menu if the latch does not turn.

2

Remove the used ribbon.

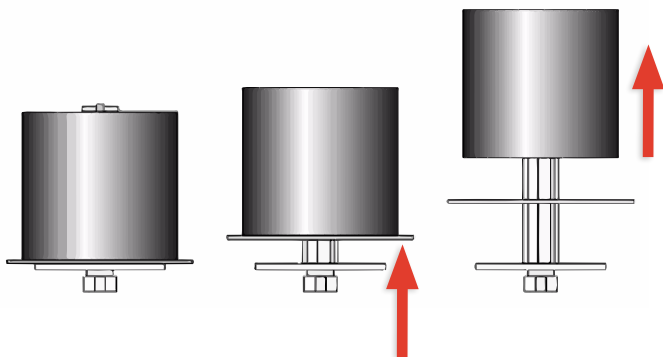

Changing the ribbon



Markem-Imaje ribbon only



Ribbon Path

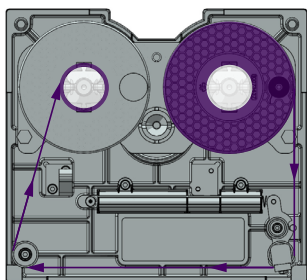

Left Hand Cassette

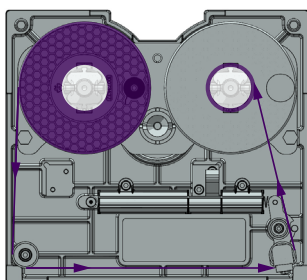

Right Hand Cassette



Changing the ribbon

3

Loading the new ribbon (LH cassette shown)

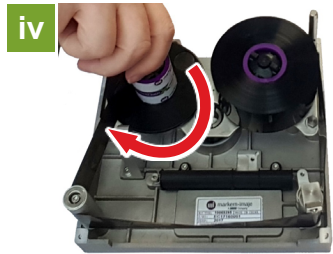
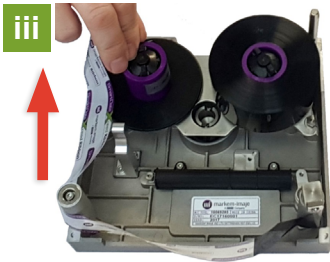
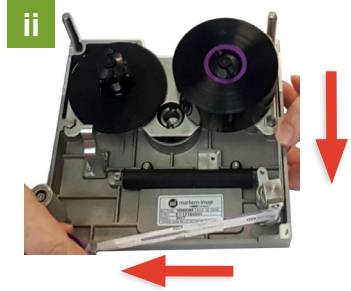

Faults and Warnings

■ Faults

A fault will stop the printer. The fault causing the condition must be fixed before printing can continue.

HHT

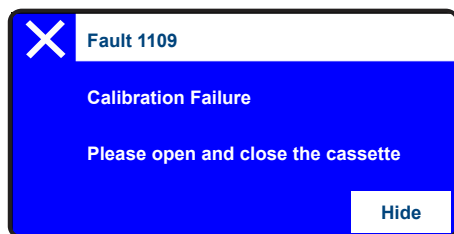

RUI

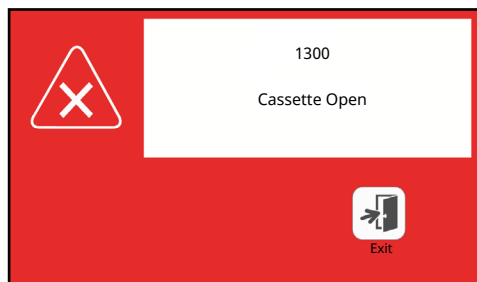

■ Warnings

A warning will not stop the printer, but will highlight information or a condition that may require attention.

HHT

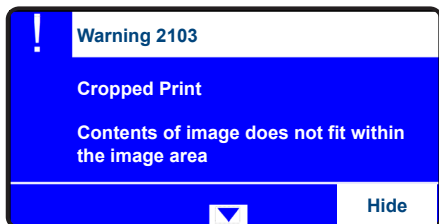

RUI



Faults and Warnings

■ Common Faults and Warnings

LOW RIBBON

The ribbon will soon run out, prepare a new ribbon.

CASSETTE OPEN

The cassette latch is open, close it.

CALIBRATION FAILED

The ribbon has broken during calibration, reload the ribbon and try again.

RIBBON BREAK DETECTED

The ribbon has broken during printing reload the ribbon.





S/N: Serial number: _____

Ribbon type: _____



For Marking & Coding Equipment. Photographs and drawings are not binding in detail. This document was originally written in English. The English text of this document shall alone be authentic and shall prevail in the event of a dispute. Markem-Imaje reserves the right to modify the specifications of its products without prior notice. Any reproduction, even partial, of this document is prohibited. Original manual.

© 2021 Markem-Imaje All Rights Reserved.





markem·imaje

a **DOVER** company

Redefine the possiblesm

TSS - User Documentation

Markem-Image Limited
Nottingham Science Park
University Boulevard
Nottingham NG7 2QN
UK
www.markem-imaje.com

10082287-AD 09/2021

en