

# FCC Test Report

**Equipment** : net4more comMODULE un:c-Thread  
**Brand Name** : Tridonic  
**Model No.** : 28001579  
**FCC ID** : 2AMXZ28001579  
**Standard** : 47 CFR FCC Part 15.247  
**Operating Band** : 2400 MHz – 2483.5 MHz  
**Function** :  Point-to-multipoint;  Point-to-point  
**Applicant** : **Tridonic GmbH & Co KG**  
Faerbergasse 15, 6851 Dornbirn, Austria  
**Manufacturer** : **XAVi Technologies Corp.**  
22F., No.69, Sec. 2, Guangfu Rd., Sanchong Dist.,  
New Taipei City 241, Taiwan (R.O.C.)

The product sample received on Jun. 15, 2017 and completely tested on Jul. 03, 2017. We, SPORTON, would like to declare that the tested sample has been evaluated in accordance with the procedures given in ANSI C63.10-2013 and shown compliance with the applicable technical standards.

The test results in this report apply exclusively to the tested model / sample. Without written approval of SPORTON INTERNATIONAL INC., the test report shall not be reproduced except in full.

  
Phoenix Chen  
SPORTON INTERNATIONAL INC.





## Table of Contents

<b>1</b>	<b>GENERAL DESCRIPTION .....</b>	<b>5</b>
1.1	Information.....	5
1.2	Testing Applied Standards .....	6
1.3	Testing Location Information .....	6
1.4	Measurement Uncertainty .....	6
<b>2</b>	<b>TEST CONFIGURATION OF EUT.....</b>	<b>7</b>
2.1	Test Condition .....	7
2.2	Test Channel Mode .....	7
2.3	The Worst Case Measurement Configuration.....	8
2.4	Support Equipment.....	9
2.5	Test Setup Diagram .....	10
<b>3</b>	<b>TRANSMITTER TEST RESULT .....</b>	<b>12</b>
3.1	AC Power-line Conducted Emissions .....	12
3.2	DTS Bandwidth.....	13
3.3	Maximum Conducted Output Power .....	14
3.4	Power Spectral Density .....	16
3.5	Emissions in Non-restricted Frequency Bands .....	17
3.6	Emissions in Restricted Frequency Bands.....	18
<b>4</b>	<b>TEST EQUIPMENT AND CALIBRATION DATA .....</b>	<b>22</b>
<b>APPENDIX A. TEST RESULTS OF AC POWER-LINE CONDUCTED EMISSIONS</b>		
<b>APPENDIX B. TEST RESULTS OF DTS BANDWIDTH</b>		
<b>APPENDIX C. TEST RESULTS OF MAXIMUM CONDUCTED OUTPUT POWER</b>		
<b>APPENDIX D. TEST RESULTS OF POWER SPECTRAL DENSITY</b>		
<b>APPENDIX E. TEST RESULTS OF EMISSIONS IN NON-RESTRICTED FREQUENCY BANDS</b>		
<b>APPENDIX F. TEST RESULTS OF EMISSIONS IN RESTRICTED FREQUENCY BANDS</b>		
<b>APPENDIX G. TEST PHOTOS</b>		
<b>PHOTOGRAPHS OF EUT v01</b>		



### Summary of Test Result

Conformance Test Specifications				
Report Clause	Ref. Std. Clause	Description	Limit	Result
1.1.2	15.203	Antenna Requirement	FCC 15.203	Complied
3.1	15.207	AC Power-line Conducted Emissions	FCC 15.207	Complied
3.2	15.247(a)	DTS Bandwidth	≥500kHz	Complied
3.3	15.247(b)	Maximum Conducted Output Power	Power [dBm]:30	Complied
3.4	15.247(e)	Power Spectral Density	PSD [dBm/3kHz]:8	Complied
3.5	15.247(d)	Emissions in Non-restricted Frequency Bands	Non-Restricted Bands: > 30 dBc	Complied
3.6	15.247(d)	Emissions in Restricted Frequency Bands	Restricted Bands: FCC 15.209	Complied



### Revision History

Report No.	Version	Description	Issued Date
FR681025-01AZ	Rev. 01	Initial issue of report	Sep. 14, 2017



# 1 General Description

## 1.1 Information

### 1.1.1 RF General Information

Frequency Range (MHz)	IEEE Std.	Ch. Frequency (MHz)	Channel Number
2400-2483.5	802.15.4	2405-2480	11-26 [16]

Band	Mode	BWch (MHz)	Nant
2.4-2.4835GHz	ZigBee	5	1TX

Note:.

- ♦ ZigBee uses a O-QPSK (250kbps) modulation for DSSS.
- ♦ BWch is the nominal channel bandwidth.

### 1.1.2 Antenna Information

Ant.	Port	Brand	Model Name	Antenna Type	Connector	Gain (dBi)
1	1	-	-	Print PCB	Mini i-Pex	1.2

Note . The EUT has two antennas and only employ 1T1R structure. The manufacturer declared that both ANT 0 and ANT 1 are identical each other.

### 1.1.3 EUT Information

Operational Condition	
EUT Power Type	From Power Adapter
Type of EUT	
<input checked="" type="checkbox"/>	Stand-alone
<input type="checkbox"/>	Combined (EUT where the radio part is fully integrated within another device)
	Combined Equipment - Brand Name / Model No.: ...
<input type="checkbox"/>	Plug-in radio (EUT intended for a variety of host systems)
	Host System - Brand Name / Model No.: ...
<input type="checkbox"/>	Other:

### 1.1.4 Mode Test Duty Cycle

Mode	DC	DCF(dB)	T(s)	VBW(Hz) ≥ 1/T
ZigBee	1	0	n/a (DC>=0.98)	n/a (DC>=0.98)

## 1.2 Testing Applied Standards

According to the specifications of the manufacturer, the EUT must comply with the requirements of the following standards:

- ◆ 47 CFR FCC Part 15
- ◆ ANSI C63.10-2013
- ◆ KDB 558074 D01 v04

## 1.3 Testing Location Information

Testing Location		
<input checked="" type="checkbox"/>	HWA YA	ADD : No. 52, Huaya 1st Rd., Guishan Dist., Taoyuan City, Taiwan (R.O.C.) TEL : 886-3-327-3456 FAX : 886-3-327-0973
Test site Designation No. TW1190 with FCC.		
<input checked="" type="checkbox"/>	DONG HU	ADD : No. 3, Ln. 238, Kangle St., Neihu Dist., Taipei City, Taiwan (R.O.C.) TEL : 886-2-2631-5551 FAX : 886-2-2631-9740
Test site Designation No. TW1094 with FCC.		
<input type="checkbox"/>	JHUBEI	ADD : No.8, Ln. 724, Bo'ai St., Zhubei City, Hsinchu County, Taiwan (R.O.C.) TEL : 886-3-656-9065 FAX : 886-3-656-9085
Test site Designation No. TW0006 with FCC.		

Test Condition	Test Site No.	Test Engineer	Test Environment	Test Date
AC Conduction	CO01-NH	Willy	25°C / 50%	15/Jun/2017
RF Conducted	TH06-HY	Wayne	22.5°C / 65.5%	03/Jul/2017
Radiated	03CH03-HY	Thor	24°C / 63.4%	03/Jul/2017

## 1.4 Measurement Uncertainty

ISO/IEC 17025 requires that an estimate of the measurement uncertainties associated with the emissions test results be included in the report. The measurement uncertainties given below are based on a 95% confidence level (based on a coverage factor (k=2))

Test Items	Uncertainty	Remark
Radiated Emission (30MHz ~ 1,000MHz)	2.1 dB	Confidence levels of 95%
Radiated Emission (1GHz ~ 18GHz)	2.6 dB	Confidence levels of 95%
Radiated Emission (18GHz ~ 40GHz)	2.9 dB	Confidence levels of 95%
Conducted Emission	1.3 dB	Confidence levels of 95%

Test Items	Test Site No.	Uncertainty	Remark
Conducted Emissions	CO01-NH	± 2.6 dB	Confidence levels of 95%



## 2 Test Configuration of EUT

### 2.1 Test Condition

RF Conducted	Abbreviation	Remark
TnomVnom	Tnom	20°C
-	Vnom	120V

### 2.2 Test Channel Mode



Test Software	Dos
---------------	-----

Mode	Power Setting
Zigbee	-
2405MHz	0
2440MHz	0
2480MHz	8

### 2.3 The Worst Case Measurement Configuration

The Worst Case Mode for Following Conformance Tests	
Tests Item	AC power-line conducted emissions
Condition	AC power-line conducted measurement for line and neutral
Operating Mode	Normal Link
1	ZigBee Link + NFC Tag

The Worst Case Mode for Following Conformance Tests	
Tests Item	DTS Bandwidth Maximum Conducted Output Power Power Spectral Density Emissions in Non-restricted Frequency Bands
Test Condition	Conducted measurement at transmit chains

The Worst Case Mode for Following Conformance Tests			
Tests Item	Emissions in Restricted Frequency Bands		
Test Condition	Radiated measurement If EUT consist of multiple antenna assembly (multiple antenna are used in EUT regardless of spatial multiplexing MIMO configuration), the radiated test should be performed with highest antenna gain of each antenna type.		
Operating Mode < 1GHz	CTX		
Orthogonal Planes of EUT	X Plane	Y Plane	Z Plane
			
Worst Planes of EUT	V		





## 2.4 Support Equipment

Support Equipment – AC Conduction				
No.	Equipment	Brand Name	Model Name	FCC ID
A	SENSOR	XAVi	-	-
B	ADAPTER(DC 5V)	Sunny	SYS1381-0505-W2E	DoC
C	Lightboxes	-	-	-
Y	NB (Remote)	DELL	E5520	DoC
Z	Variant (Remote)	XAVi	DMC120_B	-

Note: Support equipment A, B, C and Z were provided by customer.

Support Equipment – RF Conducted				
No.	Equipment	Brand Name	Model Name	FCC ID
1	Notebook	DELL	E5410	DoC
2	Adapter for NB	DELL	HA65NM130	DoC

Support Equipment – Radiated Emission				
No.	Equipment	Brand Name	Model Name	FCC ID
1	AC adapter	XIAOMI	MDY-03-EC	-

Note: Support equipment No.1 was provided by customer.

## 2.5 Test Setup Diagram

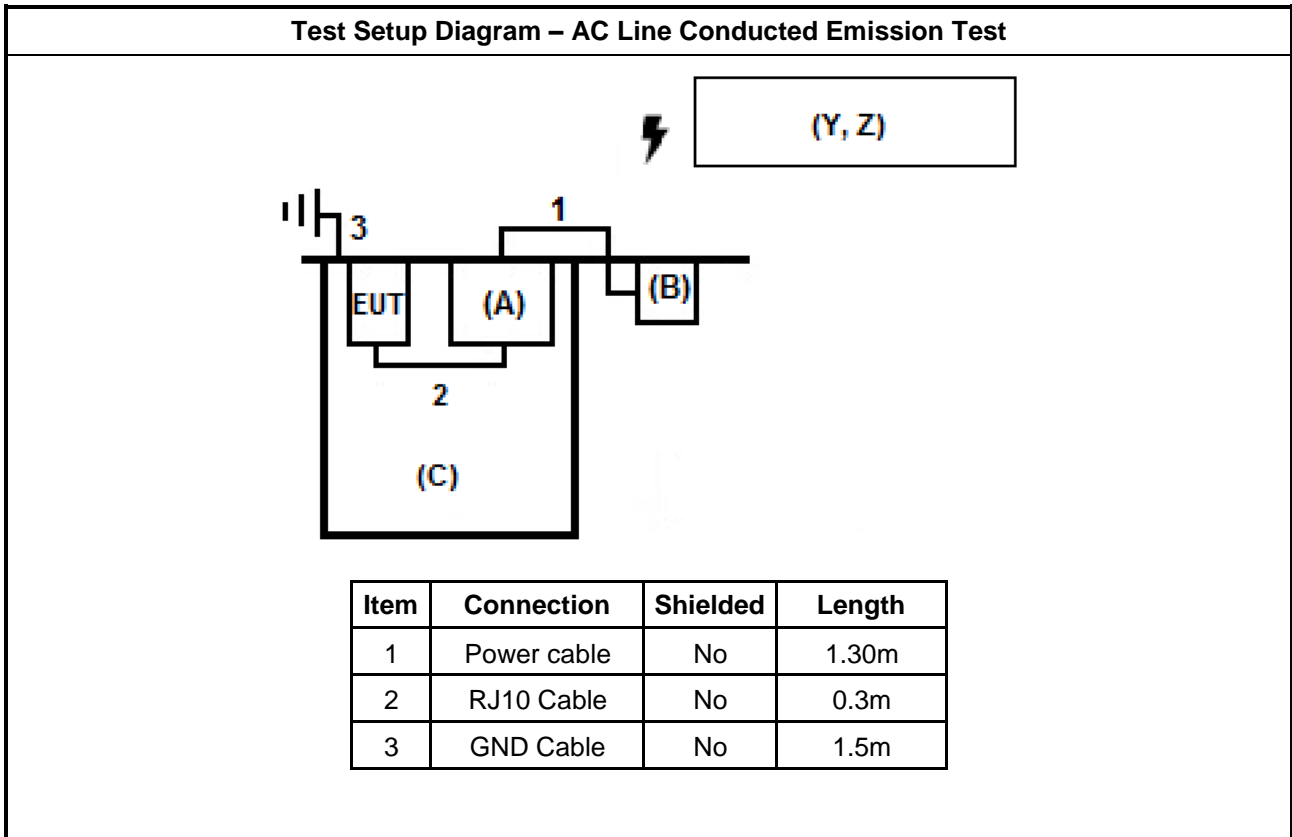

**Test Setup Diagram - Radiated Test**

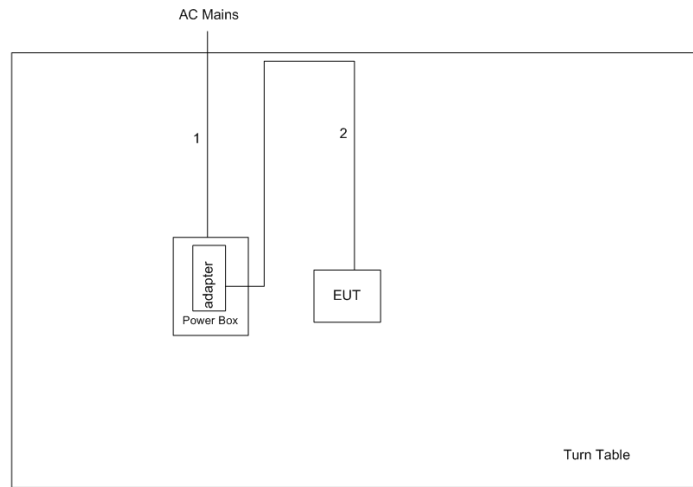

Item	Connection	Shielded	Length
1	Power cable	No	2.0m
2	USB to RJ-11 cable	No	1.2m

### 3 Transmitter Test Result

#### 3.1 AC Power-line Conducted Emissions

##### 3.1.1 AC Power-line Conducted Emissions Limit

AC Power-line Conducted Emissions Limit		
Frequency Emission (MHz)	Quasi-Peak	Average
0.15-0.5	66 - 56 *	56 - 46 *
0.5-5	56	46
5-30	60	50

Note 1: \* Decreases with the logarithm of the frequency.

##### 3.1.2 Measuring Instruments

Refer a test equipment and calibration data table in this test report.

##### 3.1.3 Test Procedures

Test Method
<input checked="" type="checkbox"/> Refer as ANSI C63.10-2013, clause 6.2 for AC power-line conducted emissions.

##### 3.1.4 Test Setup

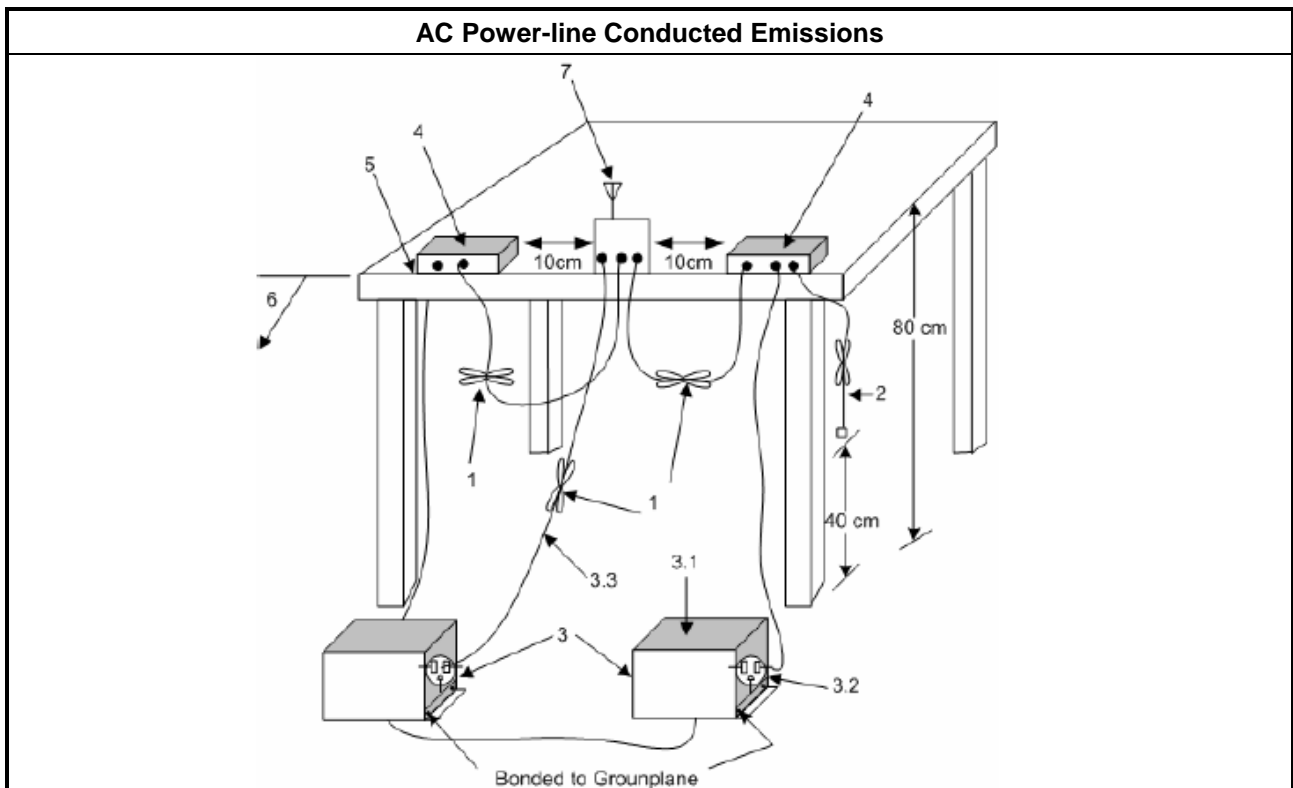

##### 3.1.5 Test Result of AC Power-line Conducted Emissions

Refer as Appendix A

### 3.2 DTS Bandwidth

#### 3.2.1 6dB Bandwidth Limit

6dB Bandwidth Limit
<b>Systems using digital modulation techniques:</b>
<ul style="list-style-type: none"> <li>▪ 6 dB bandwidth <math>\geq</math> 500 kHz.</li> </ul>

#### 3.2.2 Measuring Instruments

Refer a test equipment and calibration data table in this test report.

#### 3.2.3 Test Procedures

Test Method
<ul style="list-style-type: none"> <li>▪ For the emission bandwidth shall be measured using one of the options below:</li> </ul>
<input checked="" type="checkbox"/> Refer as KDB 558074, clause 8.1 Option 1 for 6 dB bandwidth measurement.
<input type="checkbox"/> Refer as KDB 558074, clause 8.2 Option 2 for 6 dB bandwidth measurement.
<input type="checkbox"/> Refer as ANSI C63.10, clause 6.9.3 for occupied bandwidth testing.

#### 3.2.4 Test Setup

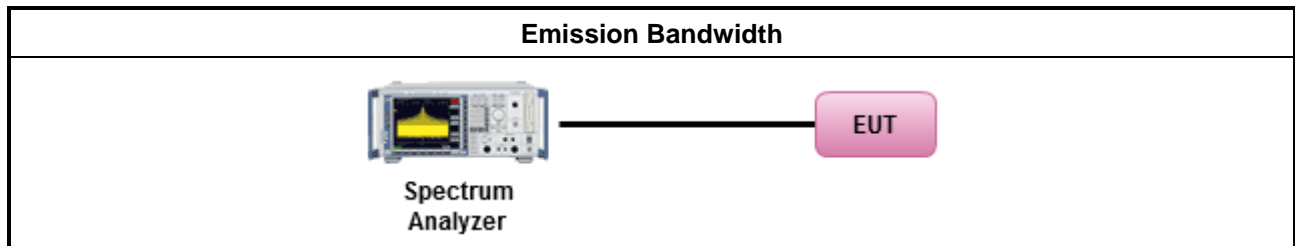

#### 3.2.5 Test Result of Emission Bandwidth

Refer as Appendix B

### 3.3 Maximum Conducted Output Power

#### 3.3.1 Maximum Conducted Output Power Limit

Maximum Conducted Output Power Limit	
	<ul style="list-style-type: none"> <li>▪ If <math>G_{TX} \leq 6</math> dBi, then <math>P_{Out} \leq 30</math> dBm (1 W)</li> </ul>
	<ul style="list-style-type: none"> <li>▪ Point-to-multipoint systems (P2M): If <math>G_{TX} &gt; 6</math> dBi, then <math>P_{Out} = 30 - (G_{TX} - 6)</math> dBm</li> </ul>
	<ul style="list-style-type: none"> <li>▪ Point-to-point systems (P2P): If <math>G_{TX} &gt; 6</math> dBi, then <math>P_{Out} = 30 - (G_{TX} - 6)/3</math> dBm</li> </ul>
	<ul style="list-style-type: none"> <li>▪ Smart antenna system (SAS):</li> </ul>
	<ul style="list-style-type: none"> <li>- Single beam: If <math>G_{TX} &gt; 6</math> dBi, then <math>P_{Out} = 30 - (G_{TX} - 6)/3</math> dBm</li> </ul>
	<ul style="list-style-type: none"> <li>- Overlap beam: If <math>G_{TX} &gt; 6</math> dBi, then <math>P_{Out} = 30 - (G_{TX} - 6)/3</math> dBm</li> </ul>
	<ul style="list-style-type: none"> <li>- Aggregate power on all beams: If <math>G_{TX} &gt; 6</math> dBi, then <math>P_{Out} = 30 - (G_{TX} - 6)/3 + 8</math> dBm</li> </ul>
e.i.r.p. Power Limit:	
	<ul style="list-style-type: none"> <li>▪ 2400-2483.5 MHz Band</li> </ul>
	<ul style="list-style-type: none"> <li>▪ Point-to-multipoint systems (P2M): <math>P_{eirp} \leq 36</math> dBm (4 W)</li> </ul>
	<ul style="list-style-type: none"> <li>▪ Point-to-point systems (P2P): <math>P_{eirp} \leq \text{MAX}(36, [P_{Out} + G_{TX}])</math> dBm</li> </ul>
	<ul style="list-style-type: none"> <li>▪ Smart antenna system (SAS)</li> </ul>
	<ul style="list-style-type: none"> <li>- Single beam: <math>P_{eirp} \leq \text{MAX}(36, P_{Out} + G_{TX})</math> dBm</li> </ul>
	<ul style="list-style-type: none"> <li>- Overlap beam: <math>P_{eirp} \leq \text{MAX}(36, P_{Out} + G_{TX})</math> dBm</li> </ul>
	<ul style="list-style-type: none"> <li>- Aggregate power on all beams: <math>P_{eirp} \leq \text{MAX}(36, [P_{Out} + G_{TX} + 8])</math> dBm</li> </ul>
<p><math>P_{Out}</math> = maximum peak conducted output power or maximum conducted output power in dBm,  <math>G_{TX}</math> = the maximum transmitting antenna directional gain in dBi.</p>	

#### 3.3.2 Measuring Instruments

Refer a test equipment and calibration data table in this test report.

### 3.3.3 Test Procedures

Test Method	
<ul style="list-style-type: none"> <li>▪ Maximum Peak Conducted Output Power</li> </ul>	
<input type="checkbox"/>	Refer as KDB 558074, clause 9.1.1 Option 1 (RBW ≥ EBW method).
<input type="checkbox"/>	Refer as KDB 558074, clause 9.1.2 Option 2 (integrated band power method)
<input type="checkbox"/>	Refer as KDB 558074, clause 9.1.3 Option 3 (peak power meter for VBW ≥ DTS BW)
<ul style="list-style-type: none"> <li>▪ Maximum Average Conducted Output Power</li> </ul>	
Duty cycle ≥ 98%	
<input type="checkbox"/>	Refer as KDB 558074, clause 9.2.2.4 Method AVGSA-2 (spectral trace averaging).
Duty cycle < 98%	
<input type="checkbox"/>	Refer as KDB 558074, clause 9.2.2.5 Method AVGSA-2 Alt. (slow sweep speed)
RF power meter and average over on/off periods with duty factor or gated trigger	
<input checked="" type="checkbox"/>	Refer as KDB 558074, clause 9.2.3.1 Method AVGPM (using an RF average power meter).
<ul style="list-style-type: none"> <li>▪ For conducted measurement.</li> </ul>	
<ul style="list-style-type: none"> <li>▪ If the EUT supports multiple transmit chains using options given below: Refer as KDB 662911, In-band power measurements. Using the measure-and-sum approach, measured all transmit ports individually. Sum the power (in linear power units e.g., mW) of all ports for each individual sample and save them.</li> </ul>	
<ul style="list-style-type: none"> <li>▪ If multiple transmit chains, EIRP calculation could be following as methods:  <math display="block">P_{total} = P_1 + P_2 + \dots + P_n</math>                     (calculated in linear unit [mW] and transfer to log unit [dBm])  <math display="block">EIRP_{total} = P_{total} + DG</math> </li> </ul>	

### 3.3.4 Test Setup

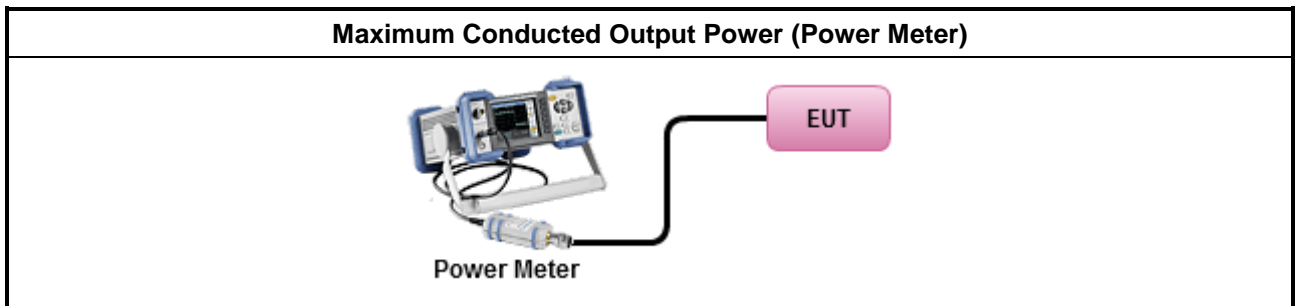

### 3.3.5 Test Result of Maximum Conducted Output Power

Refer as Appendix C

### 3.4 Power Spectral Density

#### 3.4.1 Power Spectral Density Limit

Power Spectral Density Limit
<ul style="list-style-type: none"> <li>Power Spectral Density (PSD) <math>\leq</math> 8 dBm/3kHz</li> </ul>

#### 3.4.2 Measuring Instruments

Refer a test equipment and calibration data table in this test report.

#### 3.4.3 Test Procedures

Test Method	
<ul style="list-style-type: none"> <li>Peak power spectral density procedures that the same method as used to determine the conducted output power. If maximum peak conducted output power was measured to demonstrate compliance to the output power limit, then the peak PSD procedure below (Method PKPSD) shall be used. If maximum conducted output power was measured to demonstrate compliance to the output power limit, then one of the average PSD procedures shall be used, as applicable based on the following criteria (the peak PSD procedure is also an acceptable option).</li> </ul>	
<input checked="" type="checkbox"/> Refer as KDB 558074, clause 10.2 Method PKPSD (RBW=3-100kHz; Detector=peak).	
<ul style="list-style-type: none"> <li>For conducted measurement.</li> </ul>	
<ul style="list-style-type: none"> <li>If The EUT supports multiple transmit chains using options given below:</li> </ul>	
<input type="checkbox"/>	Measure and sum the spectra across the outputs. Refer as KDB 662911, In-band power spectral density (PSD). Sample all transmit ports simultaneously using a spectrum analyzer for each transmit port. Where the trace bin-by-bin of each transmit port summing can be performed. (i.e., in the first spectral bin of output 1 is summed with that in the first spectral bin of output 2 and that from the first spectral bin of output 3, and so on up to the NTX output to obtain the value for the first frequency bin of the summed spectrum.). Add up the amplitude (power) values for the different transmit chains and use this as the new data trace.

#### 3.4.4 Test Setup

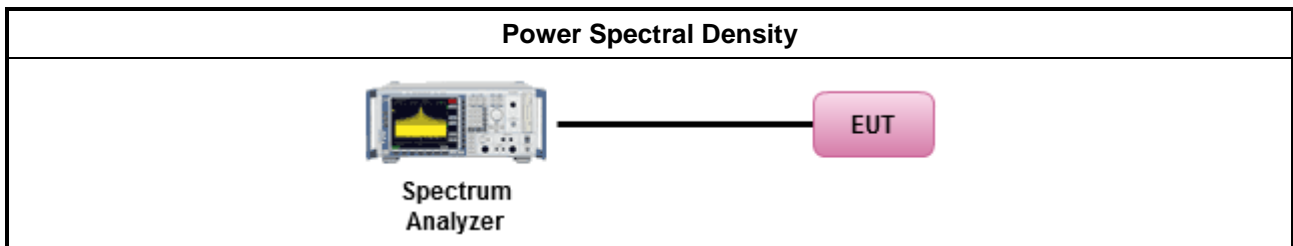

#### 3.4.5 Test Result of Power Spectral Density

Refer as Appendix D



### 3.5 Emissions in Non-restricted Frequency Bands

#### 3.5.1 Emissions in Non-restricted Frequency Bands Limit

Un-restricted Band Emissions Limit	
RF output power procedure	Limit (dB)
Peak output power procedure	20
Average output power procedure	30
<p>Note 1: If the peak output power procedure is used to measure the fundamental emission power to demonstrate compliance to requirements, then the peak conducted output power measured within any 100 kHz outside the authorized frequency band shall be attenuated by at least 20 dB relative to the maximum measured in-band peak PSD level.</p> <p>Note 2: If the average output power procedure is used to measure the fundamental emission power to demonstrate compliance to requirements, then the power in any 100 kHz outside of the authorized frequency band shall be attenuated by at least 30 dB relative to the maximum measured in-band average PSD level.</p>	

#### 3.5.2 Measuring Instruments

Refer a test equipment and calibration data table in this test report.

#### 3.5.3 Test Procedures

Test Method
<ul style="list-style-type: none"> <li>Refer as KDB 558074, clause 11 for unwanted emissions into non-restricted bands.</li> </ul>

#### 3.5.4 Test Setup

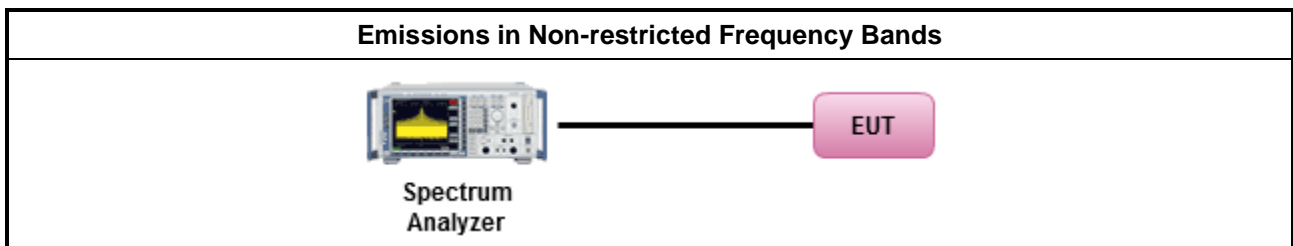

#### 3.5.5 Test Result of Emissions in Non-restricted Frequency Bands

Refer as Appendix E



### 3.6 Emissions in Restricted Frequency Bands

#### 3.6.1 Emissions in Restricted Frequency Bands Limit

Restricted Band Emissions Limit			
Frequency Range (MHz)	Field Strength (uV/m)	Field Strength (dBuV/m)	Measure Distance (m)
0.009~0.490	2400/F(kHz)	48.5 - 13.8	300
0.490~1.705	24000/F(kHz)	33.8 - 23	30
1.705~30.0	30	29	30
30~88	100	40	3
88~216	150	43.5	3
216~960	200	46	3
Above 960	500	54	3

Note 1: Test distance for frequencies at or above 30 MHz, measurements may be performed at a distance other than the limit distance provided they are not performed in the near field and the emissions to be measured can be detected by the measurement equipment. When performing measurements at a distance other than that specified, the results shall be extrapolated to the specified distance using an extrapolation factor of 20 dB/decade (inverse of linear distance for field-strength measurements, inverse of linear distance-squared for power-density measurements).

Note 2: Test distance for frequencies at below 30 MHz, measurements may be performed at a distance closer than the EUT limit distance; however, an attempt should be made to avoid making measurements in the near field. When performing measurements below 30 MHz at a closer distance than the limit distance, the results shall be extrapolated to the specified distance by either making measurements at a minimum of two or more distances on at least one radial to determine the proper extrapolation factor or by using the square of an inverse linear distance extrapolation factor (40 dB/decade). The test report shall specify the extrapolation method used to determine compliance of the EUT.

#### 3.6.2 Measuring Instruments

Refer a test equipment and calibration data table in this test report.



3.6.3 Test Procedures

Test Method	
<ul style="list-style-type: none"> <li>▪ The average emission levels shall be measured in [duty cycle <math>\geq</math> 98 or duty factor].</li> </ul>	
<ul style="list-style-type: none"> <li>▪ Refer as ANSI C63.10, clause 6.10.3 band-edge testing shall be performed at the lowest frequency channel and highest frequency channel within the allowed operating band.</li> </ul>	
<ul style="list-style-type: none"> <li>▪ For the transmitter unwanted emissions shall be measured using following options below:</li> </ul>	
	<ul style="list-style-type: none"> <li>▪ Refer as KDB 558074, clause 12 for unwanted emissions into restricted bands.</li> </ul>
<input checked="" type="checkbox"/>	Refer as KDB 558074, clause 12.2.5.3 (ANSI C63.10, clause 4.1.4.2.3), Reduced VBW $\geq$ 1/T.
<input checked="" type="checkbox"/>	Refer as KDB 558074, clause 12.2.4 measurement procedure peak limit.
<ul style="list-style-type: none"> <li>▪ For the transmitter band-edge emissions shall be measured using following options below:</li> </ul>	
	<ul style="list-style-type: none"> <li>▪ Refer as KDB 558074 clause 13.1, When the performing peak or average radiated measurements, emissions within 2 MHz of the authorized band edge may be measured using the marker-delta method described below.</li> </ul>
	<ul style="list-style-type: none"> <li>▪ Refer as KDB 558074, clause 13.2 (ANSI C63.10, clause 6.10.6) for marker-delta method for band-edge measurements.</li> </ul>
	<ul style="list-style-type: none"> <li>▪ Refer as KDB 558074, clause 13.3 for narrower resolution bandwidth (100kHz) using the band power and summing the spectral levels (i.e., 1 MHz).</li> </ul>
<ul style="list-style-type: none"> <li>▪ For conducted and cabinet radiation measurement, refer as KDB 558074, clause 12.2.2.</li> </ul>	
	<ul style="list-style-type: none"> <li>▪ For conducted unwanted emissions into restricted bands (absolute emission limits). Devices with multiple transmit chains using options given below: (1) Measure and sum the spectra across the outputs or (2) Measure and add 10 log(N) dB</li> </ul>
	<ul style="list-style-type: none"> <li>▪ For KDB 662911 The methodology described here may overestimate array gain, thereby resulting in apparent failures to satisfy the out-of-band limits even if the device is actually compliant. In such cases, compliance may be demonstrated by performing radiated tests around the frequencies at which the apparent failures occurred.</li> </ul>

### 3.6.4 Test Setup

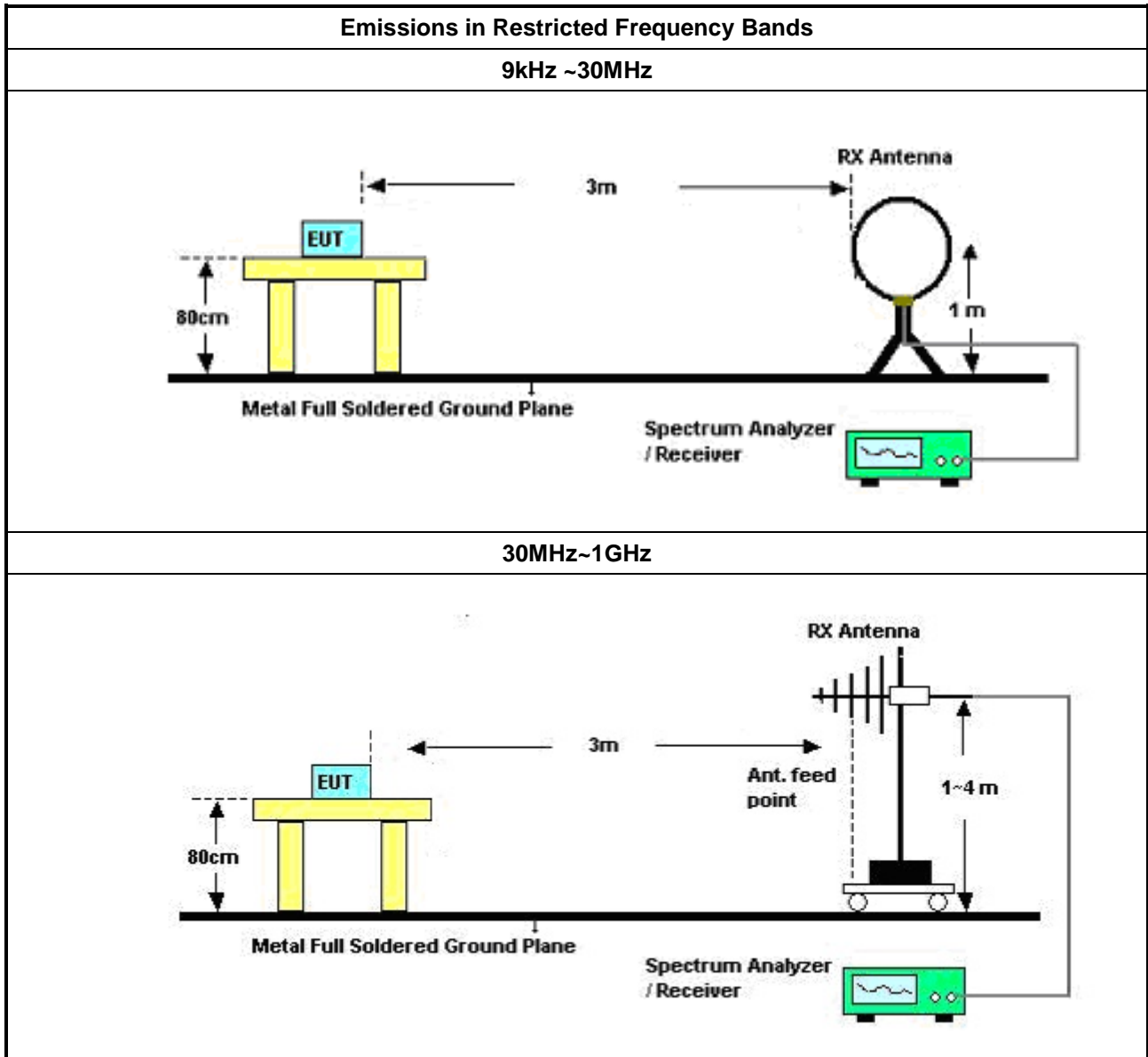

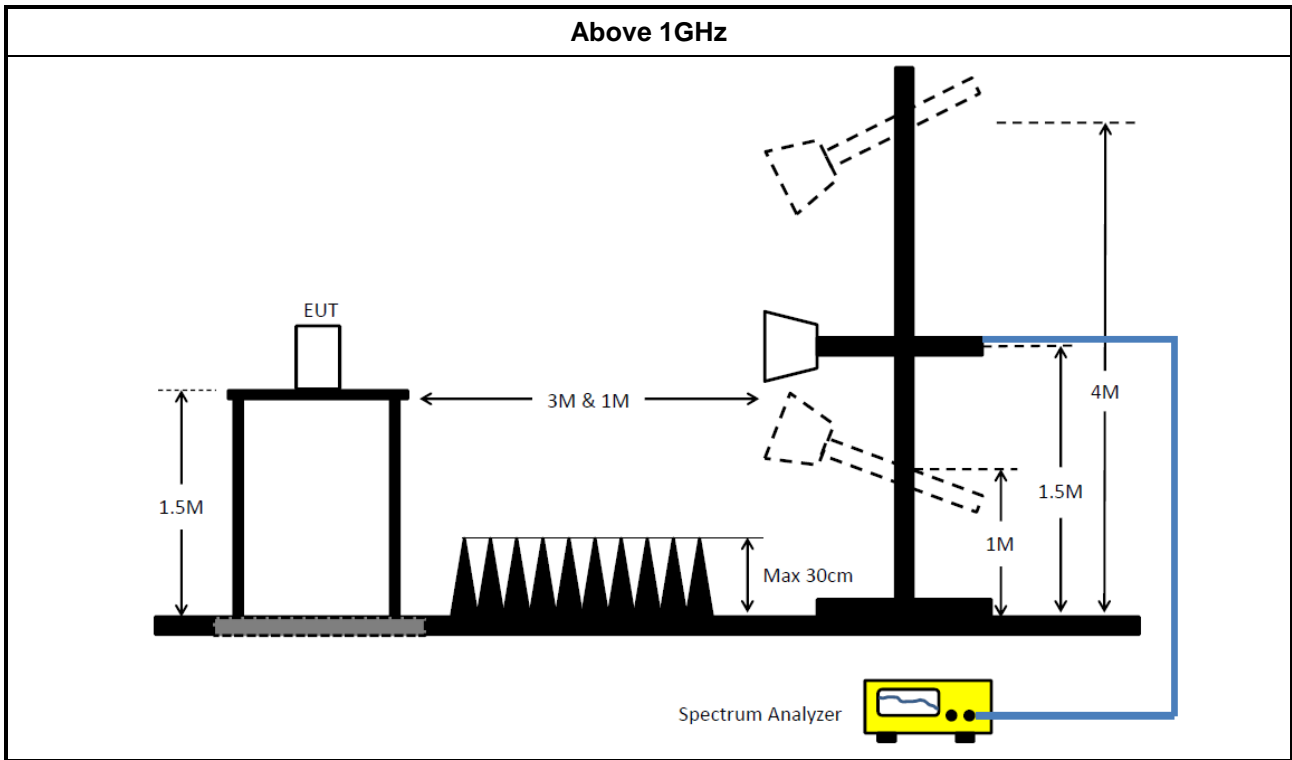

**3.6.5 Test Result of Emissions in Restricted Frequency Bands (Below 30MHz)**

The amplitude of spurious emissions which are attenuated by more than 20dB below the permissible value has no need to be reported. All amplitude of spurious emissions that are attenuated by more than 20 dB below the permissible value has no need to be reported.

**3.6.6 Test Result of Emissions in Restricted Frequency Bands**

Refer as Appendix F



## 4 Test Equipment and Calibration Data

### Instrument for AC Conduction

Instrument	Manufacturer	Model No.	Serial No.	Spec.	Calibration Date	Calibration Due Date
EMI Receiver	R&S	ESR3	102052	9k Hz – 3.6 GHz	05/Apr/2017	04/Apr/2018
LISN	SCHAFFNER	NNB41	04/10153	9kHz - 30MHz	19/Dec/2016	18/Dec/2017
LISN	KYORITSU	KNW-407	8-1010-15	9kHz – 30MHz	NCR	NCR
Power Filter	CORCOM	MR12030	N/A	30A*2	NCR	NCR
RF Cable-CON	Suhner Switzerland	RG223/U	CB004	9kHz - 30MHz	12/Dec/2016	11/Dec/2017
Impedance Stabilization Network	TESEQ GMBH	ISN T400A	25669	150kHz - 30MHz	01/Dec/2016	30/Nov/2017

NCR : Non-Calibration Require

### Instrument for Conducted Test

Instrument	Manufacturer	Model No.	Serial No.	Spec.	Calibration Date	Calibration Due Date
Spectrum Analyzer	R&S	FSV 40	101013	10Hz~40GHz	30/Dec/2016	29/Dec/2017
Power Sensor	Anritsu	MA2411B	1027452	300MHz ~ 40GHz	24/Feb/2017	23/Feb/2018
Power Meter	Anritsu	ML2495A	1124009	300MHz ~ 40GHz	24/Feb/2017	23/Feb/2018
Signal Generator	R&S	SMR40	100116	10MHz ~ 40GHz	21/Jul/2016	20/Jul/2017
RF Cable-0.2m	HUBER+SUHNER	SUCOFLEX_104	MY677/3	30MHz ~ 26.5GHz	02/Oct/2016	01/Oct/2017
RF Cable-0.2m	HUBER+SUHNER	SUCOFLEX_104	MY678/3	30MHz ~ 26.5GHz	02/Oct/2016	01/Oct/2017
RF Cable-0.5m	HUBER+SUHNER	SUCOFLEX_104	MY10717/4	30MHz ~ 26.5GHz	02/Oct/2016	01/Oct/2017

### Instrument for Radiated Test

Instrument	Manufacturer	Model No.	Serial No.	Spec.	Calibration Date	Calibration Due Date
3m Semi Anechoic Chamber	SIDT FRANKONIA	SAC-3M	03CH03-HY	30MHz ~ 1GHz	28/Nov/2016	27/Nov/2017
3m Semi Anechoic Chamber	SIDT FRANKONIA	SAC-3M	03CH03-HY	1GHz ~ 18GHz	16/Dec/2016	15/Dec/2017
Amplifier	HP	8447D	2944A08033	10kHz ~ 1.3GHz	19/Apr/2017	18/Apr/2018
Amplifier	KEYSIGHT	83017A	MY53270197	1GHz ~ 26.5GHz	29/Aug/2016	28/Aug/2017
Spectrum	R&S	FSV40	101515	9kHz ~ 40GHz	28/Nov/2016	27/Nov/2017
Bilog Antenna	SCHAFFNER	CBL 6112D	2723	30MHz ~ 1GHz	01/Oct/2016	30/Sep/2017
Horn Antenna	SCHWARZBECK	BBHA 9120D	BBHA 9120D 1531	1GHz ~ 18GHz	25/Apr/2017	24/Apr/2018
Horn Antenna	SCHWARZBECK	BBHA 9170	BBHA 9170221	18GHz ~ 40GHz	06/Feb/2017	05/Feb/2018
Loop Antenna	TESEQ	HLA 6120	24155	9 kHz~30 MHz	02/Mar/2017	01/Mar/2018
RF-Cable-high	SUHNER	SUHNER	CB222	1GHz ~ 40GHz	28/Oct/2016	27/Oct/2017
RF Cable-R03m	Jye Bao	RG142	CB021	9kHz ~ 1GHz	27/Oct/2016	26/Oct/2017
Receiver	R&S	ESU-26	100422/026	20Hz ~ 26.5GHz	21/Sep/2016	20/Sep/2017



AC Power-line Conducted Emissions Result																																																																																																																																										
Operating Mode	1	Power Phase	Neutral																																																																																																																																							
Operating Function	ZigBee Link + NFC Tag																																																																																																																																									
Date: 2017-06-15																																																																																																																																										
<table border="1" style="width:100%; border-collapse: collapse;"> <thead> <tr> <th></th> <th>Freq</th> <th>Level</th> <th>Over</th> <th>Limit</th> <th>Read</th> <th>LISN</th> <th>Cable</th> <th>Remark</th> </tr> <tr> <th></th> <th>MHz</th> <th>dBuV</th> <th>Limit</th> <th>Line</th> <th>Level</th> <th>Factor</th> <th>Loss</th> <th></th> </tr> <tr> <th></th> <th></th> <th></th> <th>dB</th> <th>dBuV</th> <th>dBuV</th> <th>dB</th> <th>dB</th> <th></th> </tr> </thead> <tbody> <tr><td>1</td><td>0.164</td><td>37.90</td><td>-27.35</td><td>65.25</td><td>27.61</td><td>10.19</td><td>0.10</td><td>QP</td></tr> <tr><td>2</td><td>0.164</td><td>27.29</td><td>-27.96</td><td>55.25</td><td>17.00</td><td>10.19</td><td>0.10</td><td>AVERAGE</td></tr> <tr><td>3</td><td>0.186</td><td>35.35</td><td>-28.85</td><td>64.20</td><td>25.01</td><td>10.24</td><td>0.10</td><td>QP</td></tr> <tr><td>4</td><td>0.186</td><td>25.86</td><td>-28.34</td><td>54.20</td><td>15.52</td><td>10.24</td><td>0.10</td><td>AVERAGE</td></tr> <tr><td>5</td><td>0.315</td><td>36.56</td><td>-23.28</td><td>59.84</td><td>26.16</td><td>10.30</td><td>0.10</td><td>QP</td></tr> <tr><td>6</td><td>0.315</td><td>31.63</td><td>-18.21</td><td>49.84</td><td>21.23</td><td>10.30</td><td>0.10</td><td>AVERAGE</td></tr> <tr><td>7</td><td>0.491</td><td>20.82</td><td>-25.32</td><td>46.14</td><td>10.43</td><td>10.29</td><td>0.10</td><td>AVERAGE</td></tr> <tr><td>8</td><td>0.491</td><td>27.90</td><td>-28.24</td><td>56.14</td><td>17.51</td><td>10.29</td><td>0.10</td><td>QP</td></tr> <tr><td>9</td><td>0.792</td><td>20.96</td><td>-25.04</td><td>46.00</td><td>10.65</td><td>10.21</td><td>0.10</td><td>AVERAGE</td></tr> <tr><td>10</td><td>0.792</td><td>31.86</td><td>-24.14</td><td>56.00</td><td>21.55</td><td>10.21</td><td>0.10</td><td>QP</td></tr> <tr><td>11</td><td>1.367</td><td>16.33</td><td>-29.67</td><td>46.00</td><td>6.01</td><td>10.18</td><td>0.14</td><td>AVERAGE</td></tr> <tr><td>12</td><td>1.367</td><td>21.26</td><td>-34.74</td><td>56.00</td><td>10.94</td><td>10.18</td><td>0.14</td><td>QP</td></tr> </tbody> </table>					Freq	Level	Over	Limit	Read	LISN	Cable	Remark		MHz	dBuV	Limit	Line	Level	Factor	Loss					dB	dBuV	dBuV	dB	dB		1	0.164	37.90	-27.35	65.25	27.61	10.19	0.10	QP	2	0.164	27.29	-27.96	55.25	17.00	10.19	0.10	AVERAGE	3	0.186	35.35	-28.85	64.20	25.01	10.24	0.10	QP	4	0.186	25.86	-28.34	54.20	15.52	10.24	0.10	AVERAGE	5	0.315	36.56	-23.28	59.84	26.16	10.30	0.10	QP	6	0.315	31.63	-18.21	49.84	21.23	10.30	0.10	AVERAGE	7	0.491	20.82	-25.32	46.14	10.43	10.29	0.10	AVERAGE	8	0.491	27.90	-28.24	56.14	17.51	10.29	0.10	QP	9	0.792	20.96	-25.04	46.00	10.65	10.21	0.10	AVERAGE	10	0.792	31.86	-24.14	56.00	21.55	10.21	0.10	QP	11	1.367	16.33	-29.67	46.00	6.01	10.18	0.14	AVERAGE	12	1.367	21.26	-34.74	56.00	10.94	10.18	0.14	QP
	Freq	Level	Over	Limit	Read	LISN	Cable	Remark																																																																																																																																		
	MHz	dBuV	Limit	Line	Level	Factor	Loss																																																																																																																																			
			dB	dBuV	dBuV	dB	dB																																																																																																																																			
1	0.164	37.90	-27.35	65.25	27.61	10.19	0.10	QP																																																																																																																																		
2	0.164	27.29	-27.96	55.25	17.00	10.19	0.10	AVERAGE																																																																																																																																		
3	0.186	35.35	-28.85	64.20	25.01	10.24	0.10	QP																																																																																																																																		
4	0.186	25.86	-28.34	54.20	15.52	10.24	0.10	AVERAGE																																																																																																																																		
5	0.315	36.56	-23.28	59.84	26.16	10.30	0.10	QP																																																																																																																																		
6	0.315	31.63	-18.21	49.84	21.23	10.30	0.10	AVERAGE																																																																																																																																		
7	0.491	20.82	-25.32	46.14	10.43	10.29	0.10	AVERAGE																																																																																																																																		
8	0.491	27.90	-28.24	56.14	17.51	10.29	0.10	QP																																																																																																																																		
9	0.792	20.96	-25.04	46.00	10.65	10.21	0.10	AVERAGE																																																																																																																																		
10	0.792	31.86	-24.14	56.00	21.55	10.21	0.10	QP																																																																																																																																		
11	1.367	16.33	-29.67	46.00	6.01	10.18	0.14	AVERAGE																																																																																																																																		
12	1.367	21.26	-34.74	56.00	10.94	10.18	0.14	QP																																																																																																																																		
<p>Note 1: "&gt;20dB" means emission levels that exceed the level of 20 dB below the applicable limit.            Note 2: "N/F" means Nothing Found emissions (No emissions were detected.)</p>																																																																																																																																										



AC Power-line Conducted Emissions Result																																																																																																																																	
Operating Mode	1	Power Phase	Line																																																																																																																														
Operating Function	ZigBee Link + NFC Tag																																																																																																																																
Date: 2017-06-15																																																																																																																																	
<table border="1" style="width: 100%; border-collapse: collapse;"> <thead> <tr> <th></th> <th>Freq</th> <th>Level</th> <th>Over Limit</th> <th>Limit Line</th> <th>Read Level</th> <th>LISN Factor</th> <th>Cable Loss</th> <th>Remark</th> </tr> <tr> <th></th> <th>MHz</th> <th>dBuV</th> <th>dB</th> <th>dBuV</th> <th>dBuV</th> <th>dB</th> <th>dB</th> <th></th> </tr> </thead> <tbody> <tr><td>1</td><td>0.154</td><td>38.17</td><td>-27.61</td><td>65.78</td><td>27.93</td><td>10.14</td><td>0.10</td><td>QP</td></tr> <tr><td>2</td><td>0.154</td><td>28.97</td><td>-26.81</td><td>55.78</td><td>18.73</td><td>10.14</td><td>0.10</td><td>AVERAGE</td></tr> <tr><td>3</td><td>0.312</td><td>30.22</td><td>-19.71</td><td>49.93</td><td>19.94</td><td>10.18</td><td>0.10</td><td>AVERAGE</td></tr> <tr><td>4</td><td>0.312</td><td>35.50</td><td>-24.43</td><td>59.93</td><td>25.22</td><td>10.18</td><td>0.10</td><td>QP</td></tr> <tr><td>5</td><td>0.479</td><td>30.02</td><td>-26.34</td><td>56.36</td><td>19.69</td><td>10.23</td><td>0.10</td><td>QP</td></tr> <tr><td>6</td><td>0.479</td><td>21.64</td><td>-24.72</td><td>46.36</td><td>11.31</td><td>10.23</td><td>0.10</td><td>AVERAGE</td></tr> <tr><td>7</td><td>0.800</td><td>28.70</td><td>-17.30</td><td>46.00</td><td>18.35</td><td>10.25</td><td>0.10</td><td>AVERAGE</td></tr> <tr><td>8</td><td>0.800</td><td>32.94</td><td>-23.06</td><td>56.00</td><td>22.59</td><td>10.25</td><td>0.10</td><td>QP</td></tr> <tr><td>9</td><td>3.258</td><td>27.53</td><td>-28.47</td><td>56.00</td><td>16.86</td><td>10.47</td><td>0.20</td><td>QP</td></tr> <tr><td>10</td><td>3.258</td><td>22.44</td><td>-23.56</td><td>46.00</td><td>11.77</td><td>10.47</td><td>0.20</td><td>AVERAGE</td></tr> <tr><td>11</td><td>6.089</td><td>24.08</td><td>-25.92</td><td>50.00</td><td>13.34</td><td>10.54</td><td>0.20</td><td>AVERAGE</td></tr> <tr><td>12</td><td>6.089</td><td>29.22</td><td>-30.78</td><td>60.00</td><td>18.48</td><td>10.54</td><td>0.20</td><td>QP</td></tr> </tbody> </table>					Freq	Level	Over Limit	Limit Line	Read Level	LISN Factor	Cable Loss	Remark		MHz	dBuV	dB	dBuV	dBuV	dB	dB		1	0.154	38.17	-27.61	65.78	27.93	10.14	0.10	QP	2	0.154	28.97	-26.81	55.78	18.73	10.14	0.10	AVERAGE	3	0.312	30.22	-19.71	49.93	19.94	10.18	0.10	AVERAGE	4	0.312	35.50	-24.43	59.93	25.22	10.18	0.10	QP	5	0.479	30.02	-26.34	56.36	19.69	10.23	0.10	QP	6	0.479	21.64	-24.72	46.36	11.31	10.23	0.10	AVERAGE	7	0.800	28.70	-17.30	46.00	18.35	10.25	0.10	AVERAGE	8	0.800	32.94	-23.06	56.00	22.59	10.25	0.10	QP	9	3.258	27.53	-28.47	56.00	16.86	10.47	0.20	QP	10	3.258	22.44	-23.56	46.00	11.77	10.47	0.20	AVERAGE	11	6.089	24.08	-25.92	50.00	13.34	10.54	0.20	AVERAGE	12	6.089	29.22	-30.78	60.00	18.48	10.54	0.20	QP
	Freq	Level	Over Limit	Limit Line	Read Level	LISN Factor	Cable Loss	Remark																																																																																																																									
	MHz	dBuV	dB	dBuV	dBuV	dB	dB																																																																																																																										
1	0.154	38.17	-27.61	65.78	27.93	10.14	0.10	QP																																																																																																																									
2	0.154	28.97	-26.81	55.78	18.73	10.14	0.10	AVERAGE																																																																																																																									
3	0.312	30.22	-19.71	49.93	19.94	10.18	0.10	AVERAGE																																																																																																																									
4	0.312	35.50	-24.43	59.93	25.22	10.18	0.10	QP																																																																																																																									
5	0.479	30.02	-26.34	56.36	19.69	10.23	0.10	QP																																																																																																																									
6	0.479	21.64	-24.72	46.36	11.31	10.23	0.10	AVERAGE																																																																																																																									
7	0.800	28.70	-17.30	46.00	18.35	10.25	0.10	AVERAGE																																																																																																																									
8	0.800	32.94	-23.06	56.00	22.59	10.25	0.10	QP																																																																																																																									
9	3.258	27.53	-28.47	56.00	16.86	10.47	0.20	QP																																																																																																																									
10	3.258	22.44	-23.56	46.00	11.77	10.47	0.20	AVERAGE																																																																																																																									
11	6.089	24.08	-25.92	50.00	13.34	10.54	0.20	AVERAGE																																																																																																																									
12	6.089	29.22	-30.78	60.00	18.48	10.54	0.20	QP																																																																																																																									
<p>Note 1: "&gt;20dB" means emission levels that exceed the level of 20 dB below the applicable limit.            Note 2: "N/F" means Nothing Found emissions (No emissions were detected.)</p>																																																																																																																																	





Summary

Mode	Max-N dB (Hz)	Max-OBW (Hz)	ITU-Code	Min-N dB (Hz)	Min-OBW (Hz)
Zigbee	-	-	-	-	-
2.4-2.4835GHz	1.663M	3.03M	3M03G1D	1.4M	2.617M

**Max-N dB** = Maximum 6dB down bandwidth; **Max-OBW** = Maximum 99% occupied bandwidth;  
**Min-N dB** = Minimum 6dB down bandwidth; **Min-OBW** = Minimum 99% occupied bandwidth;

Result

Mode	Result	Limit (Hz)	Port 1-N dB (Hz)	Port 1-OBW (Hz)
Zigbee	-	-	-	-
2405MHz_TnomVnom	Pass	500k	1.4M	2.617M
2440MHz_TnomVnom	Pass	500k	1.538M	2.68M
2480MHz_TnomVnom	Pass	500k	1.663M	3.03M

**Port X-N dB** = Port X 6dB down bandwidth; **Port X-OBW** = Port X 99% occupied bandwidth;

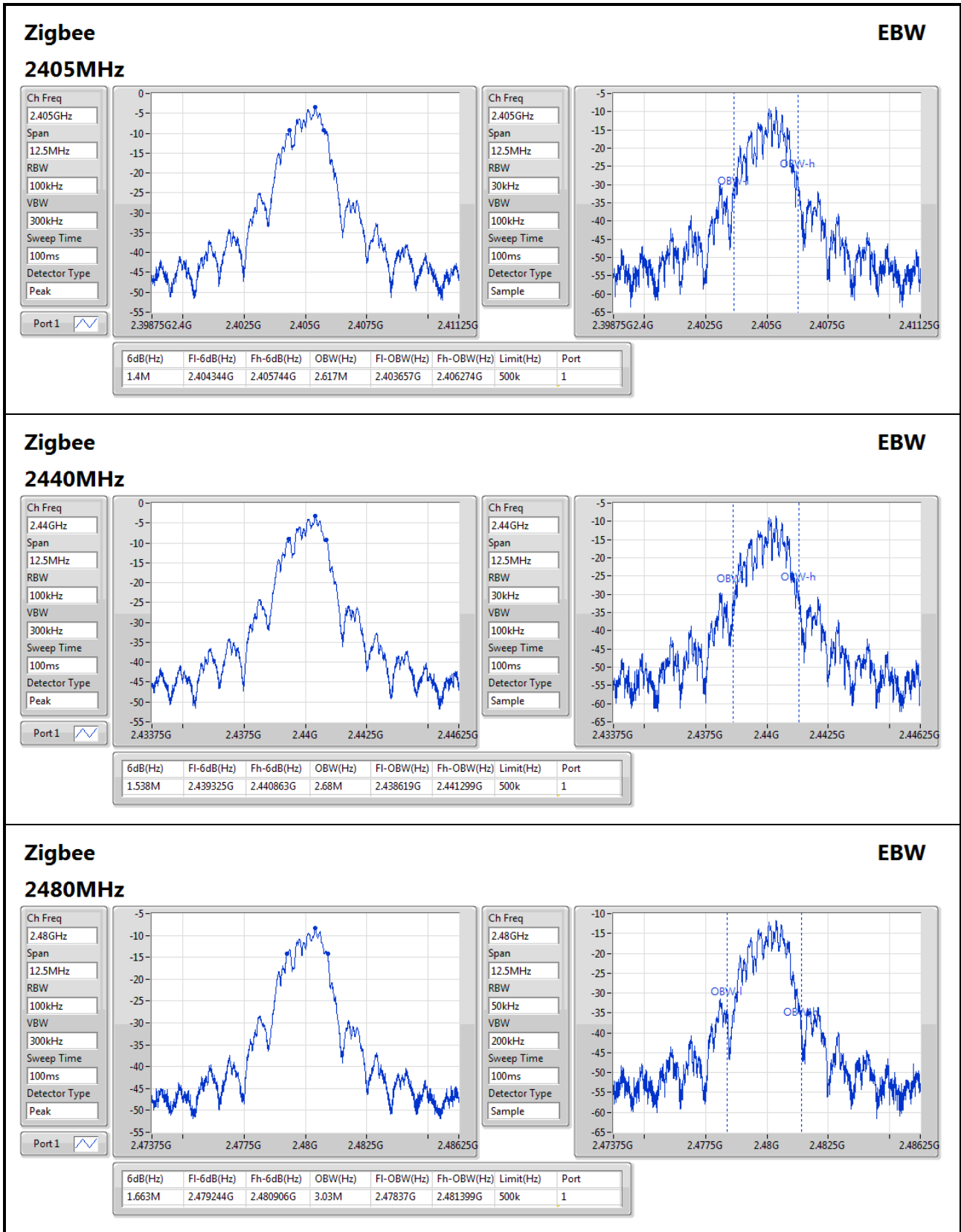



**Summary**

Mode	Total Power (dBm)	Total Power (W)
Zigbee	-	-
2.4-2.4835GHz	2.41	0.00174

**Result**

Mode	Result	DG (dBi)	Port 1 (dBm)	Total Power (dBm)	Power Limit (dBm)
Zigbee	-	-	-	-	-
2405MHz_TnomVnom	Pass	1.20	2.12	2.12	30.00
2440MHz_TnomVnom	Pass	1.20	2.41	2.41	30.00
2480MHz_TnomVnom	Pass	1.20	-2.05	-2.05	30.00

**DG** = Directional Gain; **Port X** = Port X output power



**Summary**

Mode	PD (dBm/RBW)
Zigbee	-
2.4-2.4835GHz	-8.71

RBW=3kHz.

**Result**

Mode	Result	DG (dBi)	Port 1 (dBm/RBW)	PD (dBm/RBW)	PD Limit (dBm/RBW)
Zigbee	-	-	-	-	-
2405MHz_TnomVnom	Pass	1.20	-9.01	-9.01	8.00
2440MHz_TnomVnom	Pass	1.20	-8.71	-8.71	8.00
2480MHz_TnomVnom	Pass	1.20	-13.81	-13.81	8.00

DG = Directional Gain; RBW=3kHz;

PD = trace bin-by-bin of each transmits port summing can be performed maximum power density; **Port X** = Port X power density;

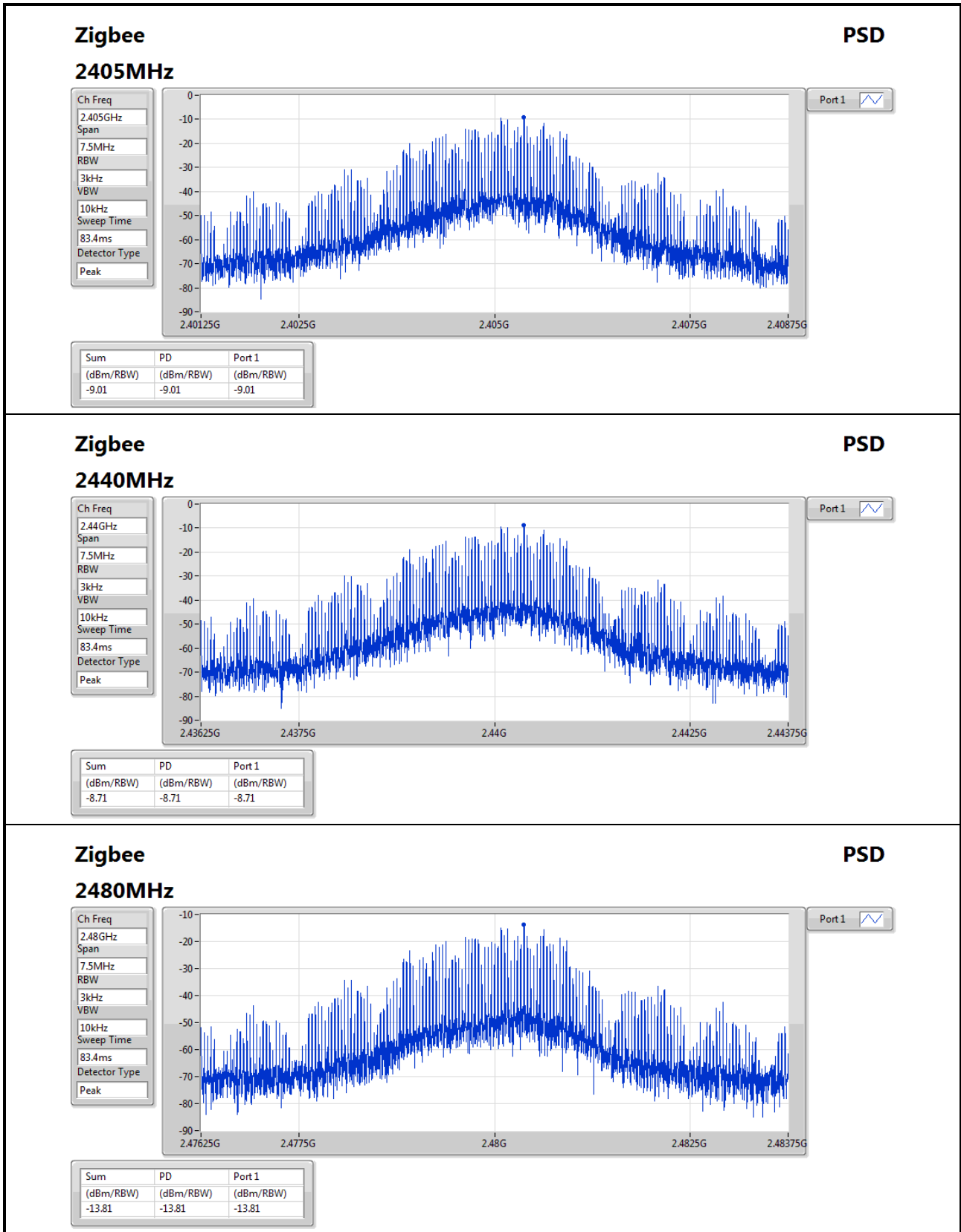



Summary

Mode	Result	Ref (Hz)	Ref (dBm)	Limit (dBm)	Freq (Hz)	Level (dBm)	Freq (Hz)	Level (dBm)	Freq (Hz)	Level (dBm)	Freq (Hz)	Level (dBm)	Port
Zigbee	-	-	-	-	-	-	-	-	-	-	-	-	-
2.4-2.4835GHz	Pass	2.480494G	6.29	-23.71	2.3015G	-55.95	2.39832G	-55.34	2.4841G	-27.97	6.9526G	-49.82	1

Result

Mode	Result	Ref (Hz)	Ref (dBm)	Limit (dBm)	Freq (Hz)	Level (dBm)	Freq (Hz)	Level (dBm)	Freq (Hz)	Level (dBm)	Freq (Hz)	Level (dBm)	Port
Zigbee	-	-	-	-	-	-	-	-	-	-	-	-	-
2405MHz_TnomVnom	Pass	2.405344G	6.29	-23.71	2.01122G	-54.98	2.39994G	-33.29	2.49246G	-55.36	6.958227G	-49.84	1
2440MHz_TnomVnom	Pass	2.440414G	6.29	-23.71	1.89794G	-55.16	2.39998G	-55.04	2.49286G	-54.39	6.921654G	-49.14	1
2480MHz_TnomVnom	Pass	2.480494G	6.29	-23.71	2.3015G	-55.95	2.39832G	-55.34	2.4841G	-27.97	6.9526G	-49.82	1

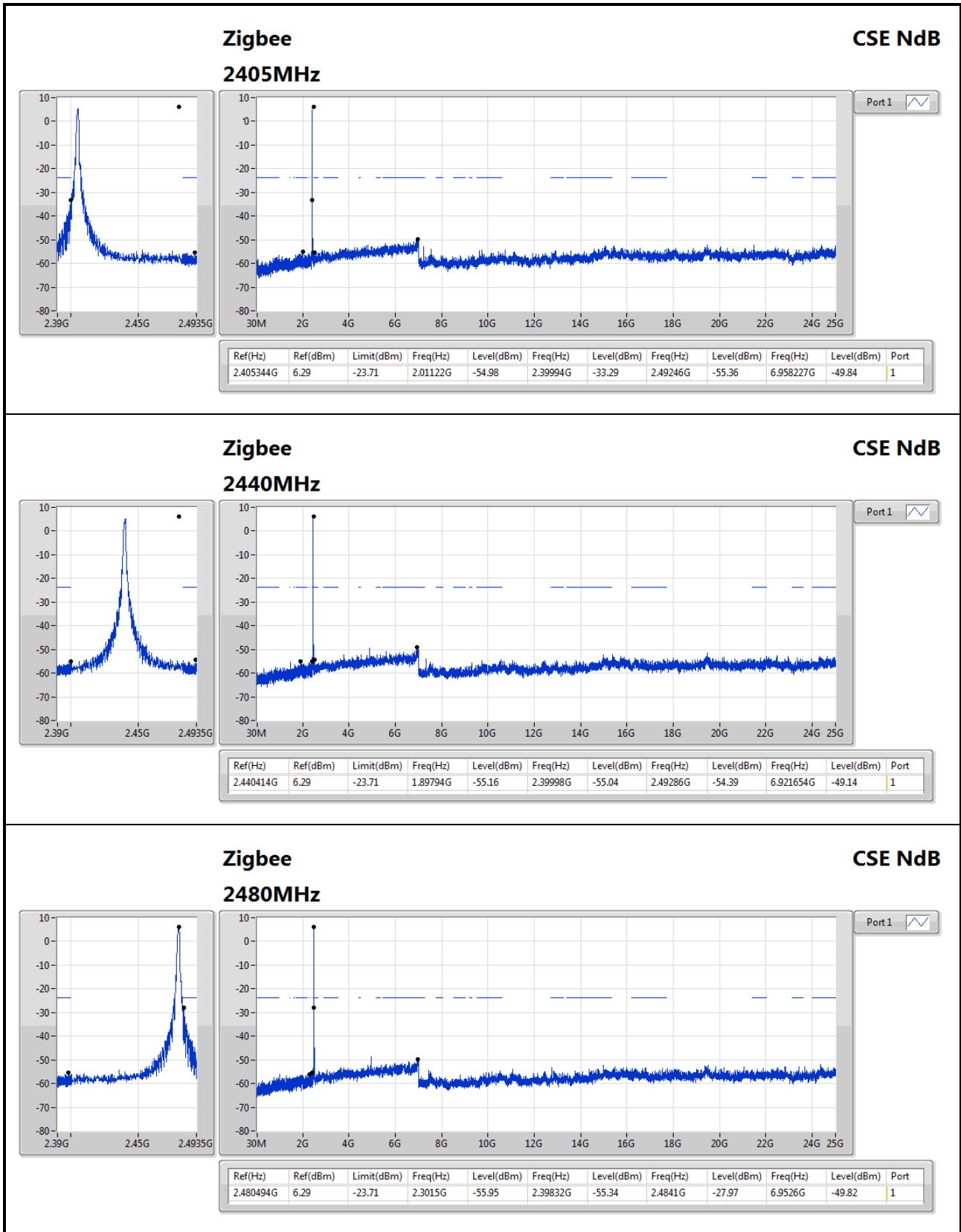



Summary

Mode	Result	Type	Freq (Hz)	Level (dBuV/m)	Limit (dBuV/m)	Margin (dB)	Factor (dB)	Dist (m)	Condition	Azimuth (°)	Height (m)	Comments
Zigbee	-	-	-	-	-	-	-	-	-	-	-	-
2.4-2.4835GHz	Pass	PK	30M	29.62	40.00	-10.38	-3.85	3	Vertical	360	1.00	-





Result

Mode	Result	Type	Freq (Hz)	Level (dBuV/m)	Limit (dBuV/m)	Margin (dB)	Factor (dB)	Dist (m)	Condition	Azimuth (°)	Height (m)	Comments
Zigbee	-	-	-	-	-	-	-	-	-	-	-	-
2440MHz	Pass	PK	30M	21.51	40.00	-18.49	-3.85	3	Horizontal	0	1.00	-
2440MHz	Pass	PK	119.24M	18.20	43.50	-25.30	-7.95	3	Horizontal	0	1.00	-
2440MHz	Pass	PK	198.78M	18.83	43.50	-24.67	-10.08	3	Horizontal	0	1.00	-
2440MHz	Pass	PK	441.28M	23.16	46.00	-22.84	-2.47	3	Horizontal	0	1.00	-
2440MHz	Pass	PK	579.02M	27.15	46.00	-18.85	-0.53	3	Horizontal	0	1.00	-
2440MHz	Pass	PK	736.16M	27.17	46.00	-18.83	0.95	3	Horizontal	0	1.00	-
2440MHz	Pass	PK	30M	29.62	40.00	-10.38	-3.85	3	Vertical	360	1.00	-
2440MHz	Pass	PK	43.58M	26.06	40.00	-13.94	-10.00	3	Vertical	360	1.00	-
2440MHz	Pass	PK	152.22M	19.59	43.50	-23.91	-9.64	3	Vertical	360	1.00	-
2440MHz	Pass	PK	334.58M	24.88	46.00	-21.12	-5.22	3	Vertical	360	1.00	-
2440MHz	Pass	PK	559.62M	26.70	46.00	-19.30	-0.47	3	Vertical	360	1.00	-
2440MHz	Pass	PK	806M	27.71	46.00	-18.29	1.82	3	Vertical	360	1.00	-

## Zigbee 2440MHz\_adapter

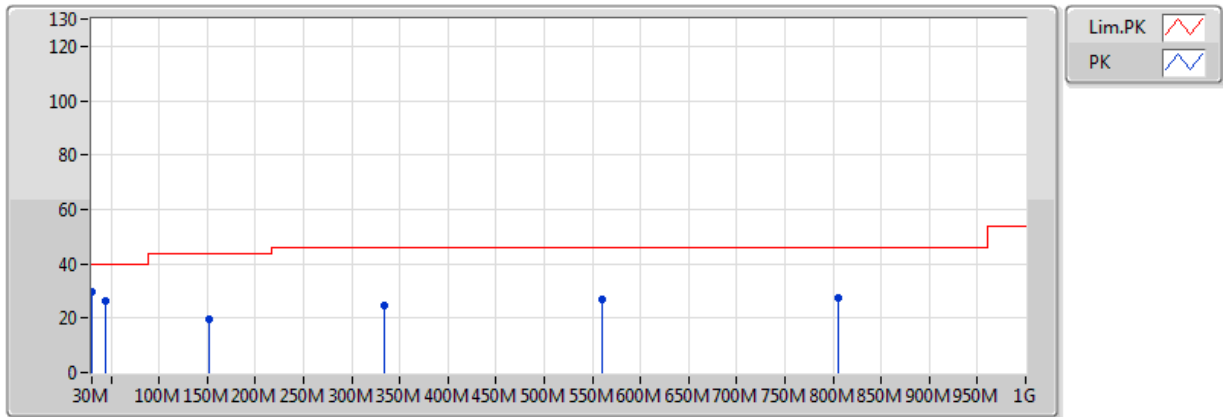

EUT=X

Type	Freq (Hz)	Level (dBuV/m)	Limit (dBuV/m)	Margin (dB)	Factor (dB)	Dist (m)	Condition	Azimuth (°)	Height (m)	Comments	Raw (dBuV)	AF (dB)	CL (dB)	PA (dB)
PK	30M	29.62	40.00	-10.38	-3.85	3	Vertical	360	1.00	-	33.47	22.02	1.71	27.58
PK	43.58M	26.06	40.00	-13.94	-10.00	3	Vertical	360	1.00	-	36.06	15.73	1.82	27.55
PK	152.22M	19.59	43.50	-23.91	-9.64	3	Vertical	360	1.00	-	29.23	15.38	2.12	27.13
PK	334.58M	24.88	46.00	-21.12	-5.22	3	Vertical	360	1.00	-	30.10	18.87	2.79	26.89
PK	559.62M	26.70	46.00	-19.30	-0.47	3	Vertical	360	1.00	-	27.17	23.79	3.67	27.93
PK	806M	27.71	46.00	-18.29	1.82	3	Vertical	360	1.00	-	25.89	24.87	4.68	27.73

## Zigbee 2440MHz\_adapter

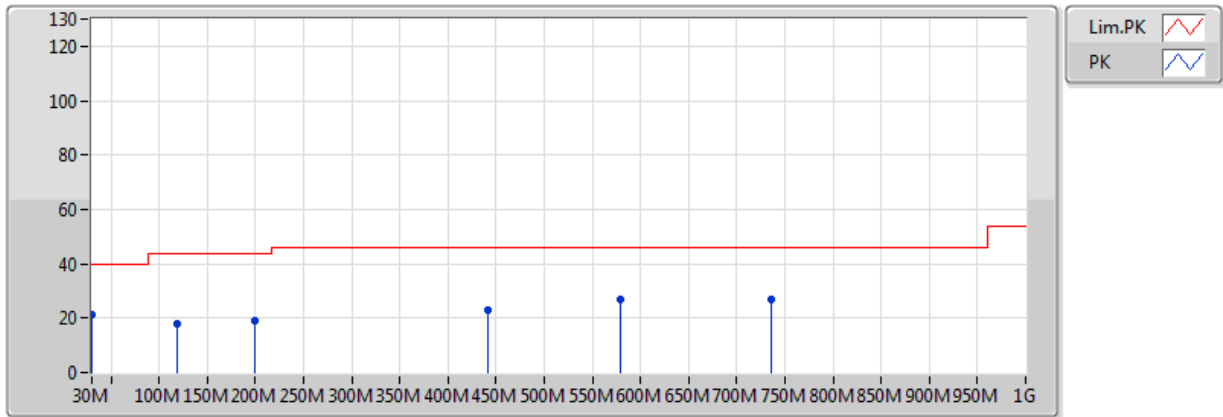

EUT=X

Type	Freq (Hz)	Level (dBuV/m)	Limit (dBuV/m)	Margin (dB)	Factor (dB)	Dist (m)	Condition	Azimuth (°)	Height (m)	Comments	Raw (dBuV)	AF (dB)	CL (dB)	PA (dB)
PK	30M	21.51	40.00	-18.49	-3.85	3	Horizontal	0	1.00	-	25.36	22.02	1.71	27.58
PK	119.24M	18.20	43.50	-25.30	-7.95	3	Horizontal	0	1.00	-	26.15	17.27	2.06	27.28
PK	198.78M	18.83	43.50	-24.67	-10.08	3	Horizontal	0	1.00	-	28.91	14.36	2.48	26.92
PK	441.28M	23.16	46.00	-22.84	-2.47	3	Horizontal	0	1.00	-	25.63	21.67	3.37	27.52
PK	579.02M	27.15	46.00	-18.85	-0.53	3	Horizontal	0	1.00	-	27.68	23.73	3.70	27.96
PK	736.16M	27.17	46.00	-18.83	0.95	3	Horizontal	0	1.00	-	26.22	24.53	4.30	27.88



Summary

Mode	Result	Type	Freq (Hz)	Level (dBuV/m)	Limit (dBuV/m)	Margin (dB)	Factor (dB)	Dist (m)	Condition	Azimuth (°)	Height (m)	Comments
Zigbee	-	-	-	-	-	-	-	-	-	-	-	-
2.4-2.4835GHz	Pass	AV	2.483502G	53.90	54.00	-0.10	31.78	3	Horizontal	11	1.50	-



Result

Mode	Result	Type	Freq (Hz)	Level (dBuV/m)	Limit (dBuV/m)	Margin (dB)	Factor (dB)	Dist (m)	Condition	Azimuth (°)	Height (m)	Comments
Zigbee	-	-	-	-	-	-	-	-	-	-	-	-
2405MHz	Pass	AV	2.39G	43.74	54.00	-10.26	31.45	3	Horizontal	20	1.04	-
2405MHz	Pass	AV	2.4052G	94.75	Inf	-Inf	31.50	3	Horizontal	20	1.04	-
2405MHz	Pass	AV	4.81G	34.45	54.00	-19.55	6.45	3	Horizontal	360	1.50	-
2405MHz	Pass	PK	2.3882G	55.64	74.00	-18.36	31.44	3	Horizontal	20	1.04	-
2405MHz	Pass	PK	2.4056G	98.34	Inf	-Inf	31.50	3	Horizontal	20	1.04	-
2405MHz	Pass	PK	4.81G	47.11	74.00	-26.89	6.45	3	Horizontal	360	1.50	-
2405MHz	Pass	AV	2.388G	43.32	54.00	-10.68	31.44	3	Vertical	95	1.14	-
2405MHz	Pass	AV	2.4052G	86.15	Inf	-Inf	31.50	3	Vertical	95	1.14	-
2405MHz	Pass	AV	4.81G	34.75	54.00	-19.25	6.45	3	Vertical	179	1.08	-
2405MHz	Pass	PK	2.3808G	54.79	74.00	-19.21	31.41	3	Vertical	95	1.14	-
2405MHz	Pass	PK	2.4054G	89.84	Inf	-Inf	31.50	3	Vertical	95	1.14	-
2405MHz	Pass	PK	4.81G	46.65	74.00	-27.35	6.45	3	Vertical	179	1.08	-
2440MHz	Pass	AV	2.384G	43.26	54.00	-10.74	31.42	3	Horizontal	12	1.01	-
2440MHz	Pass	AV	2.44G	94.32	Inf	-Inf	31.62	3	Horizontal	12	1.01	-
2440MHz	Pass	AV	2.5G	44.05	54.00	-9.95	31.84	3	Horizontal	12	1.01	-
2440MHz	Pass	AV	4.88G	34.17	54.00	-19.83	6.62	3	Horizontal	360	1.50	-
2440MHz	Pass	PK	2.378G	53.90	74.00	-20.10	31.40	3	Horizontal	12	1.01	-
2440MHz	Pass	PK	2.4404G	98.13	Inf	-Inf	31.63	3	Horizontal	12	1.01	-
2440MHz	Pass	PK	2.484G	54.97	74.00	-19.03	31.78	3	Horizontal	12	1.01	-
2440MHz	Pass	PK	4.88G	46.51	74.00	-27.49	6.62	3	Horizontal	360	1.50	-
2440MHz	Pass	AV	2.3896G	43.35	54.00	-10.65	31.44	3	Vertical	160	2.01	-
2440MHz	Pass	AV	2.44G	84.27	Inf	-Inf	31.62	3	Vertical	160	2.01	-
2440MHz	Pass	AV	2.5G	44.02	54.00	-9.98	31.84	3	Vertical	160	2.01	-
2440MHz	Pass	AV	4.88G	34.72	54.00	-19.28	6.62	3	Vertical	12	1.00	-
2440MHz	Pass	PK	2.3424G	54.36	74.00	-19.64	31.28	3	Vertical	160	2.01	-
2440MHz	Pass	PK	2.4404G	88.04	Inf	-Inf	31.63	3	Vertical	160	2.01	-
2440MHz	Pass	PK	2.4976G	55.45	74.00	-18.55	31.83	3	Vertical	160	2.01	-
2440MHz	Pass	PK	4.88G	47.62	74.00	-26.38	6.62	3	Vertical	12	1.00	-
2480MHz	Pass	AV	2.4802G	88.22	Inf	-Inf	31.77	3	Horizontal	11	1.50	-
2480MHz	Pass	AV	2.483502G	53.90	54.00	-0.10	31.78	3	Horizontal	11	1.50	-
2480MHz	Pass	AV	4.96G	32.72	54.00	-21.28	6.82	3	Horizontal	0	1.50	-
2480MHz	Pass	PK	2.4804G	92.12	Inf	-Inf	31.77	3	Horizontal	11	1.50	-
2480MHz	Pass	PK	2.483502G	63.48	74.00	-10.52	31.78	3	Horizontal	11	1.50	-
2480MHz	Pass	PK	4.96G	46.82	74.00	-27.18	6.82	3	Horizontal	0	1.50	-
2480MHz	Pass	AV	2.4802G	79.41	Inf	-Inf	31.77	3	Vertical	45	1.17	-
2480MHz	Pass	AV	2.483502G	47.45	54.00	-6.55	31.78	3	Vertical	45	1.17	-
2480MHz	Pass	AV	4.96G	33.82	54.00	-20.18	6.82	3	Vertical	360	1.50	-
2480MHz	Pass	PK	2.4804G	83.46	Inf	-Inf	31.77	3	Vertical	45	1.17	-
2480MHz	Pass	PK	2.483502G	59.00	74.00	-15.00	31.78	3	Vertical	45	1.17	-
2480MHz	Pass	PK	4.96G	46.82	74.00	-27.18	6.82	3	Vertical	360	1.50	-

## Zigbee 2405MHz\_TX

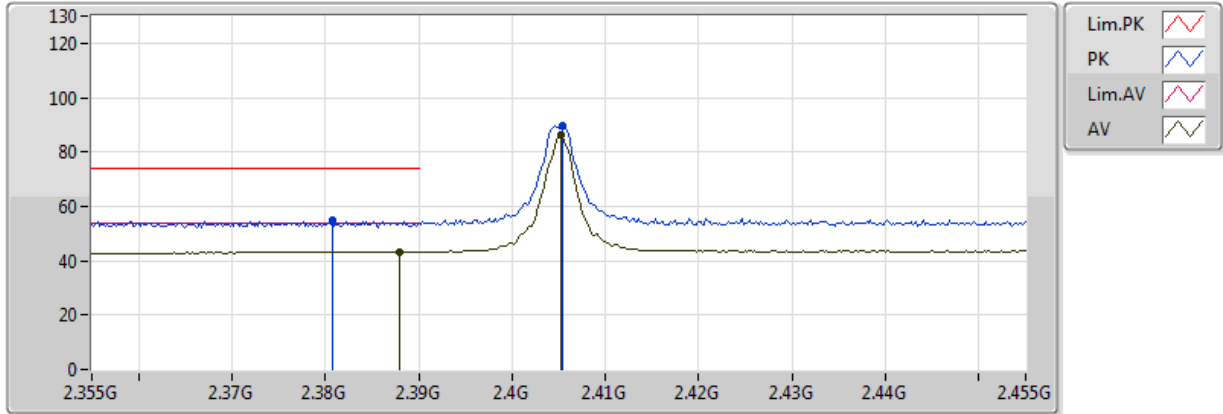

EUT=X

Type	Freq (Hz)	Level (dBuV/m)	Limit (dBuV/m)	Margin (dB)	Factor (dB)	Dist (m)	Condition	Azimuth (°)	Height (m)	Comments	Raw (dBuV)	AF (dB)	CL (dB)	PA (dB)
AV	2.388G	43.32	54.00	-10.68	31.44	3	Vertical	95	1.14	-	11.88	27.21	4.23	-
AV	2.4052G	86.15	Inf	-Inf	31.50	3	Vertical	95	1.14	-	54.66	27.25	4.25	-
PK	2.3808G	54.79	74.00	-19.21	31.41	3	Vertical	95	1.14	-	23.38	27.19	4.22	-
PK	2.4054G	89.84	Inf	-Inf	31.50	3	Vertical	95	1.14	-	58.34	27.25	4.25	-

## Zigbee 2405MHz\_TX

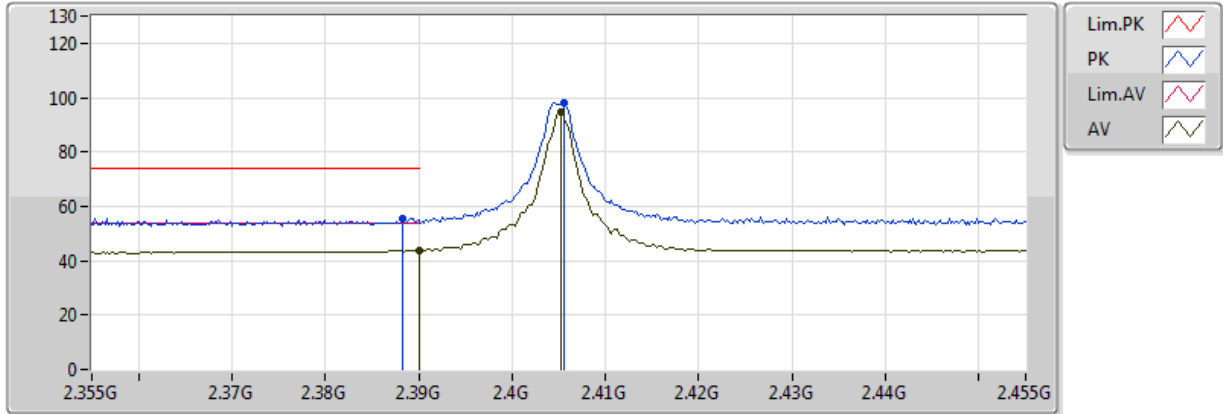

EUT=X

Type	Freq (Hz)	Level (dBuV/m)	Limit (dBuV/m)	Margin (dB)	Factor (dB)	Dist (m)	Condition	Azimuth (°)	Height (m)	Comments	Raw (dBuV)	AF (dB)	CL (dB)	PA (dB)
AV	2.39G	43.74	54.00	-10.26	31.45	3	Horizontal	20	1.04	-	12.29	27.21	4.23	-
AV	2.4052G	94.75	Inf	-Inf	31.50	3	Horizontal	20	1.04	-	63.25	27.25	4.25	-
PK	2.3882G	55.64	74.00	-18.36	31.44	3	Horizontal	20	1.04	-	24.20	27.21	4.23	-
PK	2.4056G	98.34	Inf	-Inf	31.50	3	Horizontal	20	1.04	-	66.84	27.25	4.25	-

## Zigbee

### 2405MHz\_TX

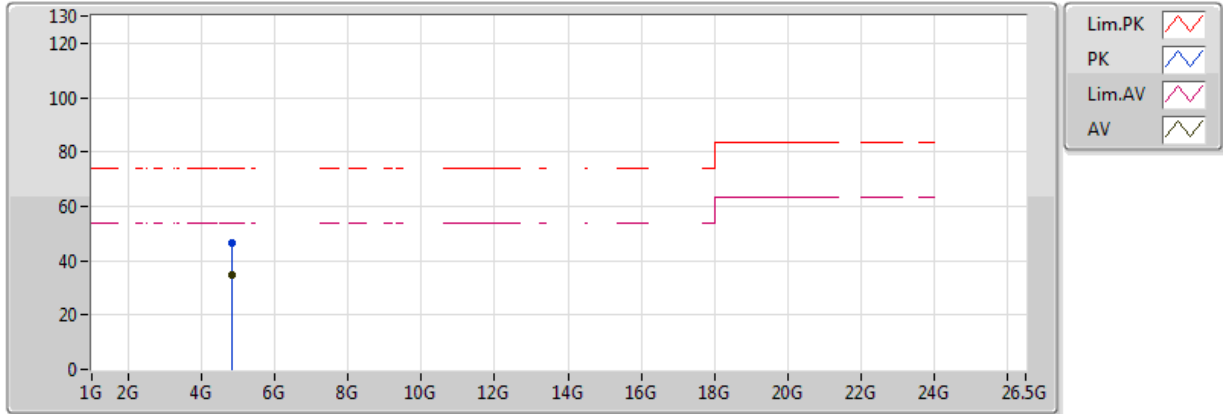

EUT=X

Type	Freq (Hz)	Level (dBuV/m)	Limit (dBuV/m)	Margin (dB)	Factor (dB)	Dist (m)	Condition	Azimuth (°)	Height (m)	Comments	Raw (dBuV)	AF (dB)	CL (dB)	PA (dB)
AV	4.81G	34.75	54.00	-19.25	6.45	3	Vertical	179	1.08	-	28.30	31.20	5.36	30.11
PK	4.81G	46.65	74.00	-27.35	6.45	3	Vertical	179	1.08	-	40.20	31.20	5.36	30.11



## Zigbee

### 2405MHz\_TX

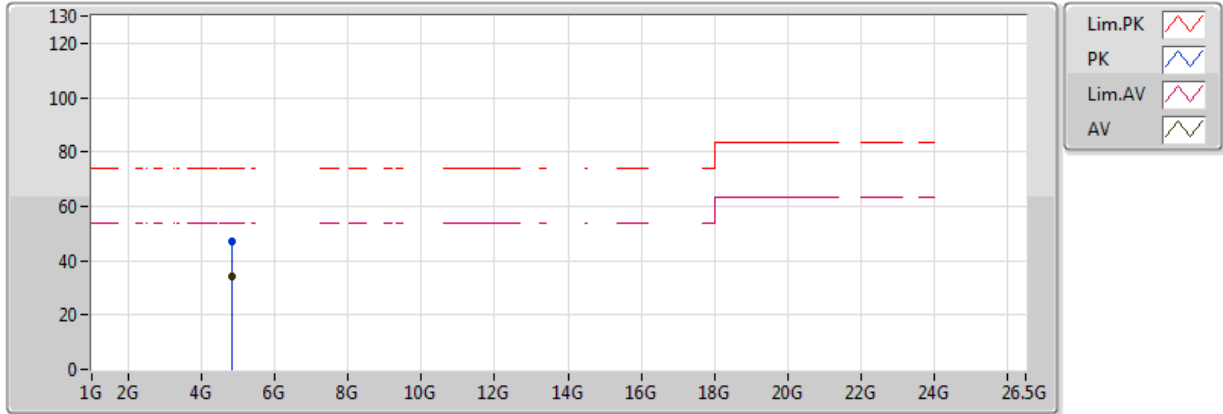

EUT=X

Type	Freq (Hz)	Level (dBuV/m)	Limit (dBuV/m)	Margin (dB)	Factor (dB)	Dist (m)	Condition	Azimuth (°)	Height (m)	Comments	Raw (dBuV)	AF (dB)	CL (dB)	PA (dB)
AV	4.81G	34.45	54.00	-19.55	6.45	3	Horizontal	360	1.50	-	28.00	31.20	5.36	30.11
PK	4.81G	47.11	74.00	-26.89	6.45	3	Horizontal	360	1.50	-	40.66	31.20	5.36	30.11

## Zigbee 2440MHz\_TX

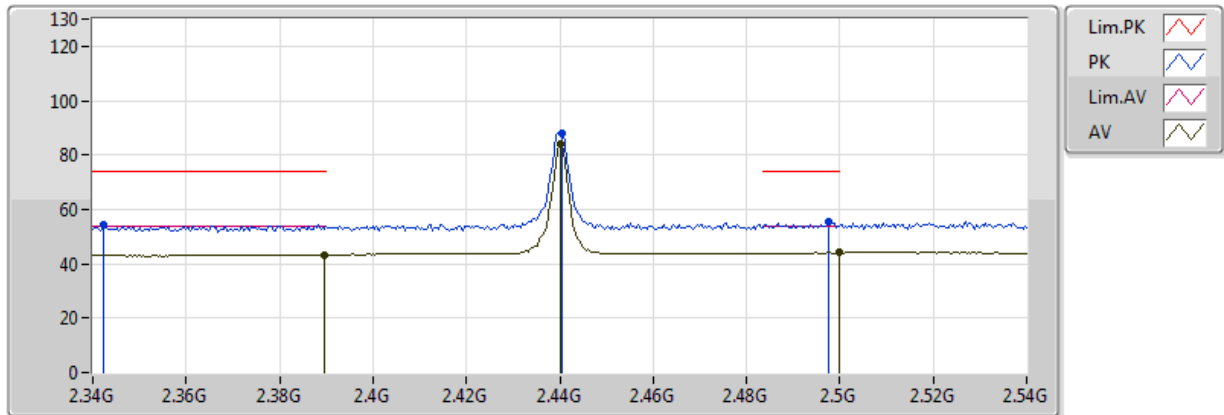

EUT=X

Type	Freq (Hz)	Level (dBuV/m)	Limit (dBuV/m)	Margin (dB)	Factor (dB)	Dist (m)	Condition	Azimuth (°)	Height (m)	Comments	Raw (dBuV)	AF (dB)	CL (dB)	PA (dB)
AV	2.3896G	43.35	54.00	-10.65	31.44	3	Vertical	160	2.01	-	11.90	27.21	4.23	-
AV	2.5G	44.02	54.00	-9.98	31.84	3	Vertical	160	2.01	-	12.18	27.50	4.34	-
AV	2.44G	84.27	Inf	-Inf	31.62	3	Vertical	160	2.01	-	52.64	27.34	4.28	-
PK	2.3424G	54.36	74.00	-19.64	31.28	3	Vertical	160	2.01	-	23.08	27.09	4.19	-
PK	2.4976G	55.45	74.00	-18.55	31.83	3	Vertical	160	2.01	-	23.62	27.49	4.34	-
PK	2.4404G	88.04	Inf	-Inf	31.63	3	Vertical	160	2.01	-	56.41	27.35	4.28	-

## Zigbee 2440MHz\_TX

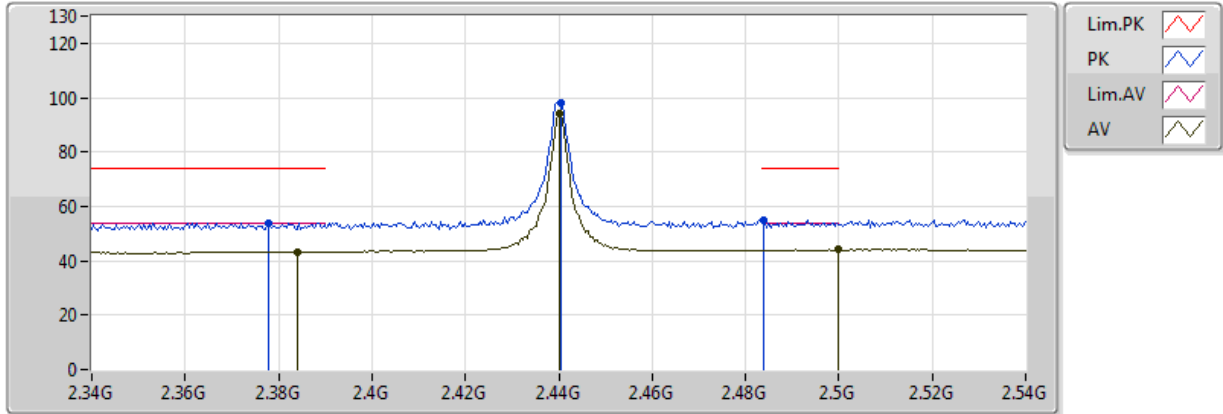

EUT=X

Type	Freq (Hz)	Level (dBuV/m)	Limit (dBuV/m)	Margin (dB)	Factor (dB)	Dist (m)	Condition	Azimuth (°)	Height (m)	Comments	Raw (dBuV)	AF (dB)	CL (dB)	PA (dB)
AV	2.384G	43.26	54.00	-10.74	31.42	3	Horizontal	12	1.01	-	11.84	27.20	4.23	-
AV	2.5G	44.05	54.00	-9.95	31.84	3	Horizontal	12	1.01	-	12.21	27.50	4.34	-
AV	2.44G	94.32	Inf	-Inf	31.62	3	Horizontal	12	1.01	-	62.70	27.34	4.28	-
PK	2.378G	53.90	74.00	-20.10	31.40	3	Horizontal	12	1.01	-	22.50	27.18	4.22	-
PK	2.484G	54.97	74.00	-19.03	31.78	3	Horizontal	12	1.01	-	23.19	27.46	4.32	-
PK	2.4404G	98.13	Inf	-Inf	31.63	3	Horizontal	12	1.01	-	66.50	27.35	4.28	-

## Zigbee 2440MHz\_TX

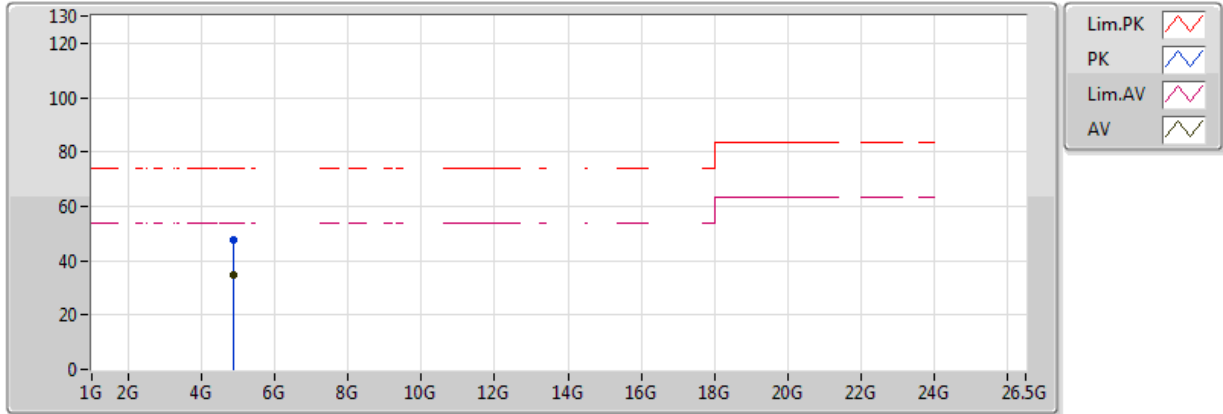

EUT=X

Type	Freq (Hz)	Level (dBuV/m)	Limit (dBuV/m)	Margin (dB)	Factor (dB)	Dist (m)	Condition	Azimuth (°)	Height (m)	Comments	Raw (dBuV)	AF (dB)	CL (dB)	PA (dB)
AV	4.88G	34.72	54.00	-19.28	6.62	3	Vertical	12	1.00	-	28.10	31.31	5.41	30.09
PK	4.88G	47.62	74.00	-26.38	6.62	3	Vertical	12	1.00	-	41.00	31.31	5.41	30.09

## Zigbee

### 2440MHz\_TX

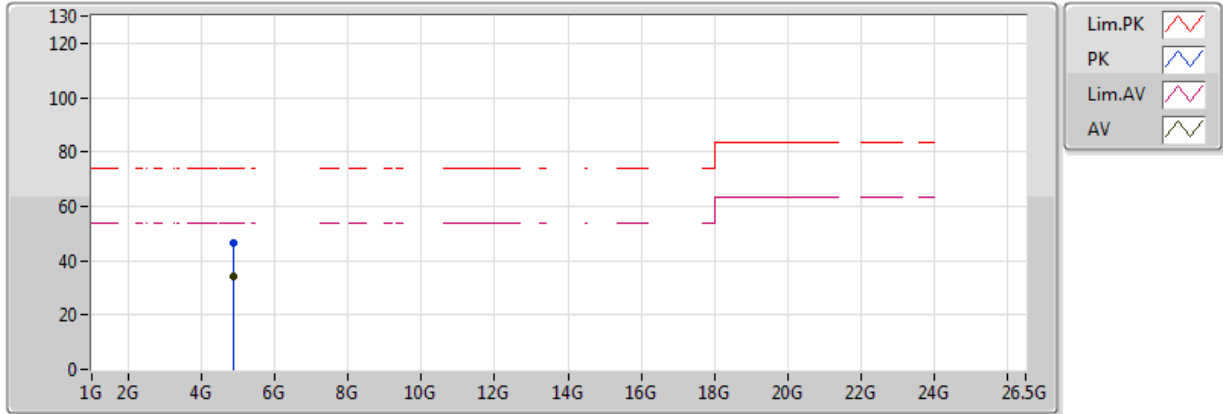

EUT=X

Type	Freq (Hz)	Level (dBuV/m)	Limit (dBuV/m)	Margin (dB)	Factor (dB)	Dist (m)	Condition	Azimuth (°)	Height (m)	Comments	Raw (dBuV)	AF (dB)	CL (dB)	PA (dB)
AV	4.88G	34.17	54.00	-19.83	6.62	3	Horizontal	360	1.50	-	27.55	31.31	5.41	30.09
PK	4.88G	46.51	74.00	-27.49	6.62	3	Horizontal	360	1.50	-	39.89	31.31	5.41	30.09

## Zigbee 2480MHz\_TX

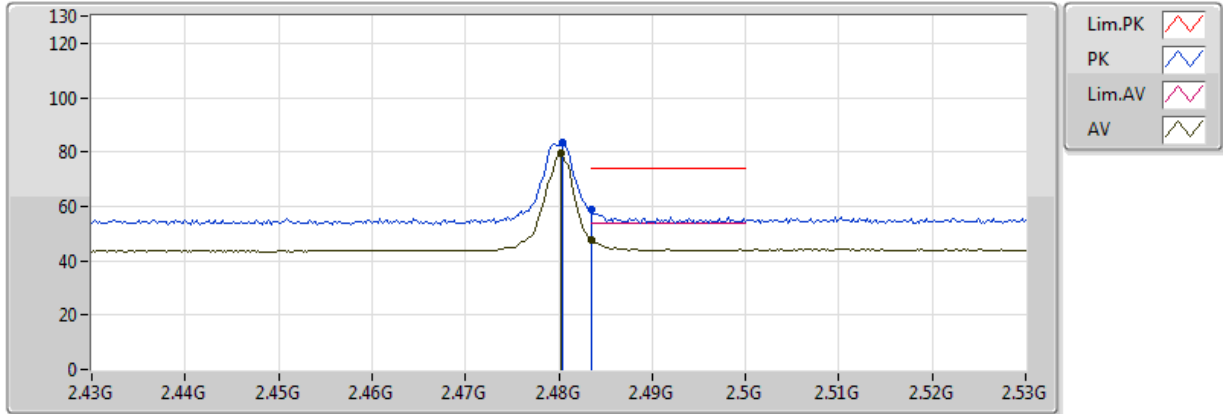

EUT=X

Type	Freq (Hz)	Level (dBuV/m)	Limit (dBuV/m)	Margin (dB)	Factor (dB)	Dist (m)	Condition	Azimuth (°)	Height (m)	Comments	Raw (dBuV)	AF (dB)	CL (dB)	PA (dB)
AV	2.483502G	47.45	54.00	-6.55	31.78	3	Vertical	45	1.17	-	15.67	27.46	4.32	-
AV	2.4802G	79.41	Inf	-Inf	31.77	3	Vertical	45	1.17	-	47.64	27.45	4.32	-
PK	2.483502G	59.00	74.00	-15.00	31.78	3	Vertical	45	1.17	-	27.22	27.46	4.32	-
PK	2.4804G	83.46	Inf	-Inf	31.77	3	Vertical	45	1.17	-	51.69	27.45	4.32	-

## Zigbee 2480MHz\_TX

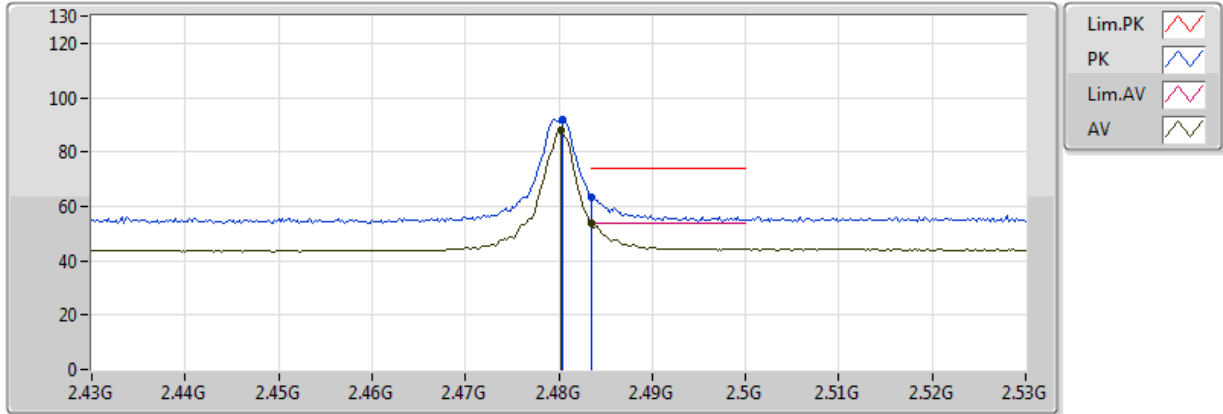

EUT=X

Type	Freq (Hz)	Level (dBuV/m)	Limit (dBuV/m)	Margin (dB)	Factor (dB)	Dist (m)	Condition	Azimuth (°)	Height (m)	Comments	Raw (dBuV)	AF (dB)	CL (dB)	PA (dB)
AV	2.483502G	53.90	54.00	-0.10	31.78	3	Horizontal	11	1.50	-	22.12	27.46	4.32	-
AV	2.4802G	88.22	Inf	-Inf	31.77	3	Horizontal	11	1.50	-	56.45	27.45	4.32	-
PK	2.483502G	63.48	74.00	-10.52	31.78	3	Horizontal	11	1.50	-	31.70	27.46	4.32	-
PK	2.4804G	92.12	Inf	-Inf	31.77	3	Horizontal	11	1.50	-	60.35	27.45	4.32	-

## Zigbee 2480MHz\_TX

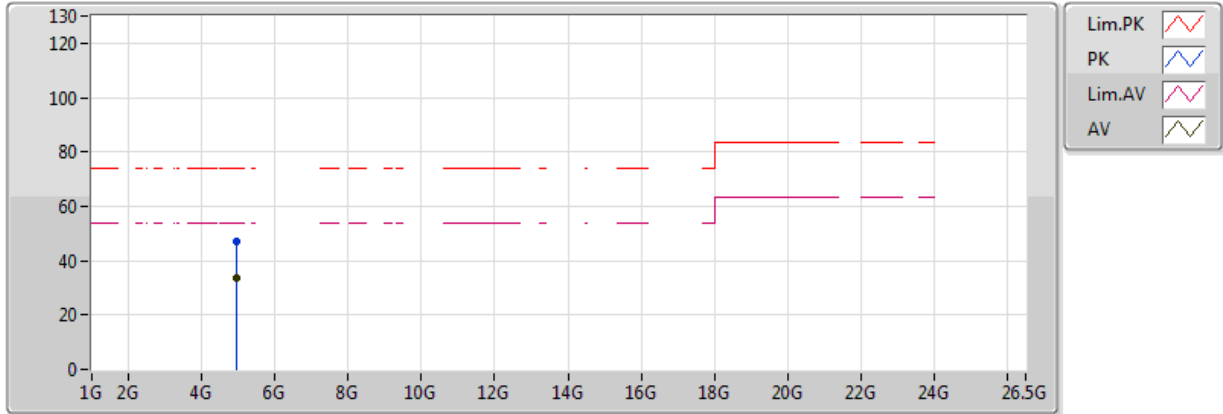

EUT=X

Type	Freq (Hz)	Level (dBuV/m)	Limit (dBuV/m)	Margin (dB)	Factor (dB)	Dist (m)	Condition	Azimuth (°)	Height (m)	Comments	Raw (dBuV)	AF (dB)	CL (dB)	PA (dB)
AV	4.96G	33.82	54.00	-20.18	6.82	3	Vertical	360	1.50	-	27.00	31.44	5.46	30.08
PK	4.96G	46.82	74.00	-27.18	6.82	3	Vertical	360	1.50	-	40.00	31.44	5.46	30.08



## Zigbee

### 2480MHz\_TX

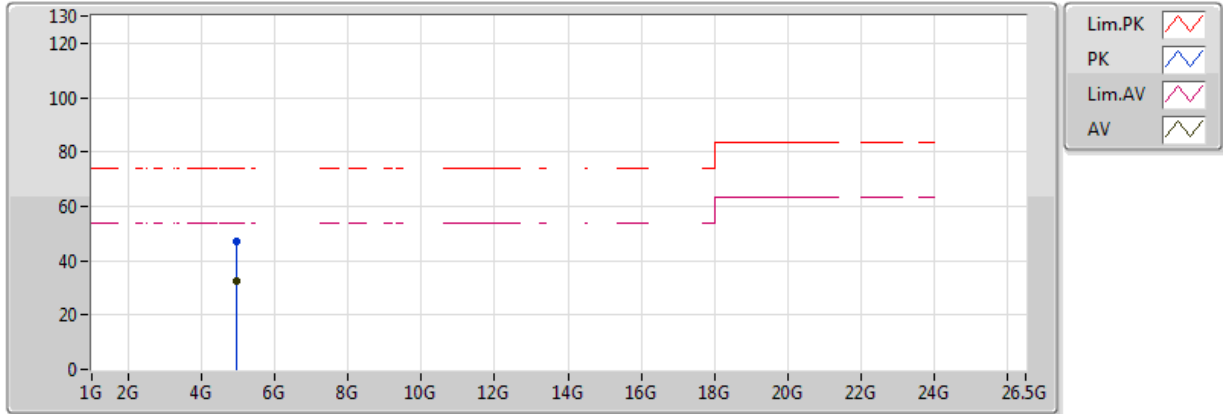

EUT=X

Type	Freq (Hz)	Level (dBuV/m)	Limit (dBuV/m)	Margin (dB)	Factor (dB)	Dist (m)	Condition	Azimuth (°)	Height (m)	Comments	Raw (dBuV)	AF (dB)	CL (dB)	PA (dB)
AV	4.96G	32.72	54.00	-21.28	6.82	3	Horizontal	0	1.50	-	25.90	31.44	5.46	30.08
PK	4.96G	46.82	74.00	-27.18	6.82	3	Horizontal	0	1.50	-	40.00	31.44	5.46	30.08