

# Operation Manual (Model:WDR300)

Ver. 1.0 – 07/26/2017

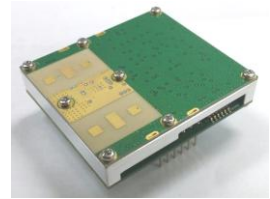

## 1. Features and Applications

- This motion-detection radar(Model: WDR300) operating at 24GHz ISM band, is a Doppler radar sensor detecting even minute movement of human or objects in real time.
- It detects up to 40 m, which is longer than the other conventional sensors and insensitive to the environmental change such as light, ambient temperature, dust etc.
- Maximum detection distance can be adjustable and be doubles by cascading connection of the same sensors.
- User friendly designs such as small form factor, single 5VDC power supply and wired/wireless communication interfaces provides easy application of this device.
- For outdoor usage, it adopts an algorithm differentiate motions between natural and artificial motion (especially for human).
- The sensor is suitable for the energy saving application by motion detection.

## 2. Maximum Ratings

Items	Symbol	Rating	Unit
DC power supply	$V_{DC}$	+5	VDC
Operating Temperature	$T_C$	-40 to +85	°C
Storage Temperature	$T_{STG}$	-50 to +130	°C

### CONFIDENTIAL AND PROPRIETARY

The information contained in this document shall remain the sole and exclusive property of Wooriro Co., LTD and shall not be disclosed by the recipient to third parties without prior consent of Wooriro in writing.

### 3. Performance Characteristics

Item		Performance	Note
Tx Frequency		24.05~24.25 GHz	ISM band
Tx EIRP		13dBm	
Antenna	Beam Width	60° x 35°	horizontal x vertical – half power
	Polarization	linear	
Velocity		0.2m/s~3m/s 3m/s~30m/s	Low detection mode High detection
Update Rate*		0.5Hz/10Hz	Low detection mode/ High detection
Outline		50 x 45 x 10 mm <sup>3</sup>	
Interface		Header 6pin	
Power Supply Voltage		+5 VDC	
Power Consumption		1.0W	

\* Target classification algorithm is applied only to the low detection mode

### 4. Product Outline and Dimensions

Top View

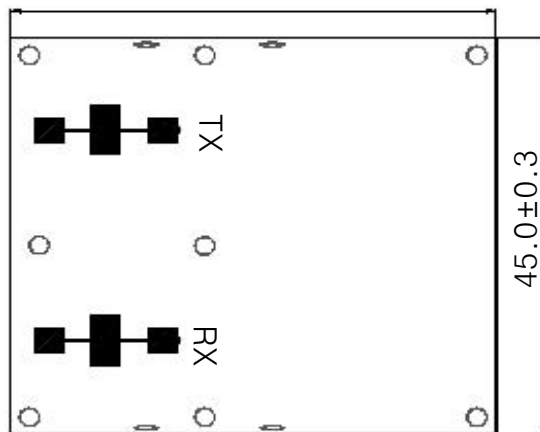

**CONFIDENTIAL AND PROPRIETARY**

The information contained in this document shall remain the sole and exclusive property of Wooriro Co., LTD and shall not be disclosed by the recipient to third parties without prior consent of Wooriro in writing.

Side View

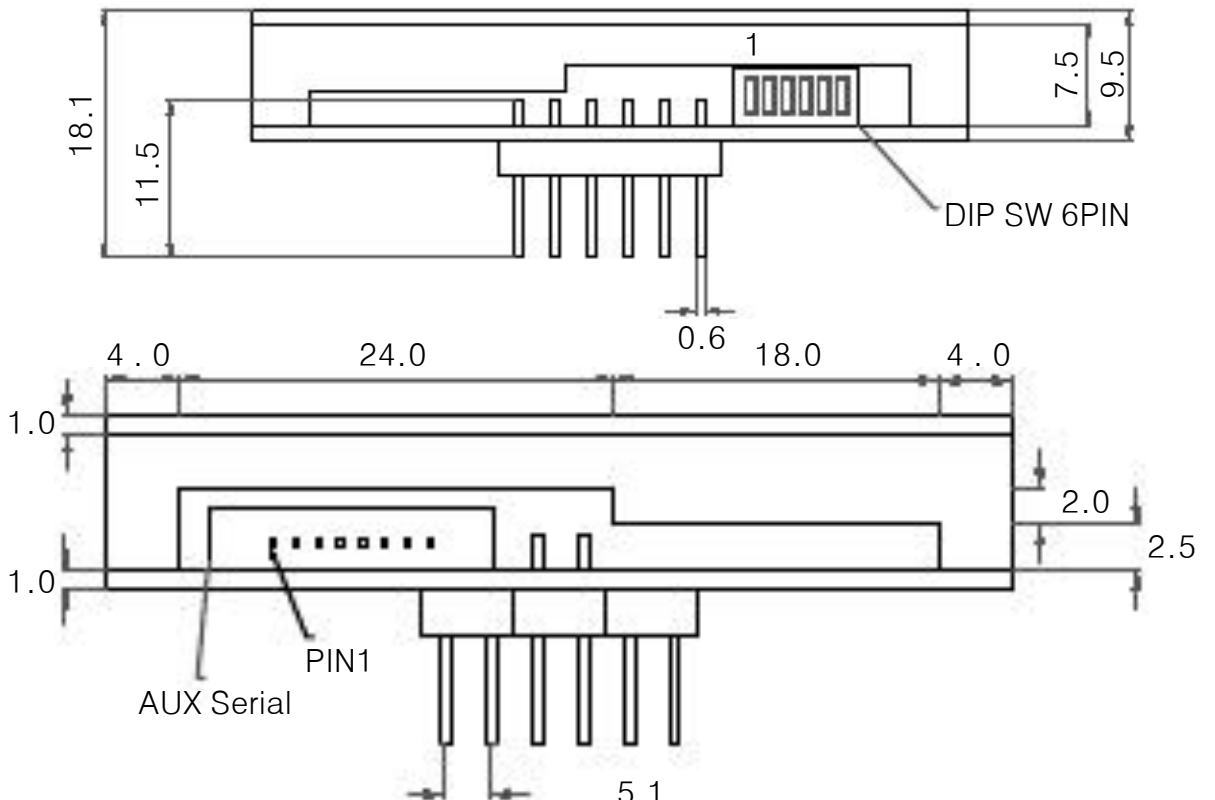

Bottom View

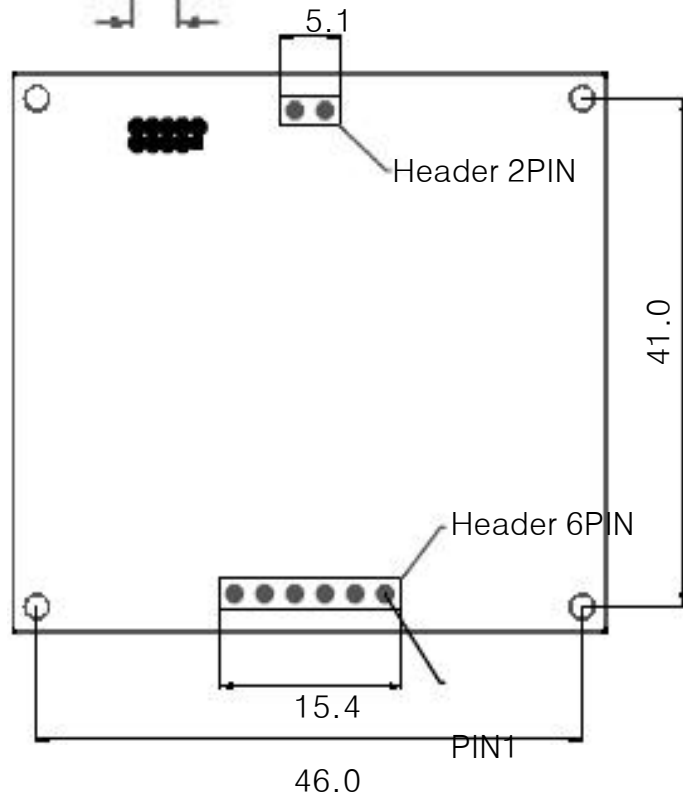

**CONFIDENTIAL AND PROPRIETARY**

The information contained in this document shall remain the sole and exclusive property of Wooriro Co., LTD and shall not be disclosed by the recipient to third parties without prior consent of Wooriro in writing.

## 5. Set Fuctions

### 5.1. Header-pin Connector

Connector	Pin#	Function	Description
Header 6pin	1	VDC	+5VDC
	2	GND	GND
	3	GPIO	3.3V D-Output (“High” @detection)
	4	PWM*	LED dimming usage
	5	UART_TX*	RS485-B(option)
	6	UART_RX*	RS485-A(option)
Header 2pin	For mechanical fixing purpose only		

\* See AN300-1

### 5.2. DIP Switch

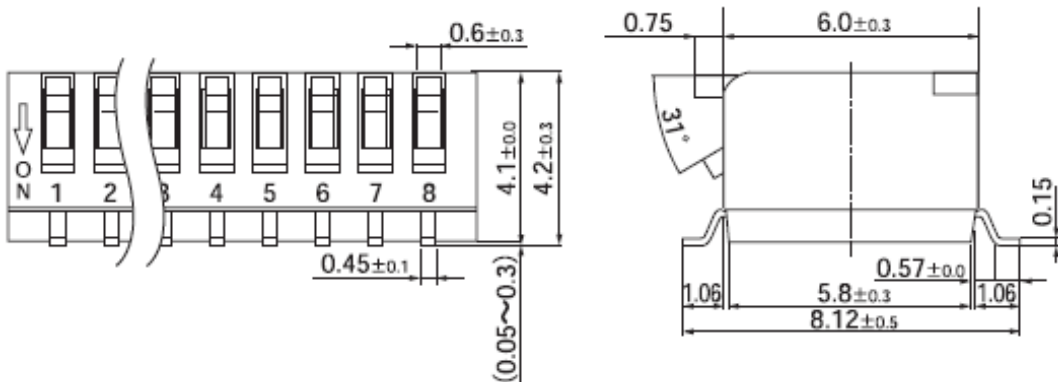

#### CONFIDENTIAL AND PROPRIETARY

The information contained in this document shall remain the sole and exclusive property of Wooriro Co., LTD and shall not be disclosed by the recipient to third parties without prior consent of Wooriro in writing.

## 5.2. DIP Switch

Function \ Pin#		#6	#5	#4	#3	#2	#1
Line-voltage rejection	50Hz	0					
	60Hz ( )	1					
Sensitivity	Max -3		0	0			
	Max-2		0	1			
	Max-1		1	0			
	Max (default)		1	1			
Serial Communication	Enable				0		
	Disable (default)				1		
Tx CW Frequency	Low					0	0
	Medium					0	1
	High					1	0
	Default					1	1

Note : "0"="ON" and "1"="OFF"

Fuction		Frequency [GHz]
Tx CW Frequency	Low	24.07 +/- 0.01
	Medium	24.125 +/- 0.01
	High	24.23 +/- 0.01
	Default	24.17 +/- 0.01

### CONFIDENTIAL AND PROPRIETARY

The information contained in this document shall remain the sole and exclusive property of Wooriro Co., LTD and shall not be disclosed by the recipient to third parties without prior consent of Wooriro in writing.

## 5.3. Serial Communication

To use “serial mode”, “#3”-pin of DIP Switch6 must be set to “ON”(=“0”; enable)

Baud rate = 256kbps, Parity = none, Data bits = 8bit, Stop = 1bit

See AN300-1 for the details

### 5.3.1. Master→WDR300 (2-byte)

Function	MSB byte	LSB byte	Note	
Line Voltage Rejection	0X01	0X{value}	{value} = 0 or 1	
Sensitivity	0X02	0X{value}	Slow detection	{value}== 0~9, 9 max
	0XF2	0X{value}	Fast detection	
Tx CW Frequency	0X03	0D{value}	{value} =0~250 Tx_Frequency=24,000MHz +{value}MHz	
Tx Off	0X04	0X{value}	{value} = 1 → Tx Off otherwise → Tx On	
Raw Data/ Report Detection/ Report Setting Values	0X05	0X{value}	{value} = 01	Raw data(slow)
			{value} = F1	Raw data(fast)
			{value} =02*	Report Detection(short)
			{value} =03	Report Detection(long)
			{value} =04	Report Setting Values
			otherwise	Disable
			All are one-time report except “Report detection”(continuous report)	

\* Default setting

#### CONFIDENTIAL AND PROPRIETARY

The information contained in this document shall remain the sole and exclusive property of Wooriro Co., LTD and shall not be disclosed by the recipient to third parties without prior consent of Wooriro in writing.

### 5.3.2. WDR300→Master

Response of Raw Data/Report Detection/Report Setting Values

See AN300-1 for the details

## 6. Product wiring

### 6.1. General Wiring Method

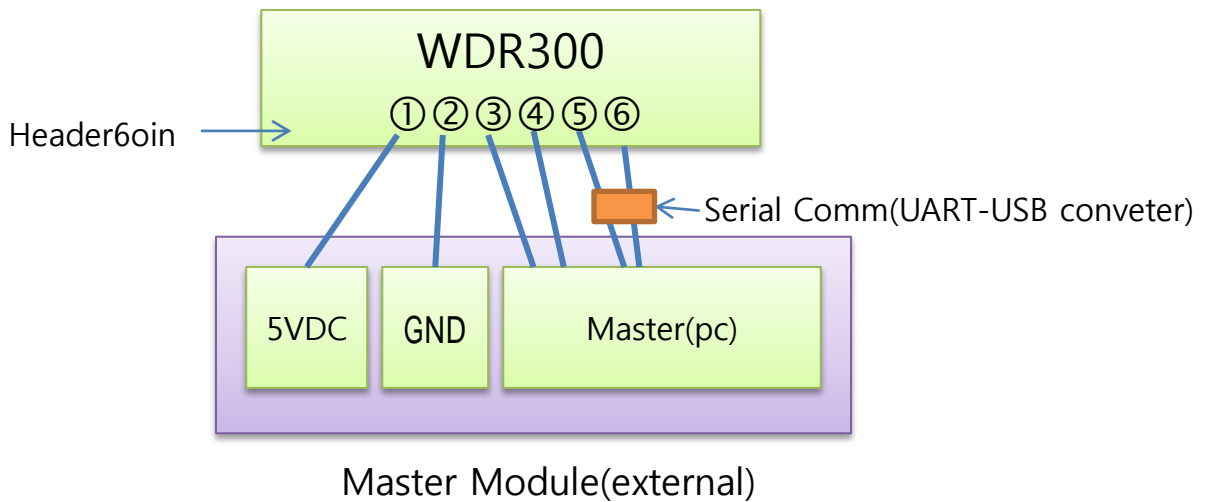

### 6.2. Wiring for operation test(an example)

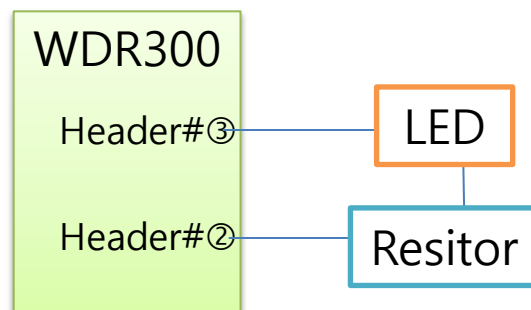

#### CONFIDENTIAL AND PROPRIETARY

The information contained in this document shall remain the sole and exclusive property of Wooriro Co., LTD and shall not be disclosed by the recipient to third parties without prior consent of Wooriro in writing.

## 7. Installation

✓ Before installation, you must read “appendix 1” carefully that describes the detection angle of the sensor.

✓ **Selecting Installation position, direction and angle.**

**Considering antenna as eyes and then approximately selecting the coverage. (If there is any difficulty in installation, send us the document and/or photograph, then we will help you to selection.)**

✓ **Confirming your selection**

- ① Set to maximum sensitivity (refer “5.2” if this manual)
- ② Check your coverage selection.
- ③ Check your wiring.(refer chapter 6)
- ④ Wait about 2 seconds after power on.
- ⑤ Check the blind spots. – If not enough change the direction and/or sensitivity.

### CONFIDENTIAL AND PROPRIETARY

The information contained in this document shall remain the sole and exclusive property of Wooriro Co., LTD and shall not be disclosed by the recipient to third parties without prior consent of Wooriro in writing.



## **FCC Statement**

### **Federal Communication Commission Interference Statement**

This equipment has been tested and found to comply with the limits for a Class B digital device, pursuant to Part 15 of the FCC Rules. These limits are designed to provide reasonable protection against harmful interference in a residential installation. This equipment generates, uses and can radiate radio frequency energy and, if not installed and used in accordance with the instructions, may cause harmful interference to radio communications. However, there is no guarantee that interference will not occur in a particular installation. If this equipment does cause harmful interference to radio or television reception, which can be determined by turning the equipment off and on, the user is encouraged to try to correct the interference by one of the following measures:

- Reorient or relocate the receiving antenna.
- Increase the separation between the equipment and receiver.
- Connect the equipment into an outlet on a circuit different from that to which the receiver is connected.
- Consult the dealer or an experienced radio/TV technician for help.

This device complies with Part 15 of the FCC Rules. Operation is subject to the following two conditions: (1) This device may not cause harmful interference, and (2) this device must accept any interference received, including interference that may cause undesired operation.

#### **CONFIDENTIAL AND PROPRIETARY**

The information contained in this document shall remain the sole and exclusive property of Wooriro Co., LTD and shall not be disclosed by the recipient to third parties without prior consent of Wooriro in writing.

## **OEM/Integrators Installation Manual**

### **IMPORTANT NOTE:**

This module is intended for OEM integrator only. The OEM integrator is responsible for the compliance to all the rules that apply to the product into which this certified RF module is integrated. Additional testing and certification may be necessary when multiple modules are used.

Any changes or modifications not expressly approved by the manufacturer could void the user's authority to operate this equipment.

OEM integrator are responsible for ensuring that the end-user has no manual instructions to remove or install module.

"The grantee (Wooriro Co., Ltd.) will offer guidance to the host manufacturer if requested in order to assist in Subpart B issues."

### **USERS MANUAL OF THE END PRODUCT:**

The end user has to also be informed that any changes or modifications not expressly approved by the manufacturer could void the user's authority to operate this equipment.

If the labeling area is smaller than the palm of the hand, then additional FCC part 15.19 statement is required to be available in the users manual: This device complies with Part 15 of FCC rules.

Operation is subject to the following two conditions: (1) this device may not cause harmful interference and (2) this device must accept any interference received, including interference that may cause undesired operation.

#### **CONFIDENTIAL AND PROPRIETARY**

The information contained in this document shall remain the sole and exclusive property of Wooriro Co., LTD and shall not be disclosed by the recipient to third parties without prior consent of Wooriro in writing.

## LABEL OF THE END PRODUCT:

The final end product must be labeled in a visible area with the following " Contains TX FCC ID: 2AM57WDR300".

If the labeling area is larger than the palm of the hand, then the following FCC part 15.19 statement has to also be available on the label: This device complies with Part 15 of FCC rules. Operation is subject to the following two conditions: (1) this device may not cause harmful interference and (2) this device must accept any interference received, including interference that may cause undesired operation.

Ant.	Brand	Model Name	Antenna Type	Connector	Gain(dBi)
1	WooriRadar	WDR300	Patch Array Antenna	N/A	8.25

### CONFIDENTIAL AND PROPRIETARY

The information contained in this document shall remain the sole and exclusive property of Wooriro Co., LTD and shall not be disclosed by the recipient to third parties without prior consent of Wooriro in writing.

## **CE Statement For MPE Statement – Mobile device**

This equipment complies with EU radiation exposure limits set forth for an uncontrolled environment. This equipment should be installed and operated with minimum distance 20cm between the radiator & your body.

All operational modes

Operational mode: 24GHz radar detection

The frequency and the maximum transmitted power in EU are listed below:

24.07GHz~24.23GHz : 11.40 dBm

Hereby , [WOORIRO Co., Ltd.] declares that the radio equipment type [WDR300] is in compliance with Directive 2014/53/EU. The full text of the EU declaration of conformity is available at the following internet address:  
[www.wooriro.com](http://www.wooriro.com)

### **CONFIDENTIAL AND PROPRIETARY**

The information contained in this document shall remain the sole and exclusive property of Wooriro Co., LTD and shall not be disclosed by the recipient to third parties without prior consent of Wooriro in writing.

## ESD-INFORMATION



This Wooriro sensor is sensitive to damage from ESD. Normal precautions as usually applied to ESD sensitive devices are sufficient when handling the device. Touching the signal output pins has to be avoided at any time before soldering or plugging the device into a motherboard.

## APPROVAL

Wooriro Standard Product. Changes will not be notified as long as there is no influence on form, fit and within this datasheet specified function of the product.

This Data Sheet contains the technical specifications of the described product. All previous versions of this Data Sheet are no longer valid.

### CONFIDENTIAL AND PROPRIETARY

The information contained in this document shall remain the sole and exclusive property of Wooriro Co., LTD and shall not be disclosed by the recipient to third parties without prior consent of Wooriro in writing.

## Appendix 1 : Antenna detection angle

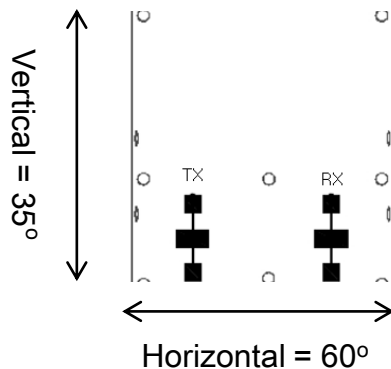

Antenna consist of 2 parts; Tx and rx. They are same 1x3 patch type having 60 degree horizontal half-power beam width and 35 degree vertical half-power beam width.

Horizontal/vertical are not absolute and can be rotated for your own purpose.

The beam-shape is fan shaped but at short range the coverage angle become wider. The actual detection profile is similar to a balloon. Note there is a trade-off between near blind spots and maximum detection range. This trade-off becomes more serious when the installation height becomes higher.

## Appendix 2: Radome Design

Radome is the case of antenna part. The sensitivity may be greatly degraded unless properly designed.

This table is a rule-of-thumb design rule.

Thickness	Material	Spacing
<2.0mm	plastic	6.2+/-2mm

### CONFIDENTIAL AND PROPRIETARY

The information contained in this document shall remain the sole and exclusive property of Wooriro Co., LTD and shall not be disclosed by the recipient to third parties without prior consent of Wooriro in writing.