

## Thank you for sharing your home with Otto.

We are committed to creating experiences that make your life more open, more secure and more connected.

Enjoy Life Unlocked.

The Otto Team



otto.

Welcome to Life Unlocked.™

### Terms & Policies

We take your security and privacy very seriously. Before installing or using Otto, please read the terms, policies and other information at [meetotto.com/legal](http://meetotto.com/legal). This device complies with Part 15 of the FCC Rules and with Industry Canada licence-exempt RSS standard(s). Operation is subject to the following two conditions: (1) this device may not cause harmful interference and (2) this device must accept any interference received, including interference that may cause undesired operation. © 2017 Otto LLC. All rights reserved.

Le présent appareil est conforme aux CNR d'Industrie Canada applicables aux appareils radio exempts de licence. L'exploitation est autorisée aux deux conditions suivantes: (1) l'appareil ne doit pas produire de brouillage, et (2) l'appareil doit accepter tout brouillage radioélectrique subi, même si le brouillage est susceptible d'en compromettre le fonctionnement. © 2017 Otto LLC. Tous droits réservés

This equipment generates, uses and can radiate radio frequency energy and, if not installed and used in accordance with the instructions, may cause harmful interference to radio communications. However, there is no guarantee that interference will not occur in a particular installation. If this equipment does cause harmful interference to radio or television reception, which can be determined by turning the equipment off and on, the user is encouraged to try to correct the interference by one or more of the following measures:

- Reorient or relocate the receiving antenna.
- Increase the separation between the equipment and receiver.
- Connect the equipment into an outlet on a circuit different from that to which the receiver is connected.
- Consult the dealer or an experienced radio/TV technician for help

Your device is a radio transmitter and receiver. It is designed and manufactured not to exceed the emission limits for exposure to radio frequency (RF) energy set by the Federal Communications Commission of the U.S. Government. The FCC has established criteria for the amount of radio frequency energy various products may produce depending on their intended usage. This product has been evaluated and found to comply with the FCC's exposure criteria. For body worn operation, the FCC RF exposure guidelines were also met when used with the accessories supplied or designed for this product. Use of other accessories may not ensure compliance with FCC RF exposure guidelines and should be avoided.

**CAUTION:** Any changes or modifications not expressly approved by the party responsible for compliance could void the user's authority to operate this device.

This device must not be co-located with other transmitters.

The installer of this radio equipment must ensure that the antenna is located or pointed such that it does not emit RF field in excess of Health Canada limits for the general population; consult Safety Code 6, obtainable from Health Canada's website: [www.hc-sc.gc.ca/rp/b](http://www.hc-sc.gc.ca/rp/b)

otto.

### This Box Contains

1. BOLT (with removable extender for short backset)
2. STRIKE CUP
3. MOTOR
4. RING
5. BATTERY PACK
6. TOOLKIT

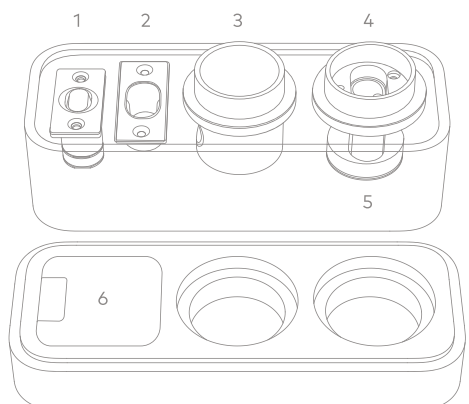

## Getting Started

Follow these four steps to enjoy Life Unlocked.



**Download the Otto app**



**Install Otto**

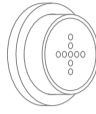

**Pair Otto with the app**



**Invite family and friends**

## Install Otto

Professional installation is required. To schedule an appointment with one of our professional installation partners or to learn more about installing Otto, please visit [meetotto.com/install](https://meetotto.com/install) or call **855.OTTO.HELP**.

## How It Works

### From Outside

Press the glass.

(Smartphone Bluetooth must be turned on)

### From Inside

Turn the dial.

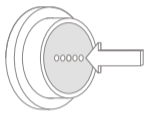

**Locked**

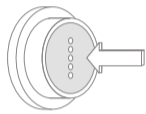

**Unlocked**



**Locked**



**Unlocked**

### Remote Lock/Unlock

Available through the Otto app.

## Entry Code

To unlock your door without a smartphone, use your entry code.

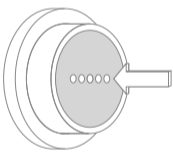

1. Press the glass to activate number display.

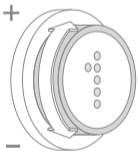

2. Turn the dial to find the number and press the glass to select.

## Replace Batteries (from inside)

LEDs will turn red when battery is low. Promptly replace with two CR123 batteries to ensure full functionality of the device.

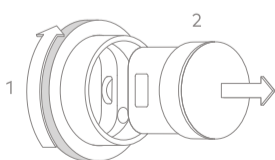

1. Turn the base clockwise until the battery pack is ejected.

2. Remove the battery pack from the device. Access the batteries by removing the small screw.

For additional information on how to use Otto, visit [meetotto.com/howitworks](https://meetotto.com/howitworks).

**otto.**