

FCC Test Report

Report No.: RF190307E01

FCC ID: 2ALI9V-JETT

Test Model: JET-T

Received Date: Mar. 07, 2019

Test Date: Apr. 17 to 18, 2019

Issued Date: Apr. 30, 2019

Applicant: WISEJET, INC.

Address: 401, IT Venture Town, 35, Techno 9-ro, Yuseong-gu, Daejun, South Korea

Issued By: Bureau Veritas Consumer Products Services (H.K.) Ltd., Taoyuan Branch
Hsin Chu Laboratory

Lab Address: E-2, No.1, Li Hsin 1st Road, Hsinchu Science Park, Hsinchu City 300,
Taiwan R.O.C.

Test Location: E-2, No.1, Li Hsin 1st Road, Hsinchu Science Park, Hsinchu City 300,
Taiwan R.O.C.

**FCC Registration /
Designation Number:** 723255 / TW2022



This report is for your exclusive use. Any copying or replication of this report to or for any other person or entity, or use of our name or trademark, is permitted only with our prior written permission. This report sets forth our findings solely with respect to the test samples identified herein. The results set forth in this report are not indicative or representative of the quality or characteristics of the lot from which a test sample was taken or any similar or identical product unless specifically and expressly noted. Our report includes all of the tests requested by you and the results thereof based upon the information that you provided to us. You have 60 days from date of issuance of this report to notify us of any material error or omission caused by our negligence, provided, however, that such notice shall be in writing and shall specifically address the issue you wish to raise. A failure to raise such issue within the prescribed time shall constitute your unqualified acceptance of the completeness of this report, the tests conducted and the correctness of the report contents. Unless specific mention, the uncertainty of measurement has been explicitly taken into account to declare the compliance or non-compliance to the specification. The report must not be used by the client to claim product certification, approval, or endorsement by TAF or any government agencies.

Table of Contents

Release Control Record	4
1 Certificate of Conformity	5
2 Summary of Test Results	6
2.1 Measurement Uncertainty	6
2.2 Modification Record	6
3 General Information	7
3.1 General Description of EUT	7
3.2 Description of Test Modes	8
3.2.1 Test Mode Applicability and Tested Channel Detail	9
3.3 Description of Support Units	11
3.3.1 Configuration of System under Test	12
3.4 General Description of Applied Standards	13
4 Test Types and Results	14
4.1 Radiated Emission Measurement	14
4.1.1 Limits of Radiated Emission Measurement	14
4.1.2 Test Instruments	15
4.1.3 Test Procedures	18
4.1.4 Deviation from Test Standard	19
4.1.5 Test Setup	20
4.1.6 EUT Operating Conditions	21
4.1.7 Test Results (LRP mode)	22
4.1.8 Test Results (HRP mode)	52
4.2 Conducted Emission Measurement	62
4.2.1 Limits of Conducted Emission Measurement	62
4.2.2 Test Instruments	62
4.2.3 Test Procedures	63
4.2.4 Deviation from Test Standard	63
4.2.5 Test Setup	63
4.2.6 EUT Operating Conditions	63
4.2.7 Test Results	64
4.3 6dB Bandwidth Measurement	66
4.3.1 Limits of 6dB Bandwidth Measurement	66
4.3.2 Test Setup	66
4.3.3 Test Instruments	66
4.3.4 Test Procedure	66
4.3.5 Deviation from Test Standard	66
4.3.6 EUT Operating Conditions	66
4.3.7 Test Result (LRP Mode)	67
4.3.8 Test Result (HRP Mode)	69
4.4 Output Power Measurement	70
4.4.1 Limits of Output Power Measurement	70
4.4.2 Test Setup	71
4.4.3 Test Instruments	71
4.4.4 Test Procedures	72
4.4.5 Deviation from Test Standard	72
4.4.6 EUT Operating Conditions	73
4.4.7 Test Results (LRP Mode)	73
4.4.8 Test Results (HRP Mode)	75
4.5 Frequency Stability Measurement	76
4.5.1 Limits of Frequency Stability Measurement	76
4.5.2 Test Setup	76
4.5.3 Test Instruments	76
4.5.4 Test Procedure	76

4.5.5 Deviation from Test Standard	76
4.5.6 EUT Operating Condition	76
4.5.7 Test Results	77
5 Pictures of Test Arrangements.....	79
Appendix – Information of the Testing Laboratories	80



Release Control Record

Issue No.	Description	Date Issued
RF190307E01	Original release.	Apr. 30, 2019

1 Certificate of Conformity

Product: V-JET
Brand: WISEJET
Test Model: JET-T
Sample Status: ENGINEERING SAMPLE
Applicant: WISEJET, INC.
Test Date: Apr. 17 to 18, 2019
Standards: 47 CFR FCC Part 15, Subpart C (Section 15.255)
ANSI C63.10: 2013

The above equipment has been tested by **Bureau Veritas Consumer Products Services (H.K.) Ltd., Taoyuan Branch**, and found compliance with the requirement of the above standards. The test record, data evaluation & Equipment Under Test (EUT) configurations represented herein are true and accurate accounts of the measurements of the sample's EMC characteristics under the conditions specified in this report.

Prepared by :  _____, **Date:** _____ Apr. 30, 2019
Claire Kuan / Specialist

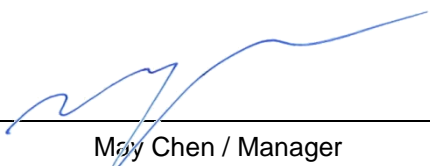
Approved by :  _____, **Date:** _____ Apr. 30, 2019
May Chen / Manager

2 Summary of Test Results

47 CFR FCC Part 15, Subpart C (Section 15.255)			
FCC Clause	Test Item	Result	Remarks
15.207	AC Power Conducted Emission	PASS	Meet the requirement of limit. Minimum passing margin is -32.49dB at 0.49375MHz.
15.255(e)	6dB Bandwidth	-	Reference only.
15.255 (c) & (e)	Output Power	PASS	Meet the requirement of limit.
15.255(d)	Spurious Emissions	PASS	Meet the requirement of limit. Minimum passing margin is -4.5dB at 844.15MHz.
15.255(f)	Frequency Stability	PASS	Meet the requirement of limit.

Note: Determining compliance based on the results of the compliance measurement, not taking into account measurement instrumentation uncertainty.

2.1 Measurement Uncertainty

Where relevant, the following measurement uncertainty levels have been estimated for tests performed on the EUT as specified in CISPR 16-4-2:

Measurement	Frequency	Expanded Uncertainty (k=2) (\pm)
Conducted Emissions at mains ports	150kHz ~ 30MHz	1.8 dB
Radiated Emissions up to 1 GHz	30MHz ~ 1GHz	5.1 dB
Radiated Emissions above 1 GHz	1GHz ~ 6GHz	5.1 dB
	6GHz ~ 18GHz	5.0 dB
	18GHz ~ 40GHz	5.2 dB
	40GHz ~ 200GHz	5.4 dB

2.2 Modification Record

There were no modifications required for compliance.

3 General Information

3.1 General Description of EUT

Product	V-JET
Brand	WISEJET
Test Model	JET-T
Status of EUT	ENGINEERING SAMPLE
Power Supply Rating	DC 5V
Modulation Type	16QAM, QPSK, BPSK
Transfer Rate	LRP-BPSK (20.337Mb/s) HRP-QPSK (0.952Gbs -Quarter Rate, 1.904Gb/s-Half Rate) HRP-16QAM (3.807 Gb/s-Full Rate)
Operating Frequency	LRP: 60.16GHz ~ 62.96GHz HRP: 60.48GHz ~ 62.64GHz
Output Power	LRP: 24.1 dBm HRP: 29.9 dBm
Antenna Type	Refer to Note
Antenna Connector	NA
Accessory Device	NA
Data Cable Supplied	NA

Note:

1. The antenna provided to the EUT, please refer to the following table:

Brand	Model	Antenna Gain (dBi)	Frequency range	Antenna Type	Connector Type
LATTICE SEMICONDUCTOR	Sil6310	18	59.4~63.56GHz	patch array antenna	none

2. The above EUT information is declared by manufacturer and for more detailed features description, please refer to the manufacturer's specifications or user's manual.

3.2 Description of Test Modes

LRP MODE							
Frequency Band	Channel Plan	Channel	Frequency	Channel	Frequency	Channel	Frequency
60.16 – 60.80GHz	A	1	60.16GHz	2	60.48GHz	3	60.80GHz
62.32 – 62.96GHz	B	1	62.32GHz	2	62.64GHz	3	62.96GHz

HRP MODE	
Channel	Frequency
1	60.48GHz
2	62.64GHz

3.2.1 Test Mode Applicability and Tested Channel Detail

EUT CONFIGURE MODE	APPLICABLE TO						DESCRIPTION
	PLC	BW	OP	FS	RE < 1G	RE ≥ 1G	
L	-	√	√	-	√	√	LRP Mode
H	√	√	√	√	√	√	HRP Mode

Where **PLC**: Power Line Conducted Emission **BW**: 6dB Bandwidth
OP: Output Power **FS**: Frequency Stability
RE < 1G: Radiated Emission below 1GHz **RE ≥ 1G**: Radiated Emission above 1GHz

NOTE: The EUT had been pre-tested on the positioned of each 3 axis. The worst case was found when positioned on **Z-plane**.

Power Line Conducted Emission Test:

- Pre-Scan has been conducted to determine the worst-case mode from all possible combinations between available modulations, data rates and antenna ports (if EUT with antenna diversity architecture).
- Following channel(s) was (were) selected for the final test as listed below.

EUT CONFIGURE MODE	AVAILABLE CHANNEL	TESTED CHANNEL	MODULATION TYPE	DATA RATE
H	2	1	QPSK	0.952 Gb/s

6dB Bandwidth Test:

- Pre-Scan has been conducted to determine the worst-case mode from all possible combinations between available modulations, data rates and antenna ports (if EUT with antenna diversity architecture).
- Following channel(s) was (were) selected for the final test as listed below.

EUT CONFIGURE MODE	AVAILABLE CHANNEL	TESTED CHANNEL	MODULATION TYPE	DATA RATE
L	3	1, 2, 3	BPSK	20.337 Mb/s
H	2	1, 2	QPSK	0.952 Gb/s

Output Power Test:

- Pre-Scan has been conducted to determine the worst-case mode from all possible combinations between available modulations, data rates and antenna ports (if EUT with antenna diversity architecture).
- Following channel(s) was (were) selected for the final test as listed below.

EUT CONFIGURE MODE	AVAILABLE CHANNEL	TESTED CHANNEL	MODULATION TYPE	DATA RATE
L	3	1, 2, 3	BPSK	20.337 Mb/s
H	2	1, 2	QPSK	0.952 Gb/s

Frequency stability test:

- Pre-Scan has been conducted to determine the worst-case mode from all possible combinations between available modulations, data rates and antenna ports (if EUT with antenna diversity architecture).
- Following channel(s) was (were) selected for the final test as listed below.

EUT CONFIGURE MODE	AVAILABLE CHANNEL	TESTED CHANNEL	DATA RATE
H	2	1, 2	0.952 Gb/s

Radiated Emission Test (Below 1GHz):

- Pre-Scan has been conducted to determine the worst-case mode from all possible combinations between available modulations, data rates and antenna ports (if EUT with antenna diversity architecture).
- Following channel(s) was (were) selected for the final test as listed below.

EUT CONFIGURE MODE	AVAILABLE CHANNEL	TESTED CHANNEL	MODULATION TYPE	DATA RATE
L	3	1, 2, 3	BPSK	20.337 Mb/s
H	2	1, 2	QPSK	0.952 Gb/s

Radiated Emission Test (Above 1GHz):

- Pre-Scan has been conducted to determine the worst-case mode from all possible combinations between available modulations, data rates and antenna ports (if EUT with antenna diversity architecture).
- Following channel(s) was (were) selected for the final test as listed below.

EUT CONFIGURE MODE	AVAILABLE CHANNEL	TESTED CHANNEL	MODULATION TYPE	DATA RATE
L	3	1, 2, 3	BPSK	20.337 Mb/s
H	2	1, 2	QPSK	0.952 Gb/s

Test Condition:

APPLICABLE TO	ENVIRONMENTAL CONDITIONS	INPUT POWER (SYSTEM)	TESTED BY
PLC	25deg. C, 75%RH	120Vac, 60Hz	Andy Ho
BW	23deg. C, 62%RH	120Vac, 60Hz	Weiwei Lo
OP	23deg. C, 62%RH	120Vac, 60Hz	Weiwei Lo
FS	23deg. C, 62%RH	120Vac, 60Hz	Weiwei Lo
RE<1G	23deg. C, 69%RH	120Vac, 60Hz	Andy Ho
RE≥1G	24deg. C, 68%RH	120Vac, 60Hz	Andy Ho

3.3 Description of Support Units

The EUT has been tested as an independent unit together with other necessary accessories or support units. The following support units or accessories were used to form a representative test configuration during the tests.

ID	Product	Brand	Model No.	Serial No.	FCC ID	Remarks
A.	PC	ASUS	UN45H	NA	NA	Supplied by client
B.	Test Tool	WISEJET	V-JET_T10_V3.3	NA	NA	Supplied by client
C.	DC PowerSupply	GOOD WILL INSTRUMENT CO., LTD	GPC-3030D	E847076	NA	Provided by Lab
D.	V-JET	WISEJET	V-JET-4K-R	NA	NA	Supplied by client
E.	HDMI Monitor	LG	24UD58	804NTBK75997	NA	Provided by Lab

Note:

1. All power cords of the above support units are non-shielded (1.8m).

ID	Descriptions	Qty.	Length (m)	Shielding (Yes/No)	Cores (Qty.)	Remarks
1.	microHDMI	1	0.6	Yes	0	Supplied by client
2.	DC Cable	1	3	No	0	Provided by Lab
3.	HDMI Cable	1	1.5	Yes	2	Supplied by client

Note: The core(s) is(are) originally attached to the cable(s).

3.3.1 Configuration of System under Test

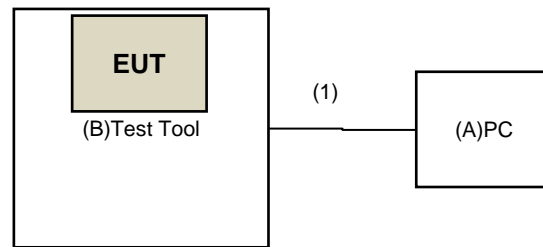

(2)

Under Table

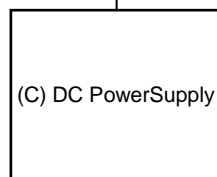

Remote Site

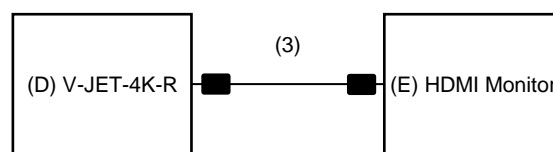

3.4 General Description of Applied Standards

The EUT is a RF Product. According to the specifications of the manufacturer, it must comply with the requirements of the following standards:

FCC Part 15, Subpart C (15.255)

ANSI C63.10-2013

FCC KDB 200443 D02 RF Detector Method v01

All test items have been performed and recorded as per the above standards.

4 Test Types and Results

4.1 Radiated Emission Measurement

4.1.1 Limits of Radiated Emission Measurement

Spurious Emission	
Frequency Range	Limitation
Radiated emissions below 40GHz	Part 15.209
Between 40GHz and 200GHz	90pW/cm ² (at 3 meter)
Note: The levels of the spurious emissions shall not exceed the level of the fundamental emission	

Emissions radiated outside of the specified bands, shall be according to the general radiated limits in 15.209 as following:

Frequencies (MHz)	Field strength (microvolts/meter)	Measurement distance (meters)
0.009-0.490	2400/F(kHz)	300
0.490-1.705	24000/F(kHz)	30
1.705-30.0	30	30
30-88	100	3
88-216	150	3
216-960	200	3
Above 960	500	3

NOTE:

1. The lower limit shall apply at the transition frequencies.
2. Emission level (dBuV/m) = 20 log Emission level (uV/m).
3. As shown in 15.35(b), for frequencies above 1000MHz, the field strength limits are based on average detector, however, the peak field strength of any emission shall not exceed the maximum permitted average limits, specified above by more than 20dB under any condition of modulation.
4. Section 15.205 restricted bands of operation shall compliance with the limits in Section 15.209.

4.1.2 Test Instruments

Below 40GHz test:

DESCRIPTION & MANUFACTURER	MODEL NO.	SERIAL NO.	CALIBRATED DATE	CALIBRATED UNTIL
Test Receiver Agilent	N9038A	MY50010156	July 12, 2018	July 11, 2019
Pre-Amplifier EMCI	EMC001340	980142	Jan. 25, 2019	Jan. 24, 2020
Loop Antenna Electro-Metrics	EM-6879	269	Sep. 07, 2018	Sep. 06, 2019
RF Cable	NA	LOOPCAB-001	Jan. 14, 2019	Jan. 13, 2020
RF Cable	NA	LOOPCAB-002	Jan. 14, 2019	Jan. 13, 2020
Pre-Amplifier Mini-Circuits	ZFL-1000VH2B	AMP-ZFL-05	May 05, 2018	May 04, 2019
Trilog Broadband Antenna SCHWARZBECK	VULB 9168	9168-361	Nov. 22, 2018	Nov. 21, 2019
RF Cable	8D	966-3-1	Mar. 18, 2019	Mar. 17, 2020
RF Cable	8D	966-3-2	Mar. 18, 2019	Mar. 17, 2020
RF Cable	8D	966-3-3	Mar. 18, 2019	Mar. 17, 2020
Fixed attenuator Mini-Circuits	UNAT-5+	PAD-3m-3-01	Sep. 27, 2018	Sep. 26, 2019
Horn_Antenna SCHWARZBECK	BBHA9120-D	9120D-406	Nov. 25, 2018	Nov. 24, 2019
Pre-Amplifier EMCI	EMC12630SE	980384	Jan. 28, 2019	Jan. 27, 2020
RF Cable	EMC104-SM-SM-1200	160922	Jan. 28, 2019	Jan. 27, 2020
RF Cable	EMC104-SM-SM-2000	180601	June 12, 2018	June 11, 2019
RF Cable	EMC104-SM-SM-6000	180602	June 12, 2018	June 11, 2019
Spectrum Analyzer Keysight	N9030A	MY54490679	July 23, 2018	July 22, 2019
Pre-Amplifier EMCI	EMC184045SE	980387	Jan. 28, 2019	Jan. 27, 2020
Horn_Antenna SCHWARZBECK	BBHA 9170	BBHA9170519	Nov. 25, 2018	Nov. 24, 2019
RF Cable	EMC102-KM-KM-1200	160924	Jan. 28, 2019	Jan. 27, 2020
RF Cable	EMC102-KM-KM-1200	160925	Jan. 28, 2019	Jan. 27, 2020
Software	ADT_Radiated_V8.7.08	NA	NA	NA
Antenna Tower & Turn Table Max-Full	MF-7802	MF780208406	NA	NA
Boresight Antenna Fixture	FBA-01	FBA-SIP01	NA	NA
DC Power Supply Topward	6603D	795558	NA	NA
Temperature & Humidity Chamber Giant Force	GTH-150-40-SP-AR	MAA0812-008	Jan. 09, 2019	Jan. 08, 2020
True RMS Clamp Meter FLUKE	325	31130711WS	May 22, 2018	May 21, 2019

Note:

1. The calibration interval of the above test instruments is 12 months and the calibrations are traceable to NML/ROC and NIST/USA.
2. The test was performed in 966 Chamber No. 3.
3. Loop antenna was used for all emissions below 30 MHz.
4. Tested Date: Apr. 17 to 18, 2019

Above 40GHz test:

DESCRIPTION & MANUFACTURER	MODEL NO.	SERIAL NO.	CALIBRATED DATE	CALIBRATED UNTIL
Spectrum Analyzer Agilent	E4446A	MY48250254	Nov. 14, 2018	Nov. 13, 2019
*Harmonic Mixer (33~55GHz) OML	M22HWD	110215-1	Oct. 17, 2017	Oct. 16, 2019
*Horn Antenna (33~55GHz) OML	M22RH	110215-1	Oct. 17, 2017	Oct. 16, 2019
*Harmonic Mixer (50~75GHz) OML	M15RH	110215-1	Oct. 17, 2017	Oct. 16, 2019
*Horn Antenna (50~75GHz) OML	M15HWD	110215-1	Oct. 17, 2017	Oct. 16, 2019
*Harmonic Mixer (75~110GHz) OML	M10HWD	110215-1	Oct. 17, 2017	Oct. 16, 2019
*Horn Antenna (75~110GHz) OML	M10RH	110215-1	Oct. 17, 2017	Oct. 16, 2019
*Harmonic Mixer (110~170GHz) OML	M06RH	110215-1	Oct. 17, 2017	Oct. 16, 2019
*Horn Antenna(110~170GHz) OML	M06HWD	110215-1	Oct. 17, 2017	Oct. 16, 2019
*Harmonic Mixer (140~220GHz) OML	M05HWD	110215-1	Oct. 17, 2017	Oct. 16, 2019
*Horn Antenna (140~220GHz) OML	M05RH	110215-1	Oct. 17, 2017	Oct. 16, 2019
*Harmonic Mixer (220~325GHz) OML	M03HWA	M03HWA_140505-1	Oct. 17, 2017	Oct. 16, 2019
*Horn Antenna (220~325GHz) OML	M03RH	M03RH_140508-1	Oct. 17, 2017	Oct. 16, 2019
*Diplexer EMCI	DPL26	DPL26_01	Oct. 17, 2017	Oct. 16, 2019
*Diplexer EMCI	DPL26	DPL26_02	Oct. 17, 2017	Oct. 16, 2019
*Precision 30dB Attenuator Keysight	11708A	MY55260015	Oct. 17, 2017	Oct. 16, 2019
*Zero-Bias Detector (50~75GHz) Vdi	WR15ZBD	WR15R5 1-30	Oct. 17, 2017	Oct. 16, 2019
Digital Storage Oscilloscope Keysight	DSOX6002A+ DSOX6000- AMG	MY56270092	Jan. 17, 2019	Jan. 16, 2020
*WR15CH Conical Horn Keysight	WR15CH	WR15CH-01	Oct. 17, 2017	Oct. 16, 2019
*WR10CH Conical Horn Keysight	WR10CH	WR10CH-01	Oct. 17, 2017	Oct. 16, 2019
*Millimeter-Wave Signal Generator Frequency Extension Module (50~75 GHz) Keysight	E8257DV15	US54250106	Oct. 17, 2017	Oct. 16, 2019

*Millimeter-Wave Signal Generator Frequency Extension Module (75~110 GHz) Keysight	E8257DV10	US53250009	Oct. 17, 2017	Oct. 16, 2019
PSG analog signal generator Keysight	E8257D	MY53401987	June 26, 2018	June 25, 2019
Antenna Tower & Turn Table CT	NA	NA	NA	NA

Note:

1. The calibration interval of the above test instruments is 12 months and the calibrations are traceable to NML/ROC and NIST/USA.
2. *The calibration interval of the above test instruments is 24 months and the calibrations are traceable to NML/ROC and NIST/USA.
3. The test was performed in 966 Chamber No. 3.
4. Tested Date: Apr. 17, 2019

4.1.3 Test Procedures

For Radiated emission below 30MHz

- a. The EUT was placed on the top of a rotating table 0.8 meters above the ground at a 3 meter chamber room. The table was rotated 360 degrees to determine the position of the highest radiation.
- b. The EUT was set 3 meters away from the interference-receiving antenna, which was mounted on the top of a variable-height antenna tower.
- c. Parallel, perpendicular, and ground-parallel orientations of the antenna are set to make the measurement.
- d. For each suspected emission, the EUT was arranged to its worst case and the rotatable table was turned from 0 degrees to 360 degrees to find the maximum reading.
- e. The test-receiver system was set to Quasi-Peak Detect Function and Specified Bandwidth with Maximum Hold Mode.

NOTE:

1. The resolution bandwidth and video bandwidth of test receiver/spectrum analyzer is 9kHz at frequency below 30MHz.

For Radiated emission 30MHz to 40GHz

- a. The EUT was placed on the top of a rotating table 0.8 meters (for 30MHz ~ 1GHz) / 1.5 meters (for above 1GHz) above the ground at 3 meter chamber room for test. The table was rotated 360 degrees to determine the position of the highest radiation.
- b. The EUT was set 3 meters (30MHz-18GHz) / 1 meters (18GHz-40GHz) away from the interference-receiving antenna, which was mounted on the top of a variable-height antenna tower.
- c. The height of antenna is varied from one meter to four meters above the ground to determine the maximum value of the field strength. Both horizontal and vertical polarizations of the antenna are set to make the measurement.
- d. For each suspected emission, the EUT was arranged to its worst case and then the antenna was tuned to heights from 1 meter to 4 meters and the rotatable table was turned from 0 degrees to 360 degrees to find the maximum reading.
- e. The test-receiver system was set to quasi-peak detect function and specified bandwidth with maximum hold mode when the test frequency is below 1 GHz.
- f. The test-receiver system was set to peak and average detects function and specified bandwidth with maximum hold mode when the test frequency is above 1 GHz. If the peak reading value also meets average limit, measurement with the average detector is unnecessary.

Note:

1. The resolution bandwidth and video bandwidth of test receiver/spectrum analyzer is 120kHz for Quasi-peak detection (QP) at frequency below 1GHz.
2. The resolution bandwidth of test receiver/spectrum analyzer is 1 MHz and the video bandwidth is 3 MHz for Peak detection (PK) and Average detection (AV) at frequency above 1GHz.
3. All modes of operation were investigated and the worst-case emissions are reported.

For Radiated emission above 40GHz

- a. Connect the test antenna covering the appropriate frequency range to a spectrum analyzer via an external mixer to the spectrum analyzer.
- b. Set spectrum analyzer RBW = 1 MHz, VBW = 3 MHz, average detector.
- c. Calculate the distance to the far field boundary and determine the maximum measurement distance.
- d. Perform an exploratory search for emissions and determine the approximate direction at which each observed emission emanates from the EUT.
- e. Exploratory measurements be made at a closer distance than the validated maximum measurement distance.
- f. Perform a final measurement; begin with the test antenna at the approximate position where the maximum level occurred during the exploratory scan.
- g. Slowly scan the test antenna around this position, slowly vary the test antenna polarization by rotating through at least 0° to 180°, and slowly vary the orientation of the test antenna to find the final position, polarization, and orientation at which the maximum level of the emission is observed.
- h. Record the measured reading with the test antenna fixed at this maximized position, polarization, and orientation. Record the measurement distance.
- i. Calculate the maximum field strength of the emission at the measurement distance and the adjusted/corrected power at the output of the test antenna.
- j. Calculate the EIRP from the measured field strength and then convert to the linear.
- k. Calculate the power density at the distance specified by the limit from the field strength at the distance specified by the limit.
- l. Repeat the preceding sequence for every emission observed in the frequency band under investigation.

4.1.4 Deviation from Test Standard

No deviation.

4.1.5 Test Setup

For Radiated emission below 30MHz

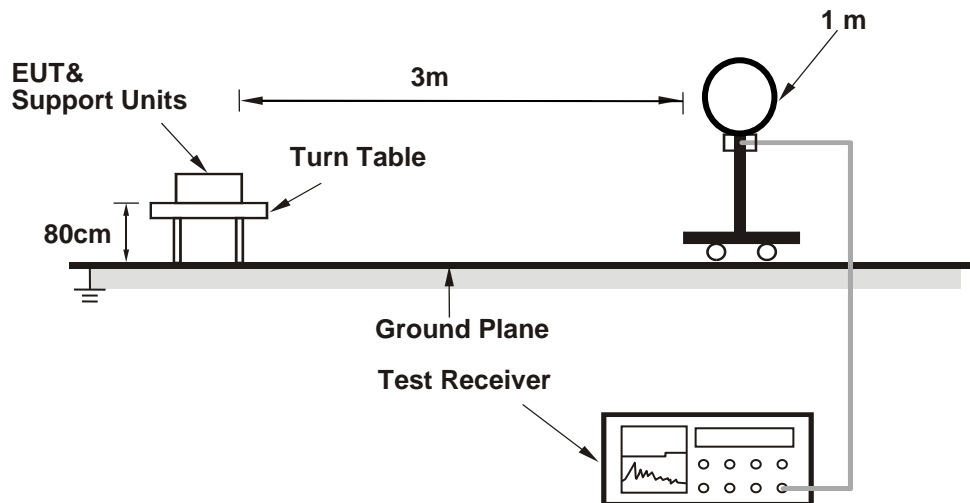

For Radiated emission 30MHz to 1GHz

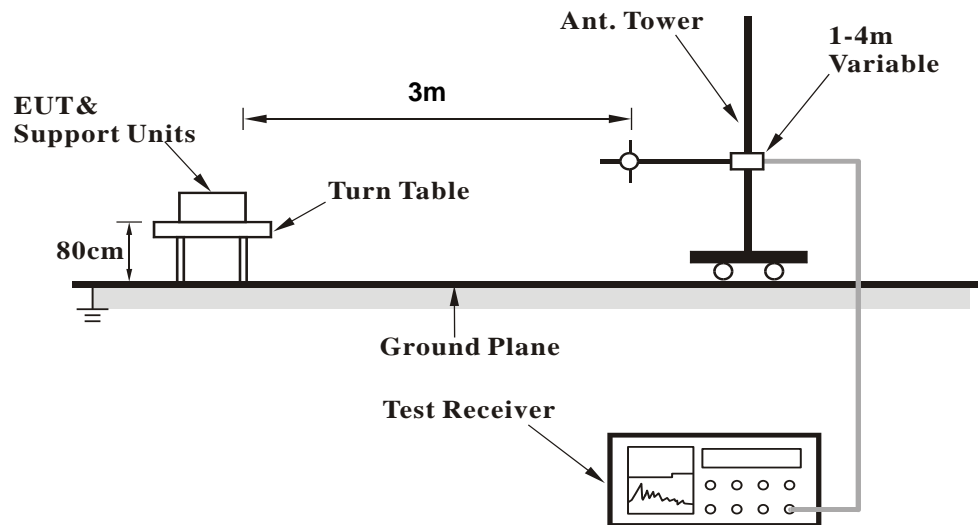

For Radiated emission 1GHz to 40GHz

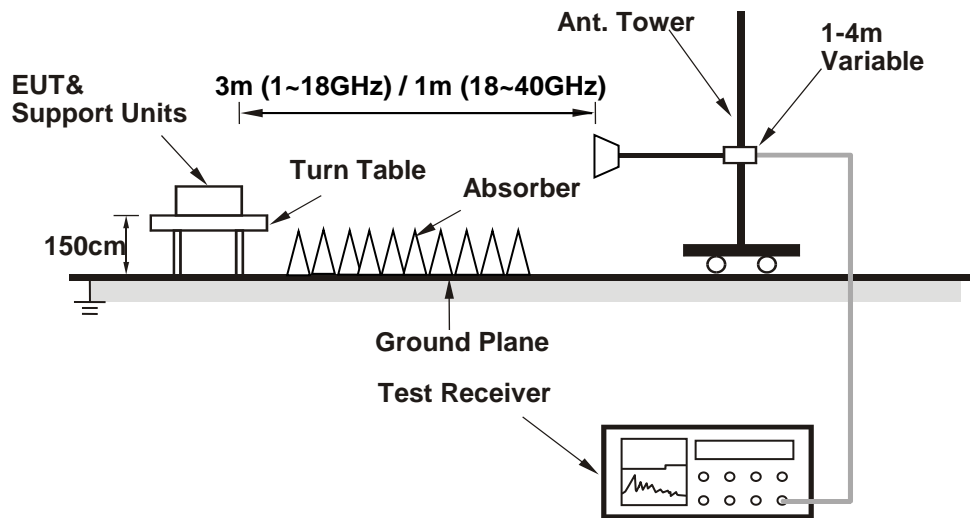

For Radiated emission above 40 GHz

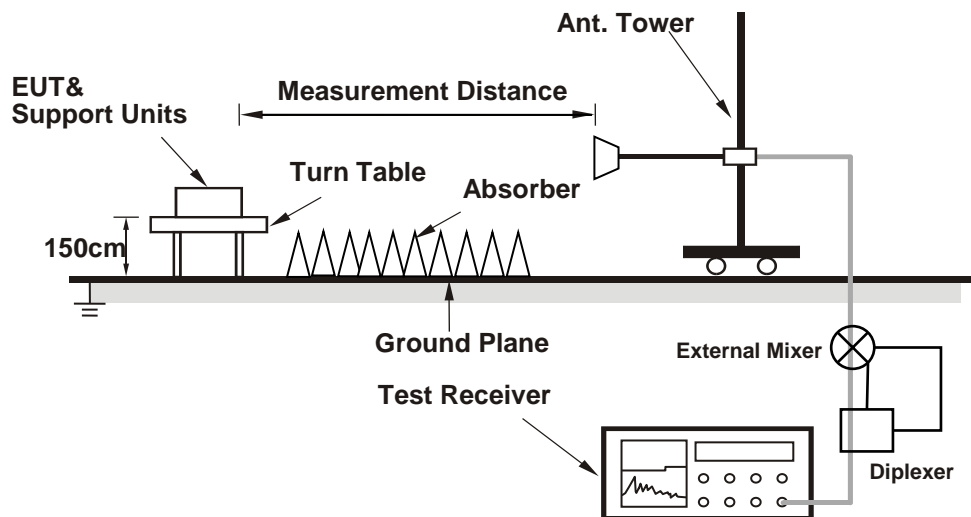

For the actual test configuration, please refer to the attached file (Test Setup Photo).

4.1.6 EUT Operating Conditions

- a. Connected the EUT with the Laptop which is placed on remote site.
- b. Controlling software has been activated to set the EUT under transmission condition continuously on specific status.

4.1.7 Test Results (LRP mode)

Channel Plan A

Above 1GHz Data:

CHANNEL	TX Channel 1	DETECTOR FUNCTION	Peak (PK)
FREQUENCY RANGE	1GHz ~ 18GHz		Average (AV)

ANTENNA POLARITY & TEST DISTANCE: HORIZONTAL AT 3 M

NO.	FREQ. (MHz)	EMISSION LEVEL (dBuV/m)	LIMIT (dBuV/m)	MARGIN (dB)	ANTENNA HEIGHT (m)	TABLE ANGLE (Degree)	RAW VALUE (dBuV)	CORRECTION FACTOR (dB/m)
1	#2167.42	44.8 PK	74.0	-29.2	1.00 H	172	46.7	-1.9
2	#2167.42	26.4 AV	54.0	-27.6	1.00 H	172	28.3	-1.9
3	#2426.21	45.5 PK	74.0	-28.5	1.00 H	360	47.6	-2.1
4	#2426.21	36.7 AV	54.0	-17.3	1.00 H	360	38.8	-2.1
5	#10151.89	50.2 PK	74.0	-23.8	1.00 H	282	38.4	11.8
6	#10151.89	47.0 AV	54.0	-7.0	1.00 H	282	35.2	11.8

ANTENNA POLARITY & TEST DISTANCE: VERTICAL AT 3 M

NO.	FREQ. (MHz)	EMISSION LEVEL (dBuV/m)	LIMIT (dBuV/m)	MARGIN (dB)	ANTENNA HEIGHT (m)	TABLE ANGLE (Degree)	RAW VALUE (dBuV)	CORRECTION FACTOR (dB/m)
1	2210.58	51.9 PK	74.0	-22.1	1.00 V	78	53.5	-1.6
2	2210.58	39.4 AV	54.0	-14.6	1.00 V	78	41.0	-1.6
3	4000.93	41.0 PK	74.0	-33.0	1.56 V	144	40.2	0.8
4	4000.93	30.9 AV	54.0	-23.1	1.56 V	144	30.1	0.8
5	7613.71	45.8 PK	74.0	-28.2	1.50 V	360	37.4	8.4
6	7613.71	37.6 AV	54.0	-16.4	1.50 V	360	29.2	8.4
7	12207.31	53.4 PK	74.0	-20.6	1.50 V	0	40.9	12.5
8	12207.31	34.8 AV	54.0	-19.2	1.50 V	0	22.3	12.5

REMARKS:

1. Emission Level(dBuV/m) = Raw Value(dBuV) + Correction Factor(dB/m)
2. Correction Factor(dB/m) = Antenna Factor(dB/m) + Cable Factor(dB) – Pre-Amplifier Factor(dB)
3. Margin value = Emission Level – Limit value
4. The other emission levels were very low against the limit.
5. " # ": The radiated frequency is out of the restricted band.

CHANNEL	TX Channel 1	DETECTOR FUNCTION	Peak (PK)
FREQUENCY RANGE	18GHz ~ 40GHz		Average (AV)

ANTENNA POLARITY: HORIZONTAL								
NO.	FREQ. (MHz)	EMISSION LEVEL (dBuV/m)	LIMIT (dBuV/m)	MARGIN (dB)	ANTENNA HEIGHT (m)	TABLE ANGLE (Degree)	RAW VALUE (dBuV)	CORRECTION FACTOR (dB/m)
1	#24193.61	45.2 PK	74.0	-28.8	1.08 H	303	62.9	-17.7
2	#24193.61	33.2 AV	54.0	-20.8	1.08 H	303	50.9	-17.7
3	#29602.13	45.4 PK	74.0	-28.6	1.29 H	193	62.3	-16.9
4	#29602.13	37.2 AV	54.0	-16.8	1.29 H	193	54.1	-16.9
5	#34491.29	45.2 PK	74.0	-28.8	1.53 H	304	62.9	-17.7
6	#34491.29	35.3 AV	54.0	-18.7	1.53 H	304	53.0	-17.7

ANTENNA POLARITY: VERTICAL								
NO.	FREQ. (MHz)	EMISSION LEVEL (dBuV/m)	LIMIT (dBuV/m)	MARGIN (dB)	ANTENNA HEIGHT (m)	TABLE ANGLE (Degree)	RAW VALUE (dBuV)	CORRECTION FACTOR (dB/m)
1	21112.96	45.5 PK	74.0	-28.5	1.19 V	245	64.1	-18.6
2	21112.96	34.8 AV	54.0	-19.2	1.19 V	245	53.4	-18.6
3	#27246.38	44.1 PK	74.0	-29.9	1.42 V	178	60.8	-16.7
4	#27246.38	36.2 AV	54.0	-17.8	1.42 V	178	52.9	-16.7
5	31281.69	46.1 PK	74.0	-27.9	1.56 V	283	62.9	-16.8
6	31281.69	35.6 AV	54.0	-18.4	1.56 V	283	52.4	-16.8

REMARKS:

1. Emission Level(dBuV/m) = Raw Value(dBuV) + Correction Factor(dB/m)
2. Correction Factor(dB/m) = Antenna Factor(dB/m) + Cable Factor(dB) – Pre-Amplifier Factor(dB)
3. The other emission levels were very low against the limit.
4. Margin value = Emission Level – Limit value
5. Shorter measurement distances was used to improve the measurement system's noise floor. As standard description is based on the measurement in distance of 3 meters, the data obtained at 1-meter distance was extrapolate results to the 3-m distance:
 Test value at 3-meter distance (dBuV)
 = Test value at 1 meter distance (dBuV) -20log(3/1)(dB)
 = Test value at 1 meter distance (dBuV) -9.54(dB).

*Measurements made at 1 meter distance. Test value converted to account for 3-meter measurement distance.

CHANNEL	TX Channel 1	DETECTOR FUNCTION	Average (AV)
FREQUENCY RANGE	40GHz ~ 200GHz		

ANTENNA POLARITY & TEST DISTANCE: HORIZONTAL AT 3 M						
NO.	Frequency (GHz)	EIRP Level (dBm)	Raw Value (dBm)	Receiver Antenna Gain (dBi)	Power Density (pW/cm ²)	Power Density Limit (pW/cm ²)
1	120.32	-22.9	-67.6	23.3	4.535 AV	90
2	200	-26.4	-75.5	23.3	2.026 AV	90
ANTENNA POLARITY & TEST DISTANCE: VERTICAL AT 3 M						
NO.	Frequency (GHz)	EIRP Level (dBm)	Raw Value (dBm)	Receiver Antenna Gain (dBi)	Power Density (pW/cm ²)	Power Density Limit (pW/cm ²)
1	120.32	-22.1	-66.8	23.3	5.452 AV	90
2	200	-23.3	-72.4	23.3	4.136 AV	90

Note

1. The measured power level is converted to EIRP using the equation:

$$\text{EIRP} = \text{Raw Value} - \text{Receiver Antenna Gain} + 20 \cdot \log(4 \cdot 3.1416 \cdot D / \lambda)$$

where:

D is the measurement distance

λ is the wavelength

*Measurements made at 0.5 meter distance.

2. The far-field boundary is given in ANSI 63.10 as:

$$R \text{ far field} = (2 \cdot L^2) / \lambda$$

L is the Largest Antenna Dimension, including the reflector

λ is the wavelength

FREQUENCY (GHz)	L (m)	Lambda (m)	R (Far Field) (m)
60.16	0.02	0.00499	0.16

CHANNEL	TX Channel 2	DETECTOR FUNCTION	Peak (PK)
FREQUENCY RANGE	1GHz ~ 18GHz		Average (AV)

ANTENNA POLARITY & TEST DISTANCE: HORIZONTAL AT 3 M

NO.	FREQ. (MHz)	EMISSION LEVEL (dBuV/m)	LIMIT (dBuV/m)	MARGIN (dB)	ANTENNA HEIGHT (m)	TABLE ANGLE (Degree)	RAW VALUE (dBuV)	CORRECTION FACTOR (dB/m)
1	#2167.40	45.2 PK	74.0	-28.8	1.10 H	295	47.1	-1.9
2	#2167.40	26.7 AV	54.0	-27.3	1.10 H	295	28.6	-1.9
3	#2426.23	45.8 PK	74.0	-28.2	1.14 H	287	47.9	-2.1
4	#2426.23	36.4 AV	54.0	-17.6	1.14 H	287	38.5	-2.1
5	#8883.75	48.6 PK	74.0	-25.4	1.00 H	195	38.6	10.0
6	#8883.75	46.8 AV	54.0	-7.2	1.00 H	195	36.8	10.0

ANTENNA POLARITY & TEST DISTANCE: VERTICAL AT 3 M

NO.	FREQ. (MHz)	EMISSION LEVEL (dBuV/m)	LIMIT (dBuV/m)	MARGIN (dB)	ANTENNA HEIGHT (m)	TABLE ANGLE (Degree)	RAW VALUE (dBuV)	CORRECTION FACTOR (dB/m)
1	2210.61	52.3 PK	74.0	-21.7	1.13 V	193	53.9	-1.6
2	2210.61	39.7 AV	54.0	-14.3	1.13 V	193	41.3	-1.6
3	4000.92	40.6 PK	74.0	-33.4	1.64 V	231	39.8	0.8
4	4000.92	31.3 AV	54.0	-22.7	1.64 V	231	30.5	0.8
5	7613.70	46.2 PK	74.0	-27.8	1.49 V	294	37.8	8.4
6	7613.70	37.3 AV	54.0	-16.7	1.49 V	294	28.9	8.4
7	12207.30	53.1 PK	74.0	-20.9	1.48 V	116	40.6	12.5
8	12207.30	35.0 AV	54.0	-19.0	1.48 V	116	22.5	12.5

REMARKS:

1. Emission Level(dBuV/m) = Raw Value(dBuV) + Correction Factor(dB/m)
2. Correction Factor(dB/m) = Antenna Factor(dB/m) + Cable Factor(dB) – Pre-Amplifier Factor(dB)
3. Margin value = Emission Level – Limit value
4. The other emission levels were very low against the limit.
5. " # ": The radiated frequency is out of the restricted band.

CHANNEL	TX Channel 2	DETECTOR FUNCTION	Peak (PK)
FREQUENCY RANGE	18GHz ~ 40GHz		Average (AV)

ANTENNA POLARITY: HORIZONTAL								
NO.	FREQ. (MHz)	EMISSION LEVEL (dBuV/m)	LIMIT (dBuV/m)	MARGIN (dB)	ANTENNA HEIGHT (m)	TABLE ANGLE (Degree)	RAW VALUE (dBuV)	CORRECTION FACTOR (dB/m)
1	#24194.43	46.1 PK	74.0	-27.9	1.16 H	243	63.8	-17.7
2	#24194.43	35.5 AV	54.0	-18.5	1.16 H	243	53.2	-17.7
3	#29602.57	45.3 PK	74.0	-28.7	1.41 H	295	62.2	-16.9
4	#29602.57	37.2 AV	54.0	-16.8	1.41 H	295	54.1	-16.9
5	#34491.32	46.3 PK	74.0	-27.7	1.43 H	225	64.0	-17.7
6	#34491.32	36.1 AV	54.0	-17.9	1.43 H	225	53.8	-17.7

ANTENNA POLARITY: VERTICAL								
NO.	FREQ. (MHz)	EMISSION LEVEL (dBuV/m)	LIMIT (dBuV/m)	MARGIN (dB)	ANTENNA HEIGHT (m)	TABLE ANGLE (Degree)	RAW VALUE (dBuV)	CORRECTION FACTOR (dB/m)
1	21113.36	45.2 PK	74.0	-28.8	1.66 V	189	63.8	-18.6
2	21113.36	34.1 AV	54.0	-19.9	1.66 V	189	52.7	-18.6
3	#27247.05	44.3 PK	74.0	-29.7	2.20 V	159	61.0	-16.7
4	#27247.05	37.3 AV	54.0	-16.7	2.20 V	159	54.0	-16.7
5	31283.63	46.6 PK	74.0	-27.4	1.00 V	147	63.4	-16.8
6	31283.63	35.7 AV	54.0	-18.3	1.00 V	147	52.5	-16.8

REMARKS:

1. Emission Level(dBuV/m) = Raw Value(dBuV) + Correction Factor(dB/m)
2. Correction Factor(dB/m) = Antenna Factor(dB/m) + Cable Factor(dB) – Pre-Amplifier Factor(dB)
3. The other emission levels were very low against the limit.
4. Margin value = Emission Level – Limit value
5. Shorter measurement distances was used to improve the measurement system's noise floor. As standard description is based on the measurement in distance of 3 meters, the data obtained at 1-meter distance was extrapolate results to the 3-m distance:
 Test value at 3-meter distance (dBuV)
 = Test value at 1 meter distance (dBuV) -20log(3/1)(dB)
 = Test value at 1 meter distance (dBuV) -9.54(dB).

*Measurements made at 1 meter distance. Test value converted to account for 3-meter measurement distance.

CHANNEL	TX Channel 2	DETECTOR FUNCTION	Average (AV)
FREQUENCY RANGE	40GHz ~ 200GHz		

ANTENNA POLARITY & TEST DISTANCE: HORIZONTAL AT 3 M						
NO.	Frequency (GHz)	EIRP Level (dBm)	Raw Value (dBm)	Receiver Antenna Gain (dBi)	Power Density (pW/cm ²)	Power Density Limit (pW/cm ²)
1	120.96	-23.0	-67.8	23.3	4.432 AV	90
2	200	-26.3	-75.4	23.3	2.073 AV	90

ANTENNA POLARITY & TEST DISTANCE: VERTICAL AT 3 M						
NO.	Frequency (GHz)	EIRP Level (dBm)	Raw Value (dBm)	Receiver Antenna Gain (dBi)	Power Density (pW/cm ²)	Power Density Limit (pW/cm ²)
1	120.96	-22.2	-67.0	23.3	5.328 AV	90
2	200	-23.1	-72.2	23.3	4.331 AV	90

Note

1. The measured power level is converted to EIRP using the equation:

$$\text{EIRP} = \text{Raw Value} - \text{Receiver Antenna Gain} + 20 \cdot \log(4 \cdot 3.1416 \cdot D / \lambda)$$

where:

D is the measurement distance

λ is the wavelength

*Measurements made at 0.5 meter distance.

2. The far-field boundary is given in ANSI 63.10 as:

$$R \text{ far field} = (2 \cdot L^2) / \lambda$$

L is the Largest Antenna Dimension, including the reflector

λ is the wavelength

FREQUENCY (GHz)	L (m)	Lambda (m)	R (Far Field) (m)
60.48	0.02	0.00496	0.161

CHANNEL	TX Channel 3	DETECTOR FUNCTION	Peak (PK)
FREQUENCY RANGE	1GHz ~ 18GHz		Average (AV)

ANTENNA POLARITY & TEST DISTANCE: HORIZONTAL AT 3 M

NO.	FREQ. (MHz)	EMISSION LEVEL (dBuV/m)	LIMIT (dBuV/m)	MARGIN (dB)	ANTENNA HEIGHT (m)	TABLE ANGLE (Degree)	RAW VALUE (dBuV)	CORRECTION FACTOR (dB/m)
1	#2167.41	44.5 PK	74.0	-29.5	1.13 H	242	46.4	-1.9
2	#2167.41	26.7 AV	54.0	-27.3	1.13 H	242	28.6	-1.9
3	#2426.19	45.3 PK	74.0	-28.7	1.62 H	293	47.4	-2.1
4	#2426.19	36.2 AV	54.0	-17.8	1.62 H	293	38.3	-2.1
5	#10151.91	49.8 PK	74.0	-24.2	1.18 H	305	38.0	11.8
6	#10151.91	47.3 AV	54.0	-6.7	1.18 H	305	35.5	11.8

ANTENNA POLARITY & TEST DISTANCE: VERTICAL AT 3 M

NO.	FREQ. (MHz)	EMISSION LEVEL (dBuV/m)	LIMIT (dBuV/m)	MARGIN (dB)	ANTENNA HEIGHT (m)	TABLE ANGLE (Degree)	RAW VALUE (dBuV)	CORRECTION FACTOR (dB/m)
1	2210.61	52.1 PK	74.0	-21.9	1.52 V	265	53.7	-1.6
2	2210.61	39.5 AV	54.0	-14.5	1.52 V	265	41.1	-1.6
3	4000.90	40.4 PK	74.0	-33.6	1.53 V	242	39.6	0.8
4	4000.90	31.6 AV	54.0	-22.4	1.53 V	242	30.8	0.8
5	7613.72	46.1 PK	74.0	-27.9	1.56 V	257	37.7	8.4
6	7613.72	37.6 AV	54.0	-16.4	1.56 V	257	29.2	8.4
7	12207.30	52.8 PK	74.0	-21.2	1.43 V	269	40.3	12.5
8	12207.30	34.8 AV	54.0	-19.2	1.43 V	269	22.3	12.5

REMARKS:

1. Emission Level(dBuV/m) = Raw Value(dBuV) + Correction Factor(dB/m)
2. Correction Factor(dB/m) = Antenna Factor(dB/m) + Cable Factor(dB) – Pre-Amplifier Factor(dB)
3. Margin value = Emission Level – Limit value
4. The other emission levels were very low against the limit.
5. " # ": The radiated frequency is out of the restricted band.

CHANNEL	TX Channel 3	DETECTOR FUNCTION	Peak (PK)
FREQUENCY RANGE	18GHz ~ 40GHz		Average (AV)

ANTENNA POLARITY: HORIZONTAL								
NO.	FREQ. (MHz)	EMISSION LEVEL (dBuV/m)	LIMIT (dBuV/m)	MARGIN (dB)	ANTENNA HEIGHT (m)	TABLE ANGLE (Degree)	RAW VALUE (dBuV)	CORRECTION FACTOR (dB/m)
1	#24193.86	46.3 PK	74.0	-27.7	1.52 H	221	64.0	-17.7
2	#24193.86	36.4 AV	54.0	-17.6	1.52 H	221	54.1	-17.7
3	#29602.73	45.2 PK	74.0	-28.8	1.18 H	305	62.1	-16.9
4	#29602.73	37.3 AV	54.0	-16.7	1.18 H	305	54.2	-16.9
5	#34491.65	45.2 PK	74.0	-28.8	1.43 H	178	62.9	-17.7
6	#34491.65	36.2 AV	54.0	-17.8	1.43 H	187	53.9	-17.7
ANTENNA POLARITY: VERTICAL								
NO.	FREQ. (MHz)	EMISSION LEVEL (dBuV/m)	LIMIT (dBuV/m)	MARGIN (dB)	ANTENNA HEIGHT (m)	TABLE ANGLE (Degree)	RAW VALUE (dBuV)	CORRECTION FACTOR (dB/m)
1	21113.42	45.4 PK	74.0	-28.6	1.71 V	208	64.0	-18.6
2	21113.42	34.6 AV	54.0	-19.4	1.71 V	208	53.2	-18.6
3	#27247.10	44.8 PK	74.0	-29.2	1.98 V	245	61.5	-16.7
4	#27247.10	37.2 AV	54.0	-16.8	1.98 V	245	53.9	-16.7
5	31283.60	46.8 PK	74.0	-27.2	1.18 V	245	63.6	-16.8
6	31283.60	35.8 AV	54.0	-18.2	1.18 V	245	52.6	-16.8

REMARKS:

1. Emission Level(dBuV/m) = Raw Value(dBuV) + Correction Factor(dB/m)
2. Correction Factor(dB/m) = Antenna Factor(dB/m) + Cable Factor(dB) – Pre-Amplifier Factor(dB)
3. The other emission levels were very low against the limit.
4. Margin value = Emission Level – Limit value
5. Shorter measurement distances was used to improve the measurement system's noise floor. As standard description is based on the measurement in distance of 3 meters, the data obtained at 1-meter distance was extrapolate results to the 3-m distance:
 Test value at 3-meter distance (dBuV)
 = Test value at 1 meter distance (dBuV) -20log(3/1)(dB)
 = Test value at 1 meter distance (dBuV) -9.54(dB).

*Measurements made at 1 meter distance. Test value converted to account for 3-meter measurement distance.

CHANNEL	TX Channel 3	DETECTOR FUNCTION	Average (AV)
FREQUENCY RANGE	40GHz ~ 200GHz		

ANTENNA POLARITY & TEST DISTANCE: HORIZONTAL AT 3 M						
NO.	Frequency (GHz)	EIRP Level (dBm)	Raw Value (dBm)	Receiver Antenna Gain (dBi)	Power Density (pW/cm ²)	Power Density Limit (pW/cm ²)
1	121.6	-22.4	-67.2	23.3	5.088 AV	90
2	200	-22.5	-71.6	23.3	4.972 AV	90

ANTENNA POLARITY & TEST DISTANCE: VERTICAL AT 3 M						
NO.	Frequency (GHz)	EIRP Level (dBm)	Raw Value (dBm)	Receiver Antenna Gain (dBi)	Power Density (pW/cm ²)	Power Density Limit (pW/cm ²)
1	121.6	-22.2	-67.0	23.3	5.328 AV	90
2	200	-23.0	-72.1	23.3	4.432 AV	90

Note

1. The measured power level is converted to EIRP using the equation:

$$\text{EIRP} = \text{Raw Value} - \text{Receiver Antenna Gain} + 20 \cdot \log(4 \cdot 3.1416 \cdot D / \lambda)$$

where:

D is the measurement distance

λ is the wavelength

*Measurements made at 0.5 meter distance.

2. The far-field boundary is given in ANSI 63.10 as:

$$R \text{ far field} = (2 \cdot L^2) / \lambda$$

L is the Largest Antenna Dimension, including the reflector

λ is the wavelength

FREQUENCY (GHz)	L (m)	Lambda (m)	R (Far Field) (m)
60.8	0.02	0.00493	0.162

Below 1GHz Data:

CHANNEL	TX Channel 1	DETECTOR FUNCTION	Quasi-Peak (QP)
FREQUENCY RANGE	9kHz ~ 1GHz		

ANTENNA POLARITY & TEST DISTANCE: HORIZONTAL AT 3 M

NO.	FREQ. (MHz)	EMISSION LEVEL (dBuV/m)	LIMIT (dBuV/m)	MARGIN (dB)	ANTENNA HEIGHT (m)	TABLE ANGLE (Degree)	RAW VALUE (dBuV)	CORRECTION FACTOR (dB/m)
1	30.05	31.1 QP	40.0	-8.9	1.00 H	106	40.5	-9.4
2	56.48	30.8 QP	40.0	-9.2	1.50 H	45	39.5	-8.7
3	259.77	29.7 QP	46.0	-16.3	1.00 H	360	37.8	-8.1
4	389.63	33.7 QP	46.0	-12.3	1.00 H	297	38.1	-4.4
5	519.49	32.4 QP	46.0	-13.6	1.50 H	104	33.7	-1.3
6	844.17	41.2 QP	46.0	-4.8	2.00 H	30	36.6	4.6

REMARKS:

1. Emission Level(dBuV/m) = Raw Value(dBuV) + Correction Factor(dB/m)
2. Correction Factor(dB/m) = Antenna Factor(dB/m) + Cable Factor(dB) – Pre-Amplifier Factor(dB)
3. Margin value = Emission Level – Limit value
4. The other emission levels were very low against the limit of frequency range 30MHz~1000MHz.
5. The emission levels were very low against the limit of frequency range 9kHz~30MHz: the amplitude of spurious emissions attenuated more than 20 dB below the permissible value to be report.

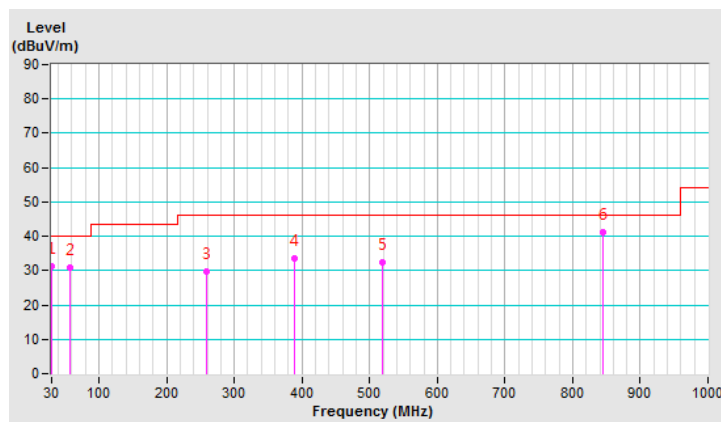

CHANNEL	TX Channel 1	DETECTOR FUNCTION	Quasi-Peak (QP)
FREQUENCY RANGE	9kHz ~ 1GHz		

ANTENNA POLARITY & TEST DISTANCE: VERTICAL AT 3 M

NO.	FREQ. (MHz)	EMISSION LEVEL (dBuV/m)	LIMIT (dBuV/m)	MARGIN (dB)	ANTENNA HEIGHT (m)	TABLE ANGLE (Degree)	RAW VALUE (dBuV)	CORRECTION FACTOR (dB/m)
1	54.90	34.1 QP	40.0	-5.9	1.00 V	173	42.7	-8.6
2	149.65	33.2 QP	43.5	-10.3	1.00 V	178	40.9	-7.7
3	389.60	30.0 QP	46.0	-16.0	3.00 V	360	34.4	-4.4
4	593.30	31.9 QP	46.0	-14.1	1.50 V	83	31.6	0.3
5	710.43	33.0 QP	46.0	-13.0	1.00 V	348	31.1	1.9
6	896.28	39.0 QP	46.0	-7.0	3.00 V	112	33.8	5.2

REMARKS:

1. Emission Level(dBuV/m) = Raw Value(dBuV) + Correction Factor(dB/m)
2. Correction Factor(dB/m) = Antenna Factor(dB/m) + Cable Factor(dB) – Pre-Amplifier Factor(dB)
3. Margin value = Emission Level – Limit value
4. The other emission levels were very low against the limit of frequency range 30MHz~1000MHz.
5. The emission levels were very low against the limit of frequency range 9kHz~30MHz: the amplitude of spurious emissions attenuated more than 20 dB below the permissible value to be report.

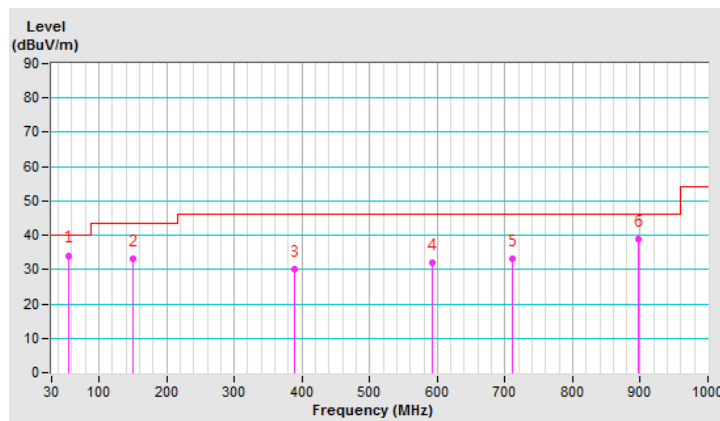

CHANNEL	TX Channel 2	DETECTOR FUNCTION	Quasi-Peak (QP)
FREQUENCY RANGE	9kHz ~ 1GHz		

ANTENNA POLARITY & TEST DISTANCE: HORIZONTAL AT 3 M

NO.	FREQ. (MHz)	EMISSION LEVEL (dBuV/m)	LIMIT (dBuV/m)	MARGIN (dB)	ANTENNA HEIGHT (m)	TABLE ANGLE (Degree)	RAW VALUE (dBuV)	CORRECTION FACTOR (dB/m)
1	30.05	31.6 QP	40.0	-8.4	1.10 H	245	41.0	-9.4
2	56.48	31.3 QP	40.0	-8.7	1.56 H	241	40.0	-8.7
3	259.77	30.3 QP	46.0	-15.7	1.59 H	287	38.4	-8.1
4	389.63	33.8 QP	46.0	-12.2	1.00 H	265	38.2	-4.4
5	519.49	32.7 QP	46.0	-13.3	1.50 H	231	34.0	-1.3
6	844.17	41.1 QP	46.0	-4.9	1.59 H	231	36.5	4.6

REMARKS:

1. Emission Level(dBuV/m) = Raw Value(dBuV) + Correction Factor(dB/m)
2. Correction Factor(dB/m) = Antenna Factor(dB/m) + Cable Factor(dB) – Pre-Amplifier Factor(dB)
3. Margin value = Emission Level – Limit value
4. The other emission levels were very low against the limit of frequency range 30MHz~1000MHz.
5. The emission levels were very low against the limit of frequency range 9kHz~30MHz: the amplitude of spurious emissions attenuated more than 20 dB below the permissible value to be report.

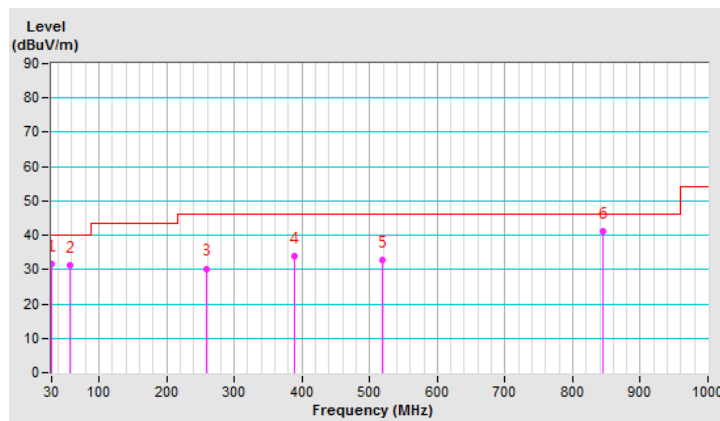

CHANNEL	TX Channel 2	DETECTOR FUNCTION	Quasi-Peak (QP)
FREQUENCY RANGE	9kHz ~ 1GHz		

ANTENNA POLARITY & TEST DISTANCE: VERTICAL AT 3 M

NO.	FREQ. (MHz)	EMISSION LEVEL (dBuV/m)	LIMIT (dBuV/m)	MARGIN (dB)	ANTENNA HEIGHT (m)	TABLE ANGLE (Degree)	RAW VALUE (dBuV)	CORRECTION FACTOR (dB/m)
1	54.91	34.2 QP	40.0	-5.8	1.23 V	269	42.8	-8.6
2	149.65	33.6 QP	43.5	-9.9	1.13 V	297	41.3	-7.7
3	389.60	30.3 QP	46.0	-15.7	2.59 V	301	34.7	-4.4
4	593.30	32.4 QP	46.0	-13.6	1.65 V	245	32.1	0.3
5	710.43	33.4 QP	46.0	-12.6	1.24 V	284	31.5	1.9
6	896.28	39.2 QP	46.0	-6.8	2.56 V	138	34.0	5.2

REMARKS:

1. Emission Level(dBuV/m) = Raw Value(dBuV) + Correction Factor(dB/m)
2. Correction Factor(dB/m) = Antenna Factor(dB/m) + Cable Factor(dB) – Pre-Amplifier Factor(dB)
3. Margin value = Emission Level – Limit value
4. The other emission levels were very low against the limit of frequency range 30MHz~1000MHz.
5. The emission levels were very low against the limit of frequency range 9kHz~30MHz: the amplitude of spurious emissions attenuated more than 20 dB below the permissible value to be report.

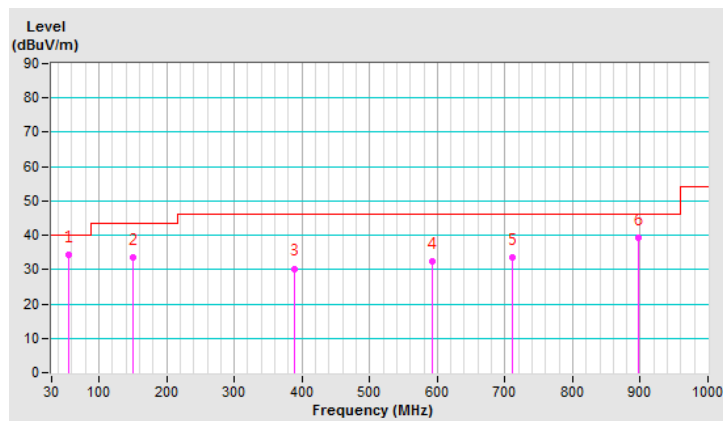

CHANNEL	TX Channel 3	DETECTOR FUNCTION	Quasi-Peak (QP)
FREQUENCY RANGE	9kHz ~ 1GHz		

ANTENNA POLARITY & TEST DISTANCE: HORIZONTAL AT 3 M

NO.	FREQ. (MHz)	EMISSION LEVEL (dBuV/m)	LIMIT (dBuV/m)	MARGIN (dB)	ANTENNA HEIGHT (m)	TABLE ANGLE (Degree)	RAW VALUE (dBuV)	CORRECTION FACTOR (dB/m)
1	30.05	31.6 QP	40.0	-8.4	1.13 H	305	41.0	-9.4
2	56.46	30.4 QP	40.0	-9.6	1.65 H	295	39.1	-8.7
3	259.77	30.4 QP	46.0	-15.6	1.10 H	295	38.5	-8.1
4	389.62	34.3 QP	46.0	-11.7	1.65 H	238	38.7	-4.4
5	519.49	32.6 QP	46.0	-13.4	1.63 H	178	33.9	-1.3
6	844.15	41.5 QP	46.0	-4.5	1.98 H	302	36.9	4.6

REMARKS:

1. Emission Level(dBuV/m) = Raw Value(dBuV) + Correction Factor(dB/m)
2. Correction Factor(dB/m) = Antenna Factor(dB/m) + Cable Factor(dB) – Pre-Amplifier Factor(dB)
3. Margin value = Emission Level – Limit value
4. The other emission levels were very low against the limit of frequency range 30MHz~1000MHz.
5. The emission levels were very low against the limit of frequency range 9kHz~30MHz: the amplitude of spurious emissions attenuated more than 20 dB below the permissible value to be report.

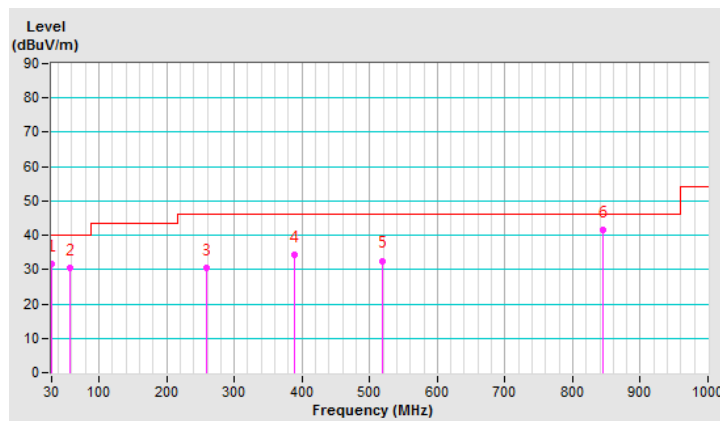

CHANNEL	TX Channel 3	DETECTOR FUNCTION	Quasi-Peak (QP)
FREQUENCY RANGE	9kHz ~ 1GHz		

ANTENNA POLARITY & TEST DISTANCE: VERTICAL AT 3 M

NO.	FREQ. (MHz)	EMISSION LEVEL (dBuV/m)	LIMIT (dBuV/m)	MARGIN (dB)	ANTENNA HEIGHT (m)	TABLE ANGLE (Degree)	RAW VALUE (dBuV)	CORRECTION FACTOR (dB/m)
1	54.91	34.4 QP	40.0	-5.6	1.55 V	143	43.0	-8.6
2	149.65	33.8 QP	43.5	-9.7	1.31 V	253	41.5	-7.7
3	389.60	30.7 QP	46.0	-15.3	2.31 V	174	35.1	-4.4
4	593.30	33.7 QP	46.0	-12.3	1.54 V	295	33.4	0.3
5	710.43	36.1 QP	46.0	-9.9	1.30 V	254	34.2	1.9
6	896.28	39.3 QP	46.0	-6.7	2.53 V	174	34.1	5.2

REMARKS:

1. Emission Level(dBuV/m) = Raw Value(dBuV) + Correction Factor(dB/m)
2. Correction Factor(dB/m) = Antenna Factor(dB/m) + Cable Factor(dB) – Pre-Amplifier Factor(dB)
3. Margin value = Emission Level – Limit value
4. The other emission levels were very low against the limit of frequency range 30MHz~1000MHz.
5. The emission levels were very low against the limit of frequency range 9kHz~30MHz: the amplitude of spurious emissions attenuated more than 20 dB below the permissible value to be report.

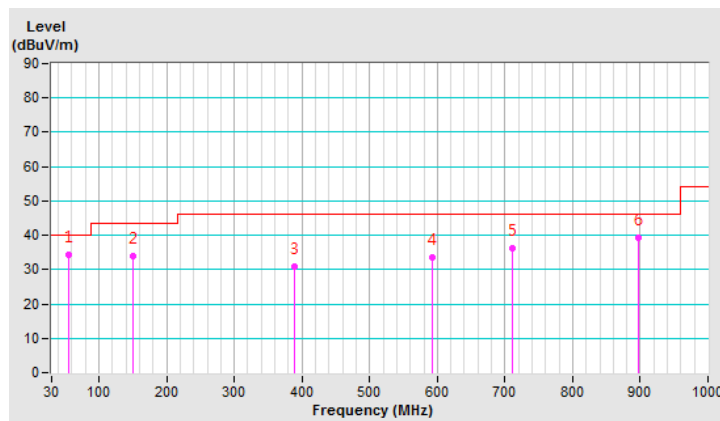

Channel Plan B

Above 1GHz Data:

CHANNEL	TX Channel 1	DETECTOR FUNCTION	Peak (PK)
FREQUENCY RANGE	1GHz ~ 18GHz		Average (AV)

ANTENNA POLARITY & TEST DISTANCE: HORIZONTAL AT 3 M

NO.	FREQ. (MHz)	EMISSION LEVEL (dBuV/m)	LIMIT (dBuV/m)	MARGIN (dB)	ANTENNA HEIGHT (m)	TABLE ANGLE (Degree)	RAW VALUE (dBuV)	CORRECTION FACTOR (dB/m)
1	#2426.22	45.5 PK	74.0	-28.5	1.57 H	314	47.6	-2.1
2	#2426.22	36.4 AV	54.0	-17.6	1.57 H	314	38.5	-2.1
3	#7173.98	45.2 PK	74.0	-28.8	2.02 H	156	36.9	8.3
4	#7173.98	32.4 AV	54.0	-21.6	2.02 H	156	24.1	8.3
5	#10151.93	49.6 PK	74.0	-24.4	1.41 H	264	37.8	11.8
6	#10151.93	47.1 AV	54.0	-6.9	1.41 H	264	35.3	11.8

ANTENNA POLARITY & TEST DISTANCE: VERTICAL AT 3 M

NO.	FREQ. (MHz)	EMISSION LEVEL (dBuV/m)	LIMIT (dBuV/m)	MARGIN (dB)	ANTENNA HEIGHT (m)	TABLE ANGLE (Degree)	RAW VALUE (dBuV)	CORRECTION FACTOR (dB/m)
1	2210.59	52.1 PK	74.0	-21.9	1.59 V	263	53.7	-1.6
2	2210.59	39.4 AV	54.0	-14.6	1.59 V	263	41.0	-1.6
3	4000.89	40.3 PK	74.0	-33.7	1.98 V	185	39.5	0.8
4	4000.89	31.6 AV	54.0	-22.4	1.98 V	185	30.8	0.8
5	7613.69	45.8 PK	74.0	-28.2	1.66 V	278	37.4	8.4
6	7613.69	37.7 AV	54.0	-16.3	1.66 V	278	29.3	8.4
7	12207.28	53.0 PK	74.0	-21.0	1.68 V	253	40.5	12.5
8	12207.28	35.0 AV	54.0	-19.0	1.68 V	253	22.5	12.5

REMARKS:

1. Emission Level(dBuV/m) = Raw Value(dBuV) + Correction Factor(dB/m)
2. Correction Factor(dB/m) = Antenna Factor(dB/m) + Cable Factor(dB) – Pre-Amplifier Factor(dB)
3. Margin value = Emission Level – Limit value
4. The other emission levels were very low against the limit.
5. "#": The radiated frequency is out of the restricted band.

CHANNEL	TX Channel 1	DETECTOR FUNCTION	Peak (PK)
FREQUENCY RANGE	18GHz ~ 40GHz		Average (AV)

ANTENNA POLARITY: HORIZONTAL								
NO.	FREQ. (MHz)	EMISSION LEVEL (dBuV/m)	LIMIT (dBuV/m)	MARGIN (dB)	ANTENNA HEIGHT (m)	TABLE ANGLE (Degree)	RAW VALUE (dBuV)	CORRECTION FACTOR (dB/m)
1	#24192.41	44.3 PK	74.0	-29.7	1.98 H	302	62.0	-17.7
2	#24192.41	34.5 AV	54.0	-19.5	1.98 H	302	52.2	-17.7
3	#29600.13	44.7 PK	74.0	-29.3	1.48 H	331	61.6	-16.9
4	#29600.13	37.6 AV	54.0	-16.4	1.48 H	331	54.5	-16.9
5	#34491.51	45.3 PK	74.0	-28.7	1.66 H	289	63.0	-17.7
6	#34491.51	36.5 AV	54.0	-17.5	1.66 H	289	54.2	-17.7

ANTENNA POLARITY : VERTICAL								
NO.	FREQ. (MHz)	EMISSION LEVEL (dBuV/m)	LIMIT (dBuV/m)	MARGIN (dB)	ANTENNA HEIGHT (m)	TABLE ANGLE (Degree)	RAW VALUE (dBuV)	CORRECTION FACTOR (dB/m)
1	21112.94	45.2 PK	74.0	-28.8	1.00 V	197	63.8	-18.6
2	21112.94	34.6 AV	54.0	-19.4	1.00 V	197	53.2	-18.6
3	#27246.35	44.4 PK	74.0	-29.6	1.50 V	52	61.1	-16.7
4	#27246.35	36.8 AV	54.0	-17.2	1.50 V	52	53.5	-16.7
5	31281.71	46.3 PK	74.0	-27.7	1.00 V	151	63.1	-16.8
6	31281.71	35.4 AV	54.0	-18.6	1.00 V	151	52.2	-16.8

REMARKS:

1. Emission Level(dBuV/m) = Raw Value(dBuV) + Correction Factor(dB/m)
2. Correction Factor(dB/m) = Antenna Factor(dB/m) + Cable Factor(dB) – Pre-Amplifier Factor(dB)
3. The other emission levels were very low against the limit.
4. Margin value = Emission Level – Limit value
5. Shorter measurement distances was used to improve the measurement system's noise floor. As standard description is based on the measurement in distance of 3 meters, the data obtained at 1-meter distance was extrapolate results to the 3-m distance:
 Test value at 3-meter distance (dBuV)
 = Test value at 1 meter distance (dBuV) -20log(3/1)(dB)
 = Test value at 1 meter distance (dBuV) -9.54(dB).

*Measurements made at 1 meter distance. Test value converted to account for 3-meter measurement distance.

CHANNEL	TX Channel 1	DETECTOR FUNCTION	Average (AV)
FREQUENCY RANGE	40GHz ~ 200GHz		

ANTENNA POLARITY & TEST DISTANCE: HORIZONTAL AT 3 M

NO.	Frequency (GHz)	EIRP Level (dBm)	Raw Value (dBm)	Receiver Antenna Gain (dBi)	Power Density (pW/cm ²)	Power Density Limit (pW/cm ²)
1	124.64	-22.8	-67.8	23.3	4.64 AV	90
2	200	-26.2	-75.3	23.3	2.121 AV	90

ANTENNA POLARITY & TEST DISTANCE: VERTICAL AT 3 M

NO.	Frequency (GHz)	EIRP Level (dBm)	Raw Value (dBm)	Receiver Antenna Gain (dBi)	Power Density (pW/cm ²)	Power Density Limit (pW/cm ²)
1	124.64	-22.0	-67.0	23.3	5.579 AV	90
2	200	-23.0	-72.1	23.3	4.432 AV	90

Note

1. The measured power level is converted to EIRP using the equation:

$$\text{EIRP} = \text{Raw Value} - \text{Receiver Antenna Gain} + 20 \cdot \log(4 \cdot 3.1416 \cdot D / \lambda)$$

where:

D is the measurement distance

λ is the wavelength

*Measurements made at 0.5 meter distance.

2. The far-field boundary is given in ANSI 63.10 as:

$$R \text{ far field} = (2 \cdot L^2) / \lambda$$

L is the Largest Antenna Dimension, including the reflector

λ is the wavelength

FREQUENCY (GHz)	L (m)	Lambda (m)	R (Far Field) (m)
62.32	0.02	0.00481	0.166

CHANNEL	TX Channel 2	DETECTOR FUNCTION	Peak (PK)
FREQUENCY RANGE	1GHz ~ 18GHz		Average (AV)

ANTENNA POLARITY & TEST DISTANCE: HORIZONTAL AT 3 M

NO.	FREQ. (MHz)	EMISSION LEVEL (dBuV/m)	LIMIT (dBuV/m)	MARGIN (dB)	ANTENNA HEIGHT (m)	TABLE ANGLE (Degree)	RAW VALUE (dBuV)	CORRECTION FACTOR (dB/m)
1	#2167.39	44.3 PK	74.0	-29.7	1.64 H	178	46.2	-1.9
2	#2167.39	26.3 AV	54.0	-27.7	1.64 H	178	28.2	-1.9
3	#2426.23	45.2 PK	74.0	-28.8	1.58 H	142	47.3	-2.1
4	#2426.23	36.1 AV	54.0	-17.9	1.58 H	142	38.2	-2.1
5	#10151.89	49.6 PK	74.0	-24.4	1.31 H	259	37.8	11.8
6	#10151.89	47.1 AV	54.0	-6.9	1.31 H	159	35.3	11.8

ANTENNA POLARITY & TEST DISTANCE: VERTICAL AT 3 M

NO.	FREQ. (MHz)	EMISSION LEVEL (dBuV/m)	LIMIT (dBuV/m)	MARGIN (dB)	ANTENNA HEIGHT (m)	TABLE ANGLE (Degree)	RAW VALUE (dBuV)	CORRECTION FACTOR (dB/m)
1	2210.63	51.8 PK	74.0	-22.2	1.72 V	301	53.4	-1.6
2	2210.63	39.6 AV	54.0	-14.4	1.72 V	301	41.2	-1.6
3	4000.86	40.6 PK	74.0	-33.4	1.65 V	224	39.8	0.8
4	4000.86	31.2 AV	54.0	-22.8	1.65 V	224	30.4	0.8
5	7613.67	45.3 PK	74.0	-28.7	1.59 V	243	36.9	8.4
6	7613.67	37.2 AV	54.0	-16.8	1.59 V	243	28.8	8.4
7	12207.26	53.3 PK	74.0	-20.7	1.57 V	284	40.8	12.5
8	12207.26	35.2 AV	54.0	-18.8	1.57 V	284	22.7	12.5

REMARKS:

1. Emission Level(dBuV/m) = Raw Value(dBuV) + Correction Factor(dB/m)
2. Correction Factor(dB/m) = Antenna Factor(dB/m) + Cable Factor(dB) – Pre-Amplifier Factor(dB)
3. Margin value = Emission Level – Limit value
4. The other emission levels were very low against the limit.
5. " # ": The radiated frequency is out of the restricted band.

CHANNEL	TX Channel 2	DETECTOR FUNCTION	Peak (PK)
FREQUENCY RANGE	18GHz ~ 40GHz		Average (AV)

ANTENNA POLARITY: HORIZONTAL								
NO.	FREQ. (MHz)	EMISSION LEVEL (dBuV/m)	LIMIT (dBuV/m)	MARGIN (dB)	ANTENNA HEIGHT (m)	TABLE ANGLE (Degree)	RAW VALUE (dBuV)	CORRECTION FACTOR (dB/m)
1	#24192.43	44.7 PK	74.0	-29.3	1.69 H	118	62.4	-17.7
2	#24192.43	34.3 AV	54.0	-19.7	1.69 H	118	52.0	-17.7
3	#29600.15	44.6 PK	74.0	-29.4	1.31 H	289	61.5	-16.9
4	#29600.15	37.2 AV	54.0	-16.8	1.31 H	289	54.1	-16.9
5	#34491.52	45.5 PK	74.0	-28.5	1.64 H	302	63.2	-17.7
6	#34491.52	36.3 AV	54.0	-17.7	1.64 H	302	54.0	-17.7

ANTENNA POLARITY: VERTICAL								
NO.	FREQ. (MHz)	EMISSION LEVEL (dBuV/m)	LIMIT (dBuV/m)	MARGIN (dB)	ANTENNA HEIGHT (m)	TABLE ANGLE (Degree)	RAW VALUE (dBuV)	CORRECTION FACTOR (dB/m)
1	21113.85	45.6 PK	74.0	-28.4	1.42 V	330	64.2	-18.6
2	21113.85	35.7 AV	54.0	-18.3	1.42 V	330	54.3	-18.6
3	#27246.05	44.1 PK	74.0	-29.9	1.59 V	281	60.8	-16.7
4	#27246.05	37.3 AV	54.0	-16.7	1.59 V	281	54.0	-16.7
5	31280.90	46.2 PK	74.0	-27.8	1.62 V	301	63.0	-16.8
6	31280.90	36.4 AV	54.0	-17.6	1.62 V	301	53.2	-16.8

REMARKS:

1. Emission Level(dBuV/m) = Raw Value(dBuV) + Correction Factor(dB/m)
2. Correction Factor(dB/m) = Antenna Factor(dB/m) + Cable Factor(dB) – Pre-Amplifier Factor(dB)
3. The other emission levels were very low against the limit.
4. Margin value = Emission Level – Limit value
5. Shorter measurement distances was used to improve the measurement system's noise floor. As standard description is based on the measurement in distance of 3 meters, the data obtained at 1-meter distance was extrapolate results to the 3-m distance:
 Test value at 3-meter distance (dBuV)
 = Test value at 1 meter distance (dBuV) -20log(3/1)(dB)
 = Test value at 1 meter distance (dBuV) -9.54(dB).

*Measurements made at 1 meter distance. Test value converted to account for 3-meter measurement distance.

CHANNEL	TX Channel 2	DETECTOR FUNCTION	Average (AV)
FREQUENCY RANGE	40GHz ~ 200GHz		

ANTENNA POLARITY & TEST DISTANCE: HORIZONTAL AT 3 M						
NO.	Frequency (GHz)	EIRP Level (dBm)	Raw Value (dBm)	Receiver Antenna Gain (dBi)	Power Density (pW/cm ²)	Power Density Limit (pW/cm ²)
1	125.28	-22.5	-67.6	23.3	4.972 AV	90
2	200	-26.5	-75.6	23.3	1.98 AV	90
ANTENNA POLARITY & TEST DISTANCE: VERTICAL AT 3 M						
NO.	Frequency (GHz)	EIRP Level (dBm)	Raw Value (dBm)	Receiver Antenna Gain (dBi)	Power Density (pW/cm ²)	Power Density Limit (pW/cm ²)
1	125.28	-21.8	-66.9	23.3	5.842 AV	90
2	200	-23.0	-72.1	23.3	4.432 AV	90

Note

1. The measured power level is converted to EIRP using the equation:

$$\text{EIRP} = \text{Raw Value} - \text{Receiver Antenna Gain} + 20 \cdot \log(4 \cdot 3.1416 \cdot D / \lambda)$$

where:

D is the measurement distance

λ is the wavelength

*Measurements made at 0.5 meter distance.

2. The far-field boundary is given in ANSI 63.10 as:

$$R \text{ far field} = (2 \cdot L^2) / \lambda$$

L is the Largest Antenna Dimension, including the reflector

λ is the wavelength

FREQUENCY (GHz)	L (m)	Lambda (m)	R (Far Field)
			(m)
62.64	0.02	0.00479	0.167

CHANNEL	TX Channel 3	DETECTOR FUNCTION	Peak (PK)
FREQUENCY RANGE	1GHz ~ 18GHz		Average (AV)

ANTENNA POLARITY & TEST DISTANCE: HORIZONTAL AT 3 M

NO.	FREQ. (MHz)	EMISSION LEVEL (dBuV/m)	LIMIT (dBuV/m)	MARGIN (dB)	ANTENNA HEIGHT (m)	TABLE ANGLE (Degree)	RAW VALUE (dBuV)	CORRECTION FACTOR (dB/m)
1	#2167.41	44.6 PK	74.0	-29.4	1.55 H	302	46.5	-1.9
2	#2167.41	26.7 AV	54.0	-27.3	1.55 H	302	28.6	-1.9
3	#2426.25	45.4 PK	74.0	-28.6	1.63 H	259	47.5	-2.1
4	#2426.25	36.3 AV	54.0	-17.7	1.63 H	259	38.4	-2.1
5	#10151.92	49.3 PK	74.0	-24.7	1.69 H	338	37.5	11.8
6	#10151.92	46.7 AV	54.0	-7.3	1.69 H	338	34.9	11.8

ANTENNA POLARITY & TEST DISTANCE: VERTICAL AT 3 M

NO.	FREQ. (MHz)	EMISSION LEVEL (dBuV/m)	LIMIT (dBuV/m)	MARGIN (dB)	ANTENNA HEIGHT (m)	TABLE ANGLE (Degree)	RAW VALUE (dBuV)	CORRECTION FACTOR (dB/m)
1	2210.63	51.8 PK	74.0	-22.2	1.72 V	331	53.4	-1.6
2	2210.63	38.9 AV	54.0	-15.1	1.72 V	331	40.5	-1.6
3	4000.91	40.1 PK	74.0	-33.9	2.05 V	189	39.3	0.8
4	4000.91	31.8 AV	54.0	-22.2	2.05 V	189	31.0	0.8
5	7613.71	46.1 PK	74.0	-27.9	1.49 V	253	37.7	8.4
6	7613.71	37.5 AV	54.0	-16.5	1.49 V	253	29.1	8.4
7	12207.26	53.1 PK	74.0	-20.9	1.69 V	302	40.6	12.5
8	12207.26	35.2 AV	54.0	-18.8	1.69 V	302	22.7	12.5

REMARKS:

1. Emission Level(dBuV/m) = Raw Value(dBuV) + Correction Factor(dB/m)
2. Correction Factor(dB/m) = Antenna Factor(dB/m) + Cable Factor(dB) – Pre-Amplifier Factor(dB)
3. Margin value = Emission Level – Limit value
4. The other emission levels were very low against the limit.
5. " # ": The radiated frequency is out of the restricted band.

CHANNEL	TX Channel 3	DETECTOR FUNCTION	Peak (PK)
FREQUENCY RANGE	18GHz ~ 40GHz		Average (AV)

ANTENNA POLARITY: HORIZONTAL								
NO.	FREQ. (MHz)	EMISSION LEVEL (dBuV/m)	LIMIT (dBuV/m)	MARGIN (dB)	ANTENNA HEIGHT (m)	TABLE ANGLE (Degree)	RAW VALUE (dBuV)	CORRECTION FACTOR (dB/m)
1	#24193.60	45.1 PK	74.0	-28.9	1.50 H	94	62.8	-17.7
2	#24193.60	34.5 AV	54.0	-19.5	1.50 H	94	52.2	-17.7
3	#29599.72	43.4 PK	74.0	-30.6	1.00 H	284	60.3	-16.9
4	#29599.72	37.2 AV	54.0	-16.8	1.00 H	284	54.1	-16.9
5	#34490.57	45.5 PK	74.0	-28.5	1.50 H	251	63.2	-17.7
6	#34490.57	36.1 AV	54.0	-17.9	1.50 H	251	53.8	-17.7

ANTENNA POLARITY: VERTICAL								
NO.	FREQ. (MHz)	EMISSION LEVEL (dBuV/m)	LIMIT (dBuV/m)	MARGIN (dB)	ANTENNA HEIGHT (m)	TABLE ANGLE (Degree)	RAW VALUE (dBuV)	CORRECTION FACTOR (dB/m)
1	21113.84	45.8 PK	74.0	-28.2	1.00 V	217	64.4	-18.6
2	21113.84	35.4 AV	54.0	-18.6	1.00 V	217	54.0	-18.6
3	#27246.06	44.2 PK	74.0	-29.8	1.50 V	25	60.9	-16.7
4	#27246.06	36.9 AV	54.0	-17.1	1.50 V	25	53.6	-16.7
5	31280.91	46.4 PK	74.0	-27.6	1.00 V	148	63.2	-16.8
6	31280.91	35.9 AV	54.0	-18.1	1.00 V	148	52.7	-16.8

REMARKS:

1. Emission Level(dBuV/m) = Raw Value(dBuV) + Correction Factor(dB/m)
2. Correction Factor(dB/m) = Antenna Factor(dB/m) + Cable Factor(dB) – Pre-Amplifier Factor(dB)
3. The other emission levels were very low against the limit.
4. Margin value = Emission Level – Limit value
5. Shorter measurement distances was used to improve the measurement system's noise floor. As standard description is based on the measurement in distance of 3 meters, the data obtained at 1-meter distance was extrapolate results to the 3-m distance:
 Test value at 3-meter distance (dBuV)
 = Test value at 1 meter distance (dBuV) -20log(3/1)(dB)
 = Test value at 1 meter distance (dBuV) -9.54(dB).

*Measurements made at 1 meter distance. Test value converted to account for 3-meter measurement distance.

CHANNEL	TX Channel 3	DETECTOR FUNCTION	Average (AV)
FREQUENCY RANGE	40GHz ~ 200GHz		

ANTENNA POLARITY & TEST DISTANCE: HORIZONTAL AT 3 M						
NO.	Frequency (GHz)	EIRP Level (dBm)	Raw Value (dBm)	Receiver Antenna Gain (dBi)	Power Density (pW/cm ²)	Power Density Limit (pW/cm ²)
1	125.92	-22.2	-67.3	23.3	5.328 AV	90
2	200	-26.7	-75.8	23.3	1.89 AV	90

ANTENNA POLARITY & TEST DISTANCE: VERTICAL AT 3 M						
NO.	Frequency (GHz)	EIRP Level (dBm)	Raw Value (dBm)	Receiver Antenna Gain (dBi)	Power Density (pW/cm ²)	Power Density Limit (pW/cm ²)
1	125.92	-21.9	-67.0	23.3	5.709 AV	90
2	200	-22.7	-71.8	23.3	4.749 AV	90

Note

1. The measured power level is converted to EIRP using the equation:

$$\text{EIRP} = \text{Raw Value} - \text{Receiver Antenna Gain} + 20 \cdot \log(4 \cdot 3.1416 \cdot D / \lambda)$$

where:

D is the measurement distance

λ is the wavelength

*Measurements made at 0.5 meter distance.

2. The far-field boundary is given in ANSI 63.10 as:

$$R \text{ far field} = (2 \cdot L^2) / \lambda$$

L is the Largest Antenna Dimension, including the reflector

λ is the wavelength

FREQUENCY (GHz)	L (m)	Lambda (m)	R (Far Field) (m)
62.96	0.02	0.00476	0.168

Below 1GHz Data:

CHANNEL	TX Channel 1	DETECTOR FUNCTION	Quasi-Peak (QP)
FREQUENCY RANGE	9kHz ~ 1GHz		

ANTENNA POLARITY & TEST DISTANCE: HORIZONTAL AT 3 M

NO.	FREQ. (MHz)	EMISSION LEVEL (dBuV/m)	LIMIT (dBuV/m)	MARGIN (dB)	ANTENNA HEIGHT (m)	TABLE ANGLE (Degree)	RAW VALUE (dBuV)	CORRECTION FACTOR (dB/m)
1	30.03	31.4 QP	40.0	-8.6	1.54 H	297	40.8	-9.4
2	56.46	30.6 QP	40.0	-9.4	1.59 H	228	39.3	-8.7
3	259.77	31.3 QP	46.0	-14.7	1.56 H	278	39.4	-8.1
4	389.62	34.1 QP	46.0	-11.9	1.54 H	265	38.5	-4.4
5	519.49	33.2 QP	46.0	-12.8	1.54 H	259	34.5	-1.3
6	844.15	41.3 QP	46.0	-4.7	1.89 H	276	36.7	4.6

REMARKS:

1. Emission Level(dBuV/m) = Raw Value(dBuV) + Correction Factor(dB/m)
2. Correction Factor(dB/m) = Antenna Factor(dB/m) + Cable Factor(dB) – Pre-Amplifier Factor(dB)
3. Margin value = Emission Level – Limit value
4. The other emission levels were very low against the limit of frequency range 30MHz~1000MHz.
5. The emission levels were very low against the limit of frequency range 9kHz~30MHz: the amplitude of spurious emissions attenuated more than 20 dB below the permissible value to be report.

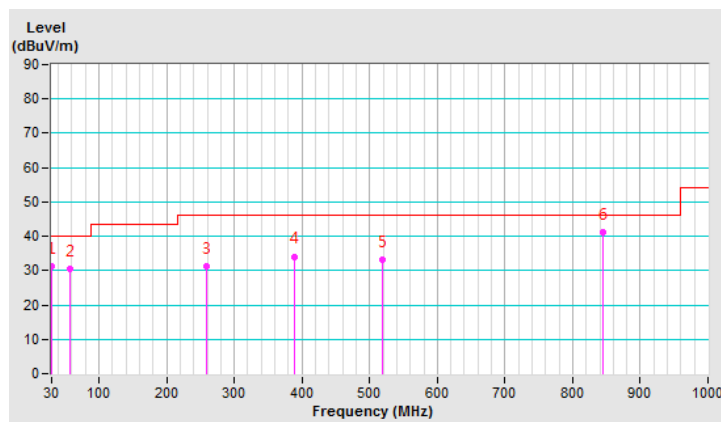

CHANNEL	TX Channel 1	DETECTOR FUNCTION	Quasi-Peak (QP)
FREQUENCY RANGE	9kHz ~ 1GHz		

ANTENNA POLARITY & TEST DISTANCE: VERTICAL AT 3 M

NO.	FREQ. (MHz)	EMISSION LEVEL (dBuV/m)	LIMIT (dBuV/m)	MARGIN (dB)	ANTENNA HEIGHT (m)	TABLE ANGLE (Degree)	RAW VALUE (dBuV)	CORRECTION FACTOR (dB/m)
1	54.90	34.2 QP	40.0	-5.8	1.46 V	228	42.8	-8.6
2	149.65	34.2 QP	43.5	-9.3	1.35 V	241	41.9	-7.7
3	389.60	30.3 QP	46.0	-15.7	1.92 V	265	34.7	-4.4
4	593.30	34.2 QP	46.0	-11.8	1.63 V	142	33.9	0.3
5	710.43	36.5 QP	46.0	-9.5	1.43 V	238	34.6	1.9
6	896.28	39.4 QP	46.0	-6.6	2.51 V	169	34.2	5.2

REMARKS:

1. Emission Level(dBuV/m) = Raw Value(dBuV) + Correction Factor(dB/m)
2. Correction Factor(dB/m) = Antenna Factor(dB/m) + Cable Factor(dB) – Pre-Amplifier Factor(dB)
3. Margin value = Emission Level – Limit value
4. The other emission levels were very low against the limit of frequency range 30MHz~1000MHz.
5. The emission levels were very low against the limit of frequency range 9kHz~30MHz: the amplitude of spurious emissions attenuated more than 20 dB below the permissible value to be report.

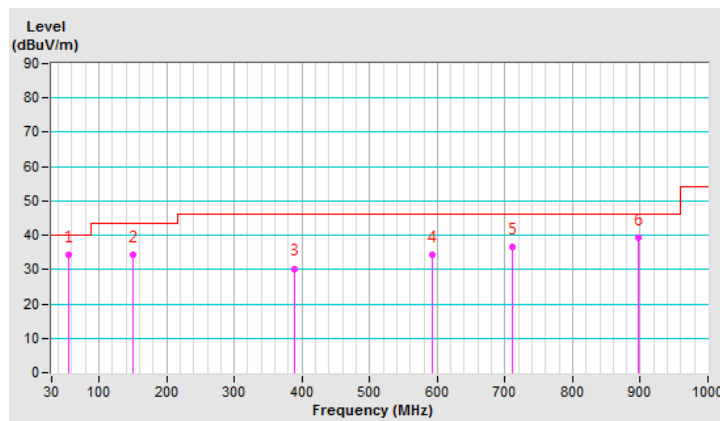

CHANNEL	TX Channel 2	DETECTOR FUNCTION	Quasi-Peak (QP)
FREQUENCY RANGE	9kHz ~ 1GHz		

ANTENNA POLARITY & TEST DISTANCE: HORIZONTAL AT 3 M

NO.	FREQ. (MHz)	EMISSION LEVEL (dBuV/m)	LIMIT (dBuV/m)	MARGIN (dB)	ANTENNA HEIGHT (m)	TABLE ANGLE (Degree)	RAW VALUE (dBuV)	CORRECTION FACTOR (dB/m)
1	30.02	30.8 QP	40.0	-9.2	1.13 H	265	40.2	-9.4
2	56.48	31.4 QP	40.0	-8.6	1.56 H	115	40.1	-8.7
3	259.76	30.3 QP	46.0	-15.7	1.18 H	302	38.4	-8.1
4	389.65	34.4 QP	46.0	-11.6	1.51 H	289	38.8	-4.4
5	519.49	32.8 QP	46.0	-13.2	1.66 H	318	34.1	-1.3
6	844.17	40.8 QP	46.0	-5.2	1.94 H	311	36.2	4.6

REMARKS:

1. Emission Level(dBuV/m) = Raw Value(dBuV) + Correction Factor(dB/m)
2. Correction Factor(dB/m) = Antenna Factor(dB/m) + Cable Factor(dB) – Pre-Amplifier Factor(dB)
3. Margin value = Emission Level – Limit value
4. The other emission levels were very low against the limit of frequency range 30MHz~1000MHz.
5. The emission levels were very low against the limit of frequency range 9kHz~30MHz: the amplitude of spurious emissions attenuated more than 20 dB below the permissible value to be report.

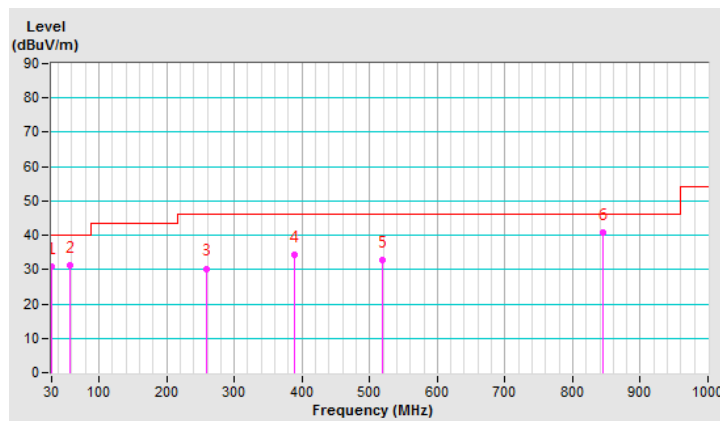

CHANNEL	TX Channel 2	DETECTOR FUNCTION	Quasi-Peak (QP)
FREQUENCY RANGE	9kHz ~ 1GHz		

ANTENNA POLARITY & TEST DISTANCE: VERTICAL AT 3 M

NO.	FREQ. (MHz)	EMISSION LEVEL (dBuV/m)	LIMIT (dBuV/m)	MARGIN (dB)	ANTENNA HEIGHT (m)	TABLE ANGLE (Degree)	RAW VALUE (dBuV)	CORRECTION FACTOR (dB/m)
1	54.90	34.3 QP	40.0	-5.7	1.53 V	241	42.9	-8.6
2	149.65	34.4 QP	43.5	-9.1	1.64 V	218	42.1	-7.7
3	389.60	30.5 QP	46.0	-15.5	1.65 V	331	34.9	-4.4
4	593.29	33.8 QP	46.0	-12.2	1.58 V	241	33.5	0.3
5	710.43	36.7 QP	46.0	-9.3	1.56 V	242	34.8	1.9
6	896.28	39.1 QP	46.0	-6.9	2.43 V	155	33.9	5.2

REMARKS:

1. Emission Level(dBuV/m) = Raw Value(dBuV) + Correction Factor(dB/m)
2. Correction Factor(dB/m) = Antenna Factor(dB/m) + Cable Factor(dB) – Pre-Amplifier Factor(dB)
3. Margin value = Emission Level – Limit value
4. The other emission levels were very low against the limit of frequency range 30MHz~1000MHz.
5. The emission levels were very low against the limit of frequency range 9kHz~30MHz: the amplitude of spurious emissions attenuated more than 20 dB below the permissible value to be report.

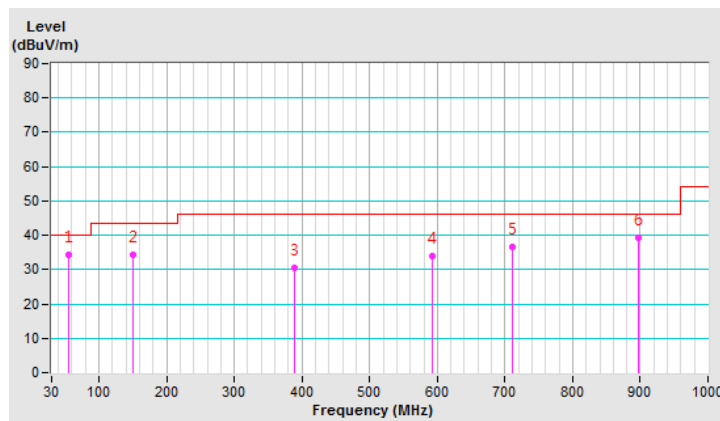

CHANNEL	TX Channel 3	DETECTOR FUNCTION	Quasi-Peak (QP)
FREQUENCY RANGE	9kHz ~ 1GHz		

ANTENNA POLARITY & TEST DISTANCE: HORIZONTAL AT 3 M

NO.	FREQ. (MHz)	EMISSION LEVEL (dBuV/m)	LIMIT (dBuV/m)	MARGIN (dB)	ANTENNA HEIGHT (m)	TABLE ANGLE (Degree)	RAW VALUE (dBuV)	CORRECTION FACTOR (dB/m)
1	30.02	31.3 QP	40.0	-8.7	1.21 H	341	40.7	-9.4
2	56.46	31.8 QP	40.0	-8.2	1.61 H	289	40.5	-8.7
3	259.76	30.8 QP	46.0	-15.2	1.21 H	289	38.9	-8.1
4	389.65	34.8 QP	46.0	-11.2	1.56 H	288	39.2	-4.4
5	519.49	33.4 QP	46.0	-12.6	1.69 H	305	34.7	-1.3
6	844.17	40.4 QP	46.0	-5.6	1.65 H	308	35.8	4.6

REMARKS:

1. Emission Level(dBuV/m) = Raw Value(dBuV) + Correction Factor(dB/m)
2. Correction Factor(dB/m) = Antenna Factor(dB/m) + Cable Factor(dB) – Pre-Amplifier Factor(dB)
3. Margin value = Emission Level – Limit value
4. The other emission levels were very low against the limit of frequency range 30MHz~1000MHz.
5. The emission levels were very low against the limit of frequency range 9kHz~30MHz: the amplitude of spurious emissions attenuated more than 20 dB below the permissible value to be report.

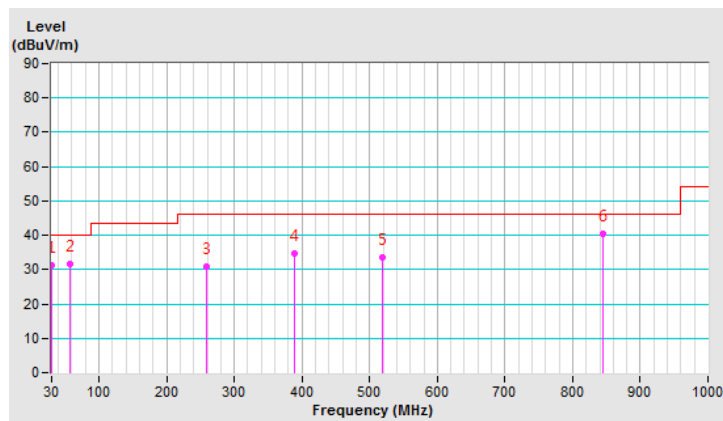

CHANNEL	TX Channel 3	DETECTOR FUNCTION	Quasi-Peak (QP)
FREQUENCY RANGE	9kHz ~ 1GHz		

ANTENNA POLARITY & TEST DISTANCE: VERTICAL AT 3 M

NO.	FREQ. (MHz)	EMISSION LEVEL (dBuV/m)	LIMIT (dBuV/m)	MARGIN (dB)	ANTENNA HEIGHT (m)	TABLE ANGLE (Degree)	RAW VALUE (dBuV)	CORRECTION FACTOR (dB/m)
1	54.90	34.3 QP	40.0	-5.7	1.65 V	238	42.9	-8.6
2	149.65	33.7 QP	43.5	-9.8	1.62 V	184	41.4	-7.7
3	389.60	30.8 QP	46.0	-15.2	2.65 V	338	35.2	-4.4
4	593.30	34.2 QP	46.0	-11.8	1.66 V	271	33.9	0.3
5	710.43	36.5 QP	46.0	-9.5	1.65 V	279	34.6	1.9
6	896.28	39.1 QP	46.0	-6.9	2.42 V	163	33.9	5.2

REMARKS:

1. Emission Level(dBuV/m) = Raw Value(dBuV) + Correction Factor(dB/m)
2. Correction Factor(dB/m) = Antenna Factor(dB/m) + Cable Factor(dB) – Pre-Amplifier Factor(dB)
3. Margin value = Emission Level – Limit value
4. The other emission levels were very low against the limit of frequency range 30MHz~1000MHz.
5. The emission levels were very low against the limit of frequency range 9kHz~30MHz: the amplitude of spurious emissions attenuated more than 20 dB below the permissible value to be report.

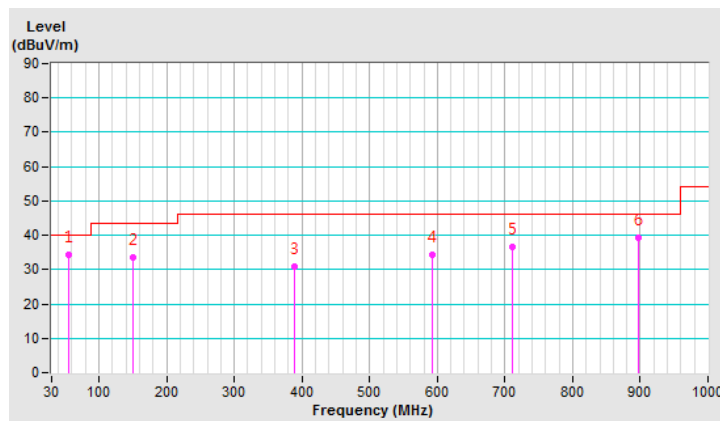

4.1.8 Test Results (HRP mode)

Channel Plan A

Above 1GHz Data:

CHANNEL	TX Channel 1	DETECTOR FUNCTION	Peak (PK)
FREQUENCY RANGE	1GHz ~ 18GHz		Average (AV)

ANTENNA POLARITY & TEST DISTANCE: HORIZONTAL AT 3 M

NO.	FREQ. (MHz)	EMISSION LEVEL (dBuV/m)	LIMIT (dBuV/m)	MARGIN (dB)	ANTENNA HEIGHT (m)	TABLE ANGLE (Degree)	RAW VALUE (dBuV)	CORRECTION FACTOR (dB/m)
1	2833.45	43.6 PK	74.0	-30.4	1.56 H	283	44.8	-1.2
2	2833.45	36.6 AV	54.0	-17.4	1.56 H	283	37.8	-1.2
3	#10525.25	47.1 PK	74.0	-26.9	2.02 H	243	34.5	12.6
4	#10525.25	37.2 AV	54.0	-16.8	2.02 H	243	24.6	12.6
5	#14711.61	57.3 PK	74.0	-16.7	1.53 H	265	41.1	16.2
6	#14711.61	47.6 AV	54.0	-6.4	1.53 H	265	31.4	16.2

ANTENNA POLARITY & TEST DISTANCE: VERTICAL AT 3 M

NO.	FREQ. (MHz)	EMISSION LEVEL (dBuV/m)	LIMIT (dBuV/m)	MARGIN (dB)	ANTENNA HEIGHT (m)	TABLE ANGLE (Degree)	RAW VALUE (dBuV)	CORRECTION FACTOR (dB/m)
1	3774.37	44.3 PK	74.0	-29.7	1.10 V	241	44.2	0.1
2	3774.37	33.6 AV	54.0	-20.4	1.10 V	241	33.5	0.1
3	#8705.56	48.3 PK	74.0	-25.7	1.94 V	295	38.6	9.7
4	#8705.56	35.8 AV	54.0	-18.2	1.94 V	295	26.1	9.7
5	13333.09	48.6 PK	74.0	-25.4	1.65 V	283	34.3	14.3
6	13333.09	35.7 AV	54.0	-18.3	1.65 V	283	21.4	14.3

REMARKS:

1. Emission Level(dBuV/m) = Raw Value(dBuV) + Correction Factor(dB/m)
2. Correction Factor(dB/m) = Antenna Factor(dB/m) + Cable Factor(dB) – Pre-Amplifier Factor(dB)
3. Margin value = Emission Level – Limit value
4. The other emission levels were very low against the limit.
5. " # ": The radiated frequency is out of the restricted band.

CHANNEL	TX Channel 1	DETECTOR FUNCTION	Peak (PK)
FREQUENCY RANGE	18GHz ~ 40GHz		Average (AV)

ANTENNA POLARITY: HORIZONTAL								
NO.	FREQ. (MHz)	EMISSION LEVEL (dBuV/m)	LIMIT (dBuV/m)	MARGIN (dB)	ANTENNA HEIGHT (m)	TABLE ANGLE (Degree)	RAW VALUE (dBuV)	CORRECTION FACTOR (dB/m)
1	#24193.85	46.1 PK	74.0	-27.9	1.65 H	179	63.8	-17.7
2	#24193.85	36.1 AV	54.0	-17.9	1.65 H	179	53.8	-17.7
3	#29602.76	45.5 PK	74.0	-28.5	1.37 H	264	62.4	-16.9
4	#29602.76	37.1 AV	54.0	-16.9	1.37 H	264	54.0	-16.9
5	#34491.63	44.9 PK	74.0	-29.1	1.57 H	279	62.6	-17.7
6	#34491.63	36.1 AV	54.0	-17.9	1.57 H	279	53.8	-17.7
ANTENNA POLARITY: VERTICAL								
NO.	FREQ. (MHz)	EMISSION LEVEL (dBuV/m)	LIMIT (dBuV/m)	MARGIN (dB)	ANTENNA HEIGHT (m)	TABLE ANGLE (Degree)	RAW VALUE (dBuV)	CORRECTION FACTOR (dB/m)
1	21113.35	44.3 PK	74.0	-29.7	1.79 V	224	62.9	-18.6
2	21113.35	34.2 AV	54.0	-19.8	1.79 V	224	52.8	-18.6
3	#27247.10	44.2 PK	74.0	-29.8	1.64 V	281	60.9	-16.7
4	#27247.10	37.5 AV	54.0	-16.5	1.64 V	281	54.2	-16.7
5	31283.64	46.6 PK	74.0	-27.4	1.18 V	146	63.4	-16.8
6	31283.64	35.1 AV	54.0	-18.9	1.18 V	146	51.9	-16.8

REMARKS:

1. Emission Level(dBuV/m) = Raw Value(dBuV) + Correction Factor(dB/m)
2. Correction Factor(dB/m) = Antenna Factor(dB/m) + Cable Factor(dB) – Pre-Amplifier Factor(dB)
3. The other emission levels were very low against the limit.
4. Margin value = Emission Level – Limit value
5. Shorter measurement distances was used to improve the measurement system's noise floor. As standard description is based on the measurement in distance of 3 meters, the data obtained at 1-meter distance was extrapolate results to the 3-m distance:
 Test value at 3-meter distance (dBuV)
 = Test value at 1 meter distance (dBuV) -20log(3/1)(dB)
 = Test value at 1 meter distance (dBuV) -9.54(dB).

*Measurements made at 1 meter distance. Test value converted to account for 3-meter measurement distance.

CHANNEL	TX Channel 1	DETECTOR FUNCTION	Average (AV)
FREQUENCY RANGE	40GHz ~ 200GHz		

ANTENNA POLARITY & TEST DISTANCE: HORIZONTAL AT 3 M						
NO.	Frequency (GHz)	EIRP Level (dBm)	Raw Value (dBm)	Receiver Antenna Gain (dBi)	Power Density (pW/cm ²)	Power Density Limit (pW/cm ²)
1	120.96	-22.2	-67.0	23.3	5.328 AV	90
2	200	-26.7	-75.8	23.3	1.89 AV	90
ANTENNA POLARITY & TEST DISTANCE: VERTICAL AT 3 M						
NO.	Frequency (GHz)	EIRP Level (dBm)	Raw Value (dBm)	Receiver Antenna Gain (dBi)	Power Density (pW/cm ²)	Power Density Limit (pW/cm ²)
1	120.96	-22.2	-67.0	23.3	5.328 AV	90
2	200	-22.8	-71.9	23.3	4.64 AV	90

Note

1. The measured power level is converted to EIRP using the equation:

$$\text{EIRP} = \text{Raw Value} - \text{Receiver Antenna Gain} + 20 \cdot \log(4 \cdot 3.1416 \cdot D / \lambda)$$

where:

D is the measurement distance

λ is the wavelength

*Measurements made at 0.5 meter distance.

2. The far-field boundary is given in ANSI 63.10 as:

$$R \text{ far field} = (2 \cdot L^2) / \lambda$$

L is the Largest Antenna Dimension, including the reflector

λ is the wavelength

FREQUENCY (GHz)	L (m)	Lambda (m)	R (Far Field) (m)
60.48	0.02	0.00496	0.161

CHANNEL	TX Channel 2	DETECTOR FUNCTION	Peak (PK)
FREQUENCY RANGE	1GHz ~ 18GHz		Average (AV)

ANTENNA POLARITY & TEST DISTANCE: HORIZONTAL AT 3 M

NO.	FREQ. (MHz)	EMISSION LEVEL (dBuV/m)	LIMIT (dBuV/m)	MARGIN (dB)	ANTENNA HEIGHT (m)	TABLE ANGLE (Degree)	RAW VALUE (dBuV)	CORRECTION FACTOR (dB/m)
1	2833.46	44.3 PK	74.0	-29.7	1.55 H	297	45.5	-1.2
2	2833.46	36.3 AV	54.0	-17.7	1.55 H	297	37.5	-1.2
3	#10525.23	47.6 PK	74.0	-26.4	1.71 H	226	35.0	12.6
4	#10525.23	37.3 AV	54.0	-16.7	1.17 H	226	24.7	12.6
5	#14711.60	57.3 PK	74.0	-16.7	1.09 H	342	41.1	16.2
6	#14711.60	47.4 AV	54.0	-6.6	1.09 H	342	31.2	16.2

ANTENNA POLARITY & TEST DISTANCE: VERTICAL AT 3 M

NO.	FREQ. (MHz)	EMISSION LEVEL (dBuV/m)	LIMIT (dBuV/m)	MARGIN (dB)	ANTENNA HEIGHT (m)	TABLE ANGLE (Degree)	RAW VALUE (dBuV)	CORRECTION FACTOR (dB/m)
1	3774.35	44.5 PK	74.0	-29.5	1.35 V	172	44.4	0.1
2	3774.35	34.2 AV	54.0	-19.8	1.35 V	172	34.1	0.1
3	#8705.61	48.3 PK	74.0	-25.7	2.05 V	318	38.6	9.7
4	#8705.61	36.3 AV	54.0	-17.7	2.05 V	318	26.6	9.7
5	13333.10	48.9 PK	74.0	-25.1	1.94 V	256	34.6	14.3
6	13333.10	36.2 AV	54.0	-17.8	1.94 V	256	21.9	14.3

REMARKS:

1. Emission Level(dBuV/m) = Raw Value(dBuV) + Correction Factor(dB/m)
2. Correction Factor(dB/m) = Antenna Factor(dB/m) + Cable Factor(dB) – Pre-Amplifier Factor(dB)
3. Margin value = Emission Level – Limit value
4. The other emission levels were very low against the limit.
5. " # ": The radiated frequency is out of the restricted band.

CHANNEL	TX Channel 2	DETECTOR FUNCTION	Peak (PK)
FREQUENCY RANGE	18GHz ~ 40GHz		Average (AV)

ANTENNA POLARITY: HORIZONTAL								
NO.	FREQ. (MHz)	EMISSION LEVEL (dBuV/m)	LIMIT (dBuV/m)	MARGIN (dB)	ANTENNA HEIGHT (m)	TABLE ANGLE (Degree)	RAW VALUE (dBuV)	CORRECTION FACTOR (dB/m)
1	#24194.46	46.7 PK	74.0	-27.3	1.25 H	249	64.4	-17.7
2	#24194.46	35.2 AV	54.0	-18.8	1.25 H	249	52.9	-17.7
3	#29602.61	45.6 PK	74.0	-28.4	2.00 H	338	62.5	-16.9
4	#29602.61	37.8 AV	54.0	-16.2	2.00 H	338	54.7	-16.9
5	#34491.35	46.4 PK	74.0	-27.6	1.92 H	187	64.1	-17.7
6	#34491.35	36.6 AV	54.0	-17.4	1.92 H	187	54.3	-17.7

ANTENNA POLARITY: VERTICAL								
NO.	FREQ. (MHz)	EMISSION LEVEL (dBuV/m)	LIMIT (dBuV/m)	MARGIN (dB)	ANTENNA HEIGHT (m)	TABLE ANGLE (Degree)	RAW VALUE (dBuV)	CORRECTION FACTOR (dB/m)
1	21113.40	44.7 PK	74.0	-29.3	1.81 V	95	63.3	-18.6
2	21113.40	34.8 AV	54.0	-19.2	1.81 V	95	53.4	-18.6
3	#27247.12	44.6 PK	74.0	-29.4	1.59 V	174	61.3	-16.7
4	#27247.12	37.7 AV	54.0	-16.3	1.59 V	174	54.4	-16.7
5	31283.65	46.3 PK	74.0	-27.7	1.58 V	312	63.1	-16.8
6	31283.65	35.7 AV	54.0	-18.3	1.58 V	312	52.5	-16.8

REMARKS:

1. Emission Level(dBuV/m) = Raw Value(dBuV) + Correction Factor(dB/m)
2. Correction Factor(dB/m) = Antenna Factor(dB/m) + Cable Factor(dB) – Pre-Amplifier Factor(dB)
3. The other emission levels were very low against the limit.
4. Margin value = Emission Level – Limit value
5. Shorter measurement distances was used to improve the measurement system's noise floor. As standard description is based on the measurement in distance of 3 meters, the data obtained at 1-meter distance was extrapolate results to the 3-m distance:
 Test value at 3-meter distance (dBuV)
 = Test value at 1 meter distance (dBuV) -20log(3/1)(dB)
 = Test value at 1 meter distance (dBuV) -9.54(dB).

*Measurements made at 1 meter distance. Test value converted to account for 3-meter measurement distance.

CHANNEL	TX Channel 2	DETECTOR FUNCTION	Average (AV)
FREQUENCY RANGE	40GHz ~ 200GHz		

ANTENNA POLARITY & TEST DISTANCE: HORIZONTAL AT 3 M

NO.	Frequency (GHz)	EIRP Level (dBm)	Raw Value (dBm)	Receiver Antenna Gain (dBi)	Power Density (pW/cm ²)	Power Density Limit (pW/cm ²)
1	125.28	-21.6	-66.7	23.3	6.117 AV	90
2	200	-27.0	-76.1	23.3	1.764 AV	90

ANTENNA POLARITY & TEST DISTANCE: VERTICAL AT 3 M

NO.	Frequency (GHz)	EIRP Level (dBm)	Raw Value (dBm)	Receiver Antenna Gain (dBi)	Power Density (pW/cm ²)	Power Density Limit (pW/cm ²)
1	125.28	-21.7	-66.8	23.3	5.978 AV	90
2	200	-22.7	-71.8	23.3	4.749 AV	90

Note

1. The measured power level is converted to EIRP using the equation:

$$\text{EIRP} = \text{Raw Value} - \text{Receiver Antenna Gain} + 20 \cdot \log(4 \cdot 3.1416 \cdot D / \lambda)$$

where:

D is the measurement distance

λ is the wavelength

*Measurements made at 0.5 meter distance.

2. The far-field boundary is given in ANSI 63.10 as:

$$R \text{ far field} = (2 \cdot L^2) / \lambda$$

L is the Largest Antenna Dimension, including the reflector

λ is the wavelength

FREQUENCY (GHz)	L (m)	Lambda (m)	R (Far Field) (m)
62.64	0.02	0.00479	0.167

Below 1GHz Data:

CHANNEL	TX Channel 1	DETECTOR FUNCTION	Quasi-Peak (QP)
FREQUENCY RANGE	9kHz ~ 1GHz		

ANTENNA POLARITY & TEST DISTANCE: HORIZONTAL AT 3 M								
NO.	FREQ. (MHz)	EMISSION LEVEL (dBuV/m)	LIMIT (dBuV/m)	MARGIN (dB)	ANTENNA HEIGHT (m)	TABLE ANGLE (Degree)	RAW VALUE (dBuV)	CORRECTION FACTOR (dB/m)
1	30.05	32.5 QP	40.0	-7.5	1.15 H	301	41.9	-9.4
2	56.48	31.4 QP	40.0	-8.6	1.62 H	204	40.1	-8.7
3	259.77	30.4 QP	46.0	-15.6	1.41 H	229	38.5	-8.1
4	389.63	33.8 QP	46.0	-12.2	1.16 H	238	38.2	-4.4
5	519.49	32.8 QP	46.0	-13.2	1.61 H	203	34.1	-1.3
6	844.17	41.1 QP	46.0	-4.9	1.56 H	297	36.5	4.6

REMARKS:

1. Emission Level(dBuV/m) = Raw Value(dBuV) + Correction Factor(dB/m)
2. Correction Factor(dB/m) = Antenna Factor(dB/m) + Cable Factor(dB) – Pre-Amplifier Factor(dB)
3. Margin value = Emission Level – Limit value
4. The other emission levels were very low against the limit of frequency range 30MHz~1000MHz.
5. The emission levels were very low against the limit of frequency range 9kHz~30MHz: the amplitude of spurious emissions attenuated more than 20 dB below the permissible value to be report.

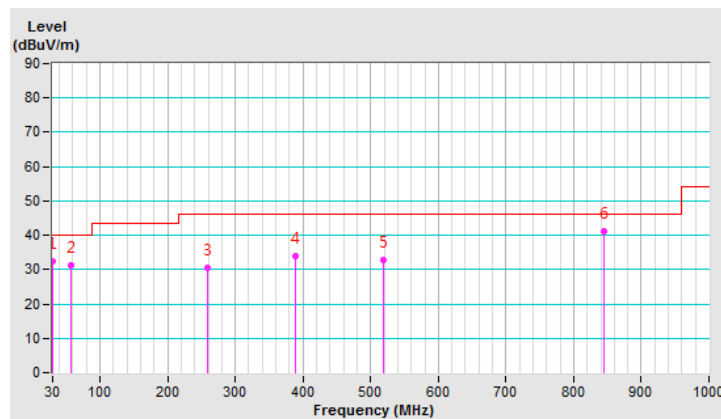

CHANNEL	TX Channel 1	DETECTOR FUNCTION	Quasi-Peak (QP)
FREQUENCY RANGE	9kHz ~ 1GHz		

ANTENNA POLARITY & TEST DISTANCE: VERTICAL AT 3 M

NO.	FREQ. (MHz)	EMISSION LEVEL (dBuV/m)	LIMIT (dBuV/m)	MARGIN (dB)	ANTENNA HEIGHT (m)	TABLE ANGLE (Degree)	RAW VALUE (dBuV)	CORRECTION FACTOR (dB/m)
1	54.90	34.5 QP	40.0	-5.5	1.58 V	242	43.1	-8.6
2	149.65	34.5 QP	43.5	-9.0	1.51 V	297	42.2	-7.7
3	389.60	31.4 QP	46.0	-14.6	2.93 V	228	35.8	-4.4
4	593.30	34.4 QP	46.0	-11.6	1.59 V	283	34.1	0.3
5	710.43	37.2 QP	46.0	-8.8	1.59 V	302	35.3	1.9
6	896.28	39.2 QP	46.0	-6.8	2.52 V	335	34.0	5.2

REMARKS:

1. Emission Level(dBuV/m) = Raw Value(dBuV) + Correction Factor(dB/m)
2. Correction Factor(dB/m) = Antenna Factor(dB/m) + Cable Factor(dB) – Pre-Amplifier Factor(dB)
3. Margin value = Emission Level – Limit value
4. The other emission levels were very low against the limit of frequency range 30MHz~1000MHz.
5. The emission levels were very low against the limit of frequency range 9kHz~30MHz: the amplitude of spurious emissions attenuated more than 20 dB below the permissible value to be report.

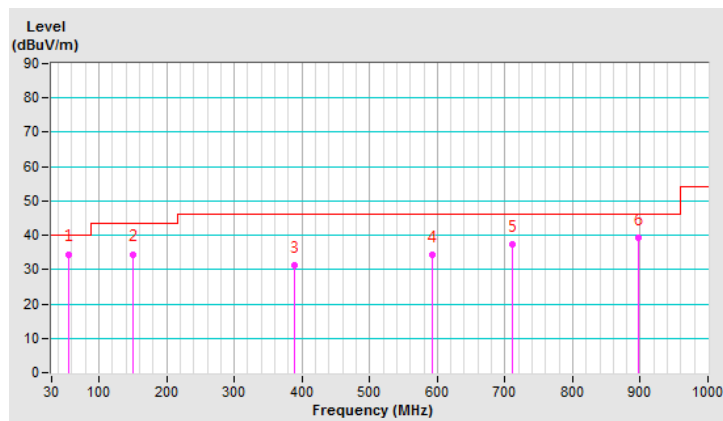

CHANNEL	TX Channel 2	DETECTOR FUNCTION	Quasi-Peak (QP)
FREQUENCY RANGE	9kHz ~ 1GHz		

ANTENNA POLARITY & TEST DISTANCE: HORIZONTAL AT 3 M								
NO.	FREQ. (MHz)	EMISSION LEVEL (dBuV/m)	LIMIT (dBuV/m)	MARGIN (dB)	ANTENNA HEIGHT (m)	TABLE ANGLE (Degree)	RAW VALUE (dBuV)	CORRECTION FACTOR (dB/m)
1	30.05	32.3 QP	40.0	-7.7	1.41 H	258	41.7	-9.4
2	56.48	31.6 QP	40.0	-8.4	1.51 H	305	40.3	-8.7
3	259.77	30.8 QP	46.0	-15.2	1.41 H	306	38.9	-8.1
4	389.63	34.2 QP	46.0	-11.8	1.41 H	141	38.6	-4.4
5	519.49	34.1 QP	46.0	-11.9	1.52 H	318	35.4	-1.3
6	844.17	40.2 QP	46.0	-5.8	1.43 H	189	35.6	4.6

REMARKS:

1. Emission Level(dBuV/m) = Raw Value(dBuV) + Correction Factor(dB/m)
2. Correction Factor(dB/m) = Antenna Factor(dB/m) + Cable Factor(dB) – Pre-Amplifier Factor(dB)
3. Margin value = Emission Level – Limit value
4. The other emission levels were very low against the limit of frequency range 30MHz~1000MHz.
5. The emission levels were very low against the limit of frequency range 9kHz~30MHz: the amplitude of spurious emissions attenuated more than 20 dB below the permissible value to be report.

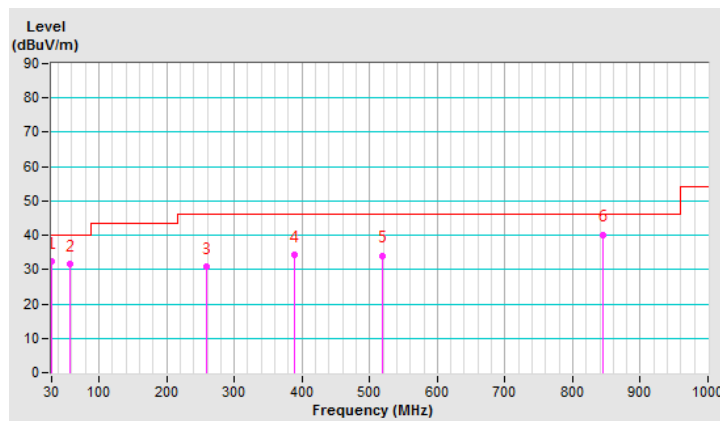

CHANNEL	TX Channel 2	DETECTOR FUNCTION	Quasi-Peak (QP)
FREQUENCY RANGE	9kHz ~ 1GHz		

ANTENNA POLARITY & TEST DISTANCE: VERTICAL AT 3 M

NO.	FREQ. (MHz)	EMISSION LEVEL (dBuV/m)	LIMIT (dBuV/m)	MARGIN (dB)	ANTENNA HEIGHT (m)	TABLE ANGLE (Degree)	RAW VALUE (dBuV)	CORRECTION FACTOR (dB/m)
1	54.90	34.2 QP	40.0	-5.8	1.45 V	189	42.8	-8.6
2	149.65	34.2 QP	43.5	-9.3	1.64 V	238	41.9	-7.7
3	389.60	31.4 QP	46.0	-14.6	2.55 V	302	35.8	-4.4
4	593.30	34.2 QP	46.0	-11.8	1.65 V	298	33.9	0.3
5	710.43	37.2 QP	46.0	-8.8	1.54 V	301	35.3	1.9
6	896.28	39.2 QP	46.0	-6.8	2.64 V	118	34.0	5.2

REMARKS:

1. Emission Level(dBuV/m) = Raw Value(dBuV) + Correction Factor(dB/m)
2. Correction Factor(dB/m) = Antenna Factor(dB/m) + Cable Factor(dB) – Pre-Amplifier Factor(dB)
3. Margin value = Emission Level – Limit value
4. The other emission levels were very low against the limit of frequency range 30MHz~1000MHz.
5. The emission levels were very low against the limit of frequency range 9kHz~30MHz: the amplitude of spurious emissions attenuated more than 20 dB below the permissible value to be report.

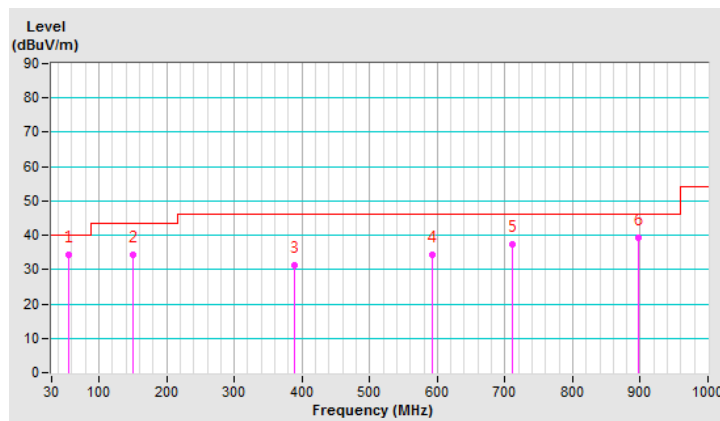

4.2 Conducted Emission Measurement

4.2.1 Limits of Conducted Emission Measurement

Frequency (MHz)	Conducted Limit (dBuV)	
	Quasi-peak	Average
0.15 - 0.5	66 - 56	56 - 46
0.50 - 5.0	56	46
5.0 - 30.0	60	50

Note: 1. The lower limit shall apply at the transition frequencies.

2. The limit decreases in line with the logarithm of the frequency in the range of 0.15 to 0.50MHz.

4.2.2 Test Instruments

DESCRIPTION & MANUFACTURER	MODEL NO.	SERIAL NO.	CALIBRATED DATE	CALIBRATED UNTIL
Test Receiver R&S	ESCS 30	847124/029	Oct. 24, 2018	Oct. 23, 2019
Line-Impedance Stabilization Network (for EUT) R&S	ESH3-Z5	848773/004	Oct. 22, 2018	Oct. 21, 2019
Line-Impedance Stabilization Network (for Peripheral) R&S	ESH3-Z5	835239/001	Mar. 17, 2019	Mar. 16, 2020
50 ohms Terminator	N/A	3	Oct. 22, 2018	Oct. 21, 2019
RF Cable	5D-FB	COCCAB-001	Sep. 28, 2018	Sep. 27, 2019
Fixed attenuator EMCI	STI02-2200-10	003	Mar. 14, 2019	Mar. 13, 2020
Software BVADT	BVADT_Cond_ V7.3.7.4	NA	NA	NA

Note:

1. The calibration interval of the above test instruments are 12 months and the calibrations are traceable to NML/ROC and NIST/USA.
2. The test was performed in Conduction 1.
3. Tested Date: Apr. 18, 2019

4.2.3 Test Procedures

- The EUT was placed 0.4 meters from the conducting wall of the shielded room with EUT being connected to the power mains through a line impedance stabilization network (LISN). Other support units were connected to the power mains through another LISN. The two LISNs provide 50 ohm/ 50uH of coupling impedance for the measuring instrument.
- Both lines of the power mains connected to the EUT were checked for maximum conducted interference.
- The frequency range from 150kHz to 30MHz was searched. Emission levels under (Limit - 20dB) was not recorded.

NOTE: The resolution bandwidth and video bandwidth of test receiver is 9kHz for quasi-peak detection (QP) and average detection (AV) at frequency 0.15MHz-30MHz.

4.2.4 Deviation from Test Standard

No deviation.

4.2.5 Test Setup

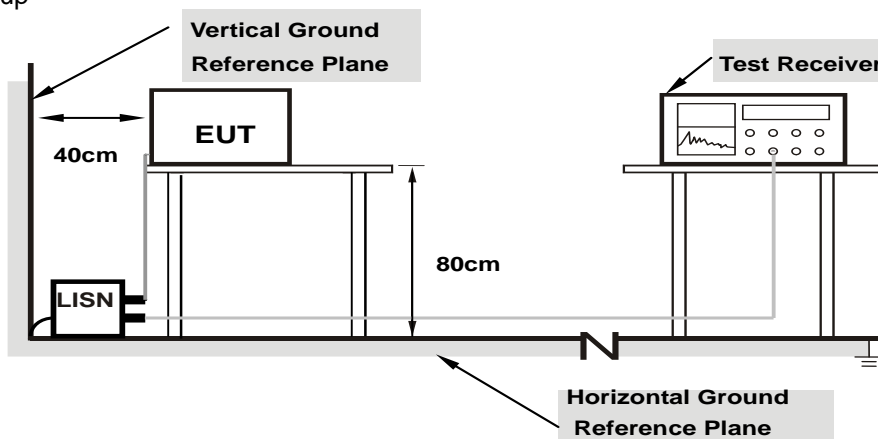

Note: 1.Support units were connected to second LISN.

For the actual test configuration, please refer to the attached file (Test Setup Photo).

4.2.6 EUT Operating Conditions

Same as 4.1.6.

4.2.7 Test Results

Phase	Line (L)	Detector Function	Quasi-Peak (QP) / Average (AV)
-------	----------	-------------------	--------------------------------

Phase Of Power : Line (L)										
No	Frequency (MHz)	Correction Factor (dB)	Reading Value (dBuV)		Emission Level (dBuV)		Limit (dBuV)		Margin (dB)	
			Q.P.	AV.	Q.P.	AV.	Q.P.	AV.	Q.P.	AV.
1	0.15000	10.02	10.96	5.14	20.98	15.16	66.00	56.00	-45.02	-40.84
2	0.18906	10.04	10.04	1.85	20.08	11.89	64.08	54.08	-44.00	-42.19
3	0.29844	10.05	10.72	6.13	20.77	16.18	60.29	50.29	-39.52	-34.11
4	0.56797	10.08	11.45	3.35	21.53	13.43	56.00	46.00	-34.47	-32.57
5	7.70313	10.42	10.67	5.03	21.09	15.45	60.00	50.00	-38.91	-34.55
6	20.28906	11.07	2.31	-3.01	13.38	8.06	60.00	50.00	-46.62	-41.94

Remarks:

1. Q.P. and AV. are abbreviations of quasi-peak and average individually.
2. The emission levels of other frequencies were very low against the limit.
3. Margin value = Emission level – Limit value
4. Correction factor = Insertion loss + Cable loss
5. Emission Level = Correction Factor + Reading Value

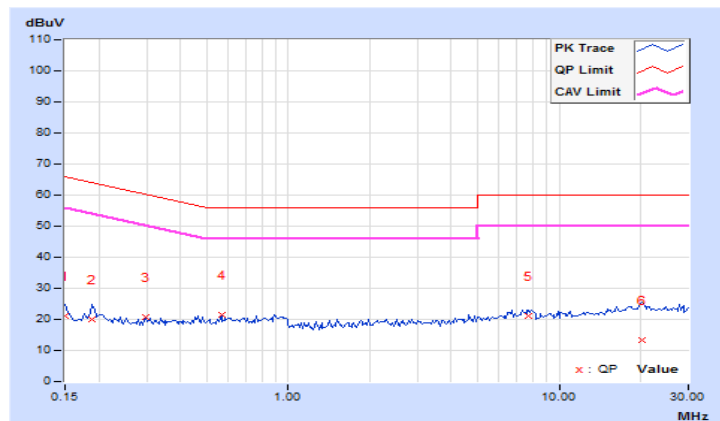

Phase	Neutral (N)	Detector Function	Quasi-Peak (QP) / Average (AV)
-------	-------------	-------------------	--------------------------------

Phase Of Power : Neutral (N)										
No	Frequency (MHz)	Correction Factor (dB)	Reading Value (dBuV)		Emission Level (dBuV)		Limit (dBuV)		Margin (dB)	
			Q.P.	AV.	Q.P.	AV.	Q.P.	AV.	Q.P.	AV.
1	0.15000	9.93	5.07	2.05	15.00	11.98	66.00	56.00	-51.00	-44.02
2	0.15781	9.93	6.13	1.81	16.06	11.74	65.58	55.58	-49.52	-43.84
3	0.18906	9.94	10.10	1.99	20.04	11.93	64.08	54.08	-44.04	-42.15
4	0.49375	9.96	10.06	3.65	20.02	13.61	56.10	46.10	-36.08	-32.49
5	7.81250	10.29	6.46	2.10	16.75	12.39	60.00	50.00	-43.25	-37.61
6	19.29297	10.84	3.77	-1.48	14.61	9.36	60.00	50.00	-45.39	-40.64

Remarks:

1. Q.P. and AV. are abbreviations of quasi-peak and average individually.
2. The emission levels of other frequencies were very low against the limit.
3. Margin value = Emission level – Limit value
4. Correction factor = Insertion loss + Cable loss
5. Emission Level = Correction Factor + Reading Value

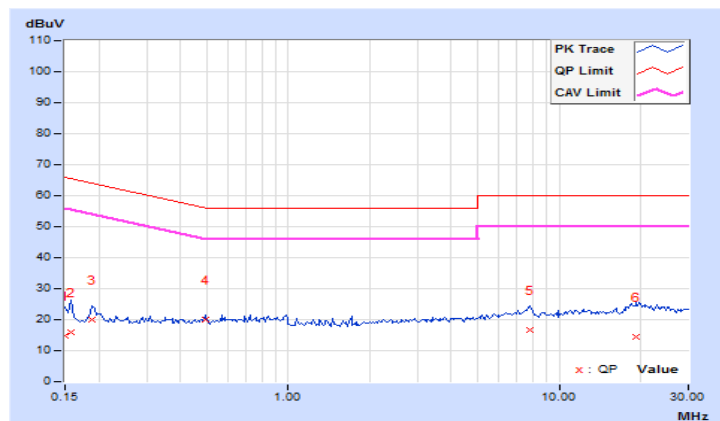

4.3 6dB Bandwidth Measurement

4.3.1 Limits of 6dB Bandwidth Measurement

None: For reporting purposes only.

4.3.2 Test Setup

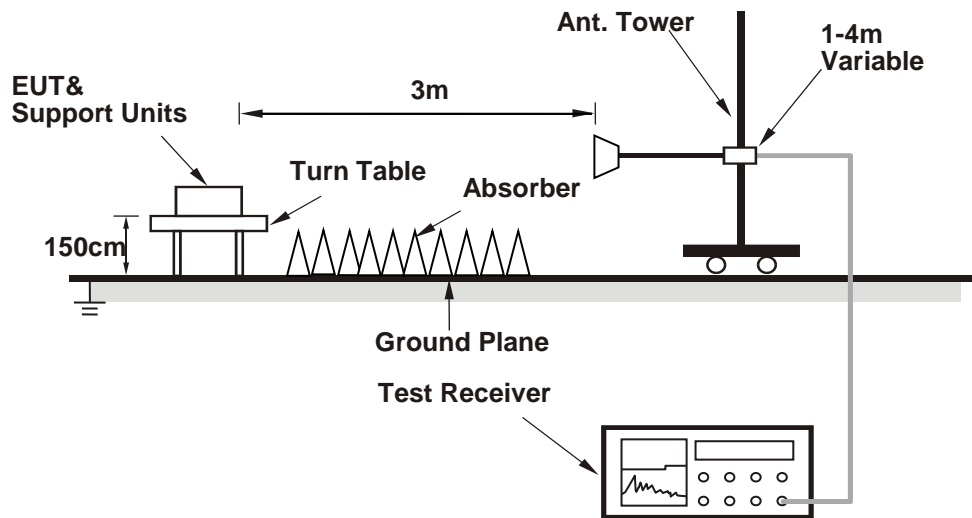

4.3.3 Test Instruments

Refer to section 4.1.2 to get information of above instrument.

4.3.4 Test Procedure

The spectrum analyzer and external mixer are set up to measure the radiated output of the transmitter.

4.3.5 Deviation from Test Standard

No deviation.

4.3.6 EUT Operating Conditions

The software provided by client to enable the EUT under transmission condition continuously at lowest, middle and highest channel frequencies individually.

4.3.7 Test Result (LRP Mode)

Channel Plan A

Channel	Frequency (GHz)	6dB Bandwidth (MHz)
1	60.16	90.36
2	60.48	90.1
3	60.8	90.22

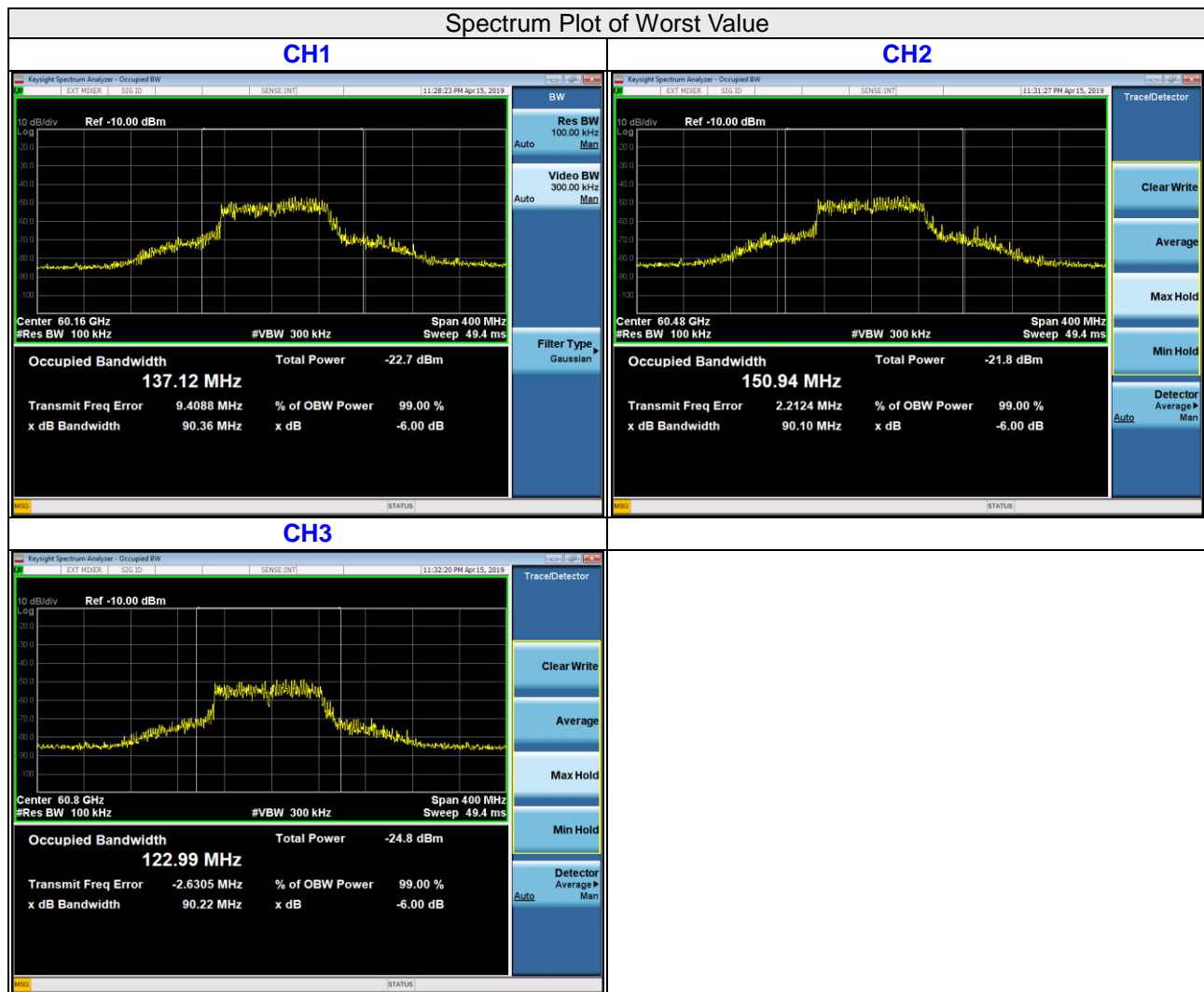

Channel Plan B

Channel	Frequency (GHz)	6dB Bandwidth (MHz)
1	62.32	90.59
2	62.64	90.74
3	62.96	90.41

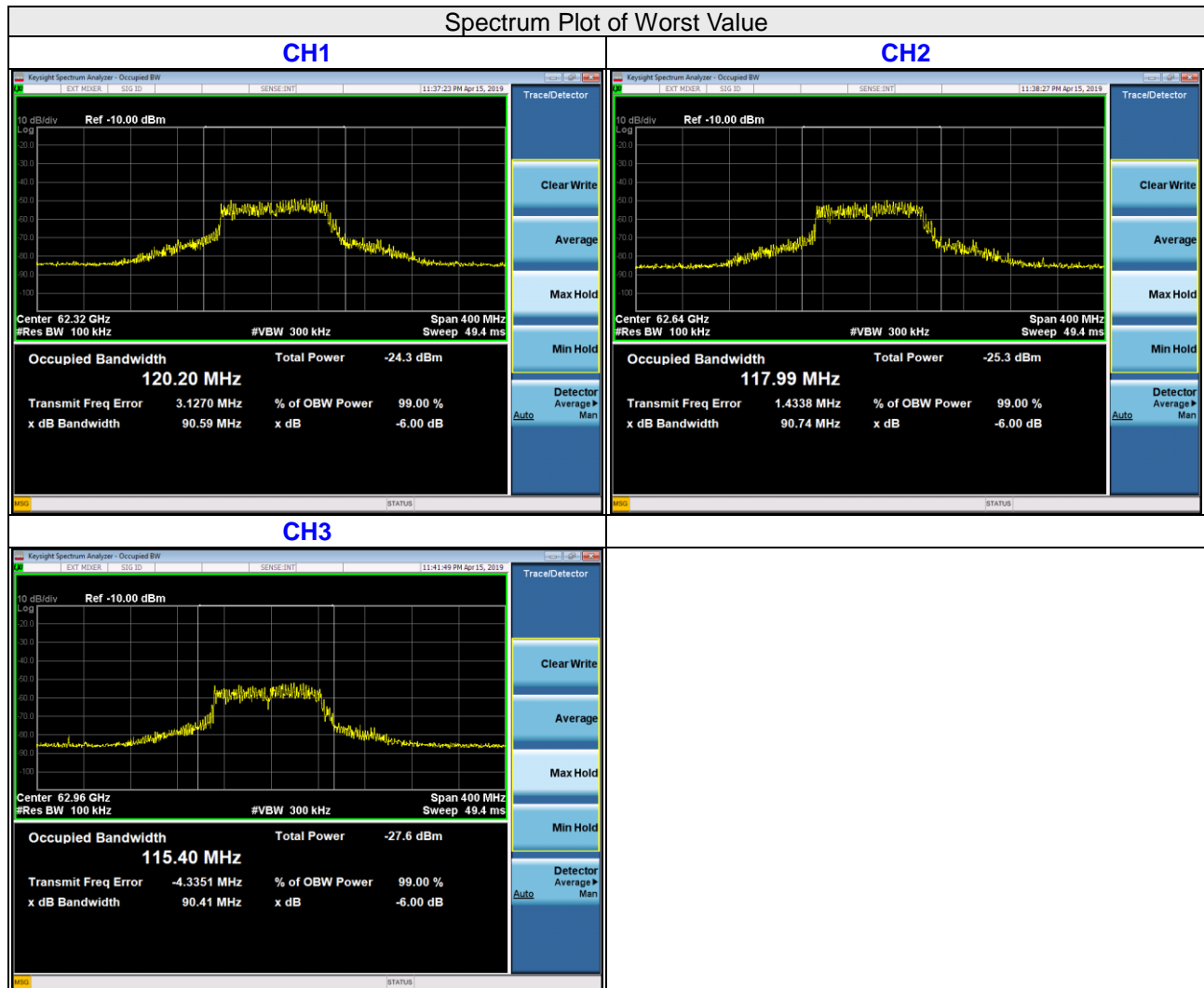

4.3.8 Test Result (HRP Mode)

Channel	Frequency (GHz)	6dB Bandwidth (MHz)
1	60.48	1497
2	62.64	1952

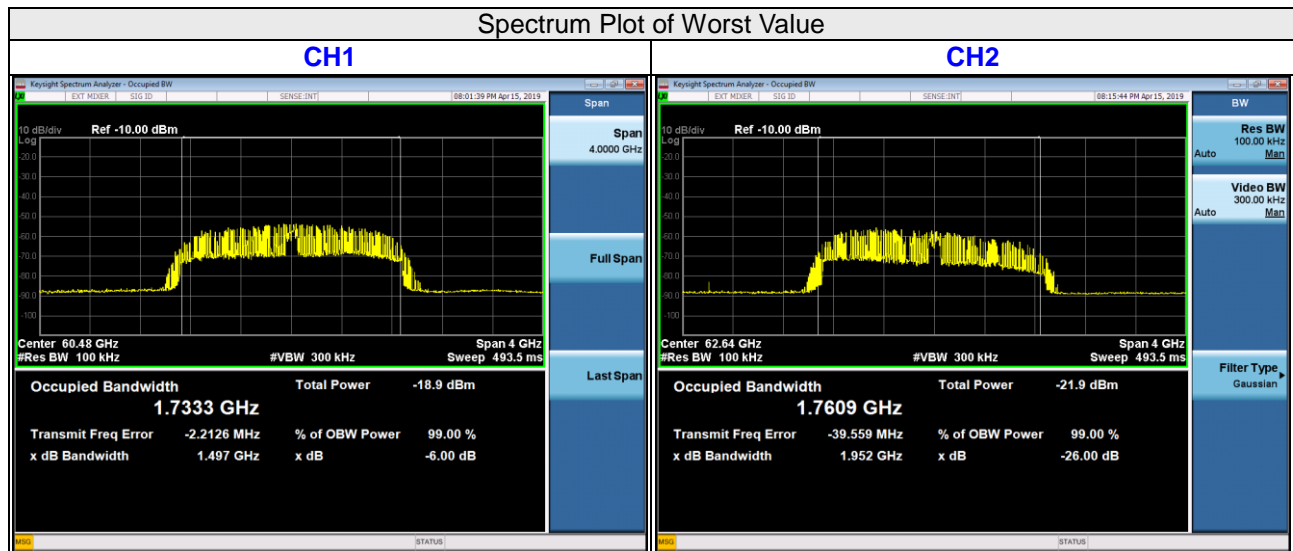

4.4 Output Power Measurement

4.4.1 Limits of Output Power Measurement

15.255 (c) & (e)

Output Power (EIRP)				
Applicable	Type		Peak Power	Average Power
V	Within the 57-71 GHz band (Other than fixed field disturbance sensors and short-range devices)	Other than fixed point to point transmitters located outdoors	43dBm	40dBm
		Fixed point-to-point transmitters located outdoors	85dBm (*Note 1)	82dBm (*Note 2)
	Fixed field disturbance sensors (61-61.5GHz)	Occupy 500 MHz or less of bandwidth	43dBm (*Note 3)	40dBm (*Note 3)
	Fixed field disturbance sensors	Other than occupy 500 MHz or less of bandwidth and that are contained wholly within the frequency band 61.0-61.5 GHz	10dBm	-
	short-range devices for interactive motion sensing	-		

Note:

1. The average power of any emission shall not exceed 82 dBm, and shall be reduced by 2 dB for every dB that the antenna gain is less than 51 dBi.
2. The peak power of any emission shall not exceed 85 dBm, and shall be reduced by 2 dB for every dB that the antenna gain is less than 51 dBi.
3. In addition, the average power of any emission outside of the 61.0-61.5 GHz band, measured during the transmit interval, but still within the 57-71 GHz band, shall not exceed 10 dBm, and the peak power of any emission shall not exceed 13 dBm.

Peak Output Power (Conducted Power)			
Applicable	Type	6dB Bandwidth	Maximum Conducted Power
	Fixed field disturbance sensors (Exclude 61-61.5GHz)	-	$\leq 0.1\text{mW}$
V	Other	Other	500mW
		Less than 100MHz	$500\text{mW} \times (B/100)$

Note:

1. B is 6dB Bandwidth (measured with a 100kHz resolution bandwidth)
2. Peak transmitter output power shall be measured with an RF detector that has a detection bandwidth that encompasses the 57-64 GHz band and the has a video bandwidth of at least 10 MHz, or using an equivalent measurement method.
3. For purposes of demonstrating compliance with this paragraph (e), corrections to the transmitter output power may be made due to the antenna and circuit loss.

4.4.2 Test Setup

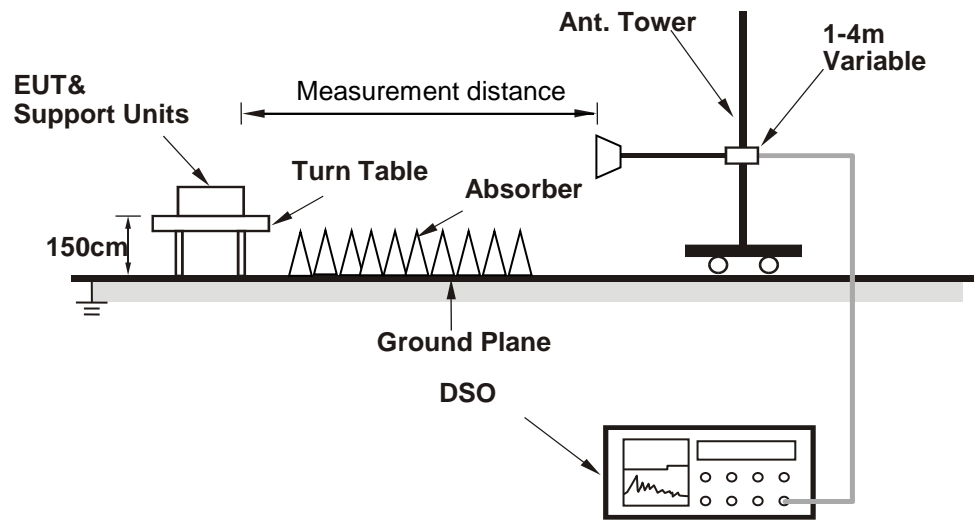

4.4.3 Test Instruments

Refer to section 4.1.2 to get information of above instrument.

4.4.4 Test Procedures

- a. Place the EUT in a continuous transmission mode.
- b. For radiated emission measurements, attach a test receive antenna for the fundamental frequency band to the RF input of an RF detector or a downconverter with an RF detector at the output.
- c. Connect the video output of the detector to the 50 ohm input of the DSO.
- d. Place the test receive antenna in the main beam of the EUT at a distance which will provide a signal within the operating range of the RF detector.
- e. Set the sampling rate of the DSO to the required value. Adjust the memory depth, the triggering and the sweep speed to obtain a display which is representative of the signal considering the type of modulation.
- f. For radiated emission measurements, calculate the distance to the far field boundary of the fundamental emission using following equation

$$d_{farfield} = \frac{2D^2}{\lambda}$$

where:

D = largest dimension of the transmit antenna

λ = wavelength

Frequency (GHz)	L (m)	Lambda (m)	R (Far Field) (m)
60.48	0.025	0.0050	0.25

- g. Perform radiated emission measurements to keep maximize the received signal from the EUT in the far field.
- h. Record the average and peak from the DSO and the measurement distance.
- i. Disconnect the EUT from the RF input port of the instrumentation system.
- j. Connect a mm-wave source to the RF input port of the instrumentation system via a waveguide variable attenuator. The mm-wave source is unmodulated.
- k. Using substitution measurement.
- l. Measure and note the power.
- m. For conducted power measurements, calculate the conducted power using following equation

$$P_{cond} = EIRP - G_{dB}$$

4.4.5 Deviation from Test Standard

No deviation.

4.4.6 EUT Operating Conditions

Same as Item 4.3.6.

4.4.7 Test Results (LRP Mode)

For Peak Power

Channel Plan A

The EIRP was evaluated on vertical and horizontal polarization, the worst case is horizontal polarization

Channel	Frequency (GHz)	EIRP (dBm)	Max. Antenna Gain (dBi)	Conducted Output Power (dBm)	Conducted Output Power (mW)	EIRP Limit (dBm)	Conducted Output Power limit (mW)	Pass /Fail
1	60.16	24.1	18	6.1	4.07	43	500	Pass
2	60.48	23.9	18	5.9	3.89	43	500	Pass
3	60.8	23.8	18	5.8	3.80	43	500	Pass

Channel Plan B

The EIRP was evaluated on vertical and horizontal polarization, the worst case is horizontal polarization

Channel	Frequency (GHz)	EIRP (dBm)	Max. Antenna Gain (dBi)	Conducted Output Power (dBm)	Conducted Output Power (mW)	EIRP Limit (dBm)	Conducted Output Power limit (mW)	Pass /Fail
1	62.32	23.8	18	5.8	3.80	43	500	Pass
2	62.64	23.9	18	5.9	3.89	43	500	Pass
3	62.96	24	18	6	3.98	43	500	Pass

For Average Power

Channel Plan A

Channel	Frequency (GHz)	Transmitt Antenna	S.G Output Value (dBm)	EIRP (dBm)	EIRP Limit (dBm)	Pass /Fail
1	60.16	21.4	-19.9	1.5	40	Pass
2	60.48	21.4	-19.7	1.7	40	Pass
3	60.8	21.4	-19.9	1.5	40	Pass

Note:

The EIRP was evaluated on vertical and horizontal polarization, the worst case is Vertical polarization.

Channel Plan B

Channel	Frequency (GHz)	Transmitt Antenna	S.G Output Value (dBm)	EIRP (dBm)	EIRP Limit (dBm)	Pass /Fail
1	62.32	21.4	-20.1	1.3	40	Pass
2	62.64	21.4	-20.0	1.4	40	Pass
3	62.96	21.4	-20.2	1.2	40	Pass

Note:

The EIRP was evaluated on vertical and horizontal polarization, the worst case is Vertical polarization.

4.4.8 Test Results (HRP Mode)

For Peak Power

The EIRP was evaluated on vertical and horizontal polarization, the worst case is horizontal polarization

Channel	Frequency (GHz)	EIRP (dBm)	Max. Antenna Gain (dBi)	Conducted Output Power (dBm)	Conducted Output Power (mW)	EIRP Limit (dBm)	Conducted Output Power limit (mW)	Pass /Fail
1	60.48	29.9	18	11.9	15.49	43	500	Pass
2	62.64	29.7	18	11.7	14.79	43	500	Pass

For Average Power

Channel	Frequency (GHz)	Transmitt Antenna	S.G Output Value (dBm)	EIRP (dBm)	EIRP Limit (dBm)	Pass /Fail
1	60.48	21.4	-17.5	4.0	40	Pass
2	62.64	21.4	-17.4	4.0	40	Pass

Note:

The EIRP was evaluated on vertical and horizontal polarization, the worst case is Vertical polarization.

4.5 Frequency Stability Measurement

4.5.1 Limits of Frequency Stability Measurement

15.255(f) Fundamental emissions must be contained within the frequency bands specified in this section during all conditions of operation. Equipment is presumed to operate over the temperature range -20 to +50 degrees Celsius with an input voltage variation of 85% to 115% of rated input voltage, unless justification is presented to demonstrate otherwise.

4.5.2 Test Setup

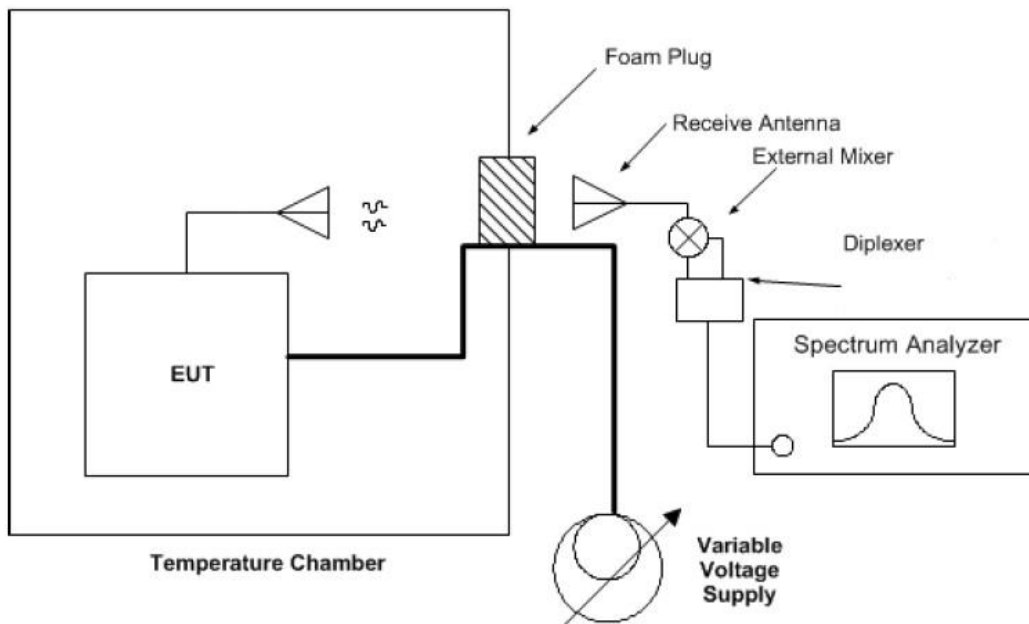

4.5.3 Test Instruments

Refer to section 4.1.2 to get information of above instrument.

4.5.4 Test Procedure

- Arrange EUT and test equipment as above setup configuration.
- With the EUT at ambient temperature and voltage source set to the EUT nominal operating voltage (100%), record the spectrum mask of the EUT emission on the spectrum analyzer.
- Vary EUT power supply between 85% and 115% of nominal, and record the frequency excursion of the EUT emission mask.
- Set the power supply to 100% nominal setting, and raise EUT operating temperature to 50 °C. Record the frequency excursion of the EUT emission mask.
- Repeat step d) at each 10 °C increment down to -20 °C

4.5.5 Deviation from Test Standard

No deviation.

4.5.6 EUT Operating Condition

Same as Item 4.3.6

4.5.7 Test Results

Frequency Stability Versus Temp.									
Operating Frequency: 60480 MHz									
TEMP. (°C)	Power Supply (Vdc)	0 Minute		2 Minutes		5 Minutes		10 Minutes	
		Measured Frequency (MHz)	Pass/Fail	Measured Frequency (MHz)	Pass/Fail	Measured Frequency (MHz)	Pass/Fail	Measured Frequency (MHz)	Pass/Fail
50	5	60479.7154	PASS	60479.7554	PASS	60479.7532	PASS	60479.7506	PASS
40	5	60479.8439	PASS	60479.8418	PASS	60479.8218	PASS	60479.8365	PASS
30	5	60479.8537	PASS	60479.8853	PASS	60479.8981	PASS	60479.8509	PASS
20	5	60479.9628	PASS	60479.9279	PASS	60479.9719	PASS	60479.9271	PASS
10	5	60480.229	PASS	60480.1887	PASS	60480.2223	PASS	60480.1829	PASS
0	5	60479.7391	PASS	60479.6894	PASS	60479.7038	PASS	60479.6977	PASS
-10	5	60480.2429	PASS	60480.2335	PASS	60480.247	PASS	60480.2618	PASS
-20	5	60480.1134	PASS	60480.1	PASS	60480.139	PASS	60480.1122	PASS

Frequency Stability Versus Voltage									
Operating Frequency: 60480 MHz									
TEMP. (°C)	Power Supply (Vdc)	0 Minute		2 Minutes		5 Minutes		10 Minutes	
		Measured Frequency (MHz)	Pass/Fail	Measured Frequency (MHz)	Pass/Fail	Measured Frequency (MHz)	Pass/Fail	Measured Frequency (MHz)	Pass/Fail
20	5.75	60479.9744	PASS	60479.9382	PASS	60479.9673	PASS	60479.9199	PASS
	5	60479.9628	PASS	60479.9279	PASS	60479.9719	PASS	60479.9271	PASS
	4.25	60479.9664	PASS	60479.9324	PASS	60479.9755	PASS	60479.9216	PASS

Frequency Stability Versus Temp.

Operating Frequency: 62640 MHz

TEMP. (°C)	Power Supply (Vdc)	0 Minute		2 Minutes		5 Minutes		10 Minutes	
		Measured Frequency (MHz)	Pass/Fail	Measured Frequency (MHz)	Pass/Fail	Measured Frequency (MHz)	Pass/Fail	Measured Frequency (MHz)	Pass/Fail
50	5	62639.8375	PASS	62639.8286	PASS	62639.8271	PASS	62639.8345	PASS
40	5	62640.3078	PASS	62640.2944	PASS	62640.2959	PASS	62640.3407	PASS
30	5	62640.0937	PASS	62640.1018	PASS	62640.1052	PASS	62640.0863	PASS
20	5	62639.7729	PASS	62639.8277	PASS	62639.8281	PASS	62639.7982	PASS
10	5	62640.2705	PASS	62640.2697	PASS	62640.2586	PASS	62640.3126	PASS
0	5	62639.8688	PASS	62639.8934	PASS	62639.8647	PASS	62639.8744	PASS
-10	5	62639.7449	PASS	62639.723	PASS	62639.729	PASS	62639.7142	PASS
-20	5	62639.8785	PASS	62639.8806	PASS	62639.9206	PASS	62639.877	PASS

Frequency Stability Versus Voltage

Operating Frequency: 62640 MHz

TEMP. (°C)	Power Supply (Vdc)	0 Minute		2 Minutes		5 Minutes		10 Minutes	
		Measured Frequency (MHz)	Pass/Fail	Measured Frequency (MHz)	Pass/Fail	Measured Frequency (MHz)	Pass/Fail	Measured Frequency (MHz)	Pass/Fail
20	5.75	62639.7667	PASS	62639.8391	PASS	62639.8346	PASS	62639.8048	PASS
	5	62639.7729	PASS	62639.8277	PASS	62639.8281	PASS	62639.7982	PASS
	4.25	62639.7787	PASS	62639.8335	PASS	62639.8293	PASS	62639.8065	PASS

5 Pictures of Test Arrangements

Please refer to the attached file (Test Setup Photo).

Appendix – Information of the Testing Laboratories

We, Bureau Veritas Consumer Products Services (H.K.) Ltd., Taoyuan Branch, were founded in 1988 to provide our best service in EMC, Radio, Telecom and Safety consultation. Our laboratories are FCC recognized accredited test firms and accredited according to ISO/IEC 17025.

If you have any comments, please feel free to contact us at the following:

Lin Kou EMC/RF Lab

Tel: 886-2-26052180

Fax: 886-2-26051924

Hsin Chu EMC/RF/Telecom Lab

Tel: 886-3-6668565

Fax: 886-3-6668323

Hwa Ya EMC/RF/Safety Lab

Tel: 886-3-3183232

Fax: 886-3-3270892

Email: service.adt@tw.bureauveritas.com

Web Site: www.bureauveritas-adt.com

The address and road map of all our labs can be found in our web site also.

--- END ---