



# TEST REPORT

## FCC PART 15.247

Report Reference No. ....: **CTL1705267011-WF-01**

Compiled by: ( position+printed name+signature)	Allen Wang (File administrators)	<u>Allen Wang</u>
Tested by: ( position+printed name+signature)	Nice Nong (Test Engineer)	<u>Nice Nong</u>
Approved by: ( position+printed name+signature)	Ivan Xie (Manager)	<u>Ivan Xie</u>

**Product Name** .....: VoIP Wireless Router

**Model/Type reference** .....: FWR9202

**List Model(s)**.....: FWR9201, FWR9200

**Trade Mark** .....: Flyingvoice

**FCC ID** .....: 2AL9D-FWR9202

**Applicant's name** .....: **Flyingvoice Network Technology Co., Ltd**

**Address of applicant** .....: Room102, 1F East, Bldg 3#, Minqi Park, Pingshan, Xili, Nanshan District, Shenzhen, China

**Test Firm** .....: **Shenzhen CTL Testing Technology Co., Ltd.**

**Address of Test Firm** .....: Floor 1-A, Baisha Technology Park, No.3011, Shaheci Road, Nanshan District, Shenzhen, China 518055

**Test specification** .....:

Standard.....: **FCC Part 15.247:** Operation within the bands 902-928 MHz, 2400-2483.5 MHz and 5725-5850 MHz.

TRF Originator .....: Shenzhen CTL Testing Technology Co., Ltd.

Master TRF .....: Dated 2011-01

**Date of Receipt**.....: June 09, 2017

**Date of Test Date**.....: June 09, 2017–July 10, 2017

**Data of Issue**.....: July 10, 2017

**Result**.....: Pass

**Shenzhen CTL Testing Technology Co., Ltd. All rights reserved.**

This publication may be reproduced in whole or in part for non-commercial purposes as long as the Shenzhen CTL Testing Technology Co., Ltd. is acknowledged as copyright owner and source of the material. Shenzhen CTL Testing Technology Co., Ltd. takes no responsibility for and will not assume liability for damages resulting from the reader's interpretation of the reproduced material due to its placement and context.

# TEST REPORT

<b>Test Report No. :</b>	<b>CTL1705267011-WF-01</b>	July 10, 2017 ----- Date of issue
--------------------------	----------------------------	---

Equipment under Test : VoIP Wireless Router

Model /Type : FWR9202, FWR9201, FWR9200

**Applicant** : **Flyingvoice Network Technology Co., Ltd**

Address : Room102, 1F East, Bldg 3#, Minqi Park, Pingshan,  
Xili, Nanshan District, Shenzhen, China

**Manufacturer** : **Flyingvoice Network Technology Co., Ltd**

Address : Room102, 1F East, Bldg 3#, Minqi Park, Pingshan,  
Xili, Nanshan District, Shenzhen, China

<b>Test result</b>	<b>Pass *</b>
--------------------	---------------

\* In the configuration tested, the EUT complied with the standards specified page 5.

The test report merely corresponds to the test sample.

It is not permitted to copy extracts of these test result without the written permission of the test laboratory.

**\*\* Modified History \*\***

Revisions	Description	Issued Data	Report No.	Remark
Version 1.0	Initial Test Report Release	2017-07-10	CTL1705267011-WF-01	Tracy Qi



## Table of Contents

Page

<b>1. SUMMARY.....</b>	<b>5</b>
1.1. TEST STANDARDS.....	5
1.2. TEST DESCRIPTION.....	5
1.3. TEST FACILITY.....	6
1.4. STATEMENT OF THE MEASUREMENT UNCERTAINTY.....	6
<b>2. GENERAL INFORMATION.....</b>	<b>7</b>
2.1. ENVIRONMENTAL CONDITIONS.....	7
2.2. GENERAL DESCRIPTION OF EUT.....	7
2.3. DESCRIPTION OF TEST MODES AND TEST FREQUENCY.....	7
2.4. EQUIPMENTS USED DURING THE TEST.....	8
2.5. RELATED SUBMITTAL(S) / GRANT (S).....	9
2.6. MODIFICATIONS.....	9
<b>3. TEST CONDITIONS AND RESULTS.....</b>	<b>10</b>
3.1. CONDUCTED EMISSIONS TEST.....	10
3.2. RADIATED EMISSIONS AND BAND EDGE.....	15
3.3. MAXIMUM CONDUCTED OUTPUT POWER.....	18
3.4. POWER SPECTRAL DENSITY.....	23
3.5. 6dB BANDWIDTH.....	28
3.6. OUT-OF-BAND EMISSIONS.....	33
3.7. ANTENNA REQUIREMENT.....	47
<b>4. TEST SETUP PHOTOS OF THE EUT.....</b>	<b>50</b>
<b>5. PHOTOS OF THE EUT.....</b>	<b>52</b>

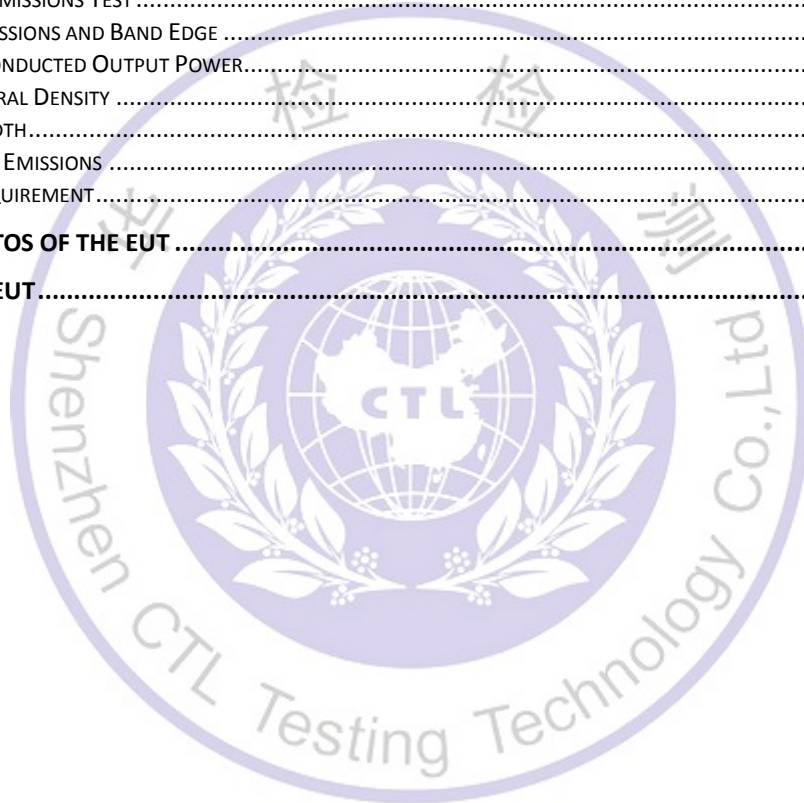

# 1. SUMMARY

## 1.1. TEST STANDARDS

The tests were performed according to following standards:

**FCC Rules Part 15.247:** Frequency Hopping, Direct Spread Spectrum and Hybrid Systems that are in operation within the bands of 902-928 MHz, 2400-2483.5 MHz, and 5725-5850 MHz

**ANSI C63.10: 2013:** American National Standard for Testing Unlicensed Wireless Devices

**ANSI C63.4: 2014:** –American National Standard for Methods of Measurement of Radio-Noise Emissions from Low-Voltage Electrical and Electronic Equipment in the Range of 9 kHz to 40GHz  
Range of 9 kHz to 40GHz

**KDB558074 D01 V03r05:** Guidance for Performing Compliance Measurements on Digital Transmission Systems (DTS) Operating Under §15.247

## 1.2. Test Description

FCC PART 15.247		
FCC Part 15.207	AC Power Conducted Emission	PASS
FCC Part 15.247(a)(2)	6dB Bandwidth	PASS
FCC Part 15.247(d)	Spurious RF Conducted Emission	PASS
FCC Part 15.247(b)	Maximum Conducted Output Power	PASS
FCC Part 15.247(e)	Power Spectral Density	PASS
FCC Part 15.109/ 15.205/ 15.209	Radiated Emissions	PASS
FCC Part 15.247(d)	Band Edge	PASS
FCC Part 15.203/15.247 (b)	Antenna Requirement	PASS



### 1.3. Test Facility

#### 1.3.1 Address of the test laboratory

Shenzhen CTL Testing Technology Co., Ltd.

Floor 1-A, Baisha Technology Park, No. 3011, Shahexi Road, Nanshan, Shenzhen 518055 China

There is one 3m semi-anechoic chamber and two line conducted labs for final test. The Test Sites meet the requirements in documents ANSI C63.4 and CISPR 22/EN 55022 requirements.

#### 1.3.2 Laboratory accreditation

The test facility is recognized, certified, or accredited by the following organizations:

##### IC Registration No.: 9618B

The 3m alternate test site of Shenzhen CTL Testing Technology Co., Ltd. EMC Laboratory has been registered by Certification and Engineer Bureau of Industry Canada for the performance of with Registration No.: 9618B on November 13, 2013.

##### FCC-Registration No.: 970318

Shenzhen CTL Testing Technology Co., Ltd. EMC Laboratory has been registered and fully described in a report filed with the (FCC) Federal Communications Commission. The acceptance letter from the FCC is maintained in our files. Registration 970318, December 19, 2013.

### 1.4. Statement of the measurement uncertainty

The data and results referenced in this document are true and accurate. The reader is cautioned that there may be errors within the calibration limits of the equipment and facilities. The measurement uncertainty was calculated for all measurements listed in this test report acc. to CISPR 16 - 4 "Specification for radio disturbance and immunity measuring apparatus and methods – Part 4: Uncertainty in EMC Measurements" and is documented in the Shenzhen CTL Testing Technology Co., Ltd. quality system acc. to DIN EN ISO/IEC 17025. Furthermore, component and process variability of devices similar to that tested may result in additional deviation. The manufacturer has the sole responsibility of continued compliance of the device.

Hereafter the best measurement capability for CTL laboratory is reported:

Test	Measurement Uncertainty	Notes
Transmitter power conducted	±0.57 dB	(1)
Transmitter power Radiated	±2.20 dB	(1)
Conducted spurious emission 9KHz-40 GHz	±2.20 dB	(1)
Occupied Bandwidth	±0.01ppm	(1)
Radiated Emission 30~1000MHz	±4.10dB	(1)
Radiated Emission Above 1GHz	±4.32dB	(1)
Conducted Disturbance0.15~30MHz	±3.20dB	(1)

- (1) This uncertainty represents an expanded uncertainty expressed at approximately the 95% confidence level using a coverage factor of k=2.

## 2. GENERAL INFORMATION

### 2.1. Environmental conditions

During the measurement the environmental conditions were within the listed ranges:

Normal Temperature:	25°C
Relative Humidity:	55 %
Air Pressure:	101 kPa

### 2.2. General Description of EUT

Product Name:	VoIP Wireless Router
Model/Type reference:	FWR9202
Power supply:	AC 120V/60Hz
Adapter 1 information:	Model: S18B72-120A150-C4 Input: 100-240V~, 50/60Hz, 0.7A Max Output: 12V---1.5A
Adapter 2 information:	Model: S12B22-120A100-C4 Input: 100-240V~, 50/60Hz, 0.5A Max Output: 12V---1A
<b>WIFI :</b>	802.11b; 802.11g SISO mode only /802.11n(H20); 802.11n(H40) MIMO mode only
Supported type:	802.11b/802.11g/802.11n(H20)/802.11n(H40)
Modulation:	802.11b: DSSS 802.11g/802.11n(H20)/802.11n(H40): OFDM
Operation frequency:	802.11b/802.11g/802.11n(H20): 2412MHz~2462MHz 802.11n(H40): 2422MHz~2452MHz
Channel number:	802.11b/802.11g/802.11n(H20): 11 802.11n(H40): 7
Channel separation:	5MHz
Antenna type:	Internal antenna 2T2R
Antenna gain:	2.5dBi

NOTE: Directional gain of WIFI MIMO mode =  $2.5 + 10 \log 2 = 5.51 \text{dBi}$

### 2.3. Description of Test Modes and Test Frequency

The Applicant provides communication tools software to control the EUT for staying in continuous transmitting (Duty Cycle more than 98%) and receiving mode for testing.

There are 11 channels provided to the EUT and Channel 01/06/11 were selected for WIFI test.

#### Operation Frequency WIFI :

Channel	Frequency(MHz)	Channel	Frequency(MHz)
<b>1</b>	<b>2412</b>	8	2447
2	2417	9	2452
3	2422	10	2457
4	2427	<b>11</b>	<b>2462</b>
5	2432		
<b>6</b>	<b>2437</b>		
7	2442		

Note: The line display in grey were the channel selected for testing

**Data Rate Used:**

Preliminary tests were performed in different data rate to find the worst radiated emission. The data rate shown in the table below is the worst-case rate with respect to the specific test item. Investigation has been done on all the possible configurations for searching the worst cases. The following table is a list of the test modes shown in this test report.

Test Items	Mode	Data Rate	Channel
Maximum Conducted Output Power Power Spectral Density 6dB Bandwidth Spurious RF conducted emission Radiated Emission 9kHz~1GHz& Radiated Emission 1GHz~10th Harmonic	11b/DSSS	1 Mbps	1/6/11
	11g/OFDM	6 Mbps	1/6/11
	11n(20MHz)/OFDM	6.5Mbps	1/6/11
	11n(40MHz)/OFDM	13.5Mbps	3/6/9
Band Edge	11b/DSSS	1 Mbps	1/11
	11g/OFDM	6 Mbps	1/11
	11n(20MHz)/OFDM	6.5Mbps	1/11
	11n(40MHz)/OFDM	13.5Mbps	3/9

**2.4. Equipments Used during the Test**

Test Equipment	Manufacturer	Model No.	Serial No.	Calibration Date	Calibration Due Date
LISN	R&S	ENV216	3560.6550.1 2	2017/05/20	2018/05/19
LISN	R&S	ESH2-Z5	860014/010	2017/05/20	2018/05/19
Bilog Antenna	Sunol Sciences Corp.	JB1	A061713	2017/05/20	2018/05/19
EMI Test Receiver	R&S	ESCI	103710	2017/05/20	2018/05/19
Spectrum Analyzer	Agilent	E4407B	MY41440676	2017/05/20	2018/05/19
Spectrum Analyzer	Agilent	N9020	US46220290	2017/05/20	2018/05/19
Power Meter	Anritsu	ML2487B	110553	2017/05/20	2018/05/19
Power Sensor	Anritsu	MA2411B	100345	2017/05/20	2018/05/19
Controller	EM Electronics	Controller EM 1000	N/A	2017/05/20	2018/05/19
Horn Antenna	Sunol Sciences Corp.	DRH-118	A062013	2017/05/20	2018/05/19
Active Loop Antenna	SCHWARZBECK	FMZB1519	1519-037	2017/05/20	2018/05/19
Amplifier	Agilent	8349B	3008A02306	2017/05/20	2018/05/19
Amplifier	Agilent	8447D	2944A10176	2017/05/20	2018/05/19
Temperature/Humidity Meter	Gangxing	CTH-608	02	2017/05/20	2018/05/19
High-Pass Filter	K&L	9SH10-2700/X1 2750-O/O	N/A	2017/05/20	2018/05/19



High-Pass Filter	K&L	41H10-1375/U1 2750-O/O	N/A	2017/05/20	2018/05/19
Coaxial Cables	HUBER+SUHNER	SUCOFLEX 104PEA-10M	10m	2017/05/20	2018/05/19
Coaxial Cables	HUBER+SUHNER	SUCOFLEX 104PEA-3M	3m	2017/05/20	2018/05/19
Coaxial Cables	HUBER+SUHNER	SUCOFLEX 104PEA-3M	3m	2017/05/20	2018/05/19
RF Cable	Megalon	RF-A303	N/A	2017/05/20	2018/05/19

The calibration interval was one year

## 2.5. Related Submittal(s) / Grant (s)

This submittal(s) (test report) is intended to comply with Section 15.247 of the FCC Part 15, Subpart C Rules.

## 2.6. Modifications

No modifications were implemented to meet testing criteria.

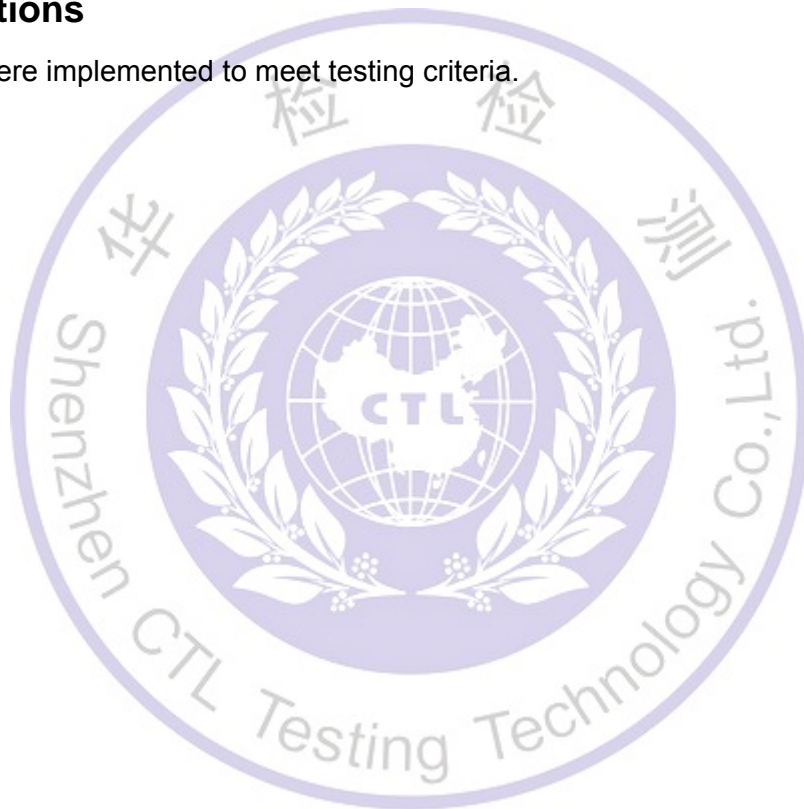

### 3. TEST CONDITIONS AND RESULTS

#### 3.1. Conducted Emissions Test

##### LIMIT

FCC CFR Title 47 Part 15 Subpart C Section 15.207

Frequency range (MHz)	Limit (dBuV)	
	Quasi-peak	Average
0.15-0.5	66 to 56*	56 to 46*
0.5-5	56	46
5-30	60	50

\* Decreases with the logarithm of the frequency.

##### TEST CONFIGURATION



##### TEST PROCEDURE

1. The equipment was set up as per the test configuration to simulate typical actual usage per the user's manual. The EUT is a tabletop system; a wooden table with a height of 0.8 meters is used and is placed on the ground plane as per ANSI C63.10:2013.
2. Support equipment, if needed, was placed as per ANSI C63.10:2013.
3. All I/O cables were positioned to simulate typical actual usage as per ANSI C63.10:2013.
4. The adapter received AC120V/60Hz power through a Line Impedance Stabilization Network (LISN) which supplied power source and was grounded to the ground plane.
5. All support equipments received AC power from a second LISN, if any.
6. The EUT test program was started. Emissions were measured on each current carrying line of the EUT using a spectrum Analyzer / Receiver connected to the LISN powering the EUT. The LISN has two monitoring points: Line 1 (Hot Side) and Line 2 (Neutral Side). Two scans were taken: one with Line 1 connected to Analyzer / Receiver and Line 2 connected to a 50 ohm load; the second scan had Line 1 connected to a 50 ohm load and Line 2 connected to the Analyzer / Receiver.
7. Analyzer / Receiver scanned from 150 KHz to 30MHz for emissions in each of the test modes.
8. During the above scans, the emissions were maximized by cable manipulation.

**TEST RESULTS**

**Adapter 1:**

Remark:802.11b/802.11g/802.11n(H20)/802.11n(H40) mode all have been tested ,only worse case of 802.11b High Channel was reported.

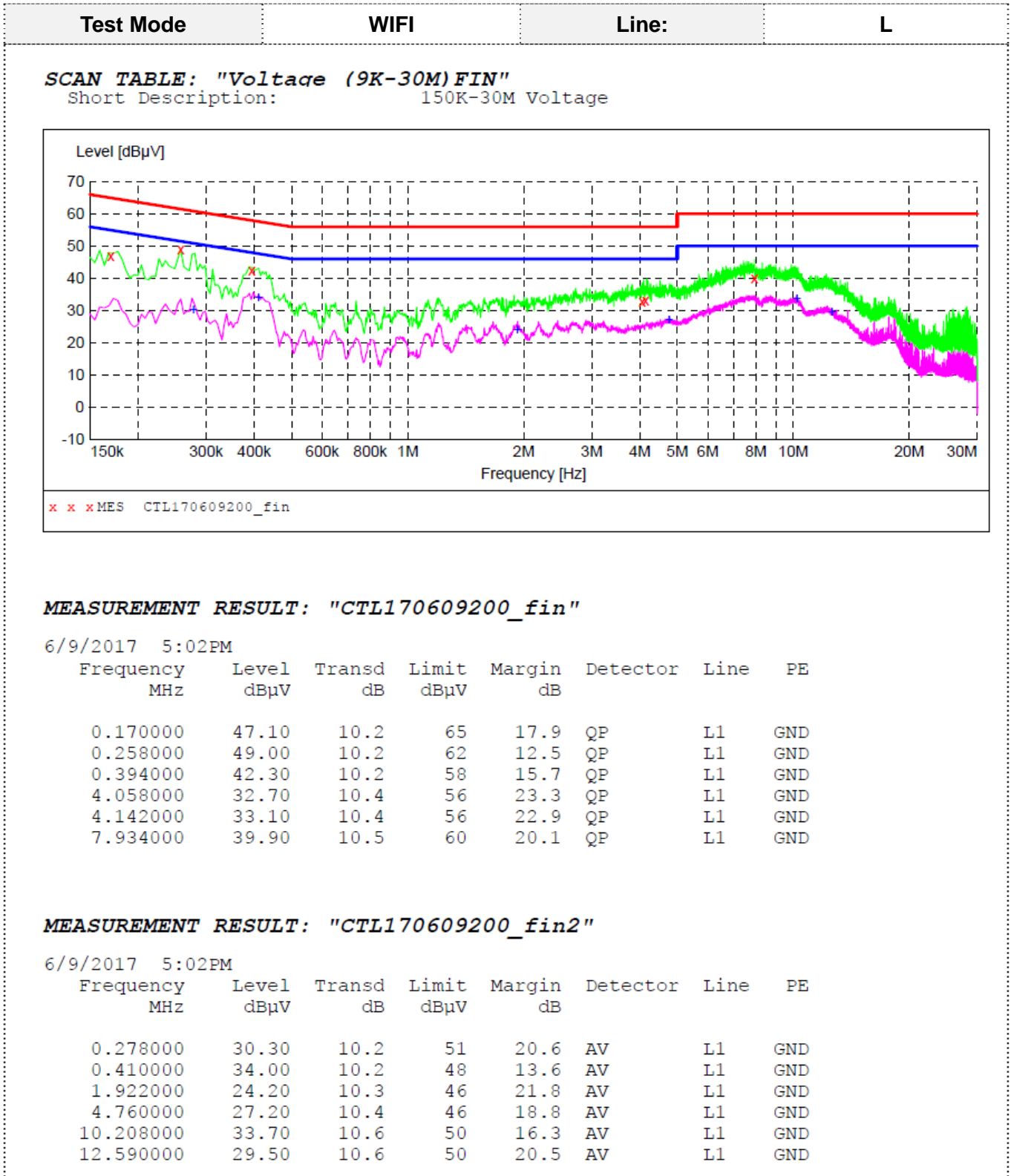

Test Mode	WIFI	Line:	N
-----------	------	-------	---

**SCAN TABLE: "Voltage (9K-30M)FIN"**  
 Short Description: 150K-30M Voltage

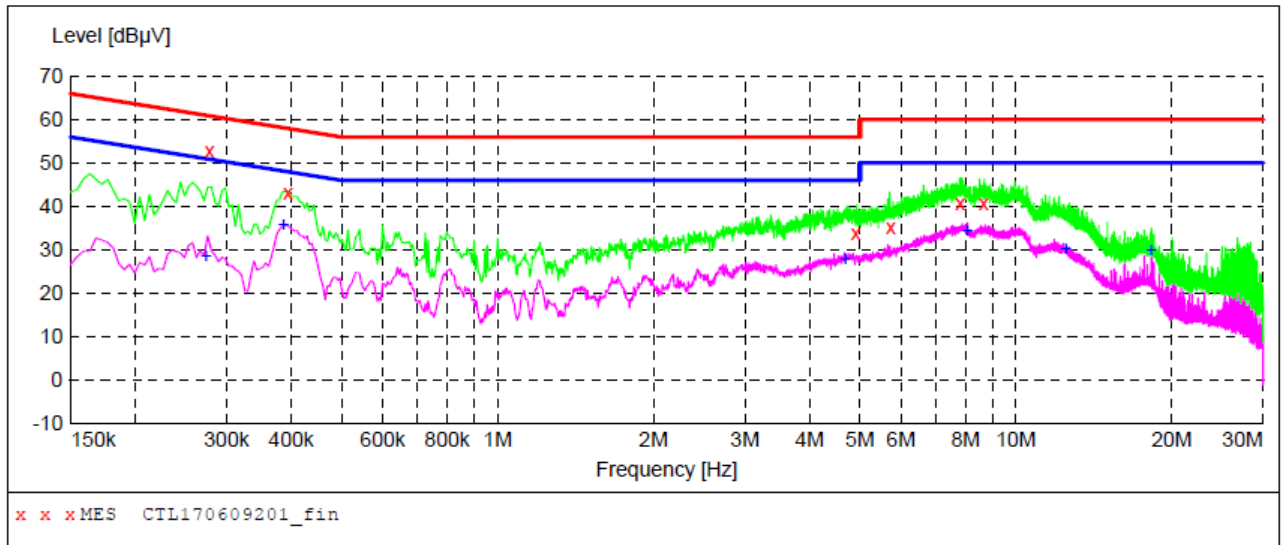

**MEASUREMENT RESULT: "CTL170609201\_fin"**

6/9/2017 5:07PM

Frequency MHz	Level dBµV	Transd dB	Limit dBµV	Margin dB	Detector	Line	PE
0.278000	52.80	10.2	61	8.1	QP	N	GND
0.394000	43.00	10.2	58	15.0	QP	N	GND
4.910000	33.80	10.4	56	22.2	QP	N	GND
5.738000	35.30	10.4	60	24.7	QP	N	GND
7.808000	40.80	10.5	60	19.2	QP	N	GND
8.660000	40.70	10.6	60	19.3	QP	N	GND

**MEASUREMENT RESULT: "CTL170609201\_fin2"**

6/9/2017 5:07PM

Frequency MHz	Level dBµV	Transd dB	Limit dBµV	Margin dB	Detector	Line	PE
0.274000	28.60	10.2	51	22.4	AV	N	GND
0.386000	35.90	10.2	48	12.2	AV	N	GND
4.688000	27.80	10.4	46	18.2	AV	N	GND
8.066000	34.30	10.5	50	15.7	AV	N	GND
12.476000	30.40	10.6	50	19.6	AV	N	GND
18.242000	29.90	10.9	50	20.1	AV	N	GND

**Adapter 2:**

Remark:802.11b/802.11g/802.11n(H20)/802.11n(H40) mode all have been tested ,only worse case of 802.11b High Channel was reported.

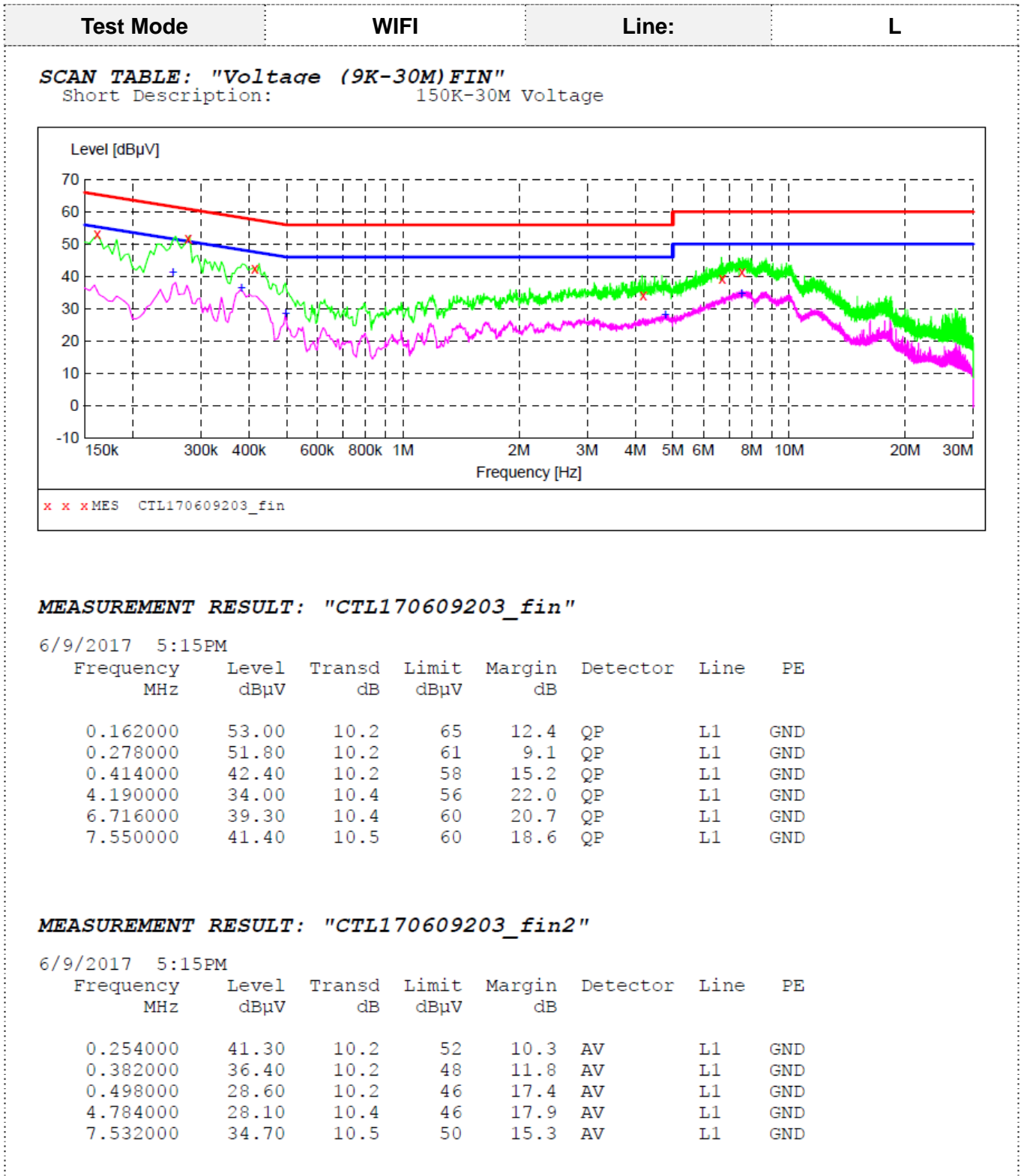



Test Mode	WIFI	Line:	N
-----------	------	-------	---

**SCAN TABLE: "Voltage (9K-30M) FIN"**  
 Short Description: 150K-30M Voltage

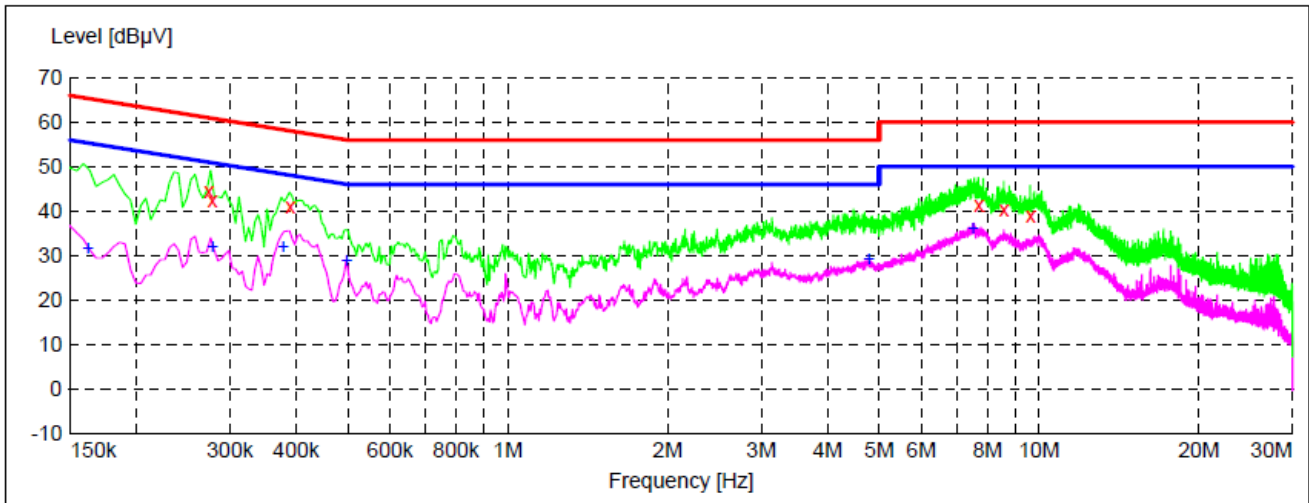

x x x MES CTL170609202\_fin

**MEASUREMENT RESULT: "CTL170609202\_fin"**

6/9/2017 5:12PM

Frequency MHz	Level dBµV	Transd dB	Limit dBµV	Margin dB	Detector	Line	PE
0.274000	44.50	10.2	61	16.5	QP	N	GND
0.278000	42.40	10.2	61	18.5	QP	N	GND
0.390000	41.10	10.2	58	17.0	QP	N	GND
7.700000	41.40	10.5	60	18.6	QP	N	GND
8.588000	40.50	10.6	60	19.5	QP	N	GND
9.638000	38.80	10.6	60	21.2	QP	N	GND

**MEASUREMENT RESULT: "CTL170609202\_fin2"**

6/9/2017 5:12PM

Frequency MHz	Level dBµV	Transd dB	Limit dBµV	Margin dB	Detector	Line	PE
0.162000	31.80	10.2	55	23.6	AV	N	GND
0.278000	32.10	10.2	51	18.8	AV	N	GND
0.378000	31.90	10.2	48	16.4	AV	N	GND
0.498000	28.90	10.2	46	17.1	AV	N	GND
4.778000	29.20	10.4	46	16.8	AV	N	GND
7.502000	36.30	10.5	50	13.7	AV	N	GND

## 3.2. Radiated Emissions and Band Edge

### Limit

For intentional device, according to § 15.209(a), the general requirement of field strength of radiated emission out of authorized band shall not exceed the following table at a 3 meters measurement distance.

In addition, radiated emissions which fall in the restricted bands, as defined in §15.205(a), must also comply with the radiated emission limits specified in §15.209(a)

Radiated emission limits

Frequency (MHz)	Distance (Meters)	Radiated (dB $\mu$ V/m)	Radiated ( $\mu$ V/m)
0.009-0.49	3	$20\log(2400/F(\text{KHz}))+40\log(300/3)$	$2400/F(\text{KHz})$
0.49-1.705	3	$20\log(24000/F(\text{KHz}))+40\log(30/3)$	$24000/F(\text{KHz})$
1.705-30	3	$20\log(30)+40\log(30/3)$	30
30-88	3	40.0	100
88-216	3	43.5	150
216-960	3	46.0	200
Above 960	3	54.0	500

### TEST CONFIGURATION

(A) Radiated Emission Test Set-Up, Frequency Below 30MHz

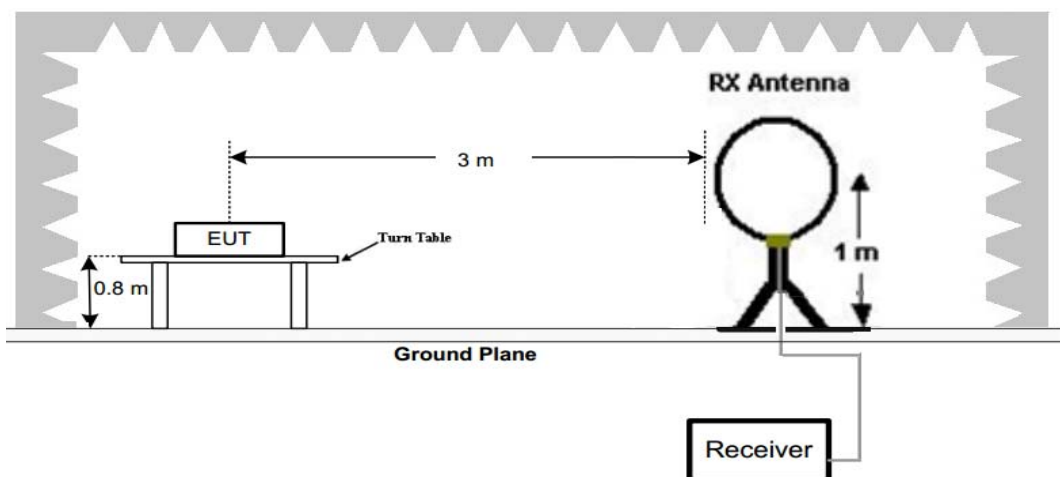

(B) Radiated Emission Test Set-Up, Frequency below 1000MHz

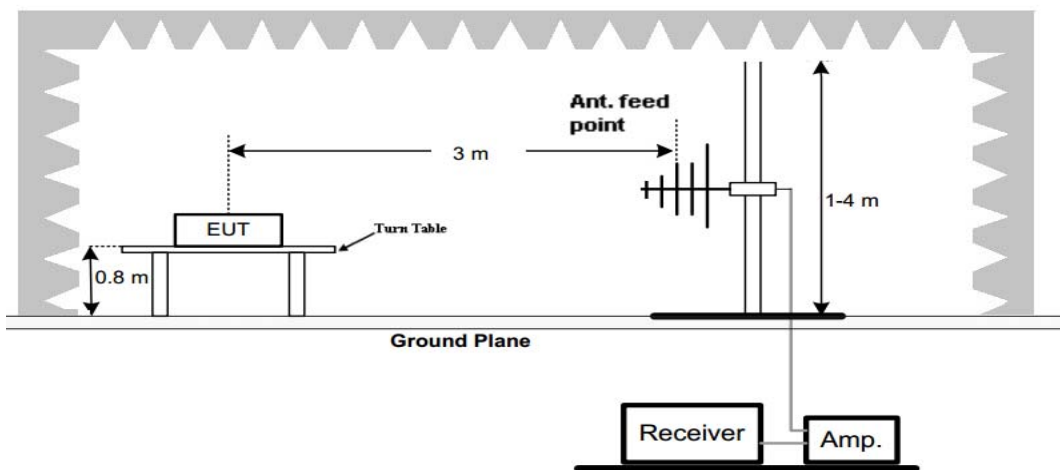

(C) Radiated Emission Test Set-Up, Frequency above 1000MHz

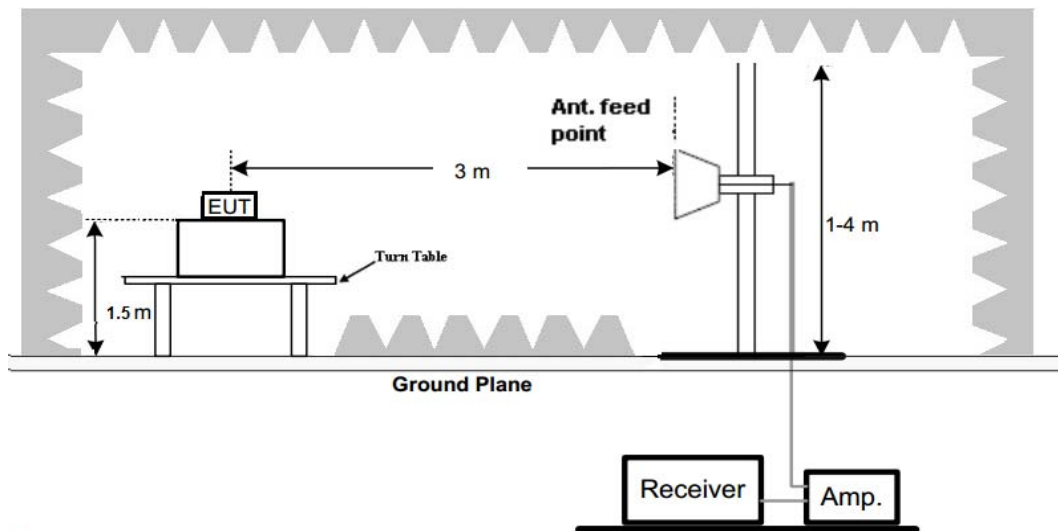

### Test Procedure

1. Below 1GHz measurement the EUT is placed on a turntable which is 0.8m above ground plane, and above 1GHz measurement EUT was placed on a low permittivity and low loss tangent turn table which is 1.5m above ground plane.
2. Maximum procedure was performed by raising the receiving antenna from 1m to 4m and rotating the turn table from 0° to 360° to acquire the highest emissions from EUT
3. And also, each emission was to be maximized by changing the polarization of receiving antenna both horizontal and vertical.
4. Repeat above procedures until all frequency measurements have been completed.

### TEST RESULTS

Remark:

1. All three channels (lowest/middle/highest) of each mode were measured below 1GHz and recorded worst case at 802.11b low channel.
2. All three channels (lowest/middle/highest) of each mode were measured above 1GHz and recorded worst case at 802.11b mode.
3. Radiated emission test from 9 KHz to 10th harmonic of fundamental was verified, and no emission found except system noise floor in 9 KHz to 30MHz and not recorded in this report.

For 30MHz-1GHz

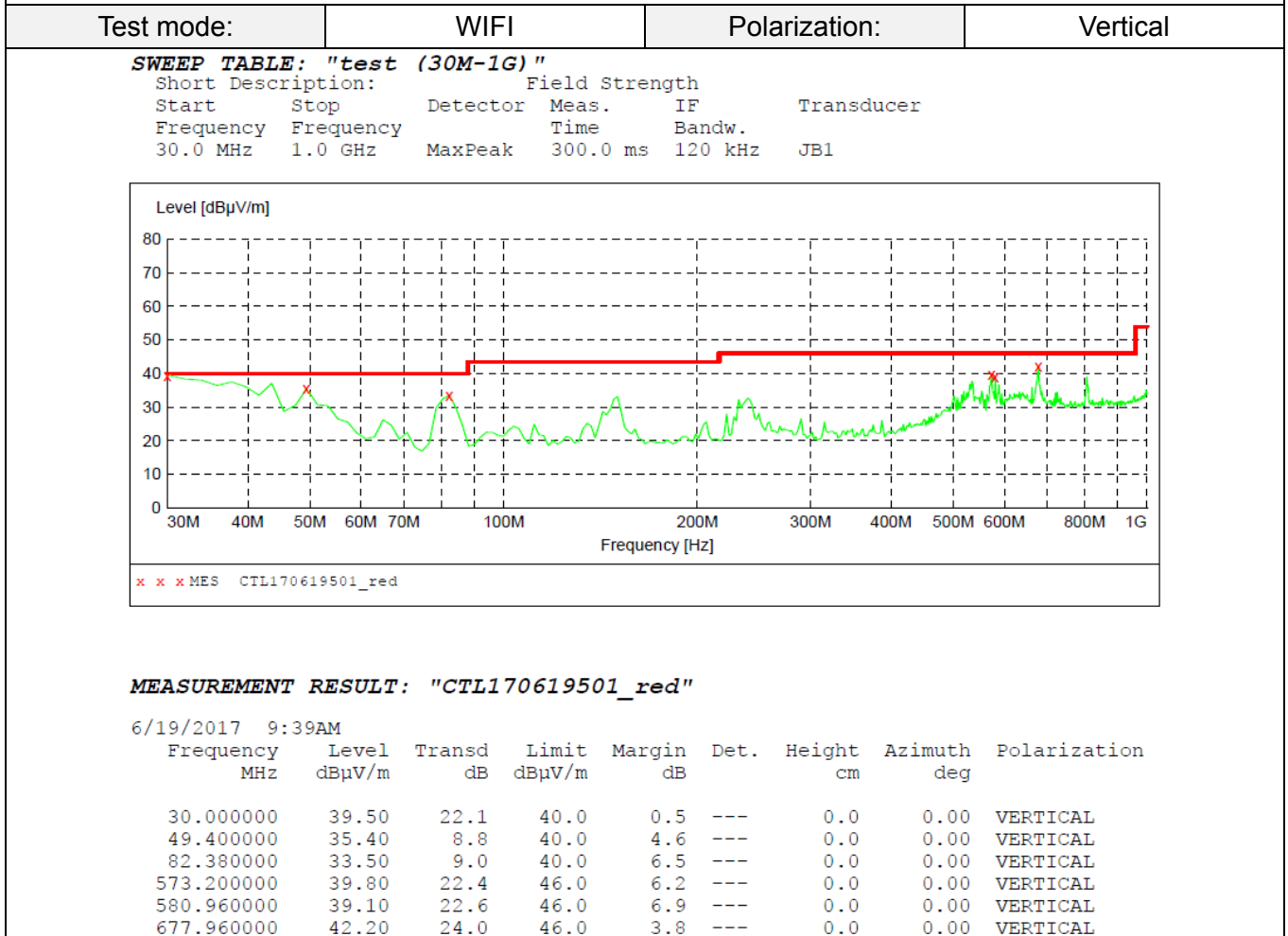
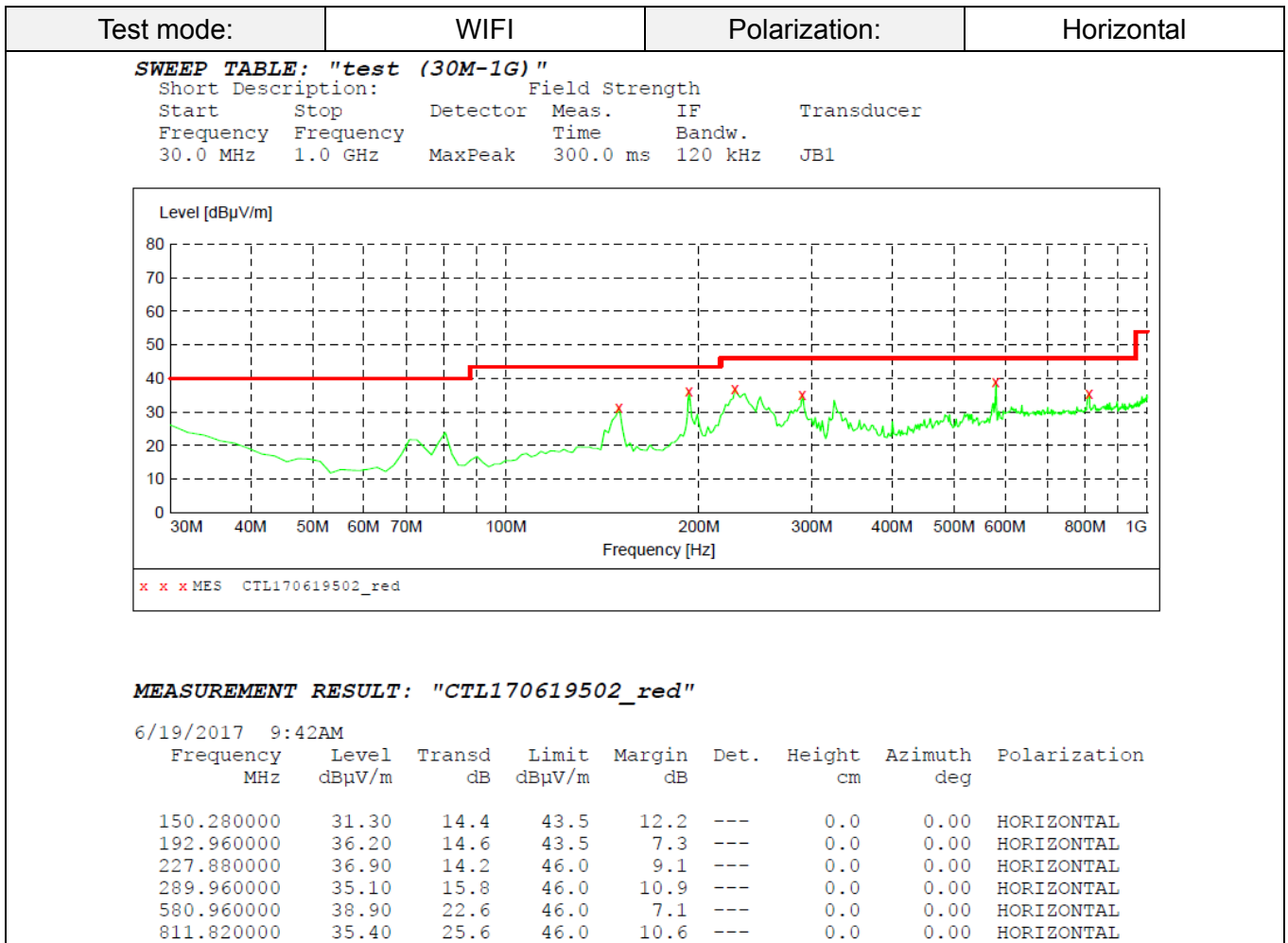

## For 1GHz to 25GHz

## 802.11b Mode (above 1GHz)

Note: 802.11b&gSISO mode /802.11n (H20/H40) MIMO mode all have been tested, only worse case 802.11b ant1 is reported

Frequency(MHz):			2412		Polarity:			HORIZONTAL	
Frequency (MHz)	Emission Level (dBuV/m)		Limit (dBuV/m)	Margin (dB)	Raw Value (dBuV)	Antenna Factor (dB/m)	Cable Factor (dB)	Pre-amplifier (dB)	Correction Factor (dB/m)
4824.00	57.64	PK	74	16.36	53.09	33.52	6.92	35.89	4.55
4824.00	51.15	AV	54	2.85	46.6	33.52	6.92	35.89	4.55
5135.15	48.01	PK	74	25.99	40.81	34.38	7.10	34.28	7.20
5135.15	--	AV	54	--	--	--	--	--	--
7236.00	50.27	PK	74	23.73	39.00	37.1	9.19	35.02	11.27
7236.00	--	AV	54	--	--	--	--	--	--

Frequency(MHz):			2412		Polarity:			VERTICAL	
Frequency (MHz)	Emission Level (dBuV/m)		Limit (dBuV/m)	Margin (dB)	Raw Value (dBuV)	Antenna Factor (dB/m)	Cable Factor (dB)	Pre-amplifier (dB)	Correction Factor (dB/m)
4824.00	58.04	PK	74	15.96	53.49	33.52	6.92	35.89	4.55
4824.00	50.62	AV	54	3.38	46.07	33.52	6.92	35.89	4.55
5135.15	48.47	PK	74	25.53	41.27	34.38	7.10	34.28	7.20
5135.15	--	AV	54	--	--	--	--	--	--
7236.00	51.07	PK	74	22.93	39.80	37.1	9.19	35.02	11.27
7236.00	--	AV	54	--	--	--	--	--	--

Frequency(MHz):			2437		Polarity:			HORIZONTAL	
Frequency (MHz)	Emission Level (dBuV/m)		Limit (dBuV/m)	Margin (dB)	Raw Value (dBuV)	Antenna Factor (dB/m)	Cable Factor (dB)	Pre-amplifier (dB)	Correction Factor (dB/m)
4874.00	59.07	PK	74	14.93	52.83	33.59	6.95	34.3	6.24
4874.00	52.41	AV	54	1.59	46.17	33.59	6.95	34.3	6.24
5233.50	49.14	PK	74	24.86	41.54	34.56	7.15	34.11	7.60
5233.50	--	AV	54	--	--	--	--	--	--
7311.00	50.67	PK	74	23.33	39.01	37.44	9.22	35	11.66
7311.00	--	AV	54	--	--	--	--	--	--

Frequency(MHz):			2437		Polarity:			VERTICAL	
Frequency (MHz)	Emission Level (dBuV/m)		Limit (dBuV/m)	Margin (dB)	Raw Value (dBuV)	Antenna Factor (dB/m)	Cable Factor (dB)	Pre-amplifier (dB)	Correction Factor (dB/m)
4874.00	58.85	PK	74	15.15	52.51	33.59	6.95	34.2	6.34
4874.00	51.41	AV	54	2.59	45.07	33.59	6.95	34.2	6.34
5233.50	48.99	PK	74	25.01	42.09	34.07	7.05	34.22	6.90
5233.50	--	AV	54	--	--	--	--	--	--
7311.00	49.73	PK	74	24.27	38.07	37.44	9.22	35	11.66
7311.00	--	AV	54	--	--	--	--	--	--



Frequency(MHz):			2462		Polarity:			HORIZONTAL	
Frequency (MHz)	Emission Level (dBuV/m)		Limit (dBuV/m)	Margin (dB)	Raw Value (dBuV)	Antenna Factor (dB/m)	Cable Factor (dB)	Pre- amplifier (dB)	Correction Factor (dB/m)
4924.00	58.08	PK	74	15.92	53.55	33.71	6.98	35.91	4.78
4924.00	50.74	AV	54	3.26	43.73	33.71	6.98	35.91	4.78
5235.50	47.05	PK	74	26.95	41.24	34.34	7.09	34.27	7.17
5235.50	--	AV	54	--	--	--	--	--	--
7386.00	49.14	PK	74	24.86	37.4	37.61	9.25	34.98	11.88
7386.00	--	AV	54	--	--	--	--	--	--

Frequency(MHz):			2462		Polarity:			VERTICAL	
Frequency (MHz)	Emission Level (dBuV/m)		Limit (dBuV/m)	Margin (dB)	Raw Value (dBuV)	Antenna Factor (dB/m)	Cable Factor (dB)	Pre- amplifier (dB)	Correction Factor (dB/m)
4924.00	59.64	PK	74	14.36	54.86	33.71	6.98	35.91	4.78
4924.00	51.91	AV	54	2.09	47.13	33.71	6.98	35.91	4.78
5235.50	48.88	PK	74	25.12	41.71	34.34	7.09	34.27	7.17
5235.50	--	AV	54	--	--	--	--	--	--
7386.00	50.39	PK	74	23.61	38.51	37.61	9.25	34.98	11.88
7386.00	--	AV	54	--	--	--	--	--	--

## REMARKS:

1. Emission level (dBuV/m) =Raw Value (dBuV)+Correction Factor (dB/m)
2. Correction Factor (dB/m) = Antenna Factor (dB/m)+Cable Factor (dB)-Pre-amplifier Factor
3. Margin value = Limit value- Emission level.
4. -- Mean the PK detector measured value is below average limit.
5. The other emission levels were very low against the limit.
6. RBW1MHz VBW3MHz Peak detector is for PK value; RMS detector is for AV value.

**Results of Band Edges Test (Radiated)**

Note: 802.11b&gSISO mode /802.11n (H20/H40) MIMO mode all have been tested, only worse case 802.11b ant1 is reported

Frequency(MHz):			2412		Polarity:			HORIZONTAL	
Frequency (MHz)	Emission Level (dBuV/m)		Limit (dBuV/m)	Margin (dB)	Raw Value (dBuV)	Antenna Factor (dB/m)	Cable Factor (dB)	Pre-amplifier (dB)	Correction Factor (dB/m)
2412.00	119.04	PK	--	--	85.65	28.78	4.61	0	33.39
2412.00	110.32	AV	--	--	76.93	28.78	4.61	0	33.39
2340.75	43.46	PK	74	30.54	10.38	28.52	4.56	0	33.08
2340.75	--	AV	54	--	--	--	--	--	--
2390.00	58.87	PK	74	15.13	25.55	28.72	4.60	0	33.32
2390.00	51.06	AV	54	2.94	17.74	28.72	4.60	0	33.32
2400.00	60.32	PK	74	13.68	26.93	28.78	4.61	0	33.39
2400.00	52.44	AV	54	1.56	19.05	28.78	4.61	0	33.39

Frequency(MHz):			2412		Polarity:			VERTICAL	
Frequency (MHz)	Emission Level (dBuV/m)		Limit (dBuV/m)	Margin (dB)	Raw Value (dBuV)	Antenna Factor (dB/m)	Cable Factor (dB)	Pre-amplifier (dB)	Correction Factor (dB/m)
2412.00	120.04	PK	--	--	86.65	28.78	4.61	0	33.39
2412.00	111.76	AV	--	--	78.37	28.78	4.61	0	33.39
2340.75	44.18	PK	74	29.82	11.1	28.52	4.56	0	33.08
2340.75	--	AV	54	--	--	--	--	--	--
2390.00	59.08	PK	74	14.92	25.76	28.72	4.60	0	33.32
2390.00	51.27	AV	54	2.73	17.95	28.72	4.60	0	33.32
2400.00	60.73	PK	74	13.27	27.34	28.78	4.61	0	33.39
2400.00	52.45	AV	54	1.55	19.06	28.78	4.61	0	33.39

Frequency(MHz):			2462		Polarity:			HORIZONTAL	
Frequency (MHz)	Emission Level (dBuV/m)		Limit (dBuV/m)	Margin (dB)	Raw Value (dBuV)	Antenna Factor (dB/m)	Cable Factor (dB)	Pre-amplifier (dB)	Correction Factor (dB/m)
2462.00	120.74	PK	--	--	87.12	28.92	4.7	0	33.62
2462.00	111.65	AV	--	--	78.03	28.92	4.7	0	33.62
2483.50	43.91	PK	74	30.09	10.28	28.93	4.7	0	33.63
2490.75	--	AV	54	--	--	--	--	--	--
2490.75	43.07	PK	74	30.93	9.43	28.94	4.71	0	33.64
2486.75	--	AV	54	--	--	--	--	--	--
2500.00	43.49	PK	74	30.51	9.81	28.96	4.72	0	33.68
2500.00	--	AV	54	--	--	--	--	--	--

Frequency(MHz):			2462		Polarity:			VERTICAL	
Frequency (MHz)	Emission Level (dBuV/m)		Limit (dBuV/m)	Margin (dB)	Raw Value (dBuV)	Antenna Factor (dB/m)	Cable Factor (dB)	Pre-amplifier (dB)	Correction Factor (dB/m)
2462.00	119.66	PK	--	--	86.04	28.92	4.7	0	33.62
2462.00	110.42	AV	--	--	76.8	28.92	4.7	0	33.62
2483.50	43.89	PK	74	30.11	10.26	28.93	4.7	0	33.63
2483.50	--	AV	54	--	--	--	--	--	--
2490.75	43.07	PK	74	30.93	9.43	28.94	4.71	0	33.64
2490.75	--	AV	54	--	--	--	--	--	--
2500.00	42.89	PK	74	31.11	9.21	28.96	4.72	0	33.68
2500.00	--	AV	54	--	--	--	--	--	--

## REMARKS:

1. Emission level (dBuV/m) =Raw Value (dBuV)+Correction Factor (dB/m)
2. Correction Factor (dB/m) = Antenna Factor (dB/m)+Cable Factor (dB)-Pre-amplifier Factor
3. Margin value = Limit value- Emission level.
4. -- Mean the PK detector measured value is below average limit.
5. The other emission levels were very low against the limit.
6. RBW1MHz VBW3MHz Peak detector is for PK value; RMS detector is for AV value.

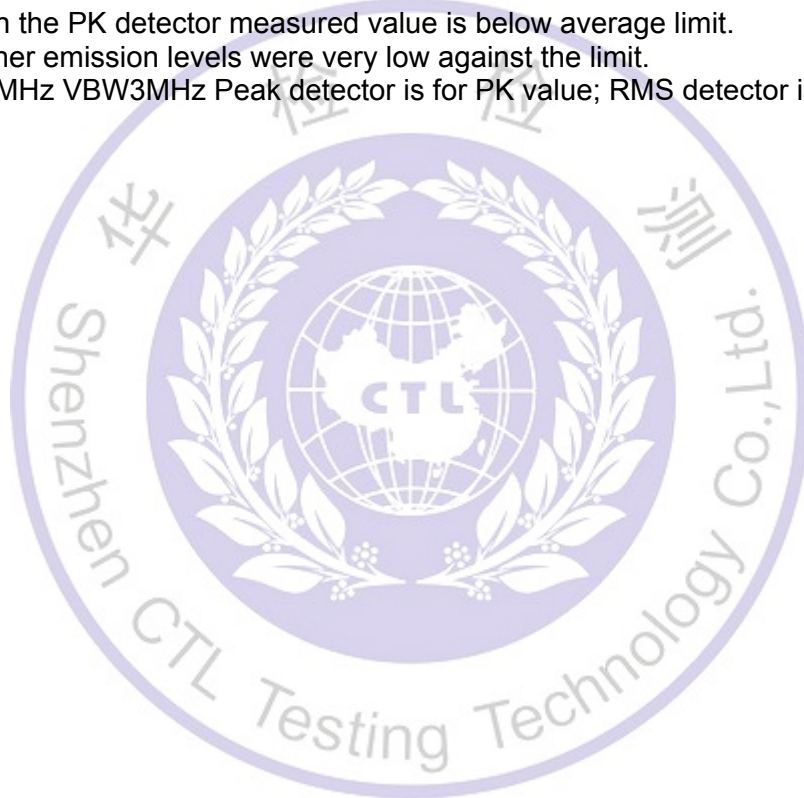

### 3.3. Maximum Conducted Output Power

#### Limit

The Maximum Peak Output Power Measurement is 30dBm.

#### Test Procedure

Remove the antenna from the EUT and then connect a low loss RF cable from the antenna port to the power sensor.

#### Test Configuration

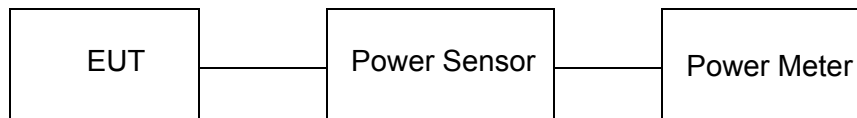

#### Test Results

Type	Channel	PK Output power Ant1 (dBm)	PK Output power Ant2 (dBm)	Output power Total (dBm)	Limit (dBm)	Result
802.11b	01	23.38	24.73	/	30.00	Pass
	06	23.77	24.43	/		
	11	24.63	23.74	/		
802.11g	01	22.75	23.36	/	30.00	Pass
	06	23.02	22.86	/		
	11	23.59	22.17	/		
802.11n(HT20) MIMO	01	22.58	22.90	25.75	30.00	Pass
	06	22.75	22.46	25.62		
	11	23.43	21.54	25.60		
802.11n(HT40) MIMO	03	22.10	22.26	25.19	30.00	Pass
	06	22.36	21.95	25.17		
	09	22.65	21.55	25.15		

Note: 1.The test results including the cable lose.

### 3.4. Power Spectral Density

#### Limit

For digitally modulated systems, the power spectral density conducted from the intentional radiator to the antenna shall not be greater than 8 dBm in any 3 kHz band during any time interval of continuous transmission.

#### Test Procedure

1. Use this procedure when the maximum peak conducted output power in the fundamental emission is used to demonstrate compliance.
2. Set the RBW  $\geq$  3 kHz.
3. Set the VBW  $\geq$  3 $\times$  RBW.
4. Set the span to 1.5 times the DTS channel bandwidth.
5. Detector = peak.
6. Sweep time = auto couple.
7. Trace mode = max hold.
8. Allow trace to fully stabilize.
9. Use the peak marker function to determine the maximum power level.
10. If measured value exceeds limit, reduce RBW (no less than 3 kHz) and repeat.
11. The resulting peak PSD level must be 8dBm.

#### Test Configuration



#### Test Results

Type	Channel	Power Spectral Density Ant1 (dBm/3KHz)	Power Spectral Density Ant2 (dBm/3KHz)	Power Spectral Density Total (dBm/3KHz)	Limit (dBm/3KHz)	Result
802.11b	01	-5.794	-4.316	/	8.00	Pass
	06	-3.924	-4.771	/		
	11	-4.729	6.528	/		
802.11g	01	-12.095	-12.675	/	8.00	Pass
	06	-12.808	-11.700	/		
	11	-11.606	-13.937	/		
802.11n(HT20) MIMO	01	-12.178	-12.444	-9.299	8.00	Pass
	06	-12.425	-13.003	-9.694		
	11	-11.865	-12.957	-9.366		
802.11n(HT40) MIMO	03	-16.442	-16.090	-13.252	8.00	Pass
	06	-15.860	-15.758	-12.798		
	09	-15.034	-16.605	-12.739		

Test plot as follows:



Ant 1

802.11b

802.11g

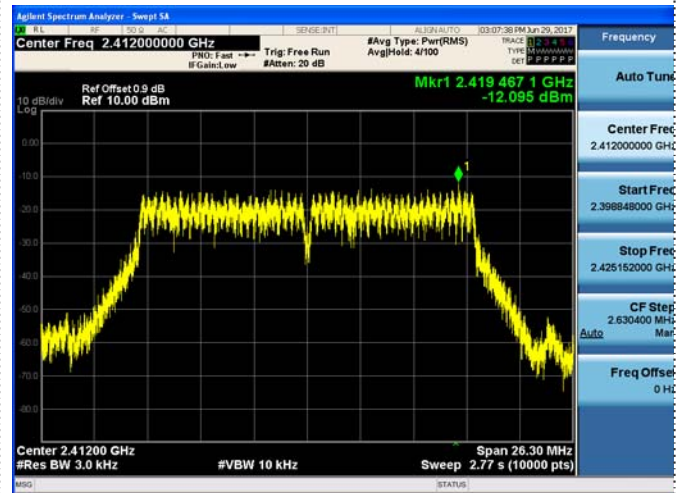
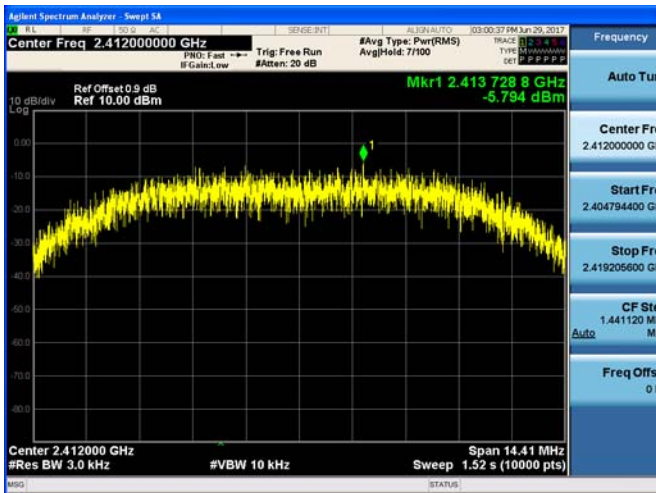

CH01

CH01

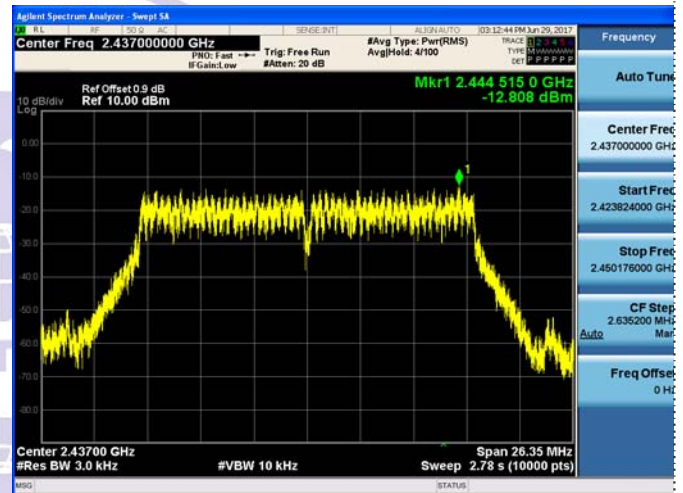
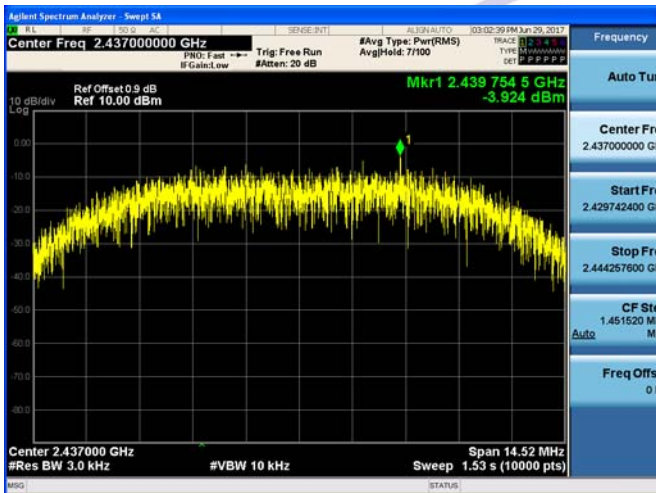

CH06

CH06

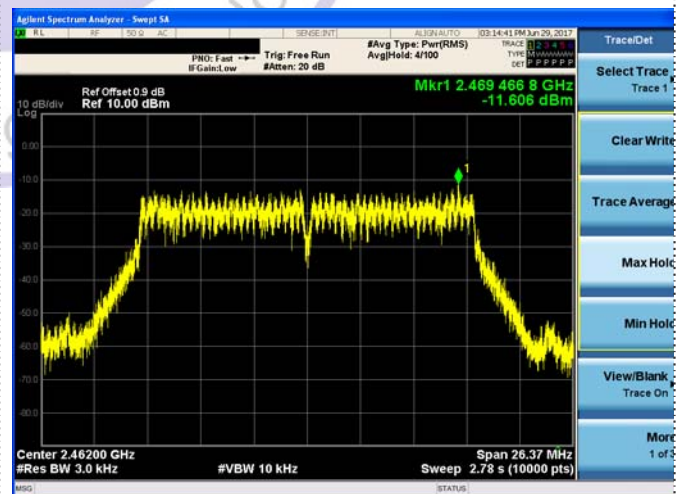
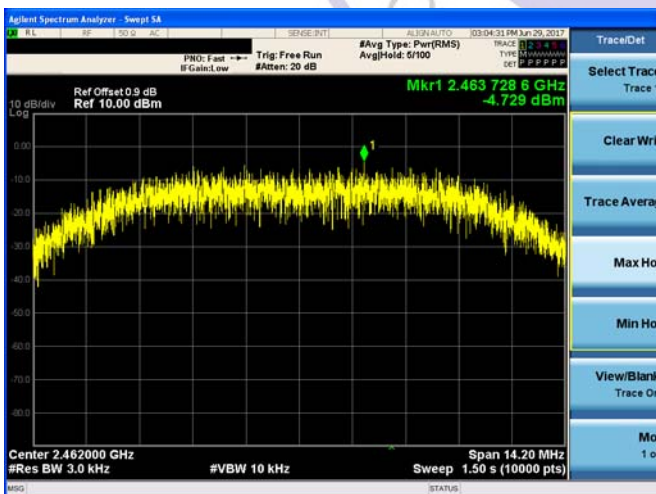

CH11

CH11

802.11n(HT20)

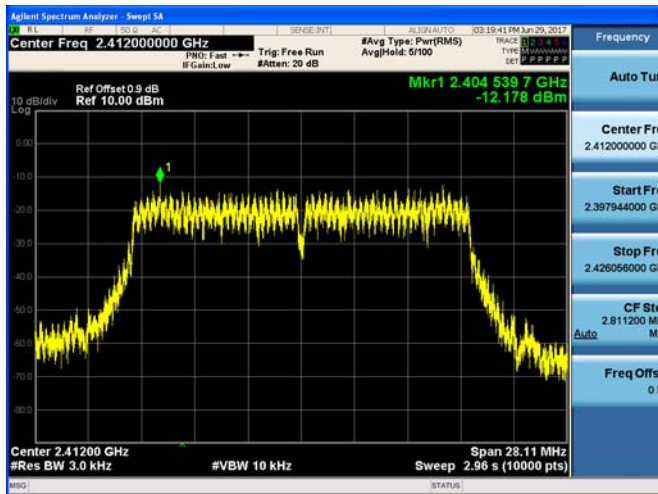

802.11n(HT40)

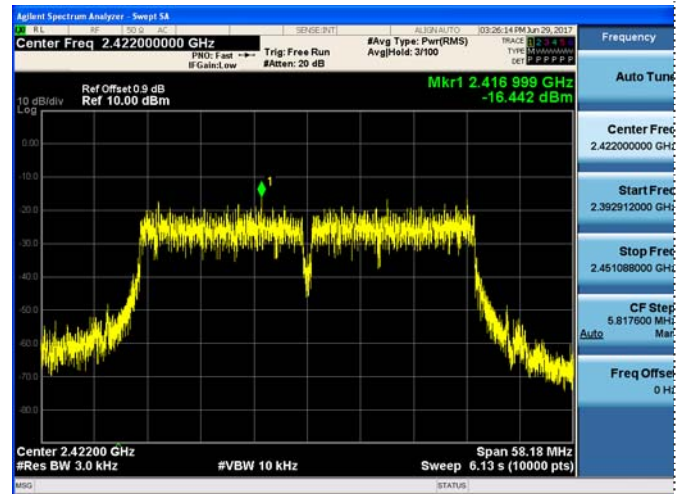

CH01

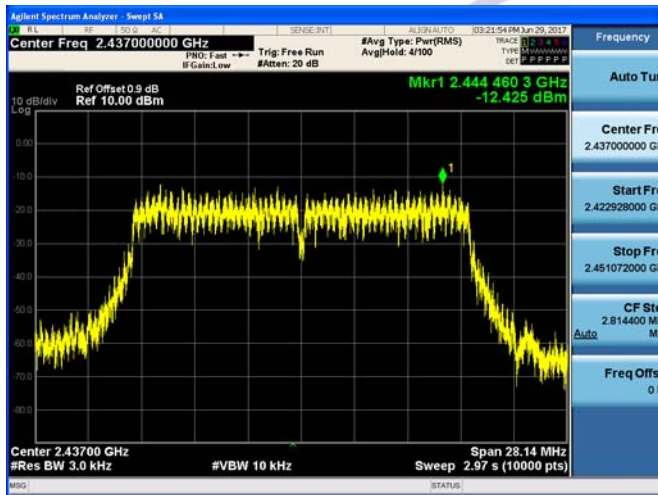

CH03

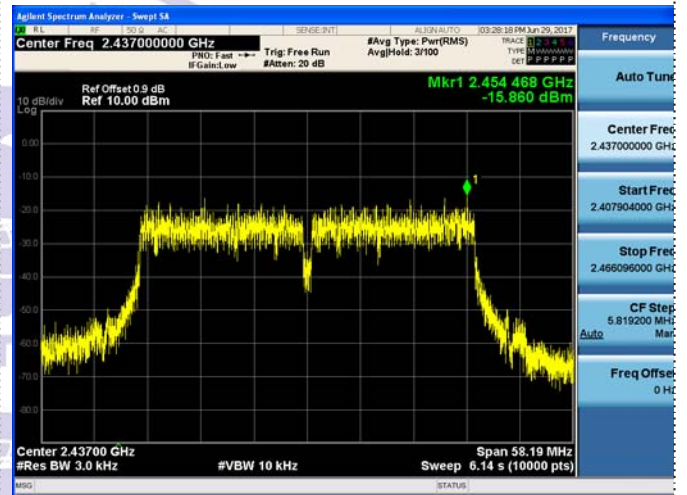

CH06

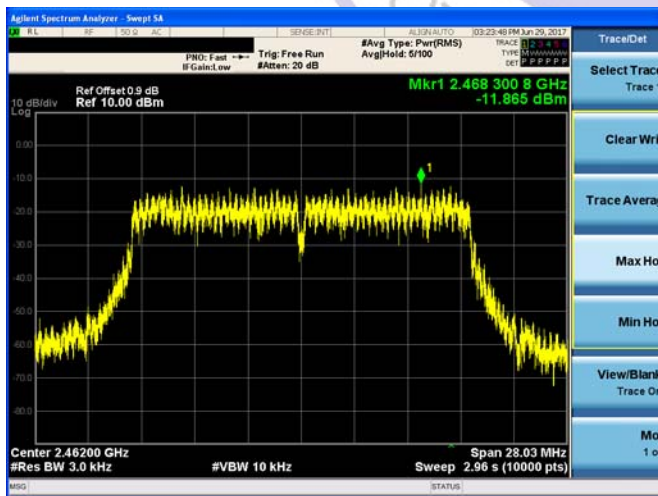

CH06

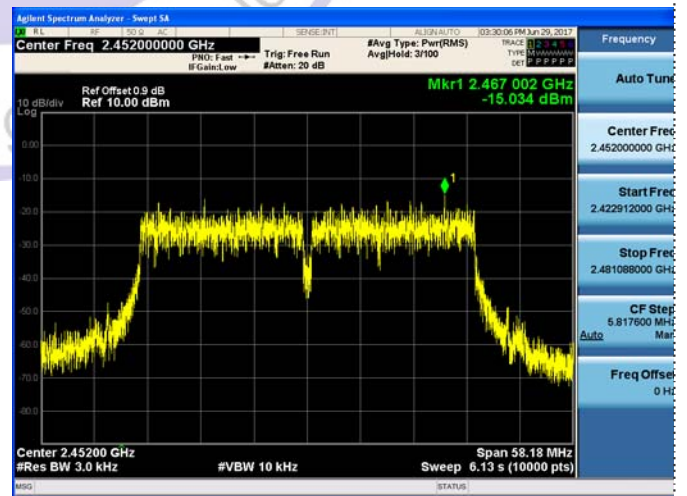

CH11

CH09

Ant 2

802.11b

802.11g

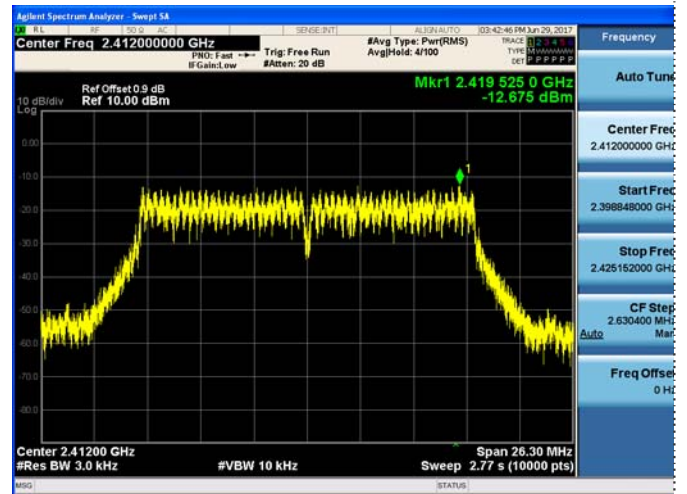
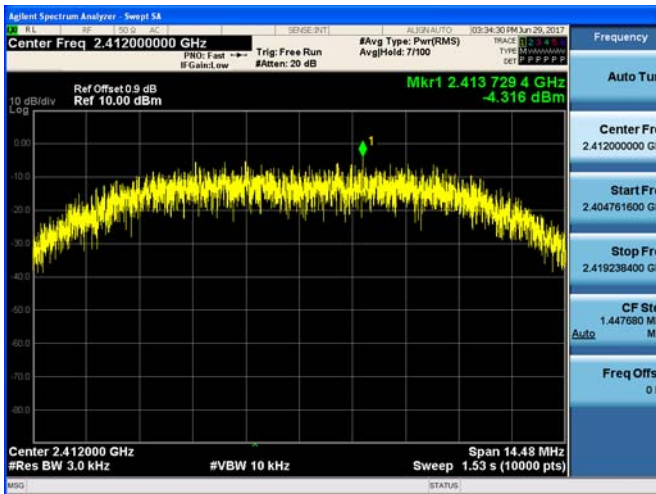

CH01

CH01

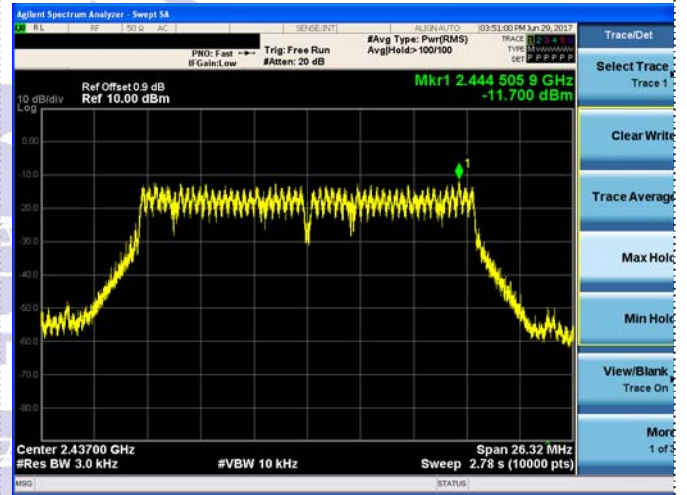
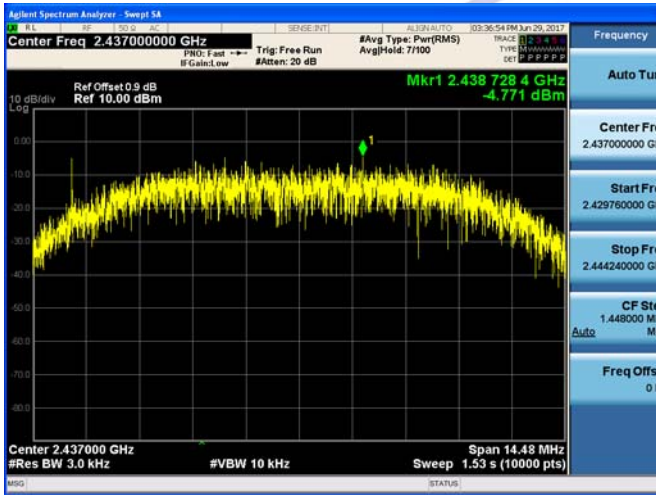

CH06

CH06

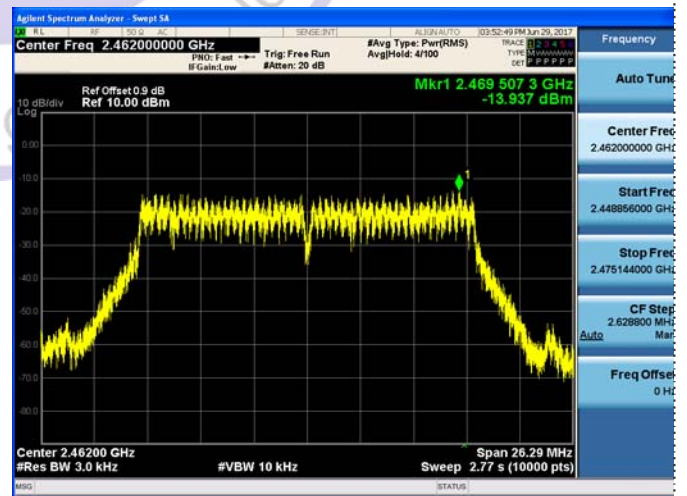
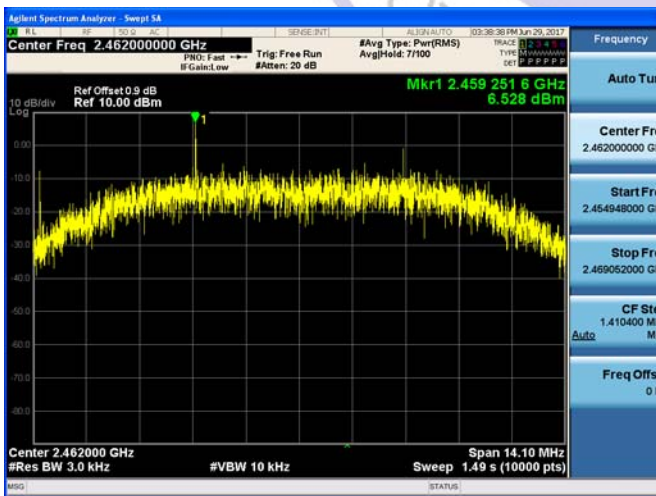

CH11

CH11



802.11n(HT20)

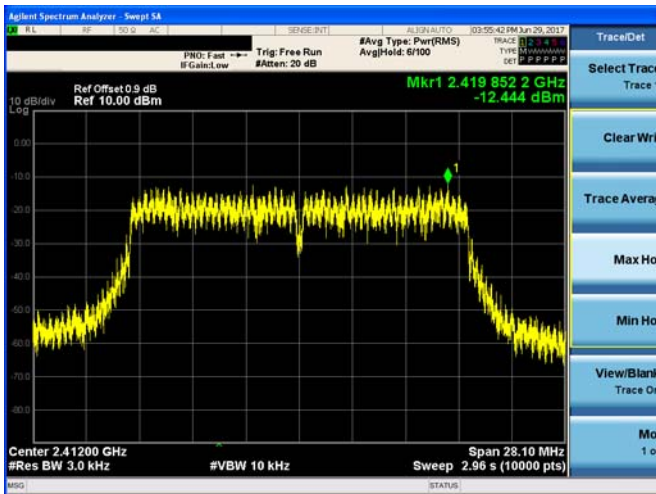

802.11n(HT40)

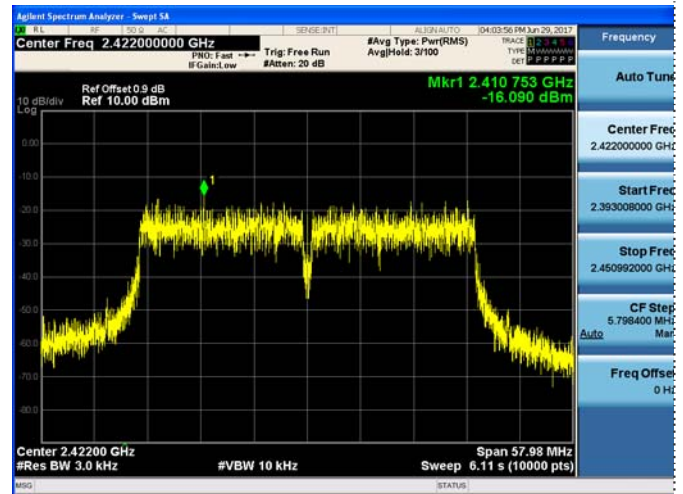

CH01

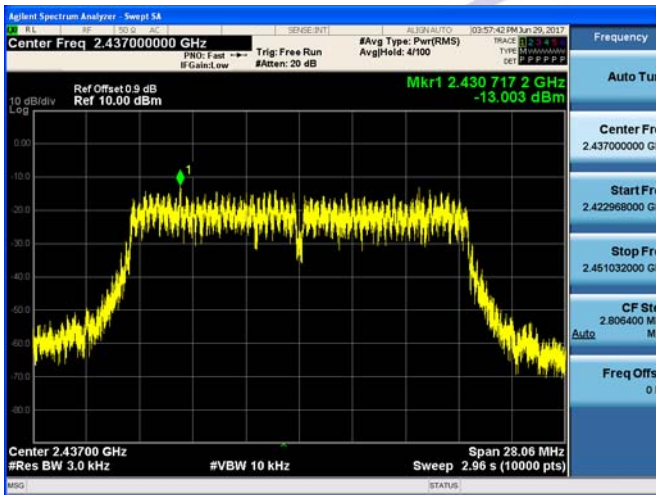

CH03

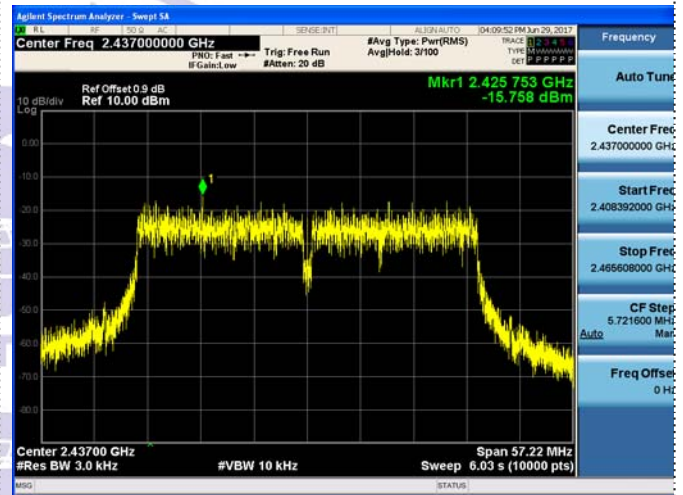

CH06

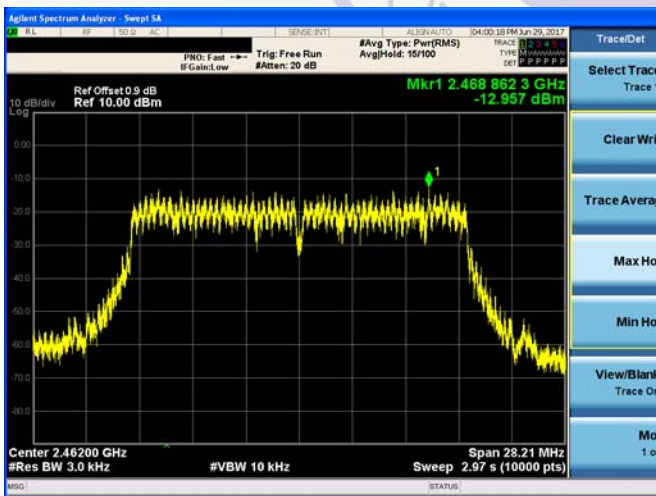

CH06

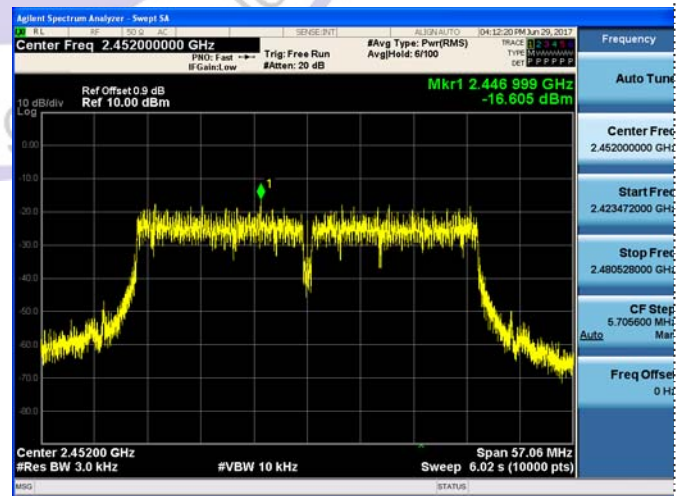

CH11



CH09



### 3.5. 6dB Bandwidth

#### Limit

For digital modulation systems, the minimum 6 dB bandwidth shall be at least 500 kHz

#### Test Procedure

The transmitter output was connected to the spectrum analyzer through an attenuator. The bandwidth of the fundamental frequency was measured by spectrum analyzer with 100 KHz RBW and 300 KHz VBW. The 6dB bandwidth is defined as the total spectrum the power of which is higher than peak power minus 6dB.

#### Test Configuration



#### Test Results

<i>WIFI</i>					
Type	Channel	6dB Bandwidth Ant1 (MHz)	6dB Bandwidth Ant2 (MHz)	Limit (KHz)	Result
802.11b	01	9.007	9.048	≥500	Pass
	06	9.072	9.050		
	11	8.873	8.815		
802.11g	01	16.44	16.44	≥500	Pass
	06	16.47	16.45		
	11	16.48	16.43		
802.11n(HT20)	01	17.57	17.56	≥500	Pass
	06	17.59	17.54		
	11	17.52	17.63		
802.11n(HT40)	03	36.36	36.24	≥500	Pass
	06	36.37	35.76		
	09	36.36	35.66		

Test plot as follows:

Ant1

802.11b

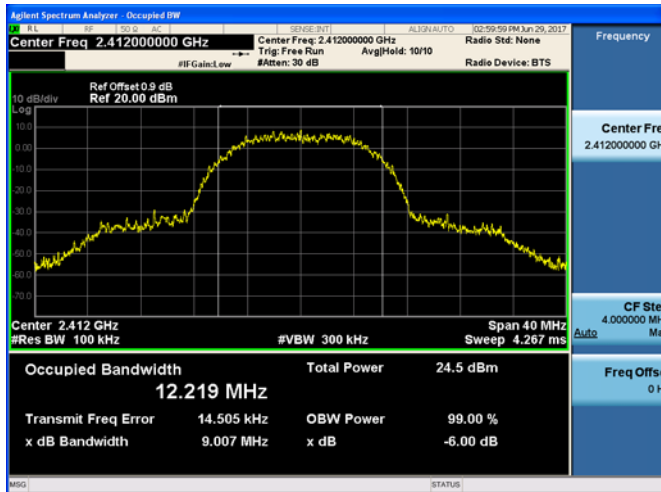

802.11g

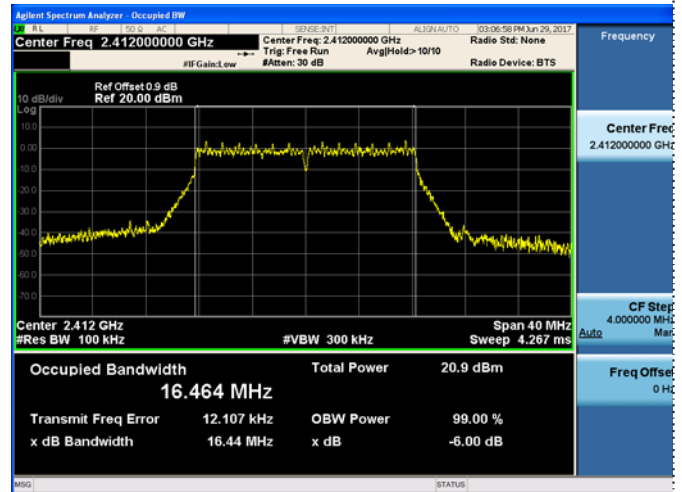

CH01

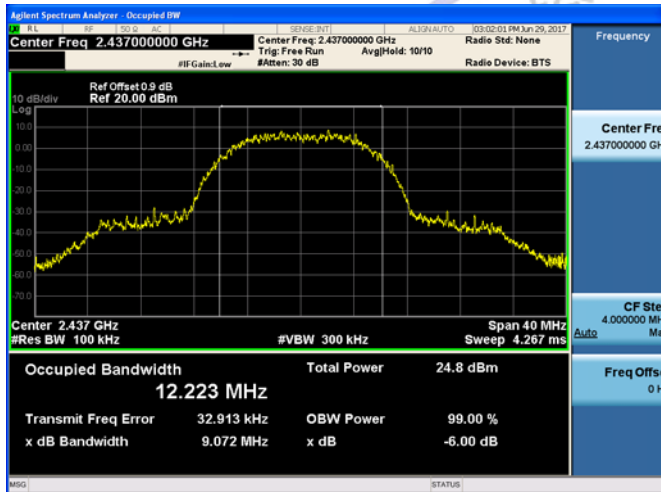

CH01

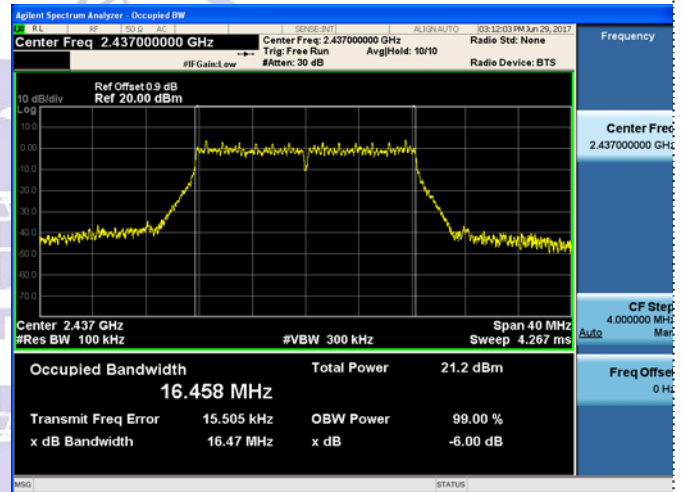

CH06

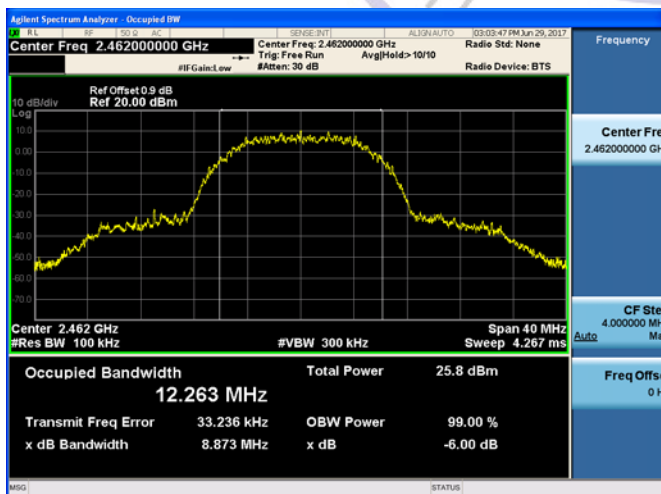

CH06

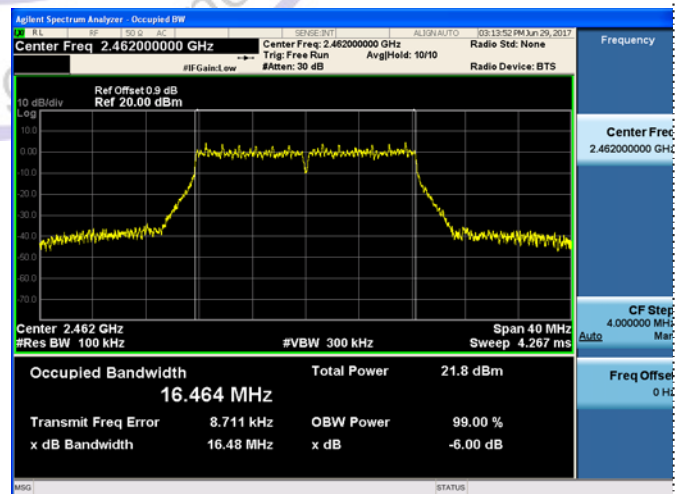

CH11



CH11

