

FCC TEST REPORT

FCC ID: 2AL8Y-X4Q

Report Number: ZKT-221125L8872-02

Date of Test.....: Nov. 16, 2022 – Nov. 30, 2022

Date of issue.....: Nov. 30, 2022

Total number of pages: 41

Test Result.....: PASS

Testing Laboratory: **Shenzhen ZKT Technology Co., Ltd.**

Address: 1/F, No. 101, Building B, No. 6, Tangwei Community Industrial Avenue, Fuhai Street, Bao'an District, Shenzhen, China

Applicant's name: Shenzhen Ugoos Technology Co., Ltd

Address: Room 6A, 6th Floor, Building A, Bao'an Square, Sun'gang Road, Luohu District, Shenzhen 518020, China

Manufacturer's name: Shenzhen Ugoos Technology Co., Ltd

Address: Room 6A, 6th Floor, Building A, Bao'an Square, Sun'gang Road, Luohu District, Shenzhen 518020, China

Test specification:

Standard: FCC CFR Title 47 Part 15 Subpart C Section 15.247
ANSI C63.10:2013

Test procedure: KDB558074 D0115.247 Meas Guidance v 05r02

Non-standard test method: N/A

Test Report Form No.: TRF-EL-110_V0

Test Report Form(s) Originator: ZKT Testing

Master TRF: Dated: 2020-01-06

This device described above has been tested by ZKT, and the test results show that the equipment under test (EUT) is in compliance with the FCC requirements. And it is applicable only to the tested sample identified in the report.

This report shall not be reproduced except in full, without the written approval of ZKT, this document may be altered or revised by ZKT, personal only, and shall be noted in the revision of the document.

Product name.....: Android TV Box

Trademark: UGOOS

Model/Type reference.....: X4Q Pro, X4Q Cube, X4Q Plus, X4Q Max

Ratings.....: DC5.0V 2.5A from adapter

Testing procedure and testing location:

Testing Laboratory : **Shenzhen ZKT Technology Co., Ltd.**

Address : 1/F, No. 101, Building B, No. 6, Tangwei Community
Industrial Avenue, Fuhai Street, Bao'an District,
Shenzhen, China

Tested by (name + signature) : **Alen He** 

Reviewer (name + signature)..... : **Joe Liu** 

Approved (name + signature) : **Lake Xie**  

Table of Contents

	Page
1. VERSION	5
2. SUMMARY OF TEST RESULTS	6
2.1 TEST FACILITY	7
2.2 MEASUREMENT UNCERTAINTY	7
3. GENERAL INFORMATION	8
3.1 GENERAL DESCRIPTION OF EUT	8
3.2 DESCRIPTION OF TEST MODES	9
3.3 BLOCK DIGRAM SHOWING THE CONFIGURATION OF SYSTEM TESTED	10
3.4 DESCRIPTION OF SUPPORT UNITS(CONDUCTED MODE)	10
3.5EQUIPMENTS LIST FOR ALL TEST ITEMS	11
4. EMC EMISSION TEST	12
4.1 CONDUCTED EMISSION MEASUREMENT	12
4.1.1 POWER LINE CONDUCTED EMISSION LIMITS	12
4.1.2 TEST PROCEDURE	12
4.1.3 DEVIATION FROM TEST STANDARD	12
4.1.4 TEST SETUP	13
4.1.5 EUT OPERATING CONDITIONS	13
4.1.6 TEST RESULT	14
4.1.6 TEST RESULT	14
4.2 RADIATED EMISSION MEASUREMENT	16
4.2.1 RADIATED EMISSION LIMITS	16
4.2.2 TEST PROCEDURE	16
4.2.3 DEVIATION FROM TEST STANDARD	17
4.2.4 TEST SETUP	17
4.2.5 EUT OPERATING CONDITIONS	18
4.2.6 TEST RESULTS	19
5. RADIATED BAND EMISSIONMEASUREMENT	22
5.1 TEST REQUIREMENT:	22
5.2 TEST PROCEDURE	22
5.3 DEVIATION FROM TEST STANDARD	22
5.4 TEST SETUP	23
5.5 EUT OPERATING CONDITIONS	23
6. POWER SPECTRAL DENSITY TEST	25
6.1 APPLIED PROCEDURES / LIMIT	25
6.2 TEST PROCEDURE	25
6.3 DEVIATION FROM STANDARD	25
6.4 TEST SETUP	25
6.5 EUT OPERATION CONDITIONS	25

6.6 TEST RESULT	25
7. CHANNEL BANDWIDTH& 99% OCCUPY BANDWIDTH	26
7.1 APPLIED PROCEDURES / LIMIT	26
7.2 TEST PROCEDURE	26
7.3 DEVIATION FROM STANDARD	26
7.4 TEST SETUP	26
7.5 EUT OPERATION CONDITIONS	26
7.6 TEST RESULT	26
8. PEAK OUTPUT POWER TEST	27
8.1 APPLIED PROCEDURES/LIMIT	27
8.2 TEST PROCEDURE	27
8.3 DEVIATION FROM STANDARD	27
8.4 TEST SETUP	27
8.5 EUT OPERATION CONDITIONS	27
8.6 TEST RESULT	27
9. CONDUCTED BAND EDGE AND SPURIOUS EMISSION	28
9.1 APPLICABLE STANDARD	28
9.2 TEST PROCEDURE	28
9.3 DEVIATION FROM STANDARD	28
9.4 TEST SETUP	28
9.5 EUT OPERATION CONDITIONS	28
9.6 TEST RESULTS	28
10. ANTENNA REQUIREMENT	29
11. APPENDIX1	30
11.1. -6DB BANDWIDTH	30
11.2. BANEDGE	32
11.3. PEAK OUTPUT POWER	34
11.4. POWER SPECTRAL DENSITY	36
11.5. SPURIOUS EMISSION	38
12. TEST SETUP PHOTO	41
13. EUT CONSTRUCTIONAL DETAILS	41

1. VERSION

Report No.	Version	Description	Approved
ZKT-221125L8872-02	Rev.01	Initial issue of report	Nov. 30, 2022

2. SUMMARY OF TEST RESULTS

Test procedures according to the technical standards:

FCC Part15 (15.247) , Subpart C			
Standard Section	Test Item	Result	Remark
FCC part 15.203/15.247 (c)	Antenna requirement	PASS	
FCC part 15.207	AC Power Line Conducted Emission	PASS	
FCC part 15.247 (b)(3)	Conducted Peak Output Power	PASS	
FCC part 15.247 (a)(2)	Channel Bandwidth& 99% OCB	PASS	
FCC part 15.247 (e)	Power Spectral Density	PASS	
FCC part 15.247(d)	Band Edge	PASS	
FCC part 15.205/15.209	Spurious Emission	PASS	

NOTE:

(1) "N/A" denotes test is not applicable in this Test Report

2.1 TEST FACILITY

Shenzhen ZKT Technology Co., Ltd.

Add. : 1/F, No. 101, Building B, No. 6, Tangwei Community Industrial Avenue, Fuhai Street, Bao'an District, Shenzhen, China

FCC Test Firm Registration Number: 692225

Designation Number: CN1299

IC Registered No.: 27033

2.2 MEASUREMENT UNCERTAINTY

The reported uncertainty of measurement $y \pm U$, where expanded uncertainty U is based on a standard uncertainty multiplied by a coverage factor of $k=2$, providing a level of confidence of approximately 95 %.

No.	Item	Uncertainty
1	Conducted Emission Test	$\pm 1.38\text{dB}$
2	RF power conducted	$\pm 0.16\text{dB}$
3	Spurious emissions conducted	$\pm 0.21\text{dB}$
4	All emissions radiated(<1G)	$\pm 4.68\text{dB}$
5	All emissions radiated(>1G)	$\pm 4.89\text{dB}$
6	Temperature	$\pm 0.5\text{C}$
7	Humidity	$\pm 2\%$

3. GENERAL INFORMATION

3.1 GENERAL DESCRIPTION OF EUT

Product Name:	Android TV Box
Model No.:	X4Q Pro
Serial No.:	X4Q Cube, X4Q Plus, X4Q Max
Model difference:	All models are consistent in design, circuit layout, wiring and bom, but the internal running software will be different due to the needs of different customers, but these differences will not affect any electrical performance and RF parameters, so the test model is: X4Q Pro
Hardware Version:	V1.0
Software Version:	V1.0
Sample(s) Status:	Engineer sample
Channel numbers:	40
Channel separation:	2402MHz~2480MHz
Date rate:	1Mbps
Modulation technology:	GFSK
Antenna Type:	PCB antenna
Antenna gain:	1.26dBi
Power supply:	DC5.0V 2.5A from adapter

Operation Frequency each of channel							
Channel	Frequency	Channel	Frequency	Channel	Frequency	Channel	Frequency
1	2402	11	2422	21	2442	31	2462
2	2404	12	2424	22	2444	32	2464
3	2406	13	2426	23	2446	33	2466
4	2408	14	2428	24	2448	34	2468
5	2410	15	2430	25	2450	35	2470
6	2412	16	2432	26	2452	36	2472
7	2414	17	2434	27	2454	37	2474
8	2416	18	2436	28	2456	38	2476
9	2418	19	2438	29	2458	39	2478
10	2420	20	2440	30	2460	40	2480

Note:

In section 15.31(m), regards to the operating frequency range over 10 MHz, the Lowest frequency, the middle frequency, and the highest frequency of channel were selected to perform the test, and the selected channel see below:

Test channel	Frequency
The lowest channel	2402MHz

The middle channel	2440MHz
The Highest channel	2480MHz

3.2 DESCRIPTION OF TEST MODES

Transmitting mode	Keep the EUT in continuously transmitting mode
Remark: During the test, the duty cycle >98%, the test voltage was tuned from 85% to 115% of the nominal rated supply voltage, and found that the worst case was under the nominal rated supply condition. So the report just shows that condition's data.	

We have verified the construction and function in typical operation. All the test modes were carried out with the EUT in transmitting operation, which was shown in this test report and defined as follows:	
Pre-scan all kind of data rate in lowest channel, and found the follow list which it was worst case.	

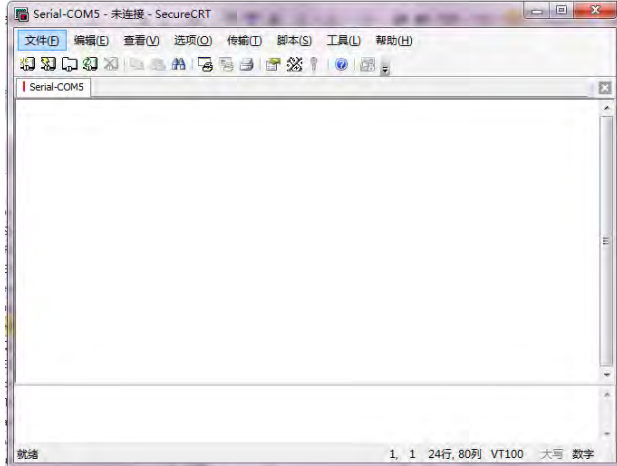
Test Software	<p>Test Tool</p> 
Power level setup	<10dBm

3.3 BLOCK DIGRAM SHOWING THE CONFIGURATION OF SYSTEM TESTED

Conducted Emission

Conducted Emission

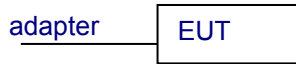

Radiated Emission

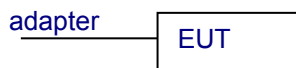

Conducted Spurious



3.4 DESCRIPTION OF SUPPORT UNITS(CONDUCTED MODE)

The EUT has been tested as an independent unit together with other necessary accessories or support units. The following support units or accessories were used to form a representative test configuration during the tests.

Item	Equipment	Mfr/Brand	Model/Type No.	Series No.	Note
1	adapter	Shenzhen Rongweixin Electronics Co.,Ltd.	R122-0502500UD	/	SDOC
2					
3					
4					

Item	Shielded Type	Ferrite Core	Length	Note

Note:

- (1) The support equipment was authorized by Declaration of Confirmation.
- (2) For detachable type I/O cable should be specified the length in cm in 『Length』 column.

3.5EQUIPMENTS LIST FOR ALL TEST ITEMS

Radiation Test equipment

Item	Equipment	Manufacturer	Type No.	Serial No.	Last calibration	Calibrated until
1	Spectrum Analyzer (9kHz-26.5GHz)	KEYSIGHT	9020A	MY55370835	Oct. 18, 2022	Oct. 17, 2023
2	Spectrum Analyzer (1GHz-40GHz)	R&S	FSQ	100363	Oct. 17, 2022	Oct. 16, 2023
3	EMI Test Receiver (9kHz-7GHz)	R&S	ESCI7	101169	Oct. 18, 2022	Oct. 17, 2023
4	Bilog Antenna (30MHz-1500MHz)	Schwarzbeck	VULB9168	N/A	Oct. 17, 2022	Oct. 16, 2023
5	Horn Antenna (1GHz-18GHz)	Agilent	AH-118	071145	Oct. 17, 2022	Oct. 16, 2023
6	Loop Antenna	TESEQ	HLA6121	58357	Oct. 17, 2022	Oct. 16, 2023
7	Amplifier (30-1000MHz)	EM Electronics	EM330 Amplifier	060747	Oct. 17, 2022	Oct. 16, 2023
8	Amplifier (1GHz-26.5GHz)	Agilent	8449B	3008A00315	Oct. 18, 2022	Oct. 17, 2023
9	RF cables1 (9kHz-30MHz)	N/A	9kHz-30MHz	N/A	Oct. 18, 2022	Oct. 17, 2023
10	RF cables2 (30MHz-1GHz)	N/A	30MHz-1GHz	N/A	Oct. 18, 2022	Oct. 17, 2023
11	RF cables3 (1GHz-40GHz)	N/A	1GHz-40GHz	N/A	Oct. 18, 2022	Oct. 17, 2023
12	ESG Signal Generator	Agilent	E4421B	N/A	Oct. 18, 2022	Oct. 17, 2023
13	Signal Generator	Agilent	N5182A	N/A	Oct. 22, 2022	Oct. 21, 2023
14	Magnetic Field Probe Tester	Narda	ELT-400	0-0344	Oct. 17, 2022	Oct. 16, 2023
15	MWRF Power Meter Test system	MW	MW100-RPC B	N/A	Oct. 22, 2022	Oct. 21, 2023
16	Power sensor	KEYSIGHT	U200H	MY51190005	Oct. 22, 2022	Oct. 21, 2023
17	D.C. Power Supply	LongWei	TPR-6405D	N/A	\	\
18	EMC Software	Frad	EZ-EMC	Ver.EMC-CON 3A1.1	\	\
19	RF Software	MW	MTS8310	V2.0.0.0	\	\
20	Turntable	MF	MF-7802BS	N/A	\	\
21	Antenna tower	MF	MF-7802BS	N/A	\	\

Conduction Test equipment

Item	Kind of Equipment	Manufacturer	Type No.	Serial No.	Last calibration	Calibrated until
1	LISN	R&S	ENV216	101471	Oct. 22, 2022	Oct. 21, 2023
2	LISN	CYBERTEK	EM5040A	E1850400149	Oct. 22, 2022	Oct. 21, 2023
3	Test Cable	N/A	C01	N/A	Oct. 18, 2022	Oct. 17, 2023
4	Test Cable	N/A	C02	N/A	Oct. 18, 2022	Oct. 17, 2023
5	EMI Test Receiver	R&S	ESCI3	101393	Oct. 17, 2022	Oct. 16, 2023
6	EMC Software	Frad	EZ-EMC	Ver.EMC-CON 3A1.1	\	\

4. EMC EMISSION TEST

4.1 CONDUCTED EMISSION MEASUREMENT

Test Requirement:	FCC Part15 C Section 15.207
Test Method:	ANSI C63.10:2013
Test Frequency Range:	150KHz to 30MHz
Receiver setup:	RBW=9KHz, VBW=30KHz, Sweep time=auto

4.1.1 POWER LINE CONDUCTED EMISSION Limits

FREQUENCY (MHz)	Limit (dBuV)		Standard
	Quasi-peak	Average	
0.15 -0.5	66 - 56 *	56 - 46 *	FCC
0.50 -5.0	56.00	46.00	FCC
5.0 -30.0	60.00	50.00	FCC

Note:

(1) *Decreases with the logarithm of the frequency.

4.1.2 TEST PROCEDURE

- The EUT was placed 0.8 meters from the horizontal ground plane with EUT being connected to the power mains through a line impedance stabilization network (LISN). All other support equipments powered from additional LISN(s). The LISN provide 50 Ohm/ 50uH of coupling impedance for the measuring instrument.
- Interconnecting cables that hang closer than 40 cm to the ground plane shall be folded back and forth in the center forming a bundle 30 to 40 cm long.
- I/O cables that are not connected to a peripheral shall be bundled in the center. The end of the cable may be terminated, if required, using the correct terminating impedance. The overall length shall not exceed 1 m.
- LISN at least 80 cm from nearest part of EUT chassis.
- For the actual test configuration, please refer to the related Item –EUT Test Photos.

4.1.3 DEVIATION FROM TEST STANDARD

No deviation

4.1.4 TEST SETUP

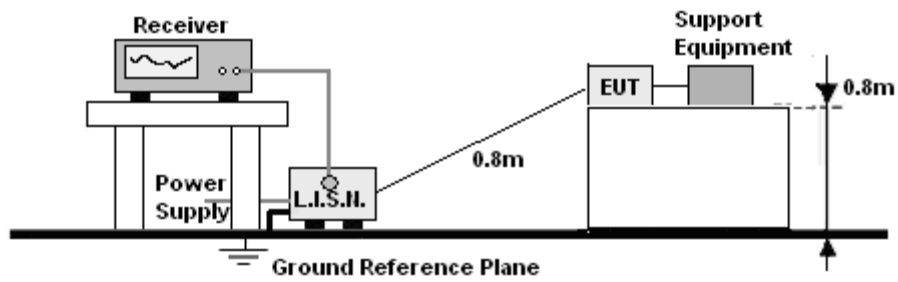

4.1.5 EUT OPERATING CONDITIONS

The EUT was configured for testing in a typical fashion (as a customer would normally use it). The EUT has been programmed to continuously transmit during test. This operating condition was tested and used to collect the included data.

We pretest AC 120V and AC 230V, the worst voltage was AC 120V and the data recording in the report.

4.1.6 TEST RESULT

4.1.6 Test Result

Temperature :	26°C	Relative Humidity :	54%
Pressure :	101kPa	Phase :	L
Test Voltage:	AC 120V/60Hz	Mode:	2480MHz

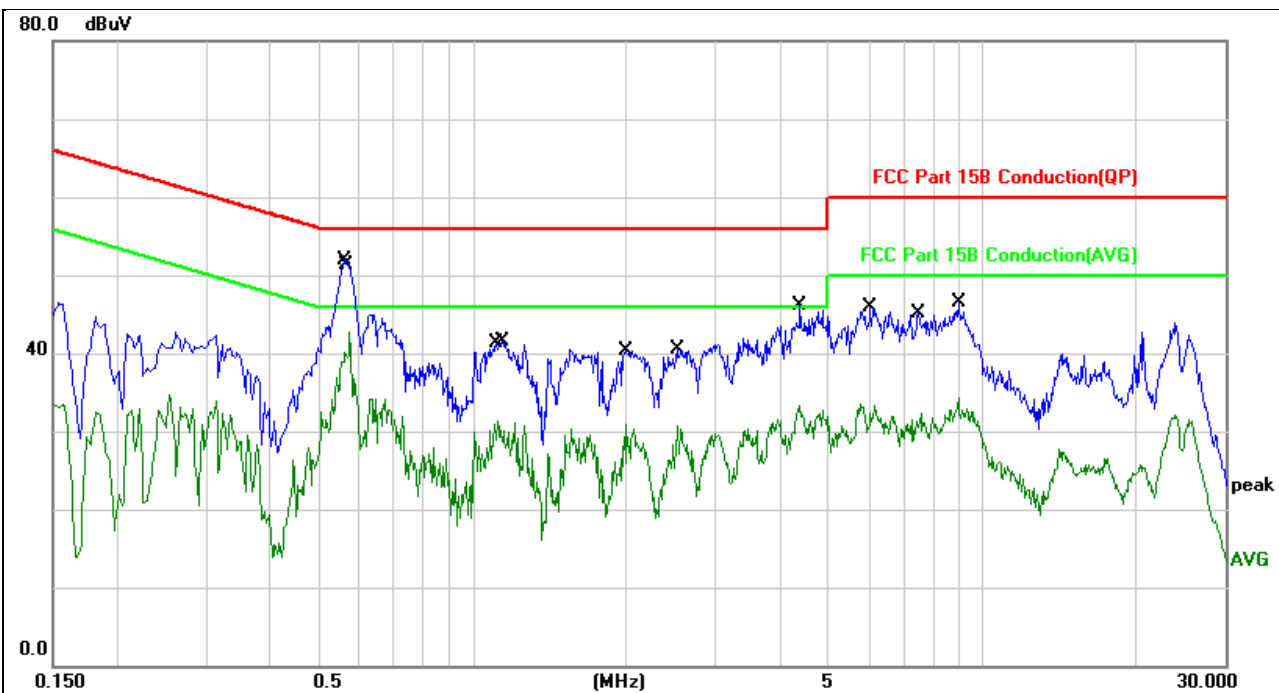

No. Mk.	Freq. MHz	Reading Level dBuV	Correct Factor dB	Measurement dBuV	Limit dBuV	Over dB	Detector	Comment
1	0.5620	41.68	10.21	51.89	56.00	-4.11	QP	
2 *	0.5740	32.46	10.21	42.67	46.00	-3.33	AVG	
3	1.1180	21.17	10.16	31.33	46.00	-14.67	AVG	
4	1.1420	31.41	10.16	41.57	56.00	-14.43	QP	
5	2.0059	20.94	10.04	30.98	46.00	-15.02	AVG	
6	2.5300	20.61	10.09	30.70	46.00	-15.30	AVG	
7	4.4060	36.28	9.87	46.15	56.00	-9.85	QP	
8	4.4060	23.45	9.87	33.32	46.00	-12.68	AVG	
9	6.0380	36.04	9.92	45.96	60.00	-14.04	QP	
10	7.5020	35.34	9.86	45.20	60.00	-14.80	QP	
11	8.9700	36.54	9.94	46.48	60.00	-13.52	QP	
12	8.9700	24.42	9.94	34.36	50.00	-15.64	AVG	

Notes:

1. An initial pre-scan was performed on the line and neutral lines with peak detector.
2. Quasi-Peak and Average measurement were performed at the frequencies with maximized peak emission.
3. Measurement Level = Reading level + Correct Factor

Temperature :	26°C	Relative Humidity :	54%
Pressure :	101kPa	Phase :	N
Test Voltage:	AC 120V/60Hz	Mode:	2480MHz

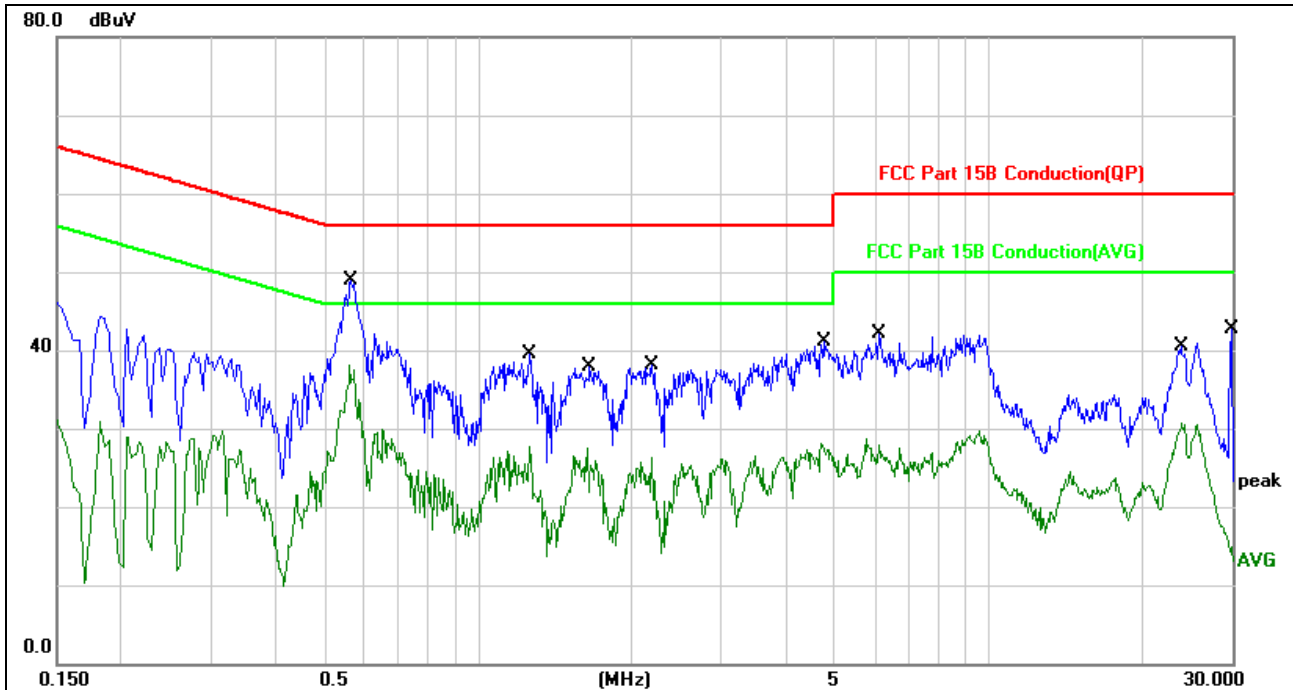

No. Mk.	Freq. MHz	Reading Level dBuV	Correct Factor dB	Measurement dBuV	Limit dBuV	Over dB	Detector	Comment
1	0.5620	27.89	10.21	38.10	46.00	-7.90	AVG	
2 *	0.5660	38.60	10.21	48.81	56.00	-7.19	QP	
3	1.2660	29.41	10.14	39.55	56.00	-16.45	QP	
4	1.2660	17.54	10.14	27.68	46.00	-18.32	AVG	
5	1.6420	17.33	10.08	27.41	46.00	-18.59	AVG	
6	2.1900	28.14	10.02	38.16	56.00	-17.84	QP	
7	2.1900	16.27	10.02	26.29	46.00	-19.71	AVG	
8	4.7140	18.17	9.92	28.09	46.00	-17.91	AVG	
9	4.7540	31.12	9.93	41.05	56.00	-14.95	QP	
10	6.0900	32.16	9.92	42.08	60.00	-17.92	QP	
11	23.9340	20.87	9.74	30.61	50.00	-19.39	AVG	
12	29.8540	32.85	9.77	42.62	60.00	-17.38	QP	

Notes:

1. An initial pre-scan was performed on the line and neutral lines with peak detector.
2. Quasi-Peak and Average measurement were performed at the frequencies with maximized peak emission.
3. Measurement Level = Reading level + Correct Factor

4.2 RADIATED EMISSION MEASUREMENT

Test Requirement:	FCC Part15 C Section 15.209				
Test Method:	ANSI C63.10:2013				
Test Frequency Range:	9kHz to 25GHz				
Test site:	Measurement Distance: 3m				
Receiver setup:	Frequency	Detector	RBW	VBW	Value
	9KHz-150KHz	Quasi-peak	200Hz	600Hz	Quasi-peak
	150KHz-30MHz	Quasi-peak	9KHz	30KHz	Quasi-peak
	30MHz-1GHz	Quasi-peak	120KHz	300KHz	Quasi-peak
	Above 1GHz	Peak	1MHz	3MHz	Peak
		Peak	1MHz	10Hz	Average

4.2.1 RADIATED EMISSION LIMITS

Frequencies (MHz)	Field Strength (micorvolts/meter)	Measurement Distance (meters)
0.009~0.490	2400/F(KHz)	300
0.490~1.705	24000/F(KHz)	30
1.705~30.0	30	30
30~88	100	3
88~216	150	3
216~960	200	3
Above 960	500	3

LIMITS OF RADIATED EMISSION MEASUREMENT

FREQUENCY (MHz)	Limit (dBuV/m) (at 3M)	
	PEAK	AVERAGE
Above 1000	74	54

Notes:

- (1) The limit for radiated test was performed according to FCC PART 15C.
- (2) The tighter limit applies at the band edges.
- (3) Emission level (dBuV/m)=20log Emission level (uV/m).

4.2.2 TEST PROCEDURE

Below 1GHz test procedure as below:

- a. The EUT was placed on the top of a rotating table 0.8 meters above the ground at a 3 meter semi-anechoiccamber. The table was rotated 360 degrees to determine the position of the highest radiation.
- b. The EUT was set 3 meters away from the interference-receiving antenna, which was mounted on the top of variable-height antenna tower.

- c. The antenna height is varied from one meter to four meters above the ground to determine the maximum value of the field strength. Both horizontal and vertical polarizations of the antenna are set to make the measurement.
- d. For each suspected emission, the EUT was arranged to its worst case and then the antenna was tuned to heights from 1 meter to 4 meters (for the test frequency of below 30MHz, the antenna was tuned to heights 1 meter) and the rotatable table was turned from 0 degrees to 360 degrees to find the maximum reading.
- e. The test-receiver system was set to Peak Detect Function and Specified Bandwidth with Maximum Hold Mode.
- f. If the emission level of the EUT in peak mode was 10dB lower than the limit specified, then testing could be stopped and the peak values of the EUT would be reported. Otherwise the emissions that did not have 10dB margin would be re-tested one by one using peak, quasi-peak or average method as specified and then reported in a data sheet.

Above 1GHz test procedure as below:

- g. Different between above is the test site, change from Semi- Anechoic Chamber to fully Anechoic Chamber and change form table 0.8 metre to 1.5 metre (Above 18GHz the distance is 1 meter and table is 1.5 metre).
- h. Test the EUT in the lowest channel ,the middle channel ,the Highest channel

Note:

Both horizontal and vertical antenna polarities were tested and performed pretest to three orthogonal axis. The worst case emissions were reported

4.2.3 DEVIATION FROM TEST STANDARD

No deviation

4.2.4 TEST SETUP

(A) Radiated Emission Test-Up Frequency Below 30MHz

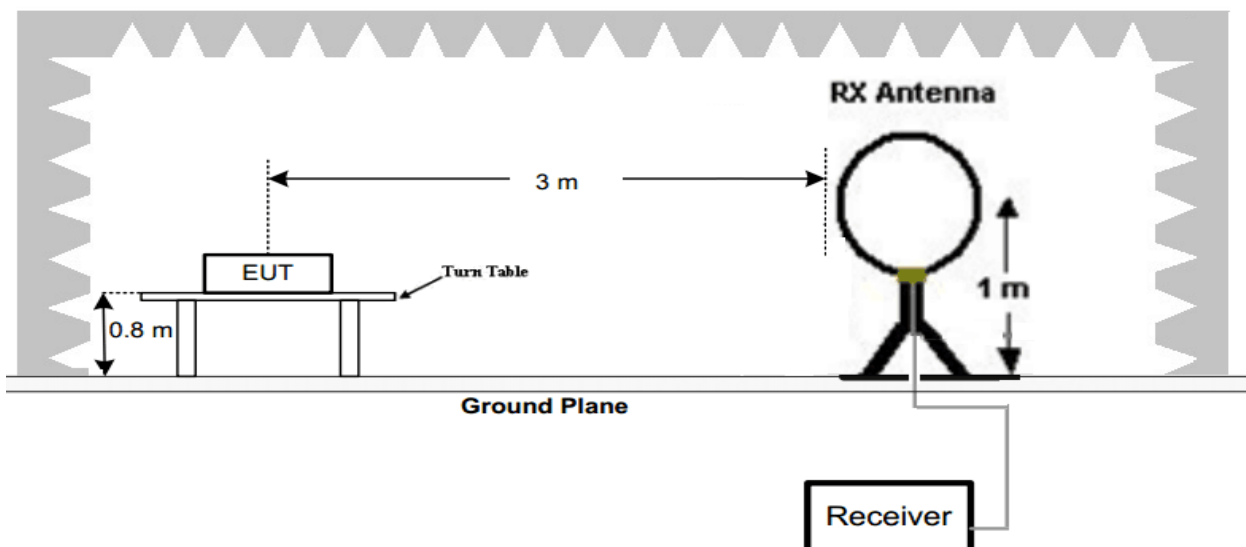

(B) Radiated Emission Test-Up Frequency 30MHz~1GHz

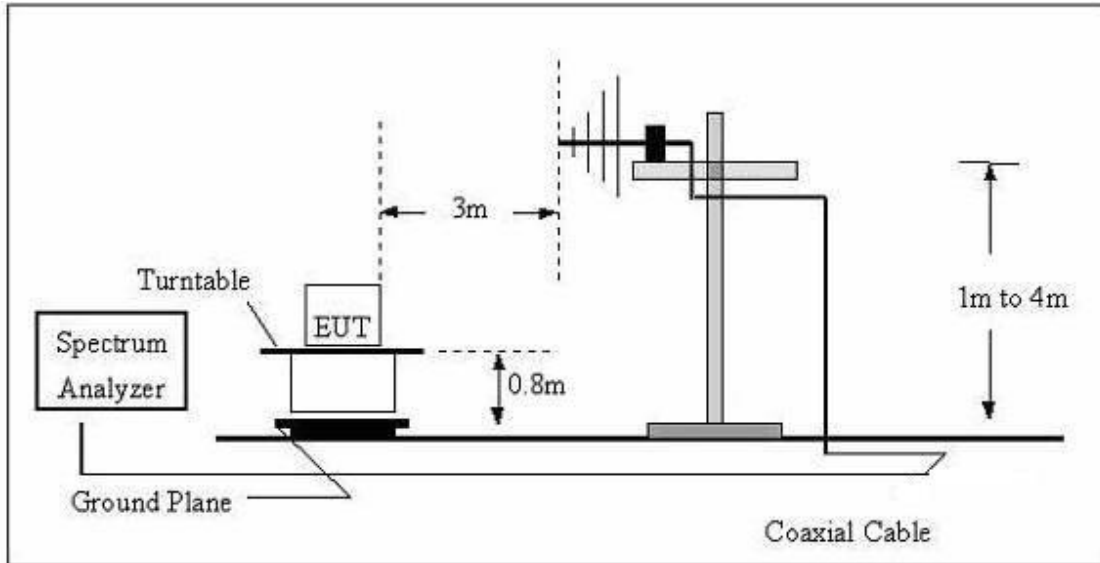

(C) Radiated Emission Test-Up Frequency Above 1GHz

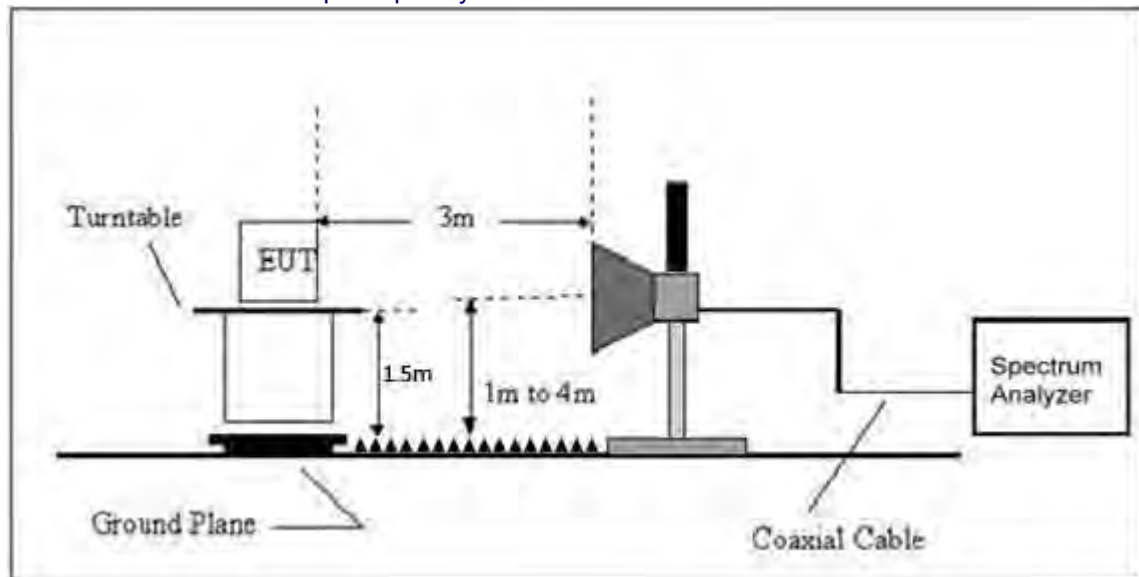

4.2.5 EUT OPERATING CONDITIONS

The EUT tested system was configured as the statements of 2.4 Unless otherwise a special operating condition is specified in the follows during the testing.

4.2.6 TEST RESULTS

Between 9KHz – 30MHz

The emission from 9 kHz to 30MHz was pre-tested and found the result was 20dB lower than the limit, and according to 15.31(o) & RSS-Gen 6.13, the test result no need to reported.

Between 30MHz – 1GHz

Temperature:	26°C	Relative Humidity:	54%
Pressure:	101 kPa	Polarization:	Horizontal
Test Voltage:	AC 120V/60Hz	Mode:	2480MHz

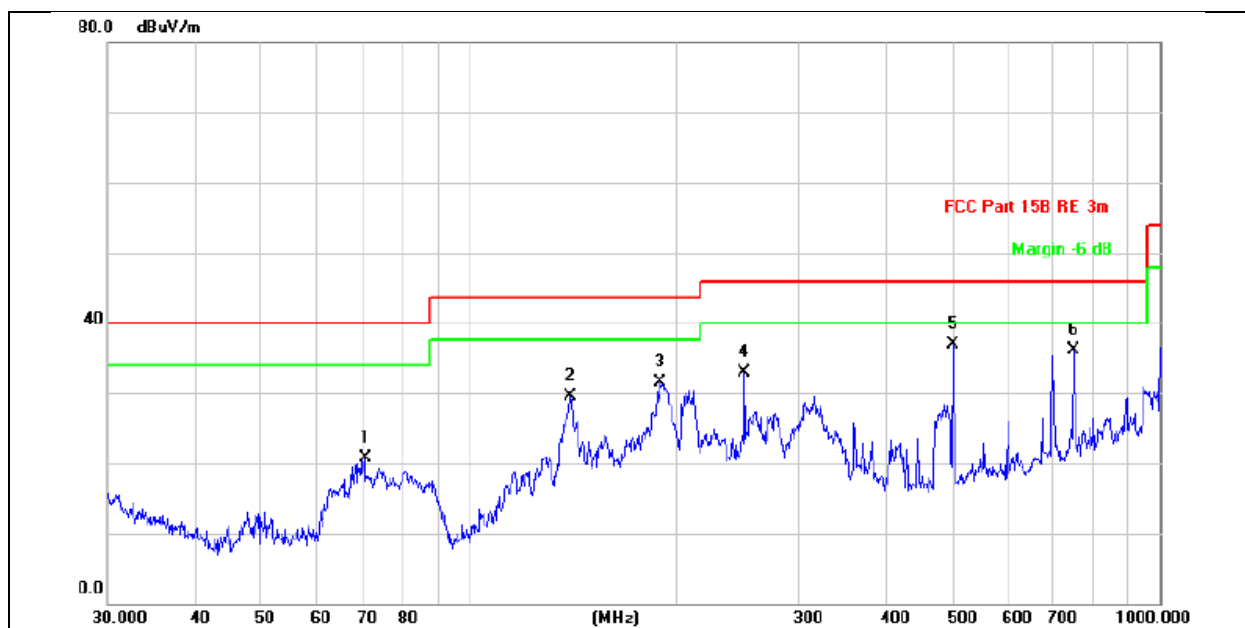

No.	Mk.	Freq. MHz	Reading Level dBuV	Correct Factor dB/m	Measure- ment dBuV/m	Limit dBuV/m	Over dB	Detector	Antenna Height cm	Table Degree	Comment
1		70.5836	35.72	-15.11	20.61	40.00	-19.39	QP	100	0	
2		139.8508	39.46	-9.90	29.56	43.50	-13.94	QP	100	36	
3		189.0743	42.02	-10.46	31.56	43.50	-11.94	QP	100	188	
4		250.3012	43.60	-10.72	32.88	46.00	-13.12	QP	100	84	
5	*	501.1790	40.15	-3.18	36.97	46.00	-9.03	QP	100	306	
6		750.1083	35.03	1.06	36.09	46.00	-9.91	QP	100	94	

Temperature:	26°C	Relative Humidity:	54%
Pressure:	101kPa	Polarization:	Vertical
Test Voltage:	AC 120V/60Hz	Mode:	2480MHz

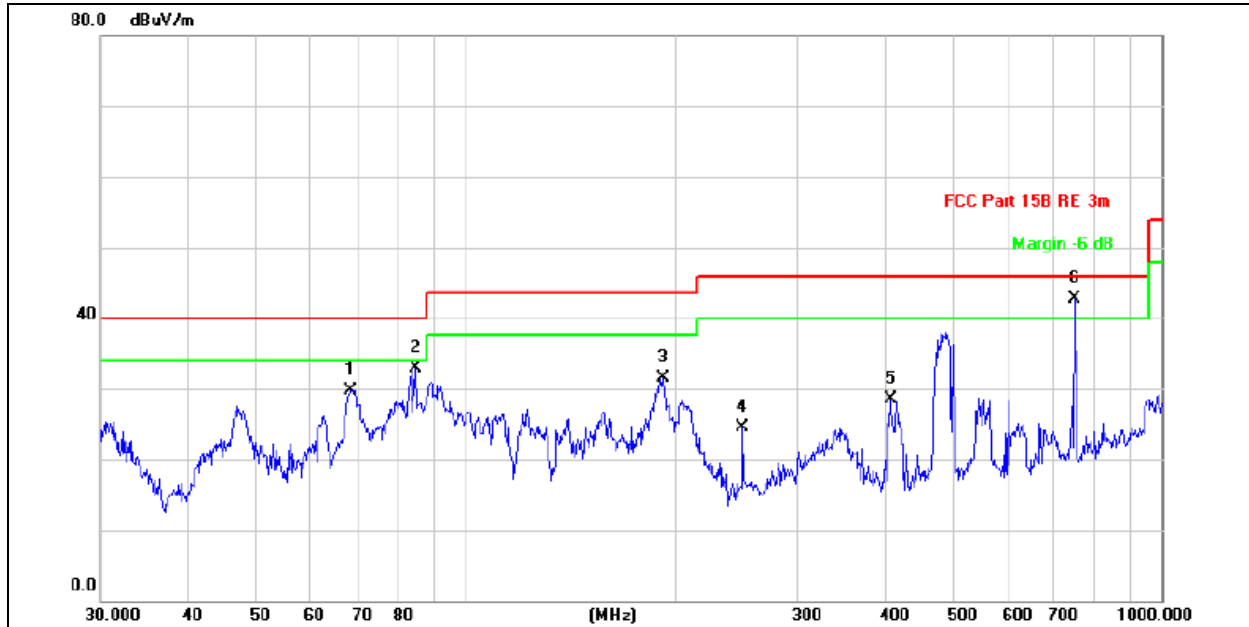

No.	Mk.	Freq.	Reading Level	Correct Factor	Measurement	Limit	Over	Antenna Height	Table Degree	
		MHz	dBuV	dB/m	dBuV/m	dBuV/m	dB	cm	degree	Comment
1		68.3908	44.95	-15.18	29.77	40.00	-10.23	QP	100	360
2		84.9995	48.23	-15.28	32.95	40.00	-7.05	QP	100	312
3		192.4186	41.78	-10.33	31.45	43.50	-12.05	QP	100	60
4		250.3012	35.16	-10.72	24.44	46.00	-21.56	QP	100	360
5		407.5145	33.96	-5.54	28.42	46.00	-17.58	QP	100	360
6	*	750.1083	41.65	1.06	42.71	46.00	-3.29	QP	100	91

Remarks:

1. Final Level = Receiver Read level + Antenna Factor + Cable Loss – Pre-amplifier Factor
2. The emission levels of other frequencies are very lower than the limit and not show in test report.

1GHz~25GHz

Polar (H/V)	Frequency	Meter Reading	Pre-ampl ifier	Cable Loss	Antenna Factor	Emission Level	Limits	Margin	Detect or Type
	(MHz)	(dBuV)	(dB)	(dB)	(dB)	(dBuV/m)	(dBuV/m)	(dB)	
BLE1M--Low Channel:2402MHz									
V	4804.00	54.03	30.55	5.77	24.66	53.91	74.00	-20.09	PK
V	4804.00	40.21	30.55	5.77	24.66	40.09	54.00	-13.91	AV
V	7206.00	54.01	30.33	6.32	24.55	54.55	74.00	-19.45	PK
V	7206.00	40.79	30.33	6.32	24.55	41.33	54.00	-12.67	AV
V	9608.00	50.71	30.85	7.45	24.69	52.00	74.00	-22.00	PK
V	9608.00	37.12	30.85	7.45	24.69	38.41	54.00	-15.59	AV
H	4804.00	55.06	30.55	5.77	24.66	54.94	74.00	-19.06	PK
H	4804.00	40.71	30.55	5.77	24.66	40.59	54.00	-13.41	AV
H	7206.00	53.92	30.33	6.32	24.55	54.46	74.00	-19.54	PK
H	7206.00	40.41	30.33	6.32	24.55	40.95	54.00	-13.05	AV
H	9608.00	50.74	30.85	7.45	24.69	52.03	74.00	-21.97	PK
H	9608.00	37.98	30.85	7.45	24.69	39.27	54.00	-14.73	AV

Polar (H/V)	Frequency	Meter Reading	Pre-ampl ifier	Cable Loss	Antenna Factor	Emission Level	Limits	Margin	Detect or Type
	(MHz)	(dBuV)	(dB)	(dB)	(dB)	(dBuV/m)	(dBuV/m)	(dB)	
BLE1M--Middle Channel:2440MHz									
V	4880.00	56.33	30.55	5.77	24.66	56.21	74.00	-17.79	PK
V	4880.00	39.24	30.55	5.77	24.66	39.12	54.00	-14.88	AV
V	7320.00	54.72	30.33	6.32	24.55	55.26	74.00	-18.74	PK
V	7320.00	40.91	30.33	6.32	24.55	41.45	54.00	-12.55	AV
V	9760.00	50.56	30.85	7.45	24.69	51.85	74.00	-22.15	PK
V	9760.00	36.69	30.85	7.45	24.69	37.98	54.00	-16.02	AV
H	4880.00	54.49	30.55	5.77	24.66	54.37	74.00	-19.63	PK
H	4880.00	40.01	30.55	5.77	24.66	39.89	54.00	-14.11	AV
H	7320.00	54.19	30.33	6.32	24.55	54.73	74.00	-19.27	PK
H	7320.00	40.59	30.33	6.32	24.55	41.13	54.00	-12.87	AV
H	9760.00	51.24	30.85	7.45	24.69	52.53	74.00	-21.47	PK
H	9760.00	38.63	30.85	7.45	24.69	39.92	54.00	-14.08	AV

Polar (H/V)	Frequency	Meter Reading	Pre-ampli fier	Cable Loss	Antenna Factor	Emission Level	Limits	Margin	Detect or Type
	(MHz)	(dBuV)	(dB)	(dB)	(dB)	(dBuV/m)	(dBuV/m)	(dB)	
BLE1M--High Channel:2480MHz									
V	4960.00	54.85	30.55	5.77	24.66	54.73	74.00	-19.27	PK
V	4960.00	39.91	30.55	5.77	24.66	39.79	54.00	-14.21	AV
V	7440.00	52.98	30.33	6.32	24.55	53.52	74.00	-20.48	PK
V	7440.00	41.29	30.33	6.32	24.55	41.83	54.00	-12.17	AV
V	9920.00	51.55	30.85	7.45	24.69	52.84	74.00	-21.16	PK
V	9920.00	38.45	30.85	7.45	24.69	39.74	54.00	-14.26	AV
H	4960.00	54.19	30.55	5.77	24.66	54.07	74.00	-19.93	PK
H	4960.00	40.55	30.55	5.77	24.66	40.43	54.00	-13.57	AV
H	7440.00	52.98	30.33	6.32	24.55	53.52	74.00	-20.48	PK
H	7440.00	39.93	30.33	6.32	24.55	40.47	54.00	-13.53	AV
H	9920.00	49.92	30.85	7.45	24.69	51.21	74.00	-22.79	PK
H	9920.00	39.04	30.85	7.45	24.69	40.33	54.00	-13.67	AV

5. RADIATED BAND EMISSION MEASUREMENT

5.1 TEST REQUIREMENT:

Test Requirement:	FCC Part15 C Section 15.209 and 15.205				
Test Method:	ANSI C63.10: 2013				
Test Frequency Range:	All of the restrict bands were tested, only the worst band's (2310MHz to 2500MHz) data was showed.				
Test site:	Measurement Distance: 3m				
Receiver setup:	Frequency	Detector	RBW	VBW	Value
	Above 1GHz	Peak	1MHz	3MHz	Peak
		Average	1MHz	3MHz	Average

LIMITS OF RADIATED EMISSION MEASUREMENT (Above 1000MHz)

FREQUENCY (MHz)	Class B (dBuV/m) (at 3M)	
	PEAK	AVERAGE
Above 1000	74	54

Notes:

- (1) The limit for radiated test was performed according to FCC PART 15C.
- (2) The tighter limit applies at the band edges.
- (3) Emission level (dBuV/m)=20log Emission level (uV/m).

5.2 TEST PROCEDURE

Above 1GHz test procedure as below:

- a. 1. The EUT was placed on the top of a rotating table 1.5 meters above the ground at a 3 meter camber. The table was rotated 360 degrees to determine the position of the highest radiation.
- b. The EUT was set 3 meters away from the interference-receiving antenna, which was mounted on the top of a variable-height antenna tower.
- c. The antenna height is varied from one meter to four meters above the ground to determine the maximum value of the field strength. Both horizontal and vertical polarizations of the antenna are set to make the measurement.
- d. For each suspected emission, the EUT was arranged to its worst case and then the antenna was tuned to heights from 1 meter to 4 meters and the rota table was turned from 0 degrees to 360 degrees to find the maximum reading.
- e. The test-receiver system was set to Peak Detect Function and Specified Bandwidth with Maximum Hold Mode.
- f. If the emission level of the EUT in peak mode was 10dB lower than the limit specified, then testing could bestopped and the peak values of the EUT would be reported. Otherwise the emissions that did not have 10dBmargin would be re-tested one by one using peak, quasi-peak or average method as specified and then reportedin a data sheet.
- g. Test the EUT in the lowest channel,the Highest channel

Note:

Both horizontal and vertical antenna polarities were tested and performed pretest to three orthogonal axis. The worst case emissions were reported

5.3 DEVIATION FROM TEST STANDARD

No deviation

5.4 TEST SETUP

Radiated Emission Test-Up Frequency Above 1GHz

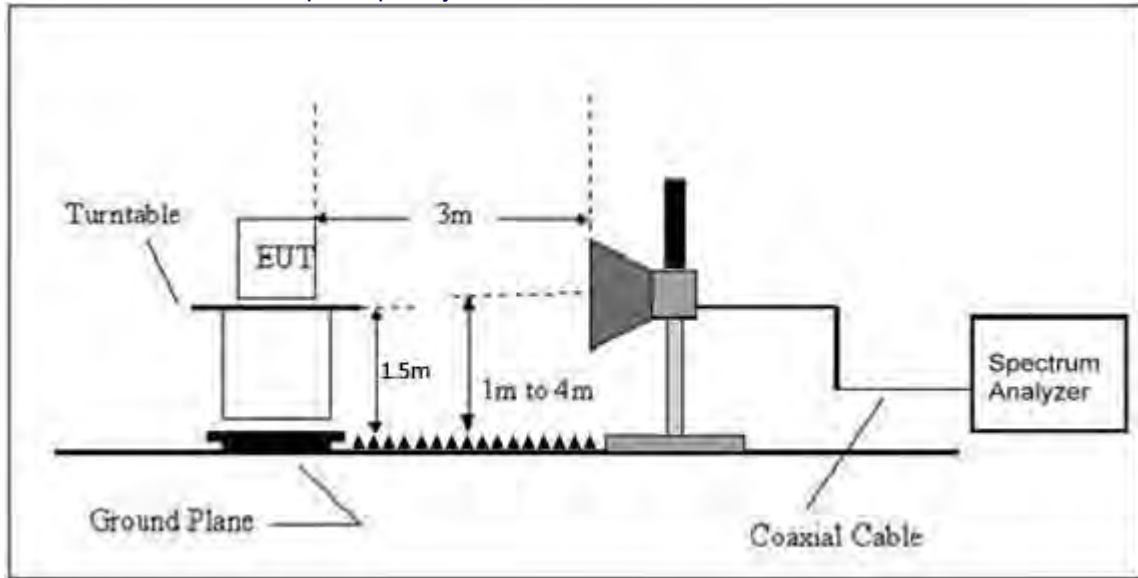

5.5 EUT OPERATING CONDITIONS

The EUT tested system was configured as the statements of 2.3 Unless otherwise a special operating condition is specified in the follows during the testing.

5.6 TEST RESULT

Polar (H/V)	Frequency (MHz)	Meter Reading (dBuV)	Pre-amplifier (dB)	Cable Loss (dB)	Antenna Factor (dB/m)	Emission level (dBuV/m)	Limit (dBuV/m)	Margin(dBuV/m)	Detect or Type	Result
BLE1M--Low Channel 2402MHz										
H	2390.00	52.05	30.22	4.85	23.98	50.66	74	-23.34	PK	PASS
H	2390.00	39.76	30.22	4.85	23.98	38.37	54	-15.63	AV	PASS
H	2400.00	53.00	30.22	4.85	23.98	51.61	74	-22.39	PK	PASS
H	2400.00	38.42	30.22	4.85	23.98	37.03	54	-16.97	AV	PASS
V	2390.00	52.83	30.22	4.85	23.98	51.44	74	-22.56	PK	PASS
V	2390.00	37.27	30.22	4.85	23.98	35.88	54	-18.12	AV	PASS
V	2400.00	53.31	30.22	4.85	23.98	51.92	74	-22.08	PK	PASS
V	2400.00	36.89	30.22	4.85	23.98	35.50	54	-18.50	AV	PASS
BLE1M--High Channel: 2480MHz										
H	2483.50	52.31	30.22	4.85	23.98	50.92	74	-23.08	PK	PASS
H	2483.50	39.23	30.22	4.85	23.98	37.84	54	-16.16	AV	PASS
H	2500.00	54.32	30.22	4.85	23.98	52.93	74	-21.07	PK	PASS
H	2500.00	38.00	30.22	4.85	23.98	36.61	54	-17.39	AV	PASS
V	2483.50	51.11	30.22	4.85	23.98	49.72	74	-24.28	PK	PASS
V	2483.50	38.59	30.22	4.85	23.98	37.20	54	-16.80	AV	PASS
V	2500.00	52.37	30.22	4.85	23.98	50.98	74	-23.02	PK	PASS
V	2500.00	38.30	30.22	4.85	23.98	36.91	54	-17.09	AV	PASS

Remark:

1. Emission Level = Meter Reading + Antenna Factor + Cable Loss – Pre-amplifier, Margin= Emission Level - Limit

6. POWER SPECTRAL DENSITY TEST

Test Requirement:	FCC Part15 C Section 15.247 (e)
Test Method:	KDB558074 D0115.247 Meas Guidance v 05r02

6.1 APPLIED PROCEDURES / LIMIT

FCC Part15 (15.247) , Subpart C				
Section	Test Item	Limit	Frequency Range (MHz)	Result
15.247	Power Spectral Density	8dBm/3kHz	2400-2483.5	PASS

6.2 TEST PROCEDURE

1. Set analyzer center frequency to DTS channel center frequency.
2. Set the span to 1.5 times the DTS bandwidth.
3. Set the RBW to: $3 \text{ kHz} \leq \text{RBW} \leq 100 \text{ kHz}$.
4. Set the VBW $\geq 3 \times \text{RBW}$.
5. Detector = peak.
6. Sweep time = auto couple.
7. Trace mode = max hold.
8. Allow trace to fully stabilize.
9. Use the peak marker function to determine the maximum amplitude level within the RBW.
10. If measured value exceeds limit, reduce RBW (no less than 3 kHz) and repeat.

6.3 DEVIATION FROM STANDARD

No deviation.

6.4 TEST SETUP**6.5 EUT OPERATION CONDITIONS**

The EUT tested system was configured as the statements of 2.1 Unless otherwise a special operating condition is specified in the follows during the testing.

6.6 TEST RESULT

PASS: PLEASE REFER TO APPENDIX: APPENDIX1 FOR DETAILS

7. CHANNEL BANDWIDTH& 99% OCCUPY BANDWIDTH

Test Requirement:	FCC Part15 C Section 15.247 (a)(2)
Test Method:	KDB558074 D0115.247 Meas Guidance v05r02

7.1 APPLIED PROCEDURES / LIMIT

FCC Part15 (15.247) , Subpart C				
Section	Test Item	Limit	Frequency Range(MHz)	Result
15.247(a)(2)	Bandwidth	$\geq 500\text{KHz}$ (6dB bandwidth)	2400-2483.5	PASS

7.2 TEST PROCEDURE

1. Set RBW = 100 kHz.
2. Set the video bandwidth (VBW) $\geq 3 \times \text{RBW}$.
3. Detector = Peak.
4. Trace mode = max hold.
5. Sweep = auto couple.
6. Allow the trace to stabilize.
7. Measure the maximum width of the emission that is constrained by the frequencies associated with the two outermost amplitude points (upper and lower frequencies) that are attenuated by 6 dB relative to the maximum level measured in the fundamental emission.

7.3 DEVIATION FROM STANDARD

No deviation.

7.4 TEST SETUP**7.5 EUT OPERATION CONDITIONS**

The EUT tested system was configured as the statements of 2.4 Unless otherwise a special operating condition is specified in the follows during the testing.

7.6 TEST RESULT

PASS: PLEASE REFER TO APPENDIX: APPENDIX1 FOR DETAILS

8. PEAK OUTPUT POWER TEST

Test Requirement:	FCC Part15 C Section 15.247 (b)(3)
Test Method:	KDB558074 D0115.247 Meas Guidance v05r02

8.1 APPLIED PROCEDURES/LIMIT

FCC Part15 (15.247) , Subpart C				
Section	Test Item	Limit	Frequency Range (MHz)	Result
15.247(b)(3)	Peak Output Power	1 watt or 30dBm	2400-2483.5	PASS

8.2 TEST PROCEDURE

- a. The EUT was directly connected to the spectrum

8.3 DEVIATION FROM STANDARD

No deviation.

8.4 TEST SETUP**8.5 EUT OPERATION CONDITIONS**

The EUT tested system was configured as the statements of 2.4 Unless otherwise a special operating condition is specified in the follows during the testing.

8.6 TEST RESULT

PASS: PLEASE REFER TO APPENDIX: APPENDIX1 FOR DETAILS

9. CONDUCTED BAND EDGE AND SPURIOUS EMISSION

Test Requirement:	FCC Part15 C Section 15.247 (d)
Test Method:	KDB558074 D0115.247 Meas Guidance v05r02

9.1 APPLICABLE STANDARD

in any 100 kHz bandwidth outside the frequency bands in which the spread spectrum intentional radiator is operating, the radio frequency power that is produced by the intentional radiator shall be at least 20dB below that in the 100kHz bandwidth within the band that contains the highest level of the desired power, In addition, radiated emissions which fall in the restricted bands, as defined in§15.205(a), must also comply with the radiated emission limits specified in15.209(a).

9.2 TEST PROCEDURE

Using the following spectrum analyzer setting:

- A) Set the RBW = 100KHz.
- B) Set the VBW = 300KHz.
- C) Sweep time = auto couple.
- D) Detector function = peak.
- E) Trace mode = max hold.
- F) Allow trace to fully stabilize.

9.3 DEVIATION FROM STANDARD

No deviation.

9.4 TEST SETUP



9.5 EUT OPERATION CONDITIONS

The EUT tested system was configured as the statements of 2.4 Unless otherwise a special operating condition is specified in the follows during the testing.

9.6 TEST RESULTS

PASS: PLEASE REFER TO APPENDIX: APPENDIX1 FOR DETAILS

10. ANTENNA REQUIREMENT

Standard requirement:	FCC Part15 C Section 15.203 /247(c)
<p>15.203 requirement: An intentional radiator shall be designed to ensure that no antenna other than that furnished by the responsible party shall be used with the device. The use of a permanently attached antenna or of an antenna that uses a unique coupling to the intentional radiator, the manufacturer may design the unit so that a broken antenna can be replaced by the user, but the use of a standard antenna jack or electrical connector is prohibited.</p> <p>15.247(c) (1)(i) requirement: (i) Systems operating in the 2400-2483.5 MHz band that is used exclusively for fixed. Point-to-point operations may employ transmitting antennas with directional gain greater than 6dBi provided the maximum conducted output power of the intentional radiator is reduced by 1 dB for every 3 dB that the directional gain of the antenna exceeds 6dBi.</p>	
EUT Antenna:	
<p>The antenna is PCB antenna, the best case gain of the antenna is 1.26dBi, reference to the below photo for details ANT for BLE</p> 	

11. APPENDIX1

11.1. -6DB BANDWIDTH

Condition	Antenna	Rate	Frequency (MHz)	-6dB BW(kHz)	limit(kHz)	Result
NVNT	ANT1	1Mbps	2402	525.56	500	Pass
NVNT	ANT1	1Mbps	2440	530.49	500	Pass
NVNT	ANT1	1Mbps	2480	530.53	500	Pass

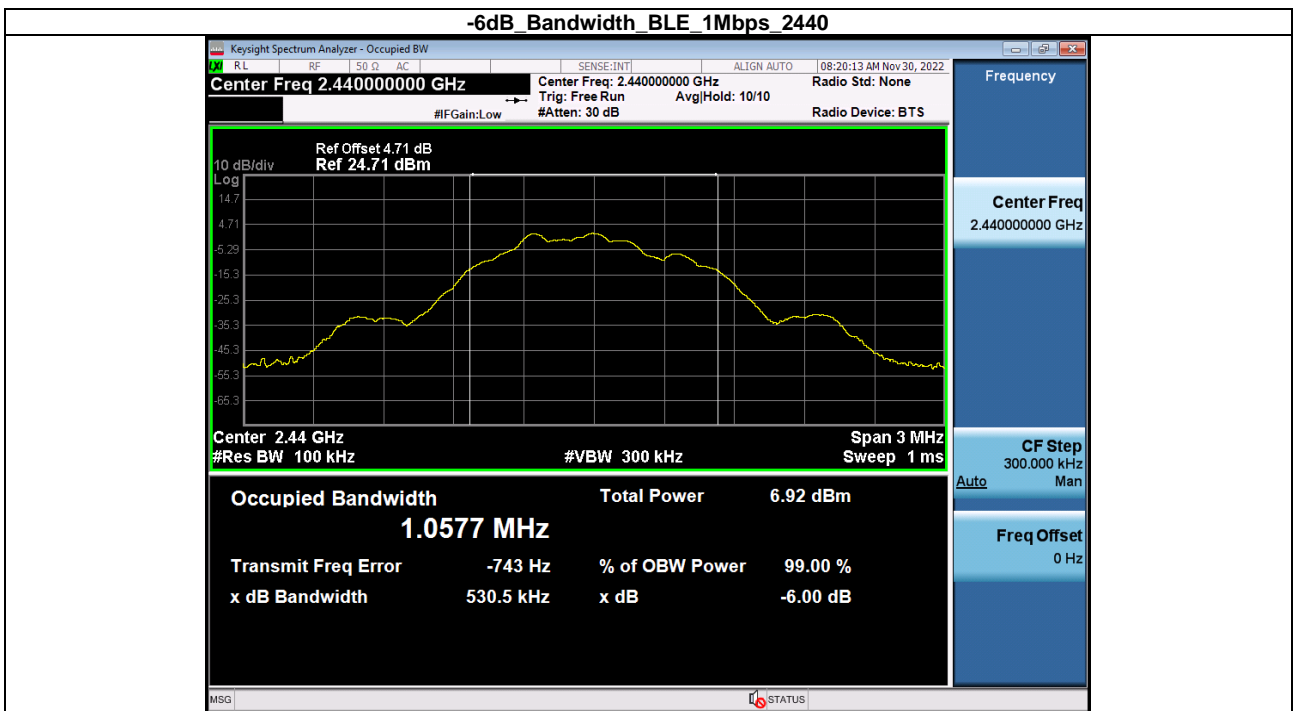
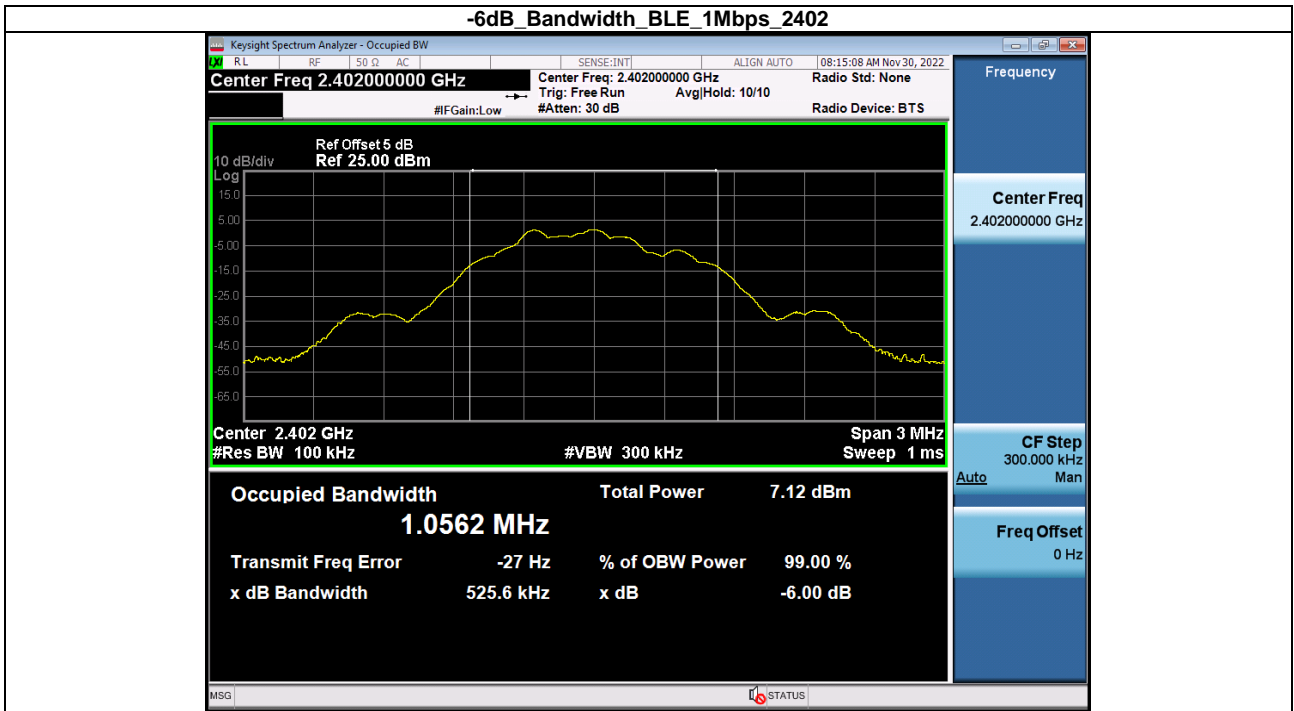

-6dB Bandwidth_BLE_1Mbps_2480



11.2. BANDEDGE

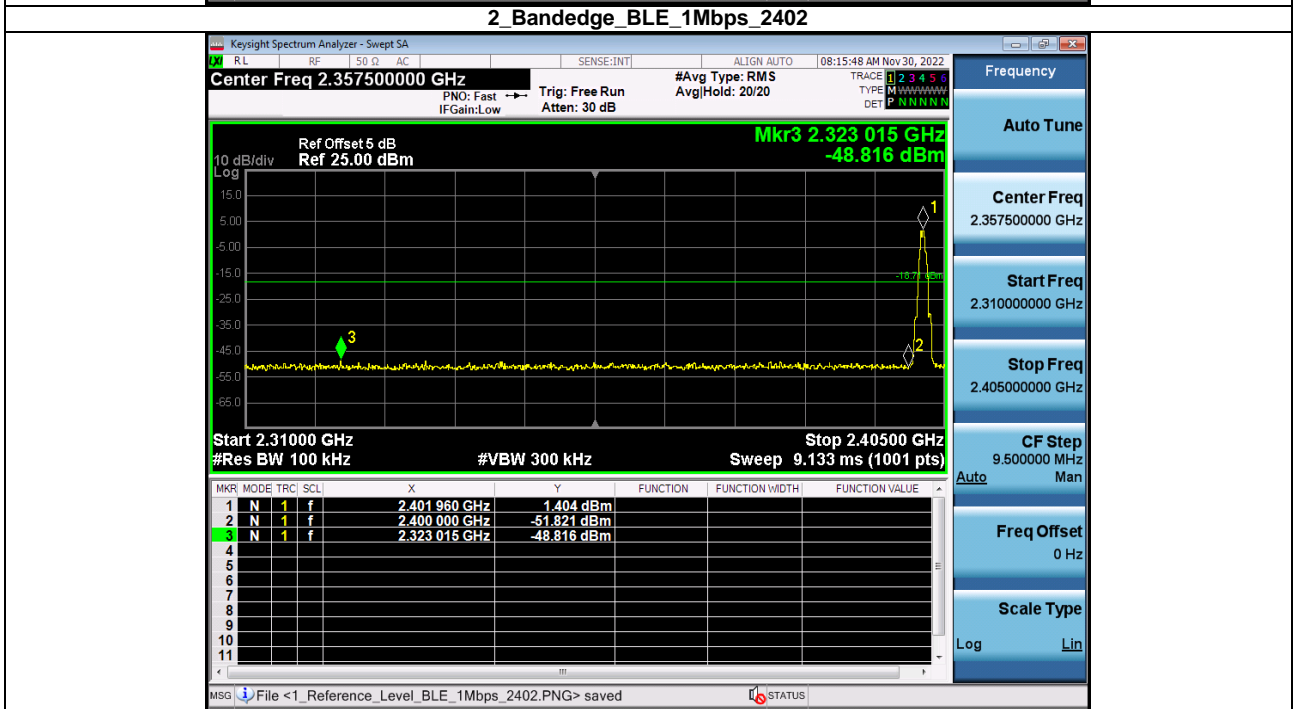
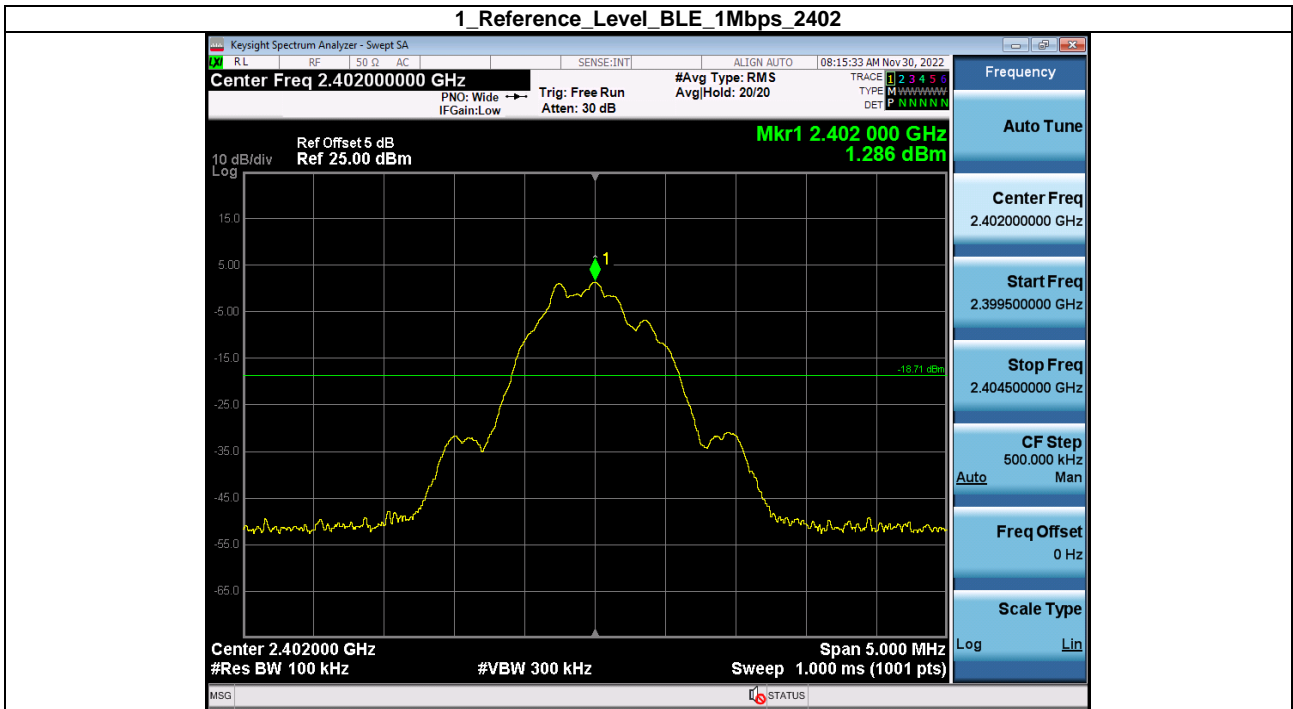

1_Reference_Level_BLE_1Mbps_2480



2_Bandedge_BLE_1Mbps_2480

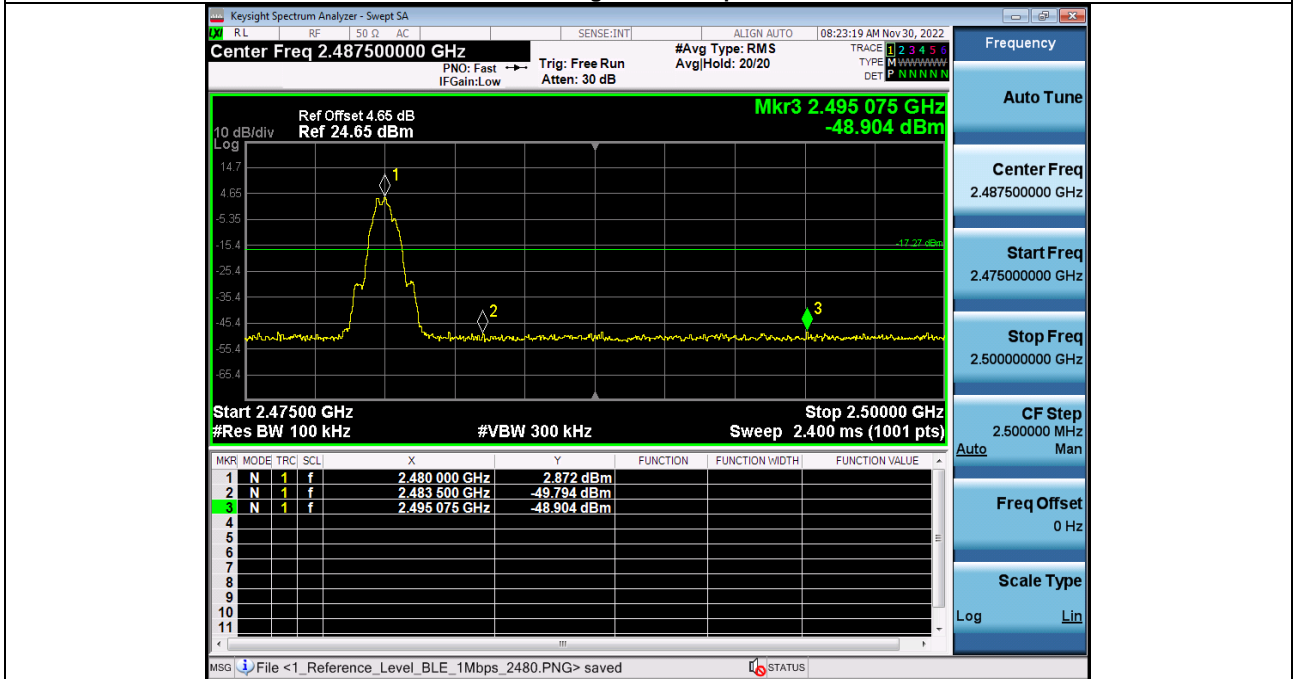

11.3. PEAK OUTPUT POWER

Condition	Antenna	Rate	Frequency (MHz)	Max. Conducted Power(dBm)	Max. Conducted Power(mW)	Limit(mW)	Result
NVNT	ANT1	1Mbps	2402	1.39	1.38	1000	Pass
NVNT	ANT1	1Mbps	2440	1.80	1.51	1000	Pass
NVNT	ANT1	1Mbps	2480	2.86	1.93	1000	Pass

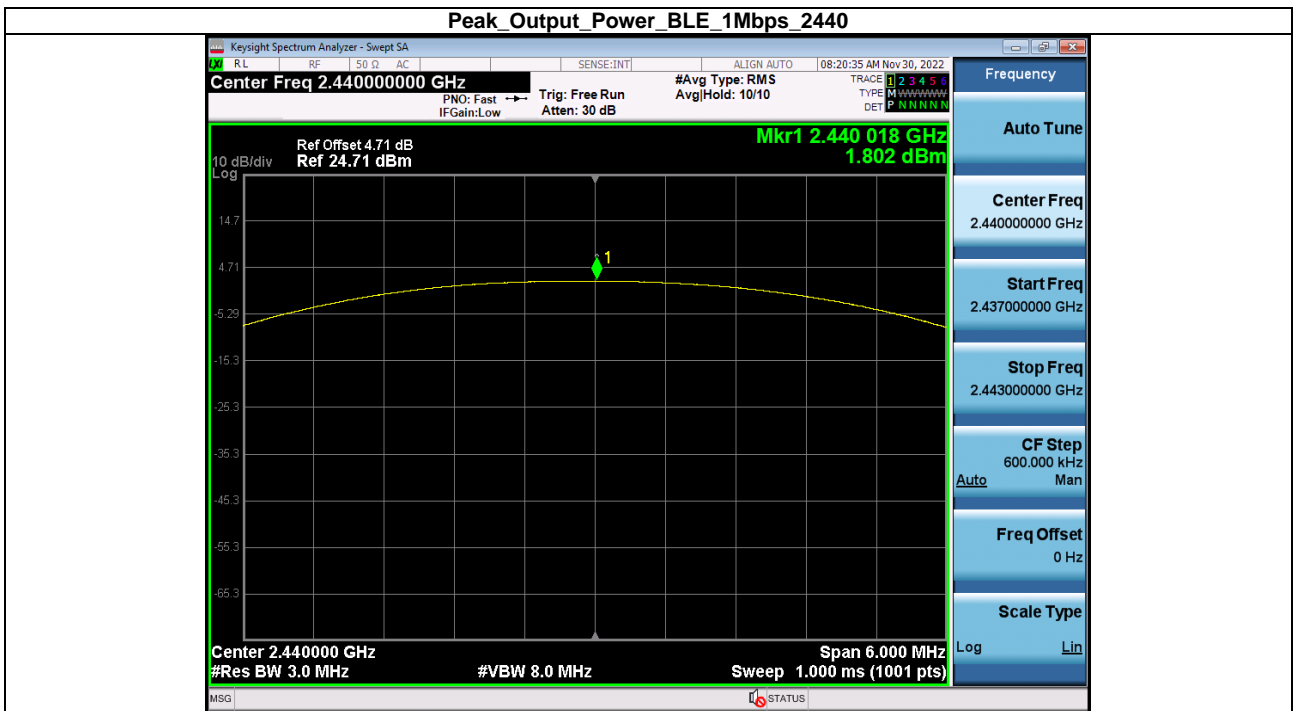
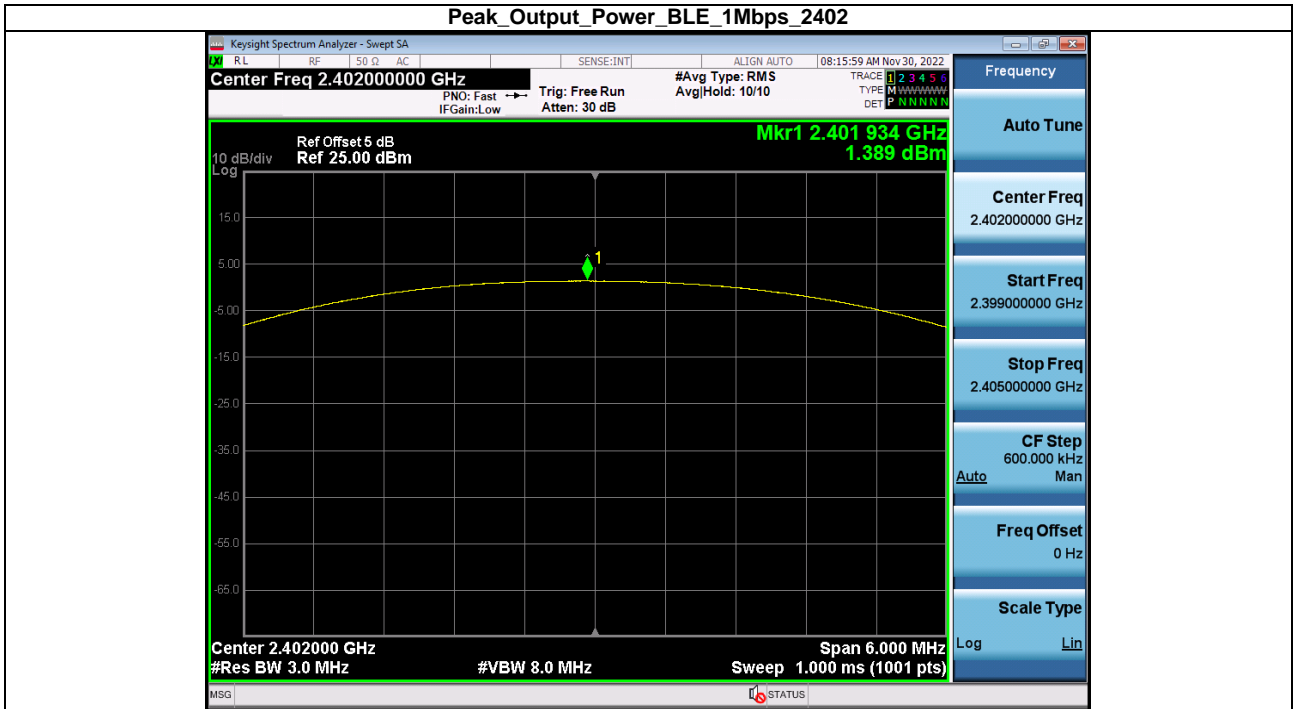

Peak_Output_Power_BLE_1Mbps_2480

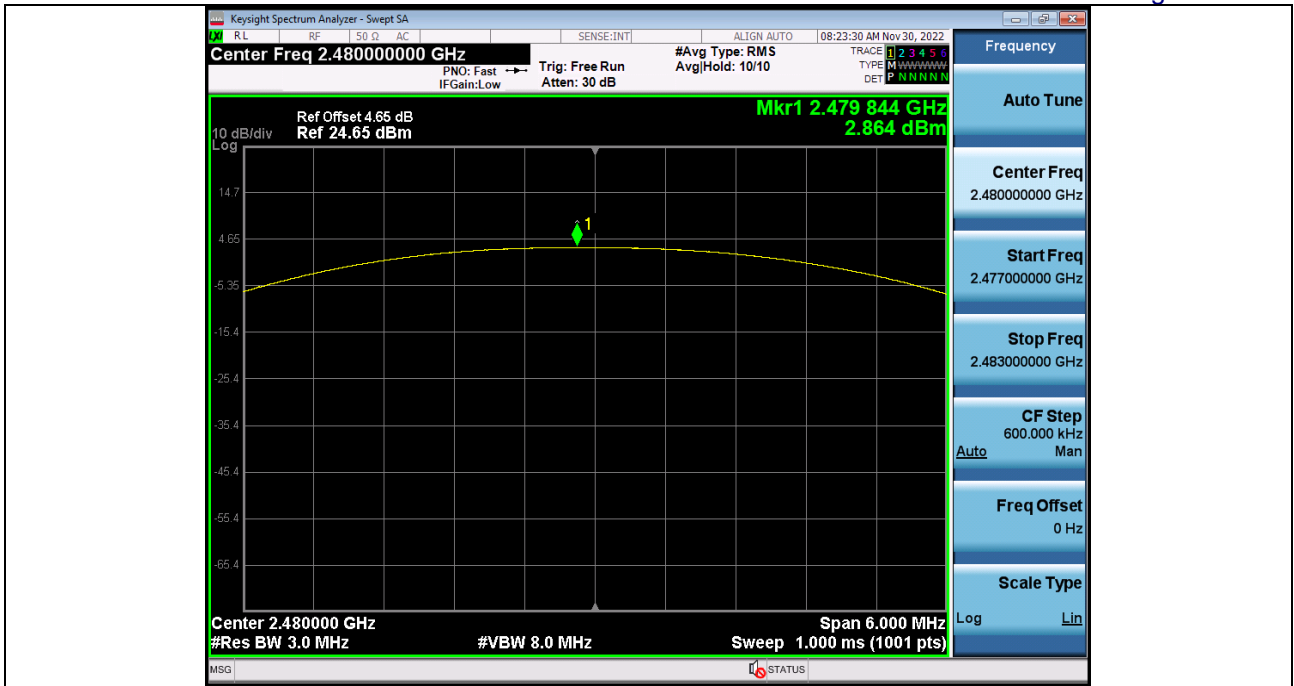

11.4. POWER SPECTRAL DENSITY

Condition	Antenna	Rate	Frequency (MHz)	Power Spectral Density(dBm)	Limit(dBm/3kHz)	Result
NVNT	ANT1	1Mbps	2402	-16.99	8	Pass
NVNT	ANT1	1Mbps	2440	-16.29	8	Pass
NVNT	ANT1	1Mbps	2480	-15.61	8	Pass

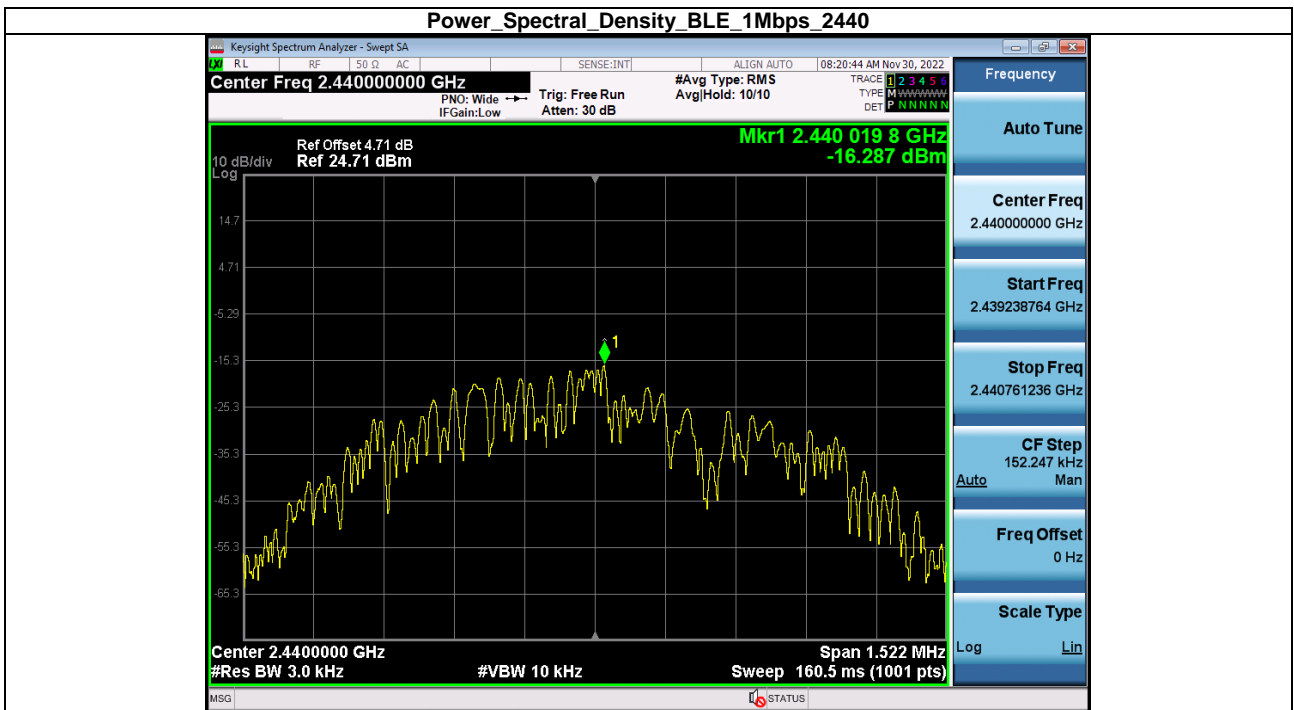
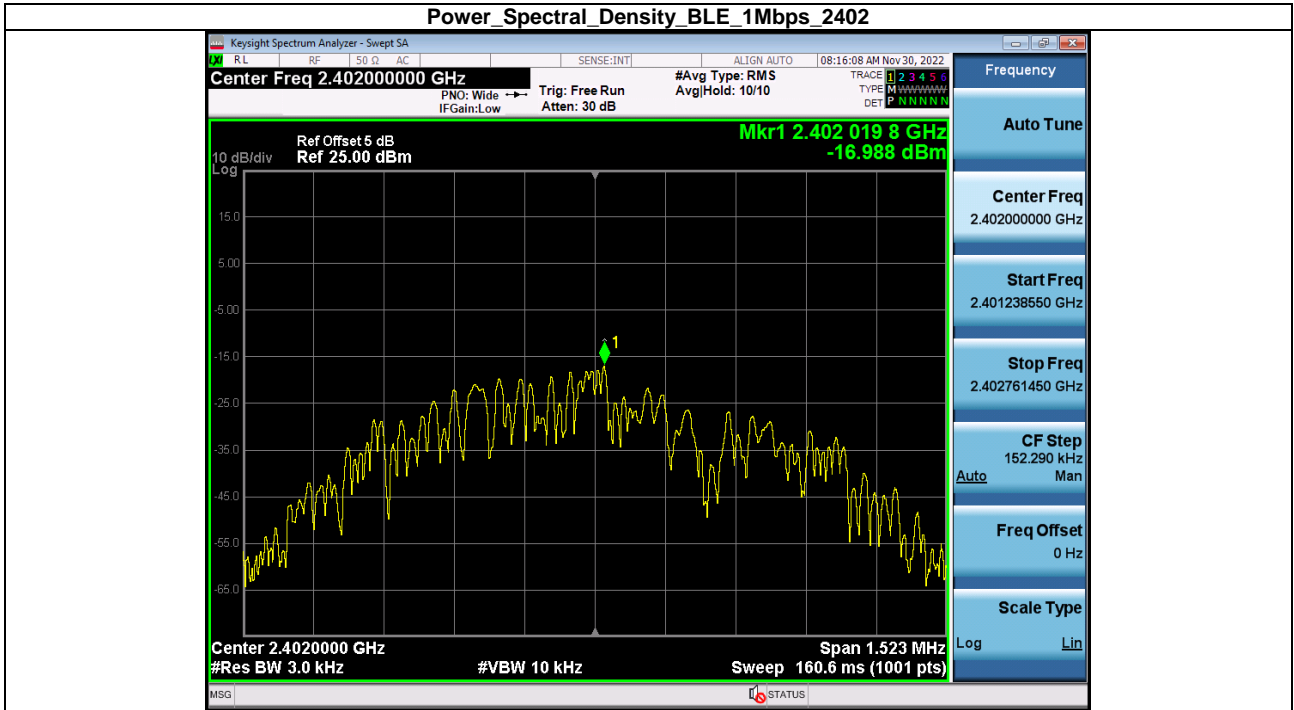

Power_Spectral_Density_BLE_1Mbps_2480



11.5. SPURIOUS EMISSION

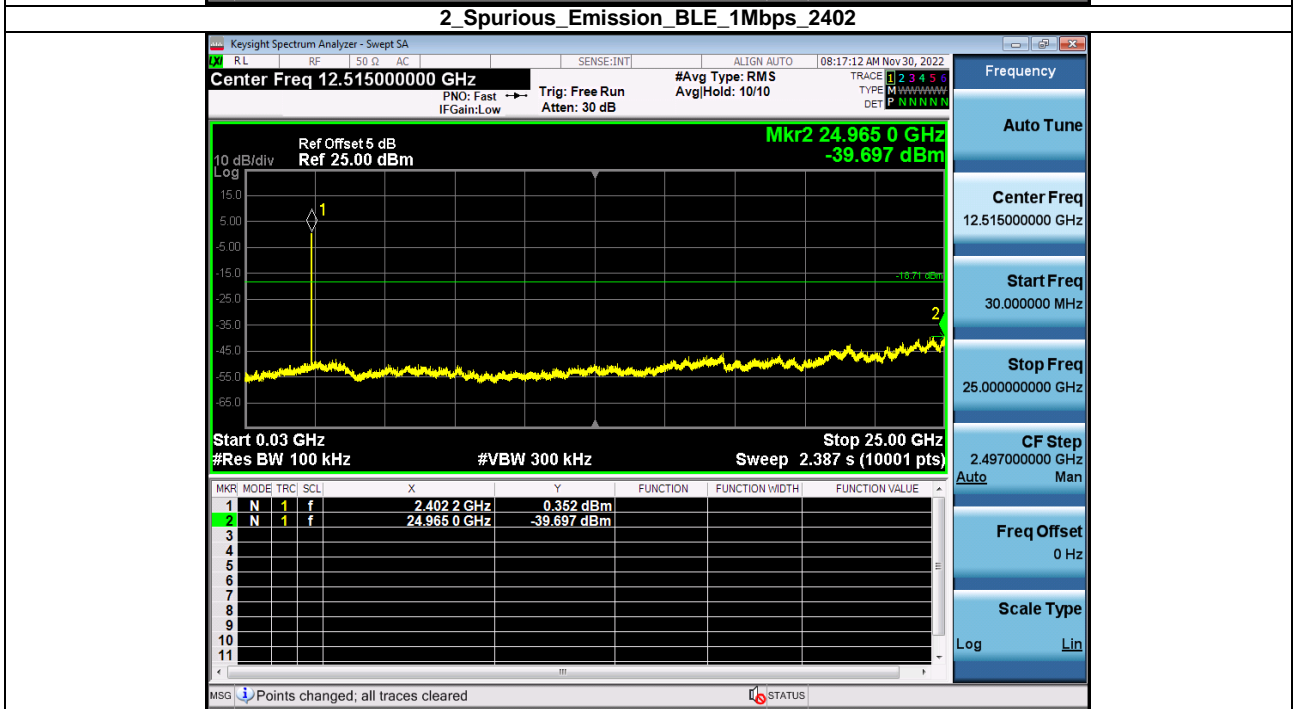
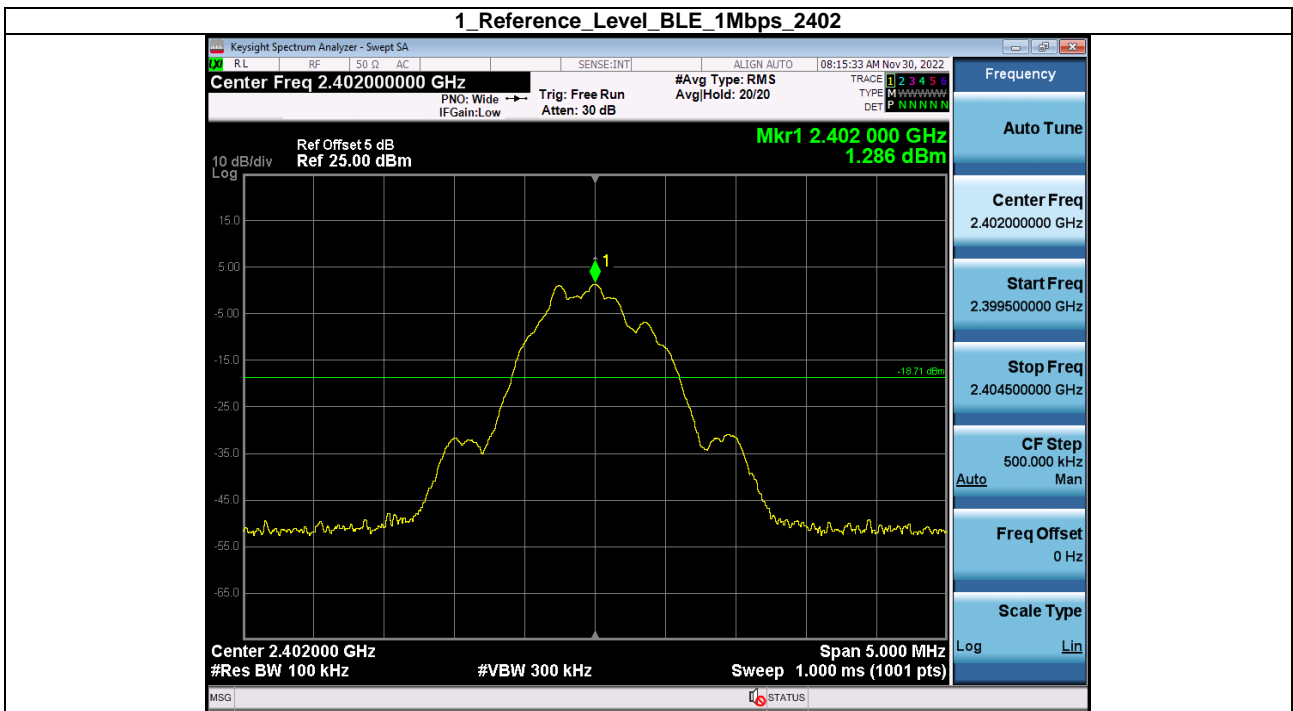

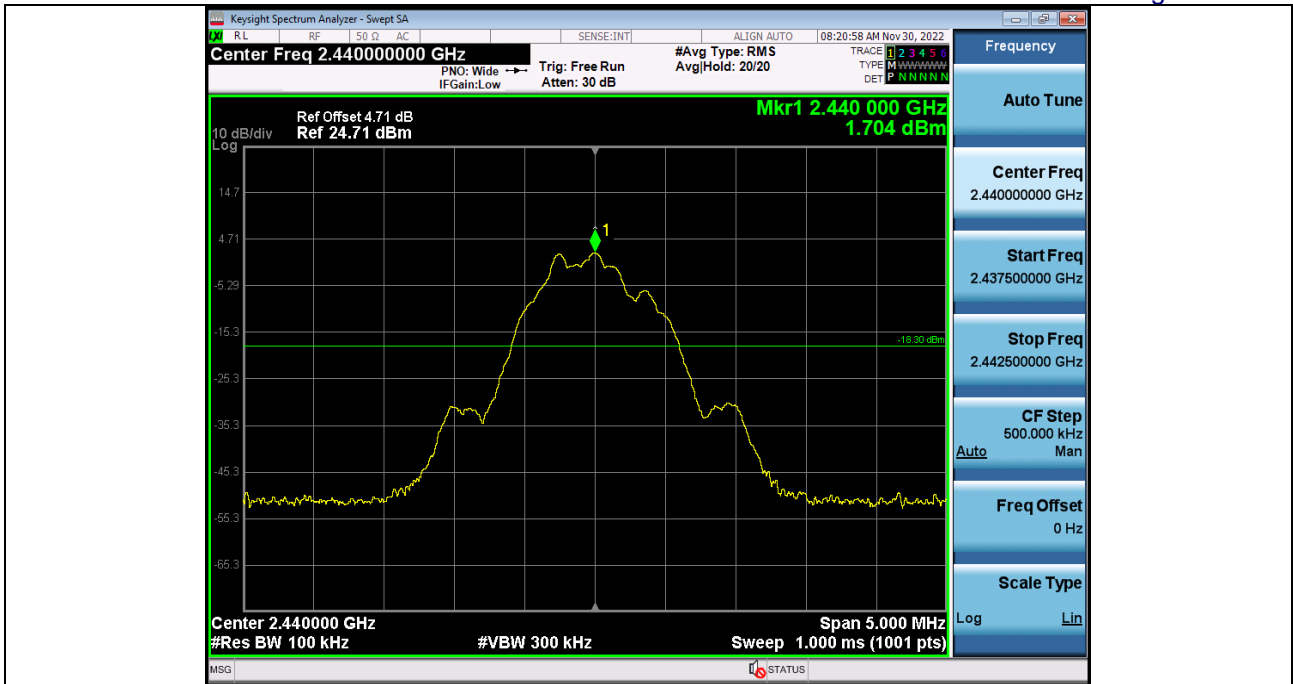

2_Spurious_Emission_BLE_1Mbps_2440

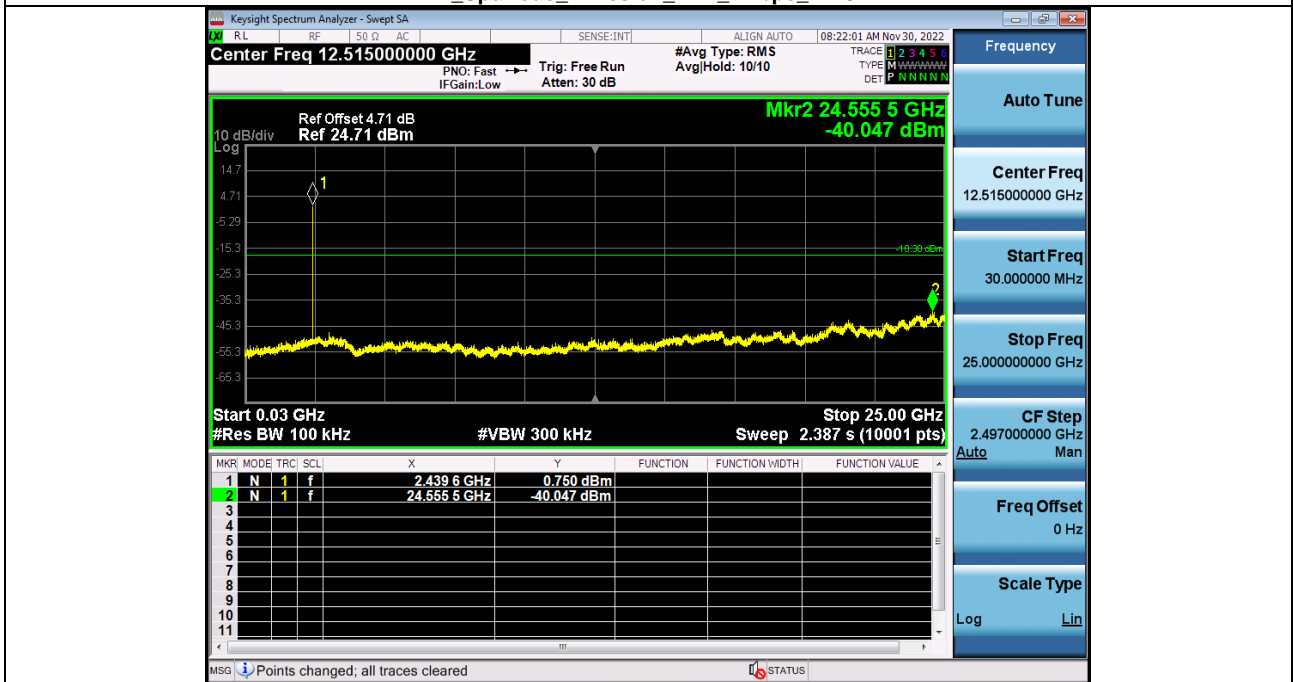

1_Reference_Level_BLE_1Mbps_2480

12. TEST SETUP PHOTO

Please refer to Setup Photo file

13. EUT CONSTRUCTIONAL DETAILS

Please refer to external photos file and internal photos file

******* END OF REPORT *******