



FCC Part 15C Test Report

FCC ID: 2AKL3S1010

Product Name:	Android TV BOX
Trademark:	N/A
Model Name :	SWISS1010 S905X, S905, S805, S912, S812, V8 PRO, X9 PRO, S9 PRO.
Prepared For :	SHENZHEN JUNUO ELECTRONICS CO., LTD
Address :	Building 1, Hezhou New Industrial Park, Hezhou village, Xixiang Town, BAO'AN District, Shenzhen, China
Prepared By :	Shenzhen BCTC Technology Co., Ltd.
Address :	No.101, Yousong Road, Longhua New District, Shenzhen, China
Test Date:	Nov. 28 - Dec. 05, 2016
Date of Report :	Dec. 05, 2016
Report No.:	BCTC-FY161105249E



CERTIFICATION

Applicant's name : SHENZHEN JUNUO ELECTRONICS CO., LTD
Address : Building 1, Hezhou New Industrial Park, Hezhou village, Xixiang Town, BAO'AN District, Shenzhen, China

Manufacture's Name..... : SHENZHEN JUNUO ELECTRONICS CO., LTD
Address : Building 1, Hezhou New Industrial Park, Hezhou village, Xixiang Town, BAO'AN District, Shenzhen, China

Product description

Product name..... : Android TV BOX

Trademark : N/A

Model and/or type reference : SWISS1010

Standards : FCC Part15.247
ANSI C63.10:2013

This device described above has been tested by BCTC, and the test results show that the equipment under test (EUT) is in compliance with the FCC requirements. And it is applicable only to the tested sample identified in the report.

This report shall not be reproduced except in full, without the written approval of BCTC, this document may be altered or revised by BCTC, personal only, and shall be noted in the revision of the document.

Testing Engineer : Eric Yang
Eric Yang

Reviewer (Supervisor) : Jade Yang
Jade Yang

Approved & Authorized Signer(Manager) : 
Carson Zhang

**Table of Contents**

	Page
1 . SUMMARY OF TEST RESULTS	5
1.1 TEST FACILITY	6
1.2 MEASUREMENT UNCERTAINTY	6
2 . GENERAL INFORMATION	7
2.1 GENERAL DESCRIPTION OF EUT	7
2.2 DESCRIPTION OF TEST MODES	8
2.3 BLOCK DIGRAM SHOWING THE CONFIGURATION OF SYSTEM TESTED	9
2.4 DESCRIPTION OF SUPPORT UNITS(CONDUCTED MODE)	9
2.5 EQUIPMENTS LIST FOR ALL TEST ITEMS	10
3 . EMC EMISSION TEST	11
3.1 CONDUCTED EMISSION MEASUREMENT	11
3.1.1 POWER LINE CONDUCTED EMISSION LIMITS	11
3.1.2 TEST PROCEDURE	11
3.1.3 DEVIATION FROM TEST STANDARD	11
3.1.4 TEST SETUP	12
3.1.5 EUT OPERATING CONDITIONS	12
3.1.6 TEST RESULTS	12
3.2 RADIATED EMISSION MEASUREMENT	15
3.2.1 RADIATED EMISSION LIMITS	15
3.2.2 TEST PROCEDURE	16
3.2.3 DEVIATION FROM TEST STANDARD	16
3.2.4 TEST SETUP	16
3.2.5 EUT OPERATING CONDITIONS	17
3.2.6 TEST RESULTS (BETWEEN 9KHZ – 30 MHZ)	18
3.2.7 TEST RESULTS (BETWEEN 30MHZ – 1GHZ)	19
3.2.8 TEST RESULTS (1GHZ~25GHZ)	21
3.3 RADIATED BAND EMISSION MEASUREMENT	25
3.3.1 TEST REQUIREMENT:	25
3.3.2 TEST PROCEDURE	25
3.3.3 DEVIATION FROM TEST STANDARD	26
3.3.4 TEST SETUP	26
3.3.5 EUT OPERATING CONDITIONS	26
4 . POWER SPECTRAL DENSITY TEST	31



Table of Contents		Page
4.1 APPLIED PROCEDURES / LIMIT		31
4.1.1 TEST PROCEDURE		31
4.1.2 DEVIATION FROM STANDARD		31
4.1.3 TEST SETUP		31
4.1.4 EUT OPERATION CONDITIONS		31
4.1.5 TEST RESULTS		32
5 . BANDWIDTH TEST		40
5.1 APPLIED PROCEDURES / LIMIT		40
5.1.1 TEST PROCEDURE		40
5.1.2 DEVIATION FROM STANDARD		40
5.1.3 TEST SETUP		40
5.1.4 EUT OPERATION CONDITIONS		40
5.1.5 TEST RESULTS		41
6 . PEAK OUTPUT POWER TEST		49
6.1 APPLIED PROCEDURES / LIMIT		49
6.1.1 TEST PROCEDURE		49
6.1.2 DEVIATION FROM STANDARD		49
6.1.3 TEST SETUP		49
6.1.4 EUT OPERATION CONDITIONS		49
6.1.5 TEST RESULTS		50
7 . 100 KHZ BANDWIDTH OF FREQUENCY BAND EDGE		51
7.1 APPLICABLE STANDARD		51
7.2 TEST PROCEDURE		51
7.3 DEVIATION FROM STANDARD		51
7.4 TEST SETUP		51
7.5 EUT OPERATION CONDITIONS		51
7.1 TEST RESULTS		51
8 . ANTENNA REQUIREMENT		56
8.1 STANDARD REQUIREMENT		56
8.2 EUT ANTENNA		56
9 . EUT TEST PHOTO		57
10 . EUT PHOTO		59
APPENDIX-PHOTOGRAPHS OF EUT CONSTRUCTIONAL DETAILS		



1. SUMMARY OF TEST RESULTS

Test procedures according to the technical standards:

FCC Part15 (15.247) , Subpart C			
Standard Section	Test Item	Judgment	Remark
15.207 RSS-GEN 8.8 RSS-247 3.1	Conducted Emission	PASS	
15.247 (a)(2) RSS-247 5.2 (1)	6dB Bandwidth	PASS	
15.247 (b) RSS-247 5.4 (3)	Peak Output Power	PASS	
15.247 (c) RSS-247 5.5	Radiated Spurious Emission	PASS	
15.247 (d) RSS-247 5.2 (2)	Power Spectral Density	PASS	
15.205 RSS-247 5.5	Band Edge Emission	PASS	
15.203 RSS-247 5.4	Antenna Requirement	PASS	

NOTE:

(1) "N/A" denotes test is not applicable in this Test Report



1.1 TEST FACILITY

Shenzhen BCTC Technology Co., Ltd.

Add. : No.101, Yousong Road, Longhua New District, Shenzhen, China

FCC Registered No.: 187086

IC Registered No.: 12655A

1.2 MEASUREMENT UNCERTAINTY

The reported uncertainty of measurement $y \pm U$, where expanded uncertainty U is based on a standard uncertainty multiplied by a coverage factor of $k=2$, providing a level of confidence of approximately **95 %**.

No.	Item	Uncertainty
1	Conducted Emission Test	$\pm 1.38\text{dB}$
2	RF power, conducted	$\pm 0.16\text{dB}$
3	Spurious emissions, conducted	$\pm 0.21\text{dB}$
4	All emissions, radiated (<1G)	$\pm 4.68\text{dB}$
5	All emissions, radiated (>1G)	$\pm 4.89\text{dB}$
6	Temperature	$\pm 0.5^\circ\text{C}$
7	Humidity	$\pm 2\%$



2. GENERAL INFORMATION

2.1 GENERAL DESCRIPTION OF EUT

Equipment	Android TV BOX	
Trade Name	N/A	
Model Name	SWISS1010	
Serial Model	S905X, S905, S805, S912, S812, V8 PRO, X9 PRO, S9 PRO.	
Model Difference	All the same, Only model name is different.	
Product Description	The EUT is a Android TV BOX	
	Operation Frequency:	802.11b/g/n20MHz:2412~2462 MHz 802.11n40MHz:2422~2452 MHz
	Modulation Type:	WIFI: OFDM/DSSS
	Bit Rate of Transmitter	802.11b:11/5.5/2/1 Mbps 802.11g:54/48/36/24/18/12/9/6Mbps 802.11n Up to 150Mbps
	Number Of Channel	802.11b/g/n20MHz:11 CH 802.11n40MHz: 7 CH
	Antenna Designation:	Please see Note 3.
Based on the application, features, or specification exhibited in User's Manual, the EUT is considered as an ITE/Computing Device. More details of EUT technical specification, please refer to the User's Manual.		
Channel List	Please refer to the Note 2.	
Power Source	DC 5V From Adapter	
Adapter	Model: XHY050200LUCH I/P:AC 100-240V 50/60Hz 0.5A O/P: DC 5V 2.0A	
hardware version	--	
Software version	--	
Serial number	--	
Connecting I/O Port(s)	Please refer to the User's Manual	

Note:

1. For a more detailed features description, please refer to the manufacturer's specifications or the User's Manual.

2.

Channel	Frequency (MHz)	Channel	Frequency (MHz)	Channel	Frequency (MHz)	Channel	Frequency (MHz)
01	2412	04	2427	07	2442	10	2457
02	2417	05	2432	08	2447	11	2462
03	2422	06	2437	09	2452		



Channel List for 802.11n(40)							
Channel	Frequency (MHz)	Channel	Frequency (MHz)	Channel	Frequency (MHz)	Channel	Frequency (MHz)
03	2422	05	2432	07	2442	09	2452
04	2427	06	2437	08	2447		

3. Table for Filed Antenna

Ant.	Brand	Model Name	Antenna Type	Gain (dBi)	NOTE
1	N/A	N/A	Internal antenna	1.0dBi	

2.2 DESCRIPTION OF TEST MODES

Pretest Mode	Description
Mode 1	802.11b CH1/ CH6/ CH11
Mode 2	802.11g CH1/ CH6/ CH11
Mode 3	802.11n20 CH1/ CH6/ CH11
Mode 4	802.11n40 CH3/ CH6/ CH9
Mode 5	Link Mode

Conducted Emission	
Final Test Mode	Description
Mode 5	Link Mode

For Radiated Emission	
Final Test Mode	Description
Mode 1	802.11b CH1/ CH6/ CH11
Mode 2	802.11g CH1/ CH6/ CH11
Mode 3	802.11n20 CH1/ CH6/ CH11
Mode 4	802.11n40 CH3/ CH6/ CH9

Note:

(1) The measurements are performed at all Bit Rate of Transmitter, the worst data was reported.

2.3 BLOCK DIGRAM SHOWING THE CONFIGURATION OF SYSTEM TESTED

Conducted Emission Test

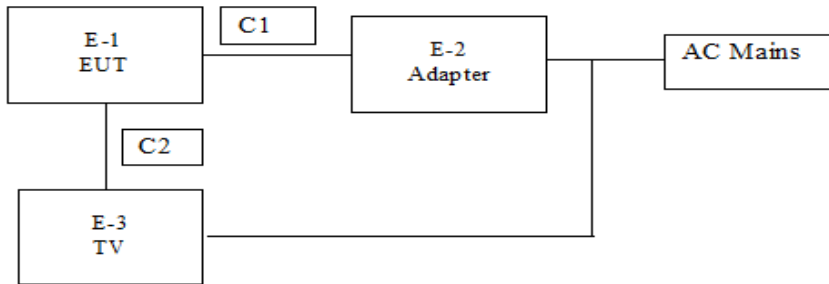

Radiated Spurious Emission Test

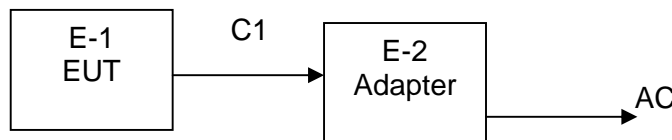

2.4 DESCRIPTION OF SUPPORT UNITS(CONDUCTED MODE)

The EUT has been tested as an independent unit together with other necessary accessories or support units. The following support units or accessories were used to form a representative test configuration during the tests.

Item	Equipment	Mfr/Brand	Model/Type No.	Series No.	Note
E-1	Android TV BOX	N/A	SWISS1010	N/A	EUT
E-2	Adapter	N/A	XHY050200LUCH		
E-3	TV	PHILIPS	24PFL3543/T3	WJ3C1528000141	AC100-240V 50/60Hz 36W

Item	Shielded Type	Ferrite Core	Length	Note
C1	No	No	1.0m	DC cable
C2	NO	NO	1.0M	HDMI cable shielded

Note:

- (1) The support equipment was authorized by Declaration of Confirmation.
- (2) For detachable type I/O cable should be specified the length in cm in 『Length』 column.



2.5 EQUIPMENTS LIST FOR ALL TEST ITEMS

Radiation Test equipment

Item	Kind of Equipment	Manufacturer	Type No.	Serial No.	Last calibration	Calibrated until
1	Spectrum Analyzer	Agilent	E4407B	MY45109572	2016.08.27	2017.08.26
2	Test Receiver	R&S	ESPI	101396	2016.08.27	2017.08.26
3	Bilog Antenna	SCHWARZBECK	VULB9160	VULB9160-3369	2016.08.27	2017.08.26
4	50Ω Coaxial Switch	Anritsu	MP59B	6200264416	2016.08.27	2017.08.26
5	Spectrum Analyzer	Agilent	N9020A	MY5051041	2016.08.27	2017.08.26
6	Horn Antenna	SCHWARZBECK	9120D	9120D-1275	2016.08.27	2017.08.26
7	Horn Ant	Schwarzbeck	BBHA 9170	9170-181	2016.08.25	2017.08.24
8	Amplifier	SCHWARZBECK	BBV9718	9718-270	2016.08.25	2017.08.24
9	Amplifier	SCHWARZBECK	BBV9743	9743-119	2016.08.25	2017.08.24
10	Loop Antenna	ARA	PLSWISS101030/B	1029	2016.08.25	2017.08.24
11	Power Meter	R&S	NRVS	100696	2016.08.27	2017.08.26
12	Power Sensor	R&S	NRV-Z55	161905	2016.08.27	2017.08.26
13	RF cables	R&S	N/A	N/A	2016.08.27	2017.08.26

Conduction Test equipment

Item	Kind of Equipment	Manufacturer	Type No.	Serial No.	Last calibration	Calibrated until
1	Test Receiver	R&S	ESCI	1166.5950K03-101165-ha	2016.08.27	2017.08.26
2	LISN	R&S	NSLK8126	8126466	2016.08.27	2017.08.26
3	LISN	R&S	NSLK8126	8126487	2016.08.27	2017.08.26
4	50Ω Coaxial Switch	Anritsu	MP59B	6200264417	2016.08.27	2017.08.26
5	RF cables	R&S	R204	R20X	2016.08.27	2017.08.26



3. EMC EMISSION TEST

3.1 CONDUCTED EMISSION MEASUREMENT

3.1.1 POWER LINE CONDUCTED EMISSION Limits (Frequency Range 150KHz-30MHz)

FREQUENCY (MHz)	Class A (dBuV)		Class B (dBuV)		Standard
	Quasi-peak	Average	Quasi-peak	Average	
0.15 -0.5	79.00	66.00	66 - 56 *	56 - 46 *	FCC
0.50 -5.0	73.00	60.00	56.00	46.00	FCC
5.0 -30.0	73.00	60.00	60.00	50.00	FCC

Note:

- (1) The tighter limit applies at the band edges.
- (2) The limit of " * " marked band means the limitation decreases linearly with the logarithm of the frequency in the range.

The following table is the setting of the receiver

Receiver Parameters	Setting
Attenuation	10 dB
Start Frequency	0.15 MHz
Stop Frequency	30 MHz
IF Bandwidth	9 kHz

3.1.2 TEST PROCEDURE

- a. The EUT was placed 0.8 meters from the horizontal ground plane with EUT being connected to the power mains through a line impedance stabilization network (LISN). All other support equipments powered from additional LISN(s). The LISN provide 50 Ohm/ 50uH of coupling impedance for the measuring instrument.
- b. Interconnecting cables that hang closer than 40 cm to the ground plane shall be folded back and forth in the center forming a bundle 30 to 40 cm long.
- c. I/O cables that are not connected to a peripheral shall be bundled in the center. The end of the cable may be terminated, if required, using the correct terminating impedance. The overall length shall not exceed 1 m.
- d. LISN at least 80 cm from nearest part of EUT chassis.
- e. For the actual test configuration, please refer to the related Item –EUT Test Photos.

3.1.3 DEVIATION FROM TEST STANDARD

No deviation

3.1.4 TEST SETUP

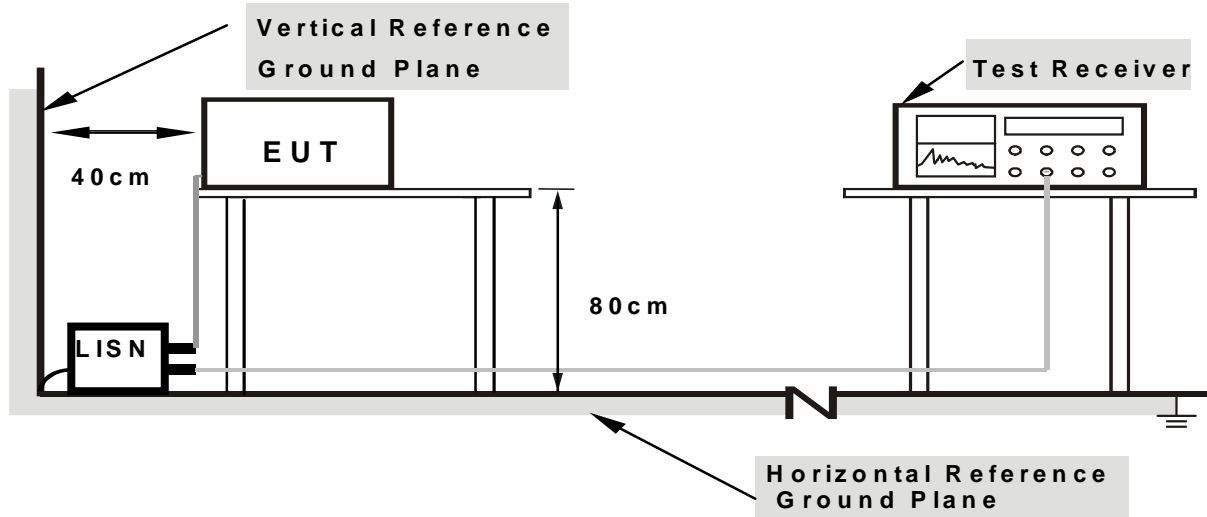

Note: 1. Support units were connected to second LISN.

2. Both of LISNs (AMN) are 80 cm from EUT and at least 80 cm from other units and other metal planes

3.1.5 EUT OPERATING CONDITIONS

The EUT was configured for testing in a typical fashion (as a customer would normally use it). The EUT has been programmed to continuously transmit during test. This operating condition was tested and used to collect the included data.

We pretest AC 120V and AC 240V, the worst voltage was AC 120V and the data recording in the report.

3.1.6 TEST RESULTS



Temperature :	25 °C	Relative Humidity :	54%
Pressure :	1010hPa	Phase :	L
Test Voltage :	AC 120V/60Hz	Test Mode :	Mode 5

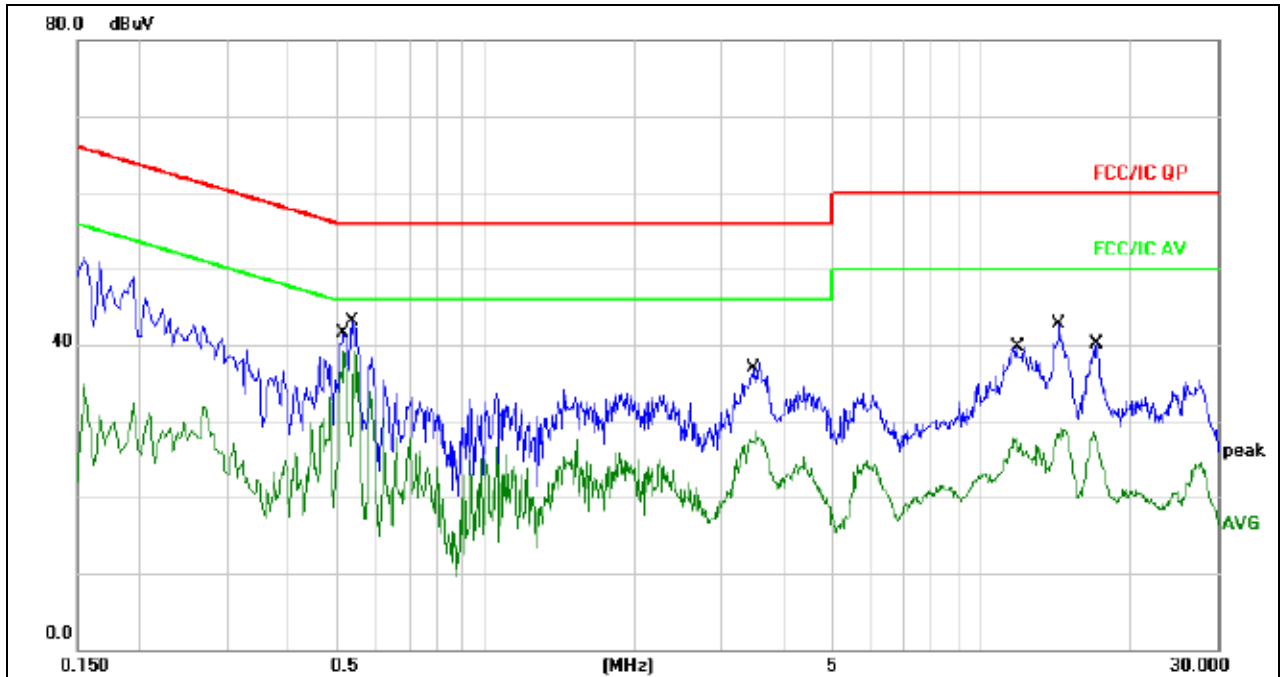

Remark:

1. All readings are Quasi-Peak and Average values.
2. Factor = Insertion Loss + Cable Loss.

No.	Mk.	Freq. MHz	Reading Level dBuV	Correct Factor dB	Measure- ment dBuV	Limit dBuV	Over dB	Detector	Comment
1		0.5180	31.76	9.68	41.44	56.00	-14.56	QP	
2		0.5180	29.36	9.68	39.04	46.00	-6.96	AVG	
3		0.5380	33.49	9.68	43.17	56.00	-12.83	QP	
4	*	0.5380	29.42	9.68	39.10	46.00	-6.90	AVG	
5		3.5260	27.92	9.73	37.65	56.00	-18.35	QP	
6		3.5260	18.93	9.73	28.66	46.00	-17.34	AVG	
7		11.7540	29.95	9.82	39.77	60.00	-20.23	QP	
8		11.7540	17.83	9.82	27.65	50.00	-22.35	AVG	
9		14.3660	32.83	9.86	42.69	60.00	-17.31	QP	
10		14.5820	19.14	9.86	29.00	50.00	-21.00	AVG	
11		16.8580	30.21	9.89	40.10	60.00	-19.90	QP	
12		16.8580	18.70	9.89	28.59	50.00	-21.41	AVG	



Temperature :	25 °C	Relative Humidity :	54%
Pressure :	1010hPa	Phase :	N
Test Voltage :	AC 120V/60Hz	Test Mode :	Mode 5

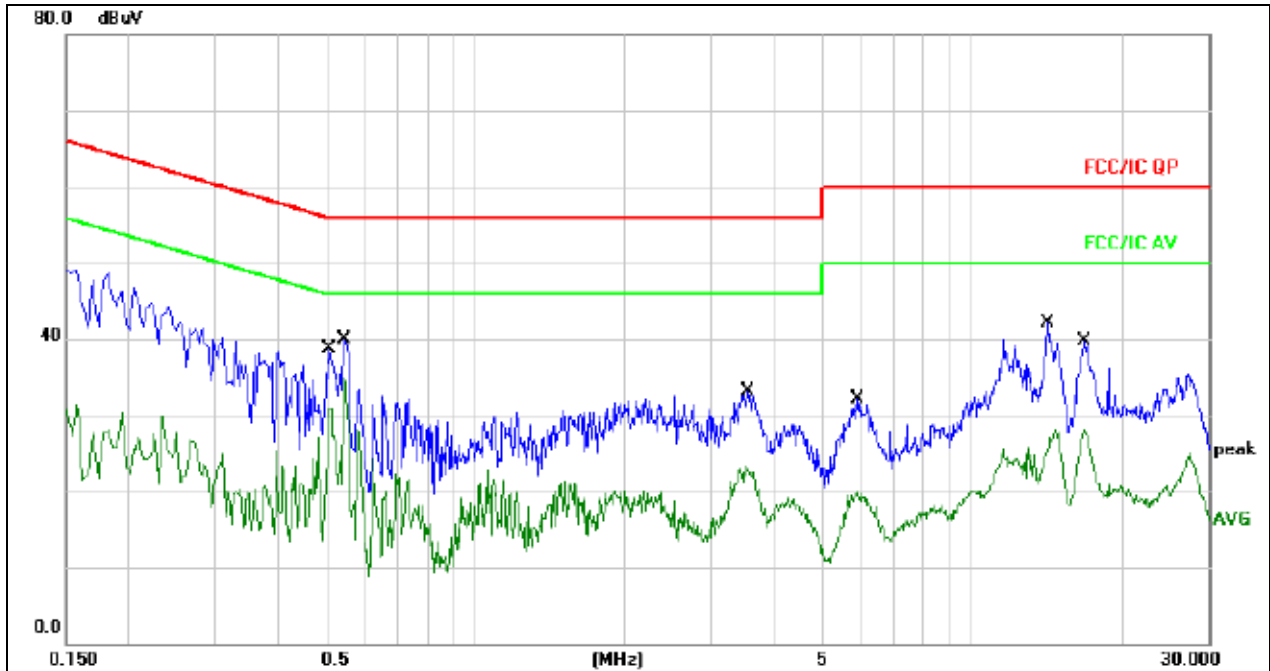

Remark:

1. All readings are Quasi-Peak and Average values.
2. Factor = Insertion Loss + Cable Loss.

No.	Mk.	Freq. MHz	Reading Level dBuV	Correct Factor dB	Measure- ment dBuV	Limit dBuV	Over dB	Detector	Comment
1		0.5100	29.07	9.68	38.75	56.00	-17.25	QP	
2		0.5100	21.17	9.68	30.85	46.00	-15.15	AVG	
3		0.5460	30.12	9.68	39.80	56.00	-16.20	QP	
4	*	0.5460	25.12	9.68	34.80	46.00	-11.20	AVG	
5		3.5180	23.38	9.73	33.11	56.00	-22.89	QP	
6		3.5180	13.54	9.73	23.27	46.00	-22.73	AVG	
7		5.9180	22.32	9.76	32.08	60.00	-27.92	QP	
8		5.9180	10.05	9.76	19.81	50.00	-30.19	AVG	
9		14.2500	32.32	9.85	42.17	60.00	-17.83	QP	
10		14.2500	18.24	9.85	28.09	50.00	-21.91	AVG	
11		16.9060	29.87	9.89	39.76	60.00	-20.24	QP	
12		16.9060	18.29	9.89	28.18	50.00	-21.82	AVG	



3.2 RADIATED EMISSION MEASUREMENT

3.2.1 RADIATED EMISSION LIMITS (Frequency Range 9kHz-1000MHz)

20dBc in any 100 kHz bandwidth outside the operating frequency band. In case the emission fall within the restricted band specified on 15.205(a), then the 15.209(a) limit in the table below has to be followed.

Frequencies (MHz)	Field Strength (micorvolts/meter)	Measurement Distance (meters)
0.009~0.490	2400/F(KHz)	300
0.490~1.705	24000/F(KHz)	30
1.705~30.0	30	30
30~88	100	3
88~216	150	3
216~960	200	3
Above 960	500	3

LIMITS OF RADIATED EMISSION MEASUREMENT (Above 1000MHz)

FREQUENCY (MHz)	Class B (dBuV/m) (at 3M)	
	PEAK	AVERAGE
Above 1000	74	54

Notes:

- (1) The limit for radiated test was performed according to FCC PART 15C.
- (2) The tighter limit applies at the band edges.
- (3) Emission level (dBuV/m)=20log Emission level (uV/m).

Spectrum Parameter	Setting
Attenuation	Auto
Start Frequency	1000 MHz
Stop Frequency	25GHz
RB / VB (emission in restricted band)	1 MHz / 1 MHz for Peak, 1 MHz / 10Hz for Average

Receiver Parameter	Setting
Attenuation	Auto
Start ~ Stop Frequency	9kHz~150kHz / RB 200Hz for QP
Start ~ Stop Frequency	150kHz~30MHz / RB 9kHz for QP
Start ~ Stop Frequency	30MHz~1000MHz / RB 120kHz for QP

3.2.2 TEST PROCEDURE

Below 1GHz test procedure as below:

- a. The EUT was placed on the top of a rotating table 0.8 meters above the ground at a 3 meter semi-anechoic chamber. The table was rotated 360 degrees to determine the position of the highest radiation.
- b. The EUT was set 3 meters away from the interference-receiving antenna, which was mounted on the top of a variable-height antenna tower.
- c. The antenna height is varied from one meter to four meters above the ground to determine the maximum value of the field strength. Both horizontal and vertical polarizations of the antenna are set to make the measurement.
- d. For each suspected emission, the EUT was arranged to its worst case and then the antenna was tuned to heights from 1 meter to 4 meters (for the test frequency of below 30MHz, the antenna was tuned to heights 1 meter) and the rotatable table was turned from 0 degrees to 360 degrees to find the maximum reading.
- e. The test-receiver system was set to Peak Detect Function and Specified Bandwidth with Maximum Hold Mode.
- f. If the emission level of the EUT in peak mode was 10dB lower than the limit specified, then testing could be stopped and the peak values of the EUT would be reported. Otherwise the emissions that did not have 10dB margin would be re-tested one by one using peak, quasi-peak or average method as specified and then reported in a data sheet.

Above 1GHz test procedure as below:

- g. Different between above is the test site, change from Semi- Anechoic Chamber to fully Anechoic Chamber and change form table 0.8 metre to 1.5 metre(Above 18GHz the distance is 1 meter and table is 1.5 metre).
- h. Test the EUT in the lowest channel ,the middle channel ,the Highest channel

Note:

Both horizontal and vertical antenna polarities were tested and performed pretest to three orthogonal axis. The worst case emissions were reported

3.2.3 DEVIATION FROM TEST STANDARD

No deviation

3.2.4 TEST SETUP

(A) Radiated Emission Test-Up Frequency Below 30MHz

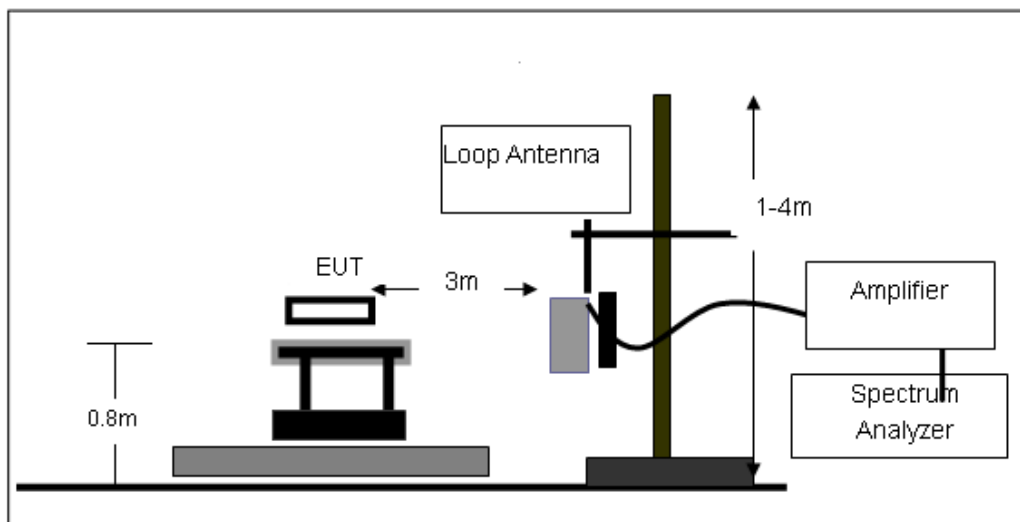

(B) Radiated Emission Test-Up Frequency 30MHz~1GHz

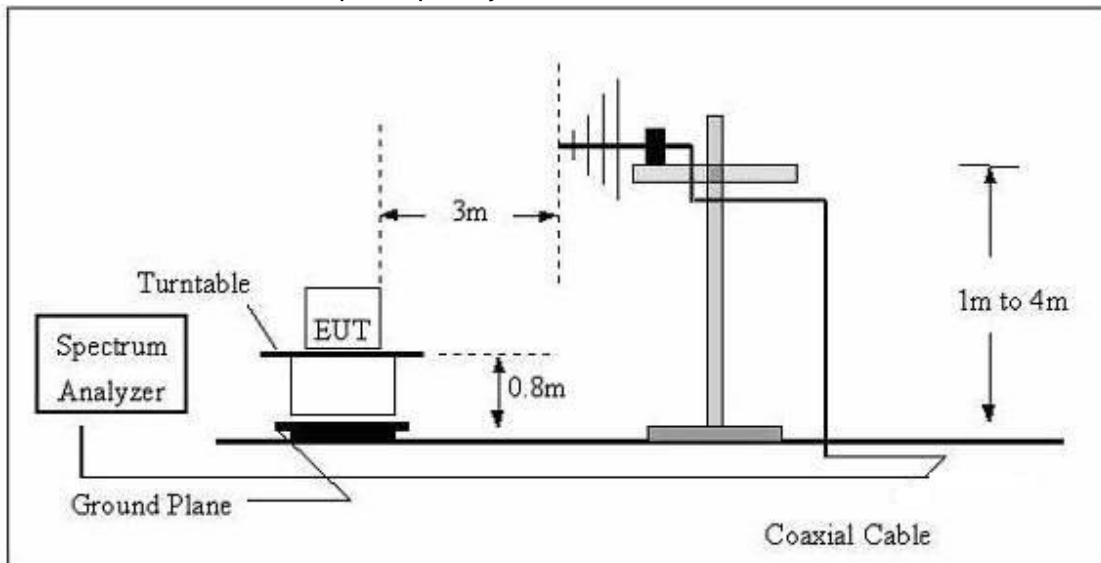

(C) Radiated Emission Test-Up Frequency Above 1GHz

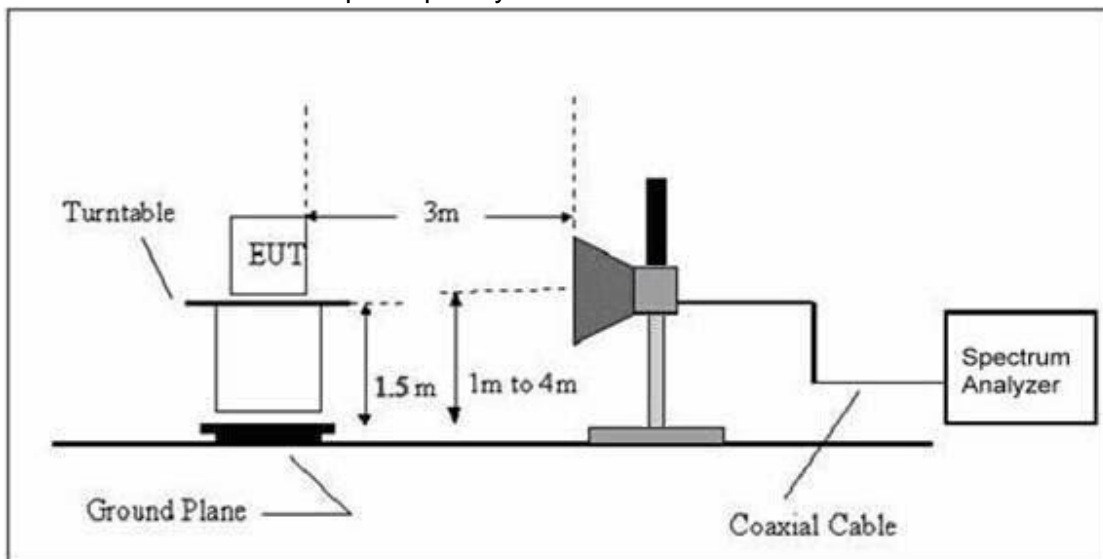

3.2.5 EUT OPERATING CONDITIONS

The EUT tested system was configured as the statements of 2.4 Unless otherwise a special operating condition is specified in the follows during the testing.

**3.2.6 TEST RESULTS (BETWEEN 9KHZ – 30 MHZ)**

Temperature:	20°C	Relative Humidity:	48%
Pressure:	1010 hPa	Test Voltage :	DC 5V From Adapter
Test Mode :	Mode 5	Polarization :	--

Freq. (MHz)	Reading (dBuV/m)	Limit (dBuV/m)	Margin (dB)	State P/F
--	--	--	--	PASS
--	--	--	--	PASS

NOTE:

The amplitude of spurious emissions which are attenuated by more than 20dB below the permissible value has no need to be reported.

Distance extrapolation factor = $40 \log(\text{specific distance}/\text{test distance})$ (dB);

Limit line = specific limits(dBuv) + distance extrapolation factor.



3.2.7 TEST RESULTS (BETWEEN 30MHZ – 1GHZ)

Temperature :	26°C	Relative Humidity :	54%
Pressure :	1010 hPa	Polarization :	Horizontal
Test Voltage :	DC 5V From Adapter		
Test Mode :	Mode 5		

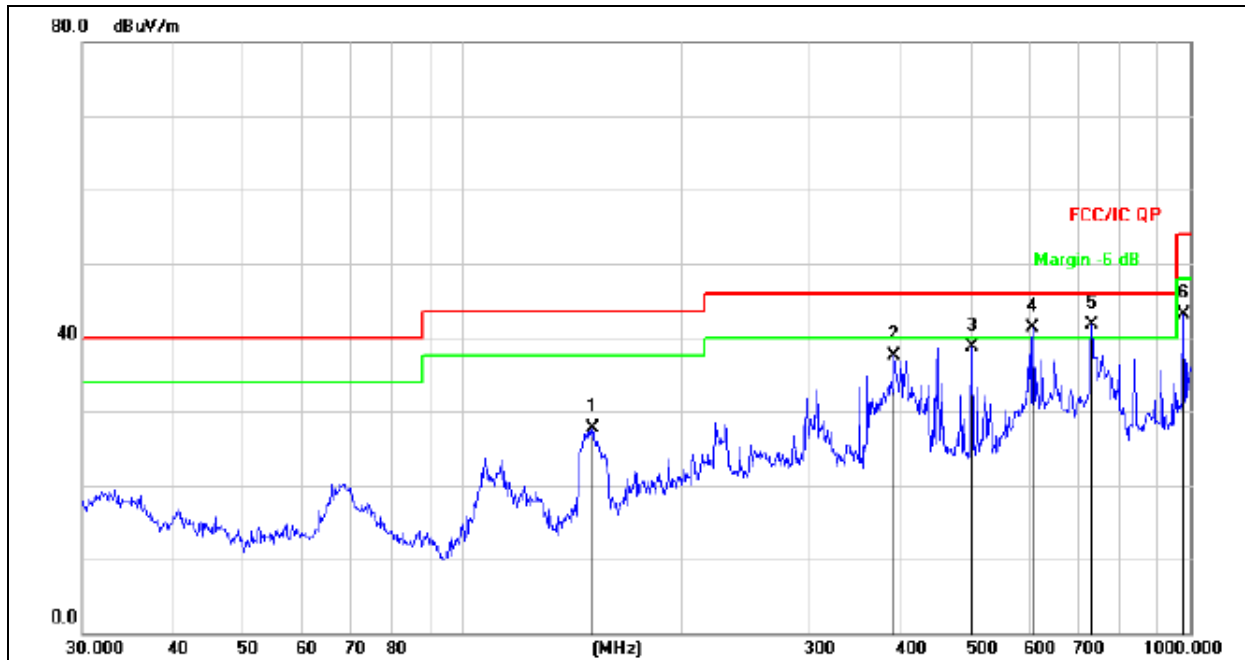

Remark:
Factor = Antenna Factor + Cable Loss – Pre-amplifier.

No.	Mk.	Freq. MHz	Reading Level dBuV	Correct Factor dB	Measure- ment dBuV/m	Limit dB/m	Over dB	Detector
1		151.0666	47.22	-19.58	27.64	43.50	-15.86	QP
2		392.0951	47.23	-9.67	37.56	46.00	-8.44	QP
3		501.1789	45.94	-7.16	38.78	46.00	-7.22	QP
4	!	607.7866	45.70	-4.40	41.30	46.00	-4.70	QP
5	*	731.9202	43.86	-2.24	41.62	46.00	-4.38	QP
6		979.1803	41.38	1.69	43.07	54.00	-10.93	QP



Temperature :	26°C	Relative Humidity :	54%
Pressure :	1010 hPa	Polarization :	Vertical
Test Voltage :	DC 5V From Adapter		
Test Mode :	Mode 5		

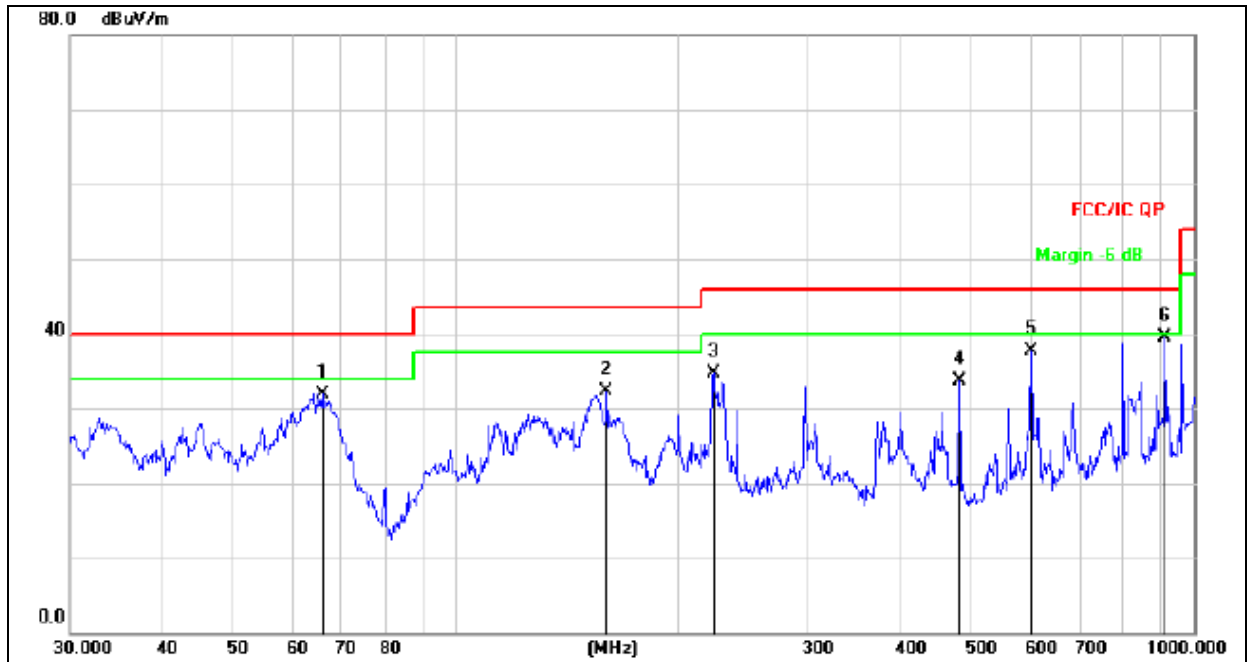

Remark:
Factor = Antenna Factor + Cable Loss – Pre-amplifier.

No.	Mk.	Freq. MHz	Reading Level dBuV	Correct Factor dB	Measure- ment dBuV/m	Limit dB/m	Over dB	Detector
1		65.8031	48.98	-17.09	31.89	40.00	-8.11	QP
2		159.7844	51.42	-19.02	32.40	43.50	-11.10	QP
3		222.9502	49.90	-15.13	34.77	46.00	-11.23	QP
4		480.5276	41.42	-7.68	33.74	46.00	-12.26	QP
5		601.4265	42.13	-4.47	37.66	46.00	-8.34	QP
6	*	912.8620	38.57	0.85	39.42	46.00	-6.58	QP



3.2.8 TEST RESULTS (1GHZ~25GHZ)

802.11b									
Polar (H/V)	Frequency	Meter Reading	Pre-amplifier	Cable Loss	Antenna Factor	Emission Level	Limits	Margin	Detector Type
	(MHz)	(dBuV)	(dB)	(dB)	(dB)	(dBuV/m)	(dBuV/m)	(dB)	
Low operation frequency:2412									
V	4824.00	68.21	39.55	7.85	25.66	62.17	74	-11.83	PK
V	4824.00	48.45	39.55	7.85	25.66	42.41	54	-11.59	AV
V	7236.00	66.88	38.33	7.52	24.55	60.62	74	-13.38	PK
V	7236.00	48.34	38.33	7.52	24.55	42.08	54	-11.92	AV
V	15450.00	52.42	35.23	6.75	26.59	50.53	74	-23.47	PK
H	4824.00	68.84	39.55	7.85	25.66	62.80	74	-11.20	PK
H	4824.00	49.15	39.55	7.85	25.66	43.11	54	-10.89	AV
H	7236.00	68.01	38.33	7.52	23.55	60.75	74	-13.25	PK
H	7236.00	51.79	38.33	7.52	23.22	44.20	54	-9.80	AV
H	15450.00	48.25	35.45	6.75	27.88	47.43	74	-26.57	PK

Polar (H/V)	Frequency	Meter Reading	Pre-amplifier	Cable Loss	Antenna Factor	Emission Level	Limits	Margin	Detector Type
	(MHz)	(dBuV)	(dB)	(dB)	(dB)	(dBuV/m)	(dBuV/m)	(dB)	
Middle operation frequency:2437									
V	4874.00	67.64	38.89	7.57	25.45	61.77	74	-12.23	PK
V	4874.00	49.47	38.89	7.57	25.45	43.60	54	-10.40	AV
V	7311.00	68.86	38.78	7.35	24.78	62.21	74	-11.79	PK
V	7311.00	48.75	38.78	7.35	24.78	42.10	54	-11.90	AV
V	15450.00	53.36	35.89	6.42	26.47	50.36	74	-23.64	PK
H	4874.00	66.27	38.89	7.57	25.45	60.40	74	-13.60	PK
H	4874.00	50.43	38.89	7.57	25.45	44.56	54	-9.44	AV
H	7311.00	68.59	38.78	7.35	24.78	61.94	74	-12.06	PK
H	7311.00	49.38	38.78	7.35	24.78	42.73	54	-11.27	AV
H	15450.00	50.42	36.68	6.42	26.65	46.81	74	-27.19	PK

Polar (H/V)	Frequency	Meter Reading	Pre-amplifier	Cable Loss	Antenna Factor	Emission Level	Limits	Margin	Detector Type
	(MHz)	(dBuV)	(dB)	(dB)	(dB)	(dBuV/m)	(dBuV/m)	(dB)	
High operation frequency:2462									
V	4924.00	67.85	38.75	7.46	25.45	62.01	74	-11.99	PK
V	4924.00	48.54	38.75	7.46	25.45	42.70	54	-11.30	AV
V	7386.00	67.87	38.65	7.22	24.78	61.22	74	-12.78	PK
V	7386.00	48.46	38.65	7.22	24.78	41.81	54	-12.19	AV
V	15450.00	53.57	35.58	6.35	26.47	50.81	74	-23.19	PK
H	4924.00	67.34	38.75	7.46	25.45	61.50	74	-12.50	PK
H	4924.00	48.27	38.75	7.46	25.45	42.43	54	-11.57	AV
H	7386.00	68.24	38.65	7.22	24.78	61.59	74	-12.41	PK
H	7386.00	50.36	38.65	7.22	24.78	43.71	54	-10.29	AV
H	15450.00	49.66	36.42	6.32	26.65	46.21	74	-27.79	PK

Remark:

1. Emission Level = Meter Reading + Antenna Factor + Cable Loss – Pre-amplifier, Margin= Emission Level - Limit
2. If peak below the average limit, the average emission was no test.
3. The amplitude of spurious emissions which are attenuated by more than 20dB below the permissible value has no need to be reported.



802.11g

Polar (H/V)	Frequency	Meter Reading	Pre-amplifier	Cable Loss	Antenna Factor	Emission Level	Limits	Margin	Detector Type
	(MHz)	(dBuV)	(dB)	(dB)	(dB)	(dBuV/m)	(dBuV/m)	(dB)	
Low operation frequency:2412									
V	4824.00	66.47	39.55	7.85	25.66	60.43	74	-13.57	PK
V	4824.00	49.65	39.55	7.85	25.66	43.61	54	-10.39	AV
V	7236.00	66.46	38.33	7.52	24.55	60.20	74	-13.80	PK
V	7236.00	47.68	38.33	7.52	24.55	41.42	54	-12.58	AV
V	15450.00	50.36	35.23	6.75	26.59	48.47	74	-25.53	PK
H	4824.00	65.25	39.55	7.85	25.66	59.21	74	-14.79	PK
H	4824.00	49.47	39.55	7.85	25.66	43.43	54	-10.57	AV
H	7236.00	67.35	38.33	7.52	23.55	60.09	74	-13.91	PK
H	7236.00	50.47	38.33	7.52	23.22	42.88	54	-11.12	AV
H	15450.00	45.79	35.45	6.75	27.88	44.97	74	-29.03	PK

Polar (H/V)	Frequency	Meter Reading	Pre-amplifier	Cable Loss	Antenna Factor	Emission Level	Limits	Margin	Detector Type
	(MHz)	(dBuV)	(dB)	(dB)	(dB)	(dBuV/m)	(dBuV/m)	(dB)	
Middle operation frequency:2437									
V	4874.00	68.15	38.89	7.57	25.45	62.28	74	-11.72	PK
V	4874.00	48.71	38.89	7.57	25.45	42.84	54	-11.16	AV
V	7311.00	67.82	38.78	7.35	24.78	61.17	74	-12.83	PK
V	7311.00	48.77	38.78	7.35	24.78	42.12	54	-11.88	AV
V	15450.00	53.34	35.89	6.42	26.47	50.34	74	-23.66	PK
H	4874.00	66.26	38.89	7.57	25.45	60.39	74	-13.61	PK
H	4874.00	50.48	38.89	7.57	25.45	44.61	54	-9.39	AV
H	7311.00	68.76	38.78	7.35	24.78	62.11	74	-11.89	PK
H	7311.00	49.53	38.78	7.35	24.78	42.88	54	-11.12	AV
H	15450.00	50.22	36.68	6.42	26.65	46.61	74	-27.39	PK

Polar (H/V)	Frequency	Meter Reading	Pre-amplifier	Cable Loss	Antenna Factor	Emission Level	Limits	Margin	Detector Type
	(MHz)	(dBuV)	(dB)	(dB)	(dB)	(dBuV/m)	(dBuV/m)	(dB)	
High operation frequency:2462									
V	4924.00	67.42	38.75	7.46	25.45	61.58	74	-12.42	PK
V	4924.00	48.66	38.75	7.46	25.45	42.82	54	-11.18	AV
V	7386.00	68.53	38.65	7.22	24.78	61.88	74	-12.12	PK
V	7386.00	49.77	38.65	7.22	24.78	43.12	54	-10.88	AV
V	15450.00	53.62	35.58	6.35	26.47	50.86	74	-23.14	PK
H	4924.00	66.58	38.75	7.46	25.45	60.74	74	-13.26	PK
H	4924.00	50.43	38.75	7.46	25.45	44.59	54	-9.41	AV
H	7386.00	69.31	38.65	7.22	24.78	62.66	74	-11.34	PK
H	7386.00	48.82	38.65	7.22	24.78	42.17	54	-11.83	AV
H	15450.00	49.69	36.42	6.32	26.65	46.24	74	-27.76	PK

Remark:

1. Emission Level = Meter Reading + Antenna Factor + Cable Loss – Pre-amplifier, Margin= Emission Level - Limit
2. If peak below the average limit, the average emission was no test.
3. The amplitude of spurious emissions which are attenuated by more than 20dB below the permissible value has no need to be reported.



802.11n(20MHz)

Polar (H/V)	Frequency	Meter Reading	Pre-amplifier	Cable Loss	Antenna Factor	Emission Level	Limits	Margin	Detector Type
	(MHz)	(dBuV)	(dB)	(dB)	(dB)	(dBuV/m)	(dBuV/m)	(dB)	
Low operation frequency:2412									
V	4824.00	67.46	39.55	7.85	25.66	61.42	74	-12.58	PK
V	4824.00	48.76	39.55	7.85	25.66	42.72	54	-11.28	AV
V	7236.00	66.83	38.33	7.52	24.55	60.57	74	-13.43	PK
V	7236.00	48.78	38.33	7.52	24.55	42.52	54	-11.48	AV
V	15450.00	51.67	35.23	6.75	26.59	49.78	74	-24.22	PK
H	4824.00	68.47	39.55	7.85	25.66	62.43	74	-11.57	PK
H	4824.00	49.66	39.55	7.85	25.66	43.62	54	-10.38	AV
H	7236.00	69.53	38.33	7.52	23.55	62.27	74	-11.73	PK
H	7236.00	52.43	38.33	7.52	23.22	44.84	54	-9.16	AV
H	15450.00	47.54	35.45	6.75	27.88	46.72	74	-27.28	PK

Polar (H/V)	Frequency	Meter Reading	Pre-amplifier	Cable Loss	Antenna Factor	Emission Level	Limits	Margin	Detector Type
	(MHz)	(dBuV)	(dB)	(dB)	(dB)	(dBuV/m)	(dBuV/m)	(dB)	
Middle operation frequency:2437									
V	4874.00	66.94	38.89	7.57	25.45	61.07	74	-12.93	PK
V	4874.00	49.56	38.89	7.57	25.45	43.69	54	-10.31	AV
V	7311.00	67.25	38.78	7.35	24.78	60.60	74	-13.40	PK
V	7311.00	47.55	38.78	7.35	24.78	40.90	54	-13.10	AV
V	15450.00	52.11	35.89	6.42	26.47	49.11	74	-24.89	PK
H	4874.00	65.78	38.89	7.57	25.45	59.91	74	-14.09	PK
H	4874.00	49.71	38.89	7.57	25.45	43.84	54	-10.16	AV
H	7311.00	69.56	38.78	7.35	24.78	62.91	74	-11.09	PK
H	7311.00	48.77	38.78	7.35	24.78	42.12	54	-11.88	AV
H	15450.00	49.25	36.68	6.45	26.65	45.67	74	-28.33	PK

Polar (H/V)	Frequency	Meter Reading	Pre-amplifier	Cable Loss	Antenna Factor	Emission Level	Limits	Margin	Detector Type
	(MHz)	(dBuV)	(dB)	(dB)	(dB)	(dBuV/m)	(dBuV/m)	(dB)	
High operation frequency:2462									
V	4924.00	67.69	38.75	7.46	25.45	61.85	74	-12.15	PK
V	4924.00	49.37	38.75	7.46	25.45	43.53	54	-10.47	AV
V	7386.00	68.06	38.65	7.22	24.78	61.41	74	-12.59	PK
V	7386.00	49.19	38.65	7.22	24.78	42.54	54	-11.46	AV
V	15450.00	53.36	35.58	6.35	26.47	50.60	74	-23.40	PK
H	4924.00	66.28	38.75	7.46	25.45	60.44	74	-13.56	PK
H	4924.00	48.35	38.75	7.46	25.45	42.51	54	-11.49	AV
H	7386.00	68.78	38.65	7.22	24.78	62.13	74	-11.87	PK
H	7386.00	48.96	38.65	7.22	24.78	42.31	54	-11.69	AV
H	15450.00	50.71	36.42	6.32	26.65	47.26	74	-26.74	PK

Remark:

1. Emission Level = Meter Reading + Antenna Factor + Cable Loss – Pre-amplifier, Margin= Emission Level - Limit
2. If peak below the average limit, the average emission was no test.
3. The amplitude of spurious emissions which are attenuated by more than 20dB below the permissible value has no need to be reported.



802.11n(40MHz)

Polar (H/V)	Frequency	Meter Reading	Pre-amplifier	Cable Loss	Antenna Factor	Emission Level	Limits	Margin	Detector Type
	(MHz)	(dBuV)	(dB)	(dB)	(dB)	(dBuV/m)	(dBuV/m)	(dB)	
Low operation frequency:2422									
V	4844.000	68.75	39.55	7.77	25.66	62.63	74	-11.37	PK
V	4844.000	49.43	39.55	7.77	25.66	43.31	54	-10.69	AV
V	7266.000	67.82	38.33	7.30	24.55	61.34	74	-12.66	PK
V	7266.000	48.36	38.33	7.30	24.55	41.88	54	-12.12	AV
V	15450.00	51.33	35.23	6.60	26.59	49.29	74	-24.71	PK
H	4844.000	68.52	39.55	7.77	25.66	62.40	74	-11.60	PK
H	4844.000	49.34	39.55	7.77	25.66	43.22	54	-10.78	AV
H	7266.000	67.62	38.33	7.30	23.55	60.14	74	-13.86	PK
H	7266.000	50.64	38.33	7.30	23.22	42.83	54	-11.17	AV
H	15450.00	49.35	35.45	6.60	27.88	48.38	74	-25.62	PK

Polar (H/V)	Frequency	Meter Reading	Pre-amplifier	Cable Loss	Antenna Factor	Emission Level	Limits	Margin	Detector Type
	(MHz)	(dBuV)	(dB)	(dB)	(dB)	(dBuV/m)	(dBuV/m)	(dB)	
Middle operation frequency:2437									
V	4874.00	67.71	38.89	7.57	25.45	61.84	74	-12.16	PK
V	4874.00	49.56	38.89	7.57	25.45	43.69	54	-10.31	AV
V	7311.00	67.78	38.78	7.35	24.78	61.13	74	-12.87	PK
V	7311.00	47.47	38.78	7.35	24.78	40.82	54	-13.18	AV
V	15450.00	52.23	35.89	6.42	26.47	49.23	74	-24.77	PK
H	4874.00	65.58	38.89	7.57	25.45	59.71	74	-14.29	PK
H	4874.00	49.24	38.89	7.57	25.45	43.37	54	-10.63	AV
H	7311.00	66.93	38.78	7.35	24.78	60.28	74	-13.72	PK
H	7311.00	48.59	38.78	7.35	24.78	41.94	54	-12.06	AV
H	15450.00	49.65	36.68	6.42	26.65	46.04	74	-27.96	PK

Polar (H/V)	Frequency	Meter Reading	Pre-amplifier	Cable Loss	Antenna Factor	Emission Level	Limits	Margin	Detector Type
	(MHz)	(dBuV)	(dB)	(dB)	(dB)	(dBuV/m)	(dBuV/m)	(dB)	
High operation frequency:2452									
V	4904.00	68.25	38.75	7.38	25.45	62.33	74	-11.67	PK
V	4904.00	47.93	38.75	7.38	25.45	42.01	54	-11.99	AV
V	7356.00	67.25	38.65	7.15	24.78	60.53	74	-13.47	PK
V	7356.00	49.47	38.65	7.15	24.78	42.75	54	-11.25	AV
V	15450.00	53.68	35.58	6.25	26.47	50.82	74	-23.18	PK
H	4904.00	66.23	38.75	7.38	25.45	60.31	74	-13.69	PK
H	4904.00	48.12	38.75	7.38	25.45	42.20	54	-11.80	AV
H	7356.00	69.09	38.65	7.15	24.78	62.37	74	-11.63	PK
H	7356.00	48.61	38.65	7.15	24.78	41.89	54	-12.11	AV
H	15450.00	51.37	36.42	6.25	26.65	47.85	74	-26.15	PK

Remark:

1. Emission Level = Meter Reading + Antenna Factor + Cable Loss – Pre-amplifier, Margin= Emission Level - Limit
2. If peak below the average limit, the average emission was no test.
3. The amplitude of spurious emissions which are attenuated by more than 20dB below the permissible value has no need to be reported.



3.3 RADIATED BAND EMISSION MEASUREMENT

3.3.1 TEST REQUIREMENT:

FCC Part15 C Section 15.209 and 15.205

LIMITS OF RADIATED EMISSION MEASUREMENT (Above 1000MHz)

FREQUENCY (MHz)	Class B (dBuV/m) (at 3M)	
	PEAK	AVERAGE
Above 1000	74	54

Notes:

- (1) The limit for radiated test was performed according to FCC PART 15C.
- (2) The tighter limit applies at the band edges.
- (3) Emission level (dBuV/m)=20log Emission level (uV/m).

Spectrum Parameter	Setting
Attenuation	Auto
Start Frequency	2300MHz
Stop Frequency	2520
RB / VB (emission in restricted band)	1 MHz / 1 MHz for Peak, 1 MHz / 10Hz for Average

3.3.2 TEST PROCEDURE

Above 1GHz test procedure as below:

- a. 1. The EUT was placed on the top of a rotating table 1.5 meters above the ground at a 3 meter camber. The table was rotated 360 degrees to determine the position of the highest radiation.
- b. The EUT was set 3 meters away from the interference-receiving antenna, which was mounted on the top of a variable-height antenna tower.
- c. The antenna height is varied from one meter to four meters above the ground to determine the maximum value of the field strength. Both horizontal and vertical polarizations of the antenna are set to make the measurement.
- d. For each suspected emission, the EUT was arranged to its worst case and then the antenna was tuned to heights from 1 meter to 4 meters and the rota table was turned from 0 degrees to 360 degrees to find the maximum reading.
- e. The test-receiver system was set to Peak Detect Function and Specified Bandwidth with Maximum Hold Mode.
- f. If the emission level of the EUT in peak mode was 10dB lower than the limit specified, then testing could be stopped and the peak values of the EUT would be reported. Otherwise the emissions that did not have 10dB margin would be re-tested one by one using peak, quasi-peak or average method as specified and then reported in a data sheet.
- g. Test the EUT in the lowest channel,the Highest channel

Note:

Both horizontal and vertical antenna polarities were tested and performed pretest to three orthogonal axis. The worst case emissions were reported

3.3.3 DEVIATION FROM TEST STANDARD

No deviation

3.3.4 TEST SETUP

Radiated Emission Test-Up Frequency Above 1GHz

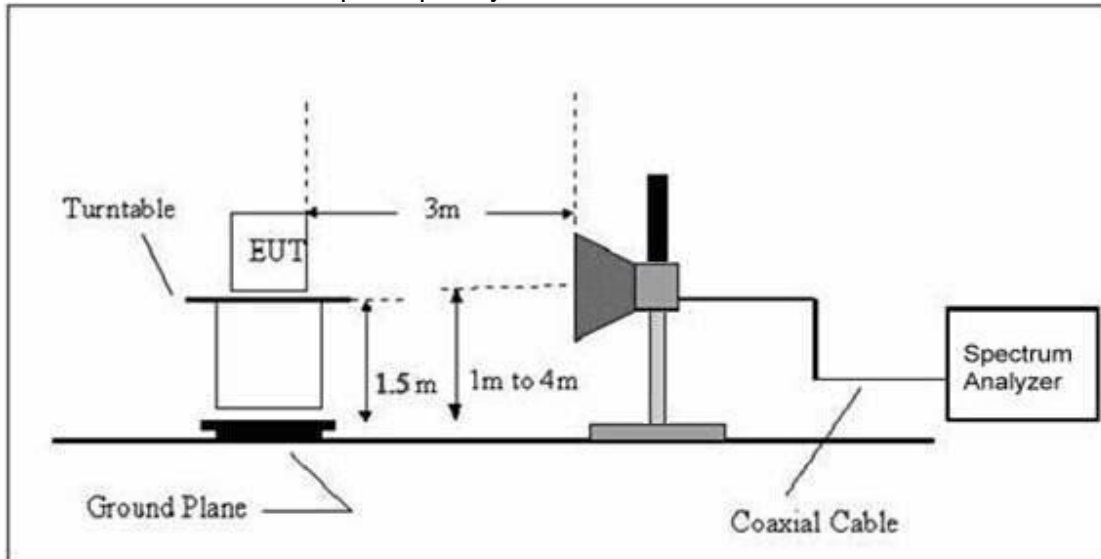

3.3.5 EUT OPERATING CONDITIONS

The EUT tested system was configured as the statements of 2.3 Unless otherwise a special operating condition is specified in the follows during the testing.



3.3.6 TEST RESULT

802.11b

Polar (H/V)	Frequency	Meter Reading	Factor	Emission Level	Limits	Margin	Detec or Type
	(MHz)	(dBuV)	(dB)	(dBuV/m)	(dBuV/m)	(dB)	
operation frequency:2412							
V	2390.00	37.69	13.83	51.52	74.00	-22.48	PK
V	2390.00	27.36	13.83	41.19	54.00	-12.81	AV
V	2400.00	38.99	13.85	52.84	74.00	-21.16	PK
V	2400.00	26.87	13.85	40.72	54.00	-13.28	AV
H	2390.00	38.09	13.83	51.92	74.00	-22.08	PK
H	2390.00	26.36	13.83	40.19	54.00	-13.81	AV
H	2400.00	38.57	13.85	52.42	74.00	-21.58	PK
H	2400.00	26.44	13.85	40.29	54.00	-13.71	AV

Polar (H/V)	Frequency	Meter Reading	Factor	Emission Level	Limits	Margin	Detector Type
	(MHz)	(dBuV)	(dB)	(dBuV/m)	(dBuV/m)	(dB)	
operation frequency:2462							
V	2483.50	38.51	14.02	52.53	74.00	-21.47	PK
V	2483.50	26.48	14.02	40.5	54.00	-13.50	AV
V	2500.00	38.52	14.06	52.58	74.00	-21.42	PK
V	2500.00	26.29	14.06	40.35	54.00	-13.65	AV
H	2483.50	38.47	14.02	52.49	74.00	-21.51	PK
H	2483.50	26.55	14.02	40.57	54.00	-13.43	AV
H	2500.00	38.33	14.06	52.39	74.00	-21.61	PK
H	2500.00	27.12	14.06	41.18	54.00	-12.82	AV

Remark:

1. Emission Level = Meter Reading + Factor, Margin= Emission Level - Limit
2. If peak below the average limit, the average emission was no test.
3. The amplitude of spurious emissions which are attenuated by more than 20dB below the permissible value has no need to be reported.



802.11g

Polar (H/V)	Frequency	Meter Reading	Factor	Emission Level	Limits	Margin	Detector Type
	(MHz)	(dBuV)	(dB)	(dBuV/m)	(dBuV/m)	(dB)	
operation frequency:2412							
V	2390.00	37.45	13.83	51.28	74.00	-22.72	PK
V	2390.00	25.67	13.83	39.5	54.00	-14.50	AV
V	2400.00	37.65	13.85	51.5	74.00	-22.50	PK
V	2400.00	25.62	13.85	39.47	54.00	-14.53	AV
H	2390.00	37.64	13.83	51.47	74.00	-22.53	PK
H	2390.00	25.23	13.83	39.06	54.00	-14.94	AV
H	2400.00	37.34	13.85	51.19	74.00	-22.81	PK
H	2400.00	25.69	13.85	39.54	54.00	-14.46	AV

Polar (H/V)	Frequency	Meter Reading	Factor	Emission Level	Limits	Margin	Detector Type
	(MHz)	(dBuV)	(dB)	(dBuV/m)	(dBuV/m)	(dB)	
operation frequency:2462							
V	2483.50	37.32	14.02	51.34	74.00	-22.66	PK
V	2483.50	26.03	14.02	40.05	54.00	-13.95	AV
V	2500.00	37.26	14.06	51.32	74.00	-22.68	PK
V	2500.00	25.48	14.06	39.54	54.00	-14.46	AV
H	2483.50	37.45	14.02	51.47	74.00	-22.53	PK
H	2483.50	26.07	14.02	40.09	54.00	-13.91	AV
H	2500.00	37.07	14.06	51.13	74.00	-22.87	PK
H	2500.00	26.32	14.06	40.38	54.00	-13.62	AV

Remark:

1. Emission Level = Meter Reading + Factor, Margin= Emission Level - Limit
2. If peak below the average limit, the average emission was no test.
3. The amplitude of spurious emissions which are attenuated by more than 20dB below the permissible value has no need to be reported.



802.11n(20MHz)

Polar (H/V)	Frequency	Meter Reading	Factor	Emission Level	Limits	Margin	Detector Type
	(MHz)	(dBuV)	(dB)	(dBuV/m)	(dBuV/m)	(dB)	
operation frequency:2412							
V	2390.00	37.46	13.83	51.29	74.00	-22.71	PK
V	2390.00	25.78	13.83	39.61	54.00	-14.39	AV
V	2400.00	37.39	13.85	51.24	74.00	-22.76	PK
V	2400.00	25.47	13.85	39.32	54.00	-14.68	AV
H	2390.00	37.56	13.83	51.39	74.00	-22.61	PK
H	2390.00	25.91	13.83	39.74	54.00	-14.26	AV
H	2400.00	37.34	13.85	51.19	74.00	-22.81	PK
H	2400.00	25.82	13.85	39.67	54.00	-14.33	AV

Polar (H/V)	Frequency	Meter Reading	Factor	Emission Level	Limits	Margin	Detector Type
	(MHz)	(dBuV)	(dB)	(dBuV/m)	(dBuV/m)	(dB)	
operation frequency:2462							
V	2483.50	37.57	14.02	51.59	74.00	-22.41	PK
V	2483.50	26.29	14.02	40.31	54.00	-13.69	AV
V	2500.00	37.48	14.06	51.54	74.00	-22.46	PK
V	2500.00	25.36	14.06	39.42	54.00	-14.58	AV
H	2483.50	37.47	14.02	51.49	74.00	-22.51	PK
H	2483.50	26.26	14.02	40.28	54.00	-13.72	AV
H	2500.00	37.32	14.06	51.38	74.00	-22.62	PK
H	2500.00	26.54	14.06	40.6	54.00	-13.40	AV

Remark:

1. Emission Level = Meter Reading + Factor, Margin= Emission Level - Limit
2. If peak below the average limit, the average emission was no test.
3. The amplitude of spurious emissions which are attenuated by more than 20dB below the permissible value has no need to be reported.



802.11n(40MHz)

Polar (H/V)	Frequency	Meter Reading	Factor	Emission Level	Limits	Margin	Detector Type
	(MHz)	(dBuV)	(dB)	(dBuV/m)	(dBuV/m)	(dB)	
operation frequency:2422							
V	2390.00	37.54	13.83	51.37	74.00	-22.63	PK
V	2390.00	26.08	13.83	39.91	54.00	-14.09	AV
V	2400.00	37.75	13.85	51.60	74.00	-22.40	PK
V	2400.00	25.66	13.85	39.51	54.00	-14.49	AV
H	2390.00	37.84	13.83	51.67	74.00	-22.33	PK
H	2390.00	26.10	13.83	39.93	54.00	-14.07	AV
H	2400.00	37.70	13.85	51.55	74.00	-22.45	PK
H	2400.00	26.05	13.85	39.90	54.00	-14.10	AV

Polar (H/V)	Frequency	Meter Reading	Factor	Emission Level	Limits	Margin	Detector Type
	(MHz)	(dBuV)	(dB)	(dBuV/m)	(dBuV/m)	(dB)	
operation frequency:2452							
V	2483.50	37.75	14.02	51.77	74.00	-22.23	PK
V	2483.50	26.32	14.02	40.34	54.00	-13.66	AV
V	2500.00	37.69	14.06	51.75	74.00	-22.25	PK
V	2500.00	25.76	14.06	39.82	54.00	-14.18	AV
H	2483.50	37.88	14.02	51.90	74.00	-22.10	PK
H	2483.50	26.36	14.02	40.38	54.00	-13.62	AV
H	2500.00	37.49	14.06	51.55	74.00	-22.45	PK
H	2500.00	26.61	14.06	40.67	54.00	-13.33	AV

Remark:

1. Emission Level = Meter Reading + Factor, Margin= Emission Level - Limit
2. If peak below the average limit, the average emission was no test.
3. The amplitude of spurious emissions which are attenuated by more than 20dB below the permissible value has no need to be reported.

4. POWER SPECTRAL DENSITY TEST

4.1 APPLIED PROCEDURES / LIMIT

FCC Part15 (15.247) , Subpart C				
Section	Test Item	Limit	Frequency Range (MHz)	Result
15.247	Power Spectral Density	8 dBm (in any 3KHz)	2400-2483.5	PASS

4.1.1 TEST PROCEDURE

1. Set analyzer center frequency to DTS channel center frequency.
2. Set the span to 1.5 times the DTS bandwidth.
3. Set the RBW to: $3\text{ kHz} \leq \text{RBW} \leq 100\text{ kHz}$.
4. Set the VBW $\geq 3 \times \text{RBW}$.
5. Detector = peak.
6. Sweep time = auto couple.
7. Trace mode = max hold.
8. Allow trace to fully stabilize.
9. Use the peak marker function to determine the maximum amplitude level within the RBW.
10. If measured value exceeds limit, reduce RBW (no less than 3 kHz) and repeat.

4.1.2 DEVIATION FROM STANDARD

No deviation.

4.1.3 TEST SETUP



4.1.4 EUT OPERATION CONDITIONS

The EUT tested system was configured as the statements of 2.1 Unless otherwise a special operating condition is specified in the follows during the testing.



4.1.5 TEST RESULTS

Temperature :	25°C	Relative Humidity :	60%
Pressure :	1015 hPa	Test Voltage :	DC 5V From Adapter
Test Mode :	TX b Mode		

Frequency	Power Spectral Density(dBm)	Limit (dBm)	Result
2412 MHz	-10.58	8	PASS
2437 MHz	-11.23	8	PASS
2462 MHz	-10.77	8	PASS

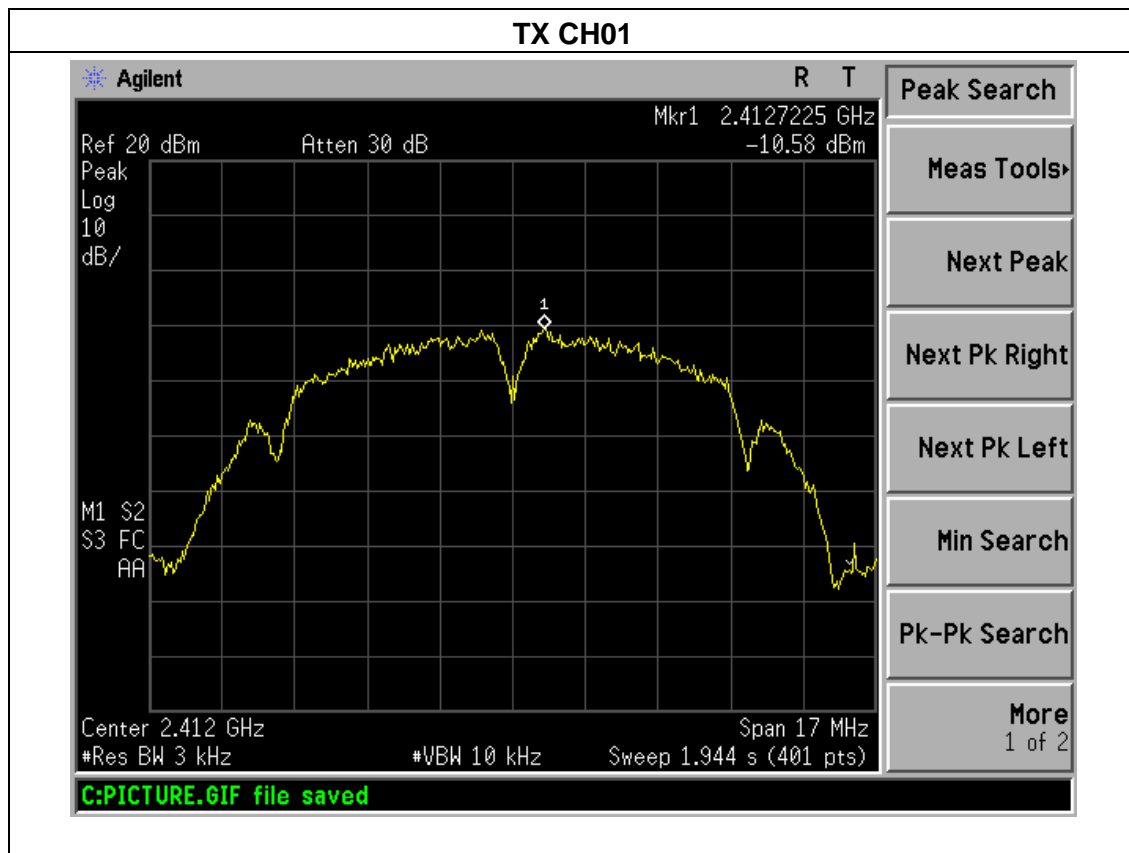

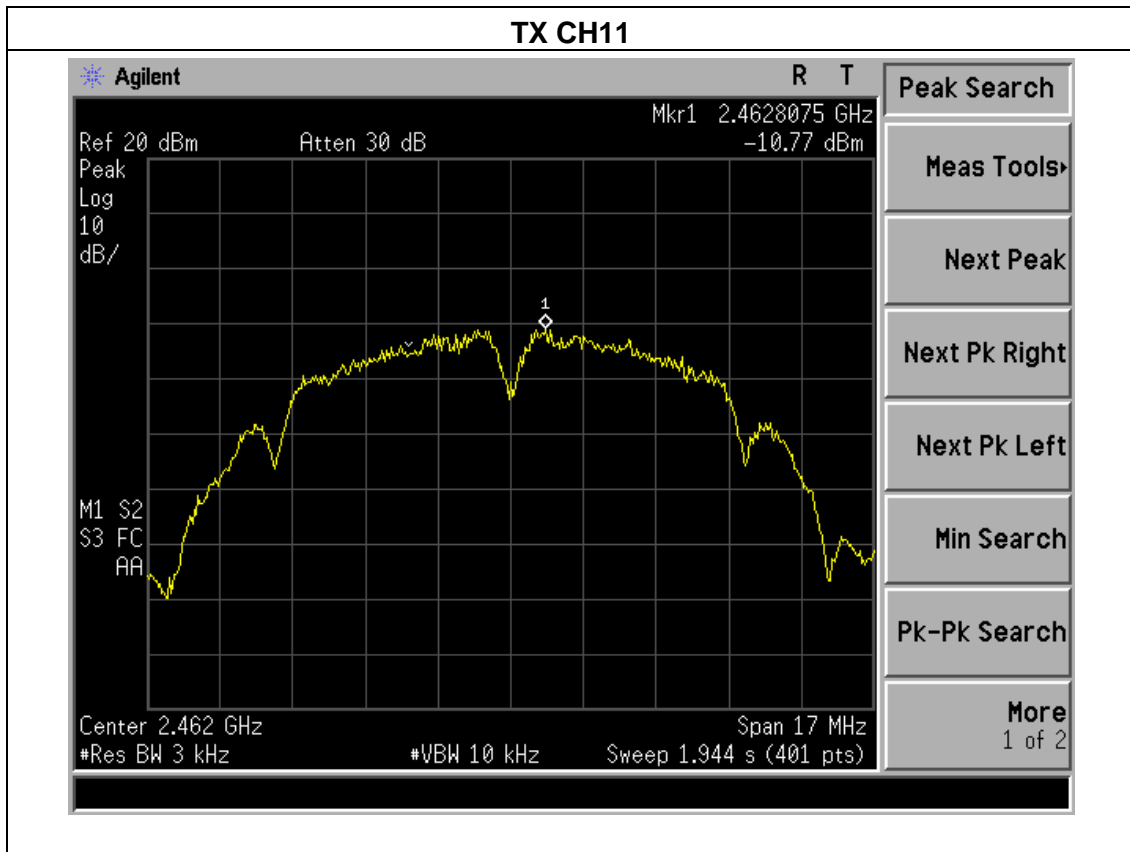
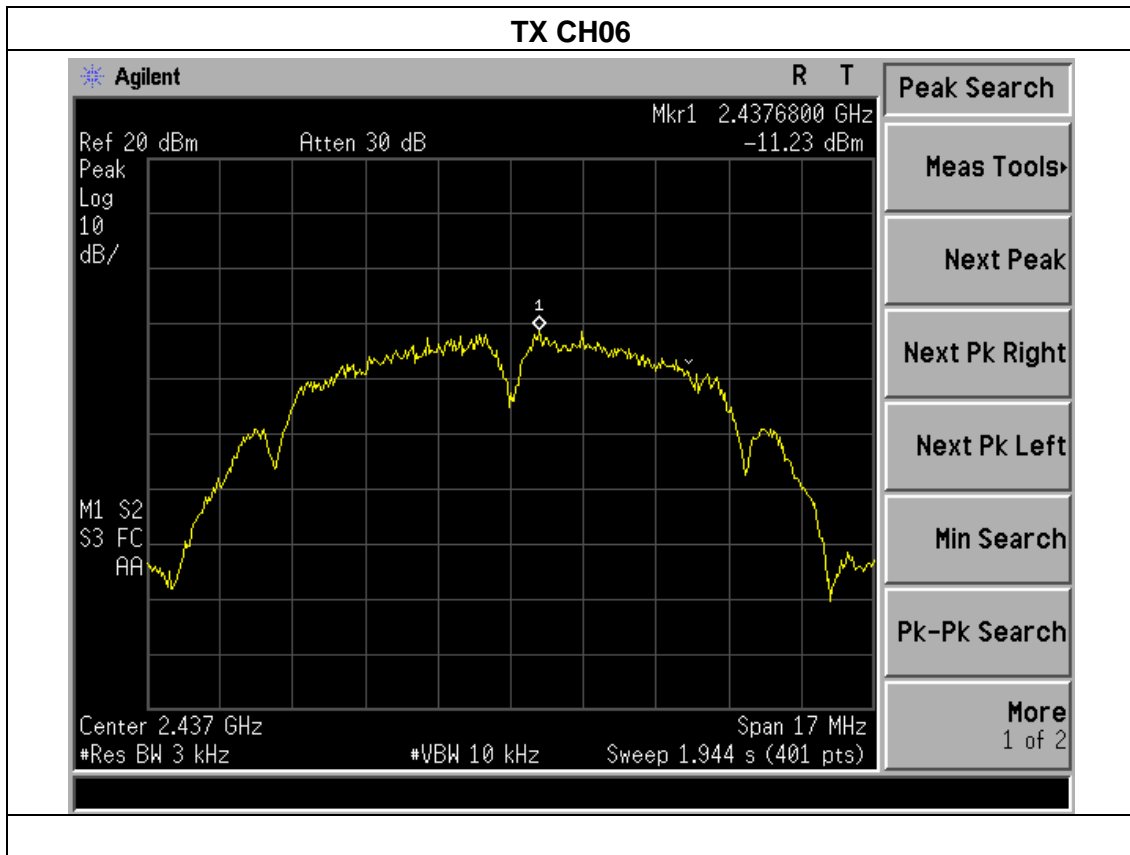



Temperature :	25°C	Relative Humidity :	60%
Pressure :	1015 hPa	Test Voltage :	DC 5V From Adapter
Test Mode :	TX g Mode		

Frequency	Power Spectral Density(dBm)	Limit (dBm)	Result
2412 MHz	-13.03	8	PASS
2437 MHz	-14.24	8	PASS
2462 MHz	-17.22	8	PASS

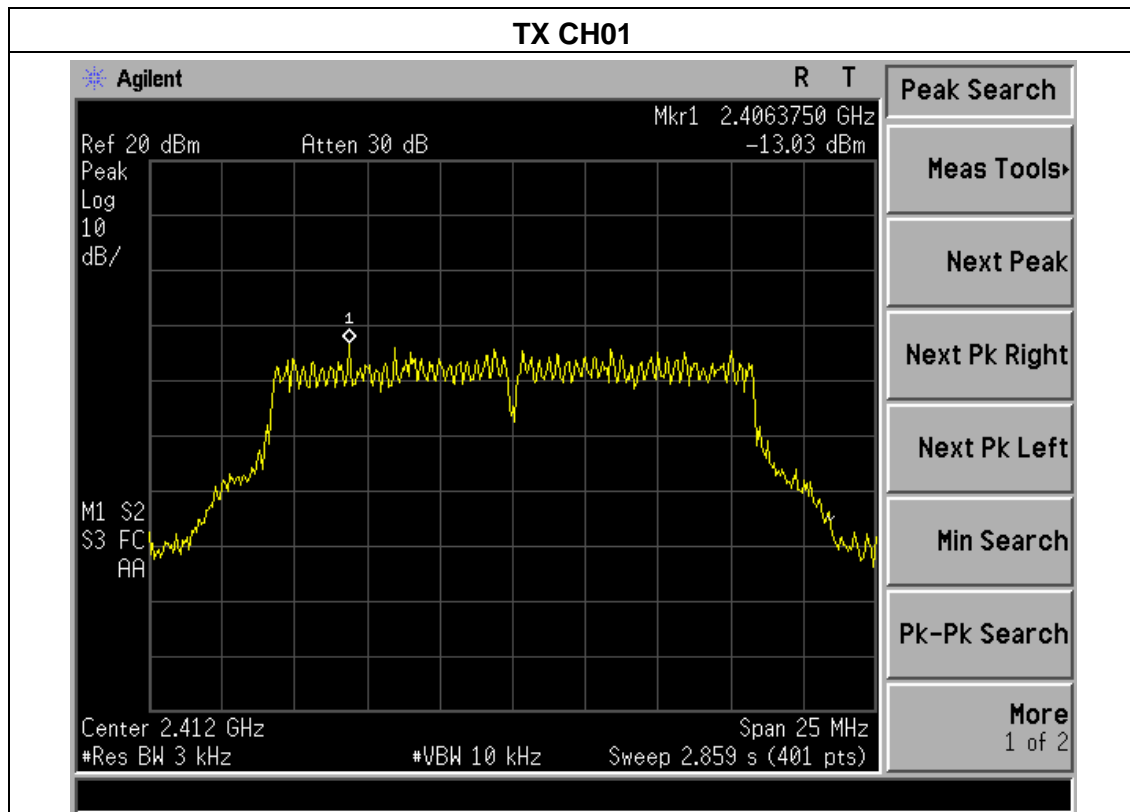

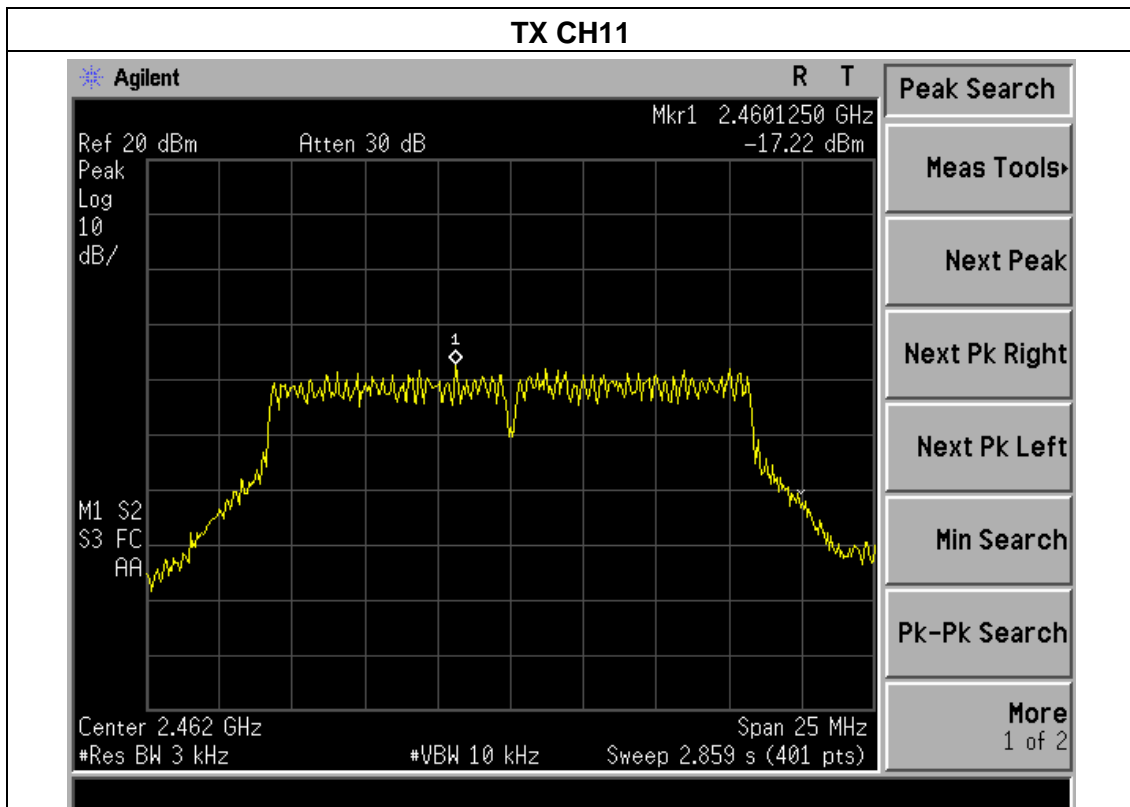
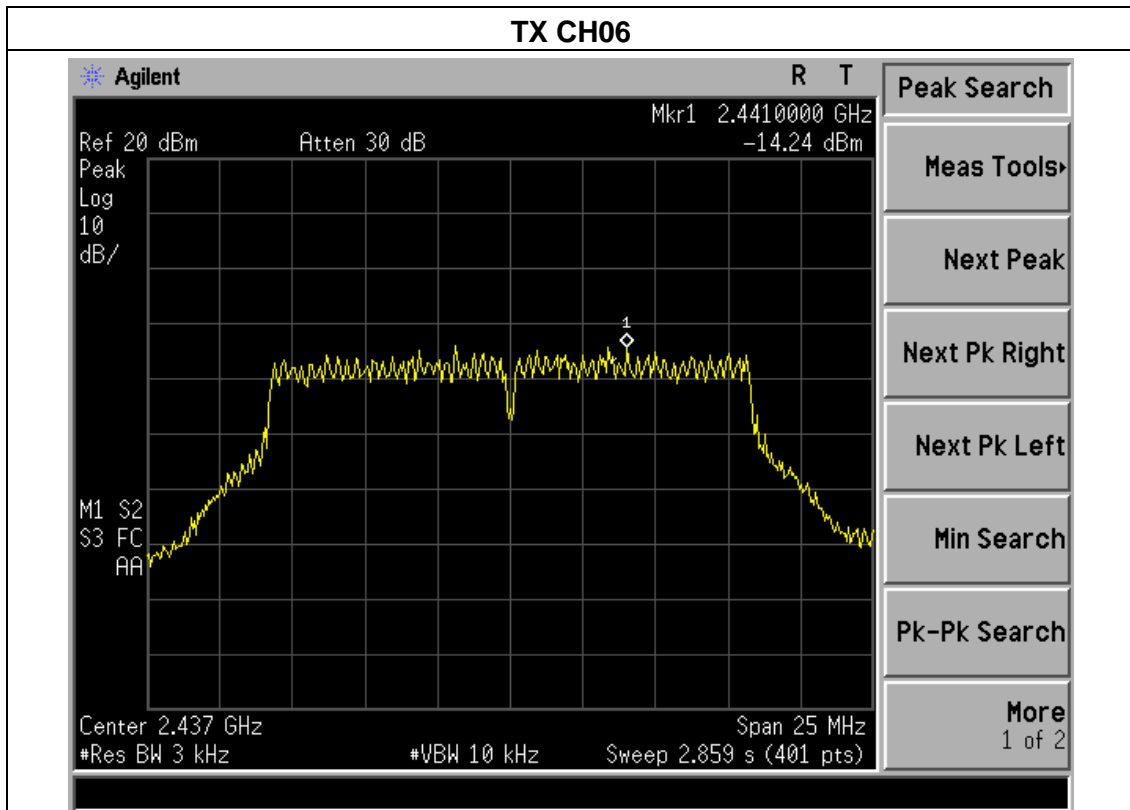



Temperature :	25°C	Relative Humidity :	60%
Pressure :	1015 hPa	Test Voltage :	DC 5V From Adapter
Test Mode :	TX n Mode(20M)		

Frequency	Power Spectral Density(dBm)	Limit (dBm)	Result
2412 MHz	-16.09	8	PASS
2437 MHz	-14.85	8	PASS
2462 MHz	-16.03	8	PASS

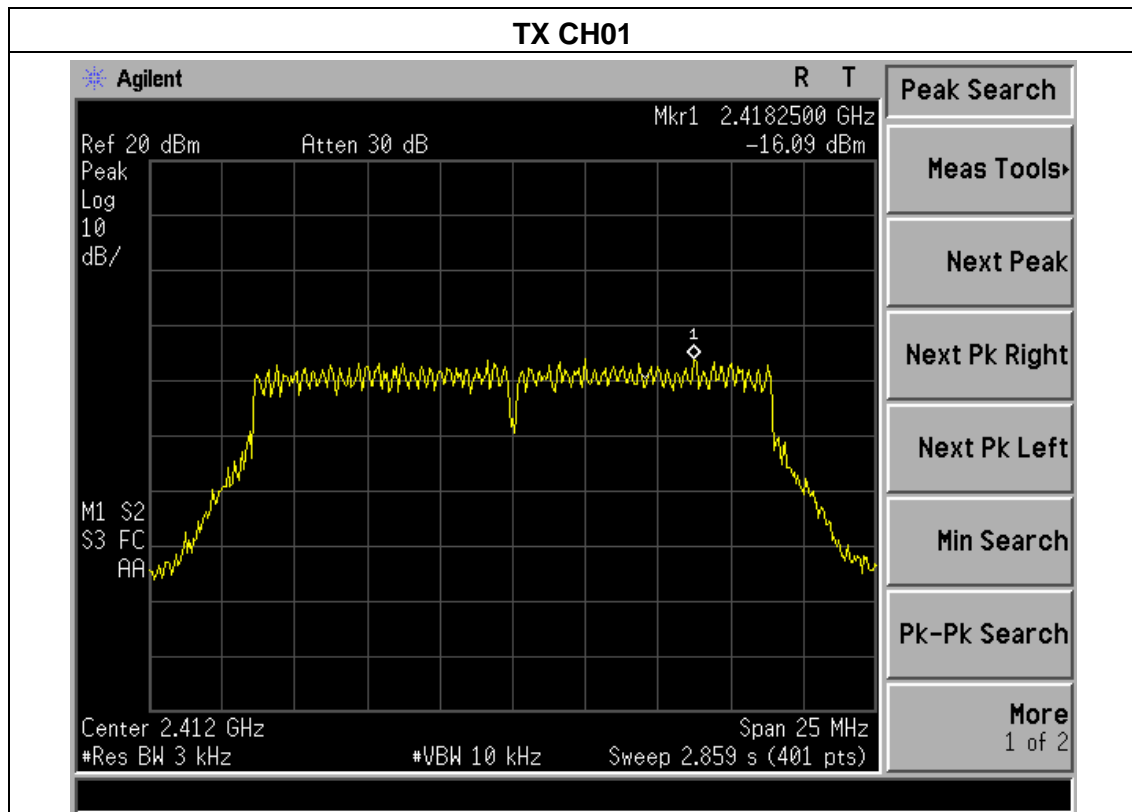

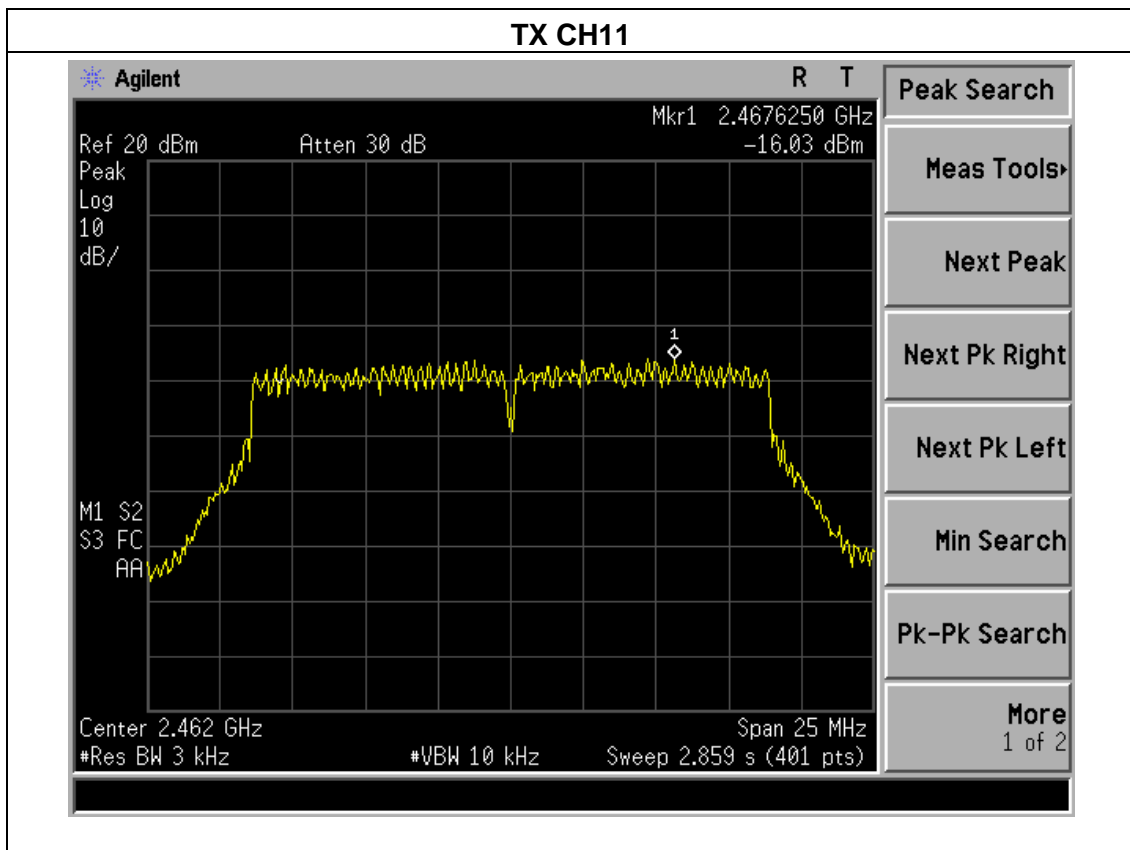
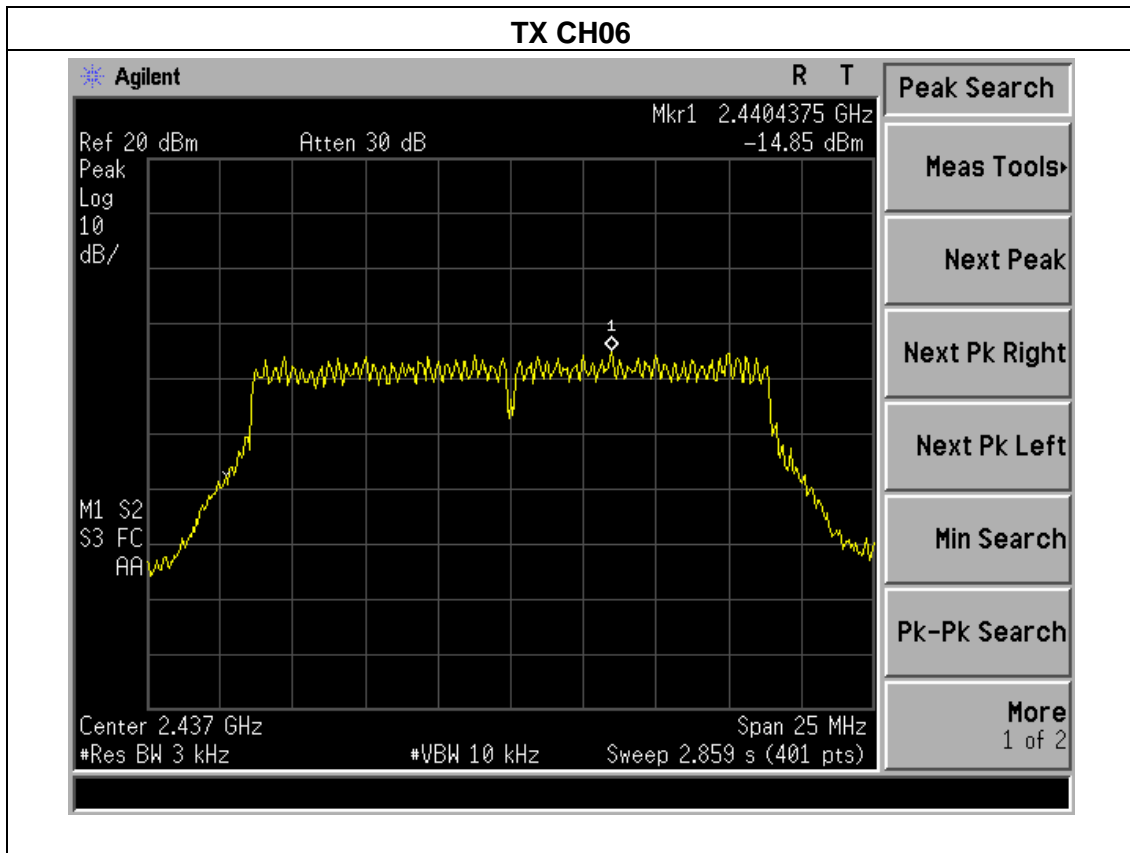



Temperature :	25°C	Relative Humidity :	60%
Pressure :	1015 hPa	Test Voltage :	DC 5V From Adapter
Test Mode :	TX n Mode(40M)		

Frequency	Power Spectral Density(dBm)	Limit (dBm)	Result
2422 MHz	-19.63	8	PASS
2437 MHz	-15.39	8	PASS
2452 MHz	-18.39	8	PASS

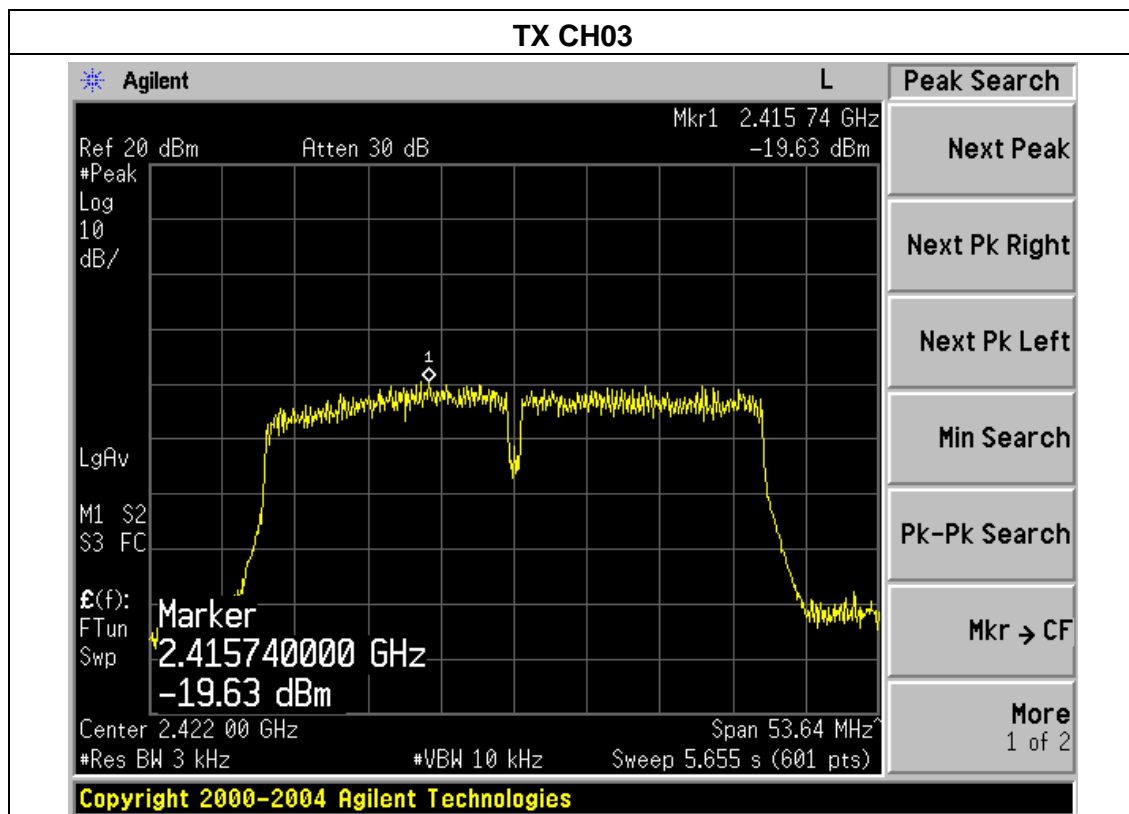

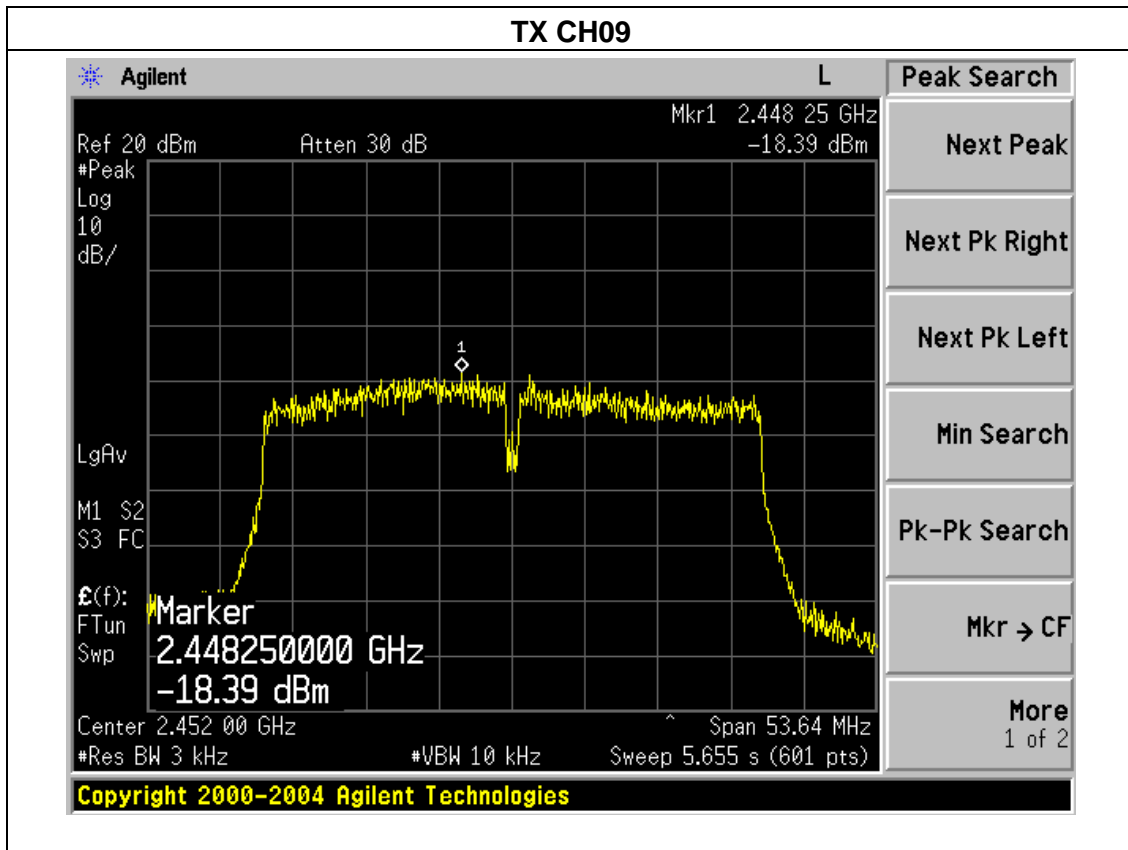
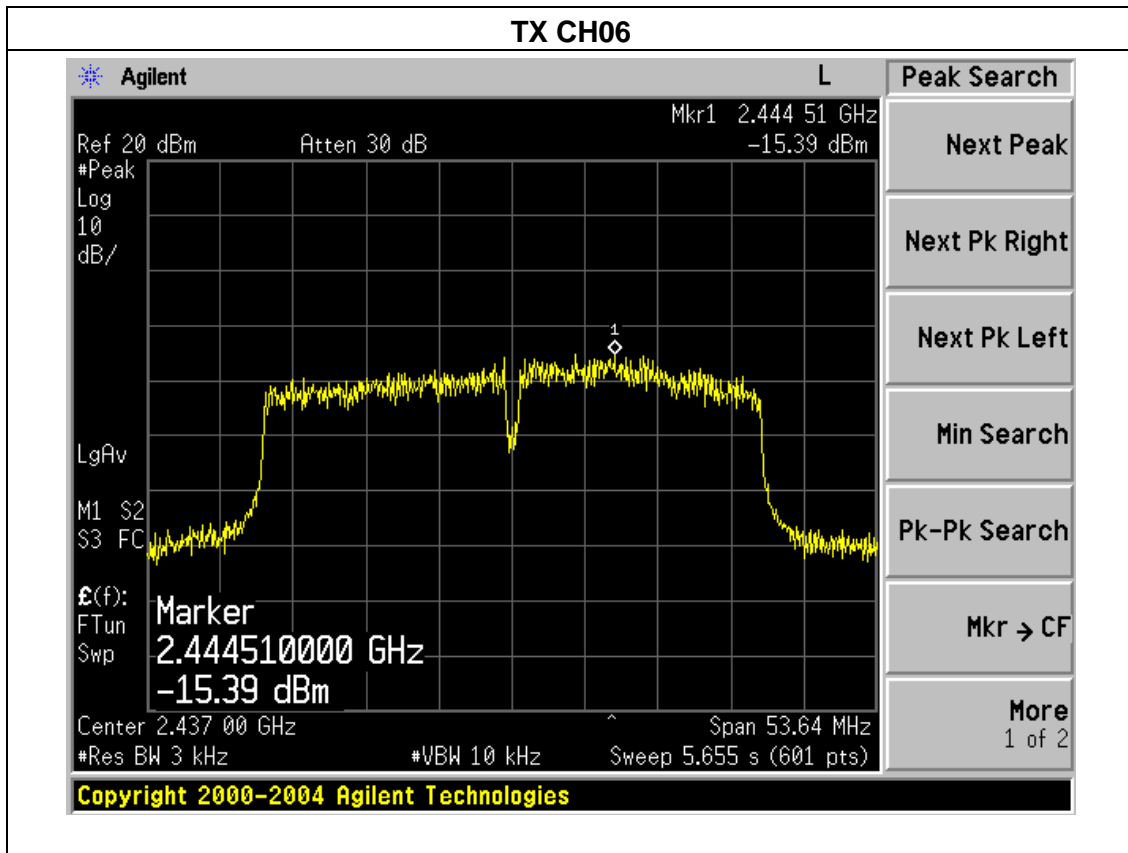



5. BANDWIDTH TEST

5.1 APPLIED PROCEDURES / LIMIT

FCC Part15 (15.247) , Subpart C				
Section	Test Item	Limit	Frequency Range (MHz)	Result
15.247(a)(2)	Bandwidth	$\geq 500\text{KHz}$ (6dB bandwidth)	2400-2483.5	PASS

5.1.1 TEST PROCEDURE

1. Set RBW = 100 kHz.
2. Set the video bandwidth (VBW) $\geq 3 \times$ RBW.
3. Detector = Peak.
4. Trace mode = max hold.
5. Sweep = auto couple.
6. Allow the trace to stabilize.
7. Measure the maximum width of the emission that is constrained by the frequencies associated with the two outermost amplitude points (upper and lower frequencies) that are attenuated by 6 dB relative to the maximum level measured in the fundamental emission.

5.1.2 DEVIATION FROM STANDARD

No deviation.

5.1.3 TEST SETUP



5.1.4 EUT OPERATION CONDITIONS

The EUT tested system was configured as the statements of 2.4 Unless otherwise a special operating condition is specified in the follows during the testing.



5.1.5 TEST RESULTS

Temperature :	25°C	Relative Humidity :	60%
Pressure :	1012 hPa	Test Voltage :	DC 5V From Adapter
Test Mode :	TX b Mode		

Frequency (MHz)	6dB bandwidth (MHz)	Limit (kHz)	Result
2412	8.123	500	Pass
2437	8.072	500	Pass
2462	8.106	500	Pass

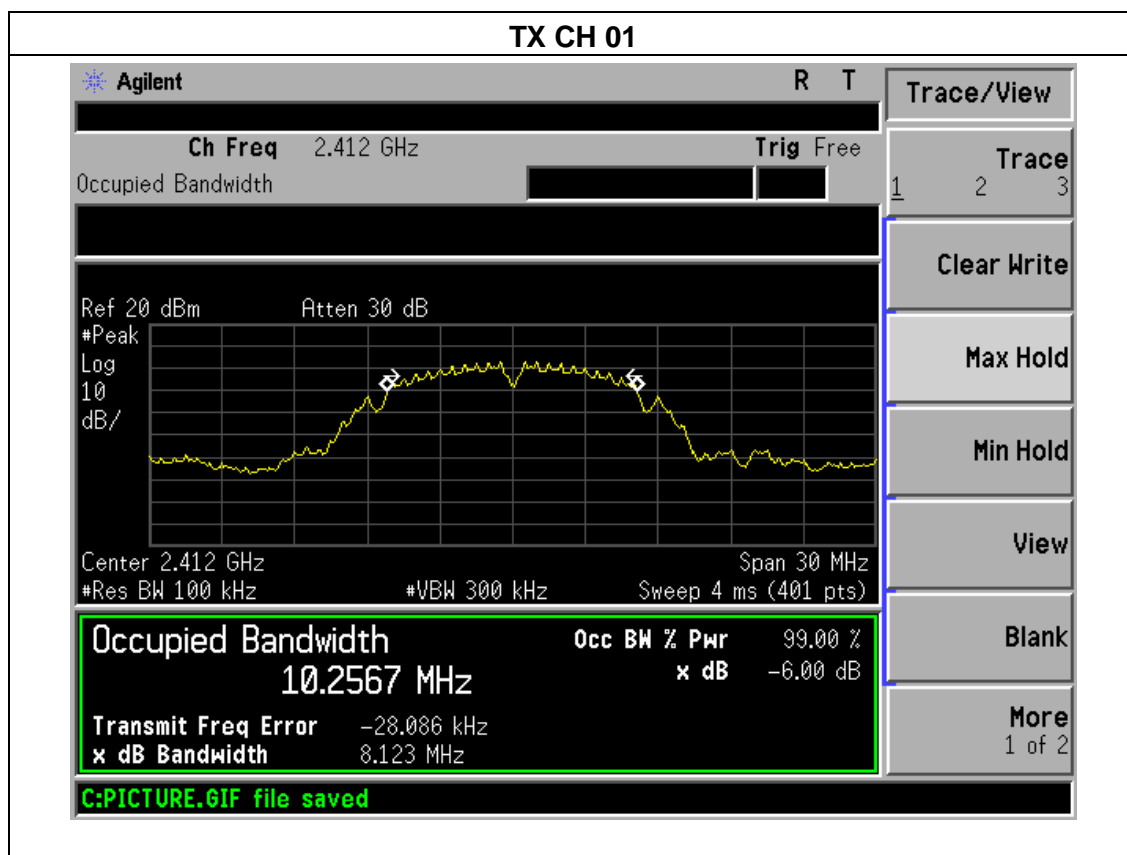

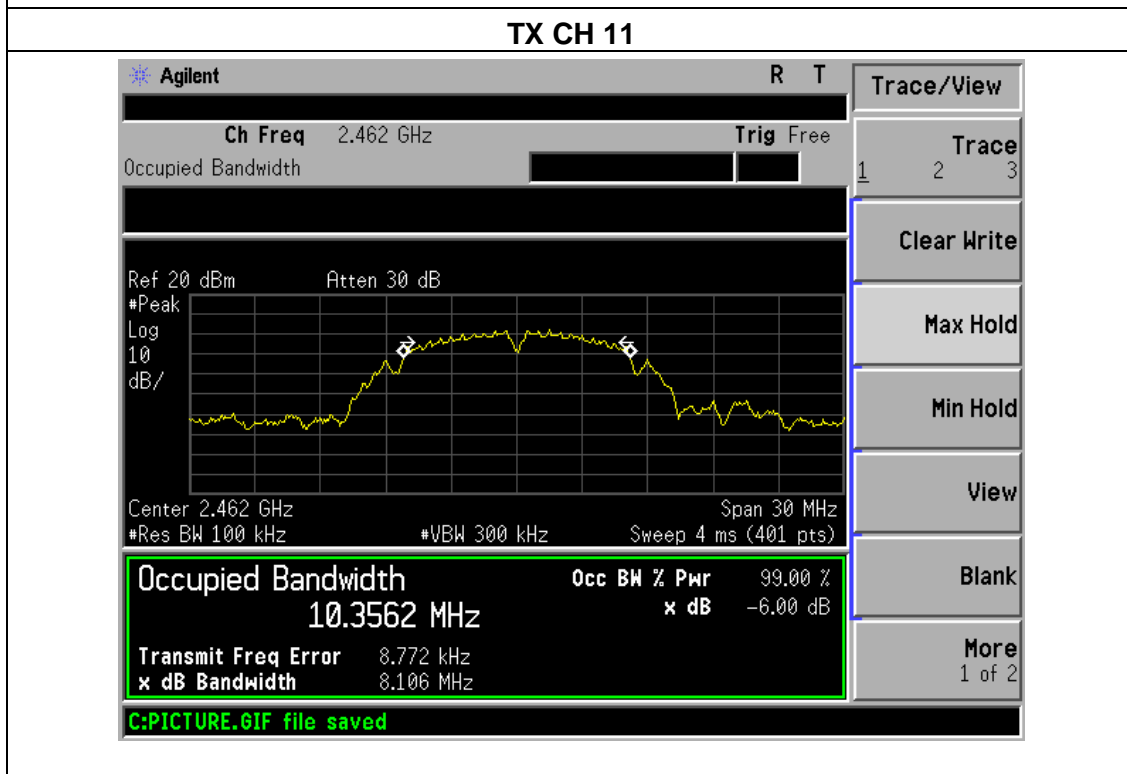
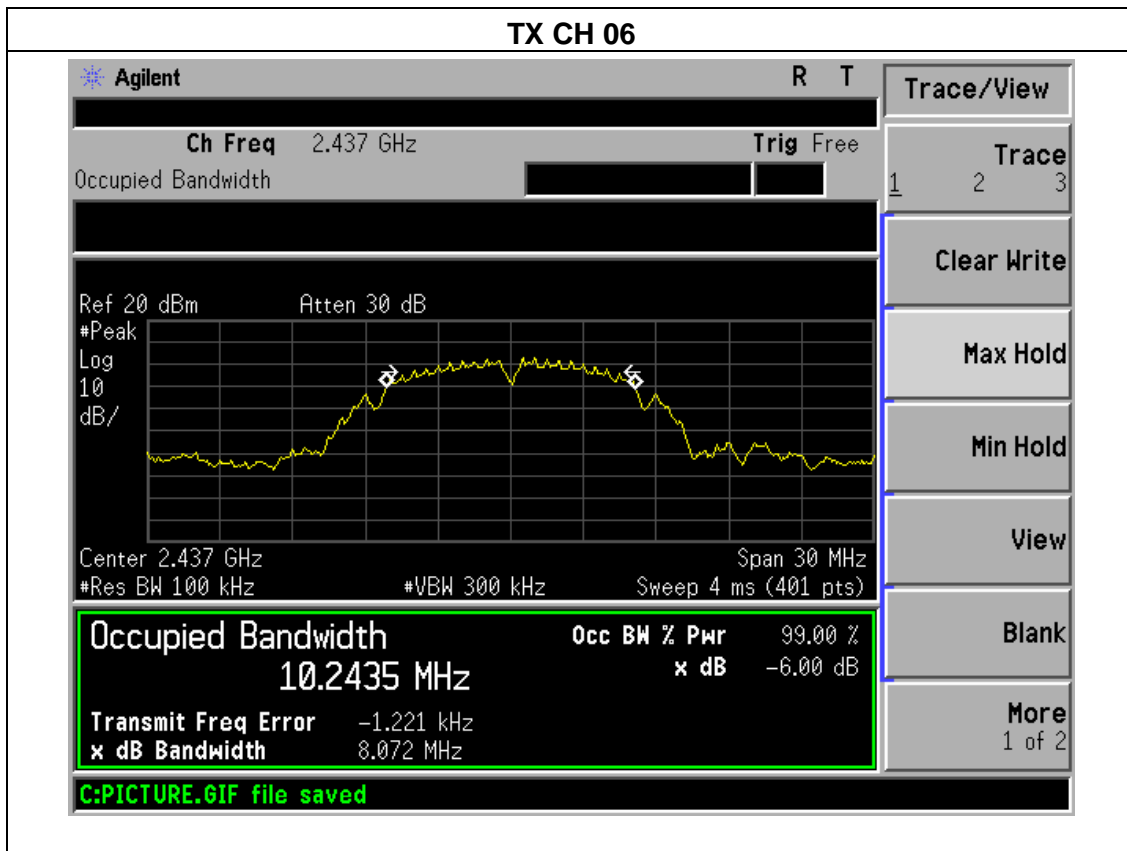



Temperature :	25°C	Relative Humidity :	60%
Pressure :	1012 hPa	Test Voltage :	DC 5V From Adapter
Test Mode :	TX g Mode		

Frequency (MHz)	6dB bandwidth (MHz)	Limit (kHz)	Result
2412	16.115	500	Pass
2437	16.416	500	Pass
2462	16.521	500	Pass

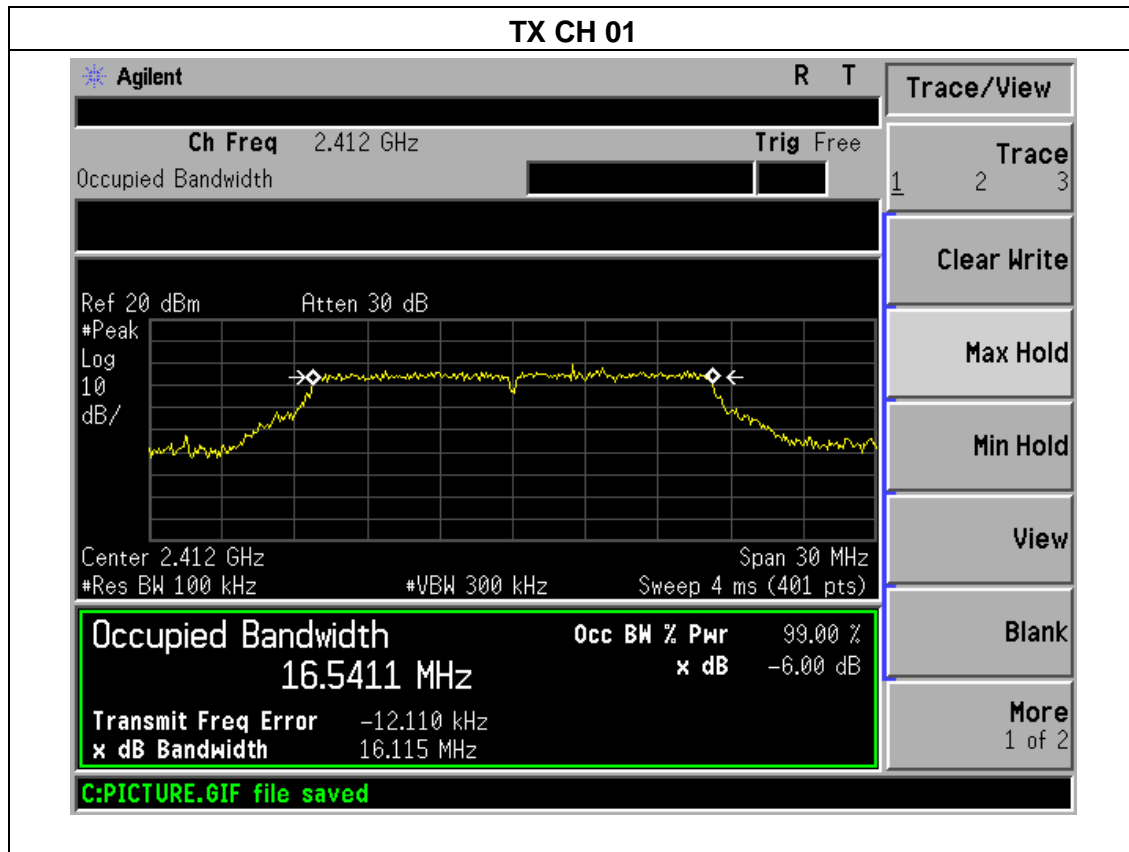

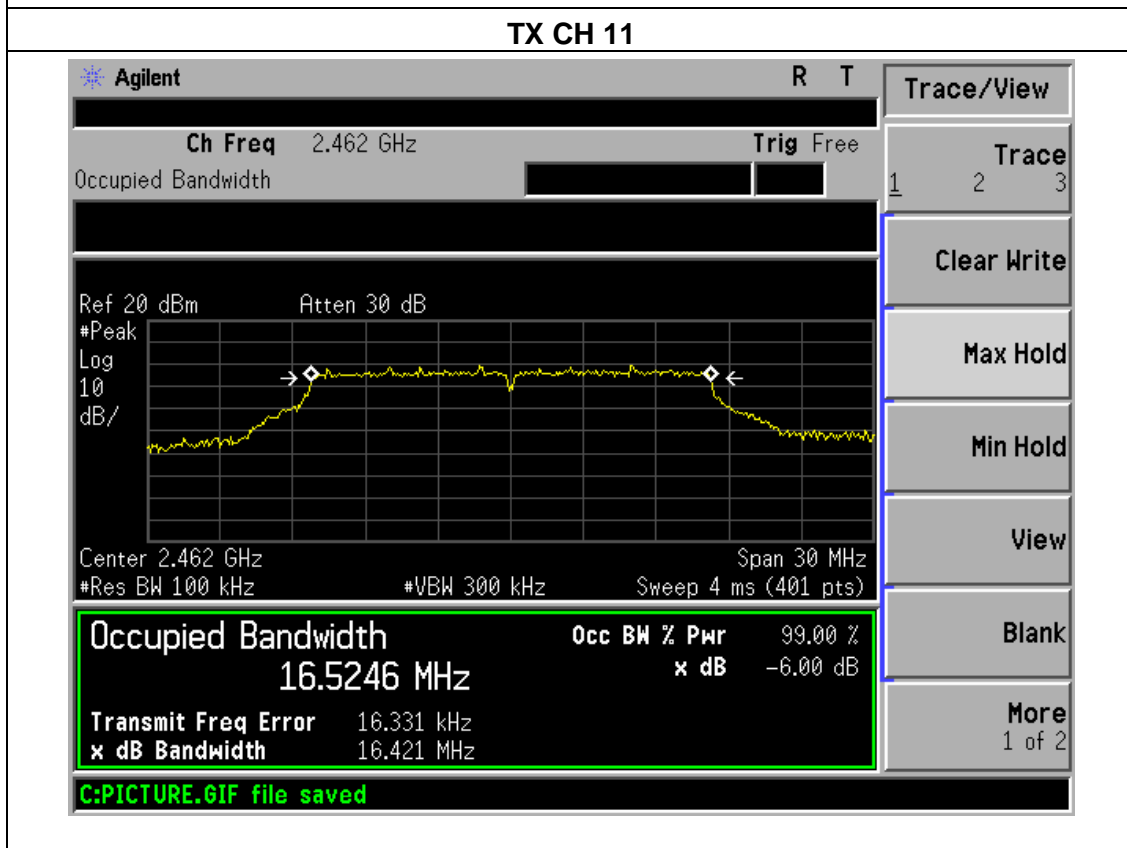
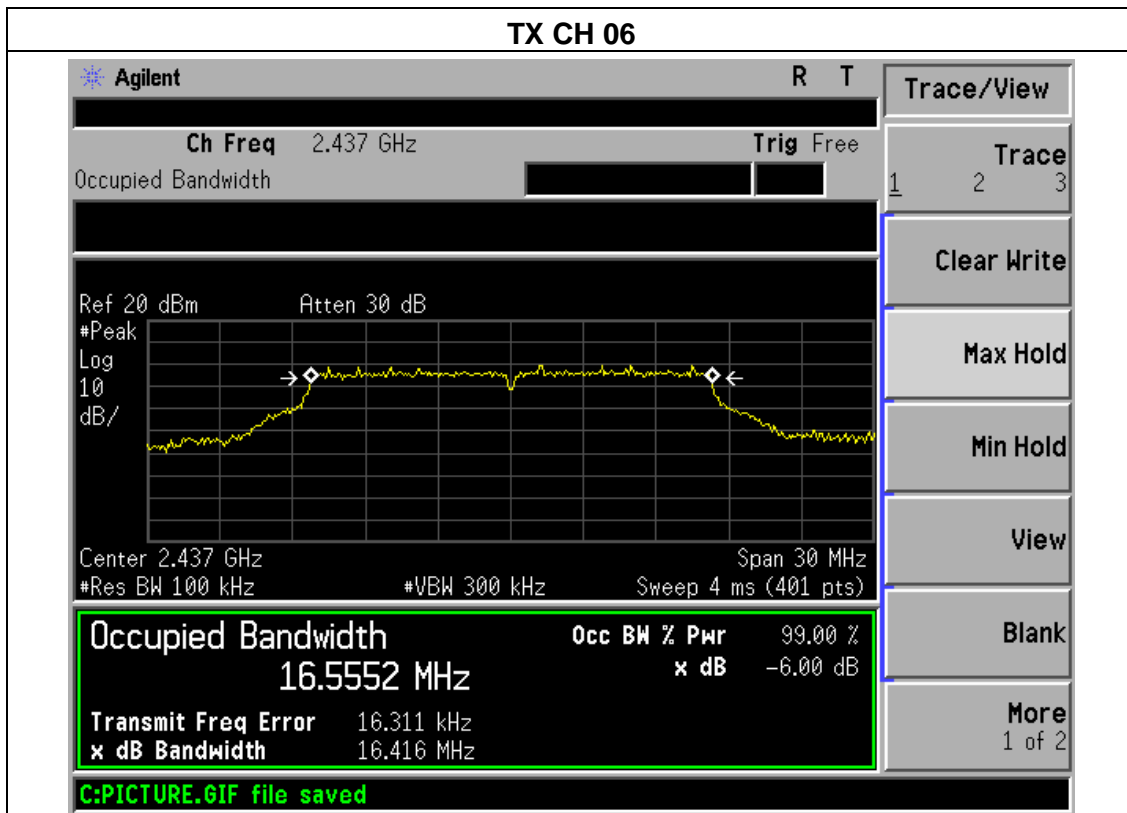



Temperature :	25°C	Relative Humidity :	60%
Pressure :	1012 hPa	Test Voltage :	DC 5V From Adapter
Test Mode :	TX n Mode(20M)		

Frequency (MHz)	6dB bandwidth (MHz)	Limit (kHz)	Result
2412	17.646	500	Pass
2437	17.651	500	Pass
2462	17.639	500	Pass

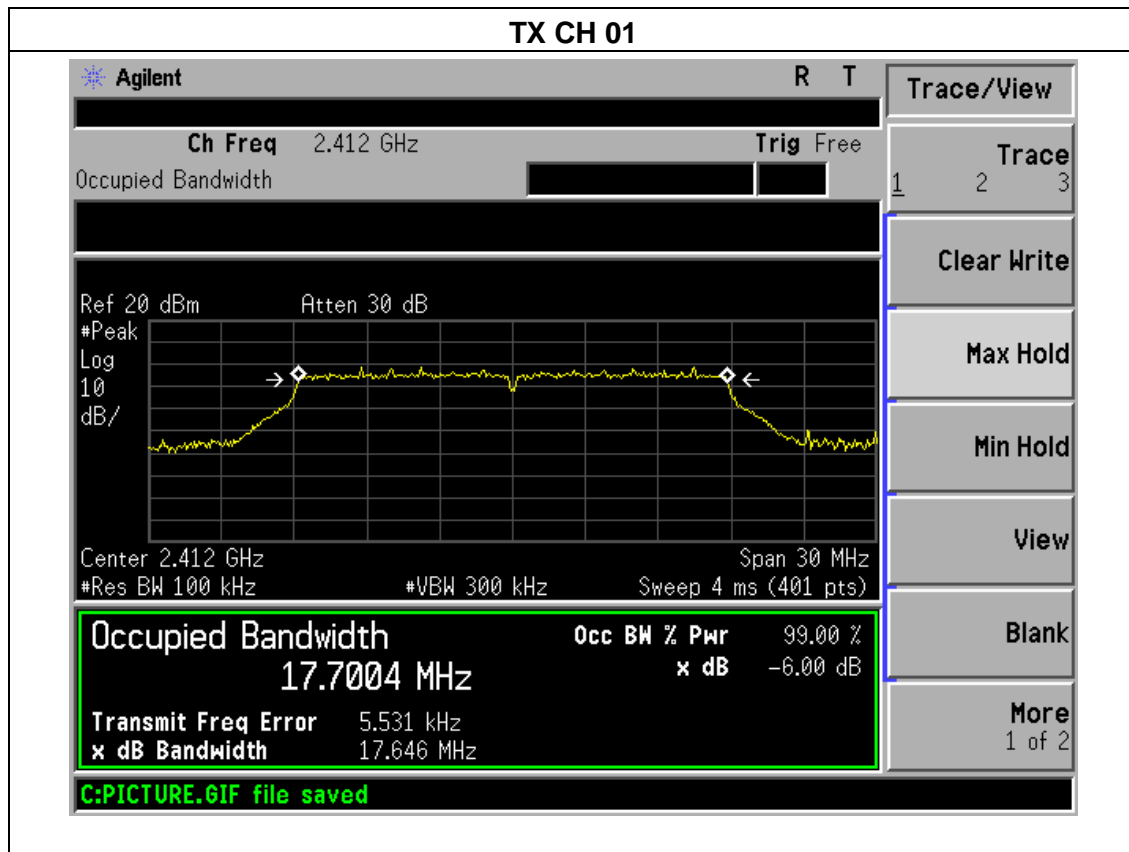

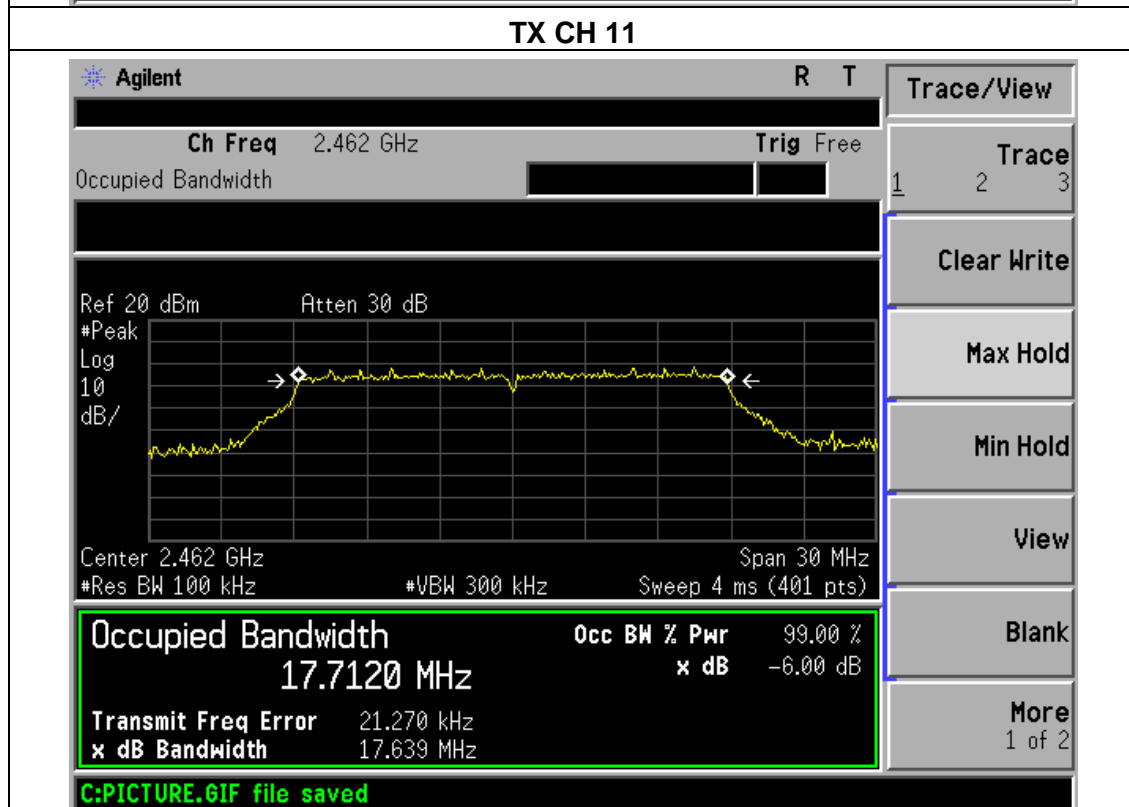
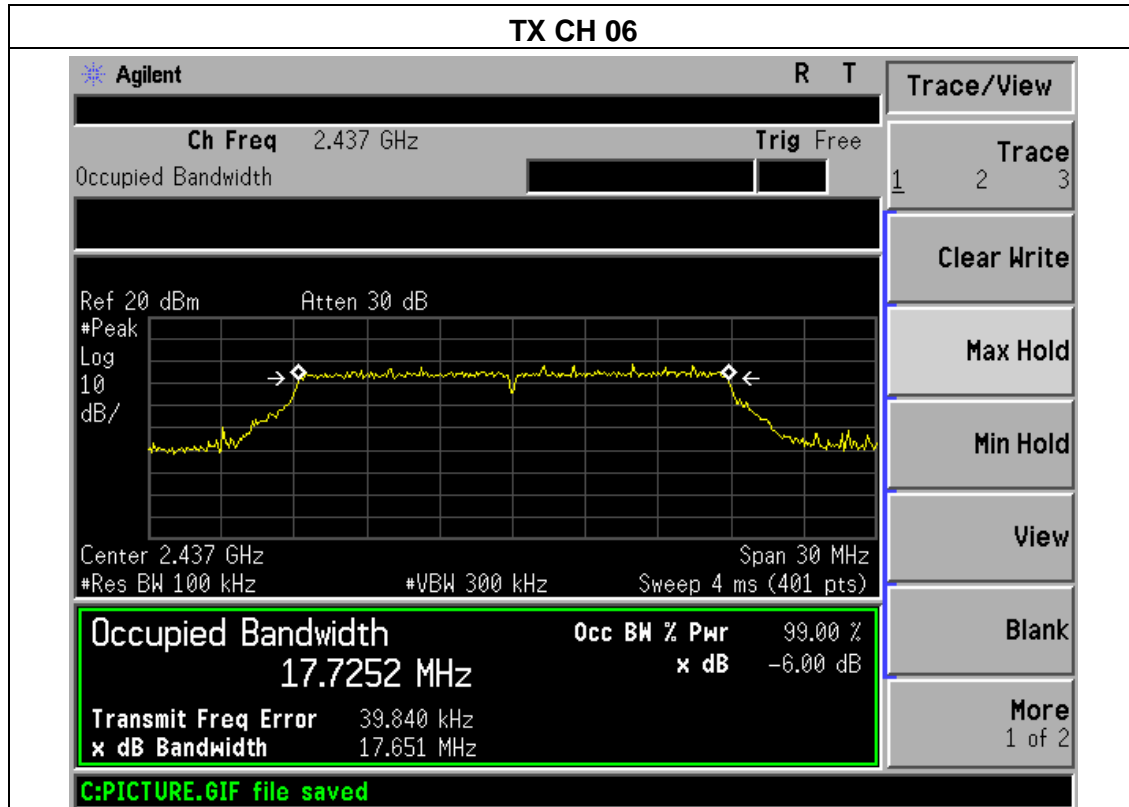



Temperature :	25°C	Relative Humidity :	60%
Pressure :	1012 hPa	Test Voltage :	DC 5V From Adapter
Test Mode :	TX n Mode(40M)		

Frequency (MHz)	6dB bandwidth (MHz)	Limit (kHz)	Result
2422	35.368	500	Pass
2437	35.121	500	Pass
2452	35.203	500	Pass

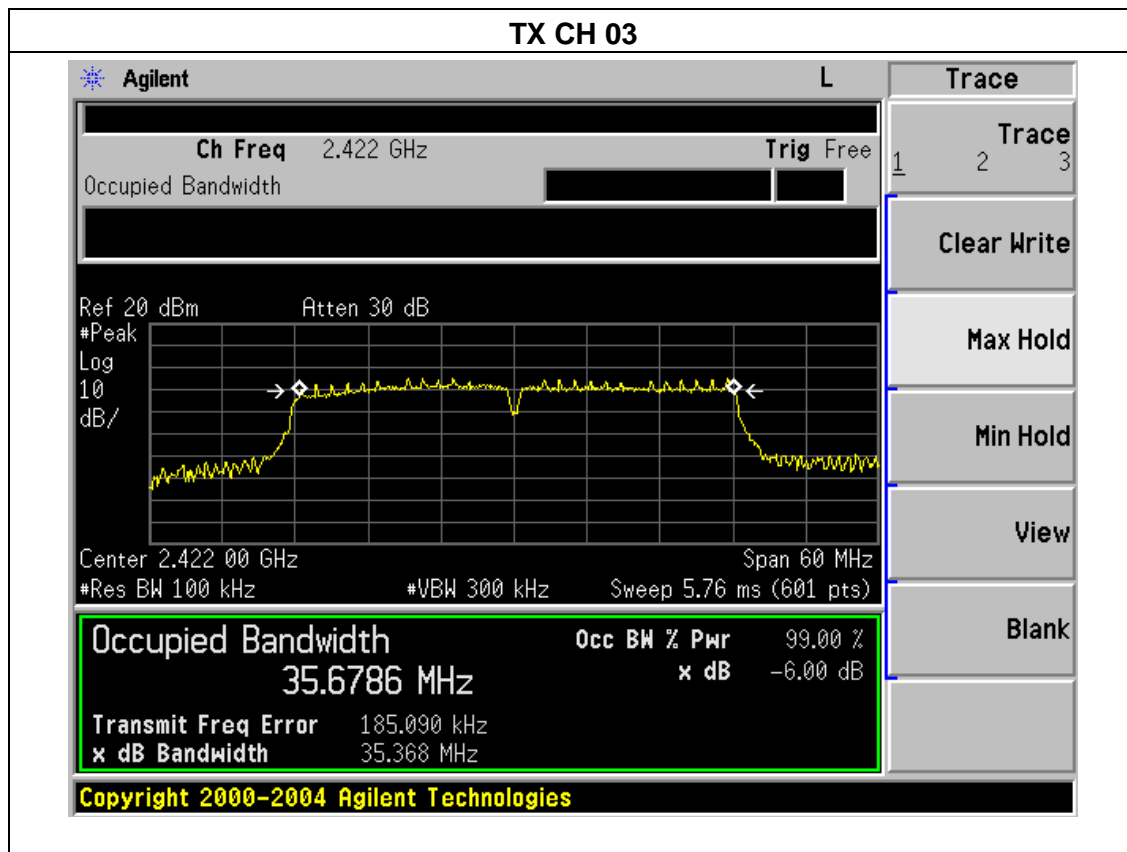

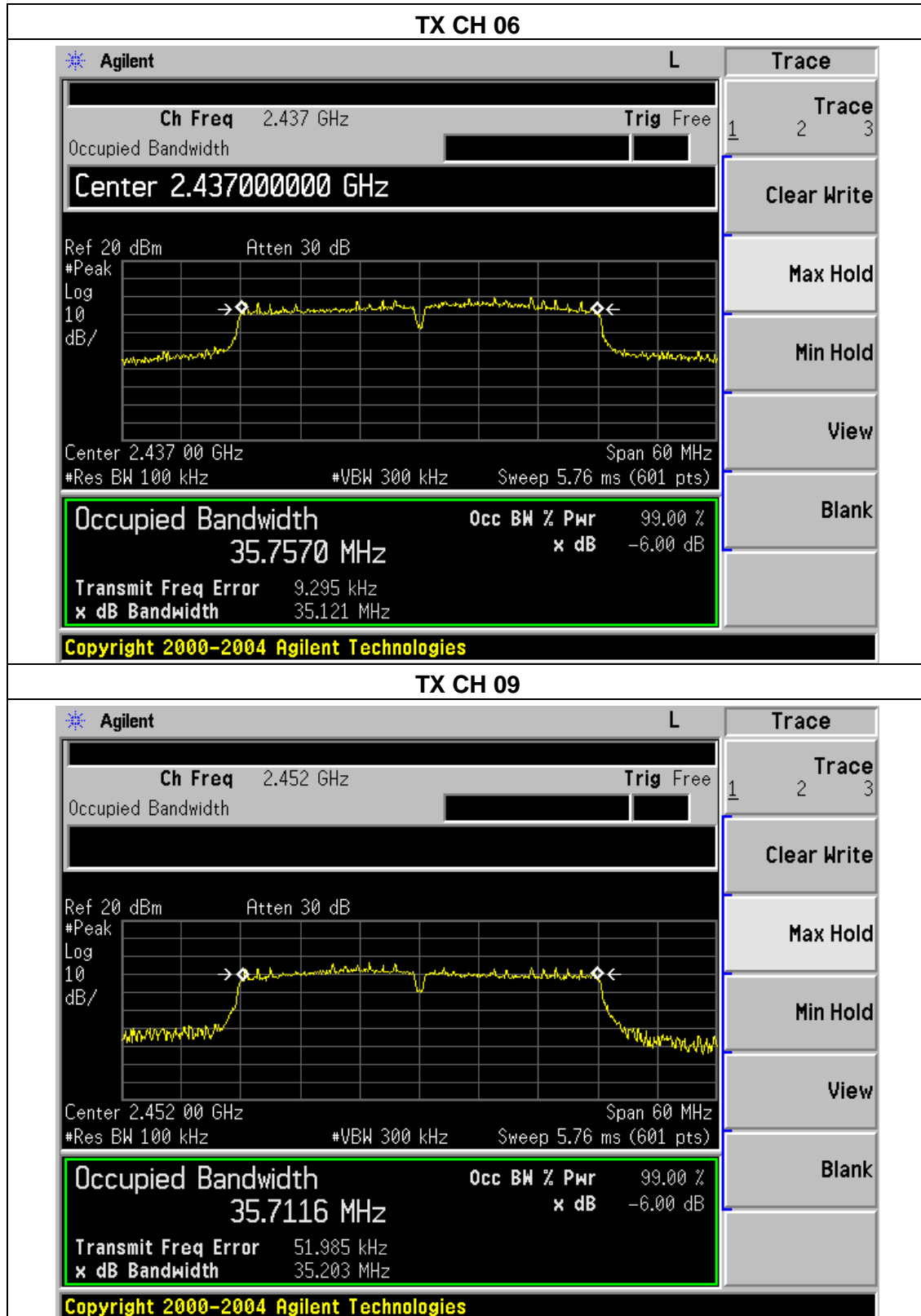

6. PEAK OUTPUT POWER TEST

6.1 APPLIED PROCEDURES / LIMIT

FCC Part15 (15.247) , Subpart C				
Section	Test Item	Limit	Frequency Range (MHz)	Result
15.247(b)(3)	Peak Output Power	1 watt or 30dBm	2400-2483.5	PASS

6.1.1 TEST PROCEDURE

- a. The EUT was directly connected to the Power meter

6.1.2 DEVIATION FROM STANDARD

No deviation.

6.1.3 TEST SETUP



6.1.4 EUT OPERATION CONDITIONS

The EUT tested system was configured as the statements of 2.4 Unless otherwise a special operating condition is specified in the follows during the testing.

**6.1.5 TEST RESULTS**

Temperature :	25°C	Relative Humidity :	60%
Pressure :	1012 hPa	Test Voltage :	DC 5V From Adapter

	Frequency	Maximum Conducted Output Power(PK)	LIMIT
	(MHz)	(dBm)	dBm
802.11b	2412	12.56	30
	2437	12.38	30
	2462	12.42	30
802.11g	2412	10.75	30
	2437	10.47	30
	2462	10.38	30
802.11n20	2412	10.54	30
	2437	10.46	30
	2462	10.72	30
802.11n40	2422	9.74	30
	2437	9.76	30
	2452	9.65	30



7. 100 KHZ BANDWIDTH OF FREQUENCY BAND EDGE

7.1 APPLICABLE STANDARD

In any 100 kHz bandwidth outside the frequency band in which the spread spectrum intentional radiator is operating, the radio frequency power that is produced by the intentional radiator shall be at least 20 dB below that in the 100 kHz bandwidth within the band that contains the highest level of the desired power, based on either an RF conducted or a radiated measurement.

7.2 TEST PROCEDURE

- a) Check the calibration of the measuring instrument using either an internal calibrator or a known signal from an external generator.
- b) Position the EUT without connection to measurement instrument. Turn on the EUT and connect its antenna terminal to measurement instrument via a low loss cable. Then set it to any one measured frequency within its operating range, and make sure the instrument is operated in its linear range.
- c) Set RBW to 100 kHz and VBW of spectrum analyzer to 300 kHz with a convenient frequency span including 100 kHz bandwidth from band edge.
- d) Measure the highest amplitude appearing on spectral display and set it as a reference level. Plot the graph with marking the highest point and edge frequency.
- e) Repeat above procedures until all measured frequencies were complete.

7.3 DEVIATION FROM STANDARD

No deviation.

7.4 TEST SETUP



7.5 EUT OPERATION CONDITIONS

The EUT tested system was configured as the statements of 2.4 Unless otherwise a special operating condition is specified in the follows during the testing.

7.1 TEST RESULTS



802.11b: Band Edge, Left Side

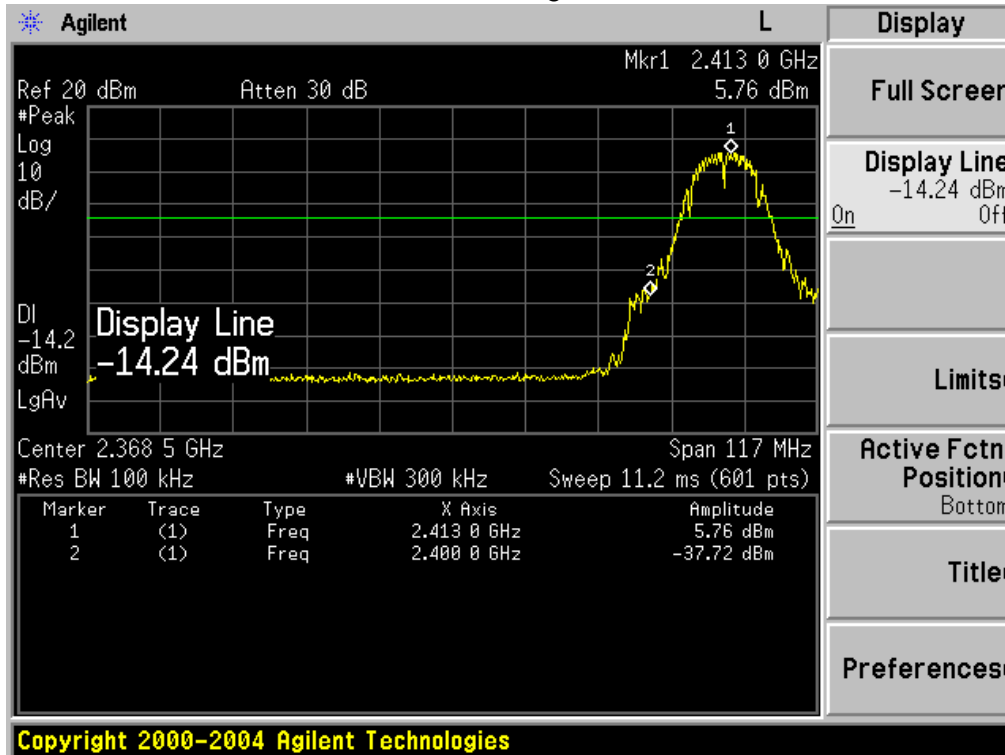

802.11b: Band Edge, Right Side

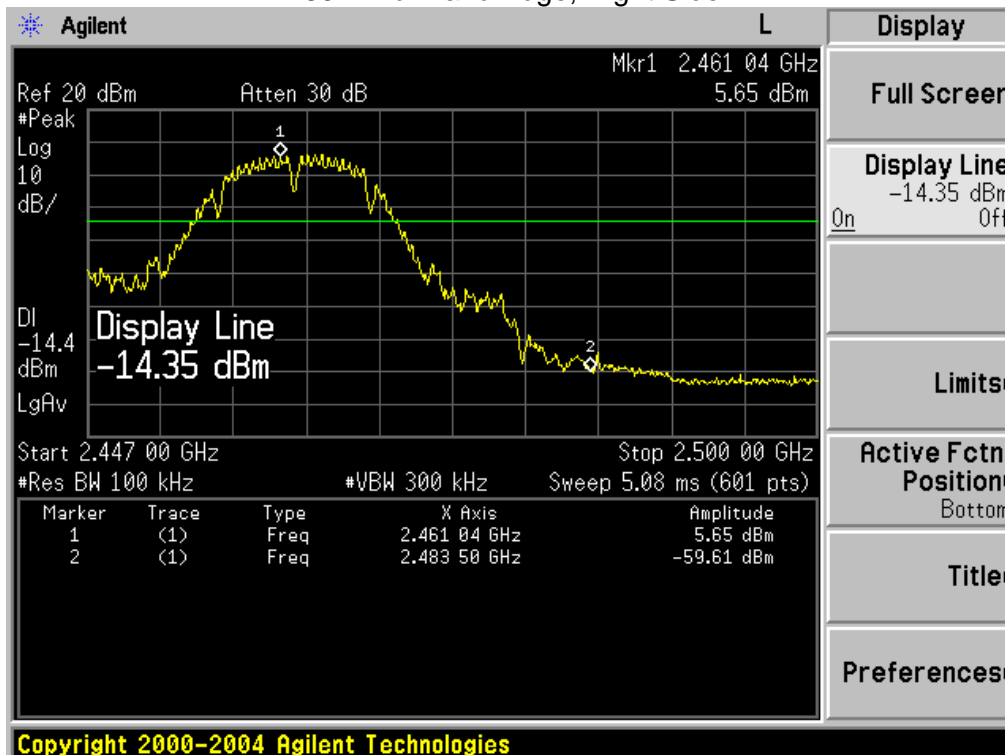



802.11g: Band Edge, Left Side

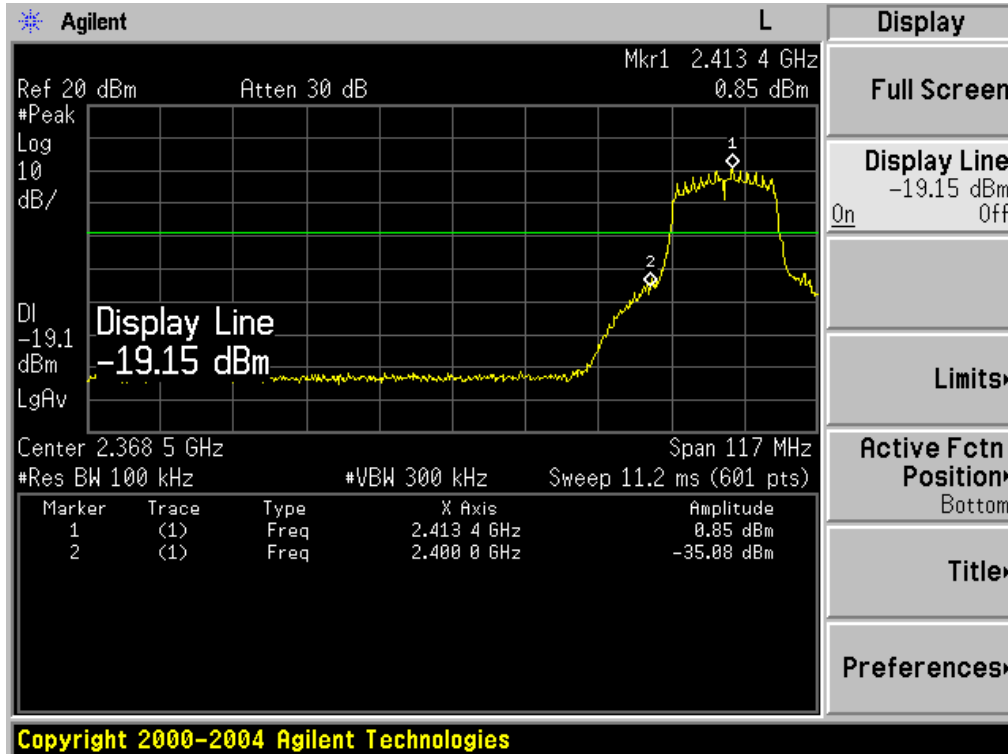

802.11g: Band Edge, Right Side

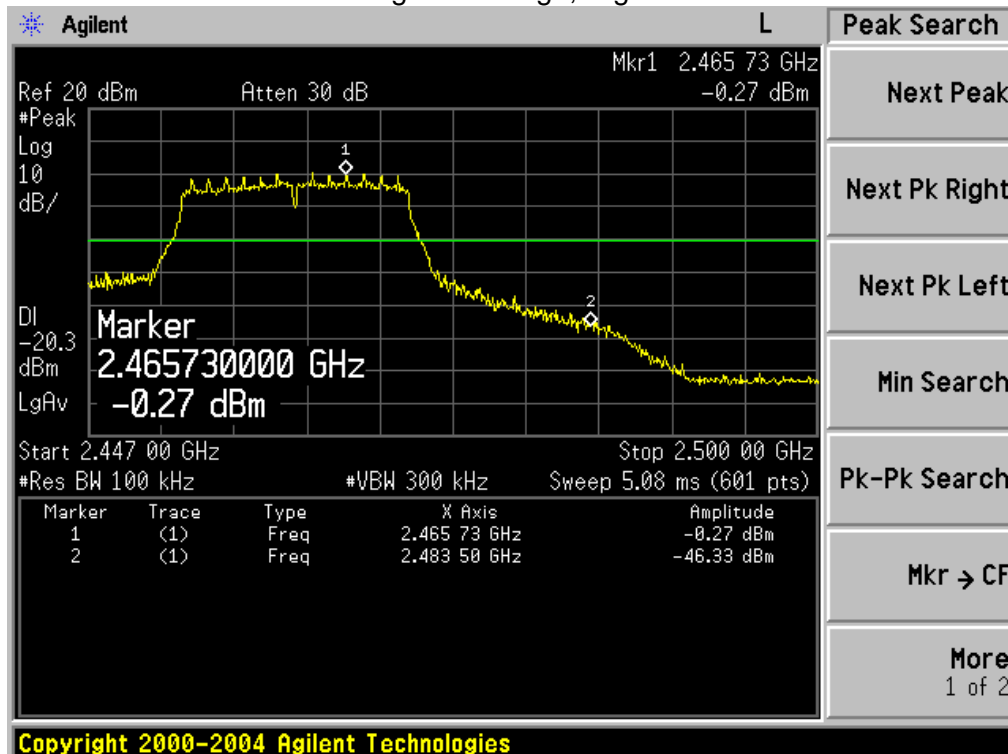



802.11n-HT20: Band Edge, Left Side

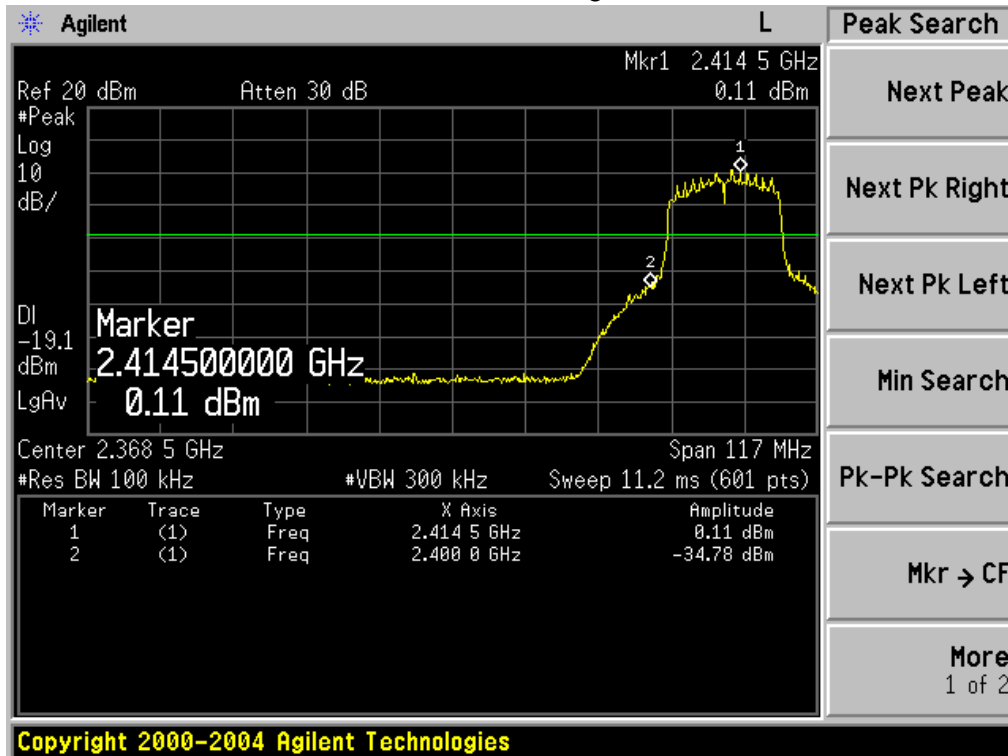

802.11n-HT20: Band Edge, Right Side

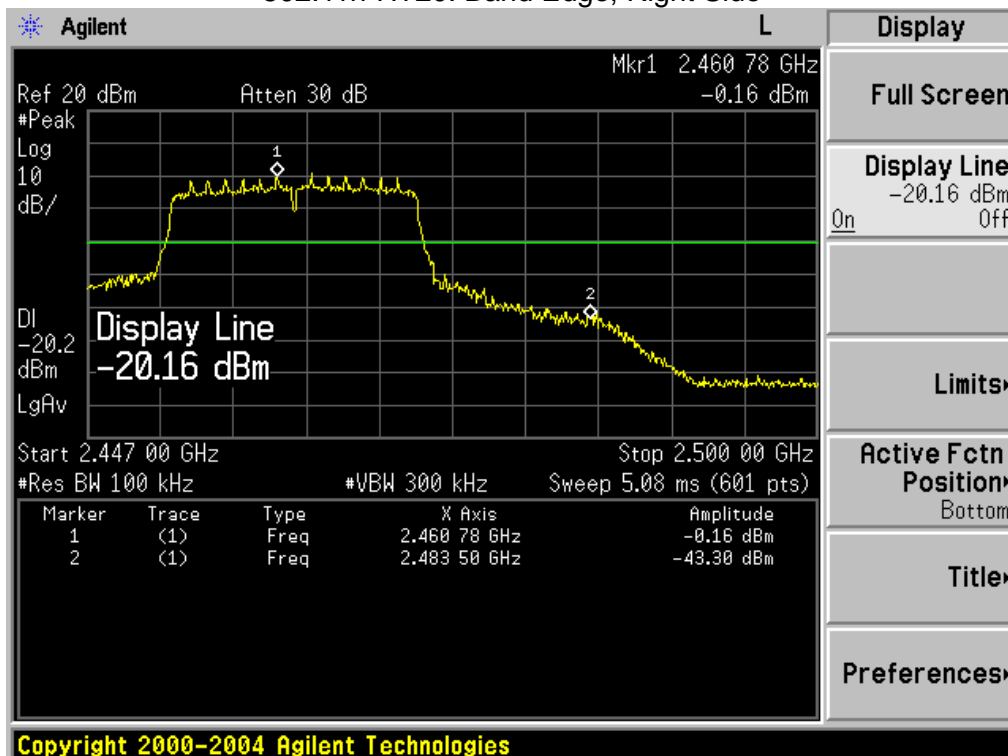



802.11n-HT40: Band Edge, Left Side

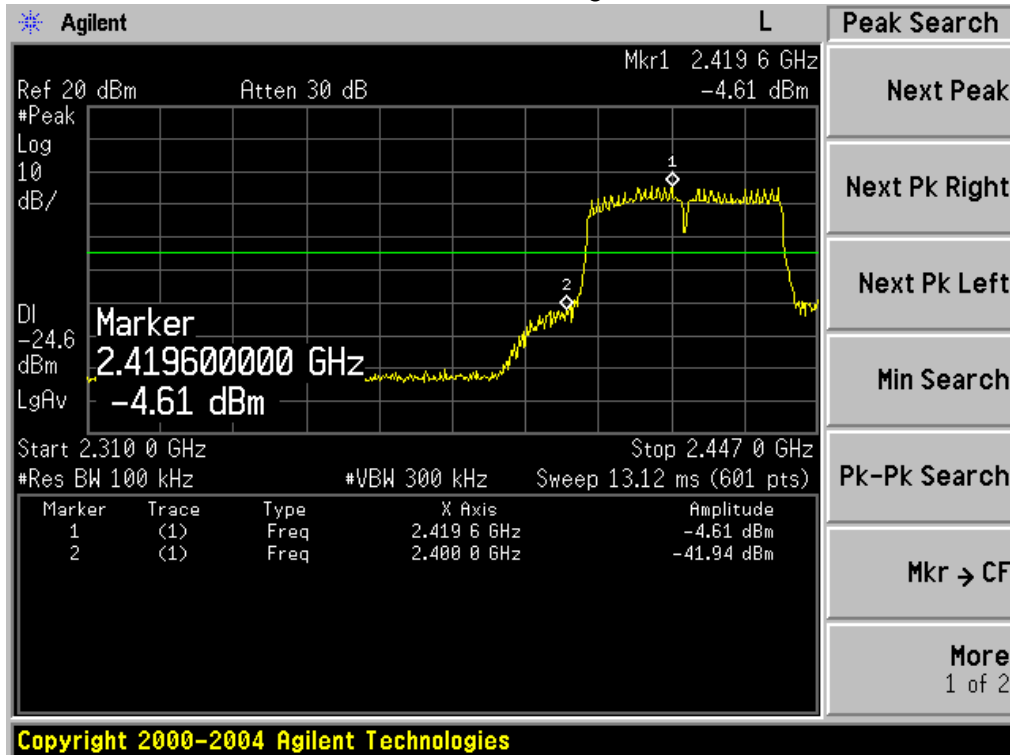

802.11n-HT40: Band Edge, Right Side

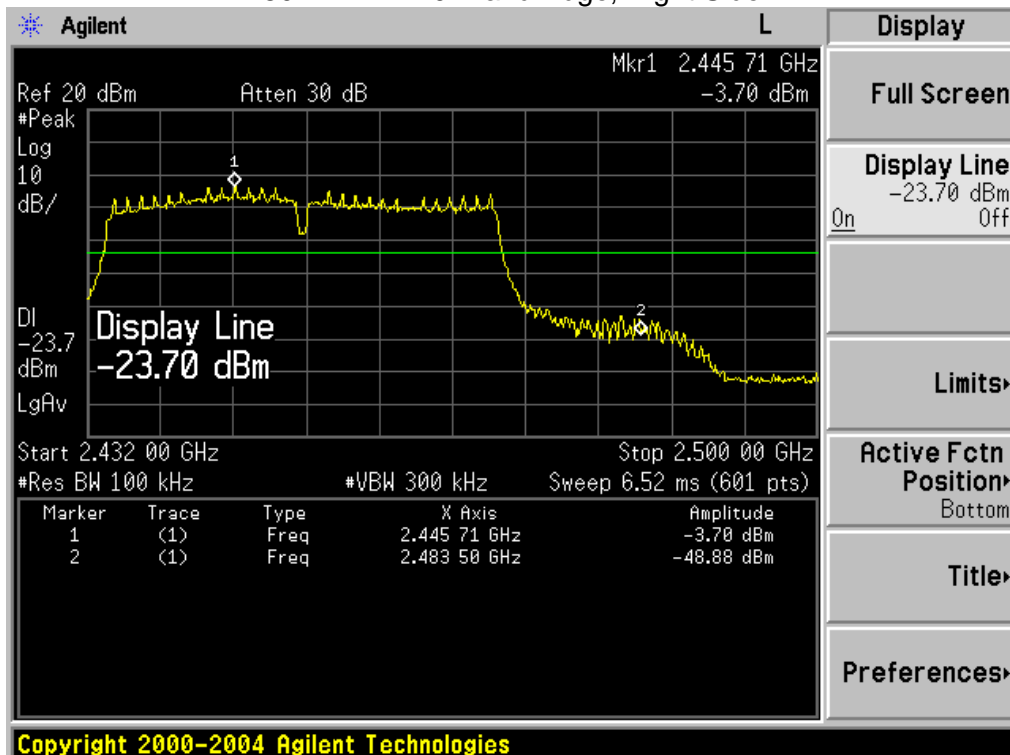



8. ANTENNA REQUIREMENT

8.1 STANDARD REQUIREMENT

15.203 requirement: For intentional device, according to 15.203: an intentional radiator shall be designed to ensure that no antenna other than that furnished by the responsible party shall be used with the device.

8.2 EUT ANTENNA

The EUT antenna is internal antenna, It comply with the standard requirement.

9. EUT TEST PHOTO

Radiated Measurement Photos



Radiated Measurement Photos

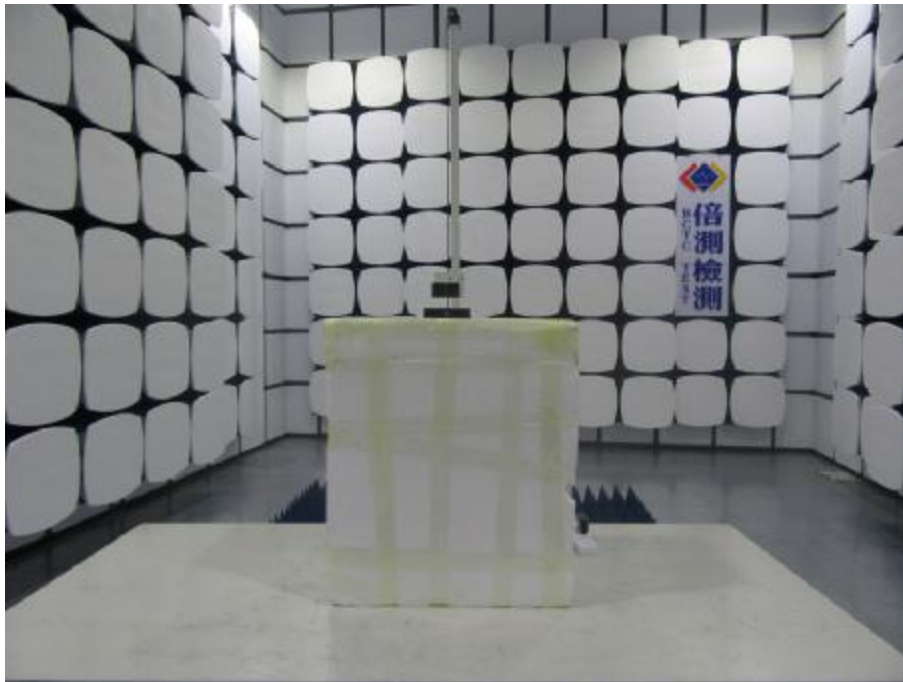



Conducted Emission



10. EUT PHOTO



***** END OF REPORT *****