



TEST REPORT

Report Reference No...... : **TRE1609020301** R/C.....:46717

FCC ID..... : **2AKFH-UPROBE-L**

Applicant's name..... : **Guangzhou Sonostar Technologies Co., Ltd.**

Address..... : 504#, C Building, #27 Yayingshi Road, Science Town, Guangzhou, China

Manufacturer..... : Guangzhou Sonostar Technologies Co., Ltd.

Address..... : 504#, C Building, #27 Yayingshi Road, Science Town, Guangzhou, China

Test item description : **Wireless Probe Type Ultrasound Scanner**

Trade Mark : -

Model/Type reference..... : UProbe-L

Listed Model(s) : UProbe-C, BProbe

Standard : **FCC CFR Title 47 Part 15 Subpart C Section 15.247**

Date of receipt of test sample..... : Sept. 30,2016

Date of testing..... : Sept. 30,2016 - Nov. 29,2016

Date of issue..... : Nov. 30,2016

Result..... : **PASS**

Compiled by
(position+printedname+signature)....: File administrators Becky Liang 

Supervised by
(position+printedname+signature).....: Project Engineer Jeff Sun 

Approved by
(position+printedname+signature).....: RF Manager Hans Hu 

Testing Laboratory Name : **Shenzhen Huatongwei International Inspection Co., Ltd.**

Address..... : 1/F, Bldg 3, Hongfa Hi-tech Industrial Park, Genyu Road, Tianliao, Gongming, Shenzhen, China

Shenzhen Huatongwei International Inspection Co., Ltd. All rights reserved.

This publication may be reproduced in whole or in part for non-commercial purposes as long as the Shenzhen Huatongwei International Inspection Co., Ltd. is acknowledged as copyright owner and source of the material. Shenzhen Huatongwei International Inspection Co., Ltd. takes no responsibility for and will not assume liability for damages resulting from the reader's interpretation of the reproduced material due to its placement and context.

Contents

1.	<u>TEST STANDARDS AND REPORT VERSION</u>	3
1.1.	Applicable Standards	3
1.2.	Report version	3
2.	<u>TEST DESCRIPTION</u>	4
3.	<u>SUMMARY</u>	5
3.1.	Client Information	5
3.2.	Product Description	5
3.3.	Operation state	6
3.4.	EUT configuration	6
3.5.	Modifications	6
4.	<u>TEST ENVIRONMENT</u>	7
4.1.	Address of the test laboratory	7
4.2.	Test Facility	7
4.3.	Equipments Used during the Test	8
4.4.	Environmental conditions	9
4.5.	Statement of the measurement uncertainty	9
5.	<u>TEST CONDITIONS AND RESULTS</u>	10
5.1.	Antenna requirement	10
5.2.	Conducted Emission (AC Main)	11
5.3.	Conducted Peak Output Power	14
5.4.	Power Spectral Density	15
5.5.	6dB bandwidth	19
5.6.	Restricted band	23
5.7.	Band edge and Spurious Emission (conducted)	27
5.8.	Spurious Emission (radiated)	31
6.	<u>TEST SETUP PHOTOS OF THE EUT</u>	40
7.	<u>EXTERNAL AND INTERNAL PHOTOS OF THE EUT</u>	42

1. Test standards and Report version

1.1. Applicable Standards

The tests were performed according to following standards:

[FCC Rules Part 15.247](#): Frequency Hopping, Direct Spread Spectrum and Hybrid Systems that are in operation within the bands of 902-928 MHz, 2400-2483.5 MHz, and 5725-5850 MHz.

[ANSI C63.10:2013](#): American National Standard for Testing Unlicensed Wireless Devices

[KDB558074 D01 DTS Meas Guidance v03r05](#): Guidance for Performing Compliance Measurements on Digital Transmission Systems (DTS) Operating under § 15.247

1.2. Report version

Version No.	Date of issue	Description
00	Nov. 30, 2016	Original

2. Test Description

Test Item	Section in CFR 47	Result
Antenna requirement	15.203/15.247 (c)	Pass
Line Conducted Emission (AC Main)	15.207	Pass
Conducted Peak Output Power	15.247 (b)(3)	Pass
Power Spectral Density	15.247 (e)	Pass
6dB Bandwidth	15.247 (a)(2)	Pass
Restricted band	15.247(d)/15.205	Pass
Spurious Emission	15.247(d)/15.209	Pass

Note: The measurement uncertainty is not included in the test result.

3. Summary

3.1. Client Information

Applicant:	Guangzhou Sonostar Technologies Co., Ltd.
Address:	504#, C Building, #27 Yayingshi Road, Science Town, Guangzhou, China
Manufacturer:	Guangzhou Sonostar Technologies Co., Ltd.
Address:	504#, C Building, #27 Yayingshi Road, Science Town, Guangzhou, China

3.2. Product Description

Name of EUT	Wireless Probe Type Ultrasound Scanner		
Trade Mark:	-		
Model No.:	UProbe-L		
Listed Model(s):	UProbe-C, BProbe		
Power supply:	DC 3.8V for internal battery		
Adapter information:	-		
WIFI			
Supported type:	<input checked="" type="checkbox"/> 802.11b	<input checked="" type="checkbox"/> 802.11g	<input checked="" type="checkbox"/> 802.11n(H20)
Modulation:	DSSS for 802.11b OFDM for 802.11g/802.11n(H20)		
Operation frequency:	2412MHz~2462MHz for 802.11b/802.11g/802.11n(H20)		
Channel number:	11 for 802.11b/802.11g/802.11n(H20)		
Channel separation:	5MHz		
Antenna type:	Integral antenna		
Antenna gain:	0 dBi		

3.3. Operation state

➤ Test frequency list

According to section 15.31(m), regards to the operating frequency range over 10 MHz, must select three channel which were tested. the Lowest frequency, the middle frequency, and the highest frequency of channel were selected to perform the test, please see the above gray bottom.

802.11b/g/n(H20)	
Channel	Frequency (MHz)
01	2412
02	2417
03	2422
04	2427
05	2432
06	2437
07	2442
08	2447
09	2452
10	2457
11	2462

➤ Test mode

For RF test items
The engineering test program was provided and enabled to make EUT continuous transmit.
For AC power line conducted emissions:
The EUT was set to connect with the WLAN AP under large package sizes transmission.
For RF test axis
EUT in each of three orthogonal axis emissions had been tested ,but only the worst case (X axis) data Recorded in the report.

3.4. EUT configuration

The following peripheral devices and interface cables were connected during the measurement:

- - supplied by the manufacturer
- - supplied by the lab

●	USB Power Adapter	Manufacturer :	Apple Inc.
		Model No. :	A1357
-	-	Manufacturer :	-
		Model No. :	-

3.5. Modifications

No modifications were implemented to meet testing criteria.

4. Test Environment

4.1. Address of the test laboratory

Laboratory:Shenzhen Huatongwei International Inspection Co., Ltd.

Address: 1/F, Bldg 3, Hongfa Hi-tech Industrial Park, Genyu Road, Tianliao, Gongming, Shenzhen, China

Phone: 86-755-26748019 Fax: 86-755-26748089

4.2. Test Facility

The test facility is recognized, certified, or accredited by the following organizations:

CNAS-Lab Code: L1225

Shenzhen Huatongwei International Inspection Co., Ltd. has been assessed and proved to be in compliance with CNAS-CL01 Accreditation Criteria for Testing and Calibration Laboratories

(identical to ISO/IEC17025: 2005 General Requirements) for the Competence of Testing and Calibration Laboratories, Date of Registration: February 28, 2015. Valid time is until February 27, 2018.

A2LA-Lab Cert. No. 3902.01

Shenzhen Huatongwei International Inspection Co., Ltd. EMC Laboratory has been accredited by A2LA for technical competence in the field of electrical testing, and proved to be in compliance with ISO/IEC 17025: 2005 General Requirements for the Competence of Testing and Calibration Laboratories and any additional program requirements in the identified field of testing. Valid time is until December 31, 2016.

FCC-Registration No.: 317478

Shenzhen Huatongwei International Inspection Co., Ltd. EMC Laboratory has been registered and fully described in a report filed with the FCC (Federal Communications Commission). The acceptance letter from the FCC is maintained in our files. Registration 317478, Renewal date Jul. 18, 2014, valid time is until Jul. 18, 2017.

IC-Registration No.: 5377A&5377B

The 3m Alternate Test Site of Shenzhen Huatongwei International Inspection Co., Ltd. has been registered by Certification and Engineering Bureau of Industry Canada for the performance of radiated measurements with Registration No. 5377A on Dec. 31, 2013, valid time is until Dec. 31, 2016.

Two 3m Alternate Test Site of Shenzhen Huatongwei International Inspection Co., Ltd. has been registered by Certification and Engineering Bureau of Industry Canada for the performance of radiated measurements with Registration No. 5377B on Dec.03, 2014, valid time is until Dec.03, 2017.

ACA

Shenzhen Huatongwei International Inspection Co., Ltd. EMC Laboratory can also perform testing for the Australian C-Tick mark as a result of our A2LA accreditation.

4.3. Equipments Used during the Test

Line Conducted Emission (AC Main)					
Item	Test Equipment	Manufacturer	Model No.	Serial No.	Last Cal.
1	EMI Test Receiver	R&S	ESCI	101247	2016/11/13
2	Artificial Mains	Shwarzbeck	NNLK 8121	573	2016/11/13
3	Pulse Limiter	R&S	ESH3-Z2	101488	2016/11/13
4	Test Software	R&S	ES-K1	N/A	N/A
5	Test cable	ENVIROFLEX	3651	1101902	2016/11/13

Maximum Peak Output Power / Power Spectral Density / 6dB Bandwidth / Band Edge Compliance of RF Emission / Spurious RF Conducted Emission					
Item	Test Equipment	Manufacturer	Model No.	Serial No.	Last Cal
1	Spectrum Analyzer	Rohde&Schwarz	FSP	1164.4391.40	2016/11/13
2	Power Meter	Anritsu	ML2480B	100798	2016/11/13
3	Power Sensor	Anritsu	MA2411B	100258	2016/11/13
4	Test cable	FARPU	MCX-J	N/A	2016/11/13
5	Temporary antenna connector	D-LENP	NJ-SMAK	N/A	2016/11/13

NOTE: The temporary antenna connector is soldered on the PCB board in order to perform conducted tests and this temporary antenna connector is listed in the equipment list.

Radiated Emission					
Item	Test Equipment	Manufacturer	Model No.	Serial No.	Last Cal.
1	EMI Test Receiver	Rohde&Schwarz	ESI 26	100009	2016/11/13
2	RF Test Panel	Rohde&Schwarz	TS / RSP	335015/0017	N/A
3	EMI Test Software	Rohde&Schwarz	ESK1	N/A	N/A
4	Loop Antenna	Rohde&Schwarz	HZ-9	838622/013	2016/11/13
5	Ultra-Broadband Antenna	ShwarzBeck	VULB9163	538	2016/11/13
6	Horn Antenna	ShwarzBeck	9120D	1011	2016/11/13
7	Broadband Horn Antenna	Shwarzbeck	BBHA9170	BBHA917047 2	2016/11/13
8	Preamplifier	Shwarzbeck	BBV9742	9742-196	2016/11/13
9	Broadband Preamplifier	Shwarzbeck	BBV 9721	9721-102	2016/11/13
10	Broadband Preamplifier	Shwarzbeck	BBV 9718	9718-247	2016/11/13
11	Turn Table	MATURO	TT2.0	/	N/A
12	Antenna Mast	MATURO	TAM-4.0-P	/	N/A
13	EMI Test Software	Audix	E3	N/A	N/A
14	Test Software	R&S	ES-K1	N/A	N/A
15	Test cable	Siva Cables Italy	RG 58A/U	W14.02	2016/11/13

The Cal.Interval was one year

4.4. Environmental conditions

During the measurement the environmental conditions were within the listed ranges:

Temperature:	15~35°C
Relative Humidity:	30~60 %
Air Pressure:	950~1050mba

4.5. Statement of the measurement uncertainty

The data and results referenced in this document are true and accurate. The reader is cautioned that there may be errors within the calibration limits of the equipment and facilities. The measurement uncertainty was calculated for all measurements listed in this test report according to TR-100028-01 "Electromagnetic compatibility and Radio spectrum Matters (ERM); Uncertainties in the measurement of mobile radio equipment characteristics; Part 1" and TR-100028-02 "Electromagnetic compatibility and Radio spectrum Matters (ERM); Uncertainties in the measurement of mobile radio equipment characteristics; Part 2" and is documented in the Shenzhen Huatongwei International Inspection Co., Ltd quality system according to DIN EN ISO/IEC 17025. Furthermore, component and process variability of devices similar to that tested may result in additional deviation. The manufacturer has the sole responsibility of continued compliance of the device.

Hereafter the best measurement capability for Shenzhen Huatongwei laboratory is reported:

Test Items	Measurement Uncertainty	Notes
Transmitter power conducted	0.57 dB	(1)
Transmitter power Radiated	2.20 dB	(1)
Conducted spurious emission 9KHz-40 GHz	1.60 dB	(1)
Radiated spurious emission 9KHz-40 GHz	2.20 dB	(1)
Conducted Emission 9KHz-30MHz	3.39 dB	(1)
Radiated Emission 30~1000MHz	4.24 dB	(1)
Radiated Emission 1~18GHz	5.16 dB	(1)
Radiated Emission 18-40GHz	5.54 dB	(1)
Occupied Bandwidth	-----	(1)

(1) This uncertainty represents an expanded uncertainty expressed at approximately the 95% confidence level using a coverage factor of $k=1.96$.

5. Test Conditions and Results

5.1. Antenna requirement

REQUIREMENT:

FCC CFR Title 47 Part 15 Subpart C Section 15.203:

An intentional radiator shall be designed to ensure that no antenna other than that furnished by the responsible party shall be used with the device. The use of a permanently attached antenna or of an antenna that uses a unique coupling to the intentional radiator, the manufacturer may design the unit so that a broken antenna can be replaced by the user, but the use of a standard antenna jack or electrical connector is prohibited.

FCC CFR Title 47 Part 15 Subpart C Section 15.247(c) (1)(i):

(i) Systems operating in the 2400-2483.5 MHz band that is used exclusively for fixed. Point-to-point operations may employ transmitting antennas with directional gain greater than 6dBi provided the maximum conducted output power of the intentional radiator is reduced by 1 dB for every 3 dB that the directional gain of the antenna exceeds 6dBi.

TEST RESULTS

Passed **Not Applicable**

The antenna is integral antenna, the best case gain of the antenna is 0 dBi, please refer to the below antenna photo.

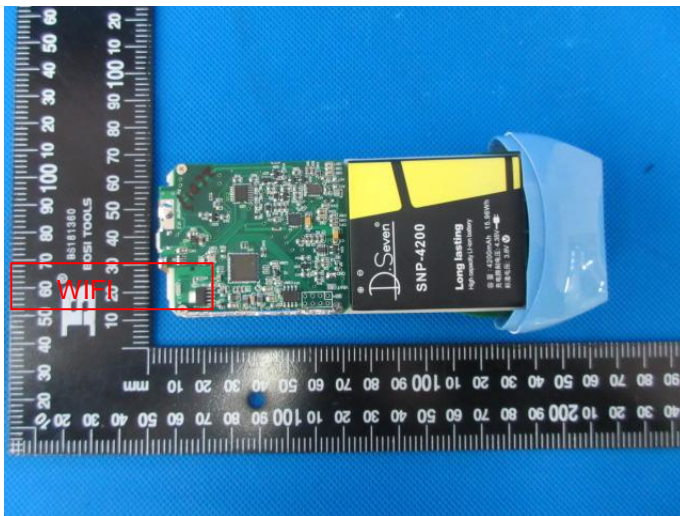

5.2. Conducted Emission (AC Main)

LIMIT

FCC CFR Title 47 Part 15 Subpart C Section 15.207:

Frequency range (MHz)	Limit (dBuV)	
	Quasi-peak	Average
0.15-0.5	66 to 56*	56 to 46*
0.5-5	56	46
5-30	60	50

* Decreases with the logarithm of the frequency.

TEST CONFIGURATION

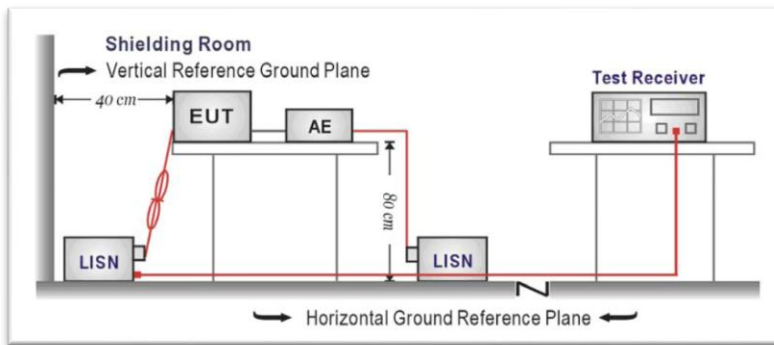

TEST PROCEDURE

1. The EUT was setup according to ANSI C63.10:2013 for compliance to FCC 47CFR 15.247 requirements.
2. The EUT was placed on a platform of nominal size, 1 m by 1.5 m, raised 80 cm above the conducting ground plane. The vertical conducting plane was located 40 cm to the rear of the EUT. All other surfaces of EUT were at least 80 cm from any other grounded conducting surface.
3. The EUT and simulators are connected to the main power through a line impedance stabilization network (LISN). The LISN provides a 50 ohm /50uH coupling impedance for the measuring equipment.
4. The peripheral devices are also connected to the main power through a LISN. (Please refer to the block diagram of the test setup and photographs)
5. Each current-carrying conductor of the EUT power cord, except the ground (safety) conductor, was individually connected through a LISN to the input power source.
6. The excess length of the power cord between the EUT and the LISN receptacle were folded back and forth at the center of the lead to form a bundle not exceeding 40 cm in length.
7. Conducted emissions were investigated over the frequency range from 0.15MHz to 30MHz using a receiver bandwidth of 9 kHz.
8. During the above scans, the emissions were maximized by cable manipulation.

TEST MODE:

Please refer to the clause 3.3

TEST RESULTS

Passed Not Applicable

Test Line:

L

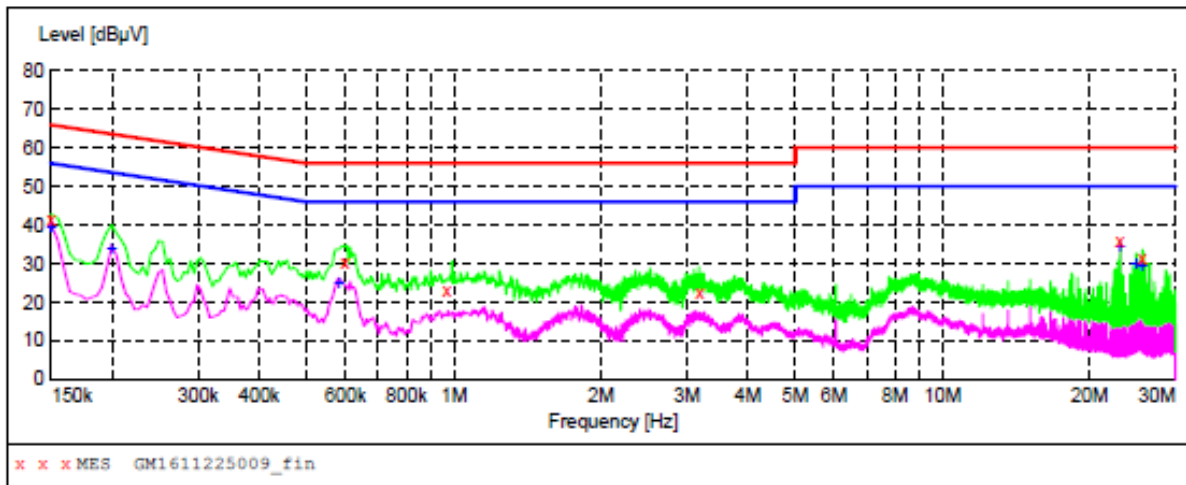

MEASUREMENT RESULT: "GM1611225009_fin"

11/22/2016 2:16PM

Frequency MHz	Level dBµV	Transd dB	Limit dBµV	Margin dB	Detector	Line	PE
0.150000	41.70	10.4	66	24.3	QP	L1	GND
0.600000	30.20	10.2	56	25.8	QP	L1	GND
0.969000	23.30	10.2	56	32.7	QP	L1	GND
3.187500	22.70	10.2	56	33.3	QP	L1	GND
23.127000	35.70	10.7	60	24.3	QP	L1	GND
25.692000	31.70	10.7	60	28.3	QP	L1	GND

MEASUREMENT RESULT: "GM1611225009_fin2"

11/22/2016 2:16PM

Frequency MHz	Level dBµV	Transd dB	Limit dBµV	Margin dB	Detector	Line	PE
0.150000	40.00	10.4	56	16.0	AV	L1	GND
0.199500	34.50	10.3	54	19.1	AV	L1	GND
0.582000	25.50	10.2	46	20.5	AV	L1	GND
23.127000	34.90	10.7	50	15.1	AV	L1	GND
24.958500	30.40	10.7	50	19.6	AV	L1	GND
25.692000	30.00	10.7	50	20.0	AV	L1	GND

Test Line:

N

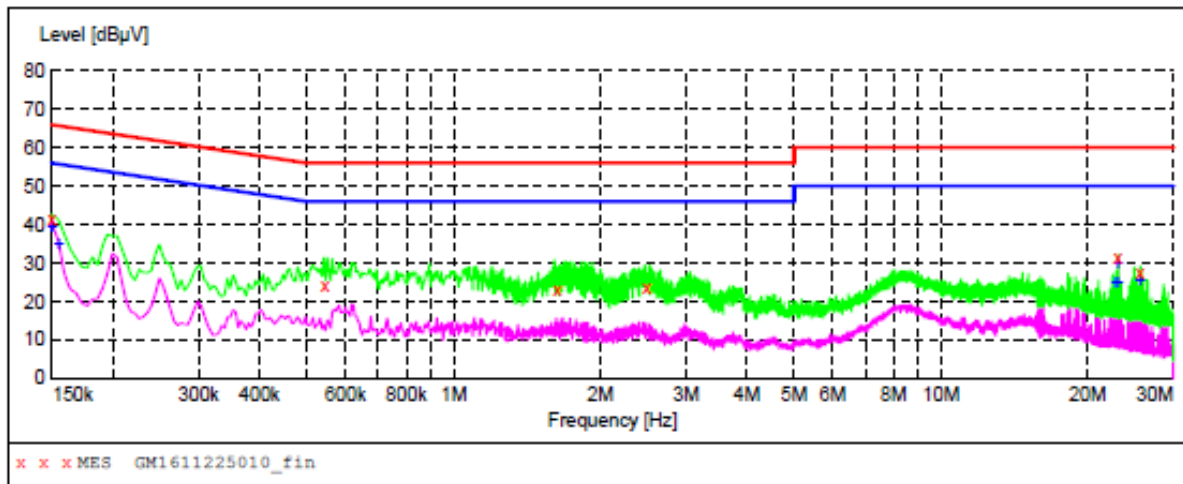

MEASUREMENT RESULT: "GM1611225010_fin"

11/22/2016 2:19PM

Frequency MHz	Level dBuV	Transd dB	Limit dBuV	Margin dB	Detector	Line	PE
0.150000	41.30	10.4	66	24.7	QP	N	GND
0.546000	24.30	10.2	56	31.7	QP	N	GND
1.635000	23.10	10.2	56	32.9	QP	N	GND
2.494500	23.40	10.2	56	32.6	QP	N	GND
23.127000	31.20	10.7	60	28.8	QP	N	GND
25.692000	27.60	10.7	60	32.4	QP	N	GND

MEASUREMENT RESULT: "GM1611225010_fin2"

11/22/2016 2:19PM

Frequency MHz	Level dBuV	Transd dB	Limit dBuV	Margin dB	Detector	Line	PE
0.150000	39.80	10.4	56	16.2	AV	N	GND
0.154500	35.30	10.4	56	20.5	AV	N	GND
22.884000	25.10	10.7	50	24.9	AV	N	GND
23.068500	25.40	10.7	50	24.6	AV	N	GND
23.127000	30.50	10.7	50	19.5	AV	N	GND
25.692000	25.60	10.7	50	24.4	AV	N	GND

5.3. Conducted Peak Output Power

LIMIT

FCC CFR Title 47 Part 15 Subpart C Section 15.247 (b)(3): **30dBm**:

TEST CONFIGURATION

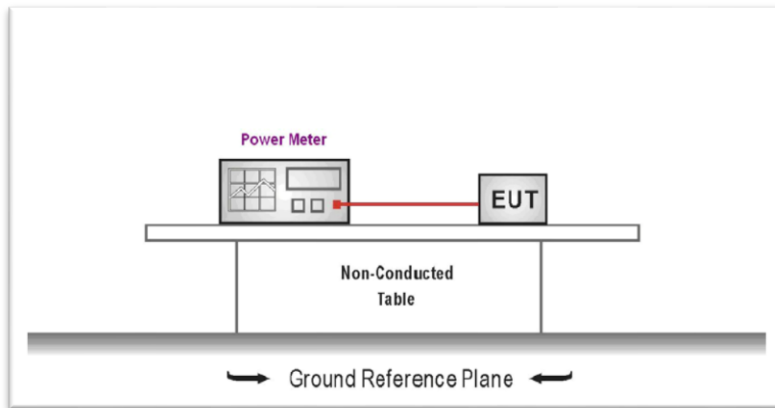

TEST PROCEDURE

1. The EUT was tested according to ANSI C63.10: 2013 and KDB 558074 D01 for compliance to FCC 47CFR 15.247 requirements.
2. The maximum peak conducted output power may be measured using a broadband peak RF power meter.
3. The power meter shall have a video bandwidth that is greater than or equal to the DTS bandwidth and shall utilize a fast-responding diode detector
4. Record the measurement data.

TEST MODE:

Please refer to the clause 3.3

TEST RESULTS

Passed **Not Applicable**

Type	Channel	Output power (dBm)	Limit (dBm)	Result
802.11b	01	9.04	30.00	Pass
	06	9.34		
	11	9.66		
802.11g	01	9.02	30.00	Pass
	06	9.06		
	11	9.10		
802.11n(H20)	01	8.87	30.00	Pass
	06	8.98		
	11	8.88		

5.4. Power Spectral Density

LIMIT

FCC CFR Title 47 Part 15 Subpart C Section 15.247 (e):

For digitally modulated systems, the power spectral density conducted from the intentional radiator to the antenna shall not be greater than 8 dBm in any 3 kHz band during any time interval of continuous transmission.

TEST CONFIGURATION

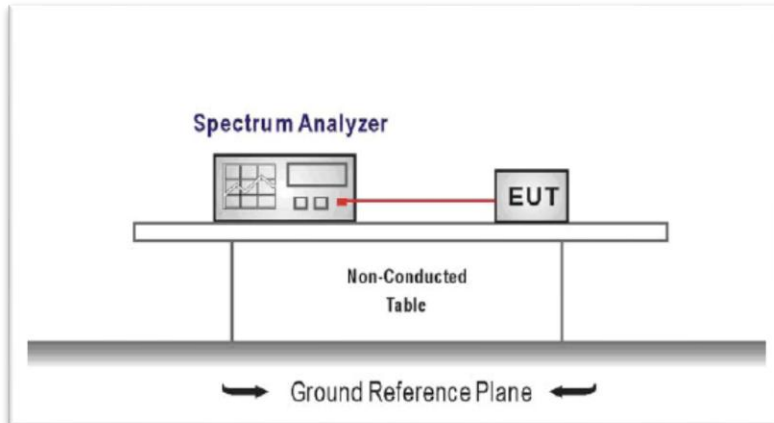

TEST PROCEDURE

1. Connect the antenna port(s) to the spectrum analyzer input,
2. Configure the spectrum analyzer as shown below:
Center frequency = DTS channel center frequency
Span = 1.5 times the DTS bandwidth
RBW = 3 kHz ≤ RBW ≤ 100 kHz, VBW ≥ 3 × RBW
Sweep time = auto couple
Detector = peak
Trace mode = max hold
3. Place the radio in continuous transmit mode, allow the trace to stabilize, view the transmitter waveform on the spectrum analyzer.
4. Use the peak marker function to determine the maximum amplitude level within the RBW.
5. If measured value exceeds limit, reduce RBW (no less than 3 kHz) and repeat.

TEST MODE:

Please refer to the clause 3.3

TEST RESULTS

Passed Not Applicable

Type	Channel	Power Spectral Density (dBm/3KHz)	Limit (dBm/3KHz)	Result
802.11b	01	-15.81	8.00	Pass
	06	-13.35		
	11	-12.68		
802.11g	01	-19.64	8.00	Pass
	06	-19.72		
	11	-20.21		
802.11n(H20)	01	-21.93	8.00	Pass
	06	-19.61		
	11	-19.45		

Test plot as follows:

802.11b

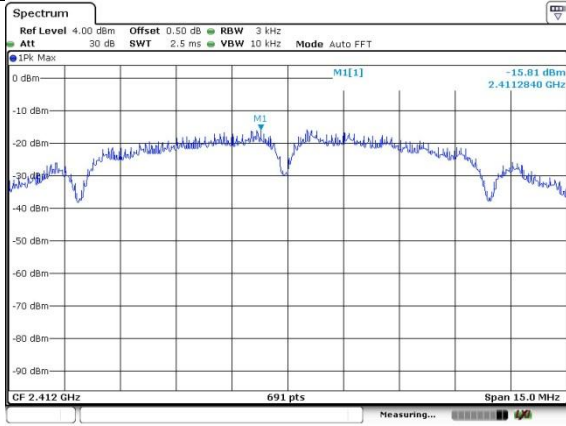

CH01

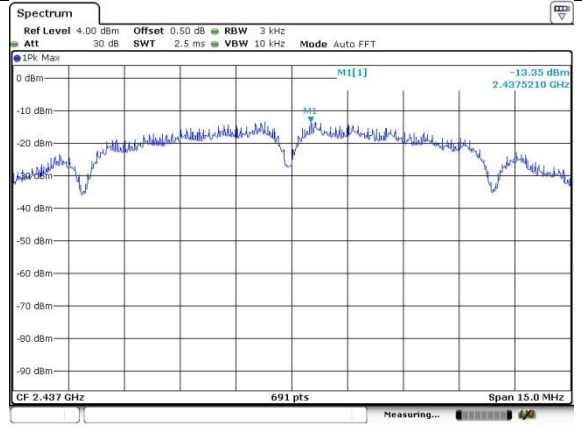

CH06

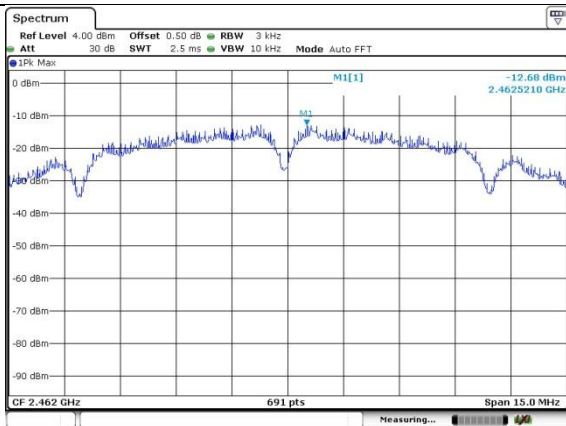

CH11

No Plot

802.11g

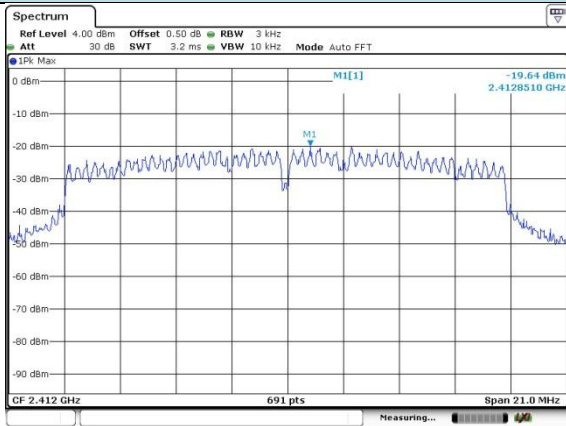

CH01

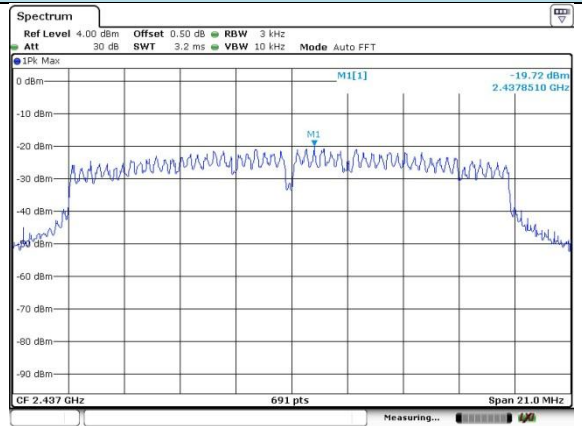

CH06

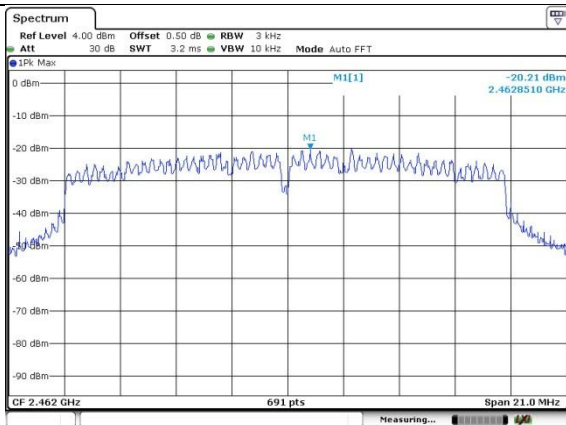

CH11

No Plot

802.11n(H20)

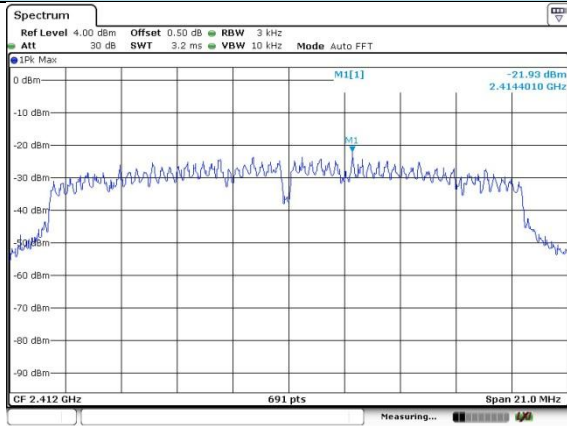

CH01

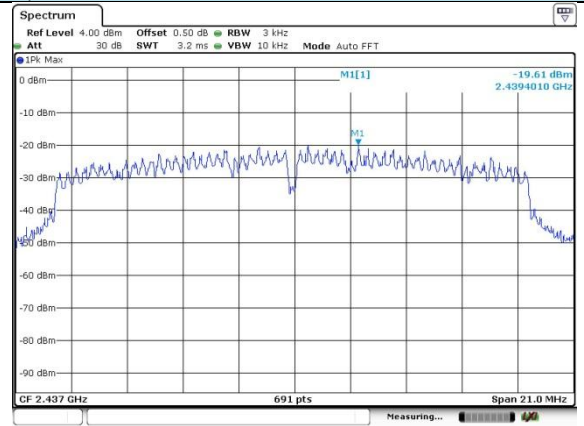

CH06

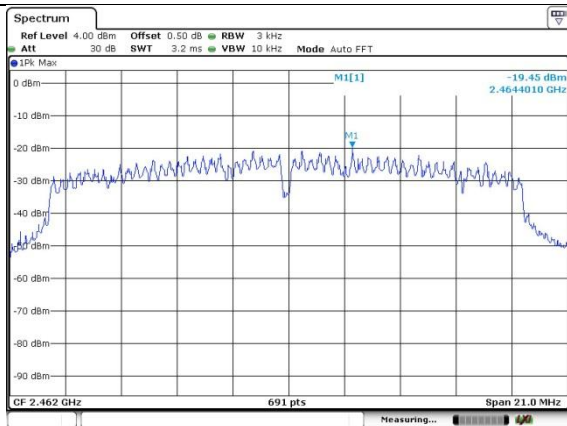

CH11

No Plot

-

5.5. 6dB bandwidthand

LIMIT

FCC CFR Title 47 Part 15 Subpart C Section 15.247 (a)(2):

For digital modulation systems, the minimum 6 dB bandwidth shall be at least 500 kHz.

TEST CONFIGURATION

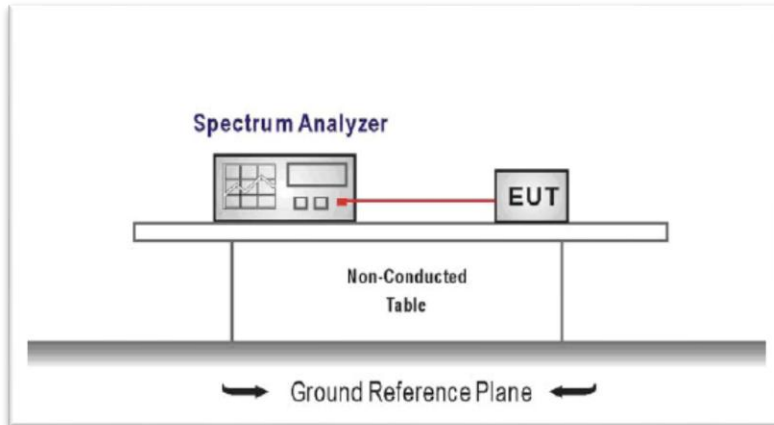

TEST PROCEDURE

1. Connect the antenna port(s) to the spectrum analyzer input.
2. Configure the spectrum analyzer as shown below (enter all losses between the transmitter output and the spectrum analyzer).
 Center Frequency = DTS channel center frequency
 Span = 2 x DTS bandwidth
 RBW = 100 kHz, VBW ≥ 3 × RBW
 Sweep time = auto couple
 Detector = Peak
 Trace mode = max hold
3. Place the radio in continuous transmit mode, allow the trace to stabilize, view the transmitter waveform on the spectrum analyzer.
4. Measure the maximum width of the emission that is constrained by the frequencies associated with the two outermost amplitude points (upper and lower frequencies) that are attenuated by 6 dB relative to the maximum level measured in the fundamental emission, and record the pertinent measurements.

TEST MODE:

Please refer to the clause 3.3

TEST RESULTS

Passed **Not Applicable**

Type	Channel	6dB Bandwidth (MHz)	Limit (KHz)	Result
802.11b	01	9.09	≥ 500	Pass
	06	9.09		
	11	9.54		
802.11g	01	13.89	≥ 500	Pass
	06	13.89		
	11	13.89		
802.11n(H20)	01	14.07	≥ 500	Pass
	06	14.07		
	11	13.89		

Test plot as follows:

802.11b

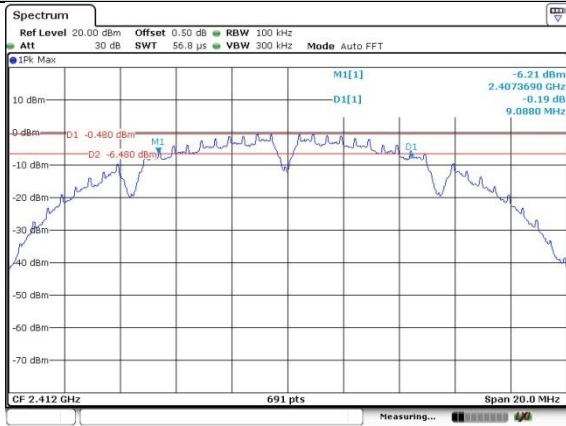

CH01



CH06

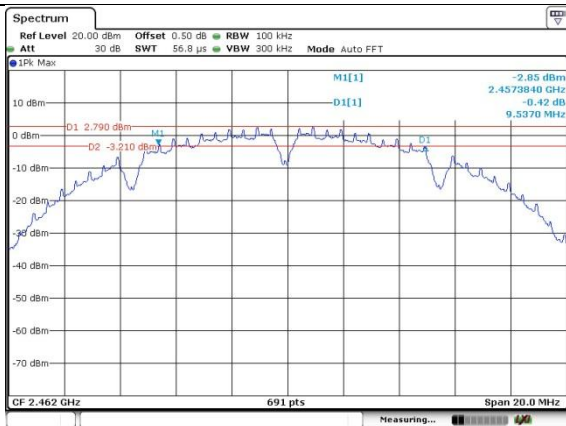

CH11

No Plot

802.11g

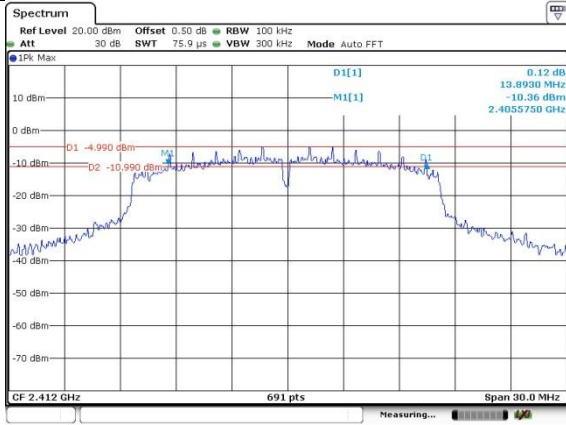

CH01

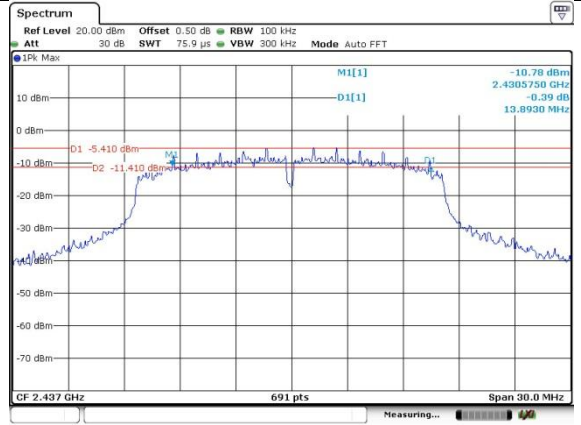

CH06

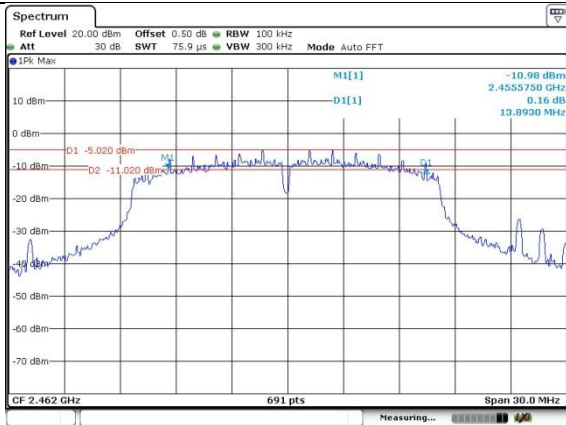

CH11

No Plot

802.11n(H20)

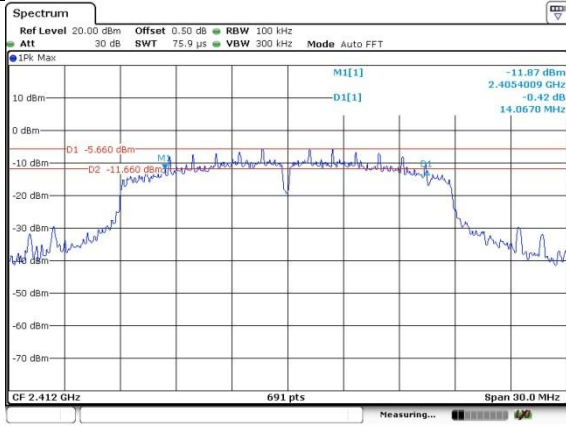

CH01

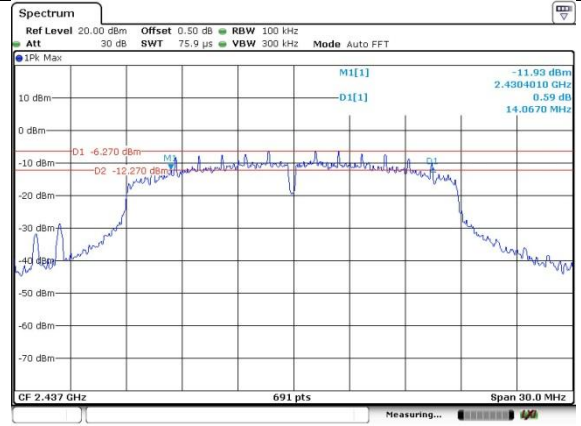

CH06

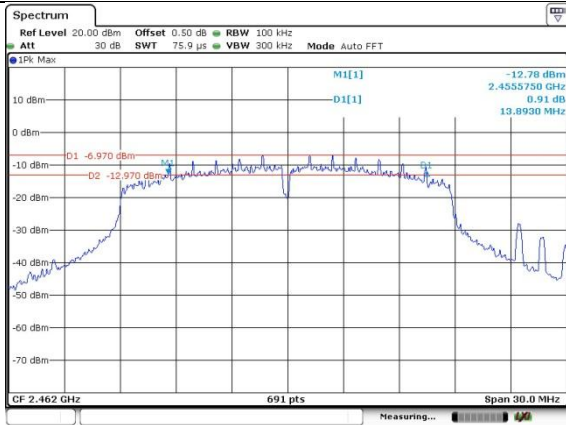

CH11

No Plot

-

5.6. Restricted band

LIMIT

FCC CFR Title 47 Part 15 Subpart C Section 15.247 (d):

In any 100 kHz bandwidth outside the frequency band in which the spread spectrum or digitally modulated intentional radiator is operating, radiated emissions which fall in the restricted bands, as defined in §15.205(a), must also comply with the radiated emission limits specified in §15.209(a) (see §15.205(c)).

TEST CONFIGURATION

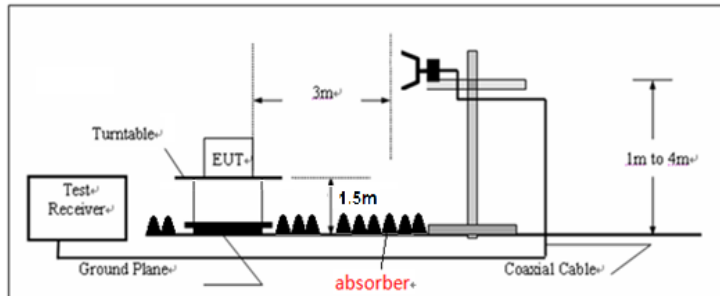

TEST PROCEDURE

- 1) The EUT was setup and tested according to ANSI C63.10:2013 for compliance to FCC 47CFR 15.247 requirements.
- 2) The EUT is placed on a turn table which is 1.5 meter above ground. The turn table is rotated 360 degrees to determine the position of the maximum emission level.
- 3) The EUT was positioned such that the distance from antenna to the EUT was 3 meters.
- 4) The antenna is scanned from 1 meter to 4 meters to find out the maximum emission level. This is repeated for both horizontal and vertical polarization of the antenna. In order to find the maximum emission, all of the interface cables were manipulated according to ANSI C63.10:2013 on radiated measurement.
- 5) The receiver set as follow:
 RBW=1MHz, VBW=3MHz Peak detector for Peak value
 RBW=1MHz, VBW=3MHz RMS detector for Average value.

TEST MODE:

Please refer to the clause 3.3

TEST RESULTS

Passed **Not Applicable**

Note:

- 1) $Final\ level = Read\ level + Antenna\ Factor + Cable\ Loss - Preamp\ Factor$

802.11b					CH01				
Frequency (MHz)	Read Level (dBuV)	Antenna Factor (dB/m)	Cable Loss (dB)	Preamp Factor (dB)	Level (dBuV/m)	Limit Line (dBuV/m)	Margin Limit (dB)	Polarization	Test value
2310.00	17.78	27.27	6.62	0.00	51.67	74.00	-22.33	Horizontal	Peak
2389.99	18.51	27.53	6.75	0.00	52.79	74.00	-21.21	Horizontal	Peak
2399.97	18.06	27.57	6.77	0.00	52.40	74.00	-21.60	Horizontal	Peak
2310.00	17.58	27.27	6.62	0.00	51.47	74.00	-22.53	Vertical	Peak
2389.99	16.53	27.53	6.75	0.00	50.81	74.00	-23.19	Vertical	Peak
2399.97	18.31	27.57	6.77	0.00	52.65	74.00	-21.75	Vertical	Peak
2310.00	11.21	27.27	6.62	0.00	45.10	54.00	-8.90	Horizontal	Average
2389.99	11.05	27.53	6.75	0.00	45.33	54.00	-8.67	Horizontal	Average
2399.97	12.66	27.57	6.77	0.00	47.00	54.00	-7.00	Horizontal	Average
2310.00	11.05	27.27	6.62	0.00	44.94	54.00	-9.06	Vertical	Average
2389.99	10.66	27.53	6.75	0.00	44.94	54.00	-9.06	Vertical	Average
2399.97	12.17	27.57	6.77	0.00	46.51	54.00	-7.49	Vertical	Average

802.11b					CH11				
Frequency (MHz)	Read Level (dBuV)	Antenna Factor (dB/m)	Cable Loss (dB)	Preamp Factor (dB)	Level (dBuV/m)	Limit Line (dBuV/m)	Margin Limit (dB)	Polarization	Test value
2483.49	17.26	27.85	6.83	0.00	51.94	74.00	-22.06	Horizontal	Peak
2500.00	17.43	27.90	6.84	0.00	52.17	74.00	-21.83	Horizontal	Peak
2483.49	16.36	27.85	6.83	0.00	51.04	74.00	-22.96	Vertical	Peak
2500.00	17.48	27.90	6.84	0.00	52.22	74.00	-21.78	Vertical	Peak
2483.49	10.61	27.85	6.83	0.00	45.29	54.00	-8.71	Horizontal	Average
2500.00	10.56	27.90	6.84	0.00	45.30	54.00	-8.70	Horizontal	Average
2483.49	11.11	27.85	6.83	0.00	45.79	54.00	-8.21	Vertical	Average
2500.00	10.68	27.90	6.84	0.00	45.42	54.00	-8.58	Vertical	Average

802.11g					CH01				
Frequency (MHz)	Read Level (dBuV)	Antenna Factor (dB/m)	Cable Loss (dB)	Preamp Factor (dB)	Level (dBuV/m)	Limit Line (dBuV/m)	Margin Limit (dB)	Polarization	Test value
2310.00	16.64	27.27	6.62	0.00	50.53	74.00	-23.47	Horizontal	Peak
2389.99	17.14	27.53	6.75	0.00	51.42	74.00	-22.58	Horizontal	Peak
2399.97	18.56	27.57	6.77	0.00	52.90	74.00	-21.10	Horizontal	Peak
2310.00	17.59	27.27	6.62	0.00	51.48	74.00	-22.52	Vertical	Peak
2389.99	18.62	27.53	6.75	0.00	52.90	74.00	-21.10	Vertical	Peak
2399.97	19.28	27.57	6.77	0.00	53.62	74.00	-20.38	Vertical	Peak
2310.00	11.04	27.27	6.62	0.00	44.93	54.00	-9.07	Horizontal	Average
2389.99	10.71	27.53	6.75	0.00	44.99	54.00	-9.01	Horizontal	Average
2399.97	11.83	27.57	6.77	0.00	46.17	54.00	-7.83	Horizontal	Average
2310.00	11.08	27.27	6.62	0.00	44.97	54.00	-9.03	Vertical	Average
2389.99	11.07	27.53	6.75	0.00	45.35	54.00	-8.65	Vertical	Average
2399.97	13.63	27.57	6.77	0.00	47.97	54.00	-6.03	Vertical	Average

802.11g					CH11				
Frequency (MHz)	Read Level (dBuV)	Antenna Factor (dB/m)	Cable Loss (dB)	Preamp Factor (dB)	Level (dBuV/m)	Limit Line (dBuV/m)	Margin Limit (dB)	Polarization	Test value
2483.49	24.65	27.85	6.83	0.00	59.33	74.00	-14.67	Horizontal	Peak
2500.00	18.08	27.90	6.84	0.00	52.82	74.00	-21.18	Horizontal	Peak
2483.49	18.60	27.85	6.83	0.00	53.28	74.00	-20.72	Vertical	Peak
2500.00	18.40	27.90	6.84	0.00	53.14	74.00	-20.86	Vertical	Peak
2483.49	13.33	27.85	6.83	0.00	48.01	54.00	-5.99	Horizontal	Average
2500.00	10.55	27.90	6.84	0.00	45.29	54.00	-8.71	Horizontal	Average
2483.49	11.68	27.85	6.83	0.00	46.36	54.00	-7.64	Vertical	Average
2500.00	10.54	27.90	6.84	0.00	45.28	54.00	-8.72	Vertical	Average

802.11n					CH01				
Frequency (MHz)	Read Level (dBuV)	Antenna Factor (dB/m)	Cable Loss (dB)	Preamp Factor (dB)	Level (dBuV/m)	Limit Line (dBuV/m)	Margin Limit (dB)	Polarization	Test value
2310.00	16.64	27.27	6.62	0.00	50.53	74.00	-23.47	Horizontal	Peak
2389.99	17.14	27.53	6.75	0.00	51.42	74.00	-22.58	Horizontal	Peak
2399.97	18.56	27.57	6.77	0.00	52.90	74.00	-21.10	Horizontal	Peak
2310.00	17.49	27.27	6.62	0.00	51.38	74.00	-22.62	Vertical	Peak
2389.99	18.83	27.53	6.75	0.00	53.11	74.00	-20.89	Vertical	Peak
2399.97	19.11	27.57	6.77	0.00	53.45	74.00	-20.55	Vertical	Peak
2310.00	11.08	27.27	6.62	0.00	44.97	54.00	-9.03	Horizontal	Average
2389.99	10.64	27.53	6.75	0.00	44.92	54.00	-9.08	Horizontal	Average
2399.97	10.96	27.57	6.77	0.00	45.30	54.00	-8.70	Horizontal	Average
2310.00	11.07	27.27	6.62	0.00	44.96	54.00	-9.04	Vertical	Average
2389.99	10.70	27.53	6.75	0.00	44.98	54.00	-9.02	Vertical	Average
2399.97	11.54	27.57	6.77	0.00	45.88	54.00	-8.12	Vertical	Average

802.11n					CH11				
Frequency (MHz)	Read Level (dBuV)	Antenna Factor (dB/m)	Cable Loss (dB)	Preamp Factor (dB)	Level (dBuV/m)	Limit Line (dBuV/m)	Margin Limit (dB)	Polarization	Test value
2483.48	21.68	27.85	6.83	0.00	56.36	74.00	-17.64	Horizontal	Peak
2500.00	13.88	27.90	6.84	0.00	48.62	74.00	-25.38	Horizontal	Peak
2483.48	14.48	27.85	6.83	0.00	49.16	74.00	-24.84	Vertical	Peak
2500.00	13.57	27.90	6.84	0.00	48.31	74.00	-25.69	Vertical	Peak
2483.48	12.79	27.85	6.83	0.00	47.47	54.00	-6.53	Horizontal	Average
2500.00	10.45	27.90	6.84	0.00	45.19	54.00	-8.81	Horizontal	Average
2483.48	11.03	27.85	6.83	0.00	45.71	54.00	-8.29	Vertical	Average
2500.00	10.43	27.90	6.84	0.00	45.17	54.00	-8.83	Vertical	Average

5.7. Band edge and Spurious Emission (conducted)

LIMIT

FCC CFR Title 47 Part 15 Subpart C Section 15.247 (d):

In any 100 kHz bandwidth outside the frequency band in which the spread spectrum intentional radiator is operating, the radio frequency power that is produced by the intentional radiator shall be at least 20 dB below that in the 100 kHz bandwidth within the band that contains the highest level of the desired power, based on either an RF conducted or a radiated measurement.

TEST CONFIGURATION

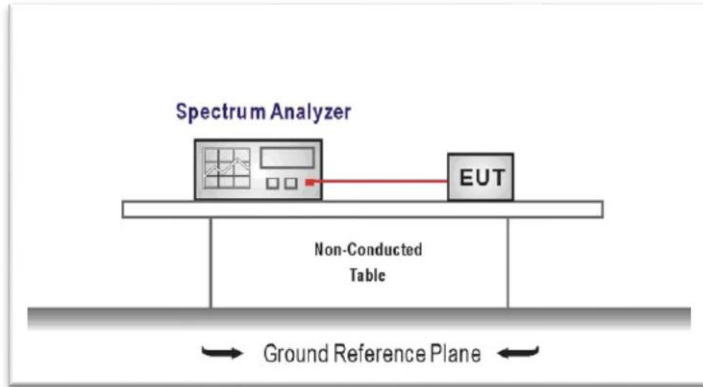

TEST PROCEDURE

1. Connect the antenna port(s) to the spectrum analyzer input.
2. Establish a reference level by using the following procedure
Center frequency = DTS channel center frequency
The span = 1.5 times the DTS bandwidth.
RBW = 100 kHz, VBW ≥ 3 x RBW
Detector = peak, Sweep time = auto couple, Trace mode = max hold
Allow trace to fully stabilize
Use the peak marker function to determine the maximum PSD level

Note: the channel found to contain the maximum PSD level can be used to establish the reference level.

3. Emission level measurement
Set the center frequency and span to encompass frequency range to be measured
RBW = 100 kHz, VBW ≥ 3 x RBW
Detector = peak, Sweep time = auto couple, Trace mode = max hold
Allow trace to fully stabilize
Use the peak marker function to determine the maximum amplitude level.
4. Place the radio in continuous transmit mode, allow the trace to stabilize, view the transmitter waveform on the spectrum analyzer.
5. Ensure that the amplitude of all unwanted emissions outside of the authorized frequency band excluding restricted frequency bands) are attenuated by at least the minimum requirements specified (at least 20 dB relative to the maximum in-band peak PSD level in 100 kHz). Report the three highest emissions relative to the limit.

TEST MODE:

Please refer to the clause 3.3

TEST RESULTS

Passed Not Applicable

802.11b

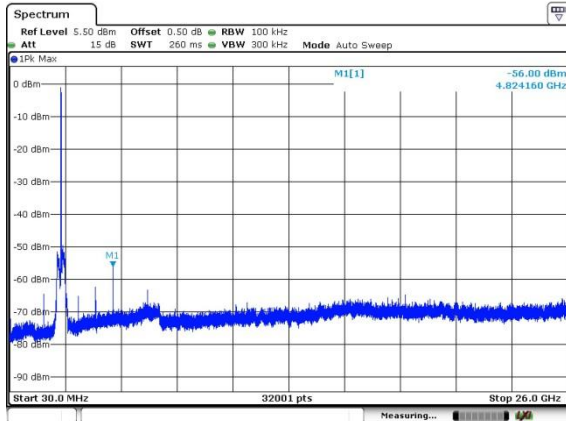

CH01-SE

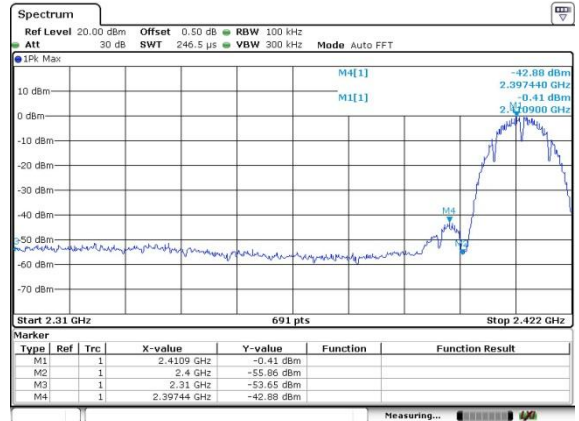

CH01-Bandedge

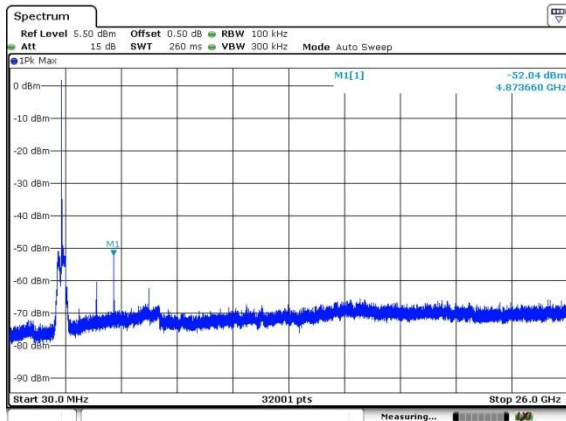

CH06-SE

No Plot

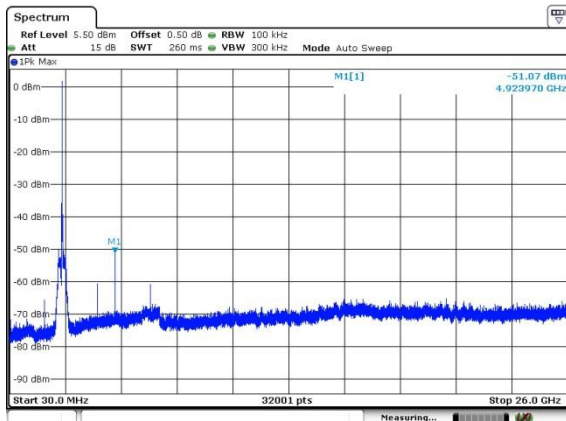

CH11-SE

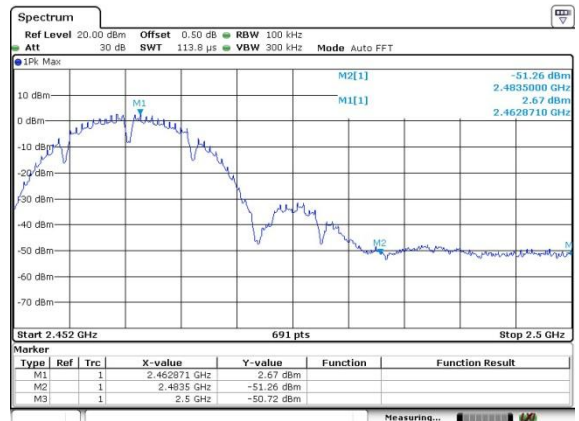

CH11-Bandedge

802.11g

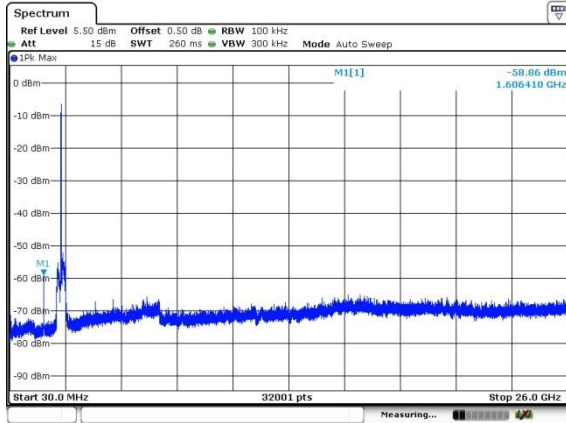

CH01-SE

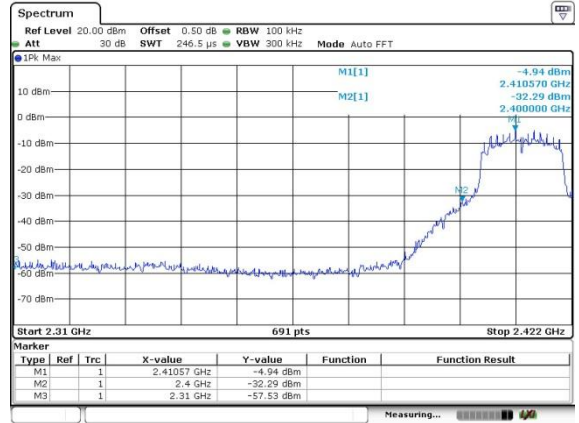

CH01-Bandedge

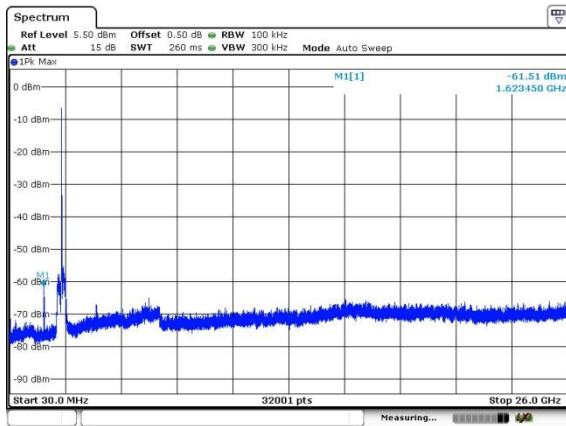

CH06

No Plot

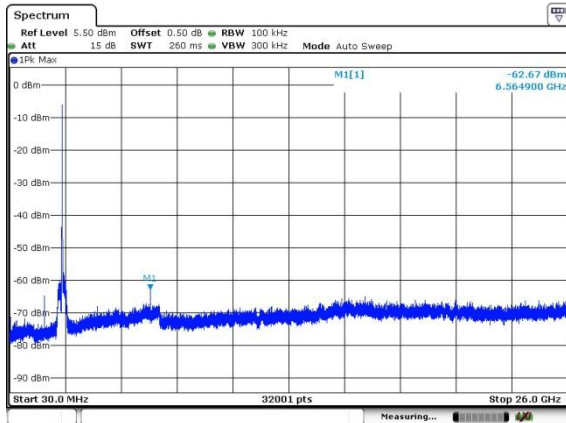

CH11-SE

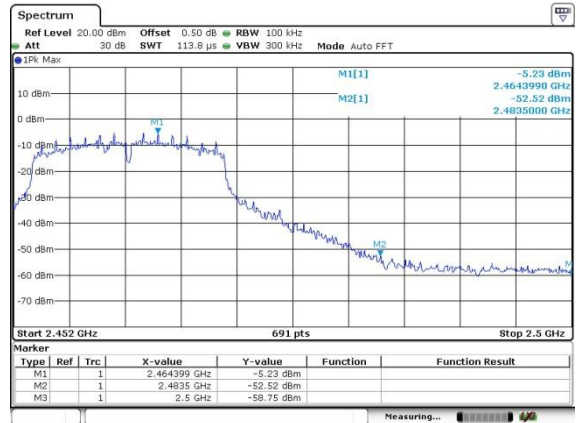

CH11-Bandedge

802.11n (H20)

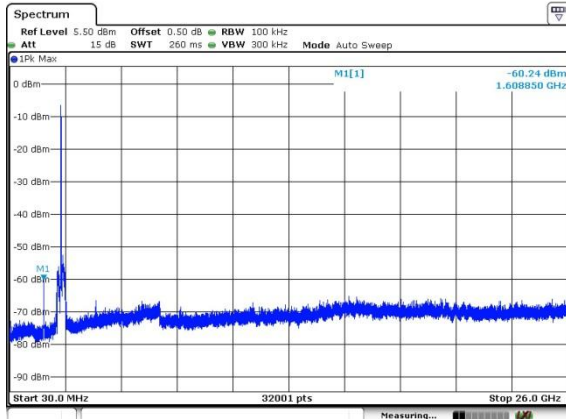

CH01-SE

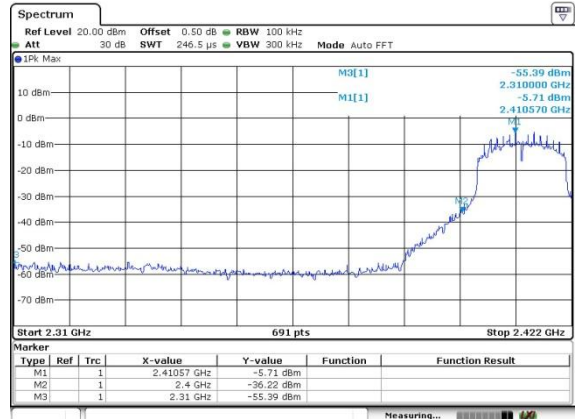

CH01-Bandedge

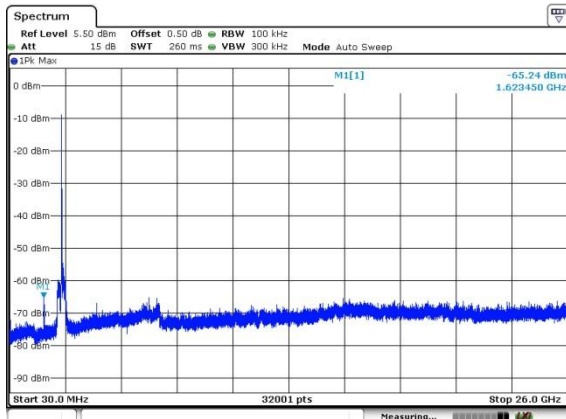

CH06

No Plot

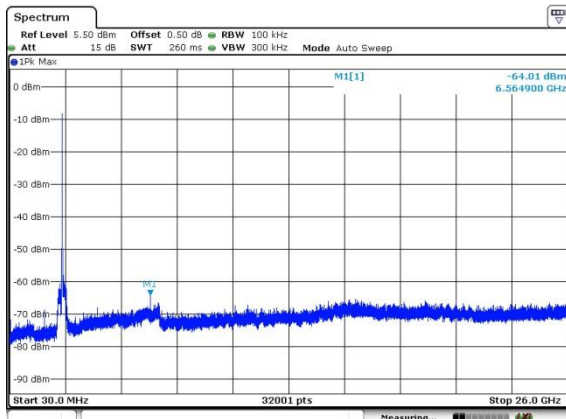

CH11-SE

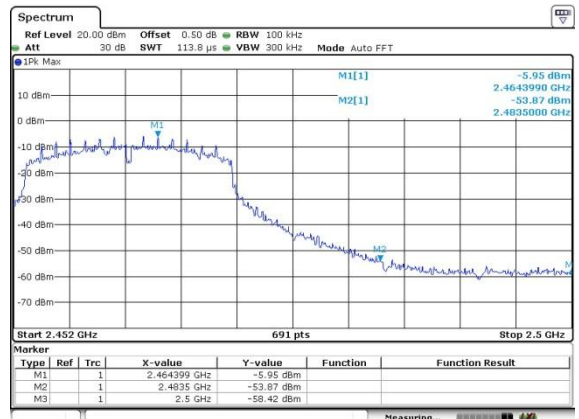

CH11-Bandedge

5.8. Spurious Emission (radiated)

LIMIT

FCC CFR Title 47 Part 15 Subpart C Section 15.209

Frequency	Limit (dBuV/m @3m)	Value
30MHz-88MHz	40.00	Quasi-peak
88MHz-216MHz	43.50	Quasi-peak
216MHz-960MHz	46.00	Quasi-peak
960MHz-1GHz	54.00	Quasi-peak
Above 1GHz	54.00	Average
	74.00	Peak

TEST CONFIGURATION

➤ 9KHz ~30MHz

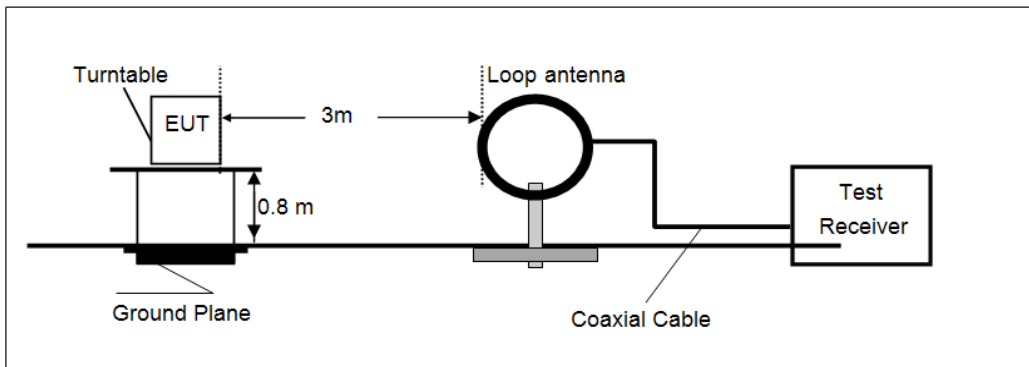

➤ 30MHz ~ 1GHz

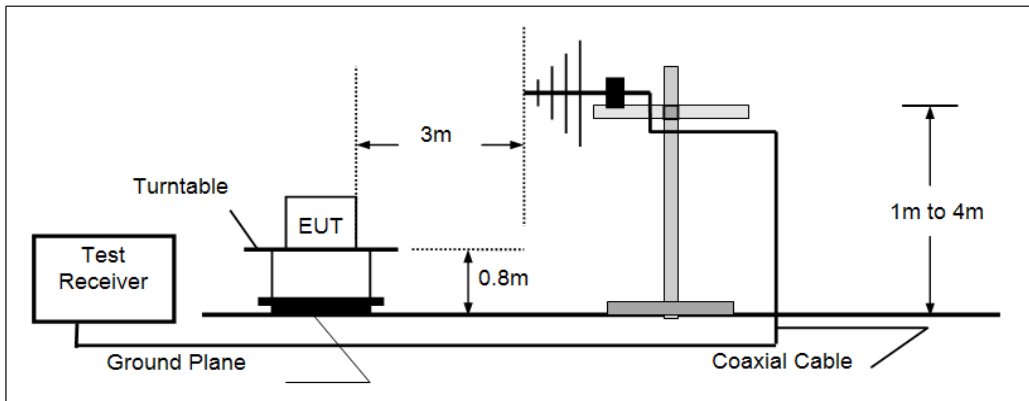

➤ Above 1GHz

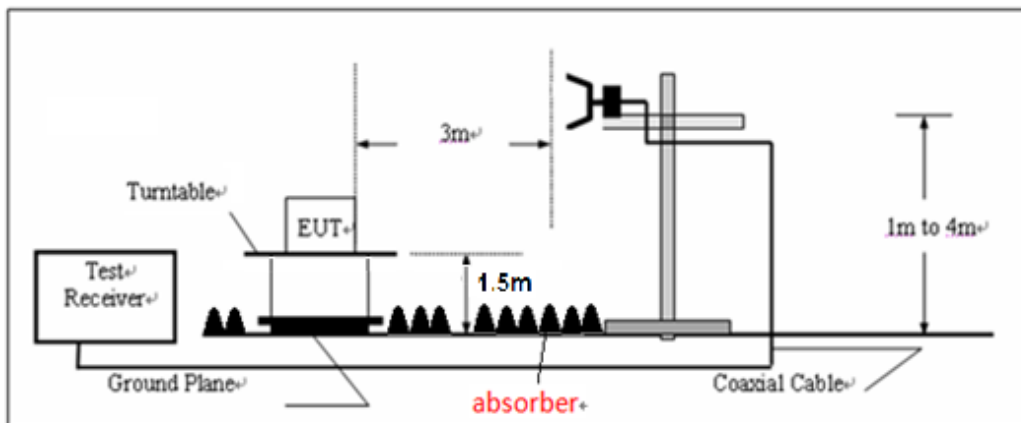

TEST PROCEDURE

1. The EUT was tested according to ANSI C63.10:2013 for compliance to FCC 47CFR 15.247 requirements.
2. The EUT is placed on a turn table which is 0.8 meter above ground. The turn table is rotated 360 degrees to determine the position of the maximum emission level.
3. The EUT was positioned such that the distance from antenna to the EUT was 3 meters.
4. The antenna is scanned from 1 meter to 4 meters to find out the maximum emission level. This is repeated for both horizontal and vertical polarization of the antenna.
5. Use the following spectrum analyzer settings
 - (1) Span shall be wide enough to fully capture the emission being measured;
 - (2) Below 1GHz, RBW=120KHz, VBW=300KHz, Sweep=auto, Detector function=QP, Trace=max hold;
If the emission level of the EUT measured by the peak detector is 3 dB lower than the applicable limit, the peak emission level will be reported. Otherwise, the emission measurement will be repeated using the quasi-peak detector and reported.
 - (3) Above 1GHz, RBW=1MHz, VBW=3MHz Peak detector for Peak value
RBW=1MHz, VBW=3MHz RMS detector for Average value.

TEST MODE:

Please refer to the clause 3.3

TEST RESULTS

Passed **Not Applicable**

Note:

- 1) *Final Level = Receiver Read level + Antenna Factor + Cable Loss – Preamplifier Factor*
- 2) *“**”, means this data is too weak instrument of signal is unable to test.*
- 3) *The emission levels of other frequencies are very lower than the limit and not show in test report.*

➤ **9kHz ~ 30MHz**

The EUT was pre-scanned the frequency band (9KHz~30MHz), found the radiated level lower than the limit, so don't show on the report.

➤ 30MHz ~ 1GHz

Polarization:

Vertical

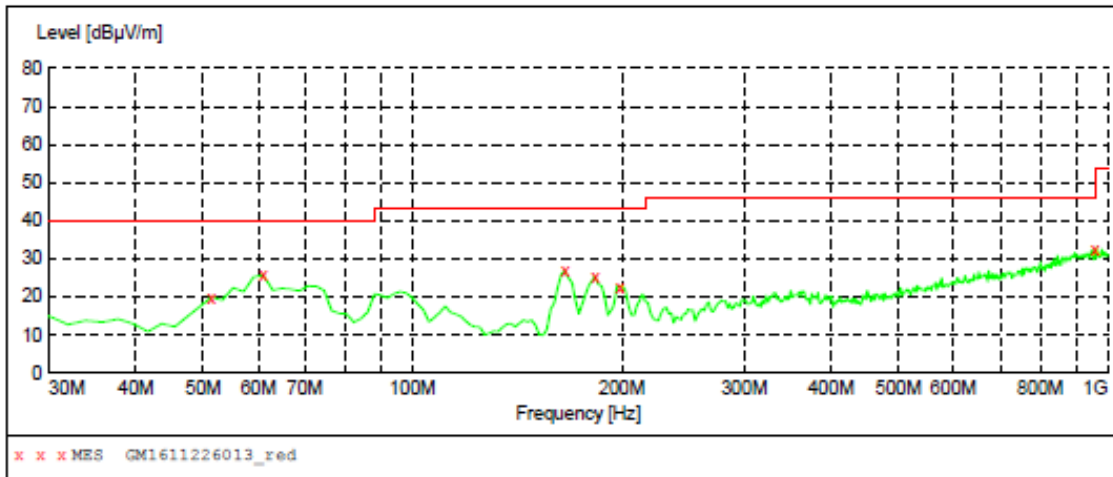

MEASUREMENT RESULT: "GM1611226013_red"

11/22/2016 10:13AM

Frequency MHz	Level dBµV/m	Transd dB	Limit dBµV/m	Margin dB	Det.	Height cm	Azimuth deg	Polarization
51.340000	19.90	-16.3	40.0	20.1	QP	100.0	360.00	VERTICAL
61.040000	25.70	-17.4	40.0	14.3	QP	100.0	29.00	VERTICAL
165.800000	26.80	-19.2	43.5	16.7	QP	100.0	138.00	VERTICAL
183.260000	25.40	-18.1	43.5	18.1	QP	100.0	121.00	VERTICAL
198.780000	22.70	-16.1	43.5	20.8	QP	100.0	121.00	VERTICAL
957.320000	32.30	1.6	46.0	13.7	QP	100.0	0.00	VERTICAL

Polarization:

Horizontal

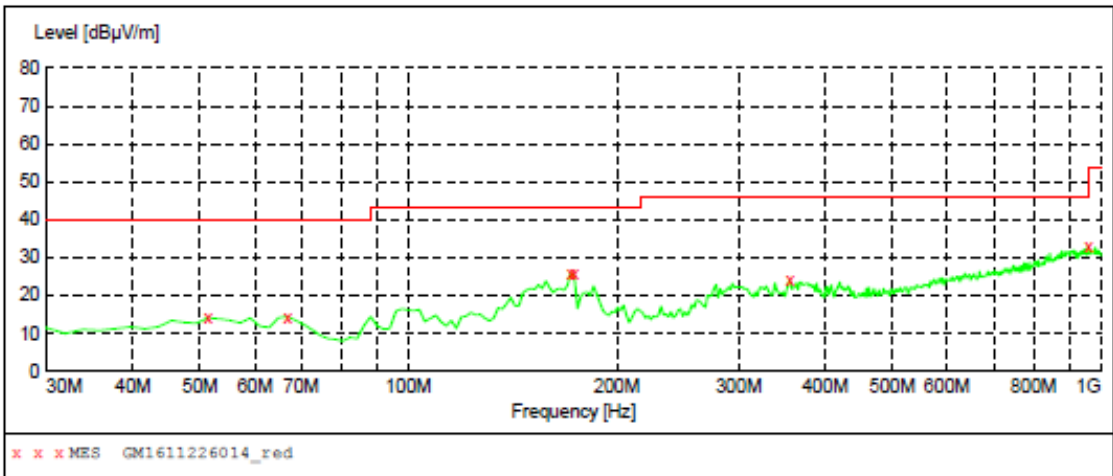

MEASUREMENT RESULT: "GM1611226014_red"

11/22/2016 10:17AM

Frequency MHz	Level dBµV/m	Transd dB	Limit dBµV/m	Margin dB	Det.	Height cm	Azimuth deg	Polarization
51.340000	14.10	-16.3	40.0	25.9	QP	300.0	111.00	HORIZONTAL
66.860000	14.40	-18.4	40.0	25.6	QP	100.0	86.00	HORIZONTAL
171.620000	25.70	-18.9	43.5	17.8	QP	100.0	195.00	HORIZONTAL
173.560000	25.50	-18.8	43.5	18.0	QP	100.0	209.00	HORIZONTAL
355.920000	23.90	-11.6	46.0	22.1	QP	100.0	136.00	HORIZONTAL
959.260000	32.80	1.6	46.0	13.2	QP	300.0	157.00	HORIZONTAL

➤ Above 1GHz

802.11b					CH01				
Frequency (MHz)	Read Level (dBuV)	Antenna Factor (dB/m)	Cable Loss (dB)	Preamp Factor (dB)	Level (dBuV/m)	Limit Line (dBuV/m)	Margin Limit (dB)	Polarization	Test value
1220.71	38.72	24.45	4.70	36.56	31.31	74.00	-42.69	Vertical	Peak
1751.96	39.37	25.46	5.87	37.04	33.66	74.00	-40.34	Vertical	Peak
3214.62	43.96	28.59	7.74	38.23	42.06	74.00	-31.94	Vertical	Peak
4015.93	43.59	29.53	8.79	38.07	43.84	54.00	-10.16	Vertical	Average
4015.93	50.03	29.53	8.79	38.07	50.28	74.00	-23.72	Vertical	Peak
4818.02	41.08	31.09	9.55	36.91	44.81	74.00	-29.19	Vertical	Peak
6432.73	35.61	34.83	11.05	35.32	46.17	54.00	-7.83	Vertical	Average
6432.73	42.22	34.83	11.05	35.32	52.78	74.00	-21.22	Vertical	Peak
1220.71	38.72	24.45	4.70	36.56	31.31	74.00	-42.69	Horizontal	Peak
1751.96	39.37	25.46	5.87	37.04	33.66	74.00	-40.34	Horizontal	Peak
3214.62	43.96	28.59	7.74	38.23	42.06	74.00	-31.94	Horizontal	Peak
4015.93	43.59	29.53	8.79	38.07	43.84	54.00	-10.16	Horizontal	Average
4015.93	50.03	29.53	8.79	38.07	50.28	74.00	-23.72	Horizontal	Peak
4818.02	41.08	31.09	9.55	36.91	44.81	74.00	-29.19	Horizontal	Peak
6432.73	35.61	34.83	11.05	35.32	46.17	54.00	-7.83	Horizontal	Average
6432.73	42.22	34.83	11.05	35.32	52.78	74.00	-21.22	Horizontal	Peak

802.11b					CH06				
Frequency (MHz)	Read Level (dBuV)	Antenna Factor (dB/m)	Cable Loss (dB)	Preamp Factor (dB)	Level (dBuV/m)	Limit Line (dBuV/m)	Margin Limit (dB)	Polarization	Test value
1277.16	38.96	24.50	4.79	36.53	31.72	74.00	-42.28	Vertical	Peak
1767.81	38.79	25.50	5.90	37.07	33.12	74.00	-40.88	Vertical	Peak
2997.07	40.51	28.50	7.48	38.23	38.26	74.00	-35.74	Vertical	Peak
4069.13	48.00	29.71	8.84	37.95	48.60	74.00	-25.40	Vertical	Peak
5705.39	38.25	32.72	10.44	35.58	45.83	74.00	-28.17	Vertical	Peak
6510.30	36.69	35.10	11.19	35.34	47.64	74.00	-26.36	Vertical	Peak
1132.34	38.23	24.35	4.51	36.60	30.49	74.00	-43.51	Horizontal	Peak
1757.03	38.24	25.47	5.88	37.05	32.54	74.00	-41.46	Horizontal	Peak
2999.19	40.51	28.50	7.48	38.23	38.26	74.00	-35.74	Horizontal	Peak
4074.39	42.87	29.71	8.84	37.94	43.48	54.00	-10.52	Horizontal	Average
4074.39	52.99	29.71	8.84	37.94	53.60	74.00	-20.40	Horizontal	Peak
5697.37	38.28	32.72	10.43	35.60	45.83	74.00	-28.17	Horizontal	Peak
6507.54	35.84	35.10	11.19	35.34	46.79	74.00	-27.21	Horizontal	Peak

802.11b					CH11				
Frequency (MHz)	Read Level (dBuV)	Antenna Factor (dB/m)	Cable Loss (dB)	Preamp Factor (dB)	Level (dBuV/m)	Limit Line (dBuV/m)	Margin Limit (dB)	Polarization	Test value
1286.61	36.88	24.51	4.73	36.61	29.51	74.00	-44.49	Vertical	Peak
1795.84	36.13	25.58	5.79	37.10	30.40	74.00	-43.60	Vertical	Peak
4524.47	34.07	30.92	9.00	38.35	35.64	74.00	-38.36	Vertical	Peak
6235.37	32.89	34.08	10.04	37.94	39.07	74.00	-34.93	Vertical	Peak
7413.73	42.99	36.13	10.93	38.14	51.91	74.00	-22.09	Vertical	Peak
12210.02	30.93	39.14	13.80	37.74	46.13	74.00	-27.87	Vertical	Peak
1702.36	36.28	25.32	5.61	37.02	30.19	74.00	-43.81	Horizontal	Peak
3607.26	35.72	28.89	8.75	37.99	35.37	74.00	-38.63	Horizontal	Peak
5703.86	31.90	32.72	9.68	38.11	36.19	74.00	-37.81	Horizontal	Peak
7413.73	43.03	36.13	10.93	38.14	51.95	74.00	-22.05	Horizontal	Peak
10778.21	31.49	38.98	13.09	38.14	45.42	74.00	-28.58	Horizontal	Peak
11603.96	30.73	39.10	13.55	37.82	45.56	74.00	-28.44	Horizontal	Peak

Remark:

1. Final Level = Receiver Read level + Antenna Factor + Cable Loss – Pre-amplifier Factor
2. The peak level is lower than average limit (54 dBuV/m), this data is too weak instrument of signal is unable to test.
3. The emission levels of other frequencies are very lower than the limit and not show in test report.

802.11g					CH01				
Frequency (MHz)	Read Level (dBuV)	Antenna Factor (dB/m)	Cable Loss (dB)	Preamp Factor (dB)	Level (dBuV/m)	Limit Line (dBuV/m)	Margin Limit (dB)	Polarization	Test value
1068.74	38.82	24.28	4.36	36.64	30.82	74.00	-43.18	Vertical	Peak
1560.67	37.18	24.90	5.46	36.67	30.87	74.00	-43.13	Vertical	Peak
3299.34	41.81	28.62	7.84	38.37	39.90	74.00	-34.10	Vertical	Peak
4121.77	45.76	29.85	8.88	37.83	46.66	74.00	-27.34	Vertical	Peak
5763.62	41.02	32.83	10.53	35.42	48.96	74.00	-25.04	Vertical	Peak
6602.27	38.35	35.24	11.36	35.36	49.59	74.00	-24.41	Vertical	Peak
1277.16	38.96	24.50	4.79	36.53	31.72	74.00	-42.28	Horizontal	Peak
1767.81	38.79	25.50	5.90	37.07	33.12	74.00	-40.88	Horizontal	Peak
2997.07	40.51	28.50	7.48	38.23	38.26	74.00	-35.74	Horizontal	Peak
4069.13	48.00	29.71	8.84	37.95	48.60	74.00	-25.40	Horizontal	Peak
5705.39	38.25	32.72	10.44	35.58	45.83	74.00	-28.17	Horizontal	Peak
6510.30	36.69	35.10	11.19	35.34	47.64	74.00	-26.36	Horizontal	Peak

802.11g					CH06				
Frequency (MHz)	Read Level (dBuV)	Antenna Factor (dB/m)	Cable Loss (dB)	Preamp Factor (dB)	Level (dBuV/m)	Limit Line (dBuV/m)	Margin Limit (dB)	Polarization	Test value
1185.94	38.38	24.41	4.63	36.58	30.84	74.00	-43.16	Vertical	Peak
1386.26	37.77	24.60	4.98	36.47	30.88	74.00	-43.12	Vertical	Peak
1736.83	38.33	25.41	5.84	37.01	32.57	74.00	-41.43	Vertical	Peak
4121.77	48.89	29.85	8.88	37.83	49.79	74.00	-24.21	Vertical	Peak
5763.62	33.14	32.83	10.53	35.42	41.08	54.00	-12.92	Vertical	Average
5763.62	43.32	32.83	10.53	35.42	51.26	74.00	-22.74	Vertical	Peak
6602.26	34.18	35.24	11.36	35.36	45.42	54.00	-8.58	Vertical	Average
6602.27	38.43	35.24	11.36	35.36	49.67	74.00	-24.33	Vertical	Peak
1192.81	38.92	24.42	4.64	36.57	31.41	74.00	-42.59	Horizontal	Peak
1692.23	38.37	25.29	5.75	36.91	32.50	74.00	-41.50	Horizontal	Peak
2990.53	42.65	28.49	7.47	38.24	40.37	74.00	-33.63	Horizontal	Peak
4062.63	42.66	29.67	8.83	37.97	43.19	54.00	-10.81	Horizontal	Average
4062.63	50.18	29.67	8.83	37.97	50.71	74.00	-23.29	Horizontal	Peak
5697.37	42.51	32.72	10.43	35.60	50.06	74.00	-23.94	Horizontal	Peak
7326.27	30.69	36.07	11.99	34.92	43.83	54.00	-10.17	Horizontal	Average
7326.27	38.99	36.07	11.99	34.92	52.13	74.00	-21.87	Horizontal	Peak

802.11g					CH11				
Frequency (MHz)	Read Level (dBuV)	Antenna Factor (dB/m)	Cable Loss (dB)	Preamp Factor (dB)	Level (dBuV/m)	Limit Line (dBuV/m)	Margin Limit (dB)	Polarization	Test value
1145.51	38.57	24.37	4.54	36.60	30.88	74.00	-43.12	Vertical	Peak
1706.97	37.97	25.33	5.78	36.94	32.14	74.00	-41.86	Vertical	Peak
3252.01	40.57	28.61	7.78	38.29	38.67	74.00	-35.33	Vertical	Peak
4074.39	47.02	29.71	8.84	37.94	47.63	74.00	-26.37	Vertical	Peak
5697.37	36.91	32.72	10.43	35.60	44.46	74.00	-29.54	Vertical	Peak
6507.54	32.15	35.10	11.19	35.34	43.10	54.00	-10.90	Vertical	Average
6507.54	40.54	35.10	11.19	35.34	51.49	74.00	-22.51	Vertical	Peak
1071.83	38.39	24.29	4.37	36.63	30.42	74.00	-43.58	Horizontal	Peak
1285.90	38.24	24.51	4.81	36.52	31.04	74.00	-42.96	Horizontal	Peak
1556.17	36.92	24.88	5.45	36.66	30.59	74.00	-43.41	Horizontal	Peak
3214.62	45.38	28.59	7.74	38.23	43.48	74.00	-30.52	Horizontal	Peak
4027.55	44.33	29.57	8.80	38.05	44.65	74.00	-29.35	Horizontal	Peak
6432.73	38.25	34.83	11.05	35.32	48.81	74.00	-25.19	Horizontal	Peak

Remark:

1. Final Level = Receiver Read level + Antenna Factor + Cable Loss – Preamplifier Factor
2. The peak level is lower than average limit (54 dBuV/m), this data is too weak instrument of signal is unable to test.
3. The emission levels of other frequencies are very lower than the limit and not show in test report.

802.11n(H20)					CH01				
Frequency (MHz)	Read Level (dBuV)	Antenna Factor (dB/m)	Cable Loss (dB)	Preamp Factor (dB)	Level (dBuV/m)	Limit Line (dBuV/m)	Margin Limit (dB)	Polarization	Test value
1125.81	38.32	24.35	4.49	36.61	30.55	74.00	-43.45	Vertical	Peak
1300.86	37.79	24.53	4.83	36.51	30.64	74.00	-43.36	Vertical	Peak
1726.82	38.27	25.39	5.82	36.99	32.49	74.00	-41.51	Vertical	Peak
3214.62	41.64	28.59	7.74	38.23	39.74	74.00	-34.26	Vertical	Peak
4027.55	44.99	29.57	8.80	38.05	45.31	74.00	-28.69	Vertical	Peak
6432.73	38.90	34.83	11.05	35.32	49.46	74.00	-24.54	Vertical	Peak
1217.19	37.88	24.44	4.69	36.56	30.45	74.00	-43.55	Horizontal	Peak
1418.69	37.49	24.63	5.05	36.48	30.69	74.00	-43.31	Horizontal	Peak
1813.79	38.47	25.62	5.98	37.15	32.92	74.00	-41.08	Horizontal	Peak
2990.53	40.69	28.49	7.47	38.24	38.41	74.00	-35.59	Horizontal	Peak
4027.55	48.14	29.57	8.80	38.05	48.46	74.00	-25.54	Horizontal	Peak
6432.73	30.75	34.83	11.05	35.32	41.31	54.00	-12.69	Horizontal	Average
6432.73	39.76	34.83	11.05	35.32	50.32	74.00	-23.68	Horizontal	Peak

802.11n(H20)					CH06				
Frequency (MHz)	Read Level (dBuV)	Antenna Factor (dB/m)	Cable Loss (dB)	Preamp Factor (dB)	Level (dBuV/m)	Limit Line (dBuV/m)	Margin Limit (dB)	Polarization	Test value
1335.14	37.58	24.56	4.89	36.50	30.53	74.00	-43.47	Vertical	Peak
1782.60	38.99	25.54	5.93	37.10	33.36	74.00	-40.64	Vertical	Peak
3252.01	41.41	28.61	7.78	38.29	39.51	74.00	-34.49	Vertical	Peak
4062.63	46.98	29.67	8.83	37.97	47.51	74.00	-26.49	Vertical	Peak
5697.37	39.96	32.72	10.43	35.60	47.51	74.00	-26.49	Vertical	Peak
6507.54	31.57	35.10	11.19	35.34	42.52	54.00	-11.48	Vertical	Average
6507.54	42.82	35.10	11.19	35.34	53.77	74.00	-20.23	Vertical	Peak
1138.90	38.32	24.36	4.52	36.60	30.60	74.00	-43.40	Horizontal	Peak
1224.25	38.95	24.45	4.70	36.56	31.54	74.00	-42.46	Horizontal	Peak
1692.23	38.27	25.29	5.75	36.91	32.40	74.00	-41.60	Horizontal	Peak
3214.62	41.78	28.59	7.74	38.23	39.88	74.00	-34.12	Horizontal	Peak
4015.93	44.25	29.53	8.79	38.07	44.50	74.00	-29.50	Horizontal	Peak
6432.73	35.88	34.83	11.05	35.32	46.44	54.00	-7.56	Horizontal	Average
6432.73	41.56	34.83	11.05	35.32	52.12	74.00	-21.88	Horizontal	Peak

802.11n(H20)					CH11				
Frequency (MHz)	Read Level (dBuV)	Antenna Factor (dB/m)	Cable Loss (dB)	Preamplifier Factor (dB)	Level (dBuV/m)	Limit Line (dBuV/m)	Margin Limit (dB)	Polarization	Test value
1224.25	38.03	24.45	4.70	36.56	30.62	74.00	-43.38	Vertical	Peak
1834.88	37.84	25.68	6.01	37.17	32.36	74.00	-41.64	Vertical	Peak
3299.34	40.73	28.62	7.84	38.37	38.82	74.00	-35.18	Vertical	Peak
4121.77	46.31	29.85	8.88	37.83	47.21	74.00	-26.79	Vertical	Peak
5780.30	40.04	32.85	10.56	35.37	48.08	74.00	-25.92	Vertical	Peak
6602.27	40.03	35.24	11.36	35.36	51.27	74.00	-22.73	Vertical	Peak
6602.27	35.88	35.24	11.36	35.36	47.12	54.00	-6.88	Vertical	Average
1189.37	38.07	24.41	4.64	36.58	30.54	74.00	-43.46	Horizontal	Peak
1829.58	38.01	25.67	6.01	37.16	32.53	74.00	-41.47	Horizontal	Peak
2990.53	40.90	28.49	7.47	38.24	38.62	74.00	-35.38	Horizontal	Peak
4074.39	41.28	29.71	8.84	37.94	41.89	54.00	-12.11	Horizontal	Average
4074.39	50.62	29.71	8.84	37.94	51.23	74.00	-22.77	Horizontal	Peak
5697.36	32.95	32.72	10.43	35.60	40.50	54.00	-13.50	Horizontal	Average
5697.37	42.90	32.72	10.43	35.60	50.45	74.00	-23.55	Horizontal	Peak
6507.54	35.89	35.10	11.19	35.34	46.84	54.00	-7.16	Horizontal	Average
6507.54	39.50	35.10	11.19	35.34	50.45	74.00	-23.55	Horizontal	Peak

Remark:

1. Final Level = Receiver Read level + Antenna Factor + Cable Loss – Preamplifier Factor
2. The peak level is lower than average limit(54 dBuV/m), this data is the too weak instrument of signal is unable to test.
3. The emission levels of other frequencies are very lower than the limit and not show in test report.

6. Test Setup Photos of the EUT

Conducted Emission(AC Mains)



Radiated Emission



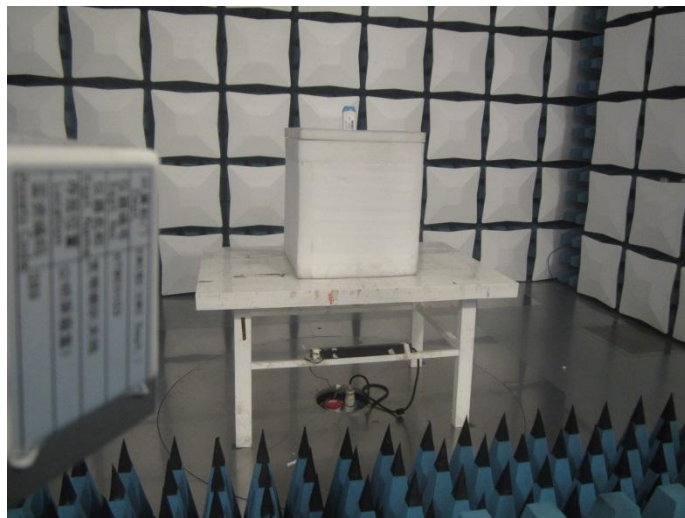

7. External and Internal Photos of the EUT

External photos





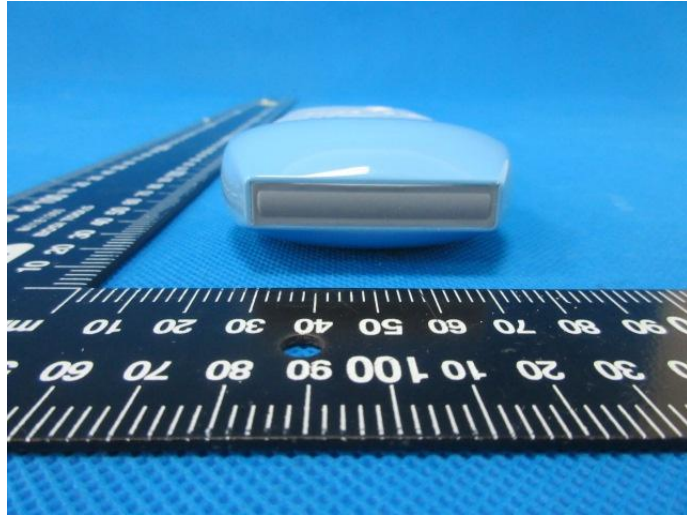

Internal photos

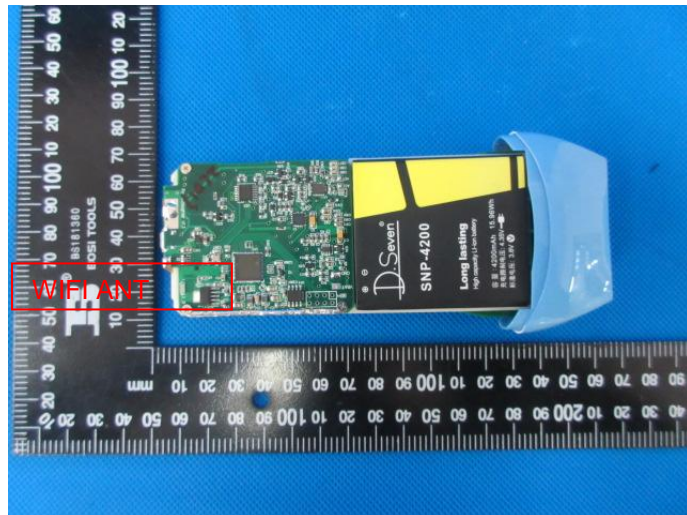

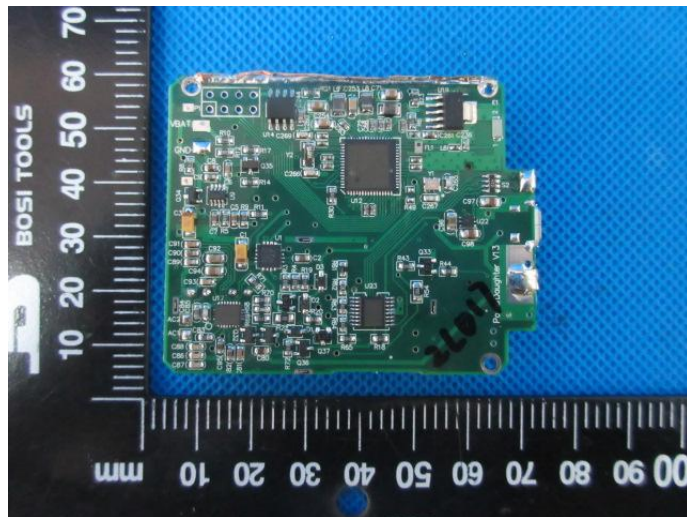
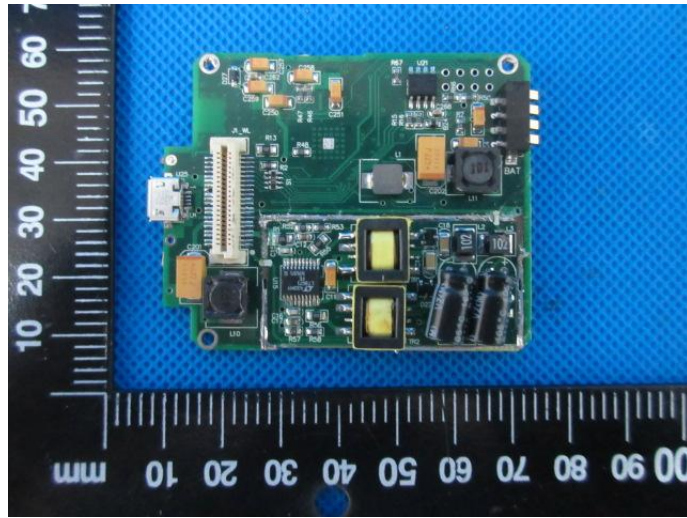
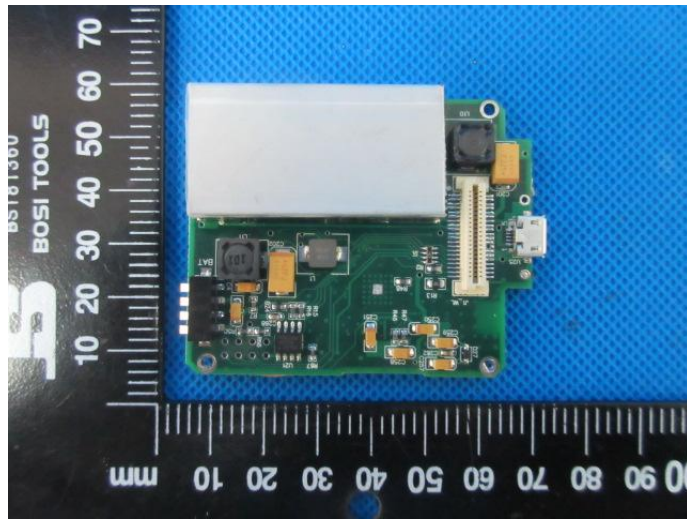

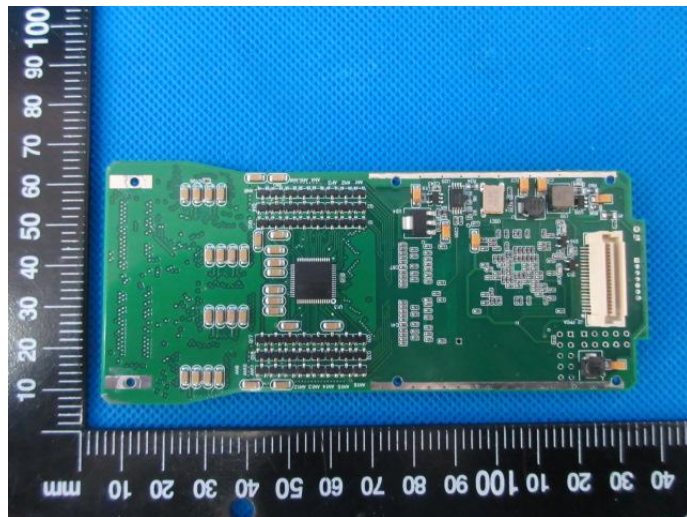
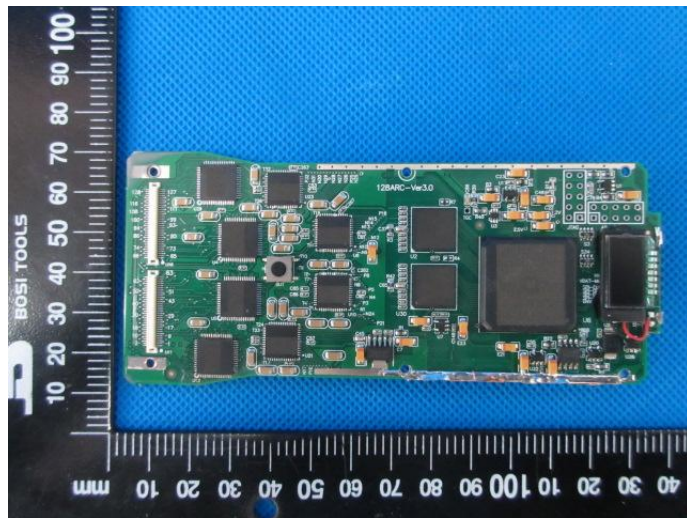
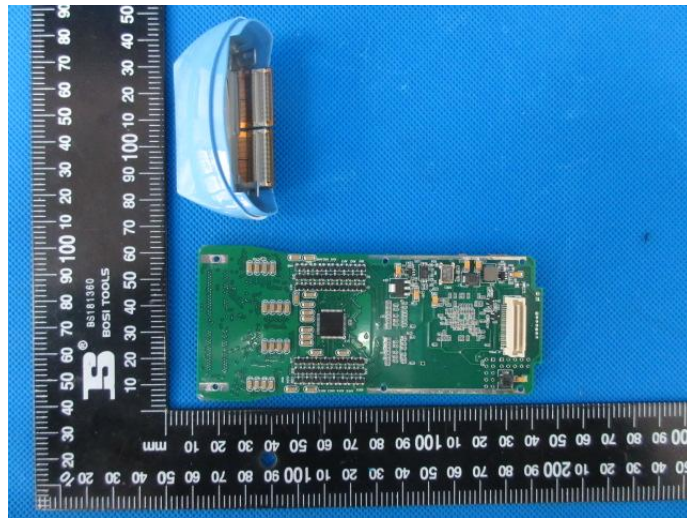

.....End of Report.....