

---

# FCC Test Report

---

Report No.: AGC00765250502FR01

**FCC ID** : 2AKC6-WF912

**APPLICATION PURPOSE** : Original Equipment

**PRODUCT DESIGNATION** : Wireless USB Adapter

**BRAND NAME** : N/A

**MODEL NAME** : AX912, AX920, WB900, WB612

**APPLICANT** : SHEN ZHEN XIN HUA TIAN TECHNOLOGY CO., LTD

**DATE OF ISSUE** : Jun. 09, 2025

**STANDARD(S)** : FCC Part 15 Subpart C §15.247

**REPORT VERSION** : V1.0

Attestation of Global Compliance (Shenzhen) Co., Ltd



Any report having not been signed by authorized approver, or having been altered without authorization, or having not been stamped by the "Dedicated Testing/Inspection Stamp" is deemed to be invalid. Copying or excerpting portion of, or altering the content of the report is not permitted without the written authorization of AGC. The test results presented in the report apply only to the tested sample. Any objections to report issued by AGC should be submitted to AGC within 15days after the issuance of the test report. Further enquiry of validity or verification of the test report should be addressed to AGC by [agc01@agccert.com](mailto:agc01@agccert.com).

Attestation of Global Compliance(Shenzhen)Co., Ltd  
Attestation of Global Compliance(Shenzhen)Std & Tech Co., Ltd  
Tel: +86-755 2523 4088 E-mail: [agc@agccert.com](mailto:agc@agccert.com) Web: <http://www.agccert.com/>



**Report Revise Record**

Report Version	Revise Time	Issued Date	Valid Version	Notes
V1.0	/	Jun. 09, 2025	Valid	Initial Release

Any report having not been signed by authorized approver, or having been altered without authorization, or having not been stamped by the "Dedicated Testing/Inspection Stamp" is deemed to be invalid. Copying or excerpting portion of, or altering the content of the report is not permitted without the written authorization of AGC. The test results presented in the report apply only to the tested sample. Any objections to report issued by AGC should be submitted to AGC within 15days after the issuance of the test report. Further enquiry of validity or verification of the test report should be addressed to AGC by [agc01@agccert.com](mailto:agc01@agccert.com).

Attestation of Global Compliance(Shenzhen)Co., Ltd  
Attestation of Global Compliance(Shenzhen)Std & Tech Co., Ltd  
Tel: +86-755 2523 4088 E-mail: [agc@agccert.com](mailto:agc@agccert.com) Web: <http://www.agccert.com/>

## Table of Contents

<b>1. General Information .....</b>	<b>5</b>
<b>2. Product Information .....</b>	<b>6</b>
2.1 Product Technical Description .....	6
2.2 Test Frequency List .....	6
2.3 Related Submittal(S) / Grant (S) .....	7
2.4 Test Methodology .....	7
2.5 Receiver Input Bandwidth .....	7
2.6 Equally Average Use of Frequencies and Behaviour.....	7
2.7 Pseudorandom Frequency Hopping Sequence .....	8
2.8 Special Accessories .....	9
2.9 Equipment Modifications .....	9
2.10 Antenna Requirement .....	9
<b>3. Test Environment .....</b>	<b>10</b>
3.1 Address of The Test Laboratory .....	10
3.2 Test Facility .....	10
3.3 Environmental Conditions .....	11
3.4 Measurement Uncertainty .....	11
3.5 List of Equipment Used .....	12
<b>4. System Test Configuration.....</b>	<b>14</b>
4.1 EUT Configuration.....	14
4.2 EUT Exercise.....	14
4.3 Configuration of Tested System .....	14
4.4 Equipment Used in Tested System.....	15
4.5 Summary of Test Results .....	16
<b>5. Description of Test Modes .....</b>	<b>17</b>
<b>6. RF Output Power Measurement .....</b>	<b>18</b>
6.1 Provisions Applicable .....	18
6.2 Measurement Procedure.....	18
6.3 Measurement Setup (Block Diagram of Configuration) .....	18
6.4 Measurement Result .....	19
<b>7. 20dB Bandwidth and 99% Occupied Bandwidth Measurement.....</b>	<b>25</b>
7.1 Provisions Applicable .....	25
7.2 Measurement Procedure.....	25
7.3 Measurement Setup (Block Diagram of Configuration) .....	25
7.4 Measurement Results .....	26
<b>8. Conducted Band Edge and Out-of-Band Emissions.....</b>	<b>31</b>
8.1 Provisions Applicable .....	31
8.2 Measurement Procedure.....	31
8.3 Measurement Setup (Block Diagram of Configuration) .....	32
8.4 Measurement Results .....	33

Any report having not been signed by authorized approver, or having been altered without authorization, or having not been stamped by the “Dedicated Testing/Inspection Stamp” is deemed to be invalid. Copying or excerpting portion of, or altering the content of the report is not permitted without the written authorization of AGC. The test results presented in the report apply only to the tested sample. Any objections to report issued by AGC should be submitted to AGC within 15days after the issuance of the test report. Further enquiry of validity or verification of the test report should be addressed to AGC by agc01@agccert.com.

<b>9. Radiated Spurious Emission .....</b>	<b>53</b>
9.1 Measurement Limit.....	53
9.2 Measurement Procedure.....	53
9.3 Measurement Setup (Block Diagram of Configuration) .....	56
9.4 Measurement Result .....	57
<b>10. Number of Hopping Frequency Measurement.....</b>	<b>66</b>
10.1 Provisions Applicable .....	66
10.2 Measurement Procedure.....	66
10.3 Measurement Setup (Block Diagram of Configuration) .....	66
10.4 Measurement Result .....	66
<b>11. Time of Occupancy (Dwell Time) Measurement .....</b>	<b>69</b>
11.1 Provisions Applicable.....	69
11.2 Measurement Procedure .....	69
11.3 Measurement Setup (Block Diagram of Configuration) .....	69
11.4 Measurement Result .....	69
<b>12. Frequency Separation Measurement.....</b>	<b>73</b>
12.1 Provisions Applicable .....	73
12.2 Measurement Procedure.....	73
12.3 Measurement Setup (Block Diagram of Configuration) .....	73
12.4 Measurement Result .....	73
<b>13. AC Power Line Conducted Emission Test.....</b>	<b>76</b>
13.1 Measurement Limit.....	76
13.2 Measurement Setup (Block Diagram of Configuration) .....	76
13.3 Preliminary Procedure of Line Conducted Emission Test .....	77
13.4 Final Procedure of Line Conducted Emission Test .....	77
13.5 Measurement Result .....	77
<b>Appendix I: Photographs of Test Setup.....</b>	<b>80</b>
<b>Appendix II: Photographs of Test EUT .....</b>	<b>80</b>

Any report having not been signed by authorized approver, or having been altered without authorization, or having not been stamped by the “Dedicated Testing/Inspection Stamp” is deemed to be invalid. Copying or excerpting portion of, or altering the content of the report is not permitted without the written authorization of AGC. The test results presented in the report apply only to the tested sample. Any objections to report issued by AGC should be submitted to AGC within 15days after the issuance of the test report. Further enquiry of validity or verification of the test report should be addressed to AGC by agc01@agccert.com.

### 1. General Information

Applicant	SHEN ZHEN XIN HUA TIAN TECHNOLOGY CO., LTD
Address	3Floor, B Buliding, DaHong Industrial Park, GuangMin District, Shenzhen City, China
Manufacturer	SHEN ZHEN XIN HUA TIAN TECHNOLOGY CO., LTD
Address	3Floor, B Buliding, DaHong Industrial Park, GuangMin District, Shenzhen City, China
Factory	SHEN ZHEN XIN HUA TIAN TECHNOLOGY CO., LTD
Address	3Floor, B Buliding, DaHong Industrial Park, GuangMin District, Shenzhen City, China
Product Designation	Wireless USB Adapter
Brand Name	N/A
Test Model	AX912
Series Model(s)	AX920, WB900, WB612
Difference Description	All the same except for the model name and plastic appearance.
Date of receipt of test item	May 16, 2025
Date of Test	May 16, 2025 to Jun. 09, 2025
Deviation from Standard	No any deviation from the test method
Condition of Test Sample	Normal
Test Result	Pass
Test Report Form No	AGCER-FCC-BR_EDR-V1

Note: The test results of this report relate only to the tested sample identified in this report.

Prepared By   
 \_\_\_\_\_  
 Cici Li  
 (Project Engineer) Jun. 09, 2025

Reviewed By   
 \_\_\_\_\_  
 Bibo Zhang  
 (Reviewer) Jun. 09, 2025

Approved By   
 \_\_\_\_\_  
 Angela Li  
 (Authorized Officer) Jun. 09, 2025

Any report having not been signed by authorized approver, or having been altered without authorization, or having not been stamped by the “Dedicated Testing/Inspection Stamp” is deemed to be invalid. Copying or excerpting portion of, or altering the content of the report is not permitted without the written authorization of AGC. The test results presented in the report apply only to the tested sample. Any objections to report issued by AGC should be submitted to AGC within 15days after the issuance of the test report. Further enquiry of validity or verification of the test report should be addressed to AGC by agc01@agccert.com.

## 2. Product Information

### 2.1 Product Technical Description

Technology Type	Classic Bluetooth
Frequency Band	2400M-2483.5MHz
Operation Frequency Range	2402MHz-2480MHz
Bluetooth Version	V5.4
Modulation Type	BR <input checked="" type="checkbox"/> GFSK, EDR <input checked="" type="checkbox"/> π /4-DQPSK, <input checked="" type="checkbox"/> 8DPSK
Number of channels	79 of Channels
Channel Separation	1 MHz
Maximum Transmitter Power	4.088dBm
Hardware Version	V2.0
Software Version	V1.2
Antenna Designation	Built-in Antenna
Antenna Gain	1.40dBi
Power Supply	DC 5V

### 2.2 Test Frequency List

Frequency Band	Channel Number	Test Frequency
2400~2483.5MHz	0	2402 MHz
	1	2403 MHz
	:	:
	39	2441MHz
	:	:
	77	2479 MHz
	78	2480 MHz

Note:  $f = 2402+1*k$  MHz,  $k=0, \dots, 78$ ; "f" is the operating frequency (MHz); "k" is the operating channel.

### 2.3 Related Submittal(S) / Grant (S)

This submittal(s) (test report) is intended for FCC ID: **2AKC6-WF912**, filing to comply with Part 2, Part 15 of the Federal Communication Commission rules.

### 2.4 Test Methodology

The tests were performed according to following standards:

No.	Identity	Document Title
1	FCC 47 CFR Part 2	Frequency allocations and radio treaty matters; general rules and regulations
2	FCC 47 CFR Part 15	Radio Frequency Devices
3	ANSI C63.10-2013	American National Standard for Testing Unlicensed Wireless Devices
4	KDB 558074 D01 15.247 Meas Guidance v05r02	Guidance for compliance measurements on Digital Transmission Systems, Frequency Hopping Spread Spectrum system, and Hybrid system devices operating under Section 15.247 of the FCC rules

### 2.5 Receiver Input Bandwidth

The input bandwidth of the receiver is 1.3MHz, in every connection one Bluetooth device is the master and the other one is slave. The master determines the hopping sequence. The slave follows this sequence. Both devices shift between RX and TX time slot according to the clock of the master. Additionally, the type of connection (e.g. single of multi slot packet) is set up at the beginning of the connection. The master adapts its hopping frequency and its TX/RX timing according to the packet type of the connection. Also, the slave of the connection will use these settings. Repeating of a packet has no influence on the hopping sequence. The hopping sequence generated by the master of the connection will be followed in any case. That means, a repeated packet will not be send on the same frequency, it is send on the next frequency of the hopping sequence.

### 2.6 Equally Average Use of Frequencies and Behaviour.

The generation of the hopping sequence in connection mode depends essentially on two input values:

1. LAP/UAP of the master of the connection.
2. Internal master clock.

The LAP (lower address part) are the 24 LSB's of the 48 BD\_ADDRESS. The BD\_ADDRESS is an unambiguous number of every Bluetooth unit. The UAP (upper address part) are the 24MSB's of the 48BD\_ADDRESS

The internal clock of a Bluetooth unit is derived from a free running clock which is never adjusted and is never turned off. For behavior action with other units only offset is used. It has no relation to the time of the day. Its resolution is at least half the RX/TX slot length of 312.5us. The clock has a cycle of about one day(23h30).

In most case it is implemented as 28 bits counter. For the deriving of the hopping sequence the entire. LAP (24 bits),4LSB's(4bits) (Input 1) and the 27MSB's of the clock (Input 2) are used. With this input values different mathematical procedures (permutations, additions, XOR-operations) are performed to generate the Sequence. This will be done at the beginning of every new transmission.

Regarding short transmissions the Bluetooth system has the following behavior:

The first connection between the two devices is established, a hopping sequence was generated. For Transmitting the wanted data the complete hopping sequence was not used. The connection ended.

The second connection will be established. A new hopping sequence is generated. Due to the fact the Bluetooth clock has a different value, because the period between the two transmission is longer (and it Cannot be shorter) than the minimum resolution of the clock(312.5us). The hopping sequence will always differ from the first one.

Any report having not been signed by authorized approver, or having been altered without authorization, or having not been stamped by the "Dedicated Testing/Inspection Stamp" is deemed to be invalid. Copying or excerpting portion of, or altering the content of the report is not permitted without the written authorization of AGC. The test results presented in the report apply only to the tested sample. Any objections to report issued by AGC should be submitted to AGC within 15days after the issuance of the test report. Further enquiry of validity or verification of the test report should be addressed to AGC by agc01@agccert.com.



## 2.7 Pseudorandom Frequency Hopping Sequence

The pseudorandom sequence may be generated in a nine-stage shift register whose 5th and 9th stage outputs are added in a modulo-two addition stage. And the result is fed back to the input of the first stage. The sequence begins with the first ONE of 9 consecutive ONES; i.e. the shift register is initialized with nine ones.

- Number of shift register stages: 9
- Length of pseudo-random sequence:  $2^9 - 1 = 511$  bits
- Longest sequence of zeros: 8 (non-inverted signal)

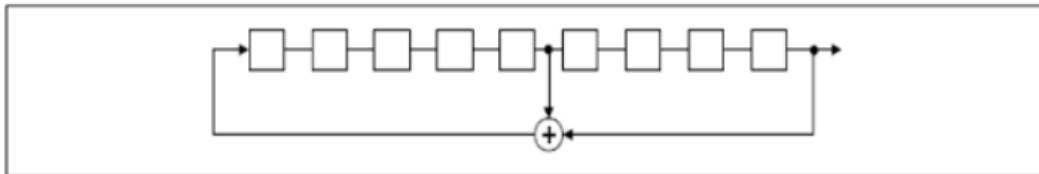

Linear Feedback Shift Register for Generation of The PRBS Sequence

An example of Pseudorandom Frequency Hopping Sequence as follow:

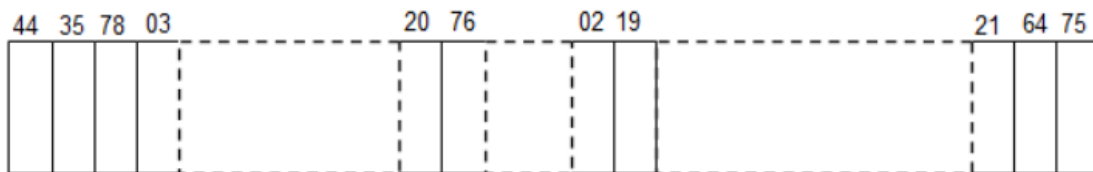

Each frequency used equally on the average by each transmitter.

The system receivers have input bandwidths that match the hopping channel bandwidths of their Corresponding transmitters and shift frequencies in synchronization with the transmitted signals.



## 2.8 Special Accessories

Not available for this EUT intended for grant.

## 2.9 Equipment Modifications

Not available for this EUT intended for grant.

## 2.10 Antenna Requirement

Standard Requirement
<p><b>15.203 requirement:</b> An intentional radiator shall be designed to ensure that no antenna other than that furnished by the responsible party shall be used with the device. The use of a permanently attached antenna or of an antenna that uses a unique coupling to the intentional radiator, the manufacturer may design the unit so that a broken antenna can be replaced by the user, but the use of a standard antenna jack or electrical connector is prohibited.</p> <p><b>15.247(b) (4) requirement:</b> The conducted output power limit specified in paragraph (b) of this section is based on the use of antennas with directional gains that do not exceed 6 dBi. Except as shown in paragraph (c) of this section, if transmitting antennas of directional gain greater than 6 dBi are used, the conducted output power from the intentional radiator shall be reduced below the stated values in paragraphs (b)(1), (b)(2), and (b)(3) of this section, as appropriate, by the amount in dB that the directional gain of the antenna exceeds 6 dBi</p>
EUT Antenna
<p>The non-detachable antenna inside the device cannot be replaced by the user at will. The gain of the antenna is 1.40dBi.</p>

Any report having not been signed by authorized approver, or having been altered without authorization, or having not been stamped by the "Dedicated Testing/Inspection Stamp" is deemed to be invalid. Copying or excerpting portion of, or altering the content of the report is not permitted without the written authorization of AGC. The test results presented in the report apply only to the tested sample. Any objections to report issued by AGC should be submitted to AGC within 15days after the issuance of the test report. Further enquiry of validity or verification of the test report should be addressed to AGC by agc01@agccert.com.

### 3. Test Environment

#### 3.1 Address of The Test Laboratory

Laboratory: Attestation of Global Compliance (Shenzhen) Co., Ltd.

Address: 1-2/F, Building 19, Junfeng Industrial Park, Chongqing Road, Heping Community, Fuhai Street, Bao'an District, Shenzhen, Guangdong, China

#### 3.2 Test Facility

The test facility is recognized, certified, or accredited by the following organizations:

##### **CNAS-Lab Code: L5488**

Attestation of Global Compliance (Shenzhen) Co., Ltd. has been assessed and proved to follow CNAS-CL01 Accreditation Criteria for Testing and Calibration Laboratories (identical to ISO/IEC17025: 2017 General Requirements for the Competence of Testing and Calibration Laboratories.)

##### **A2LA-Lab Cert. No.: 5054.02**

Attestation of Global Compliance (Shenzhen) Co., Ltd. EMC Laboratory has been accredited by A2LA for technical competence in the field of electrical testing, and proved to follow ISO/IEC 17025: 2017 General Requirements for the Competence of Testing and Calibration Laboratories and any additional program requirements in the identified field of testing.

##### **FCC-Registration No.: 975832**

Attestation of Global Compliance (Shenzhen) Co., Ltd. EMC Laboratory has been registered and fully described in a report filed with the FCC (Federal Communications Commission). The acceptance letter from the FCC is maintained in our files with Registration 975832.

##### **IC-Registration No.: 24842(CAB identifier: CN0063)**

Attestation of Global Compliance (Shenzhen) Co., Ltd. EMC Laboratory has been registered and fully described in a report filed with the Certification and Engineering Bureau of Industry Canada. The acceptance letter from the IC is maintained in our files with Registration 24842.

Any report having not been signed by authorized approver, or having been altered without authorization, or having not been stamped by the "Dedicated Testing/Inspection Stamp" is deemed to be invalid. Copying or excerpting portion of, or altering the content of the report is not permitted without the written authorization of AGC. The test results presented in the report apply only to the tested sample. Any objections to report issued by AGC should be submitted to AGC within 15days after the issuance of the test report. Further enquiry of validity or verification of the test report should be addressed to AGC by [agc01@agccert.com](mailto:agc01@agccert.com).

### 3.3 Environmental Conditions

	Normal Conditions
Temperature range (°C)	15 - 35
Relative humidity range	20 % - 75 %
Pressure range (kPa)	86 - 106
Power supply	DC 5V

### 3.4 Measurement Uncertainty

The reported uncertainty of measurement  $y \pm U$ , where expanded uncertainty  $U$  is based on a standard uncertainty multiplied by a coverage factor of  $k=2$ , providing a level of confidence of approximately 95%.

Item	Measurement Uncertainty
Uncertainty of Conducted Emission for AC Port	$U_c = \pm 2.9$ dB
Uncertainty of Radiated Emission below 1GHz	$U_c = \pm 3.9$ dB
Uncertainty of Radiated Emission above 1GHz	$U_c = \pm 4.9$ dB
Uncertainty of total RF Power, Conducted	$U_c = \pm 0.8$ dB
Uncertainty of RF Power Density, Conducted	$U_c = \pm 2.6$ dB
Uncertainty of Spurious Emissions, Conducted	$U_c = \pm 2$ %
Uncertainty of Occupied Channel Bandwidth	$U_c = \pm 2$ %
Uncertainty of Dwell Time	$U_c = \pm 2$ %

Any report having not been signed by authorized approver, or having been altered without authorization, or having not been stamped by the "Dedicated Testing/Inspection Stamp" is deemed to be invalid. Copying or excerpting portion of, or altering the content of the report is not permitted without the written authorization of AGC. The test results presented in the report apply only to the tested sample. Any objections to report issued by AGC should be submitted to AGC within 15days after the issuance of the test report. Further enquiry of validity or verification of the test report should be addressed to AGC by [agc01@agccert.com](mailto:agc01@agccert.com).

### 3.5 List of Equipment Used

● RF Conducted Test System							
Used	Equipment No.	Test Equipment	Manufacturer	Model No.	Serial No.	Last Cal. Date (YY-MM-DD)	Next Cal. Date (YY-MM-DD)
<input checked="" type="checkbox"/>	AGC-ER-E036	Spectrum Analyzer	Agilent	N9020A	MY49100060	2025-01-14	2026-01-13
<input checked="" type="checkbox"/>	AGC-ER-A007	6dB Fixed Attenuator	Mini circuits	BW-S6-2W263A+	N/A	2025-01-30	2026-01-29
<input checked="" type="checkbox"/>	N/A	RF Connection Cable	N/A	1#	N/A	Each time	N/A
<input checked="" type="checkbox"/>	N/A	RF Connection Cable	N/A	2#	N/A	Each time	N/A

● Radiated Spurious Emission							
Used	Equipment No.	Test Equipment	Manufacturer	Model No.	Serial No.	Last Cal. Date (YY-MM-DD)	Next Cal. Date (YY-MM-DD)
<input checked="" type="checkbox"/>	AGC-EM-E046	EMI Test Receiver	R&S	ESCI	100096	2025-01-14	2026-01-13
<input type="checkbox"/>	AGC-EM-E116	EMI Test Receiver	R&S	ESCI	100034	2025-05-08	2026-05-07
<input checked="" type="checkbox"/>	AGC-EM-E061	Spectrum Analyzer	Agilent	N9010A	MY53470504	2025-05-08	2026-05-07
<input checked="" type="checkbox"/>	AGC-EM-E086	Loop Antenna	ZHINAN	ZN30900C	18051	2024-03-05	2026-03-04
<input checked="" type="checkbox"/>	AGC-EM-E001	Wideband Antenna	SCHWARZBECK	VULB9168	D69250	2025-03-14	2027-03-13
<input checked="" type="checkbox"/>	AGC-EM-E029	Broadband Ridged Horn Antenna	ETS	3117	00034609	2025-03-27	2026-03-26
<input checked="" type="checkbox"/>	AGC-EM-E082	Horn Antenna	SCHWARZBECK	BBHA 9170	#768	2023-09-24	2025-09-23
<input checked="" type="checkbox"/>	AGC-EM-E146	Pre-amplifier	ETS	3117-PA	00246148	2024-07-24	2026-07-23
<input checked="" type="checkbox"/>	AGC-EM-A119	2.4GHz Filter	SongYi	N/A	N/A	2025-05-16	2026-05-15
<input checked="" type="checkbox"/>	AGC-EM-A138	6dB Attenuator	Eeatsheep	LM-XX-6-5W	N/A	2023-06-09	2025-06-08
<input checked="" type="checkbox"/>	AGC-EM-A138	6dB Attenuator	Eeatsheep	LM-XX-6-5W	N/A	2025-05-16	2027-05-15
<input type="checkbox"/>	AGC-EM-A139	6dB Attenuator	Eeatsheep	LM-XX-6-5W	N/A	2023-06-09	2025-06-08
<input type="checkbox"/>	AGC-EM-A139	6dB Attenuator	Eeatsheep	LM-XX-6-5W	N/A	2025-05-16	2027-05-15

● AC Power Line Conducted Emission							
Used	Equipment No.	Test Equipment	Manufacturer	Model No.	Serial No.	Last Cal. Date (YY-MM-DD)	Next Cal. Date (YY-MM-DD)
<input checked="" type="checkbox"/>	AGC-EM-E116	EMI Test Receiver	R&S	ESCI	100034	2025-05-08	2026-05-07
<input checked="" type="checkbox"/>	AGC-EM-A171	Attenuator	Mini-Circuits	UNAT-10A+	DC-6GZ	2024-02-01	2026-01-31
<input checked="" type="checkbox"/>	AGC-EM-E023	AMN	R&S	ESH2-Z5	100086	2025-05-08	2026-05-07

Any report having not been signed by authorized approver, or having been altered without authorization, or having not been stamped by the "Dedicated Testing/Inspection Stamp" is deemed to be invalid. Copying or excerpting portion of, or altering the content of the report is not permitted without the written authorization of AGC. The test results presented in the report apply only to the tested sample. Any objections to report issued by AGC should be submitted to AGC within 15days after the issuance of the test report. Further enquiry of validity or verification of the test report should be addressed to AGC by agc01@agccert.com.

● Test Software					
Used	Equipment No.	Test Equipment	Manufacturer	Model No.	Version Information
<input checked="" type="checkbox"/>	AGC-EM-S001	CE Test System	R&S	ES-K1	V1.71
<input checked="" type="checkbox"/>	AGC-EM-S003	RE Test System	FARA	EZ-EMC	VRA-03A
<input type="checkbox"/>	AGC-EM-S004	RE Test System	Tonscend	TS <sup>+</sup> Ver2.1(JS32-RE)	4.0.0.0
<input checked="" type="checkbox"/>	AGC-ER-S012	BT/WIFI Test System	Tonscend	JS1120-2	2.6
<input checked="" type="checkbox"/>	AGC-EM-S011	RSE Test System	Tonscend	TS+-Ver2.1(JS36-RSE)	4.0.0.0

Any report having not been signed by authorized approver, or having been altered without authorization, or having not been stamped by the "Dedicated Testing/Inspection Stamp" is deemed to be invalid. Copying or excerpting portion of, or altering the content of the report is not permitted without the written authorization of AGC. The test results presented in the report apply only to the tested sample. Any objections to report issued by AGC should be submitted to AGC within 15days after the issuance of the test report. Further enquiry of validity or verification of the test report should be addressed to AGC by agc01@agccert.com.

Attestation of Global Compliance(Shenzhen)Co., Ltd

Attestation of Global Compliance(Shenzhen)Std & Tech Co., Ltd

Tel: +86-755 2523 4088 E-mail: agc@agccert.com Web: http://www.agccert.com/

## 4. System Test Configuration

### 4.1 EUT Configuration

The EUT configuration for testing is installed on RF field strength measurement to meet the Commission's requirement and operating in a manner which intends to maximize its emission characteristics in a continuous normal application.

### 4.2 EUT Exercise

The Transmitter was operated in the normal operating mode. The TX frequency was fixed which was for the purpose of the measurements.

### 4.3 Configuration of Tested System

Radiated Emission Configure:



Conducted Emission Configure:

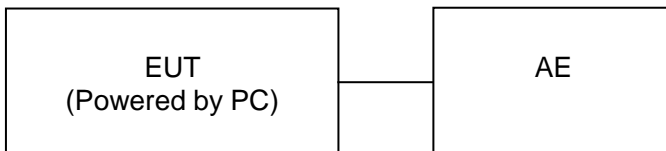

RF Conducted test Configure:

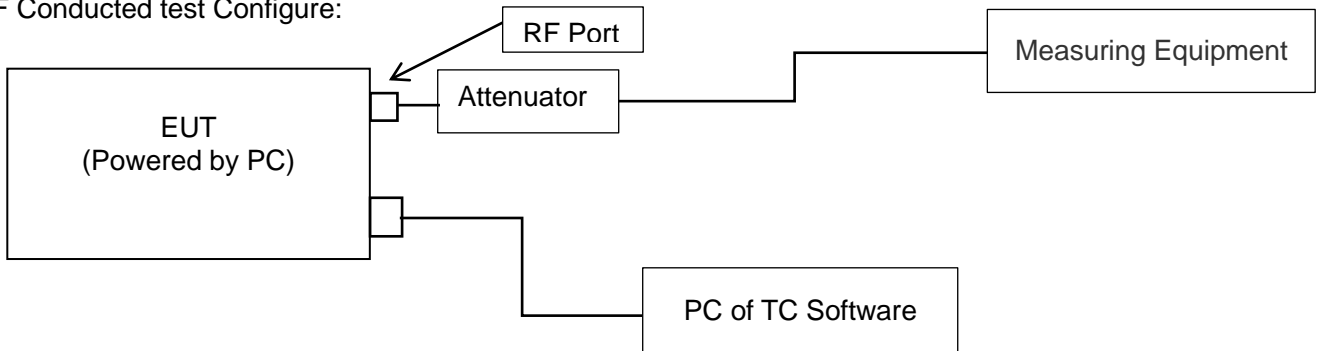

Any report having not been signed by authorized approver, or having been altered without authorization, or having not been stamped by the "Dedicated Testing/Inspection Stamp" is deemed to be invalid. Copying or excerpting portion of, or altering the content of the report is not permitted without the written authorization of AGC. The test results presented in the report apply only to the tested sample. Any objections to report issued by AGC should be submitted to AGC within 15days after the issuance of the test report. Further enquiry of validity or verification of the test report should be addressed to AGC by agc01@agccert.com.

#### 4.4 Equipment Used in Tested System

The following peripheral devices and interface cables were connected during the measurement:

Test Accessories Come From The Laboratory

No.	Equipment	Manufacturer	Model No.	Specification Information	Cable
1	Redmi Notebook PC	Redmi	XMA2002-AB	--	--
2	Adapter	XIAOMI	MDY-11-EF	Input(AC): 100V-240V 50/60Hz 0.7A Output(DC): (5V/3A;9V/3A; 10V/3A;12V/2.25A; 20V/ 1.35A)	1.2m unshielded
3	Redmi Notebook PC	Redmi	RMA2201-AG	--	--
4	USB Cable	--	--	--	0.5m unshielded

Test Accessories Come From The Manufacturer

No.	Equipment	Manufacturer	Model No.	Specification Information	Cable
1	--	--	--	--	--

Any report having not been signed by authorized approver, or having been altered without authorization, or having not been stamped by the "Dedicated Testing/Inspection Stamp" is deemed to be invalid. Copying or excerpting portion of, or altering the content of the report is not permitted without the written authorization of AGC. The test results presented in the report apply only to the tested sample. Any objections to report issued by AGC should be submitted to AGC within 15days after the issuance of the test report. Further enquiry of validity or verification of the test report should be addressed to AGC by agc01@agccert.com.



#### 4.5 Summary of Test Results

Item	FCC Rules	Description of Test	Result
1	§15.203&15.247(b)(4)	Antenna Equipment	Pass
2	§15.247 (b)(1)	RF Output Power	Pass
3	§15.247 (a)(1)	20 dB Bandwidth	Pass
4	§15.247 (d)	Conducted Band Edge and Out-of-Band Emissions	Pass
5	§15.209	Radiated Spurious Emission	Pass
6	§15.247 (a)(1)(iii)	Number of Hopping Frequency	Pass
7	§15.247 (a)(1)(iii)	Time of Occupancy	Pass
8	§15.247 (a)(1)	Frequency Separation	Pass
9	§15.207	AC Power Line Conducted Emission	Pass

Any report having not been signed by authorized approver, or having been altered without authorization, or having not been stamped by the "Dedicated Testing/Inspection Stamp" is deemed to be invalid. Copying or excerpting portion of, or altering the content of the report is not permitted without the written authorization of AGC. The test results presented in the report apply only to the tested sample. Any objections to report issued by AGC should be submitted to AGC within 15days after the issuance of the test report. Further enquiry of validity or verification of the test report should be addressed to AGC by agc01@agccert.com.

### 5. Description of Test Modes

Summary table of Test Cases	
Test Item	Data Rate / Modulation
	Radiated & Conducted Test Cases
AC Conducted Emission	Mode 1: Bluetooth Link (Connect to the PC)

Note:

1. Only the result of the worst case was recorded in the report, if no other cases.
2. For Radiated Emission, 3axis were chosen for testing for each applicable mode.
3. For Conducted Test method, a temporary antenna connector is provided by the manufacture.
4. The manufacturer of RF external cable claims that the cable loss is 0.5dB, and the cable loss and attenuator have been compensated into the Corrections Configuration of measuring equipment.
5. Input correction factor includes external cable loss and attenuator amplitude compensation. The formula is:  
 Input compensation coefficient (dB) = Cable Loss (dB) + Attenuator attenuation value (dB)

Software Setting Diagram

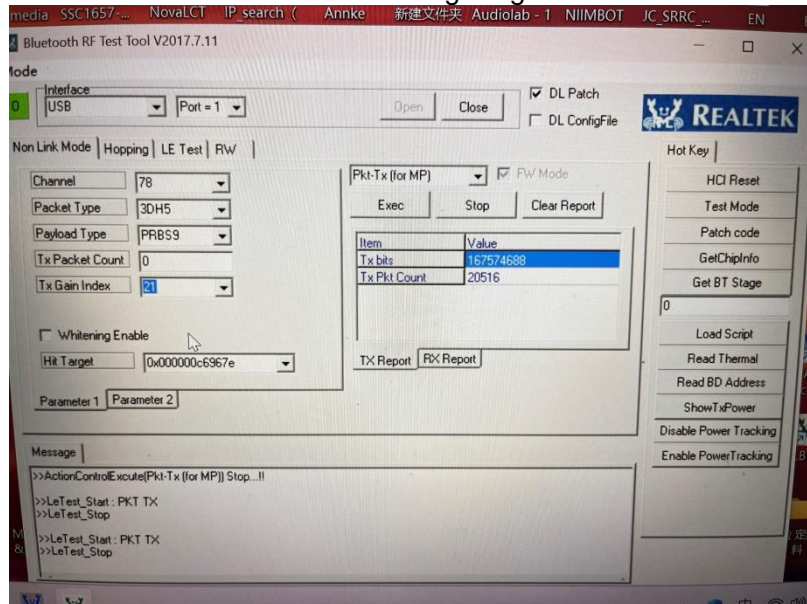

Any report having not been signed by authorized approver, or having been altered without authorization, or having not been stamped by the “Dedicated Testing/Inspection Stamp” is deemed to be invalid. Copying or excerpting portion of, or altering the content of the report is not permitted without the written authorization of AGC. The test results presented in the report apply only to the tested sample. Any objections to report issued by AGC should be submitted to AGC within 15days after the issuance of the test report. Further enquiry of validity or verification of the test report should be addressed to AGC by agc01@agccert.com.

## 6. RF Output Power Measurement

### 6.1 Provisions Applicable

The maximum out power permissible output power is 1 Watt for all frequency hopping systems operating in the 2400-2483.5 MHz band employing at least 75 non-overlapping hopping channels.

The maximum out power permissible output power is 0.125 watts for all other frequency hopping systems in the 2400-2483.5 MHz band.

### 6.2 Measurement Procedure

For Peak power test:

1. Connect EUT RF output port to the Spectrum Analyzer through an RF attenuator
2. Span: Approximately five times the 20 dB bandwidth, centered on a hopping channel.
3. RBW > 20 dB bandwidth of the emission being measured.
4. VBW  $\geq$  RBW.
5. Sweep: Auto.
6. Detector function: Peak.
7. Trace: Max hold.
8. Allow trace to stabilize. Use the marker-to-peak function to set the marker to the peak of the emission. The indicated level is the peak output power, after any corrections for external attenuators and cables.

### 6.3 Measurement Setup (Block Diagram of Configuration)

For peak power test setup

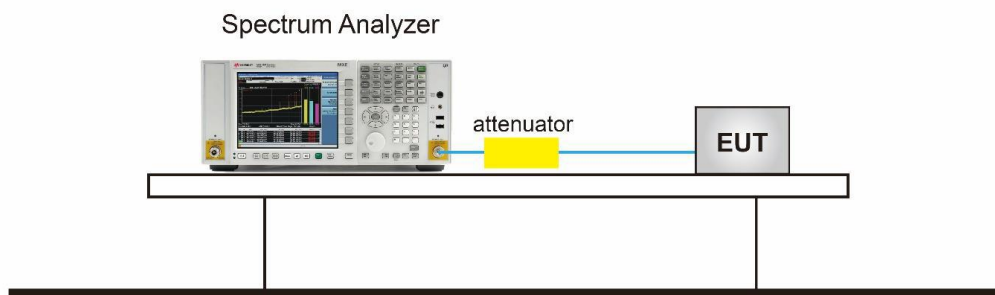

Any report having not been signed by authorized approver, or having been altered without authorization, or having not been stamped by the "Dedicated Testing/Inspection Stamp" is deemed to be invalid. Copying or excerpting portion of, or altering the content of the report is not permitted without the written authorization of AGC. The test results presented in the report apply only to the tested sample. Any objections to report issued by AGC should be submitted to AGC within 15days after the issuance of the test report. Further enquiry of validity or verification of the test report should be addressed to AGC by agc01@agccert.com.

### 6.4 Measurement Result

Test Data of Conducted Output Power				
Test Mode	Test Frequency (MHz)	Peak Power (dBm)	Limits (dBm)	Pass or Fail
GFSK	2402	3.544	≤21	Pass
	2441	3.165	≤21	Pass
	2480	2.677	≤21	Pass
π /4-DQPSK	2402	3.631	≤21	Pass
	2441	3.036	≤21	Pass
	2480	2.859	≤21	Pass
8DPSK	2402	4.088	≤21	Pass
	2441	3.603	≤21	Pass
	2480	3.221	≤21	Pass

Any report having not been signed by authorized approver, or having been altered without authorization, or having not been stamped by the "Dedicated Testing/Inspection Stamp" is deemed to be invalid. Copying or excerpting portion of, or altering the content of the report is not permitted without the written authorization of AGC. The test results presented in the report apply only to the tested sample. Any objections to report issued by AGC should be submitted to AGC within 15days after the issuance of the test report. Further enquiry of validity or verification of the test report should be addressed to AGC by agc01@agccert.com.

### Test Graphs of Conducted Output Power

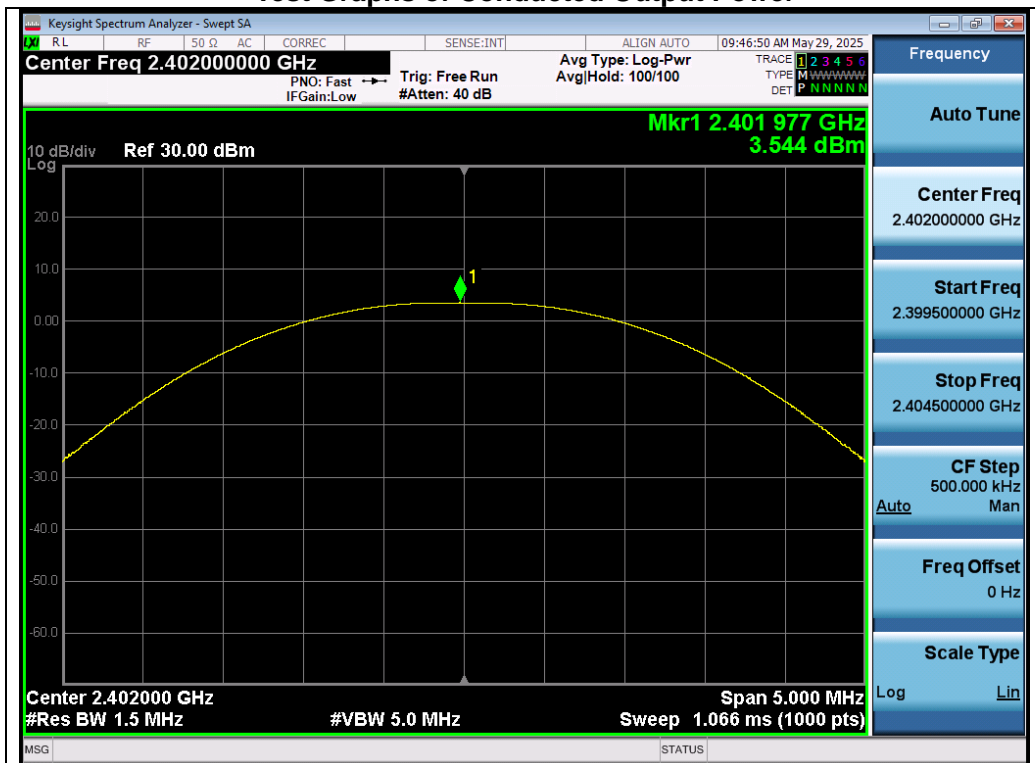

Test\_Graph\_BR\_ANT1\_2402\_1Mbps\_Peak Power

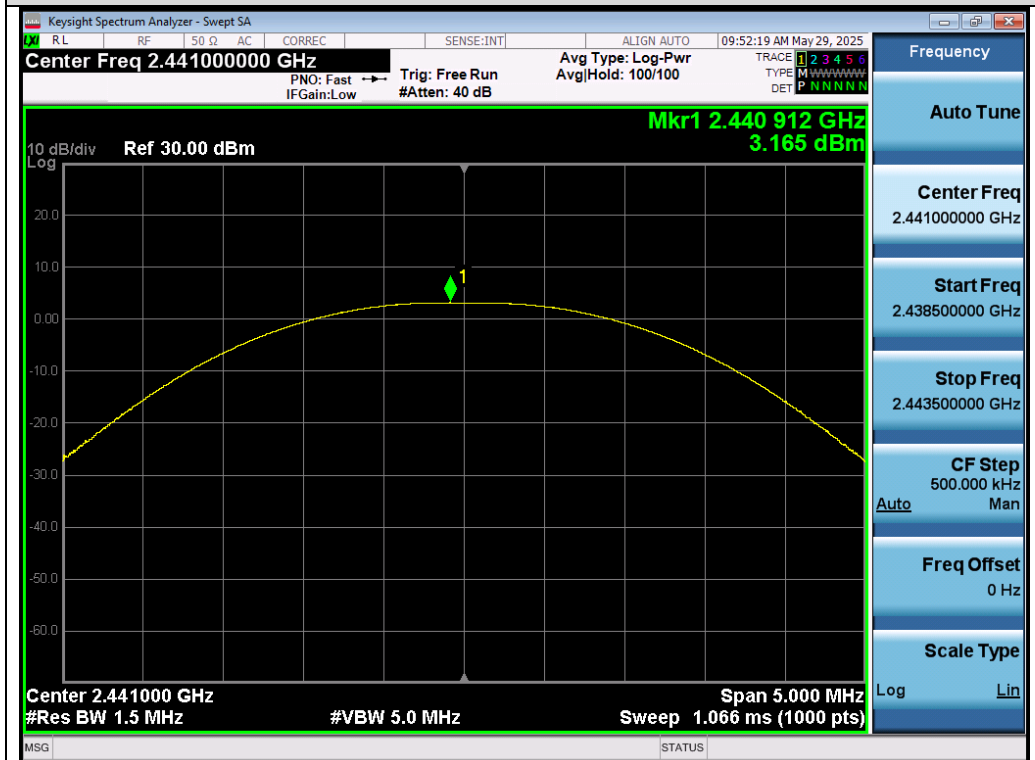

Test\_Graph\_BR\_ANT1\_2441\_1Mbps\_Peak Power

Any report having not been signed by authorized approver, or having been altered without authorization, or having not been stamped by the "Dedicated Testing/Inspection Stamp" is deemed to be invalid. Copying or excerpting portion of, or altering the content of the report is not permitted without the written authorization of AGC. The test results presented in the report apply only to the tested sample. Any objections to report issued by AGC should be submitted to AGC within 15days after the issuance of the test report. Further enquiry of validity or verification of the test report should be addressed to AGC by agc01@agccert.com.

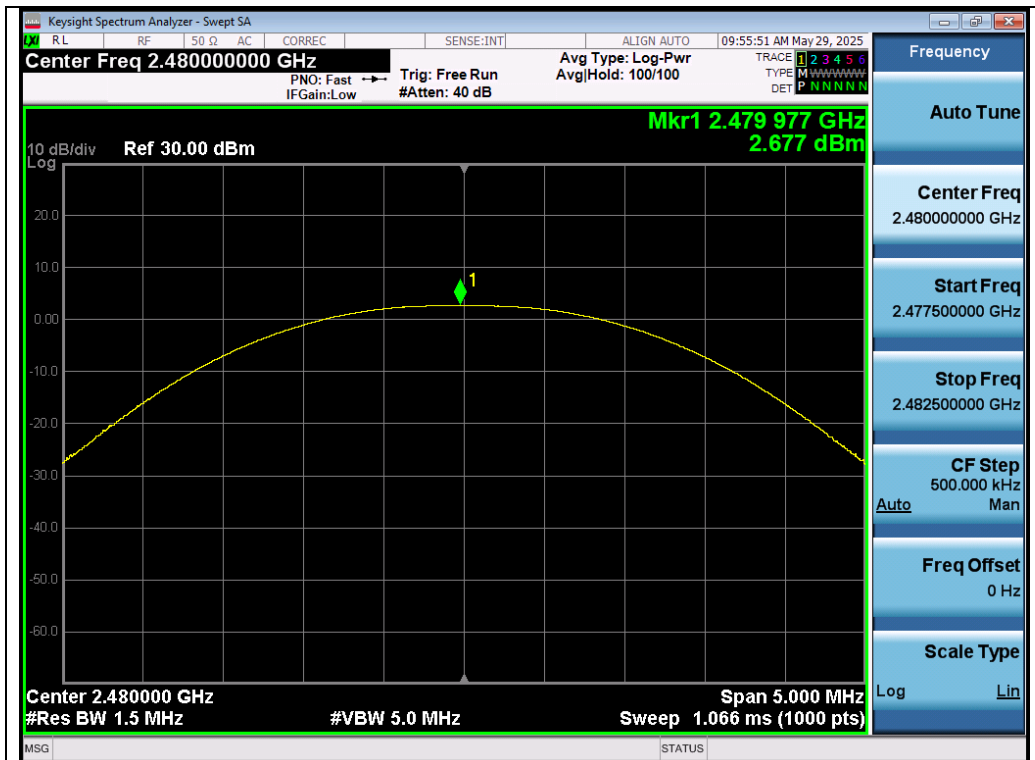

Test\_Graph\_BR\_ANT1\_2480\_1Mbps\_Peak Power

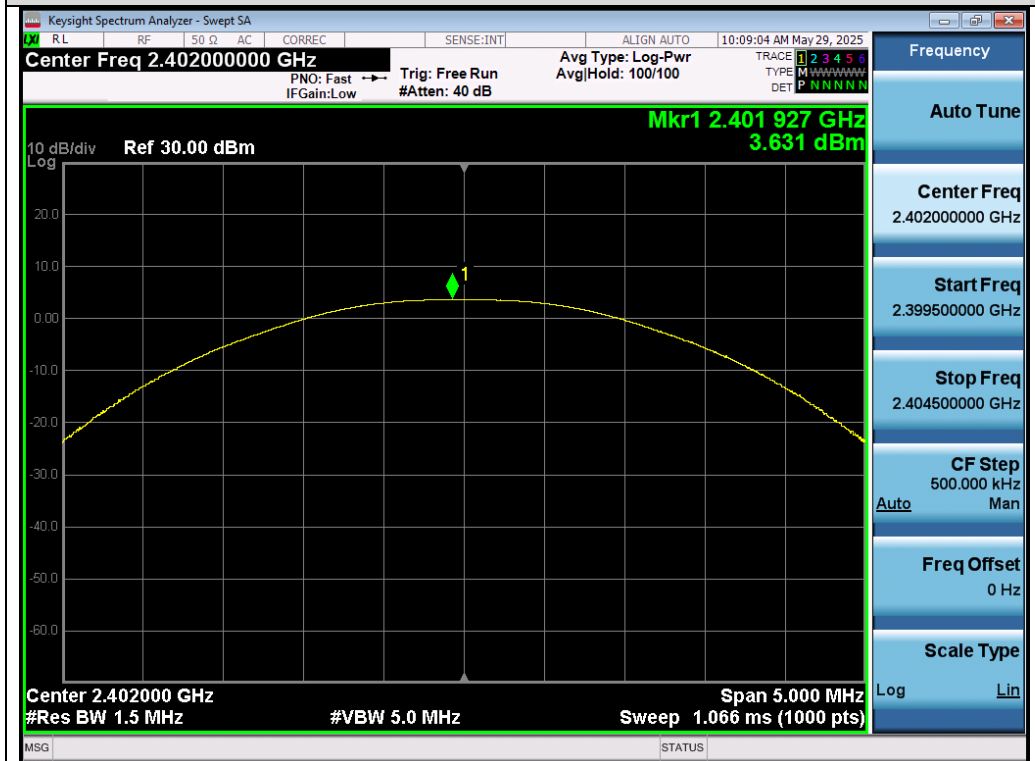

Test\_Graph\_EDR\_ANT1\_2402\_2Mbps\_Peak Power

Any report having not been signed by authorized approver, or having been altered without authorization, or having not been stamped by the "Dedicated Testing/Inspection Stamp" is deemed to be invalid. Copying or excerpting portion of, or altering the content of the report is not permitted without the written authorization of AGC. The test results presented in the report apply only to the tested sample. Any objections to report issued by AGC should be submitted to AGC within 15days after the issuance of the test report. Further enquiry of validity or verification of the test report should be addressed to AGC by agc01@agccert.com.



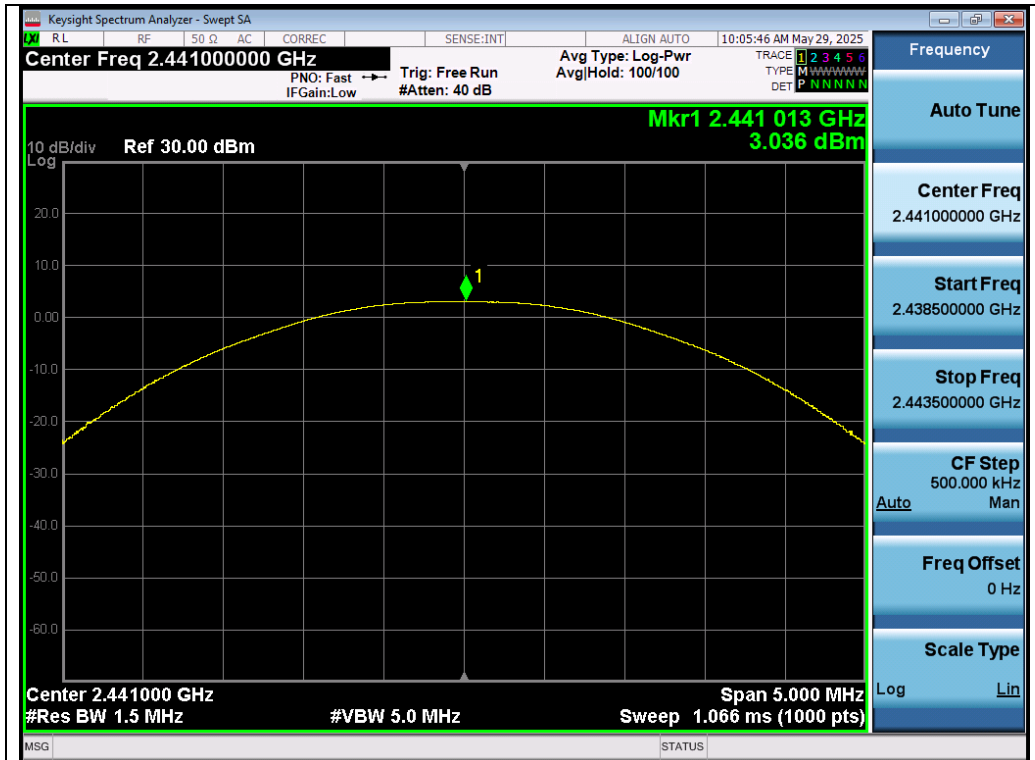

Test\_Graph\_EDR\_ANT1\_2441\_2Mbps\_Peak Power

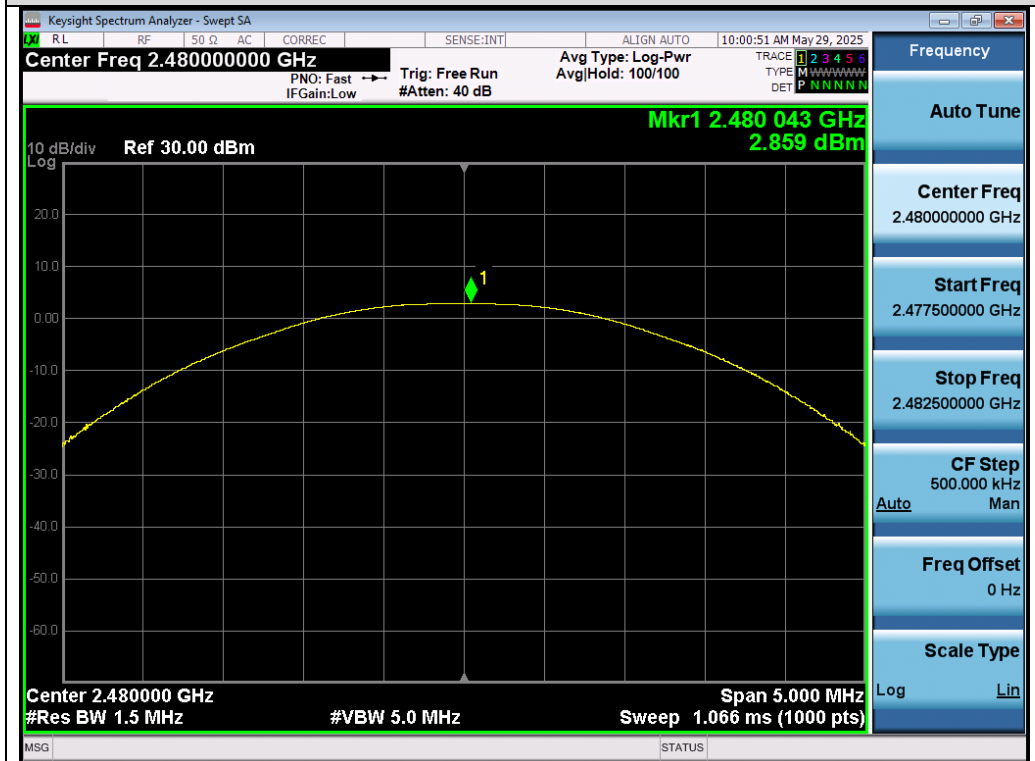

Test\_Graph\_EDR\_ANT1\_2480\_2Mbps\_Peak Power

Any report having not been signed by authorized approver, or having been altered without authorization, or having not been stamped by the "Dedicated Testing/Inspection Stamp" is deemed to be invalid. Copying or excerpting portion of, or altering the content of the report is not permitted without the written authorization of AGC. The test results presented in the report apply only to the tested sample. Any objections to report issued by AGC should be submitted to AGC within 15days after the issuance of the test report. Further enquiry of validity or verification of the test report should be addressed to AGC by agc01@agccert.com.



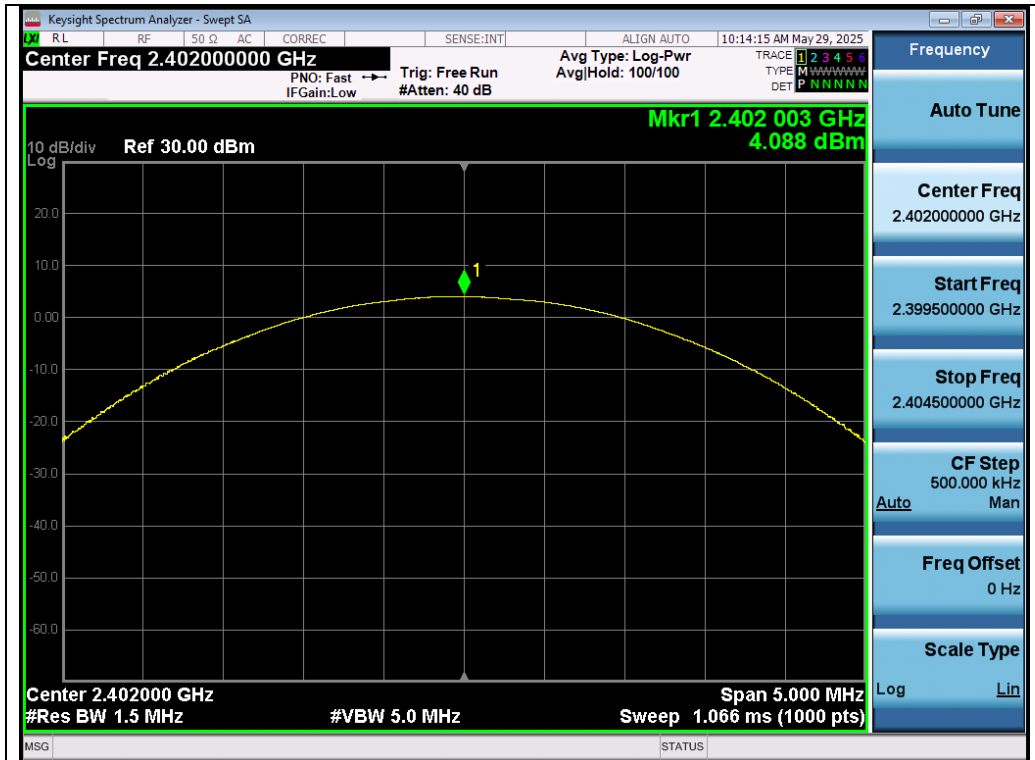

Test\_Graph\_EDR\_ANT1\_2402\_3Mbps\_Peak Power

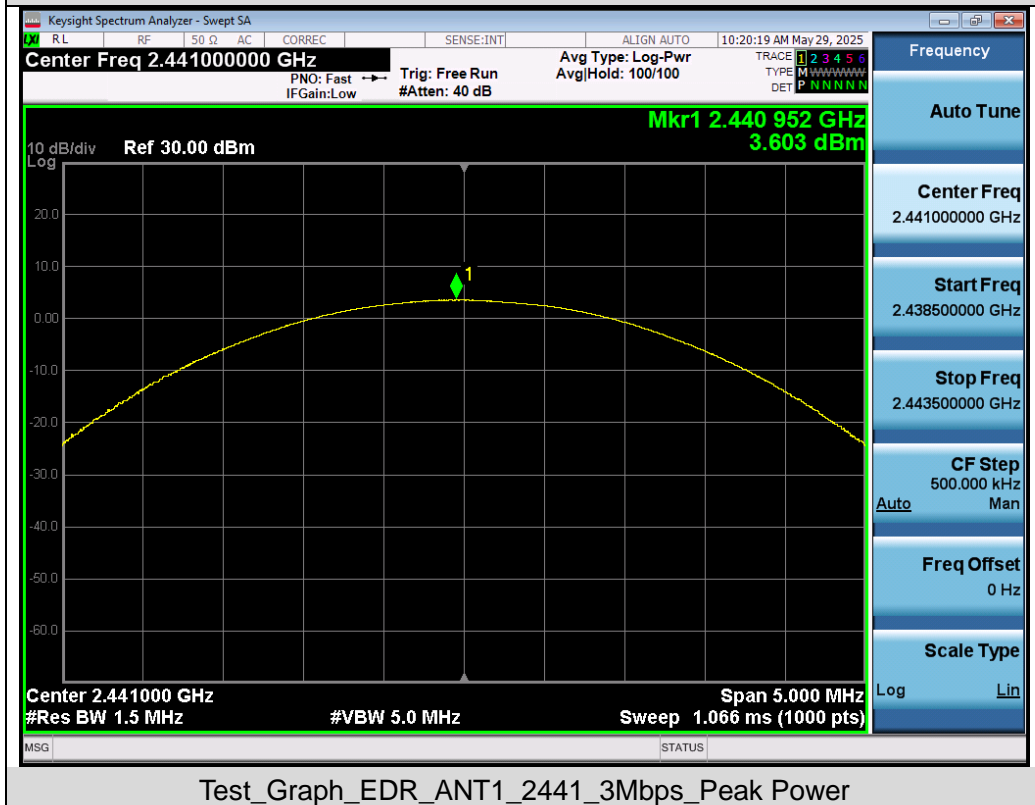

Test\_Graph\_EDR\_ANT1\_2441\_3Mbps\_Peak Power

Any report having not been signed by authorized approver, or having been altered without authorization, or having not been stamped by the "Dedicated Testing/Inspection Stamp" is deemed to be invalid. Copying or excerpting portion of, or altering the content of the report is not permitted without the written authorization of AGC. The test results presented in the report apply only to the tested sample. Any objections to report issued by AGC should be submitted to AGC within 15days after the issuance of the test report. Further enquiry of validity or verification of the test report should be addressed to AGC by agc01@agccert.com.

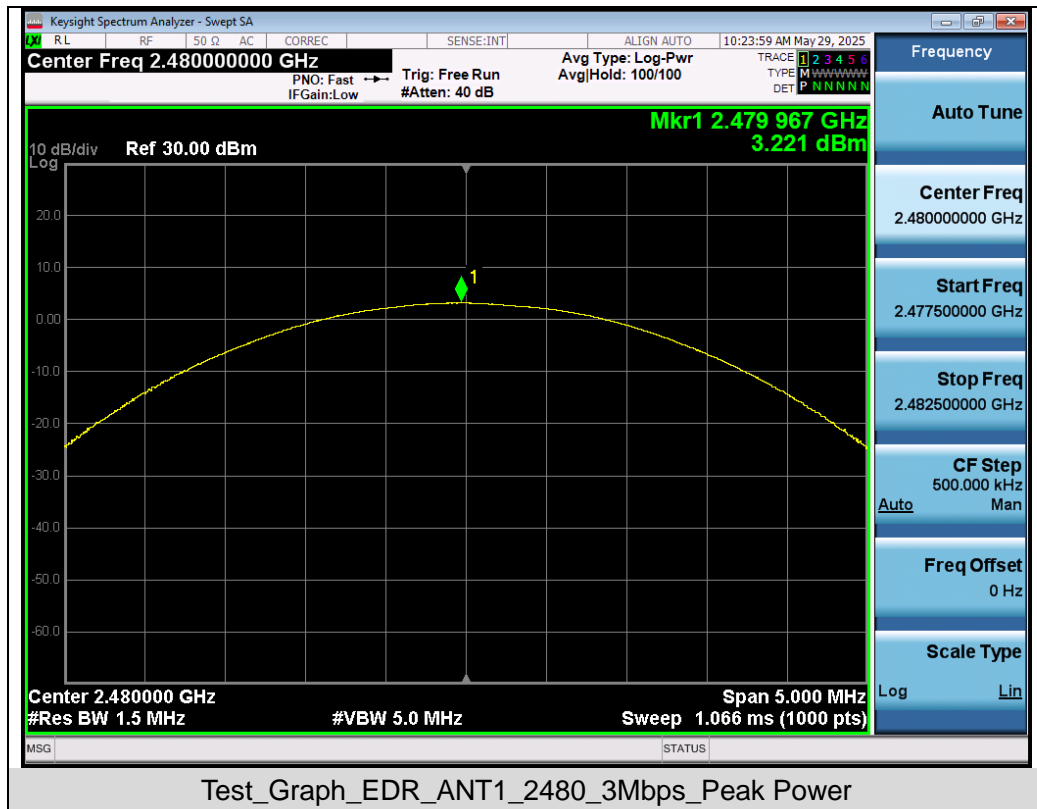

Any report having not been signed by authorized approver, or having been altered without authorization, or having not been stamped by the “Dedicated Testing/Inspection Stamp” is deemed to be invalid. Copying or excerpting portion of, or altering the content of the report is not permitted without the written authorization of AGC. The test results presented in the report apply only to the tested sample. Any objections to report issued by AGC should be submitted to AGC within 15days after the issuance of the test report. Further enquiry of validity or verification of the test report should be addressed to AGC by agc01@agccert.com.

Attestation of Global Compliance(Shenzhen)Co., Ltd  
 Attestation of Global Compliance(Shenzhen)Std & Tech Co., Ltd  
 Tel: +86-755 2523 4088 E-mail: agc@agccert.com Web: http://www.agccert.com/

## 7. 20dB Bandwidth and 99% Occupied Bandwidth Measurement

### 7.1 Provisions Applicable

There is no corresponding limit requirement for this test item.

### 7.2 Measurement Procedure

The testing follows the ANSI C63.10 Section 6.9.3 (OBW) and 6.9.2 (20dB BW).

- The 20dB bandwidth spectrum analyzer setting reference is as follows:
  1. Set RBW  $\geq$  1% to 5% of the 20dB bandwidth
  2. VBW = Approximately three times RBW
  3. Span = Approximately 2 to 5 times the 20dB bandwidth, centered on a hopping channel
  4. Detector = Peak
  5. Trace mode = Max hold
  6. Sweep = Auto couple
  7. Allow the trace to stabilize
  8. Measure the maximum width of the emission that is constrained by the frequencies associated
  9. with the two outermost amplitude points (upper and lower frequencies) that are attenuated by 20
  10. dB relative to the maximum level in the fundamental emission.
- The 99% bandwidth spectrum analyzer setting reference is as follows:
  1. Span = 1.5 times to 5 times the OBW
  2. Set RBW = 1% to 5% the OBW
  3. VBW  $\geq$  3  $\times$  RBW
  4. Detector = Peak
  5. Trace mode = Max hold
  6. Sweep = Auto couple
  7. Allow the trace was allowed to stabilize

### 7.3 Measurement Setup (Block Diagram of Configuration)

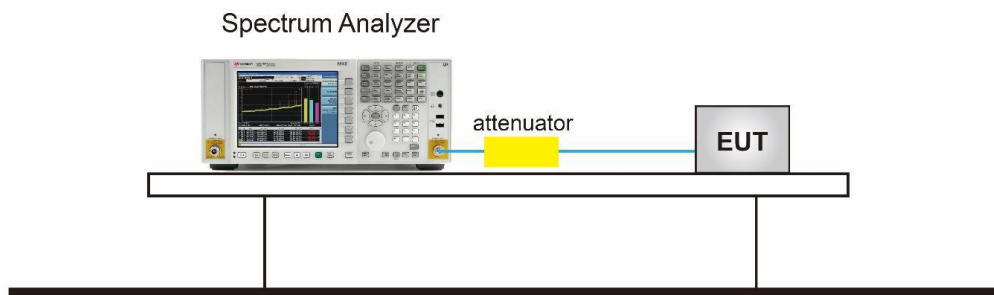

Any report having not been signed by authorized approver, or having been altered without authorization, or having not been stamped by the "Dedicated Testing/Inspection Stamp" is deemed to be invalid. Copying or excerpting portion of, or altering the content of the report is not permitted without the written authorization of AGC. The test results presented in the report apply only to the tested sample. Any objections to report issued by AGC should be submitted to AGC within 15days after the issuance of the test report. Further enquiry of validity or verification of the test report should be addressed to AGC by [agc01@agccert.com](mailto:agc01@agccert.com).

### 7.4 Measurement Results

Test Data of Occupied Bandwidth and -20dB Bandwidth					
Test Mode	Test Frequency (MHz)	99% Occupied Bandwidth (MHz)	-20dB Bandwidth (MHz)	Limits	Pass or Fail
GFSK	2402	0.859	0.961	N/A	Pass
	2441	0.859	0.962	N/A	Pass
	2480	0.859	0.962	N/A	Pass
π /4-DQPSK	2402	1.134	1.223	N/A	Pass
	2441	1.134	1.225	N/A	Pass
	2480	1.135	1.226	N/A	Pass
8DPSK	2402	1.141	1.265	N/A	Pass
	2441	1.141	1.265	N/A	Pass
	2480	1.142	1.264	N/A	Pass

### Test Graphs of Occupied Bandwidth and -20 Bandwidth

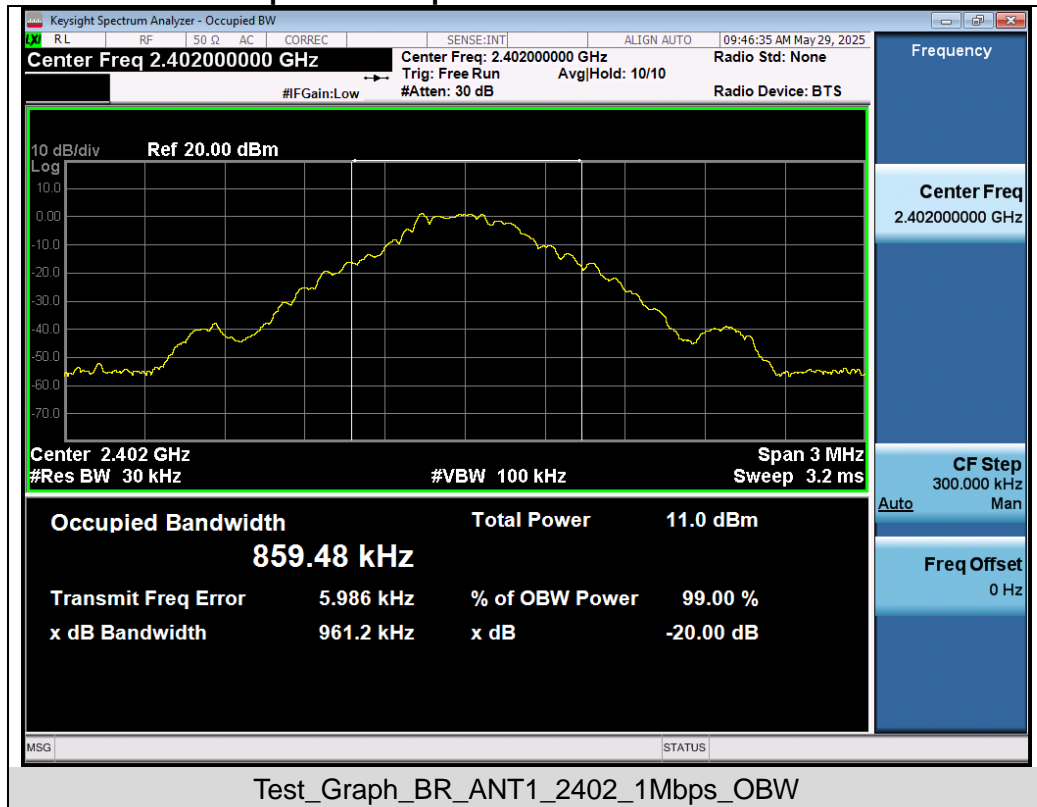

Any report having not been signed by authorized approver, or having been altered without authorization, or having not been stamped by the "Dedicated Testing/Inspection Stamp" is deemed to be invalid. Copying or excerpting portion of, or altering the content of the report is not permitted without the written authorization of AGC. The test results presented in the report apply only to the tested sample. Any objections to report issued by AGC should be submitted to AGC within 15days after the issuance of the test report. Further enquiry of validity or verification of the test report should be addressed to AGC by agc01@agccert.com.

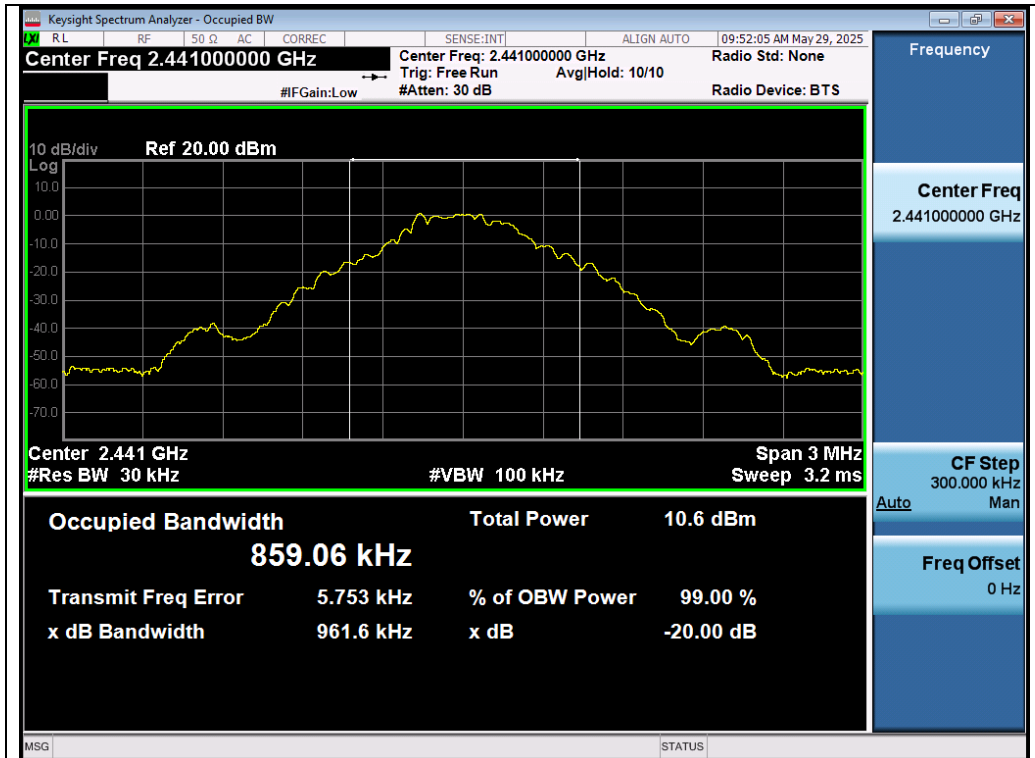

Test\_Graph\_BR\_ANT1\_2441\_1Mbps\_OBW

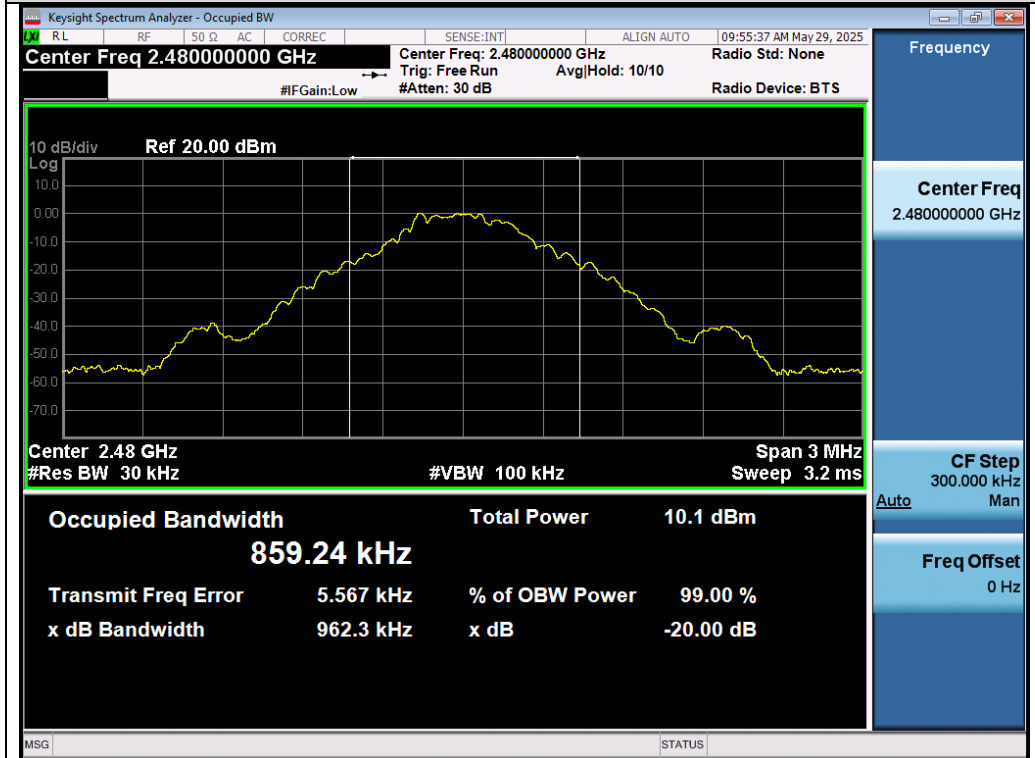

Test\_Graph\_BR\_ANT1\_2480\_1Mbps\_OBW

Any report having not been signed by authorized approver, or having been altered without authorization, or having not been stamped by the "Dedicated Testing/Inspection Stamp" is deemed to be invalid. Copying or excerpting portion of, or altering the content of the report is not permitted without the written authorization of AGC. The test results presented in the report apply only to the tested sample. Any objections to report issued by AGC should be submitted to AGC within 15days after the issuance of the test report. Further enquiry of validity or verification of the test report should be addressed to AGC by agc01@agccert.com.

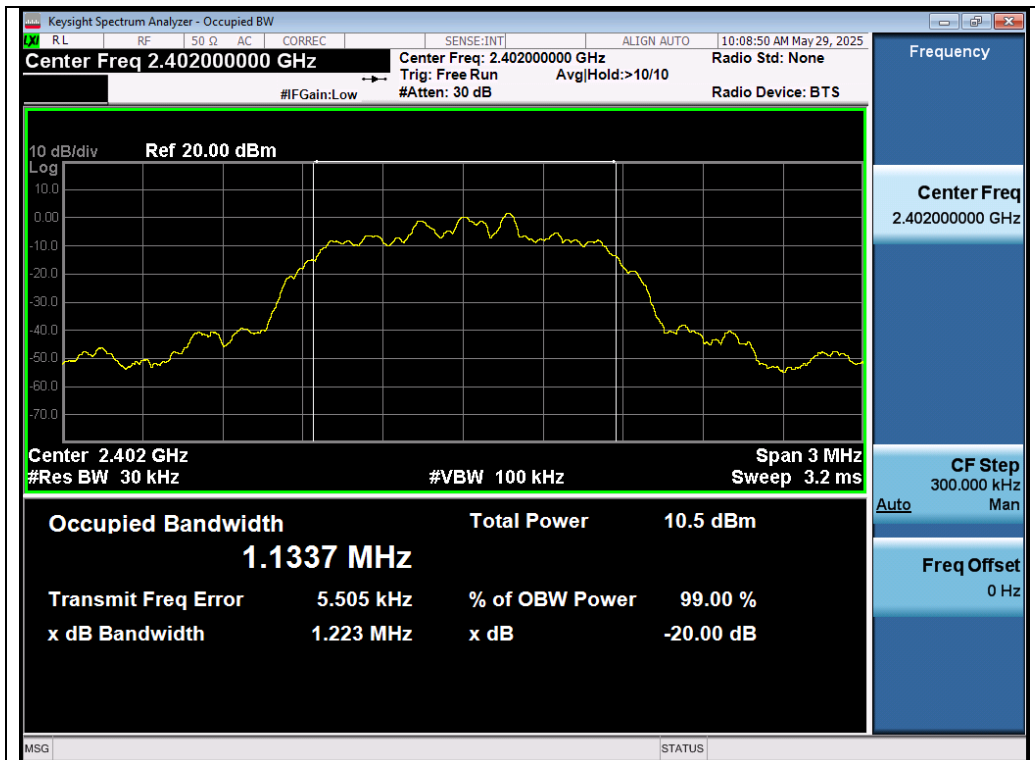

Test\_Graph\_EDR\_ANT1\_2402\_2Mbps\_OBW

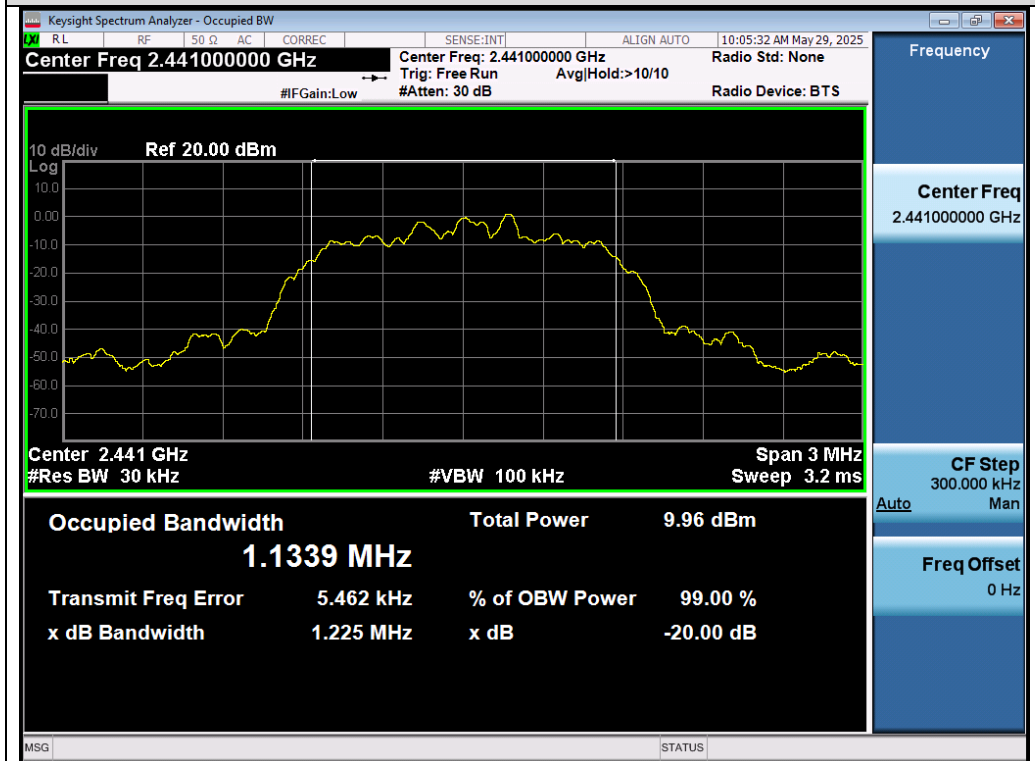

Test\_Graph\_EDR\_ANT1\_2441\_2Mbps\_OBW

Any report having not been signed by authorized approver, or having been altered without authorization, or having not been stamped by the "Dedicated Testing/Inspection Stamp" is deemed to be invalid. Copying or excerpting portion of, or altering the content of the report is not permitted without the written authorization of AGC. The test results presented in the report apply only to the tested sample. Any objections to report issued by AGC should be submitted to AGC within 15days after the issuance of the test report. Further enquiry of validity or verification of the test report should be addressed to AGC by agc01@agccert.com.



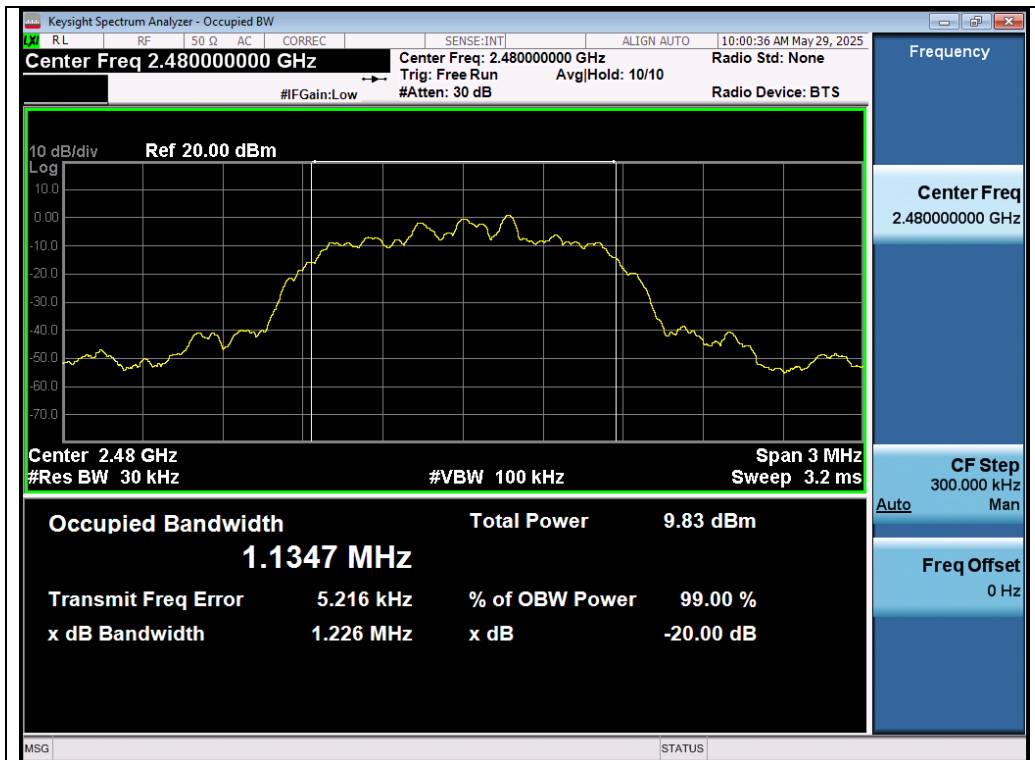

Test\_Graph\_EDR\_ANT1\_2480\_2Mbps\_OBW

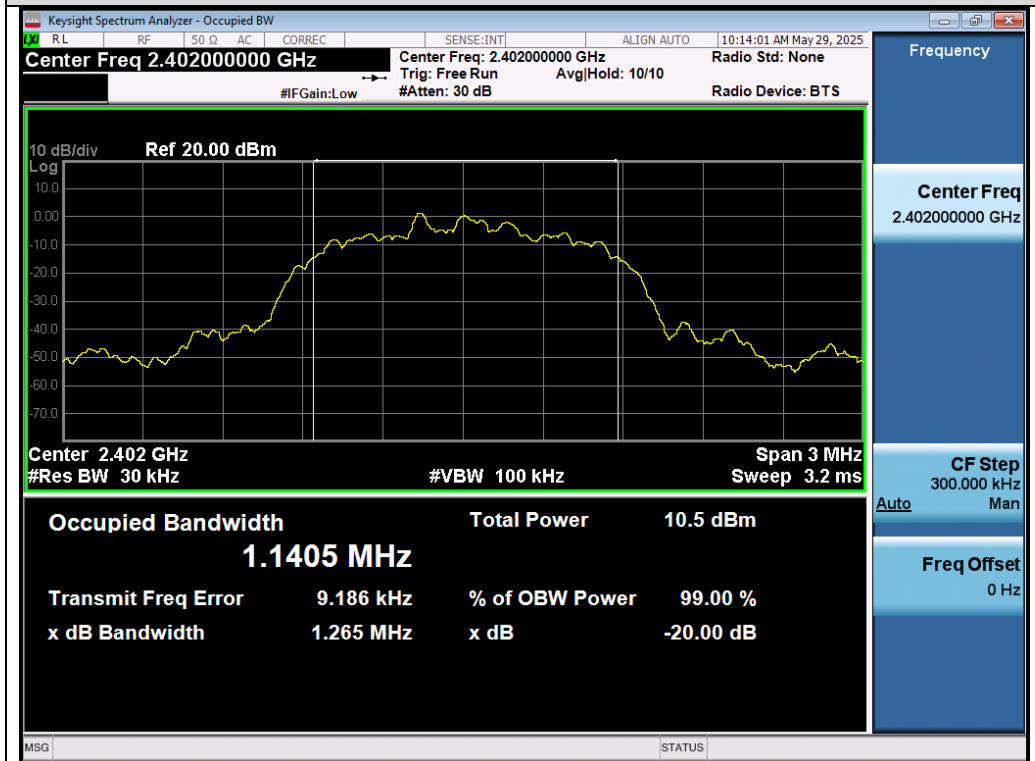

Test\_Graph\_EDR\_ANT1\_2402\_3Mbps\_OBW

Any report having not been signed by authorized approver, or having been altered without authorization, or having not been stamped by the "Dedicated Testing/Inspection Stamp" is deemed to be invalid. Copying or excerpting portion of, or altering the content of the report is not permitted without the written authorization of AGC. The test results presented in the report apply only to the tested sample. Any objections to report issued by AGC should be submitted to AGC within 15days after the issuance of the test report. Further enquiry of validity or verification of the test report should be addressed to AGC by agc01@agccert.com.



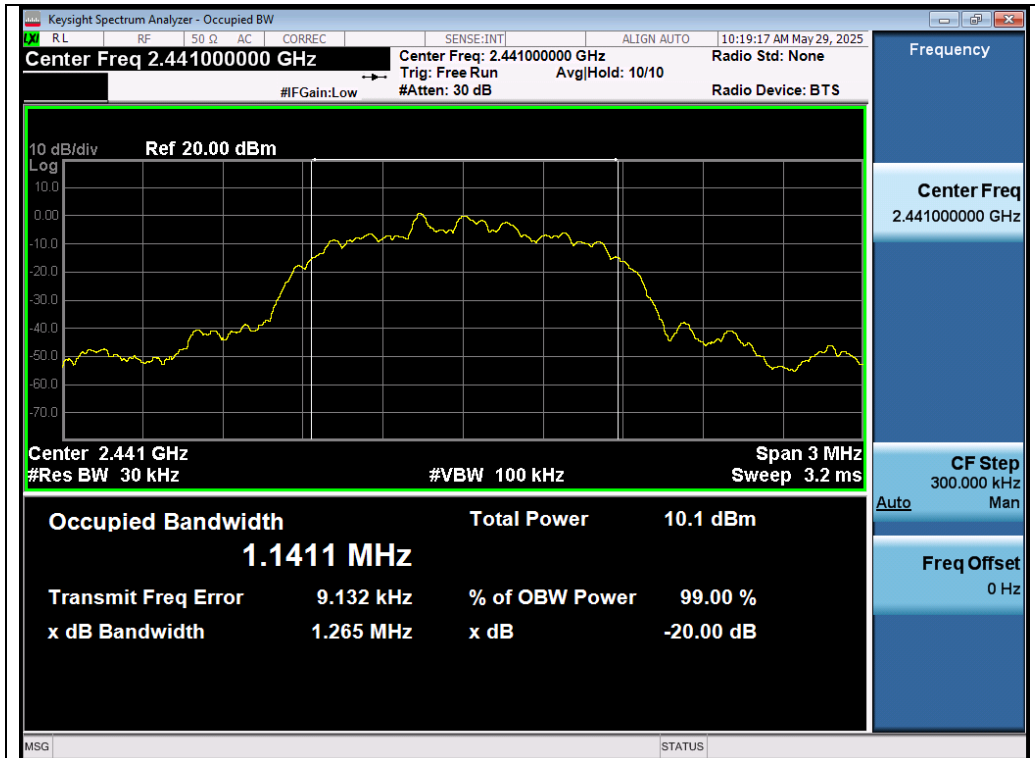

Test\_Graph\_EDR\_ANT1\_2441\_3Mbps\_OBW

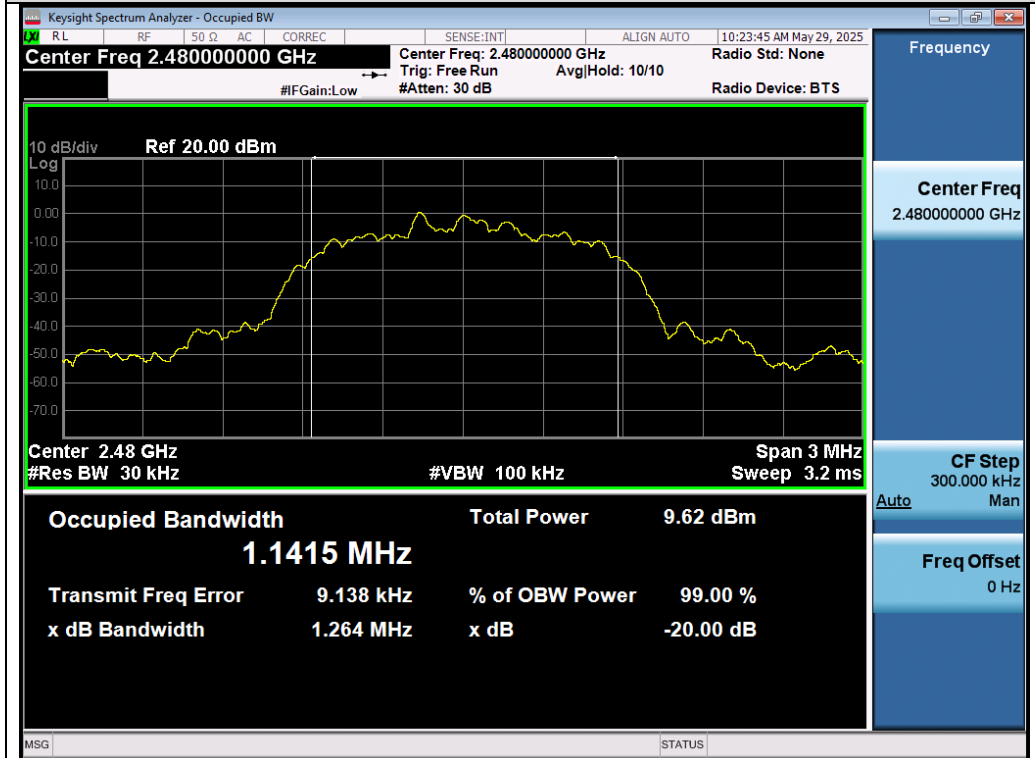

Test\_Graph\_EDR\_ANT1\_2480\_3Mbps\_OBW

Any report having not been signed by authorized approver, or having been altered without authorization, or having not been stamped by the "Dedicated Testing/Inspection Stamp" is deemed to be invalid. Copying or excerpting portion of, or altering the content of the report is not permitted without the written authorization of AGC. The test results presented in the report apply only to the tested sample. Any objections to report issued by AGC should be submitted to AGC within 15days after the issuance of the test report. Further enquiry of validity or verification of the test report should be addressed to AGC by agc01@agccert.com.

## 8. Conducted Band Edge and Out-of-Band Emissions

### 8.1 Provisions Applicable

In any 100 kHz bandwidth outside the frequency band in which the spread spectrum or digitally modulated intentional radiator is operating, the radio frequency power that is produced by the intentional radiator shall be at least 20 dB below that in the 100 kHz bandwidth within the band that contains the highest level of the desired power, based on either an RF conducted or a radiated measurement, provided the transmitter demonstrates compliance with the peak conducted or a radiated measurement, provided the transmitter demonstrates compliance with the peak conducted power limits. If the transmitter complies with the conducted power limits based on the use of RMS averaging over a time interval, the attenuation required under this paragraph shall be 30dB instead of 20dB

### 8.2 Measurement Procedure

The testing follows the ANSI C63.10 Section 6.10.4 and 7.8.8:

- Reference level measurement
  1. Span = Wide enough to capture the peak level of the emission operating on the channel closest to the band edge, as well as any modulation products which fall outside of the authorized band of operation.
  2. RBW = 100kHz
  3. VBW = 300kHz
  4. Detector = Peak
  5. Sweep time = Auto couple
  6. Trace mode = Max hold
  7. Allow the trace to stabilize. Set the marker on the emission at the band edge, or on the highest modulation product outside of the band, if this level is greater than that at the band edge. Enable the marker-delta function, then use the marker-to-peak function to move the marker to the peak of the in-band emission.
  8. Input compensation coefficient (dB) = Cable Loss (dB) + Attenuator attenuation value (dB)
- Emission level measurement
  1. Span = Wide enough to capture the peak level of the in-band emission and all spurious emissions (e.g., harmonics) from the lowest frequency generated in the EUT up through the 10th harmonic. Typically, several plots are required to cover this entire span.
  2. RBW = 100kHz
  3. VBW = 300kHz
  4. Detector = Peak
  5. Sweep time = Auto couple
  6. Trace mode = Max hold
  7. Trace was allowed to stabilize
  8. Set the marker on the peak of any spurious emission recorded. The level displayed must comply with the limit specified in this section.
  9. Input compensation coefficient (dB) = Cable Loss (dB) + Attenuator attenuation value (dB)

### 8.3 Measurement Setup (Block Diagram of Configuration)

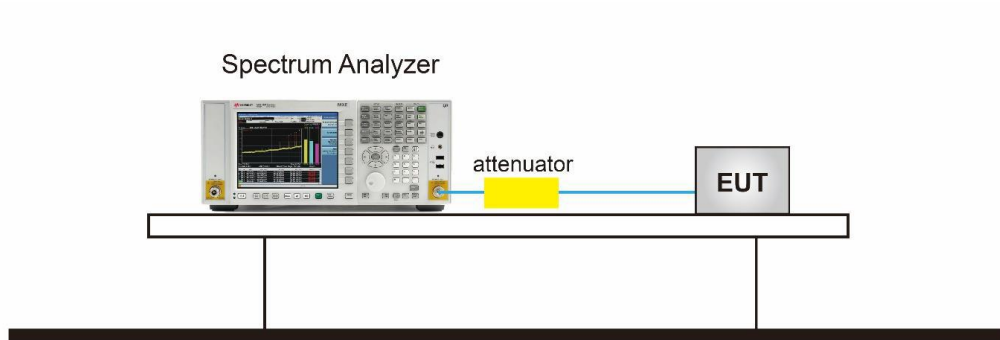

Any report having not been signed by authorized approver, or having been altered without authorization, or having not been stamped by the “Dedicated Testing/Inspection Stamp” is deemed to be invalid. Copying or excerpting portion of, or altering the content of the report is not permitted without the written authorization of AGC. The test results presented in the report apply only to the tested sample. Any objections to report issued by AGC should be submitted to AGC within 15days after the issuance of the test report. Further enquiry of validity or verification of the test report should be addressed to AGC by [agc01@agccert.com](mailto:agc01@agccert.com).

Attestation of Global Compliance(Shenzhen)Co., Ltd  
Attestation of Global Compliance(Shenzhen)Std & Tech Co., Ltd  
Tel: +86-755 2523 4088 E-mail: [agc@agccert.com](mailto:agc@agccert.com) Web: <http://www.agccert.com/>

### 8.4 Measurement Results

#### Test Graphs of Spurious Emissions in Non-Restricted Frequency Bands

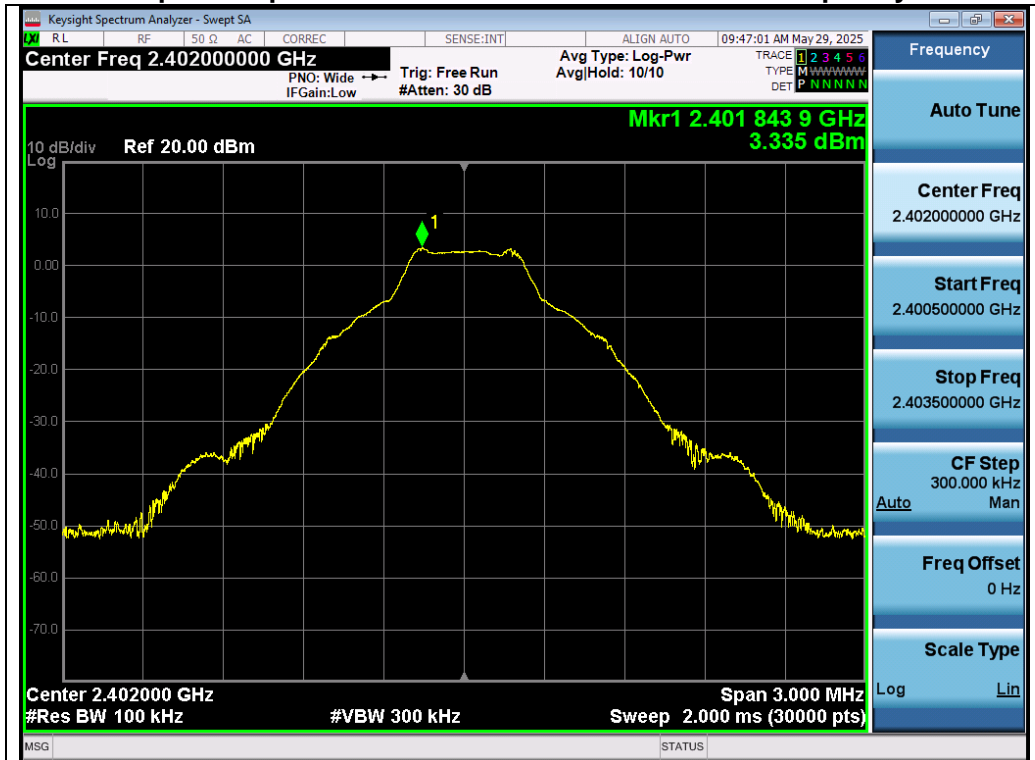

Test\_Graph\_BR\_ANT1\_2402\_1Mbps\_Reference Level

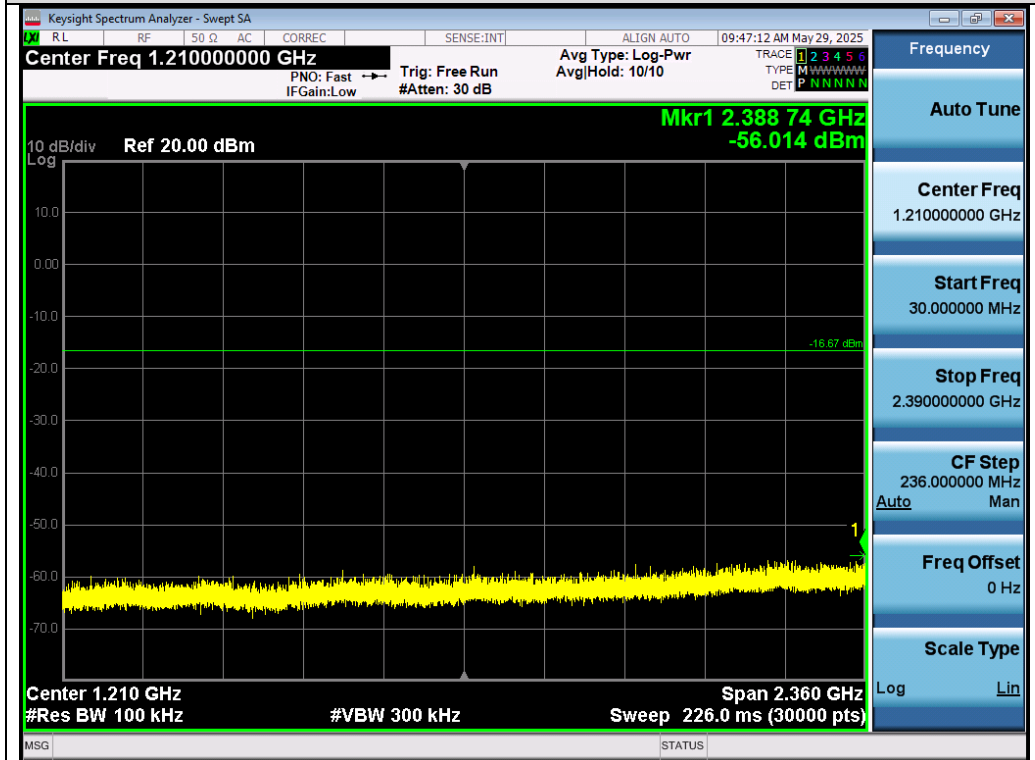

Test\_Graph\_BR\_ANT1\_2402\_1Mbps\_Lower Band Emissions

Any report having not been signed by authorized approver, or having been altered without authorization, or having not been stamped by the "Dedicated Testing/Inspection Stamp" is deemed to be invalid. Copying or excerpting portion of, or altering the content of the report is not permitted without the written authorization of AGC. The test results presented in the report apply only to the tested sample. Any objections to report issued by AGC should be submitted to AGC within 15days after the issuance of the test report. Further enquiry of validity or verification of the test report should be addressed to AGC by agc01@agccert.com.



Test\_Graph\_BR\_ANT1\_2402\_1Mbps\_Higher Band Emissions



Test\_Graph\_BR\_ANT1\_2441\_1Mbps\_Reference Level

Any report having not been signed by authorized approver, or having been altered without authorization, or having not been stamped by the "Dedicated Testing/Inspection Stamp" is deemed to be invalid. Copying or excerpting portion of, or altering the content of the report is not permitted without the written authorization of AGC. The test results presented in the report apply only to the tested sample. Any objections to report issued by AGC should be submitted to AGC within 15days after the issuance of the test report. Further enquiry of validity or verification of the test report should be addressed to AGC by agc01@agccert.com.

Attestation of Global Compliance(Shenzhen)Co., Ltd  
Attestation of Global Compliance(Shenzhen)Std & Tech Co., Ltd  
Tel: +86-755 2523 4088 E-mail: agc@agccert.com Web: http://www.agccert.com/

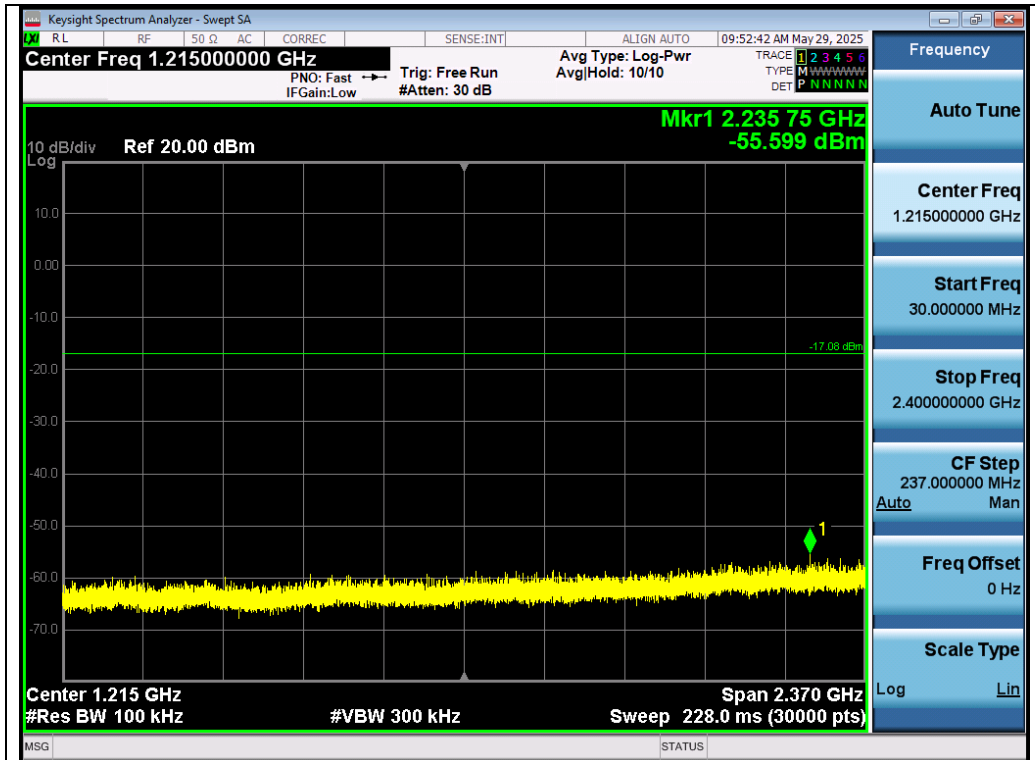

Any report having not been signed by authorized approver, or having been altered without authorization, or having not been stamped by the "Dedicated Testing/Inspection Stamp" is deemed to be invalid. Copying or excerpting portion of, or altering the content of the report is not permitted without the written authorization of AGC. The test results presented in the report apply only to the tested sample. Any objections to report issued by AGC should be submitted to AGC within 15days after the issuance of the test report. Further enquiry of validity or verification of the test report should be addressed to AGC by agc01@agccert.com.

Attestation of Global Compliance(Shenzhen)Co., Ltd  
 Attestation of Global Compliance(Shenzhen)Std & Tech Co., Ltd  
 Tel: +86-755 2523 4088 E-mail: agc@agccert.com Web: http://www.agccert.com/



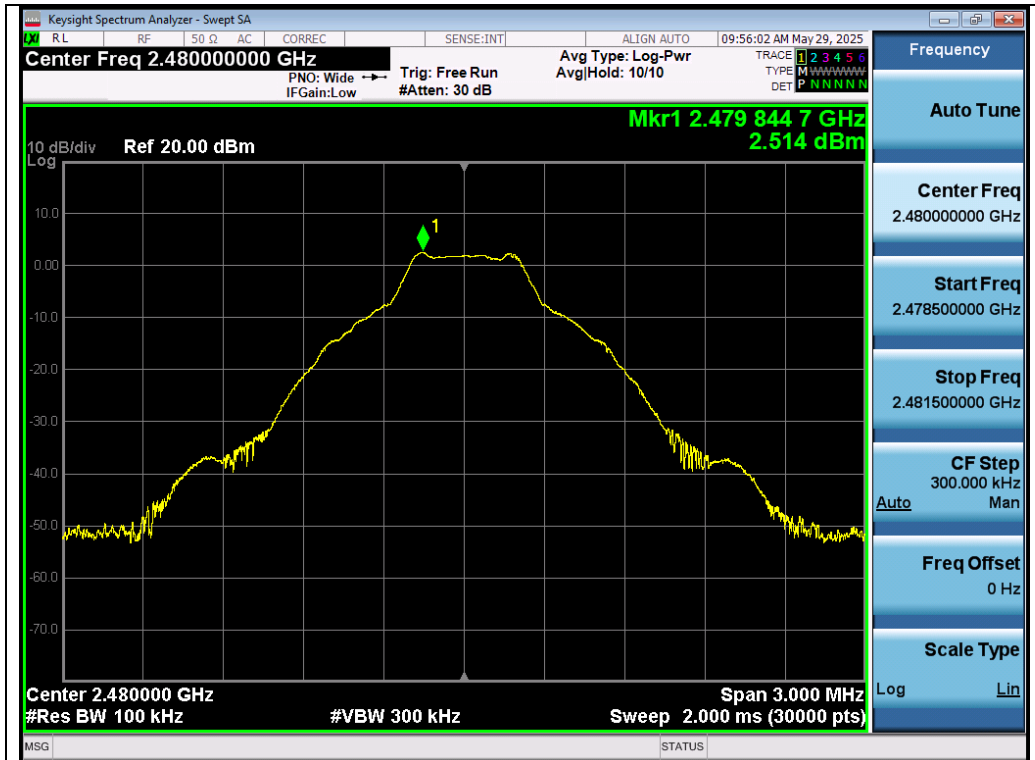

Test\_Graph\_BR\_ANT1\_2480\_1Mbps\_Reference Level

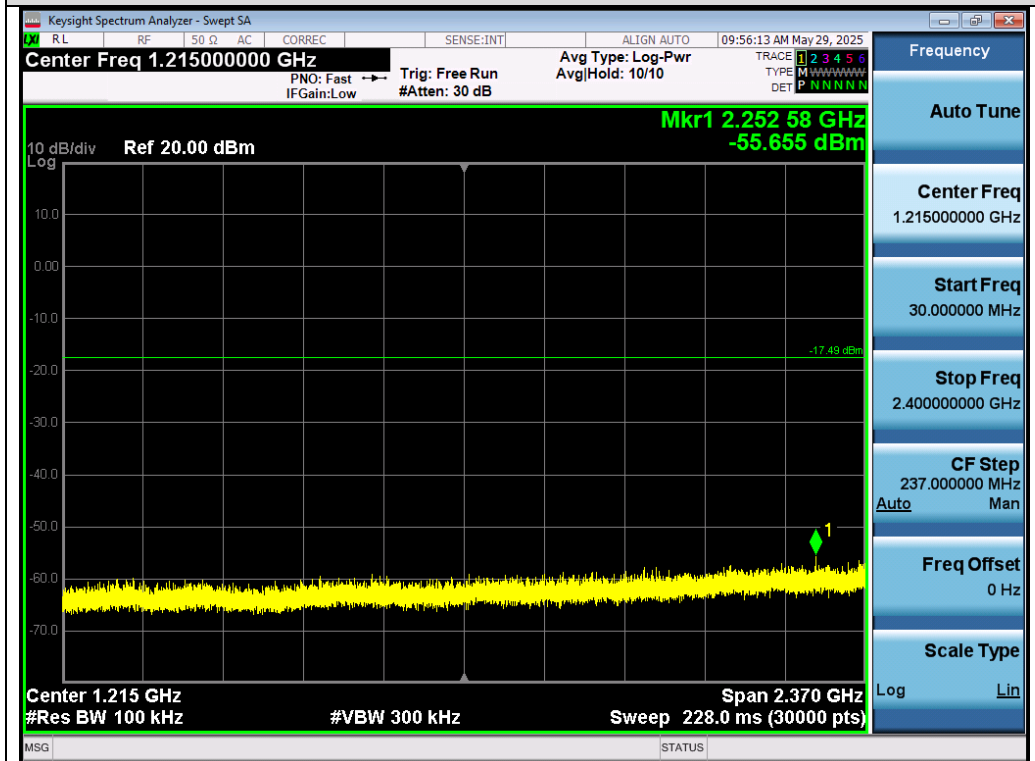

Test\_Graph\_BR\_ANT1\_2480\_1Mbps\_Lower Band Emissions

Any report having not been signed by authorized approver, or having been altered without authorization, or having not been stamped by the "Dedicated Testing/Inspection Stamp" is deemed to be invalid. Copying or excerpting portion of, or altering the content of the report is not permitted without the written authorization of AGC. The test results presented in the report apply only to the tested sample. Any objections to report issued by AGC should be submitted to AGC within 15days after the issuance of the test report. Further enquiry of validity or verification of the test report should be addressed to AGC by agc01@agccert.com.



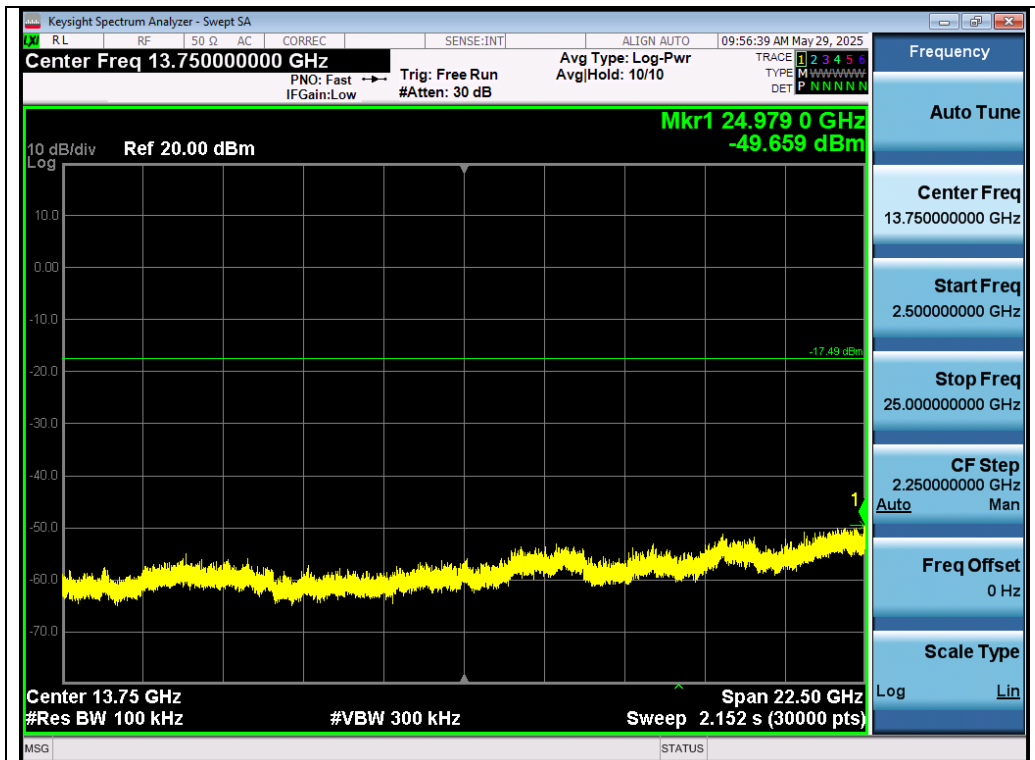

Test\_Graph\_BR\_ANT1\_2480\_1Mbps\_Higher Band Emissions



Test\_Graph\_EDR\_ANT1\_2402\_2Mbps\_Reference Level

Any report having not been signed by authorized approver, or having been altered without authorization, or having not been stamped by the "Dedicated Testing/Inspection Stamp" is deemed to be invalid. Copying or excerpting portion of, or altering the content of the report is not permitted without the written authorization of AGC. The test results presented in the report apply only to the tested sample. Any objections to report issued by AGC should be submitted to AGC within 15days after the issuance of the test report. Further enquiry of validity or verification of the test report should be addressed to AGC by agc01@agccert.com.

Attestation of Global Compliance(Shenzhen)Co., Ltd  
Attestation of Global Compliance(Shenzhen)Std & Tech Co., Ltd  
Tel: +86-755 2523 4088 E-mail: agc@agccert.com Web: http://www.agccert.com/

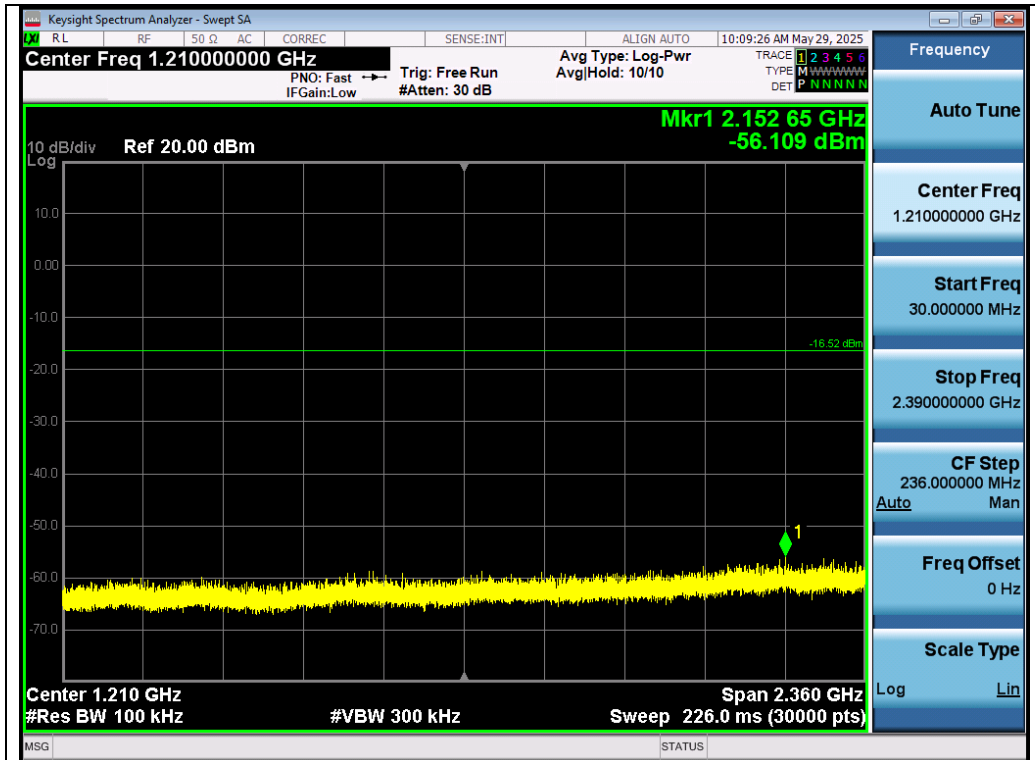

Test\_Graph\_EDR\_ANT1\_2402\_2Mbps\_Lower Band Emissions

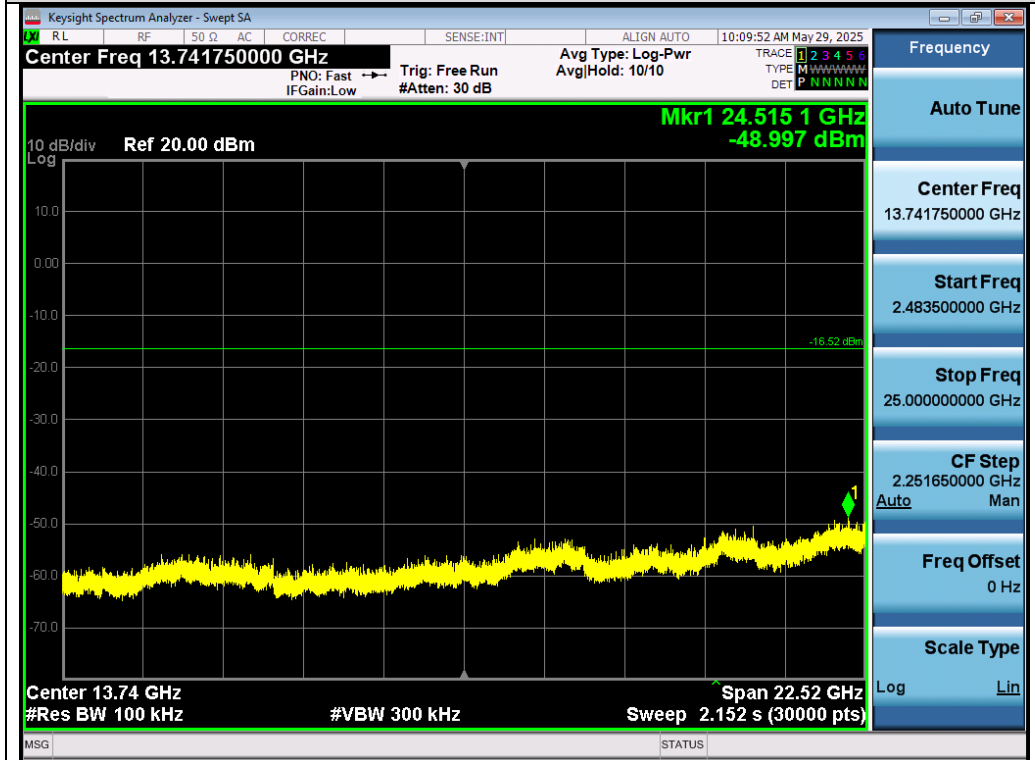

Test\_Graph\_EDR\_ANT1\_2402\_2Mbps\_Higher Band Emissions

Any report having not been signed by authorized approver, or having been altered without authorization, or having not been stamped by the "Dedicated Testing/Inspection Stamp" is deemed to be invalid. Copying or excerpting portion of, or altering the content of the report is not permitted without the written authorization of AGC. The test results presented in the report apply only to the tested sample. Any objections to report issued by AGC should be submitted to AGC within 15days after the issuance of the test report. Further enquiry of validity or verification of the test report should be addressed to AGC by agc01@agccert.com.

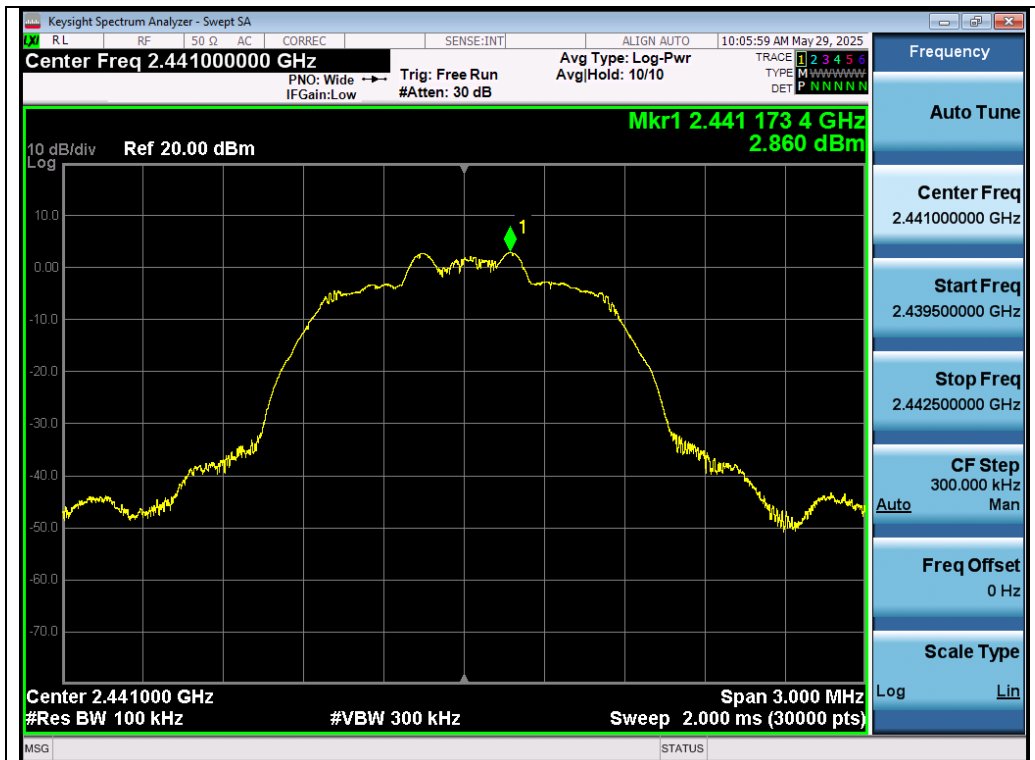

Test\_Graph\_EDR\_ANT1\_2441\_2Mbps\_Reference Level

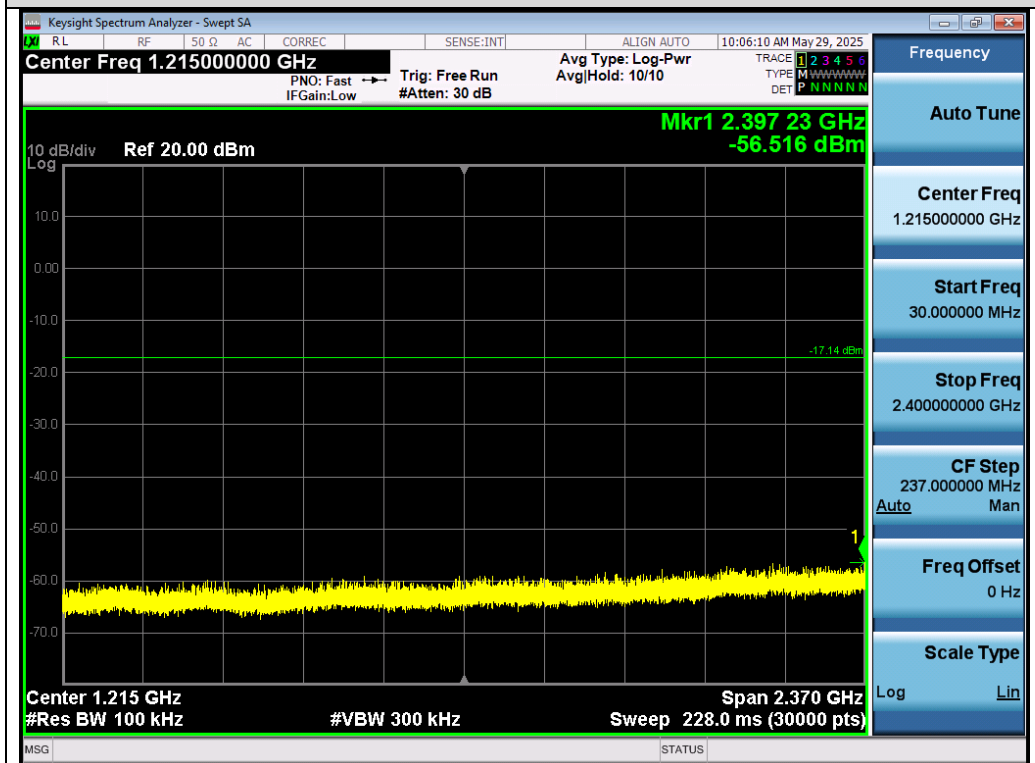

Test\_Graph\_EDR\_ANT1\_2441\_2Mbps\_Lower Band Emissions

Any report having not been signed by authorized approver, or having been altered without authorization, or having not been stamped by the "Dedicated Testing/Inspection Stamp" is deemed to be invalid. Copying or excerpting portion of, or altering the content of the report is not permitted without the written authorization of AGC. The test results presented in the report apply only to the tested sample. Any objections to report issued by AGC should be submitted to AGC within 15days after the issuance of the test report. Further enquiry of validity or verification of the test report should be addressed to AGC by agc01@agccert.com.

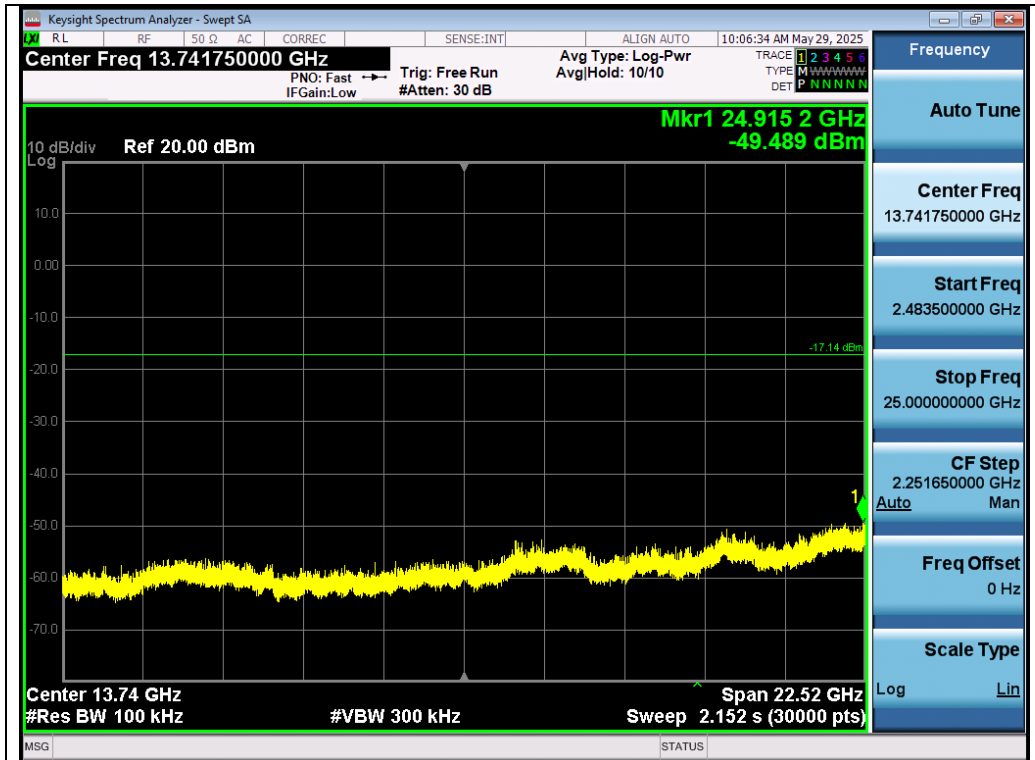

Test\_Graph\_EDR\_ANT1\_2441\_2Mbps\_Higher Band Emissions



Test\_Graph\_EDR\_ANT1\_2480\_2Mbps\_Reference Level

Any report having not been signed by authorized approver, or having been altered without authorization, or having not been stamped by the "Dedicated Testing/Inspection Stamp" is deemed to be invalid. Copying or excerpting portion of, or altering the content of the report is not permitted without the written authorization of AGC. The test results presented in the report apply only to the tested sample. Any objections to report issued by AGC should be submitted to AGC within 15days after the issuance of the test report. Further enquiry of validity or verification of the test report should be addressed to AGC by agc01@agccert.com.

Attestation of Global Compliance(Shenzhen)Co., Ltd  
Attestation of Global Compliance(Shenzhen)Std & Tech Co., Ltd  
Tel: +86-755 2523 4088 E-mail: agc@agccert.com Web: http://www.agccert.com/

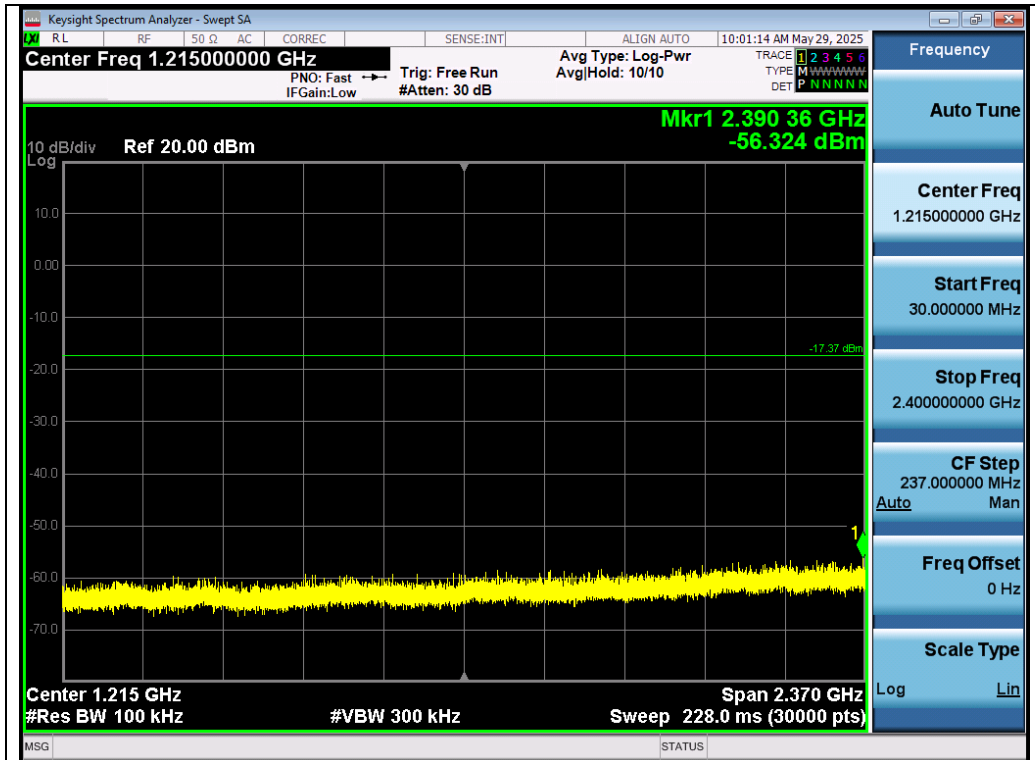

Test\_Graph\_EDR\_ANT1\_2480\_2Mbps\_Lower Band Emissions

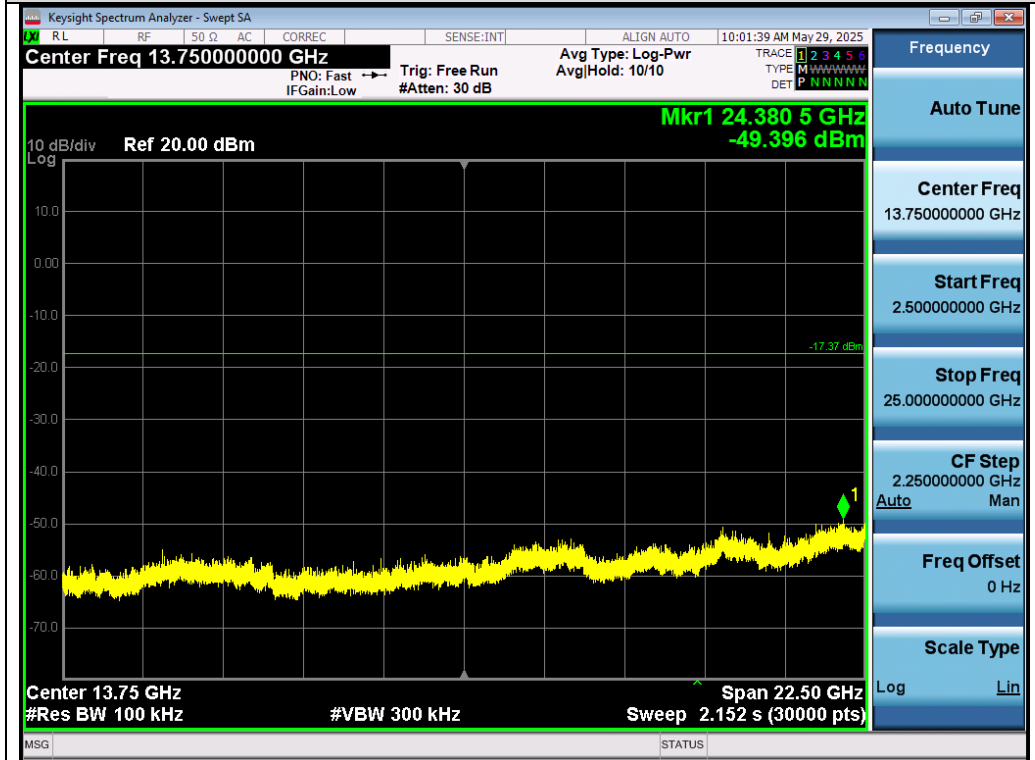

Test\_Graph\_EDR\_ANT1\_2480\_2Mbps\_Higher Band Emissions

Any report having not been signed by authorized approver, or having been altered without authorization, or having not been stamped by the "Dedicated Testing/Inspection Stamp" is deemed to be invalid. Copying or excerpting portion of, or altering the content of the report is not permitted without the written authorization of AGC. The test results presented in the report apply only to the tested sample. Any objections to report issued by AGC should be submitted to AGC within 15days after the issuance of the test report. Further enquiry of validity or verification of the test report should be addressed to AGC by agc01@agccert.com.





Test\_Graph\_EDR\_ANT1\_2402\_3Mbps\_Reference Level

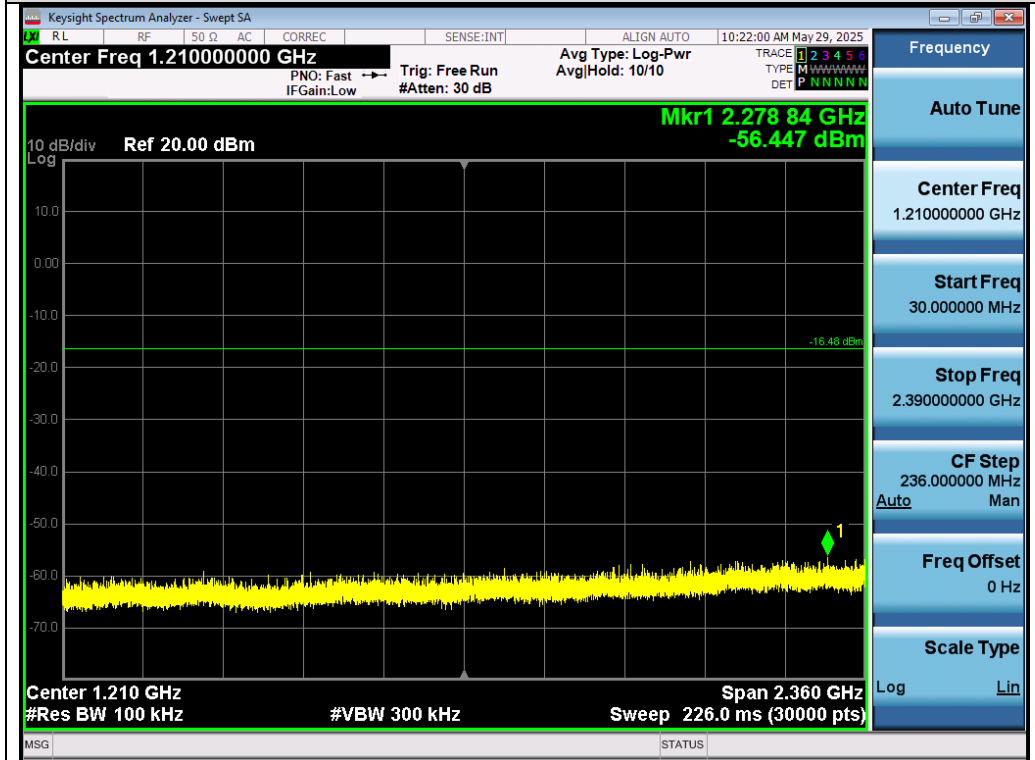

Test\_Graph\_EDR\_ANT1\_2402\_3Mbps\_Lower Band Emissions

Any report having not been signed by authorized approver, or having been altered without authorization, or having not been stamped by the "Dedicated Testing/Inspection Stamp" is deemed to be invalid. Copying or excerpting portion of, or altering the content of the report is not permitted without the written authorization of AGC. The test results presented in the report apply only to the tested sample. Any objections to report issued by AGC should be submitted to AGC within 15days after the issuance of the test report. Further enquiry of validity or verification of the test report should be addressed to AGC by agc01@agccert.com.

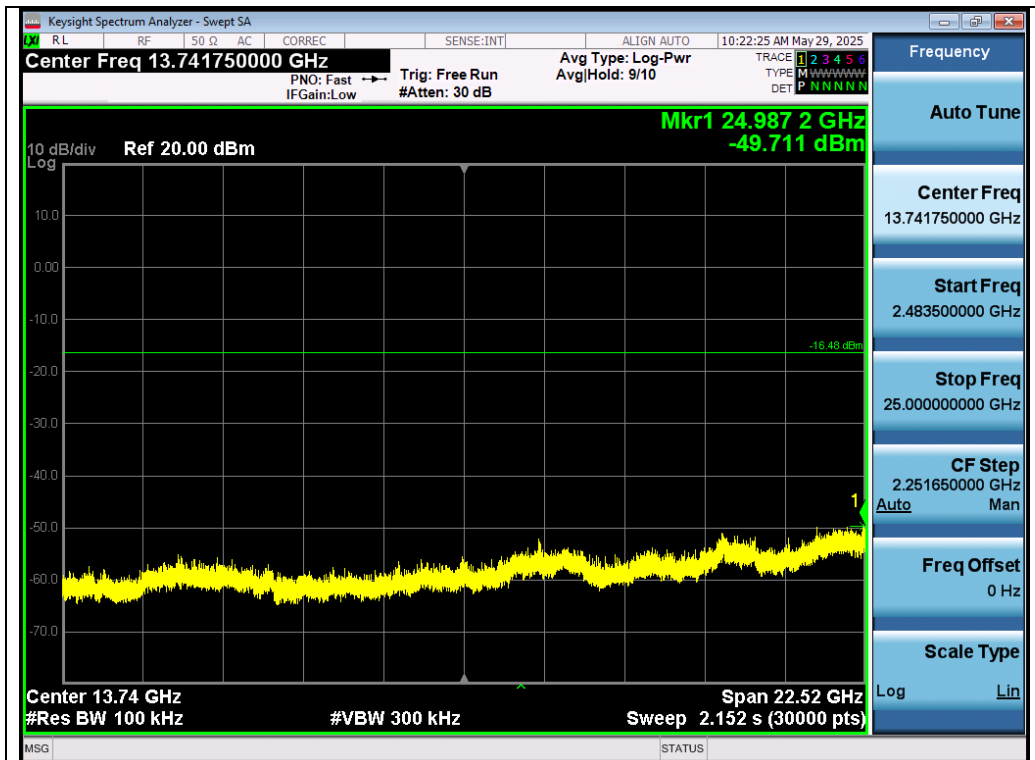

Test\_Graph\_EDR\_ANT1\_2402\_3Mbps\_Higher Band Emissions

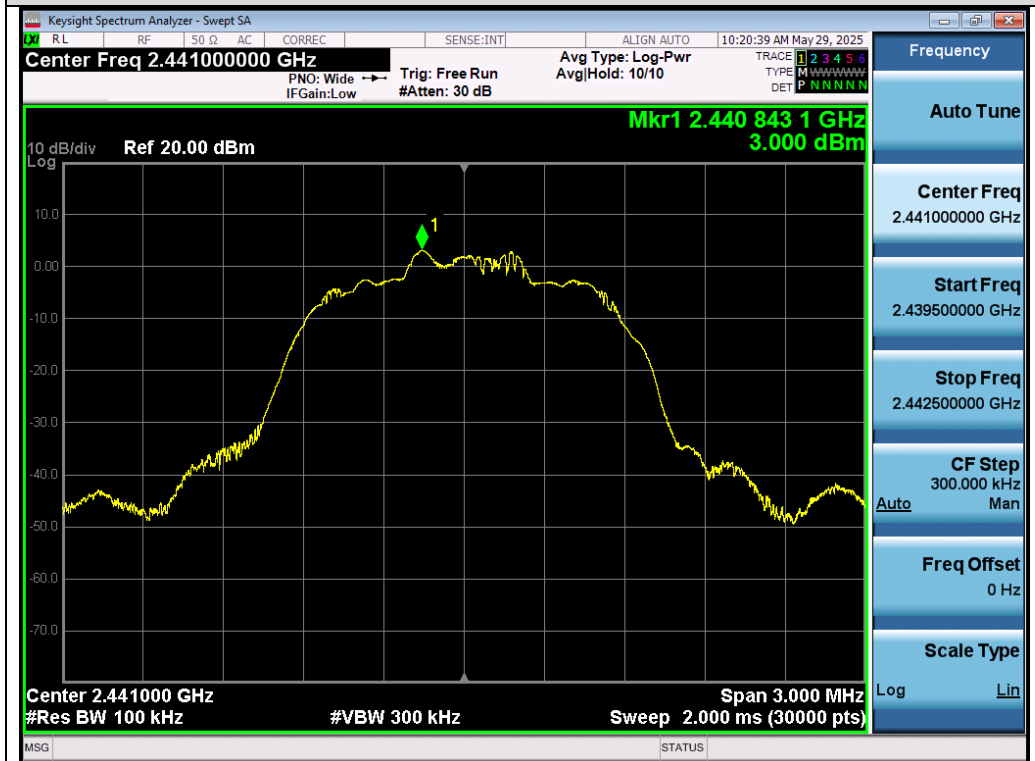

Test\_Graph\_EDR\_ANT1\_2441\_3Mbps\_Reference Level

Any report having not been signed by authorized approver, or having been altered without authorization, or having not been stamped by the "Dedicated Testing/Inspection Stamp" is deemed to be invalid. Copying or excerpting portion of, or altering the content of the report is not permitted without the written authorization of AGC. The test results presented in the report apply only to the tested sample. Any objections to report issued by AGC should be submitted to AGC within 15days after the issuance of the test report. Further enquiry of validity or verification of the test report should be addressed to AGC by agc01@agccert.com.



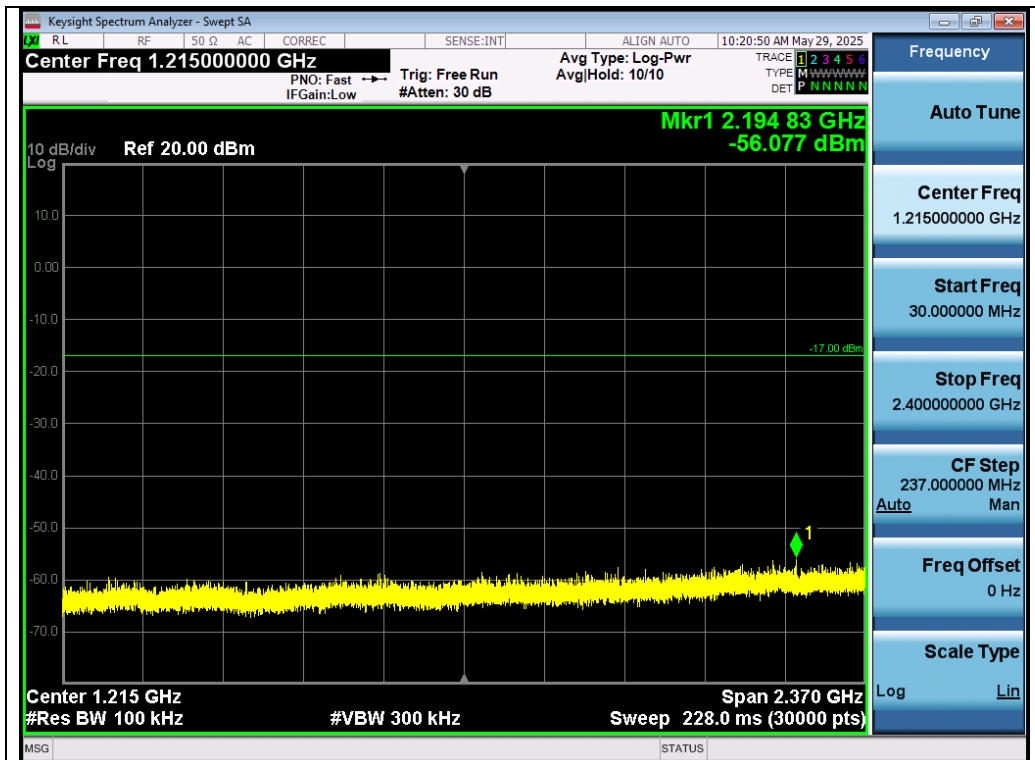

Test\_Graph\_EDR\_ANT1\_2441\_3Mbps\_Lower Band Emissions

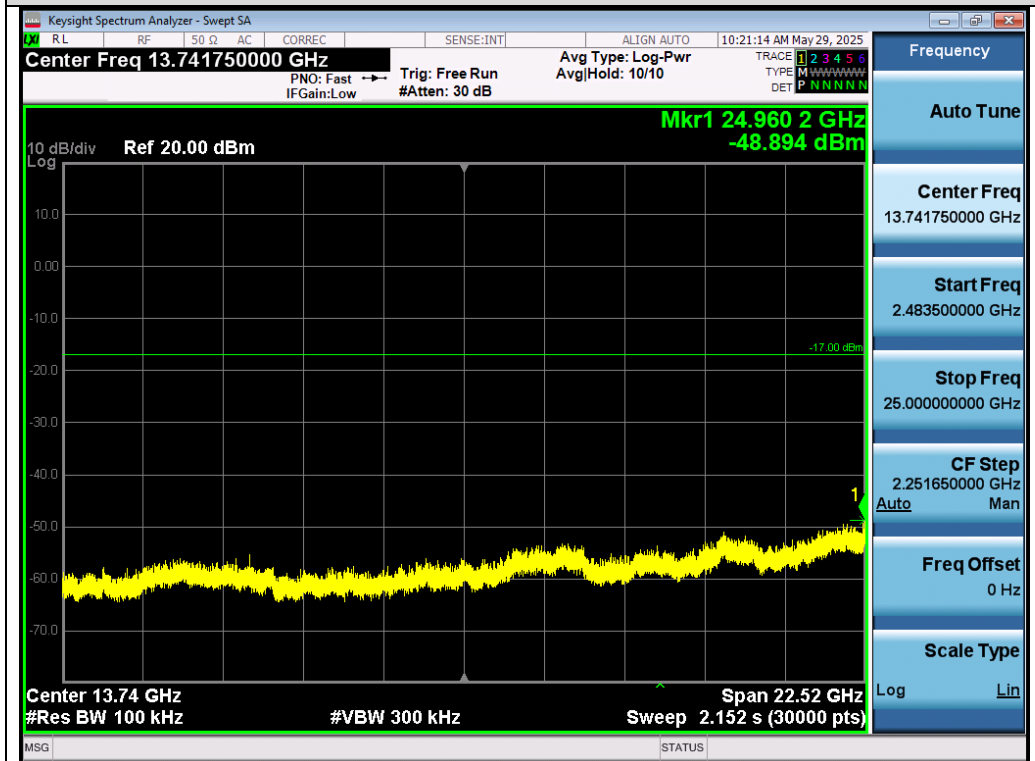

Test\_Graph\_EDR\_ANT1\_2441\_3Mbps\_Higher Band Emissions

Any report having not been signed by authorized approver, or having been altered without authorization, or having not been stamped by the "Dedicated Testing/Inspection Stamp" is deemed to be invalid. Copying or excerpting portion of, or altering the content of the report is not permitted without the written authorization of AGC. The test results presented in the report apply only to the tested sample. Any objections to report issued by AGC should be submitted to AGC within 15days after the issuance of the test report. Further enquiry of validity or verification of the test report should be addressed to AGC by agc01@agccert.com.



Test\_Graph\_EDR\_ANT1\_2480\_3Mbps\_Reference Level

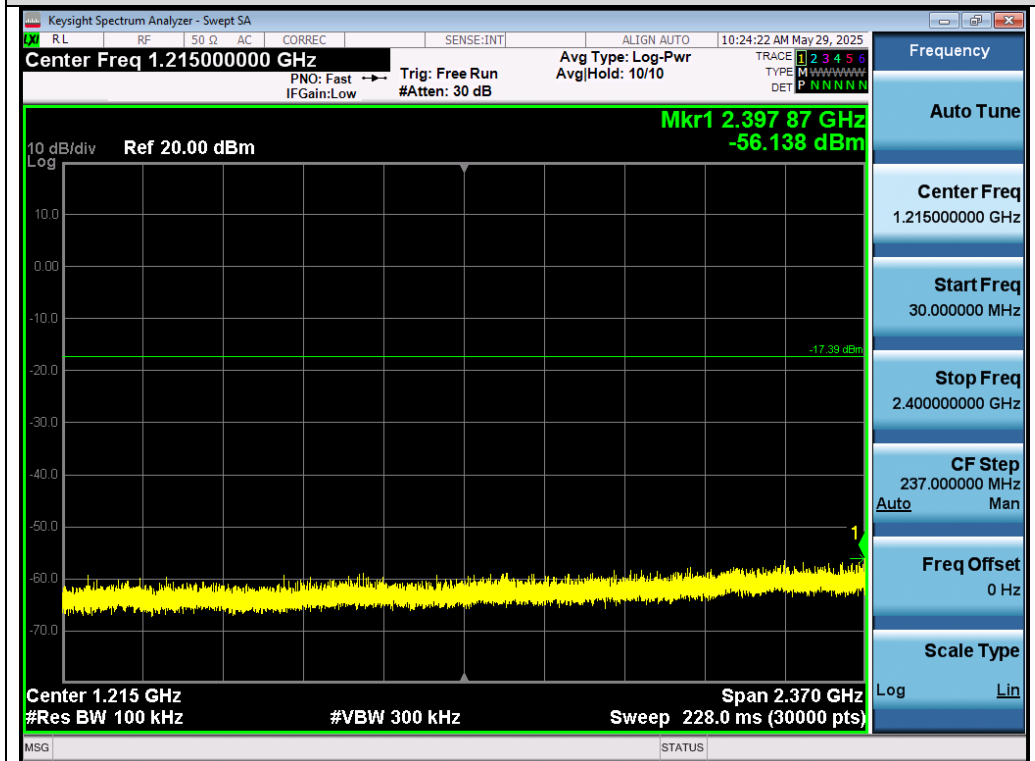

Test\_Graph\_EDR\_ANT1\_2480\_3Mbps\_Lower Band Emissions

Any report having not been signed by authorized approver, or having been altered without authorization, or having not been stamped by the "Dedicated Testing/Inspection Stamp" is deemed to be invalid. Copying or excerpting portion of, or altering the content of the report is not permitted without the written authorization of AGC. The test results presented in the report apply only to the tested sample. Any objections to report issued by AGC should be submitted to AGC within 15days after the issuance of the test report. Further enquiry of validity or verification of the test report should be addressed to AGC by agc01@agccert.com.

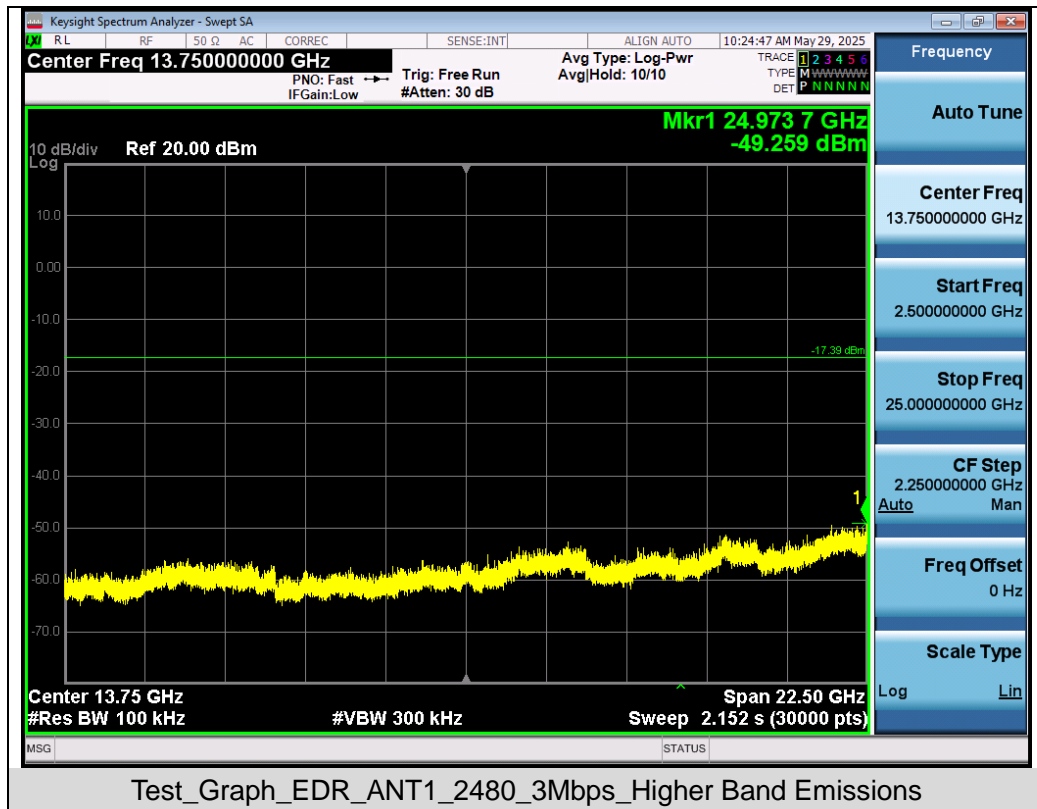

Any report having not been signed by authorized approver, or having been altered without authorization, or having not been stamped by the "Dedicated Testing/Inspection Stamp" is deemed to be invalid. Copying or excerpting portion of, or altering the content of the report is not permitted without the written authorization of AGC. The test results presented in the report apply only to the tested sample. Any objections to report issued by AGC should be submitted to AGC within 15days after the issuance of the test report. Further enquiry of validity or verification of the test report should be addressed to AGC by agc01@agccert.com.

Attestation of Global Compliance(Shenzhen)Co., Ltd  
 Attestation of Global Compliance(Shenzhen)Std & Tech Co., Ltd  
 Tel: +86-755 2523 4088 E-mail: agc@agccert.com Web: http://www.agccert.com/

**Test Graphs of Band Edge Emissions in Non-Restricted Frequency Bands**

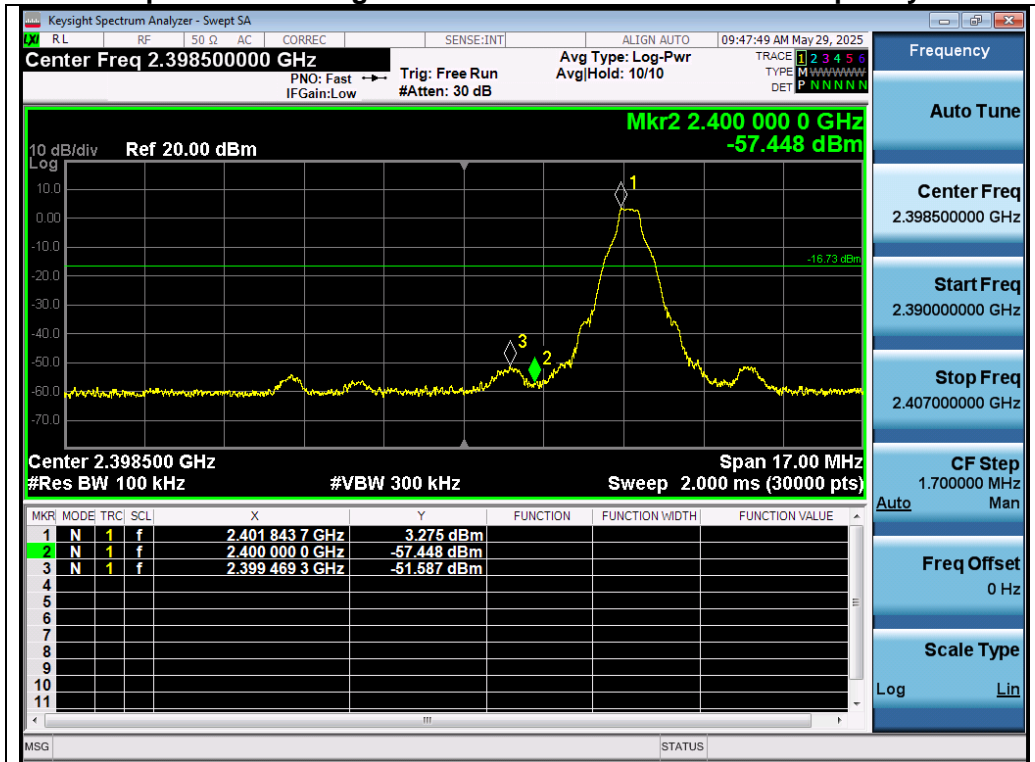

Test\_Graph\_BR\_ANT1\_2402\_1Mbps\_Lower Band Edge Emissions

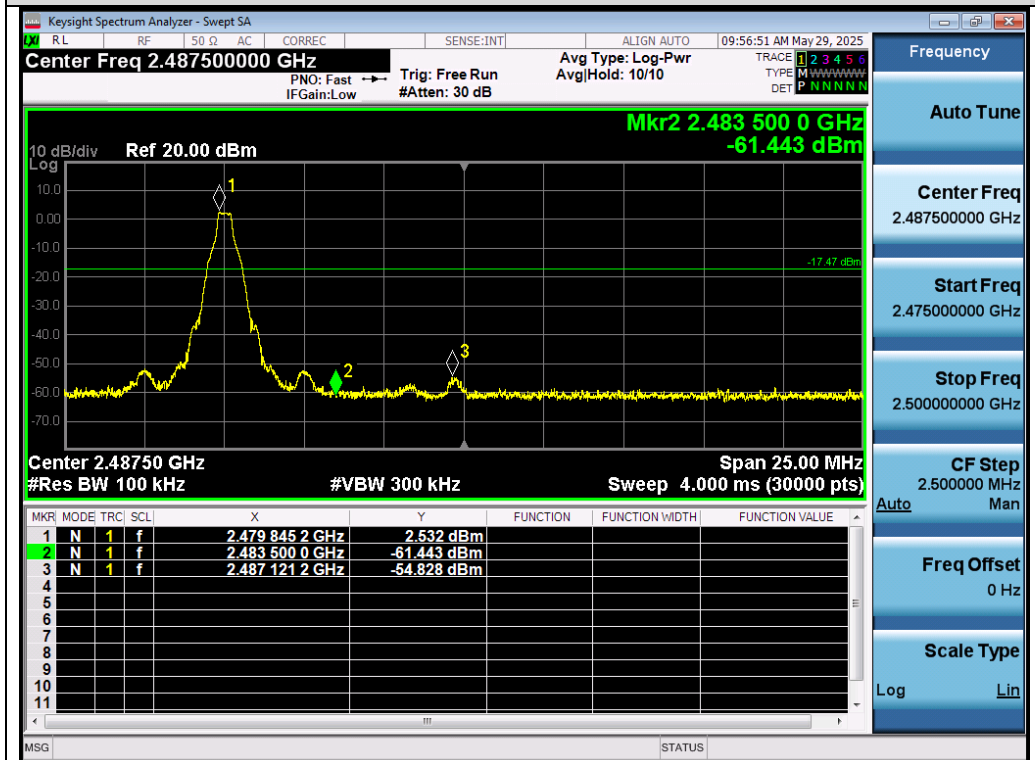

Test\_Graph\_BR\_ANT1\_2480\_1Mbps\_Higher Band Edge Emissions

Any report having not been signed by authorized approver, or having been altered without authorization, or having not been stamped by the "Dedicated Testing/Inspection Stamp" is deemed to be invalid. Copying or excerpting portion of, or altering the content of the report is not permitted without the written authorization of AGC. The test results presented in the report apply only to the tested sample. Any objections to report issued by AGC should be submitted to AGC within 15days after the issuance of the test report. Further enquiry of validity or verification of the test report should be addressed to AGC by agc01@agccert.com.

Attestation of Global Compliance(Shenzhen)Co., Ltd  
Attestation of Global Compliance(Shenzhen)Std & Tech Co., Ltd  
Tel: +86-755 2523 4088 E-mail: agc@agccert.com Web: http://www.agccert.com/

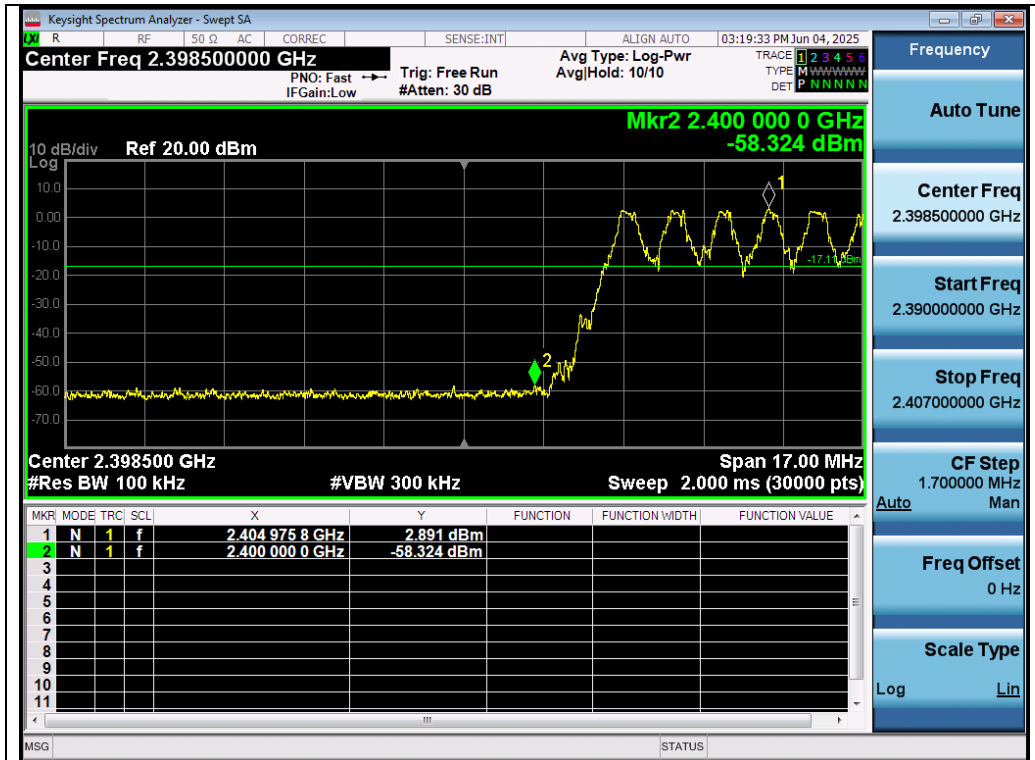

Test\_Graph\_BR\_HOP\_ANT1\_NA\_1Mbps\_Lower Band Edge Emissions

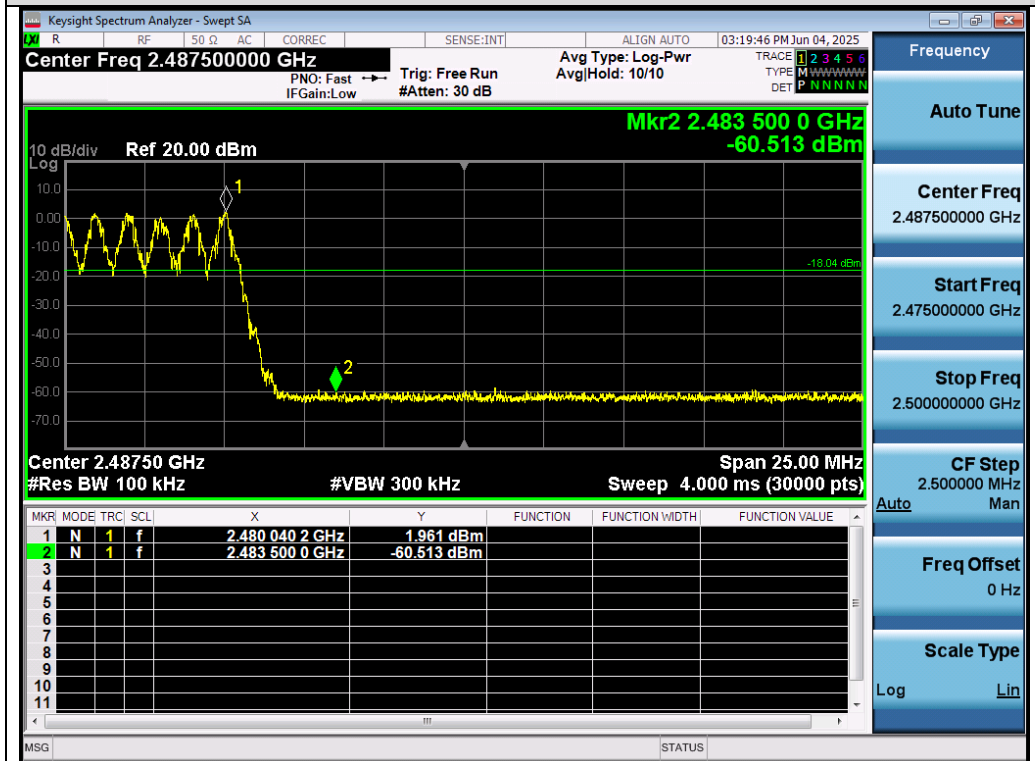

Test\_Graph\_BR\_HOP\_ANT1\_NA\_1Mbps\_Higher Band Edge Emissions

Any report having not been signed by authorized approver, or having been altered without authorization, or having not been stamped by the "Dedicated Testing/Inspection Stamp" is deemed to be invalid. Copying or excerpting portion of, or altering the content of the report is not permitted without the written authorization of AGC. The test results presented in the report apply only to the tested sample. Any objections to report issued by AGC should be submitted to AGC within 15days after the issuance of the test report. Further enquiry of validity or verification of the test report should be addressed to AGC by agc01@agccert.com.



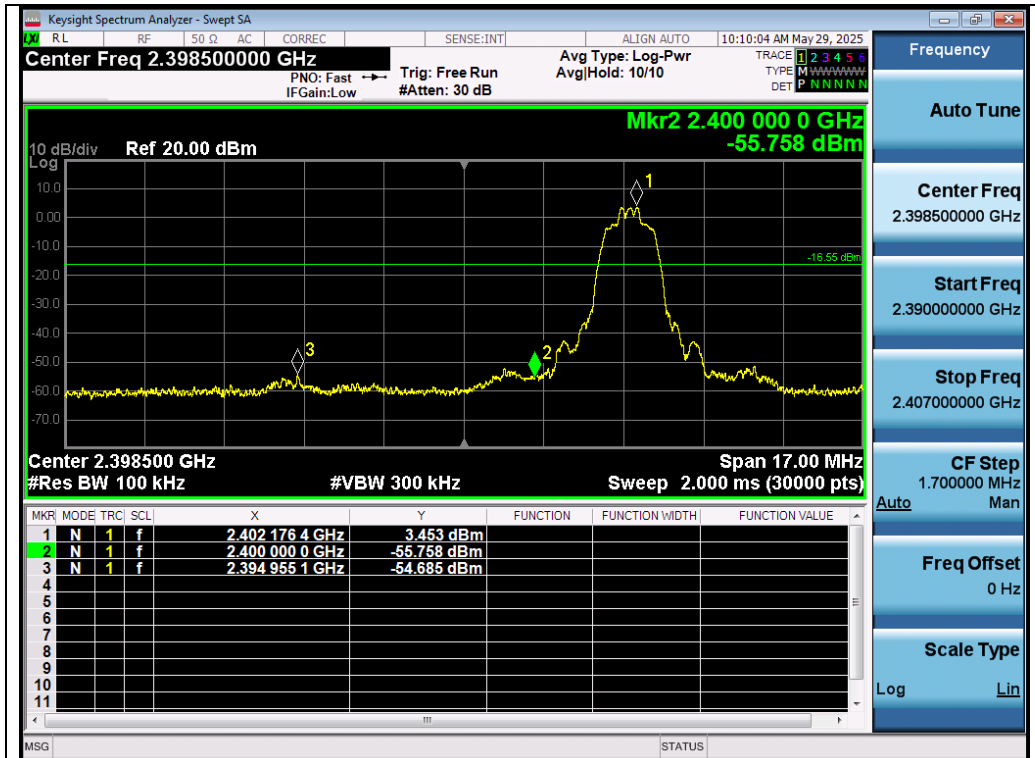

Test\_Graph\_EDR\_ANT1\_2402\_2Mbps\_Lower Band Edge Emissions

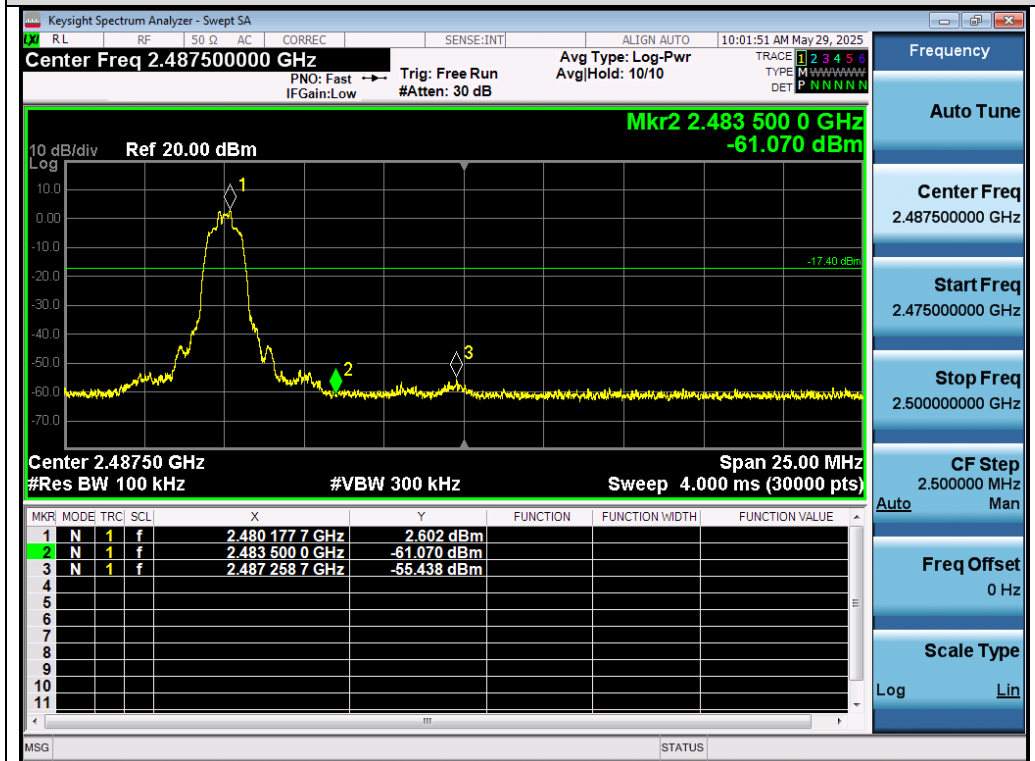

Test\_Graph\_EDR\_ANT1\_2480\_2Mbps\_Higher Band Edge Emissions

Any report having not been signed by authorized approver, or having been altered without authorization, or having not been stamped by the "Dedicated Testing/Inspection Stamp" is deemed to be invalid. Copying or excerpting portion of, or altering the content of the report is not permitted without the written authorization of AGC. The test results presented in the report apply only to the tested sample. Any objections to report issued by AGC should be submitted to AGC within 15days after the issuance of the test report. Further enquiry of validity or verification of the test report should be addressed to AGC by agc01@agccert.com.

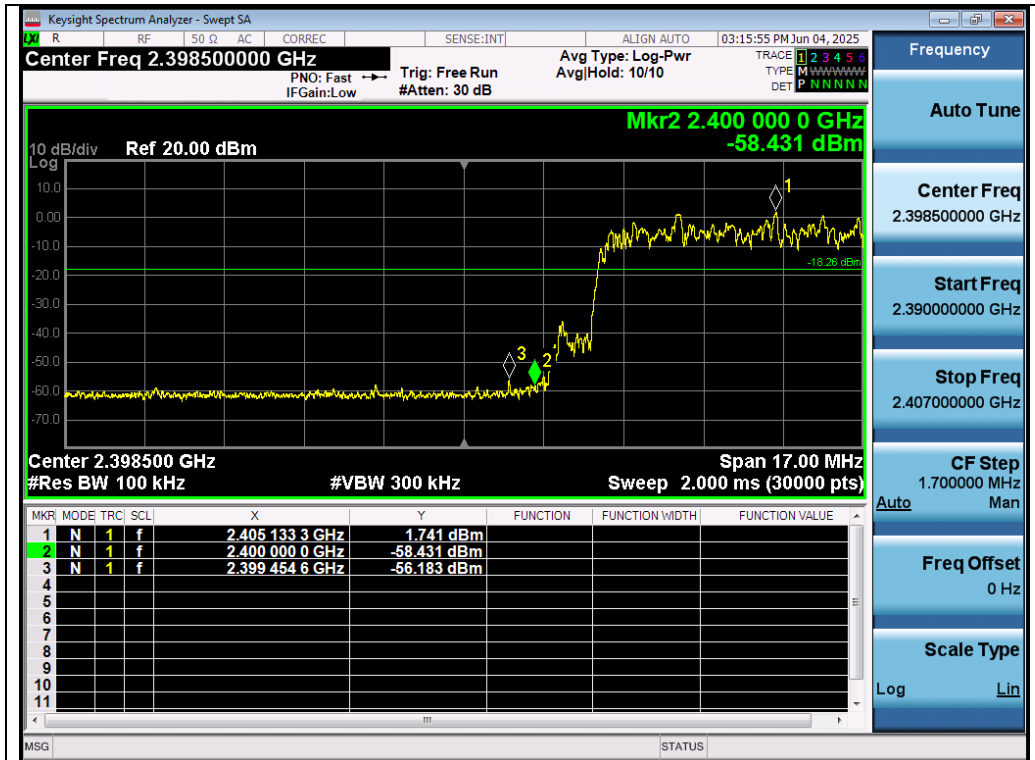

Test\_Graph\_EDR\_HOP\_ANT1\_NA\_2Mbps\_Lower Band Edge Emissions

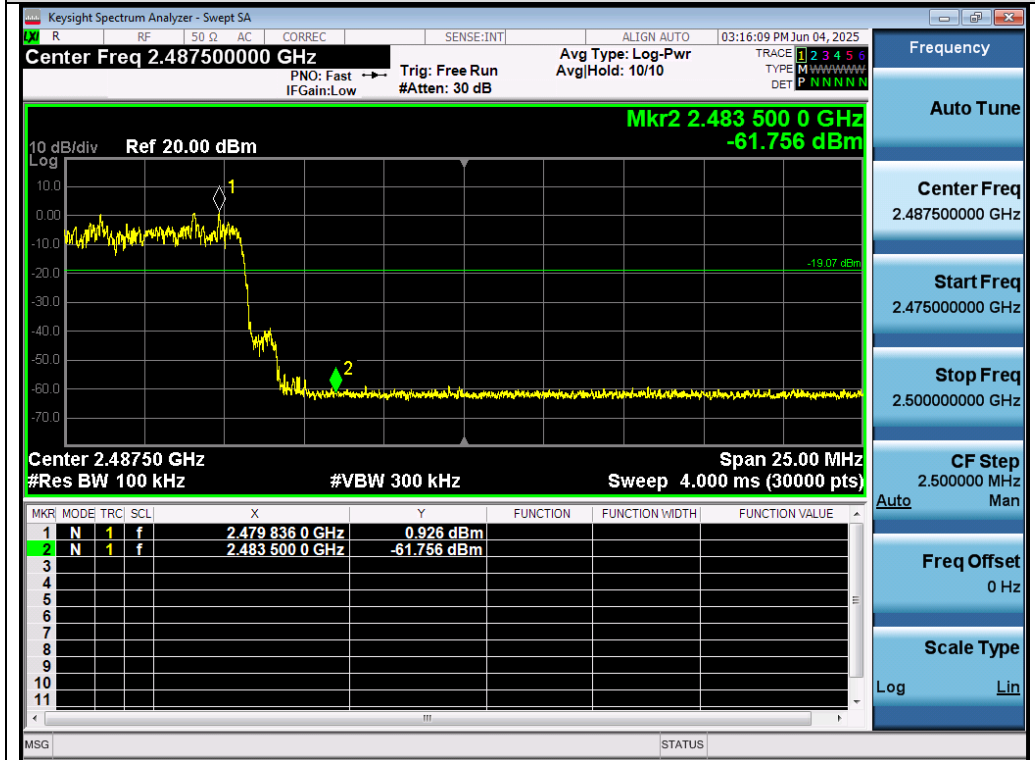

Test\_Graph\_EDR\_HOP\_ANT1\_NA\_2Mbps\_Higher Band Edge Emissions

Any report having not been signed by authorized approver, or having been altered without authorization, or having not been stamped by the "Dedicated Testing/Inspection Stamp" is deemed to be invalid. Copying or excerpting portion of, or altering the content of the report is not permitted without the written authorization of AGC. The test results presented in the report apply only to the tested sample. Any objections to report issued by AGC should be submitted to AGC within 15days after the issuance of the test report. Further enquiry of validity or verification of the test report should be addressed to AGC by agc01@agccert.com.



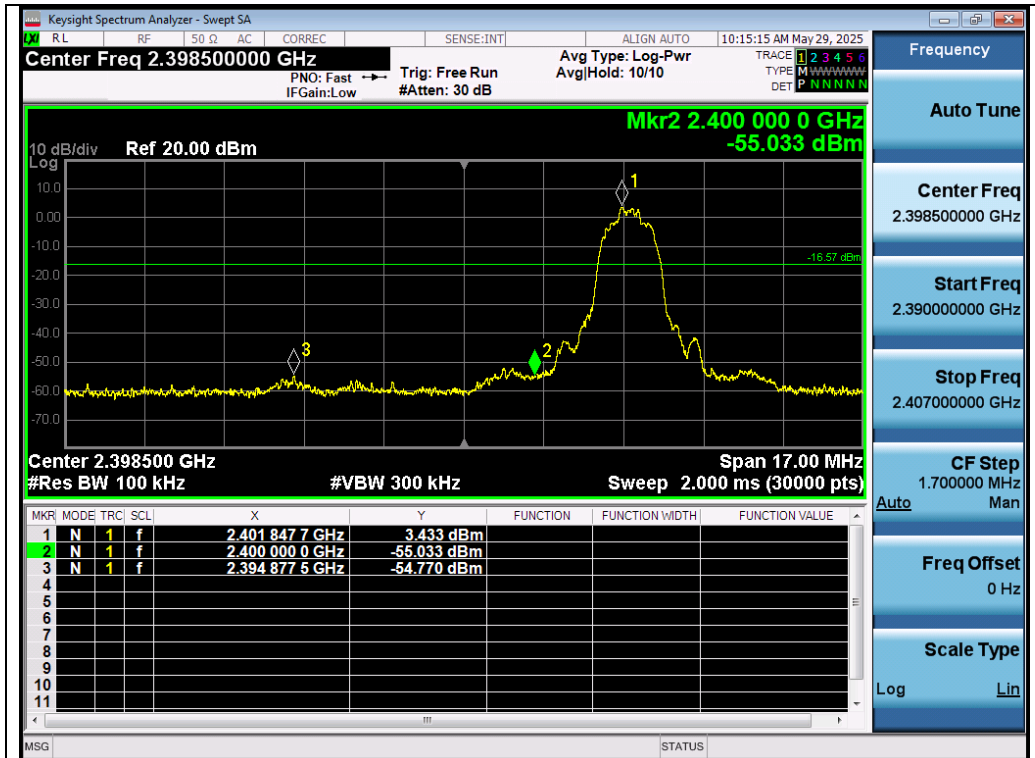

Test\_Graph\_EDR\_ANT1\_2402\_3Mbps\_Lower Band Edge Emissions

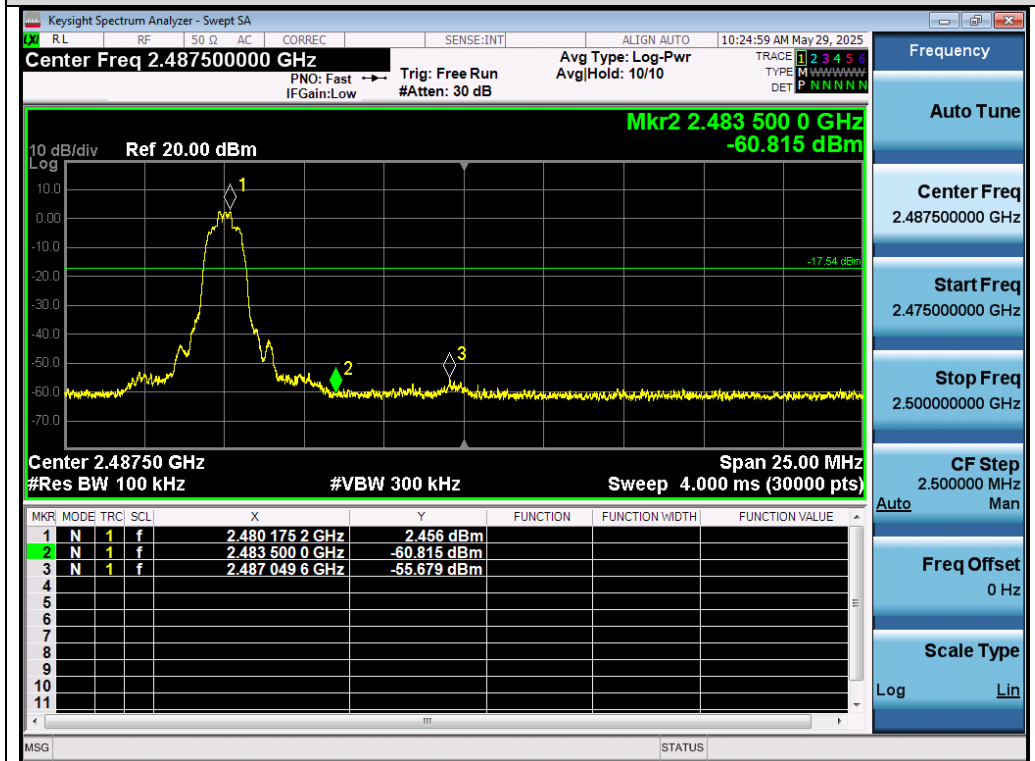

Test\_Graph\_EDR\_ANT1\_2480\_3Mbps\_Higher Band Edge Emissions

Any report having not been signed by authorized approver, or having been altered without authorization, or having not been stamped by the "Dedicated Testing/Inspection Stamp" is deemed to be invalid. Copying or excerpting portion of, or altering the content of the report is not permitted without the written authorization of AGC. The test results presented in the report apply only to the tested sample. Any objections to report issued by AGC should be submitted to AGC within 15days after the issuance of the test report. Further enquiry of validity or verification of the test report should be addressed to AGC by agc01@agccert.com.



Test\_Graph\_EDR\_HOP\_ANT1\_NA\_3Mbps\_Lower Band Edge Emissions

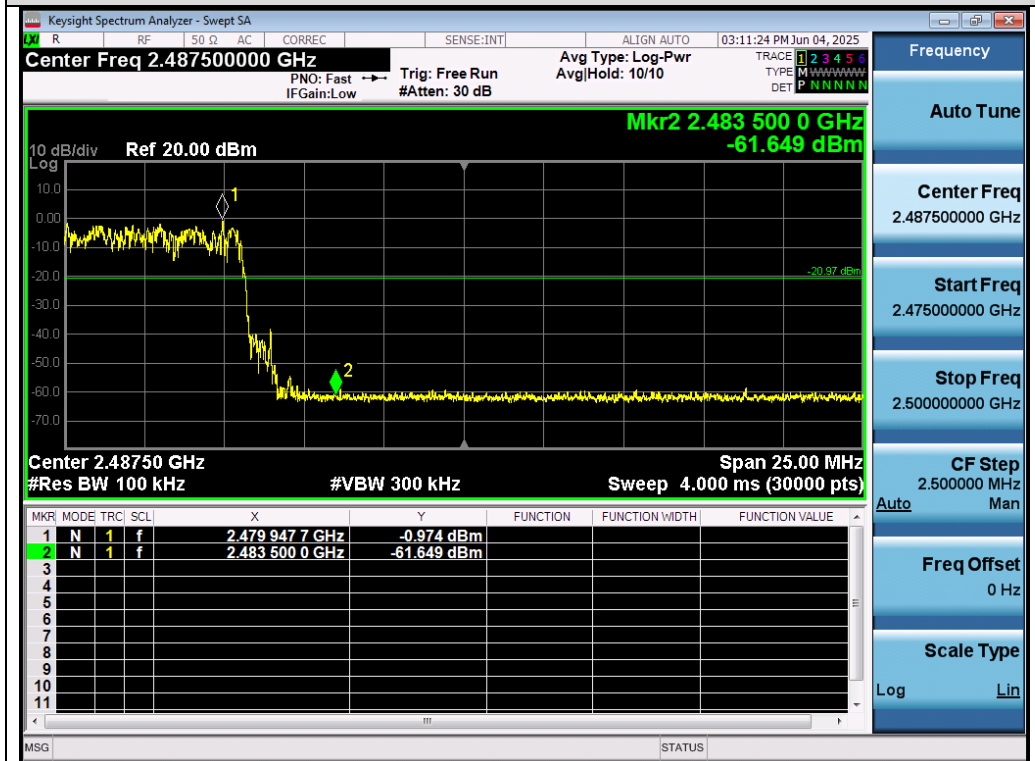

Test\_Graph\_EDR\_HOP\_ANT1\_NA\_3Mbps\_Higher Band Edge Emissions

Any report having not been signed by authorized approver, or having been altered without authorization, or having not been stamped by the "Dedicated Testing/Inspection Stamp" is deemed to be invalid. Copying or excerpting portion of, or altering the content of the report is not permitted without the written authorization of AGC. The test results presented in the report apply only to the tested sample. Any objections to report issued by AGC should be submitted to AGC within 15days after the issuance of the test report. Further enquiry of validity or verification of the test report should be addressed to AGC by agc01@agccert.com.

## 9. Radiated Spurious Emission

### 9.1 Measurement Limit

- 15.209 Limit in the below table has to be followed

Frequencies (MHz)	Field Strength (microvolts/meter)	Measurement Distance (meters)
0.009~0.490	2400/F(kHz)	300
0.490~1.705	24000/F(kHz)	30
1.705~30.0	30	30
30~88	100	3
88~216	150	3
216~960	200	3
Above 960	500	3

Note: All modes were tested for restricted band radiated emission, the test records reported below are the worst result compared to other modes.

### 9.2 Measurement Procedure

1. The EUT was placed on the top of the turntable 0.8 or 1.5 meter above ground. The phase center of the receiving antenna mounted on the top of a height-variable antenna tower was placed 3 meters far away from the turntable.
2. Power on the EUT and all the supporting units. The turntable was rotated by 360 degrees to determine the position of the highest radiation.
3. The height of the broadband receiving antenna was varied between one meter and four meters above ground to find the maximum emissions field strength of both horizontal and vertical polarization.
4. For each suspected emission, the antenna tower was scan (from 1 M to 4 M) and then the turntable was rotated (from 0 degree to 360 degrees) to find the maximum reading.
5. Set the test-receiver system to Peak or CISPR quasi-peak Detect Function with specified bandwidth under Maximum Hold Mode.
6. For emissions above 1GHz, use 1MHz RBW and 3MHz VBW for peak reading. Place the measurement antenna away from each area of the EUT determined to be a source of emissions at the specified measurement distance, while keeping the measurement antenna aimed at the source of emissions at each frequency of significant emissions, with polarization oriented for maximum response. The measurement antenna may have to be higher or lower than the EUT, depending on the radiation pattern of the emission and staying aimed at the emission source for receiving the maximum signal. The final measurement antenna elevation shall be that which maximizes the emissions. The measurement antenna elevation for maximum emissions shall be restricted to a range of heights of from 1 m to 4 m above the ground or reference ground plane.

Any report having not been signed by authorized approver, or having been altered without authorization, or having not been stamped by the "Dedicated Testing/Inspection Stamp" is deemed to be invalid. Copying or excerpting portion of, or altering the content of the report is not permitted without the written authorization of AGC. The test results presented in the report apply only to the tested sample. Any objections to report issued by AGC should be submitted to AGC within 15days after the issuance of the test report. Further enquiry of validity or verification of the test report should be addressed to AGC by agc01@agccert.com.

7. When the radiated emissions limits are expressed in terms of the average value of the emissions, and pulsed operation is employed, the measurement field strength shall be determined by averaging over one complete pulse train, including blanking intervals, as long as the pulse train does not exceed 0.1 seconds. As an alternative (provided the transmitter operates for longer than 0.1 seconds) or in cases where the pulse train exceeds 0.1 seconds, the measured field strength shall be determined from the average absolute voltage during a 0.1 second interval during which the field strength is at its maximum values.
8. If the emissions level of the EUT in peak mode was 3 dB lower than the average limit specified, then testing will be stopped and peak values of EUT will be reported, otherwise, the emissions which do not have 3 dB margin will be repeated one by one using the quasi-peak method for below 1GHz.
9. For testing above 1GHz, the emissions level of the EUT in peak mode was lower than average limit (that means the emissions level in peak mode also complies with the limit in average mode), then testing will be stopped and peak values of EUT will be reported, otherwise, the emissions will be measured in average mode again and reported.
10. In case the emission is lower than 30MHz, loop antenna has to be used for measurement and the recorded data should be QP measured by receiver. High - Low scan is not required in this case.

The following table is the setting of spectrum analyzer and receiver.

Spectrum Parameter	Setting
Start ~Stop Frequency	9KHz~150KHz/RB 200Hz for QP
Start ~Stop Frequency	150KHz~30MHz/RB 9KHz for QP
Start ~Stop Frequency	30MHz~1000MHz/RB 120KHz for QP
Start ~Stop Frequency	1GHz~26.5GHz 1MHz/3MHz for Peak, 1MHz/3MHz for Average

Receiver Parameter	Setting
Start ~Stop Frequency	9KHz~150KHz/RB 200Hz for QP
Start ~Stop Frequency	150KHz~30MHz/RB 9KHz for QP
Start ~Stop Frequency	30MHz~1000MHz/RB 120KHz for QP

Any report having not been signed by authorized approver, or having been altered without authorization, or having not been stamped by the "Dedicated Testing/Inspection Stamp" is deemed to be invalid. Copying or excerpting portion of, or altering the content of the report is not permitted without the written authorization of AGC. The test results presented in the report apply only to the tested sample. Any objections to report issued by AGC should be submitted to AGC within 15days after the issuance of the test report. Further enquiry of validity or verification of the test report should be addressed to AGC by agc01@agccert.com.

- **Quasi-Peak Measurements below 1GHz**

1. Analyzer center frequency was set to the frequency of the radiated spurious emission of interest
2. Span was set greater than 1MHz
3. RBW = as shown in the table above
4. Detector = CISPR quasi-peak
5. Sweep time = auto couple
6. Trace was allowed to stabilize

- **Peak Measurements above 1GHz**

1. Analyzer center frequency was set to the frequency of the radiated spurious emission of interest
2. RBW = 1MHz
3. VBW = 3MHz
4. Detector = peak
5. Sweep time = auto couple
6. Trace mode = max hold
7. Trace was allowed to stabilize

- **Average Measurements above 1GHz**

1. Analyzer center frequency was set to the frequency of the radiated spurious emission of interest
2. RBW = 1MHz
3. VBW  $\geq [3 \times \text{RBW}]$
4. Detector = Power averaging (rms)
5. Averaging type = power (i.e., rms)
6. Sweep time = auto
7. Perform a trace average of at least 100 traces.
8. The applicable correction factor is  $[10 \cdot \log(1 / D)]$ , where D is the duty cycle. The factor had been edited in the "Input Correction" of the Spectrum Analyzer.

Any report having not been signed by authorized approver, or having been altered without authorization, or having not been stamped by the "Dedicated Testing/Inspection Stamp" is deemed to be invalid. Copying or excerpting portion of, or altering the content of the report is not permitted without the written authorization of AGC. The test results presented in the report apply only to the tested sample. Any objections to report issued by AGC should be submitted to AGC within 15days after the issuance of the test report. Further enquiry of validity or verification of the test report should be addressed to AGC by [agc01@agccert.com](mailto:agc01@agccert.com).



### 9.3 Measurement Setup (Block Diagram of Configuration)

Radiated Emission Test Setup 9KHz-30MHz

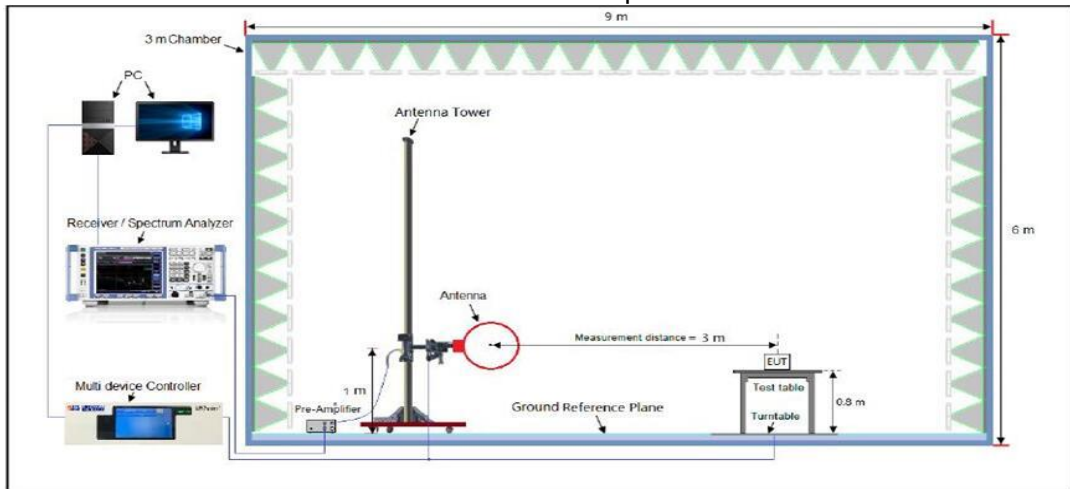

Radiated Emission Test Setup 30MHz-1000MHz

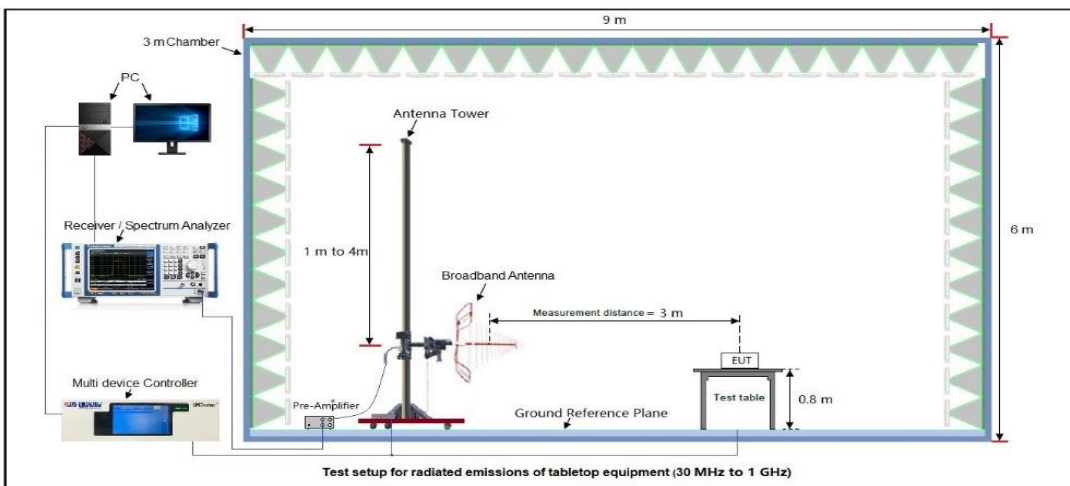

Radiated Emission Test Setup Above 1000MHz

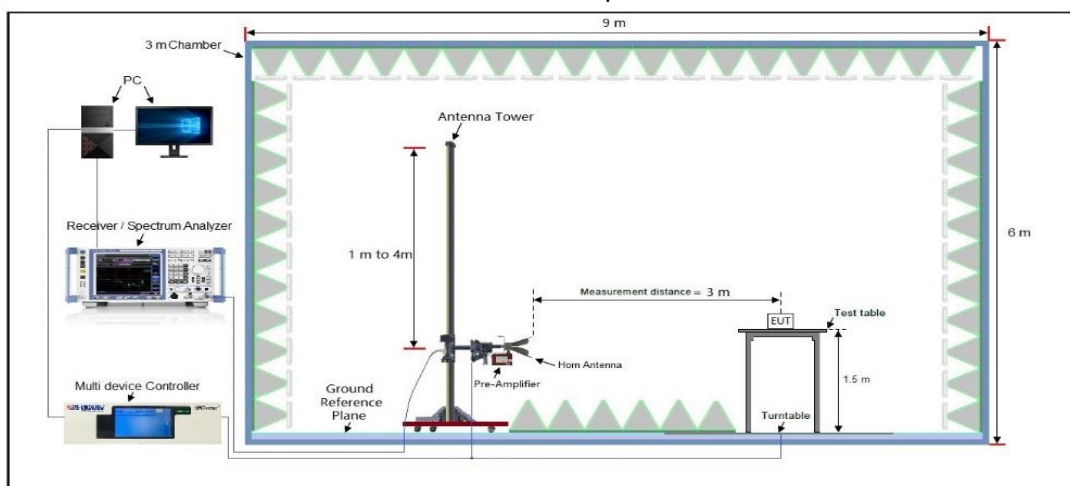

Any report having not been signed by authorized approver, or having been altered without authorization, or having not been stamped by the "Dedicated Testing/Inspection Stamp" is deemed to be invalid. Copying or excerpting portion of, or altering the content of the report is not permitted without the written authorization of AGC. The test results presented in the report apply only to the tested sample. Any objections to report issued by AGC should be submitted to AGC within 15days after the issuance of the test report. Further enquiry of validity or verification of the test report should be addressed to AGC by agc01@agccert.com.



### 9.4 Measurement Result

#### Radiated Emission Below 30MHz

The amplitude of spurious emissions from 9kHz to 30MHz which are attenuated more than 20 dB below the permissible value need not be reported.

Radiated Emission Test Results at 30MHz-1GHz			
<b>EUT Name</b>	Wireless USB Adapter	<b>Model Name</b>	AX912
<b>Temperature</b>	22.4°C	<b>Relative Humidity</b>	51.4%
<b>Pressure</b>	960hPa	<b>Test Voltage</b>	DC 5V
<b>Test Mode</b>	Mode 7	<b>Antenna Polarity</b>	Horizontal

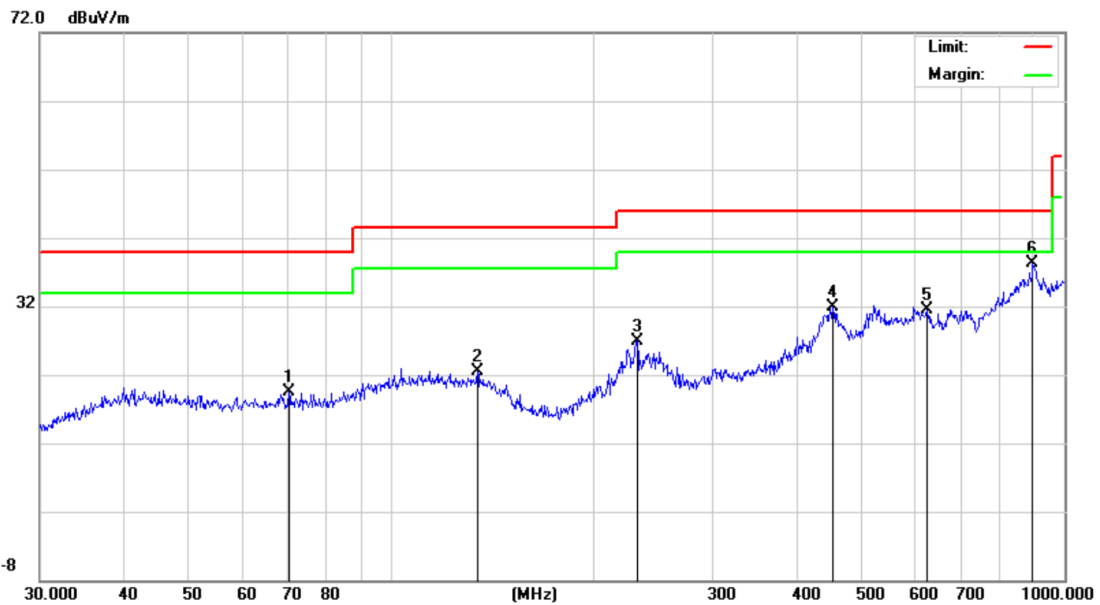

#### Final Data List

NO.	Freq. [MHz]	Level [dBμV/m]	Factor [dB]	Limit [dBμV/m]	Margin [dB]	Height [cm]	Angle [°]	Polarity
1	70.3365	19.52	12.81	40.00	20.48	100	96	Horizontal
2	134.0882	22.44	15.55	43.50	21.06	100	132	Horizontal
3	231.7179	26.94	14.99	46.00	19.06	100	225	Horizontal
4	452.7197	31.95	24.65	46.00	14.05	100	124	Horizontal
5	625.0780	31.42	24.72	46.00	14.58	100	110	Horizontal
6	896.9965	38.24	31.42	46.00	7.76	100	125	Horizontal

Any report having not been signed by authorized approver, or having been altered without authorization, or having not been stamped by the "Dedicated Testing/Inspection Stamp" is deemed to be invalid. Copying or excerpting portion of, or altering the content of the report is not permitted without the written authorization of AGC. The test results presented in the report apply only to the tested sample. Any objections to report issued by AGC should be submitted to AGC within 15days after the issuance of the test report. Further enquiry of validity or verification of the test report should be addressed to AGC by agc01@agccert.com.

Radiated Emission Test Results at 30MHz-1GHz			
<b>EUT Name</b>	Wireless USB Adapter	<b>Model Name</b>	AX912
<b>Temperature</b>	22.4°C	<b>Relative Humidity</b>	51.4%
<b>Pressure</b>	960hPa	<b>Test Voltage</b>	DC 5V
<b>Test Mode</b>	Mode 7	<b>Antenna Polarity</b>	Vertical

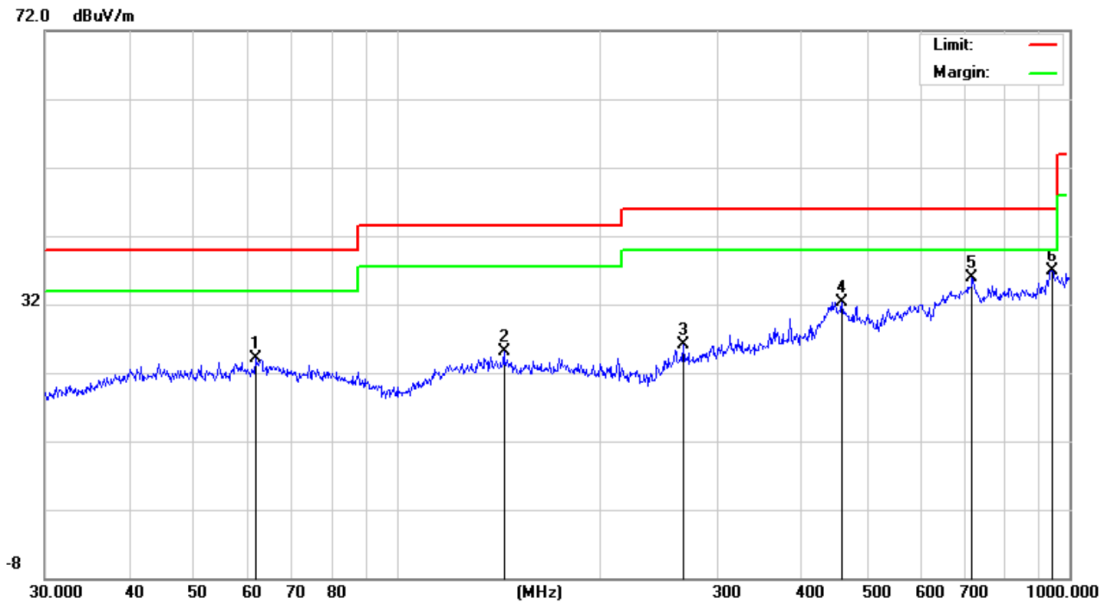

**Final Data List**

NO.	Freq. [MHz]	Level [dBμV/m]	Factor [dB]	Limit [dBμV/m]	Margin [dB]	Height [cm]	Angle [°]	Polarity
1	61.7781	24.09	17.08	40.00	15.91	100	145	Vertical
2	144.3348	25.02	18.20	43.50	18.48	100	126	Vertical
3	266.6089	26.05	18.07	46.00	19.95	100	218	Vertical
4	459.1144	32.36	25.24	46.00	13.64	100	138	Vertical
5	716.6820	35.91	28.68	46.00	10.09	100	215	Vertical
6	942.1305	36.86	30.91	46.00	9.14	100	220	Vertical

**RESULT: Pass**

**Note:**

- Factor=Antenna Factor + Cable loss, Margin= Limit-Level.
- All test modes had been pre-tested. The mode 7 is the worst case and recorded in the report.

Any report having not been signed by authorized approver, or having been altered without authorization, or having not been stamped by the "Dedicated Testing/Inspection Stamp" is deemed to be invalid. Copying or excerpting portion of, or altering the content of the report is not permitted without the written authorization of AGC. The test results presented in the report apply only to the tested sample. Any objections to report issued by AGC should be submitted to AGC within 15days after the issuance of the test report. Further enquiry of validity or verification of the test report should be addressed to AGC by agc01@agccert.com.

**Radiated Emissions Test Results Above 1GHz**

<b>EUT Name</b>	Wireless USB Adapter	<b>Model Name</b>	AX912
<b>Temperature</b>	22.4°C	<b>Relative Humidity</b>	51.4%
<b>Pressure</b>	960hPa	<b>Test Voltage</b>	DC 5V
<b>Test Mode</b>	Mode 7	<b>Antenna Polarity</b>	Horizontal

Frequency (MHz)	Meter Reading (dBµV)	Factor (dB)	Emission Level (dBµV/m)	Limits (dBµV/m)	Margin (dB)	Value Type
4804.000	46.85	0.08	46.93	74	-27.07	peak
4804.000	37.41	0.08	37.49	54	-16.51	AVG
7206.000	41.52	2.21	43.73	74	-30.27	peak
7206.000	32.69	2.21	34.9	54	-19.1	AVG

Remark:  
Factor = Antenna Factor + Cable Loss – Pre-amplifier.

<b>EUT Name</b>	Wireless USB Adapter	<b>Model Name</b>	AX912
<b>Temperature</b>	22.4°C	<b>Relative Humidity</b>	51.4%
<b>Pressure</b>	960hPa	<b>Test Voltage</b>	DC 5V
<b>Test Mode</b>	Mode 7	<b>Antenna Polarity</b>	Vertical

Frequency (MHz)	Meter Reading (dBµV)	Factor (dB)	Emission Level (dBµV/m)	Limits (dBµV/m)	Margin (dB)	Value Type
4804.000	46.82	0.08	46.9	74	-27.1	peak
4804.000	37.74	0.08	37.82	54	-16.18	AVG
7206.000	41.51	2.21	43.72	74	-30.28	peak
7206.000	32.69	2.21	34.9	54	-19.1	AVG

Remark:  
Factor = Antenna Factor + Cable Loss – Pre-amplifier.

**RESULT: PASS**

Any report having not been signed by authorized approver, or having been altered without authorization, or having not been stamped by the “Dedicated Testing/Inspection Stamp” is deemed to be invalid. Copying or excerpting portion of, or altering the content of the report is not permitted without the written authorization of AGC. The test results presented in the report apply only to the tested sample. Any objections to report issued by AGC should be submitted to AGC within 15days after the issuance of the test report. Further enquiry of validity or verification of the test report should be addressed to AGC by agc01@agccert.com.

**Radiated Emissions Test Results for Above 1GHz**

<b>EUT Name</b>	Wireless USB Adapter	<b>Model Name</b>	AX912
<b>Temperature</b>	22.4°C	<b>Relative Humidity</b>	51.4%
<b>Pressure</b>	960hPa	<b>Test Voltage</b>	DC 5V
<b>Test Mode</b>	Mode 8	<b>Antenna Polarity</b>	Horizontal

Frequency (MHz)	Meter Reading (dBµV)	Factor (dB)	Emission Level (dBµV/m)	Limits (dBµV/m)	Margin (dB)	Value Type
4882.000	45.23	0.14	45.37	74	-28.63	peak
4882.000	38.41	0.14	38.55	54	-15.45	AVG
7323.000	41.25	2.36	43.61	74	-30.39	peak
7323.000	34.81	2.36	37.17	54	-16.83	AVG

Remark:  
Factor = Antenna Factor + Cable Loss – Pre-amplifier.

<b>EUT Name</b>	Wireless USB Adapter	<b>Model Name</b>	AX912
<b>Temperature</b>	22.4°C	<b>Relative Humidity</b>	51.4%
<b>Pressure</b>	960hPa	<b>Test Voltage</b>	DC 5V
<b>Test Mode</b>	Mode 8	<b>Antenna Polarity</b>	Vertical

Frequency (MHz)	Meter Reading (dBµV)	Factor (dB)	Emission Level (dBµV/m)	Limits (dBµV/m)	Margin (dB)	Value Type
4882.000	45.36	0.14	45.5	74	-28.5	peak
4882.000	37.52	0.14	37.66	54	-16.34	AVG
7323.000	40.41	2.36	42.77	74	-31.23	peak
7323.000	33.25	2.36	35.61	54	-18.39	AVG

Remark:  
Factor = Antenna Factor + Cable Loss – Pre-amplifier.

**RESULT: PASS**

Any report having not been signed by authorized approver, or having been altered without authorization, or having not been stamped by the “Dedicated Testing/Inspection Stamp” is deemed to be invalid. Copying or excerpting portion of, or altering the content of the report is not permitted without the written authorization of AGC. The test results presented in the report apply only to the tested sample. Any objections to report issued by AGC should be submitted to AGC within 15days after the issuance of the test report. Further enquiry of validity or verification of the test report should be addressed to AGC by agc01@agccert.com.

**Radiated Emissions Test Results for Above 1GHz**

<b>EUT Name</b>	Wireless USB Adapter	<b>Model Name</b>	AX912
<b>Temperature</b>	22.4°C	<b>Relative Humidity</b>	51.4%
<b>Pressure</b>	960hPa	<b>Test Voltage</b>	DC 5V
<b>Test Mode</b>	Mode 9	<b>Antenna Polarity</b>	Horizontal

Frequency (MHz)	Meter Reading (dBμV)	Factor (dB)	Emission Level (dBμV/m)	Limits (dBμV/m)	Margin (dB)	Value Type
4960.000	46.18	0.22	46.4	74	-27.6	peak
4960.000	38.47	0.22	38.69	54	-15.31	AVG
7440.000	41.56	2.64	44.2	74	-29.8	peak
7440.000	32.38	2.64	35.02	54	-18.98	AVG

Remark:  
Factor = Antenna Factor + Cable Loss – Pre-amplifier.

<b>EUT Name</b>	Wireless USB Adapter	<b>Model Name</b>	AX912
<b>Temperature</b>	22.4°C	<b>Relative Humidity</b>	51.4%
<b>Pressure</b>	960hPa	<b>Test Voltage</b>	DC 5V
<b>Test Mode</b>	Mode 9	<b>Antenna Polarity</b>	Vertical

Frequency (MHz)	Meter Reading (dBμV)	Factor (dB)	Emission Level (dBμV/m)	Limits (dBμV/m)	Margin (dB)	Value Type
4960.000	46.29	0.22	46.51	74	-27.49	peak
4960.000	38.54	0.22	38.76	54	-15.24	AVG
7440.000	41.82	2.64	44.46	74	-29.54	peak
7440.000	32.47	2.64	35.11	54	-18.89	AVG

Remark:  
Factor = Antenna Factor + Cable Loss – Pre-amplifier.

**RESULT: PASS**

**Note:**

1. The amplitude of other spurious emissions from 1G to 25 GHz which are attenuated more than 20 dB below the permissible value need not be reported.
2. Factor = Antenna Factor + Cable loss – Pre-amplifier gain, Margin =Emission Level-Limit.
3. The “Factor” value can be calculated automatically by software of measurement system.
4. All mode rates are tested and evaluated, 8DPSK modulated 3DH5 mode is the worst case and documented in the report.

Any report having not been signed by authorized approver, or having been altered without authorization, or having not been stamped by the “Dedicated Testing/Inspection Stamp” is deemed to be invalid. Copying or excerpting portion of, or altering the content of the report is not permitted without the written authorization of AGC. The test results presented in the report apply only to the tested sample. Any objections to report issued by AGC should be submitted to AGC within 15days after the issuance of the test report. Further enquiry of validity or verification of the test report should be addressed to AGC by agc01@agccert.com.

### Band Edge Emission Test Results for Restricted Bands

EUT Name	Wireless USB Adapter	Model Name	AX912
Temperature	22.0°C	Relative Humidity	51.0%
Pressure	960hPa	Test Voltage	DC 5V
Test Mode	Mode 7	Antenna Polarity	Horizontal

Test Graph for Peak Measurement

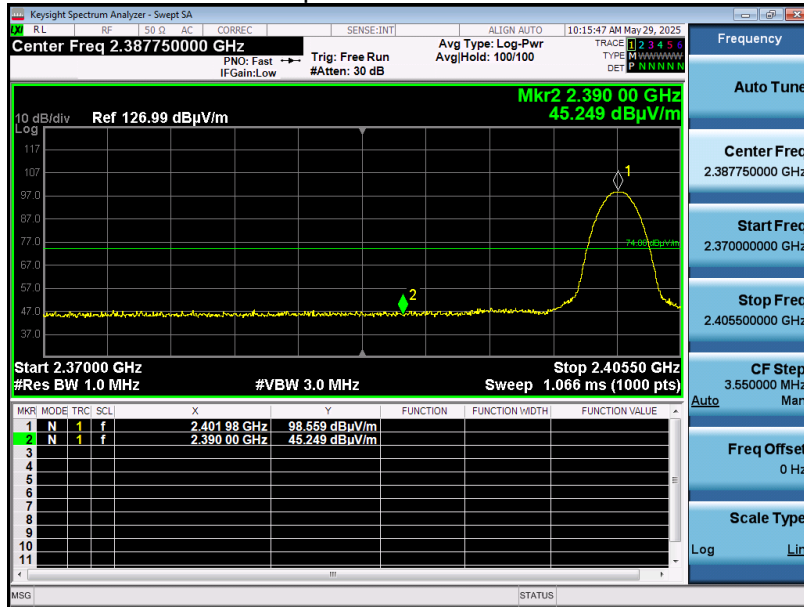

Test Graph for Average Measurement

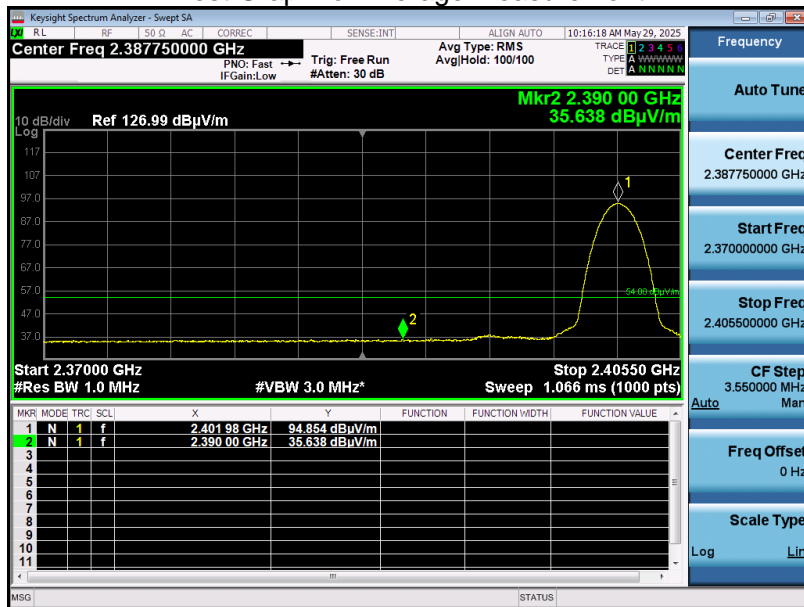

**RESULT: PASS**

Any report having not been signed by authorized approver, or having been altered without authorization, or having not been stamped by the "Dedicated Testing/Inspection Stamp" is deemed to be invalid. Copying or excerpting portion of, or altering the content of the report is not permitted without the written authorization of AGC. The test results presented in the report apply only to the tested sample. Any objections to report issued by AGC should be submitted to AGC within 15days after the issuance of the test report. Further enquiry of validity or verification of the test report should be addressed to AGC by agc01@agccert.com.

Attestation of Global Compliance(Shenzhen)Co., Ltd  
Attestation of Global Compliance(Shenzhen)Std & Tech Co., Ltd  
Tel: +86-755 2523 4088 E-mail: agc@agccert.com Web: http://www.agccert.com/



### Band Edge Emission Test Results for Restricted Bands

EUT Name	Wireless USB Adapter	Model Name	AX912
Temperature	22.0°C	Relative Humidity	51.0%
Pressure	960hPa	Test Voltage	DC 5V
Test Mode	Mode 7	Antenna Polarity	Vertical

Test Graph for Peak Measurement

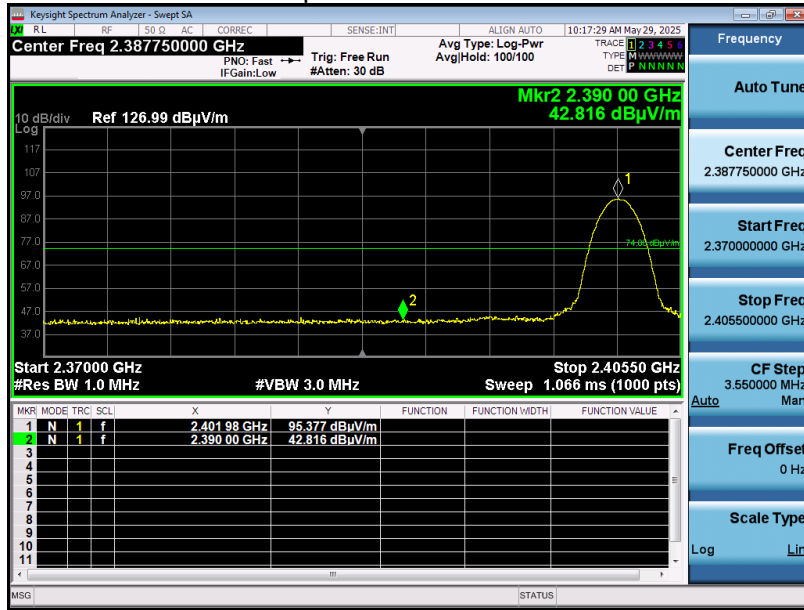

Test Graph for Average Measurement

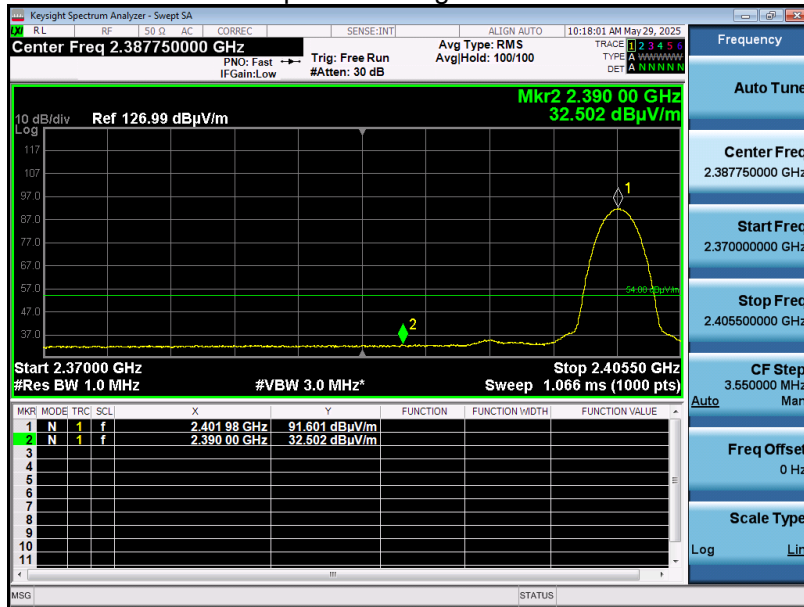

**RESULT: PASS**

Any report having not been signed by authorized approver, or having been altered without authorization, or having not been stamped by the "Dedicated Testing/Inspection Stamp" is deemed to be invalid. Copying or excerpting portion of, or altering the content of the report is not permitted without the written authorization of AGC. The test results presented in the report apply only to the tested sample. Any objections to report issued by AGC should be submitted to AGC within 15days after the issuance of the test report. Further enquiry of validity or verification of the test report should be addressed to AGC by agc01@agccert.com.

Attestation of Global Compliance(Shenzhen)Co., Ltd  
Attestation of Global Compliance(Shenzhen)Std & Tech Co., Ltd  
Tel: +86-755 2523 4088 E-mail: agc@agccert.com Web: http://www.agccert.com/

### Band Edge Emission Test Results for Restricted Bands

<b>EUT Name</b>	Wireless USB Adapter	<b>Model Name</b>	AX912
<b>Temperature</b>	22.0°C	<b>Relative Humidity</b>	51.0%
<b>Pressure</b>	960hPa	<b>Test Voltage</b>	DC 5V
<b>Test Mode</b>	Mode 9	<b>Antenna Polarity</b>	Horizontal

Test Graph for Peak Measurement

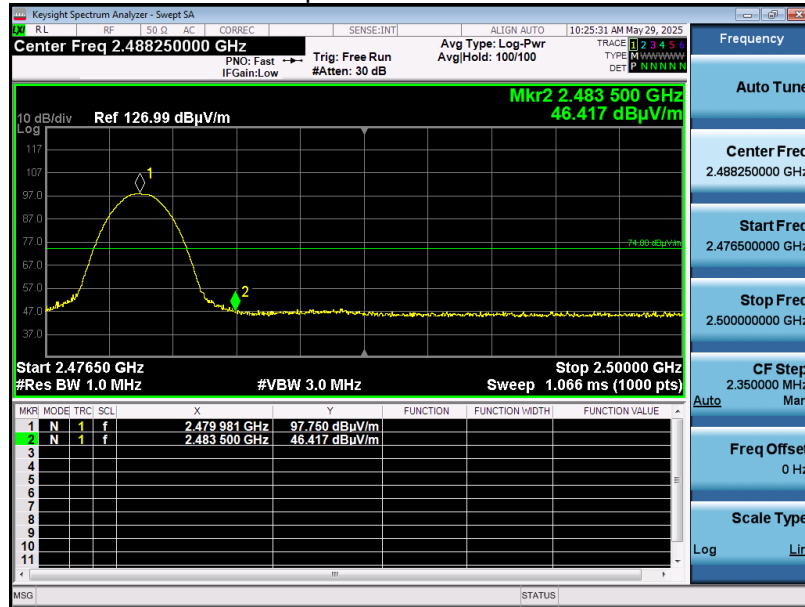

Test Graph for Average Measurement

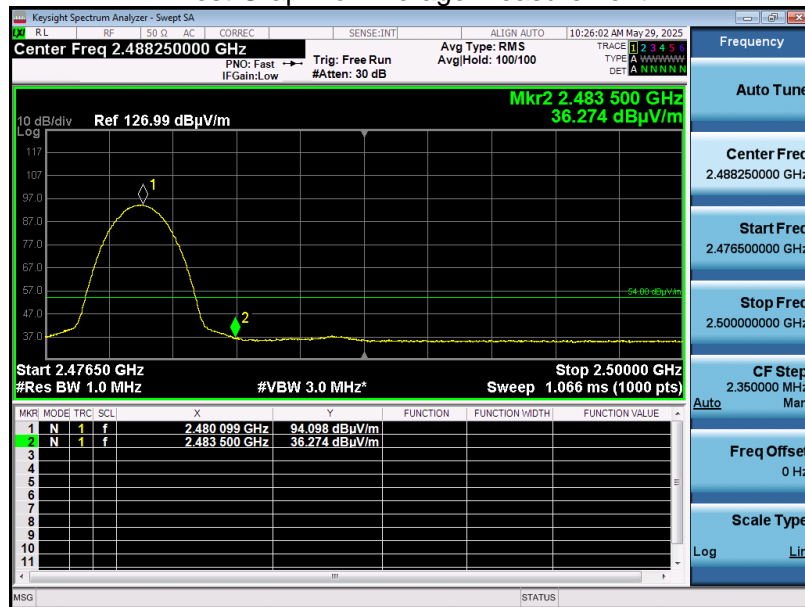

**RESULT: PASS**

Any report having not been signed by authorized approver, or having been altered without authorization, or having not been stamped by the "Dedicated Testing/Inspection Stamp" is deemed to be invalid. Copying or excerpting portion of, or altering the content of the report is not permitted without the written authorization of AGC. The test results presented in the report apply only to the tested sample. Any objections to report issued by AGC should be submitted to AGC within 15days after the issuance of the test report. Further enquiry of validity or verification of the test report should be addressed to AGC by agc01@agccert.com.

Attestation of Global Compliance(Shenzhen)Co., Ltd  
Attestation of Global Compliance(Shenzhen)Std & Tech Co., Ltd  
Tel: +86-755 2523 4088 E-mail: agc@agccert.com Web: http://www.agccert.com/

### Band Edge Emission Test Results for Restricted Bands

EUT Name	Wireless USB Adapter	Model Name	AX912
Temperature	22.0°C	Relative Humidity	51.0%
Pressure	960hPa	Test Voltage	DC 5V
Test Mode	Mode 9	Antenna Polarity	Vertical

Test Graph for Peak Measurement

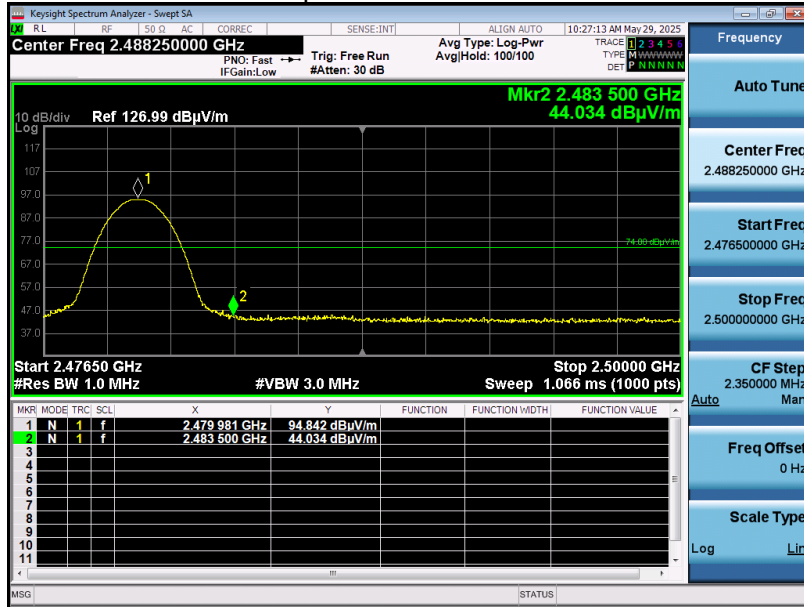

Test Graph for Average Measurement

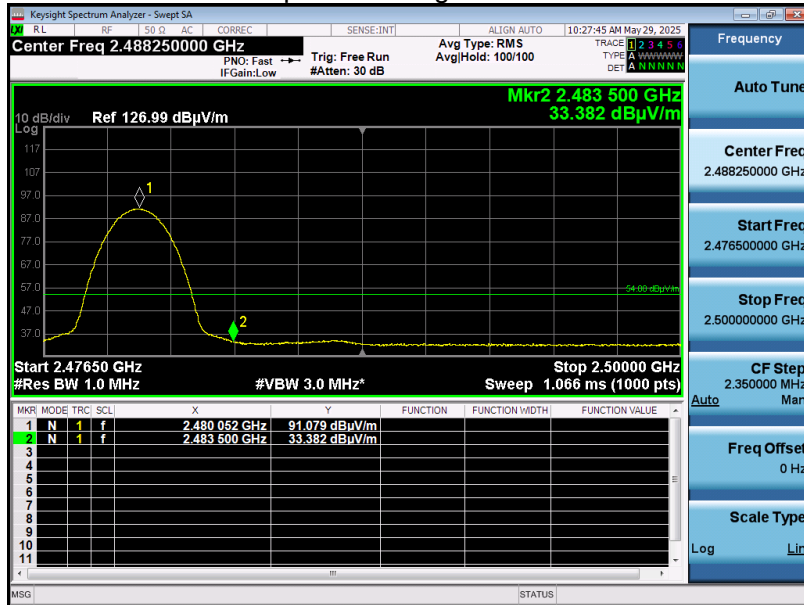

**RESULT: PASS**

Note: 1. The factor had been edited in the “Input Correction” of the Spectrum Analyzer.  
2. All mode rates are tested and evaluated, 8DPSK modulated 3DH5 mode is the worst case and documented in the report.

Any report having not been signed by authorized approver, or having been altered without authorization, or having not been stamped by the “Dedicated Testing/Inspection Stamp” is deemed to be invalid. Copying or excerpting portion of, or altering the content of the report is not permitted without the written authorization of AGC. The test results presented in the report apply only to the tested sample. Any objections to report issued by AGC should be submitted to AGC within 15days after the issuance of the test report. Further enquiry of validity or verification of the test report should be addressed to AGC by agc01@agccert.com.

## 10. Number of Hopping Frequency Measurement

### 10.1 Provisions Applicable

This frequency hopping system must employ a minimum of 15 hopping channels.

### 10.2 Measurement Procedure

The EUT shall have its hopping function enabled. Use the following spectrum analyzer settings:

1. Span = The frequency band of operation. Depending on the number of channels the device supports, it may be necessary to divide the frequency range of operation across multiple spans, to allow the individual channels to be clearly seen.
2. RBW: To identify clearly the individual channels, set the RBW to less than 30% of the channel spacing or the 20 dB bandwidth, whichever is smaller.
3. VBW  $\geq$  RBW
4. Sweep time = Auto couple
5. Detector = Peak
6. Trace mode = Max hold
7. Allow the trace to stabilize

### 10.3 Measurement Setup (Block Diagram of Configuration)

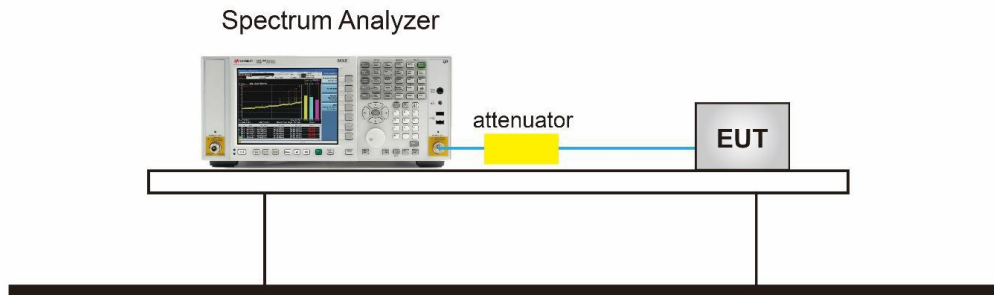

### 10.4 Measurement Result

Test Data of Number of Hopping Frequency			
Test Mode	Number of Hopping Frequency	Limits	Pass or Fail
GFSK Hopping	79	$\geq 15$	Pass
$\pi/4$ -DQPSK Hopping	79	$\geq 15$	Pass
8DPSK Hopping	79	$\geq 15$	Pass

Any report having not been signed by authorized approver, or having been altered without authorization, or having not been stamped by the "Dedicated Testing/Inspection Stamp" is deemed to be invalid. Copying or excerpting portion of, or altering the content of the report is not permitted without the written authorization of AGC. The test results presented in the report apply only to the tested sample. Any objections to report issued by AGC should be submitted to AGC within 15days after the issuance of the test report. Further enquiry of validity or verification of the test report should be addressed to AGC by agc01@agccert.com.

### Test Graphs of Number of Hopping Frequency

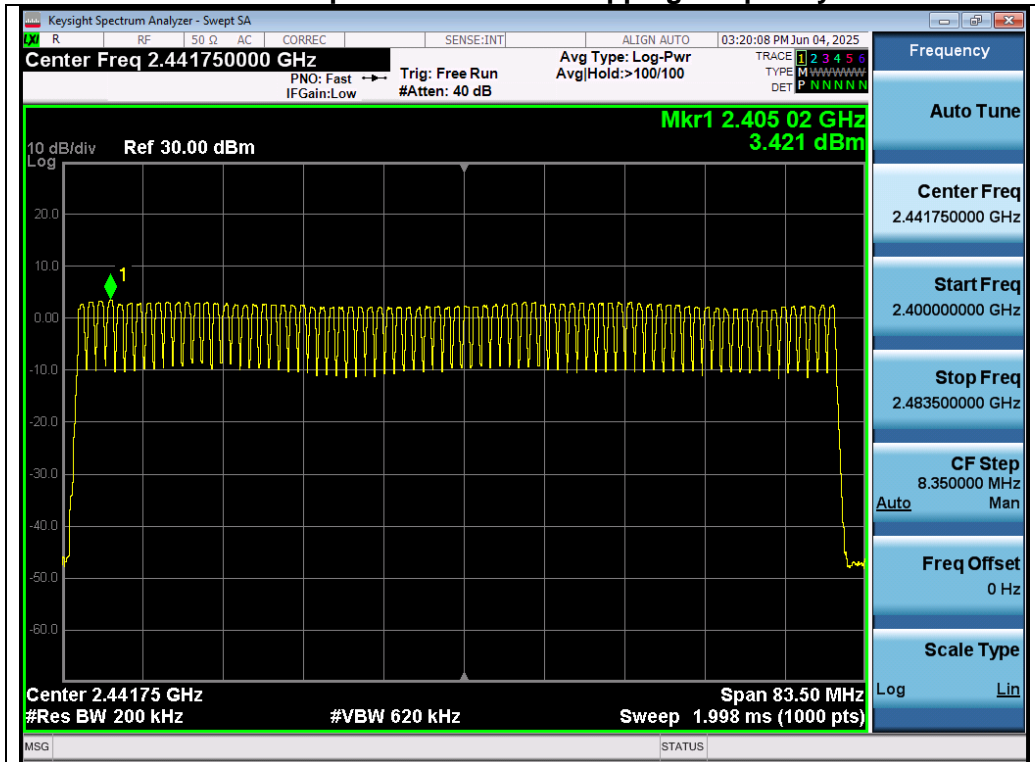

Test\_Graph\_BR\_HOP\_ANT1\_NA\_1Mbps\_Number of Hopping

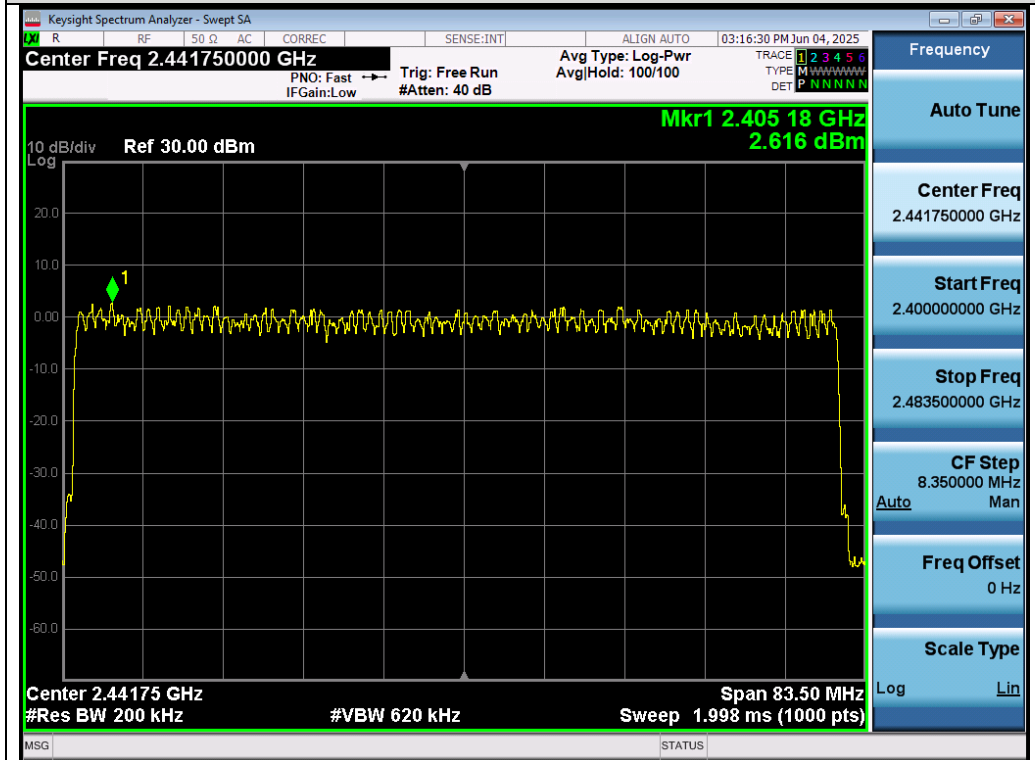

Test\_Graph\_EDR\_HOP\_ANT1\_NA\_2Mbps\_Number of Hopping

Any report having not been signed by authorized approver, or having been altered without authorization, or having not been stamped by the "Dedicated Testing/Inspection Stamp" is deemed to be invalid. Copying or excerpting portion of, or altering the content of the report is not permitted without the written authorization of AGC. The test results presented in the report apply only to the tested sample. Any objections to report issued by AGC should be submitted to AGC within 15days after the issuance of the test report. Further enquiry of validity or verification of the test report should be addressed to AGC by agc01@agccert.com.