



TEST REPORT

No.I21N02204-SAR

For

HMD global Oy

Tablet PC

Model Name: TA-1394

With

Hardware Version: V1.0

Software Version: 00WW_0_23B

FCC ID: 2AJOTTA-1394

Issued Date: 2021-08-30

Designation Number: CN1210

Note:

The test results in this test report relate only to the devices specified in this report. This report shall not be reproduced except in full without the written approval of SAICT.

Test Laboratory:

SAICT, Shenzhen Academy of Information and Communications Technology

Building G, Shenzhen International Innovation Center, No.1006 Shennan Road, Futian District, Shenzhen, Guangdong, P. R. China 518000.

Tel:+86(0)755-33322000, Fax:+86(0)755-33322001

Email: yewu@caict.ac.cn. www.saict.ac.cn



REPORT HISTORY

Report Number	Revision	Description	Issue Date
I21N02204-SAR	Rev.0	1st edition	2021-08-30

TCONTENTS

1. SUMMARY OF TEST REPORT	5
1.1. TEST ITEMS	5
1.2. TEST STANDARDS	5
1.3. TEST RESULT	5
1.4. TESTING LOCATION	5
1.5. PROJECT DATA	5
1.6. SIGNATURE	5
2. STATEMENT OF COMPLIANCE	6
3. CLIENT INFORMATION	8
3.1. APPLICANT INFORMATION.....	8
3.2. MANUFACTURER INFORMATION	8
4. EQUIPMENT UNDER TEST (EUT) AND ANCILLARY EQUIPMENT (AE)	9
4.1. ABOUT EUT	9
4.2. INTERNAL IDENTIFICATION OF EUT USED DURING THE TEST	10
4.3. INTERNAL IDENTIFICATION OF AE USED DURING THE TEST	10
5. TEST METHODOLOGY	11
5.1. APPLICABLE LIMIT REGULATIONS.....	11
5.2. APPLICABLE MEASUREMENT STANDARDS	11
6. SPECIFIC ABSORPTION RATE (SAR).....	12
6.1. INTRODUCTION.....	12
6.2. SAR DEFINITION.....	12
7. TISSUE SIMULATING LIQUIDS	13
7.1. TARGETS FOR TISSUE SIMULATING LIQUID	13
7.2. DIELECTRIC PERFORMANCE	13
8. SYSTEM VERIFICATION	18
8.1. SYSTEM SETUP.....	18
8.2. SYSTEM VERIFICATION	19
9. MEASUREMENT PROCEDURES	20
9.1. TESTS TO BE PERFORMED.....	20
9.2. GENERAL MEASUREMENT PROCEDURE	22
9.3. WCDMA MEASUREMENT PROCEDURES FOR SAR	23
9.4. LTE MEASUREMENT PROCEDURES FOR SAR.....	24
9.5. BLUETOOTH & WLAN MEASUREMENT PROCEDURES FOR SAR.....	24
9.6. POWER DRIFT.....	25
9.7. PROXIMITY SENSOR CONSIDERATIONS	25
10. CONDUCTED OUTPUT POWER	26
10.1. GSM MEASUREMENT RESULT	26
10.2. WCDMA MEASUREMENT RESULT	28
10.3. LTE MEASUREMENT RESULT	31



10.4. BLUETOOTH AND WLAN MEASUREMENT RESULT 81

11. SIMULTANEOUS TX SAR CONSIDERATIONS84

11.1. INTRODUCTION 84

11.2. TRANSMIT ANTENNA SEPARATION DISTANCES 84

11.3. SAR MEASUREMENT POSITIONS..... 85

12. EVALUATION OF SIMULTANEOUS.....86

13. SUMMARY OF TEST RESULTS.....98

13.1. TESTING ENVIRONMENT 98

13.2. SAR RESULTS..... 99

13.3. WLAN EVALUATION FOR 2.4G 106

13.4. WLAN EVALUATION FOR 5G 107

14. SAR MEASUREMENT VARIABILITY109

15. MEASUREMENT UNCERTAINTY 111

15.1. MEASUREMENT UNCERTAINTY FOR NORMAL SAR TESTS (300MHZ~3GHZ) 111

15.2. MEASUREMENT UNCERTAINTY FOR NORMAL SAR TESTS (3GHZ~6GHZ) 112

16. MAIN TEST INSTRUMENTS..... 113

ANNEX A: GRAPH RESULTS 114

ANNEX B: SYSTEMVERIFICATION RESULTS.....128

ANNEX C: SAR MEASUREMENT SETUP.....136

C.1. MEASUREMENT SET-UP 137

C.2. DASY5 E-FIELD PROBE SYSTEM 138

C.3. E-FIELD PROBE CALIBRATION..... 139

C.4. OTHER TEST EQUIPMENT..... 140

ANNEX D: POSITION OF THE WIRELESS DEVICE IN RELATION TO THE PHANTOM.....143

D.1. GENERAL CONSIDERATIONS 143

D.2. BODY-WORN DEVICE 144

D.3. DESKTOP DEVICE..... 144

D.4. DUT SETUP PHOTOS..... 145

ANNEX E: EQUIVALENT MEDIA RECIPES146

ANNEX F: SYSTEM VALIDATION.....147

ANNEX G: DAE CALIBRATION CERTIFICATE148

ANNEX H: PROBE CALIBRATION CERTIFICATE151

ANNEX I: DIPOLE CALIBRATION CERTIFICATE169

ANNEX J: EXTENDED CALIBRATION SAR DIPOLE.....231

ANNEX K: SENSOR TRIGGERING DATA SUMMARY233



1. Summary of Test Report

1.1. Test Items

Description: Tablet PC
Model Name: TA-1394
Applicant's name: HMD global Oy
Manufacturer's Name: HMD global Oy

1.2. Test Standards

ANSI C95.1-1992, IEEE 1528-2013

1.3. Test Result

Pass. Please refer to "13. Summary of Test Results"

1.4. Testing Location

Address: Building G, Shenzhen International Innovation Center, No.1006 Shennan Road, Futian District, Shenzhen, Guangdong, P. R. China

1.5. Project Data

Testing Start Date: 2021-08-06

Testing End Date: 2021-08-16

1.6. Signature

Li Yongfu

(Prepared this test report)

Zhang Yunzhan

(Reviewed this test report)

Cao Junfei

(Approved this test report)

2. Statement of Compliance

The maximum results of Specific Absorption Rate (SAR) found during testing for HMD global Oy Tablet PC TA-1394 are as follows:

Table 2.1: Highest Reported SAR for Body (1g)

Exposure Configuration	Technology Band	Highest Reported SAR 1g(W/Kg)	Equipment Class
Body	GSM850	0.55	PCE
	GSM1900	1.34	
	WCDMA Band 2	1.06	
	WCDMA Band 4	0.69	
	WCDMA Band 5	0.50	
	LTE Band 2	1.16	
	LTE Band 5	1.01	
	LTE Band 7	1.09	
	LTE Band 12	1.00	
	LTE Band 13	0.58	
	LTE Band 66	0.79	
	Bluetooth	0.07	
	WLAN 2.4GHz	0.65	DTS
	WLAN 5GHz	1.15	NII

The SAR values found for the Mobile Phone are below the maximum recommended levels of 1.6 W/Kg as averaged over any 1g tissue according to the ANSI C95.1-1992.

The EUT battery must be fully charged and checked periodically during the test to ascertain uniform power output.

The measurement together with the test system set-up is described in annex C of this test report. A detailed description of the equipment under test can be found in chapter 4 of this test report.

The highest reported SAR value is obtained at the case of (Table 2.1), the value is: **1.34 W/kg (1g)**.

Table2.2: The sum of reported SAR values for WWAN antenna and WLAN antenna

/	Position	WWAN (W/kg)	WLAN (W/kg)	Sum (W/kg)
Highest reported SAR value for Body	Top	0.42	1.15	1.57

Note: the test positions of above tables are for the worse case that has been evaluated.

Table2.3: The sum of reported SAR values for WWAN antenna and Bluetooth antenna

/	Position	WWAN (W/kg)	Bluetooth (W/kg)	Sum (W/kg)
Highest reported SAR value for Body	Top	1.34	0.02	1.36

Note: the test positions of above tables are for the worse case that has been evaluated.

According to the above tables, the highest sum of reported SAR values is **1.57 W/kg (1g)**.

The detail for simultaneous transmission consideration is described in chapter 12.



3. Client Information

3.1. Applicant Information

Company Name:	HMD global Oy
Address:	Bertel Jungin aukio 9, 02600 Espoo, Finland.
City:	/
Country:	/
Telephone:	+393 316272922

3.2. Manufacturer Information

Company Name:	HMD global Oy
Address:	Bertel Jungin aukio 9, 02600 Espoo, Finland.
City:	/
Country:	/
Telephone:	+393 316272922

4. Equipment under Test (EUT) and Ancillary Equipment (AE)

4.1. About EUT

Description:	Tablet PC
Model Name:	TA-1394
Condition of EUT as received:	No obvious damage in appearance
Operating mode(s):	GSM850/1900, WCDMA Band2/4/5, LTE Band2/4/5/7/12/13/17/66, Bluetooth, WLAN 2.4G/5G
Condition of EUT as received:	No obvious damage in appearance
Tested Tx Frequency:	824-849MHz (GSM 850)
	1850-1910MHz (GSM 1900)
	1850-1910MHz (WCDMA Band 2)
	1710-1755MHz (WCDMA Band 4)
	824-849MHz (WCDMA Band 5)
	1850 -1910MHz (LTE Band 2)
	1710-1755MHz (LTE Band 4)
	824-849MHz (LTE Band 5)
	2500-2570MHz (LTE Band 7)
	699-716MHz (LTE Band 12)
	777-787MHz (LTE Band 13)
	704-716MHz (LTE Band 17)
	1710-1780MHz (LTE Band 66)
	2402 – 2480MHz (Bluetooth)
2412 – 2462MHz (WLAN 2.4G)	
5180 – 5825MHz (WLAN 5G)	
GPRS / EGPRS Multislot Class:	12
GPRS capability Class:	B
Test device Production information:	Production unit
Device type:	Portable device
Antenna type:	Integrated antenna
Product Dimensions:	Long 247.56mm; Wide 157.44mm; Overall Diagonal 282mm

**4.2. Internal Identification of EUT used during the test**

EUT ID*	IMEI	HW Version	SW Version	Receipt Date
UT06aa	353193550104844	V1.0	00WW_0_23B	2021-07-15
UT09aa	353193550104919	V1.0	00WW_0_23B	2021-07-15
UT10aa	353193550104992	V1.0	00WW_0_23B	2021-07-15

*EUT ID: is used to identify the test sample in the lab internally.

Note: It is performed to test SAR with the UT10aa & UT09aa, and conducted power with the UT06aa.

4.3. Internal Identification of AE used during the test

AE ID*	Description	Model	Manufacturer
AE1	Battery	EMT80	HUNAN GAOYUAN BATTERY COMPANY LIMITED

*AE ID: is used to identify the test sample in the lab internally.



5. Test Methodology

5.1. Applicable Limit Regulations

ANSI C95.1–1992 IEEE Standard for Safety Levels with Respect to Human Exposure to Radio Frequency Electromagnetic Fields, 3 kHz to 300 GHz

It specifies the maximum exposure limit of **1.60 W/kg** as averaged over any 1 gram of tissue for portable devices being used within 20 cm of the user in the uncontrolled environment.

5.2. Applicable Measurement Standards

IEEE 1528–2013 Recommended Practice for Determining the Peak Spatial-Average Specific Absorption Rate (SAR) in the Human Head from Wireless Communications Devices: Experimental Techniques

KDB 447498 D01 General RF Exposure Guidance v06 Mobile and Portable Devices RF Exposure Procedures and Equipment Authorization Policies

KDB 616217 D04 SAR for laptop and tablets v01r02 SAR Evaluation Considerations for Laptop, Notebook, Notebook and Tablet Computers

KDB 941225 D01 SAR test for 3G devices v03r01 SAR Measurement Procedures for 3G Devices

KDB 941225 D05 SAR for LTE Devices v02r05 SAR Evaluation Considerations for LTE Devices

KDB 248227 D01 802.11 Wi-Fi SAR v02r02 SAR Guidance for IEEE 802.11 (Wi-Fi) Transmitters

KDB 865664 D01 SAR measurement 100 MHz to 6 GHz v01r04 SAR Measurement Requirements for 100 MHz to 6 GHz

KDB 865664 D02 RF Exposure Reporting v01r02 RF Exposure Compliance Reporting and Documentation Considerations

TCB workshop April 2019; RF Exposure Procedures (Tissue Simulating Liquids)

6. Specific Absorption Rate (SAR)

6.1. Introduction

SAR is related to the rate at which energy is absorbed per unit mass in an object exposed to a radio field. The SAR distribution in a biological body is complicated and is usually carried out by experimental techniques or numerical modeling. The standard recommends limits for two tiers of groups, occupational/controlled and general population/uncontrolled, based on a person's awareness and ability to exercise control over his or her exposure. In general, occupational/controlled exposure limits are higher than the limits for general population/uncontrolled.

6.2. SAR Definition

The SAR definition is the time derivative (rate) of the incremental energy (dW) absorbed by (dissipated in) an incremental mass (dm) contained in a volume element (dv) of a given density (ρ). The equation description is as below:

$$SAR = \frac{d}{dt} \left(\frac{dW}{dm} \right) = \frac{d}{dt} \left(\frac{dW}{\rho dv} \right)$$

SAR is expressed in units of Watts per kilogram (W/kg)

SAR measurement can be either related to the temperature elevation in tissue by

$$SAR = c \left(\frac{\delta T}{\delta t} \right)$$

Where: C is the specific heat capacity, δT is the temperature rise and δt is the exposure duration, or related to the electrical field in the tissue by

$$SAR = \frac{\sigma |E|^2}{\rho}$$

Where: σ is the conductivity of the tissue, ρ is the mass density of tissue and E is the RMS electrical field strength.

However for evaluating SAR of low power transmitter, electrical field measurement is typically applied.

7. Tissue Simulating Liquids

7.1. Targets for tissue simulating liquid

Table 7.1: Targets for tissue simulating liquid

Frequency (MHz)	Liquid Type	Conductivity (σ)	$\pm 5\%$ Range	Permittivity (ϵ)	$\pm 5\%$ Range
750	Head	0.89	0.85~0.93	41.9	39.8~44.0
835	Head	0.90	0.86~0.95	41.5	39.4~43.6
1750	Head	1.37	1.30~1.44	40.1	38.1~42.1
1900	Head	1.40	1.33~1.47	40.0	38.0~42.0
2450	Head	1.80	1.71~1.89	39.2	37.2~41.2
2550	Head	1.91	1.81~2.01	39.1	37.1~41.0
5250	Head	4.71	4.47~4.95	35.9	34.1~37.7
5600	Head	5.07	4.82~5.32	35.5	33.8~37.3
5750	Head	5.22	4.96~5.48	35.4	33.6~37.1

7.2. Dielectric Performance

Table 7.2: Dielectric Performance of Tissue Simulating Liquid

Measurement Date (yyyy-mm-dd)	Type	Frequency	Conductivity σ (S/m)	Drift (%)	Permittivity ϵ	Drift (%)
2021-08-09	Head	750 MHz	0.919	3.26	41.03	-2.08
2021-08-06	Head	835 MHz	0.925	2.78	40.46	-2.51
2021-08-15	Head	1750 MHz	1.362	-0.58	39.74	-0.85
2021-08-16	Head	1900 MHz	1.385	-1.07	39.23	-1.93
2021-08-08	Head	2450 MHz	1.849	2.72	38.44	-1.94
2021-08-13	Head	2550 MHz	1.946	1.88	37.98	-2.79
2021-08-10	Head	5250 MHz	4.652	-1.23	36.54	1.70
2021-08-10	Head	5600 MHz	5.143	1.44	35.15	-1.07
2021-08-10	Head	5750 MHz	5.309	1.70	34.82	-1.64

Note: The liquid temperature is 22.0°C.

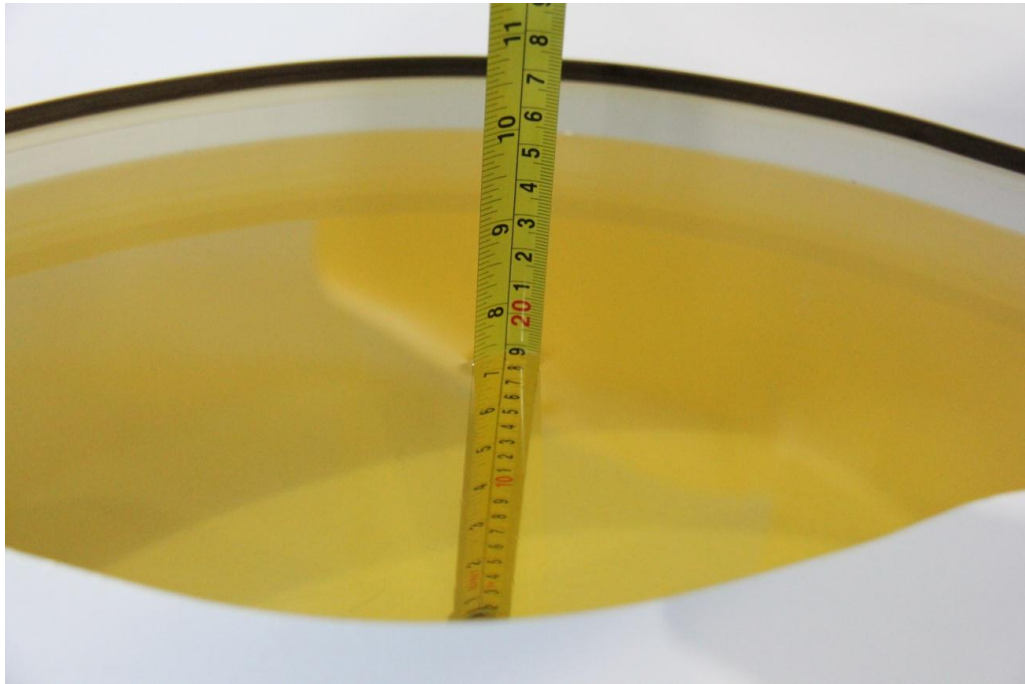

Picture 7-1: Liquid depth in the Flat Phantom (750MHz)

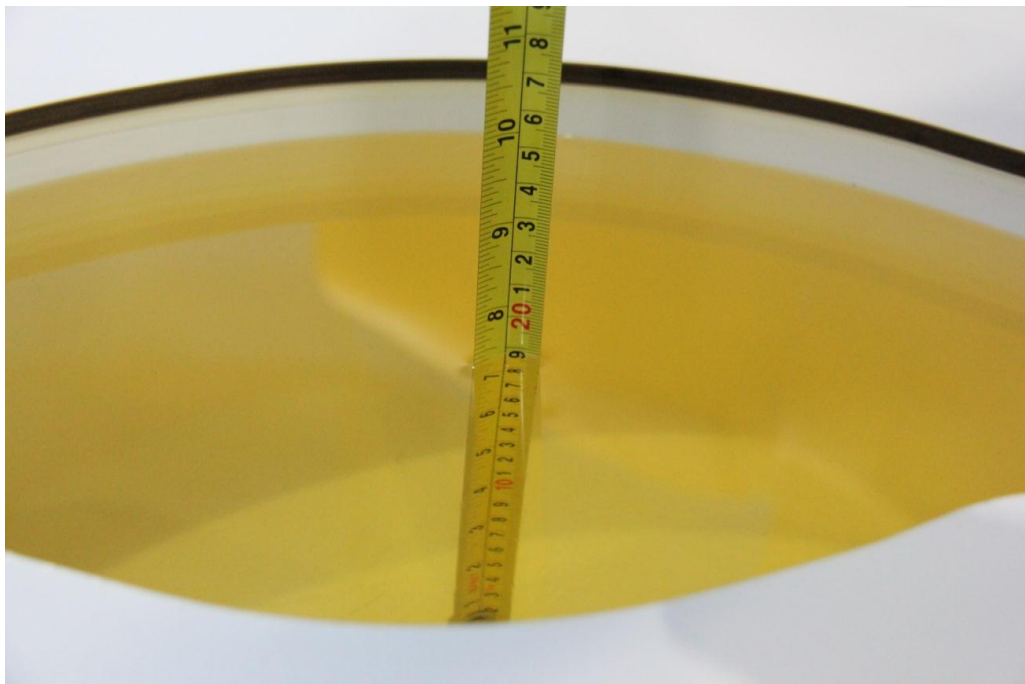

Picture 7-2: Liquid depth in the Flat Phantom (835MHz)

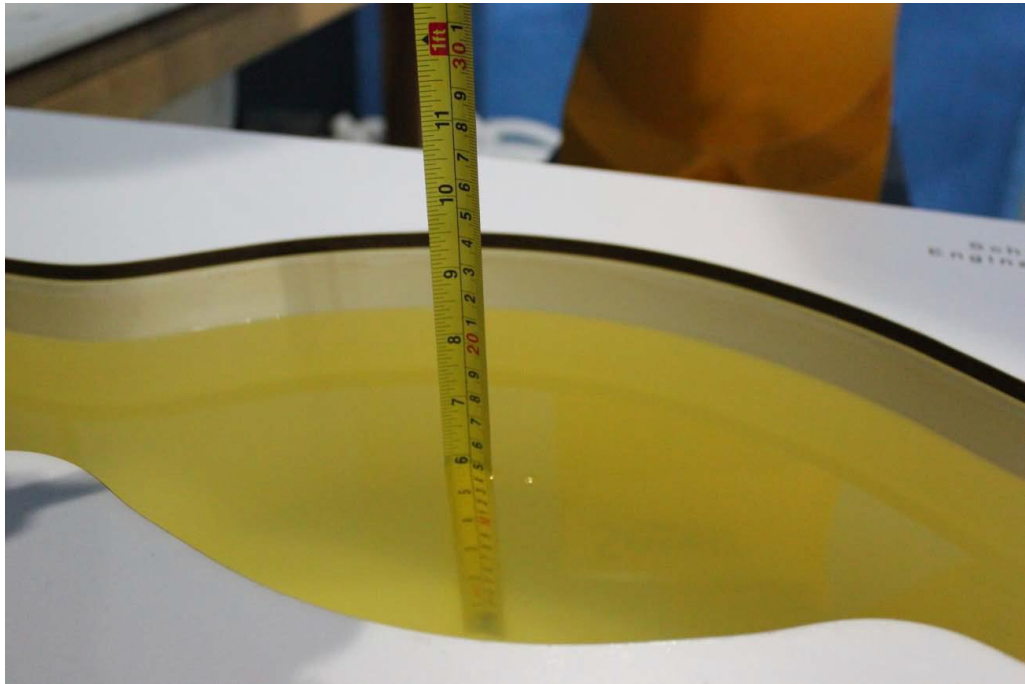

Picture 7-3: Liquid depth in the Flat Phantom (1750MHz)



Picture 7-4: Liquid depth in the Flat Phantom (1900MHz)



Picture 7-5: Liquid depth in the Flat Phantom(2450MHz)

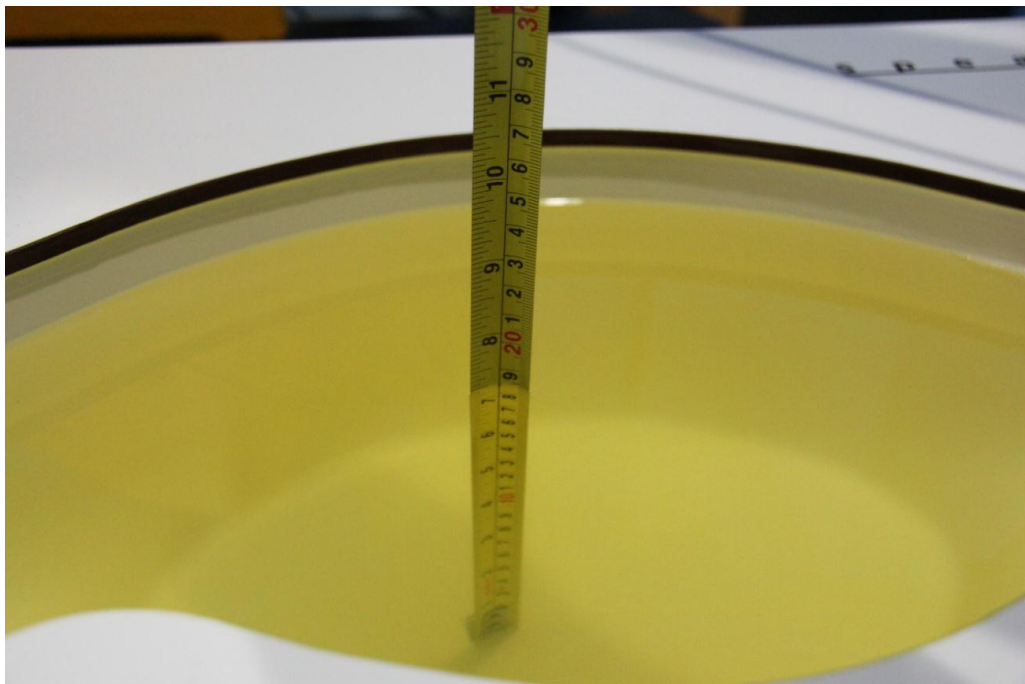

Picture 7-6: Liquid depth in the Flat Phantom(2550MHz)



Picture 7-7: Liquid depth in the Flat Phantom(5GHz)

8. System verification

8.1. System Setup

In the simplified setup for system evaluation, the DUT is replaced by a calibrated dipole and the power source is replaced by a continuous wave that comes from a signal generator. The calibrated dipole must be placed beneath the flat phantom section of the SAM twin phantom with the correct distance holder. The distance holder should touch the phantom surface with a light pressure at the reference marking and be oriented parallel to the long side of the phantom. The equipment setup is shown below:

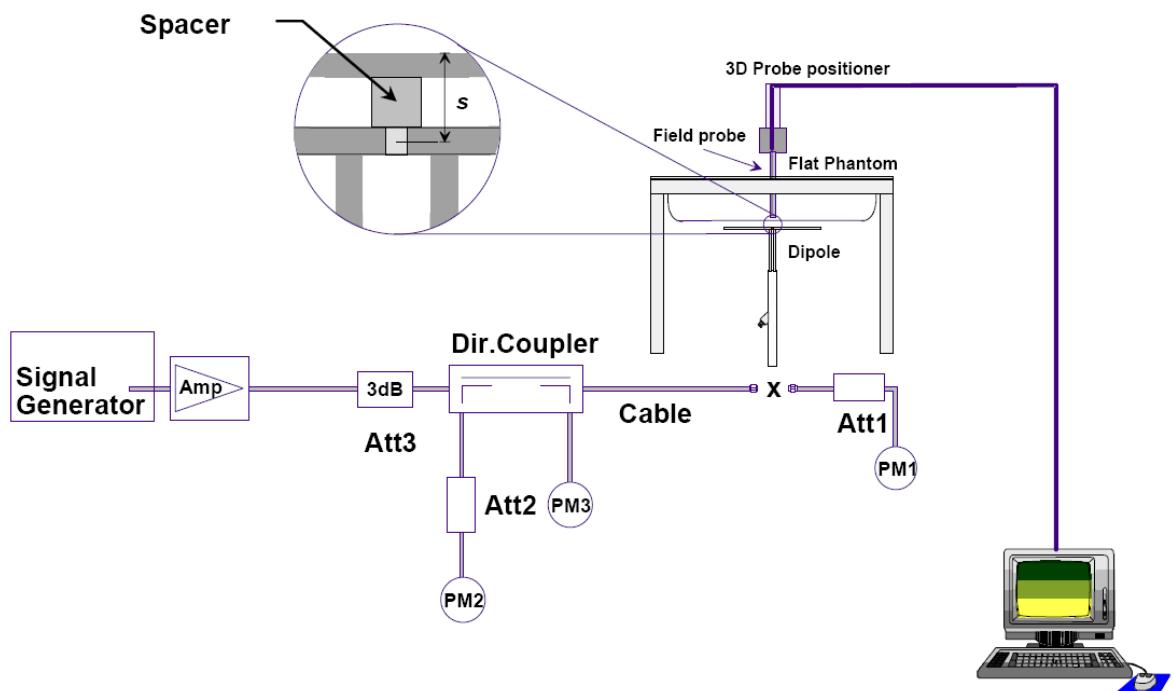

Picture 8.1 System Setup for System Evaluation

For the dipole below 3GHz, the output power on dipole port must be calibrated to 24 dBm (250mW) before dipole is connected.

For the dipole above 3GHz, the output power on dipole port must be calibrated to 20 dBm (100mW) before dipole is connected.

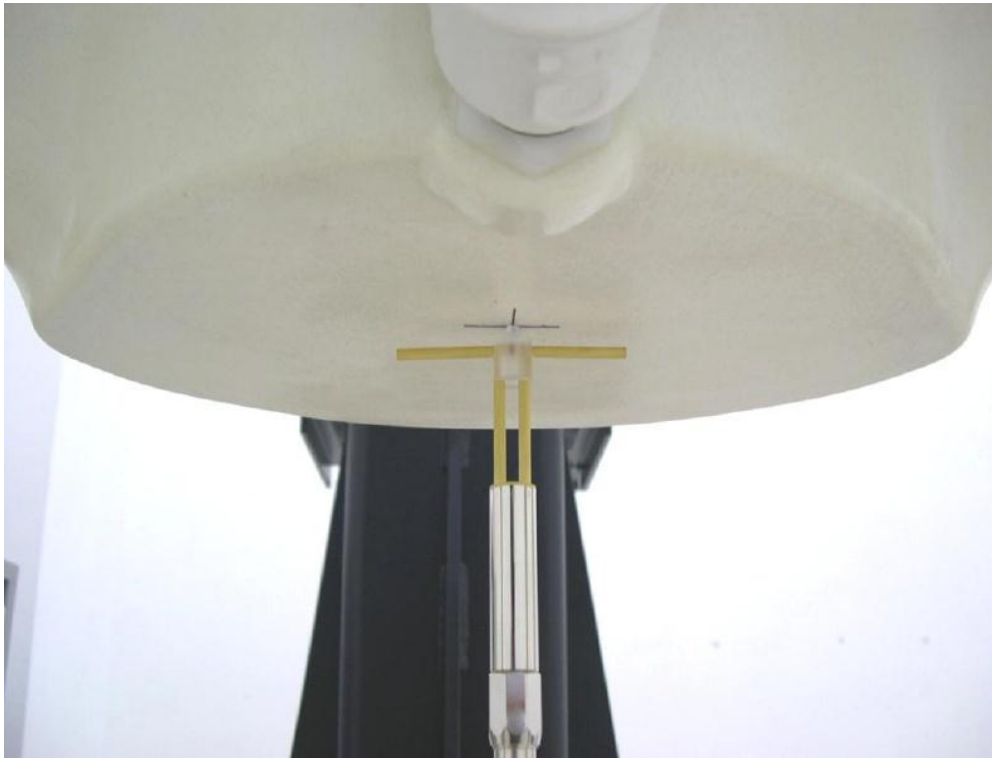

Picture 8.2 Photo of Dipole Setup

8.2. System Verification

SAR system verification is required to confirm measurement accuracy, according to the tissue dielectric media, probe calibration points and other system operating parameters required for measuring the SAR of a test device. The system verification must be performed for each frequency band and within the valid range of each probe calibration point required for testing the device.

Table 8.1: System Verification of Head

Measurement Date	Frequency (MHz)	Target value (W/kg)		Measured value (W/kg)				Deviation (%)	
		10 g	1 g	/		Normalize to 1W		10 g	1 g
				10 g	1 g	10 g	1 g		
2021-08-09	750	5.70	8.53	1.46	2.22	5.84	8.88	2.46	4.10
2021-08-06	835	6.29	9.62	1.60	2.48	6.40	9.92	1.75	3.12
2021-08-15	1750	19.30	36.40	4.78	8.92	19.12	35.68	-0.93	-1.98
2021-08-16	1900	21.00	40.50	5.15	9.83	20.60	39.32	-1.90	-2.91
2021-08-08	2450	24.10	52.00	6.19	13.6	24.76	54.40	2.74	4.62
2021-08-13	2550	25.20	55.90	6.42	14.4	25.68	57.60	1.90	3.04
2021-08-10	5250	22.30	78.00	2.18	7.52	21.80	75.20	-2.24	-3.59
2021-08-10	5600	22.70	79.50	2.33	8.25	23.30	82.50	2.64	3.77
2021-08-10	5750	22.20	78.40	2.26	8.14	22.60	81.40	1.80	3.83

9. Measurement Procedures

9.1. Tests to be performed

In order to determine the highest value of the peak spatial-average SAR of a handset, all device positions, configurations and operational modes shall be tested for each frequency band according to steps 1 to 3 below. A flowchart of the test process is shown in picture 9.1.

Step 1: The tests described in 9.2 shall be performed at the channel that is closest to the center of the transmit frequency band (f_c) for:

- a) all device positions (cheek and tilt, for both left and right sides of the SAM phantom, as described in annex D),
- b) all configurations for each device position in a), e.g., antenna extended and retracted, and
- c) all operational modes, e.g., analogue and digital, for each device position in a) and configuration in b) in each frequency band.

If more than three frequencies need to be tested according to 11.1 (i.e., $N_c > 3$), then all frequencies, configurations and modes shall be tested for all of the above test conditions.

Step 2: For the condition providing highest peak spatial-average SAR determined in Step 1, perform all tests described in 9.2 at all other test frequencies, i.e., lowest and highest frequencies. In addition, for all other conditions (device position, configuration and operational mode) where the peak spatial-average SAR value determined in Step 1 is within 3 dB of the applicable SAR limit, it is recommended that all other test frequencies shall be tested as well.

Step 3: Examine all data to determine the highest value of the peak spatial-average SAR found in Steps 1 to 2.

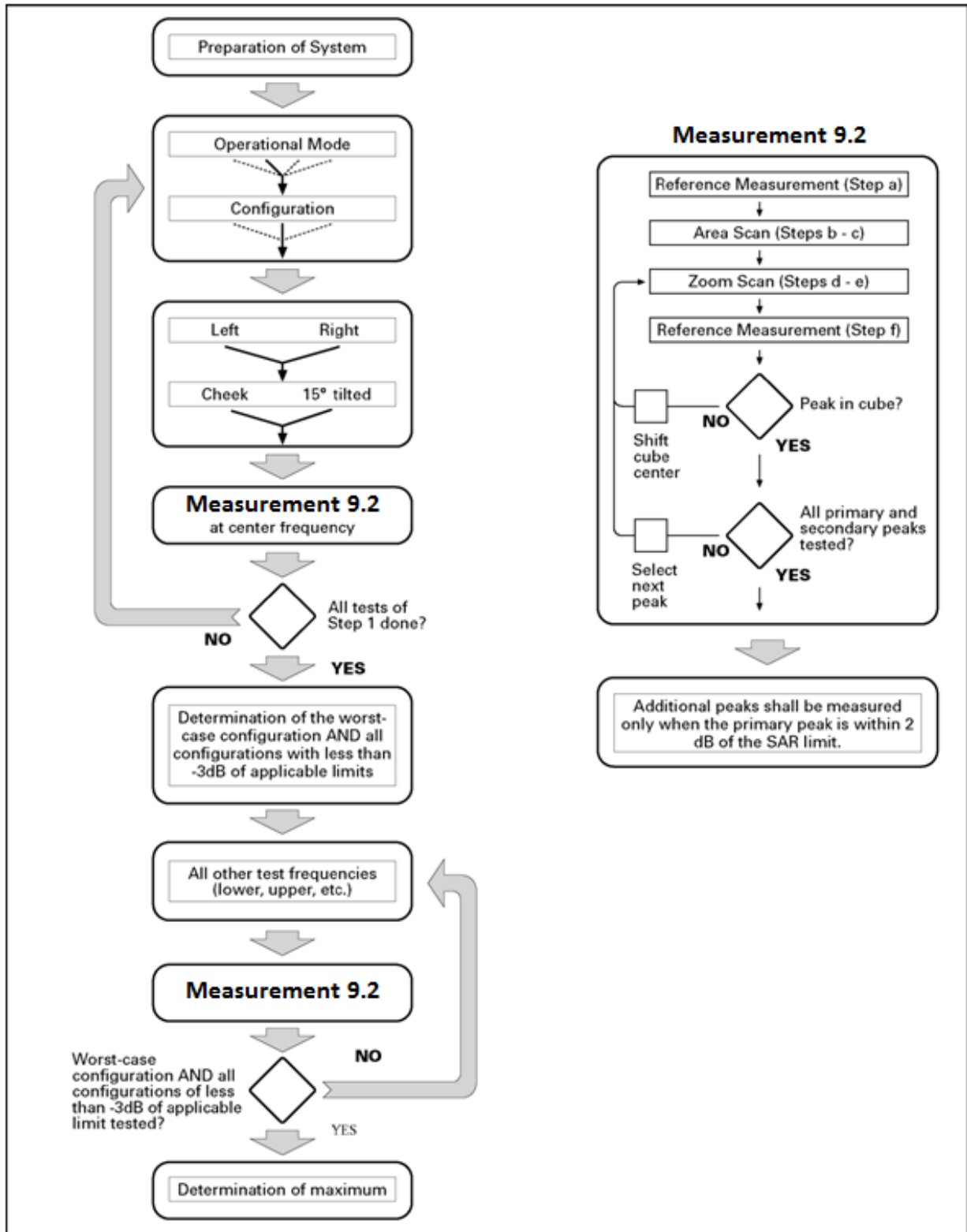

Picture 9.1 Block diagram of the tests to be performed

9.2. General Measurement Procedure

The area and zoom scan resolutions specified in the table below must be applied to the SAR measurements and fully documented in SAR reports to qualify for TCB approval. Probe boundary effect error compensation is required for measurements with the probe tip closer than half a probe tip diameter to the phantom surface. Both the probe tip diameter and sensor offset distance must satisfy measurement protocols; to ensure probe boundary effect errors are minimized and the higher fields closest to the phantom surface can be correctly measured and extrapolated to the phantom surface for computing 1-g SAR. Tolerances of the post-processing algorithms must be verified by the test laboratory for the scan resolutions used in the SAR measurements, according to the reference distribution functions specified in IEEE Std 1528-2013. The results should be documented as part of the system validation records and may be requested to support test results when all the measurement parameters in the following table are not satisfied.

		≤ 3 GHz	> 3 GHz
Maximum distance from closest measurement point (geometric center of probe sensors) to phantom surface		5 ± 1 mm	$\frac{1}{2} \cdot \delta \cdot \ln(2) \pm 0.5$ mm
Maximum probe angle from probe axis to phantom surface normal at the measurement location		$30^\circ \pm 1^\circ$	$20^\circ \pm 1^\circ$
Maximum area scan spatial resolution: Δx_{Area} , Δy_{Area}		≤ 2 GHz: ≤ 15 mm 2 – 3 GHz: ≤ 12 mm	3 – 4 GHz: ≤ 12 mm 4 – 6 GHz: ≤ 10 mm
		When the x or y dimension of the test device, in the measurement plane orientation, is smaller than the above, the measurement resolution must be \leq the corresponding x or y dimension of the test device with at least one measurement point on the test device.	
Maximum zoom scan spatial resolution: Δx_{Zoom} , Δy_{Zoom}		≤ 2 GHz: ≤ 8 mm 2 – 3 GHz: ≤ 5 mm*	3 – 4 GHz: ≤ 5 mm* 4 – 6 GHz: ≤ 4 mm*
Maximum zoom scan spatial resolution, normal to phantom surface	uniform grid: $\Delta z_{Zoom}(n)$	≤ 5 mm	3 – 4 GHz: ≤ 4 mm 4 – 5 GHz: ≤ 3 mm 5 – 6 GHz: ≤ 2 mm
	graded grid	$\Delta z_{Zoom}(1)$: between 1 st two points closest to phantom surface	≤ 4 mm
		$\Delta z_{Zoom}(n>1)$: between subsequent points	$\leq 1.5 \cdot \Delta z_{Zoom}(n-1)$
Minimum zoom scan volume	x, y, z	≥ 30 mm	3 – 4 GHz: ≥ 28 mm 4 – 5 GHz: ≥ 25 mm 5 – 6 GHz: ≥ 22 mm
Note: δ is the penetration depth of a plane-wave at normal incidence to the tissue medium; see draft standard IEEE P1528-2011 for details. * When zoom scan is required and the <i>reported</i> SAR from the area scan based 1-g SAR estimation procedures of KDB 447498 is ≤ 1.4 W/kg, ≤ 8 mm, ≤ 7 mm and ≤ 5 mm zoom scan resolution may be applied, respectively, for 2 GHz to 3 GHz, 3 GHz to 4 GHz and 4 GHz to 6 GHz.			

9.3. WCDMA Measurement Procedures for SAR

The following procedures are applicable to WCDMA handsets operating under 3GPP Release99, Release 5 and Release 6. The default test configuration is to measure SAR with an established radio link between the DUT and a communication test set using a 12.2kbps RMC (reference measurement channel) configured in Test Loop Mode 1. SAR is selectively confirmed for other physical channel configurations (DPCCH & DPDCH_n), HSDPA and HSPA (HSUPA/HSDPA) modes according to output power, exposure conditions and device operating capabilities. Both uplink and downlink should be configured with the same RMC or AMR, when required. SAR for Release 5 HSDPA and Release 6 HSPA are measured using the applicable FRC (fixed reference channel) and E-DCH reference channel configurations. Maximum output power is verified according to applicable versions of 3GPP TS 34.121 and SAR must be measured according to these maximum output conditions. When Maximum Power Reduction (MPR) is not implemented according to Cubic Metric (CM) requirements for Release 6 HSPA, the following procedures do not apply.

For Release 5 HSDPA Data Devices:

Sub-test	β_c	β_d	β_d (SF)	β_c / β_d	β_{hs}	CM/dB
1	2/15	15/15	64	2/15	4/15	0.0
2	12/15	15/15	64	12/15	24/25	1.0
3	15/15	8/15	64	15/8	30/15	1.5
4	15/15	4/15	64	15/4	30/15	1.5

For Release 6 HSPA Data Devices

Sub-test	β_c	β_d	β_d (SF)	β_c / β_d	β_{hs}	β_{ec}	β_{ed}	β_{ed} (SF)	β_{ed} (codes)	CM (dB)	MPR (dB)	AG Index	E-TFCI
1	11/15	15/15	64	11/15	22/15	209/225	1039/225	4	1	1.0	0.0	20	75
2	6/15	15/15	64	6/15	12/15	12/15	12/15	4	1	3.0	2.0	12	67
3	15/15	9/15	64	15/9	30/15	30/15	$\beta_{ed1}:47/15$ $\beta_{ed2}:47/15$	4	2	2.0	1.0	15	92
4	2/15	15/15	64	2/15	4/15	4/15	56/75	4	1	3.0	2.0	17	71
5	15/15	15/15	64	15/15	24/15	30/15	134/15	4	1	1.0	0.0	21	81

9.4. LTE Measurement Procedures for SAR

SAR tests for LTE are performed with a base station simulator, Anristu MT8820C. Closed loop power control was used so the UE transmits with maximum output power during SAR testing. All powers were measured with the Anristu MT8820C. It is performed for conducted power and SAR based on the KDB941225 D05.

SAR is evaluated separately according to the following procedures for the different test positions in each exposure condition – head, body, body-worn accessories and other use conditions. The procedures in the following subsections are applied separately to test each LTE frequency band.

1) QPSK with 1 RB allocation

Start with the largest channel bandwidth and measure SAR for QPSK with 1 RB allocation, using the RB offset and required test channel combination with the highest maximum output power among RB offsets at the upper edge, middle and lower edge of each required test channel. When the reported SAR is ≤ 0.8 W/kg, testing of the remaining RB offset configurations and required test channels is not required for 1 RB allocation; otherwise, SAR is required for the remaining required test channels and only for the RB offset configuration with the highest output power for that channel. When the reported SAR of a required test channel is > 1.45 W/kg, SAR is required for all three RB offset configurations for that required test channel.

2) QPSK with 50% RB allocation

The procedures required for 1 RB allocation in 1) are applied to measure the SAR for QPSK with 50% RB allocation.

3) QPSK with 100% RB allocation

For QPSK with 100% RB allocation, SAR is not required when the highest maximum output power for 100 % RB allocation is less than the highest maximum output power in 50% and 1 RB allocations and the highest reported SAR for 1 RB and 50% RB allocation in 1) and 2) are ≤ 0.8 W/kg. Otherwise, SAR is measured for the highest output power channel; and if the reported SAR is > 1.45 W/kg, the remaining required test channels must also be tested.

9.5. Bluetooth & WLAN Measurement Procedures for SAR

Normal network operating configurations are not suitable for measuring the SAR of 802.11 transmitters in general. Unpredictable fluctuations in network traffic and antenna diversity conditions can introduce undesirable variations in SAR results. The SAR for these devices should be measured using chipset based test mode software to ensure that the results are consistent and reliable.

Chipset based test mode software is hardware dependent and generally varies among manufacturers. The device operating parameters established in a test mode for SAR measurements must be identical to those programmed in production units, including output power levels, amplifier gain settings and other RF performance tuning parameters. The test frequencies should correspond to actual channel frequencies defined for domestic use. SAR for devices with switched diversity should be measured with only one antenna transmitting at a time during each SAR measurement, according to a fixed modulation and data rate. The same data pattern should be used for all measurements.



9.6. Power Drift

To control the output power stability during the SAR test, DASY5 system calculates the power drift by measuring the E-field at the same location at the beginning and at the end of the measurement for each test position. These drift values can be found in Section 14 labeled as: (Power Drift [dB]). This ensures that the power drift during one measurement is within 5%.

9.7. Proximity Sensor Considerations

This device uses a proximity sensor that share the same metallic electrode as the transmitting antenna to facilitate triggering in typical user interactivity with the device. Due to the operating configurations and exposure conditions required by the device, the proximity sensor is used to indicate when the tablet is held close to a user's body exposure condition. It utilizes the proximity sensor to reduce the output power in specific wireless and operating modes to ensure SAR compliance for the following scenarios: To reduce the output power of main antennas during body operating configurations. . It is also set an output power leveled to the lowest one to make sure that in any case of SAR sensor hardware failure the SAR requirements can still be satisfied.

Sensor triggering distance summary data is included in Appendix K.

10. Conducted Output Power

10.1. GSM Measurement result

During the process of testing, the EUT was controlled via Agilent Digital Radio Communication tester (E5515C) to ensure the maximum power transmission and proper modulation. This result contains conducted output power for the EUT. In all cases, the measured peak output power should be greater and within 5% than EMI measurement.

Table 10.1: The conducted power measurement results for GPRS and EGPRS

Full Power								
GPRS850/ EGPRS850	Tune up	Measured Power (dBm)			calculation	Average Power (dBm)		
		251	190	128		251	190	128
1Tx-slots	33.5	33.16	32.91	32.83	-9.03dB	24.13	23.88	23.80
2Tx-slots	31.5	30.84	30.82	30.95	-6.02dB	24.82	24.80	24.93
3Tx-slots	29.5	28.90	28.88	28.94	-4.26dB	24.64	24.62	24.68
4Tx-slots	27.5	26.71	26.68	26.78	-3.01dB	23.70	23.67	23.77
EGPRS 850 (8PSK)	Tune up	Measured Power (dBm)			calculation	Measured Power (dBm)		
		251	190	128		251	190	128
1Tx-slots	26.5	25.78	26.06	25.94	-9.03dB	16.75	17.03	16.91
2Tx-slots	25.5	24.43	24.82	24.63	-6.02dB	18.41	18.80	18.61
3Tx-slots	23.0	21.84	22.21	22.05	-4.26dB	17.58	17.95	17.79
4Tx-slots	20.5	19.46	19.75	19.62	-3.01dB	16.45	16.74	16.61
Sensor on								
GPRS850/ EGPRS850	Tune up	Measured Power (dBm)			calculation	Average Power (dBm)		
		251	190	128		251	190	128
1Tx-slots	19.0	18.79	18.79	18.86	-9.03dB	9.76	9.76	9.83
2Tx-slots	19.0	18.66	18.59	18.76	-6.02dB	12.64	12.57	12.74
3Tx-slots	19.0	18.47	18.43	18.52	-4.26dB	14.21	14.17	14.26
4Tx-slots	19.0	18.32	18.28	18.23	-3.01dB	15.31	15.27	15.22
EGPRS 850 (8PSK)	Tune up	Measured Power (dBm)			calculation	Measured Power (dBm)		
		251	190	128		251	190	128
1Tx-slots	12.5	12.09	12.16	11.98	-9.03dB	3.06	3.13	2.95
2Tx-slots	12.5	11.91	11.80	11.85	-6.02dB	5.89	5.78	5.83
3Tx-slots	12.5	11.65	11.52	11.45	-4.26dB	7.39	7.26	7.19
4Tx-slots	12.5	11.24	11.32	11.15	-3.01dB	8.23	8.31	8.14

Full Power								
GPRS1900/ EGPRS1900	Tune up	Measured Power (dBm)			calculation	Average Power (dBm)		
		810	661	512		810	661	512
1Tx-slots	31.0	30.15	30.24	30.21	-9.03dB	21.12	21.21	21.18
2Tx-slots	28.5	27.89	27.93	28.14	-6.02dB	21.87	21.91	22.12
3Tx-slots	27.0	26.39	26.46	26.66	-4.26dB	22.13	22.20	22.40
4Tx-slots	25.5	24.41	24.50	24.69	-3.01dB	21.40	21.49	21.68
EGPRS1900 (8PSK)	Tune up	Measured Power (dBm)			calculation	Measured Power (dBm)		
		810	661	512		810	661	512
1Tx-slots	27.5	27.18	27.23	27.15	-9.03dB	18.15	18.20	18.12
2Tx-slots	26.0	25.10	25.32	25.28	-6.02dB	19.08	19.30	19.26
3Tx-slots	24.5	24.06	24.06	24.13	-4.26dB	19.80	19.80	19.87
4Tx-slots	22.5	21.63	21.75	22.06	-3.01dB	18.62	18.74	19.05
Sensor on								
GPRS1900/ EGPRS1900	Tune up	Measured Power (dBm)			calculation	Average Power (dBm)		
		810	661	512		810	661	512
1Tx-slots	16.5	15.70	15.84	16.15	-9.03dB	6.67	6.81	7.12
2Tx-slots	16.5	15.60	15.78	16.11	-6.02dB	9.58	9.76	10.09
3Tx-slots	16.5	15.54	15.66	16.30	-4.26dB	11.28	11.40	12.04
4Tx-slots	16.5	15.44	15.64	15.92	-3.01dB	12.43	12.63	12.91
EGPRS1900 (8PSK)	Tune up	Measured Power (dBm)			calculation	Measured Power (dBm)		
		810	661	512		810	661	512
1Tx-slots	8.5	7.97	7.83	8.23	-9.03dB	-1.06	-1.20	-0.80
2Tx-slots	8.5	7.84	7.63	8.07	-6.02dB	1.82	1.61	2.05
3Tx-slots	8.5	7.51	7.30	7.78	-4.26dB	3.25	3.04	3.52
4Tx-slots	8.5	7.07	7.16	7.56	-3.01dB	4.06	4.15	4.55

Note:

1) Division Factors

To average the power, the division factor is as follows:

1TX-slot = 1 transmit time slot out of 8 time slots=> conducted power divided by (8/1) => -9.03dB

2TX-slots = 2 transmit time slots out of 8 time slots=> conducted power divided by (8/2) => -6.02dB

3TX-slots = 3 transmit time slots out of 8 time slots=> conducted power divided by (8/3) => -4.26dB

4TX-slots = 4 transmit time slots out of 8 time slots=> conducted power divided by (8/4) => -3.01dB

According to the conducted power as above, the body measurements are performed with 2Txslots for GSM850 and 3Txslots for GSM1900; 4Txslots for GSM 850 Sensor-on mode and 4Txslots for GSM1900 Sensor-on mode.

10.2. WCDMA Measurement result

Table 10.2: T The conducted power measurement results WCDMA

Full Power					
Item	band	WCDMA Band 2			
	ARFCN	Tune up	Ch. 9538 (1907.6MHz)	Ch. 9400 (1880MHz)	Ch. 9262 (1852.4MHz)
WCDMA	\	22.0	21.1	21.2	21.2
HSUPA	1	20.0	18.5	18.6	18.8
	2	20.0	19.0	19.2	19.4
	3	20.0	18.7	18.9	19.1
	4	20.0	19.3	19.5	19.5
	5	22.0	21.3	21.4	21.3
HSDPA	1	22.0	21.3	21.4	21.4
	2	22.0	21.0	21.1	21.2
	3	22.0	20.8	20.9	21.0
	4	22.0	20.7	20.9	21.0
Sensor on					
Item	band	WCDMA Band 2			
	ARFCN	Tune up	Ch. 9538 (1907.6MHz)	Ch. 9400 (1880MHz)	Ch. 9262 (1852.4MHz)
WCDMA	\	12.0	11.5	11.6	11.6
HSUPA	1	12.0	11.5	11.7	11.7
	2	12.0	11.4	11.6	11.6
	3	12.0	11.5	11.6	11.7
	4	11.0	9.8	9.9	9.8
	5	12.0	11.5	11.6	11.6
HSDPA	1	12.0	11.5	11.6	11.7
	2	12.0	11.2	11.4	11.4
	3	12.0	11.0	11.2	11.2
	4	12.0	11.0	11.2	11.2

Full Power					
Item	band	WCDMA Band 4			
	ARFCN	Tune up	Ch. 1513 (1752.6MHz)	Ch. 1413 (1732.6MHz)	Ch. 1312 (1712.4MHz)
WCDMA	\	22.0	21.5	21.5	21.5
HSUPA	1	20.0	20.7	20.5	20.3
	2	20.0	21.0	20.8	20.6
	3	20.0	20.7	20.5	20.3
	4	20.0	21.3	21.1	20.9
	5	22.0	21.5	21.4	21.1
HSDPA	1	22.0	21.5	21.3	21.1
	2	22.0	21.5	21.3	21.1
	3	22.0	21.4	21.3	21.1
	4	22.0	21.4	21.3	21.1
Sensor on					
Item	band	WCDMA Band 4			
	ARFCN	Tune up	Ch. 1513 (1752.6MHz)	Ch. 1413 (1732.6MHz)	Ch. 1312 (1712.4MHz)
WCDMA	\	12.0	11.6	11.5	11.3
HSUPA	1	12.0	11.7	11.6	11.5
	2	12.0	11.6	11.5	11.4
	3	12.0	11.7	11.6	11.5
	4	12.0	11.6	11.5	11.4
	5	12.0	11.6	11.6	11.5
HSDPA	1	12.0	11.7	11.5	11.3
	2	12.0	11.6	11.4	11.4
	3	12.0	11.5	11.4	11.4
	4	12.0	11.5	11.4	11.4

Full Power					
Item	band	WCDMA Band 5			
	ARFCN	Tune up	Ch. 4233 (846.6MHz)	Ch. 4182 (836.4MHz)	Ch. 4132 (826.4MHz)
WCDMA	\	23.0	22.3	22.3	22.3
HSUPA	1	20.5	19.7	19.5	19.6
	2	20.5	20.0	19.8	19.9
	3	20.5	19.7	19.5	19.6
	4	20.5	19.8	19.6	19.7
	5	22.5	21.9	21.7	21.7
HSDPA	1	22.0	21.6	21.5	21.5
	2	22.0	21.3	21.2	21.3
	3	22.0	21.0	20.6	20.9
	4	22.0	21.0	20.7	21.0
Sensor on					
Item	band	WCDMA Band 5			
	ARFCN	Tune up	Ch. 4233 (846.6MHz)	Ch. 4182 (836.4MHz)	Ch. 4132 (826.4MHz)
WCDMA	\	18.0	17.7	17.5	17.6
HSUPA	1	16.5	15.8	15.5	15.6
	2	16.5	15.8	15.5	15.6
	3	16.5	15.8	15.4	15.6
	4	16.5	15.2	15.0	15.1
	5	17.5	17.2	17.0	17.2
HSDPA	1	17.5	17.1	16.8	16.9
	2	17.5	16.8	16.5	16.6
	3	17.5	16.3	16.0	16.1
	4	17.5	16.4	16.0	16.1

10.3. LTE Measurement result

According to April 2015 TCB workshop, SAR Test exclusion can be applied for testing overlapping LTE Bands as follows:

- a) The maximum out power, including tolerance, for the smaller band must be \leq the larger band to qualify for SAR test exclusion.
- b) The channel bandwidth and other operating parameters for the smaller band must be fully supported by the larger band.

LTE Band 4 (1710-1755 MHz) is covered by LTE Band 66 (1710-1780 MHz)

LTE Band 17 (704-716 MHz) is covered by LTE Band 12 (699-716 MHz)

Table 10.3: The conducted Power for LTE

Full Power								
LTE Band 2			Actual output Power (dBm)			Tune up		
Band -width	RB No. / RB offset	Frequency	Modulation			Modulation		
			QPSK	16QAM	64QAM	QPSK	16QAM	64QAM
1.4 MHz	1RB_5	1909.3MHz	22.32	21.82	20.79	23.0	22.0	21.0
		1880MHz	22.44	21.84	20.43	23.0	22.0	21.0
		1850.7MHz	22.25	21.96	20.75	23.0	22.0	21.0
	1RB_3	1909.3MHz	22.27	21.88	20.75	23.0	22.0	21.0
		1880MHz	22.32	21.60	20.67	23.0	22.0	21.0
		1850.7MHz	22.33	21.82	20.74	23.0	22.0	21.0
	1RB_0	1909.3MHz	22.25	21.91	20.87	23.0	22.0	21.0
		1880MHz	22.26	21.77	20.51	23.0	22.0	21.0
		1850.7MHz	22.31	21.97	20.71	23.0	22.0	21.0
	3RB_3	1909.3MHz	22.38	21.70	20.42	23.0	22.0	21.0
		1880MHz	22.36	21.51	20.23	23.0	22.0	21.0
		1850.7MHz	22.34	21.77	20.45	23.0	22.0	21.0
	3RB_1	1909.3MHz	22.46	21.71	20.41	23.0	22.0	21.0
		1880MHz	22.42	21.54	20.28	23.0	22.0	21.0
		1850.7MHz	22.43	21.67	20.51	23.0	22.0	21.0
	3RB_0	1909.3MHz	22.40	21.72	20.41	23.0	22.0	21.0
		1880MHz	22.38	21.53	20.25	23.0	22.0	21.0
		1850.7MHz	22.40	21.59	20.38	23.0	22.0	21.0
	6RB_0	1909.3MHz	21.45	20.28	19.54	22.0	21.0	20.0
		1880MHz	21.35	20.28	19.40	22.0	21.0	20.0
		1850.7MHz	21.41	20.39	19.59	22.0	21.0	20.0



Full Power								
LTE Band 2			Actual output Power (dBm)			Tune up		
Band -width	RB No. / RB offset	Frequency	Modulation			Modulation		
			QPSK	16QAM	64QAM	QPSK	16QAM	64QAM
3 MHz	1RB_14	1908.5MHz	22.28	21.86	20.57	23.0	22.0	21.0
		1880MHz	22.33	21.86	20.34	23.0	22.0	21.0
		1851.5MHz	22.29	21.96	20.48	23.0	22.0	21.0
	1RB_7	1908.5MHz	22.26	21.06	20.60	23.0	22.0	21.0
		1880MHz	22.34	21.89	20.31	23.0	22.0	21.0
		1851.5MHz	22.32	21.91	20.61	23.0	22.0	21.0
	1RB_0	1908.5MHz	22.24	21.91	20.57	23.0	22.0	21.0
		1880MHz	22.34	21.87	20.35	23.0	22.0	21.0
		1851.5MHz	22.32	21.91	20.53	23.0	22.0	21.0
	8RB_7	1908.5MHz	21.42	20.67	19.53	22.0	21.0	20.0
		1880MHz	21.42	20.45	19.37	22.0	21.0	20.0
		1851.5MHz	21.44	20.60	19.53	22.0	21.0	20.0
	8RB_4	1908.5MHz	21.40	20.69	19.55	22.0	21.0	20.0
		1880MHz	21.30	20.49	19.36	22.0	21.0	20.0
		1851.5MHz	21.45	20.61	19.44	22.0	21.0	20.0
	8RB_0	1908.5MHz	21.41	20.65	19.50	22.0	21.0	20.0
		1880MHz	21.34	20.45	19.37	22.0	21.0	20.0
		1851.5MHz	21.31	20.62	19.48	22.0	21.0	20.0
	15RB_0	1908.5MHz	21.46	20.63	19.64	22.0	21.0	20.0
		1880MHz	21.38	20.48	19.65	22.0	21.0	20.0
		1851.5MHz	21.39	20.60	19.62	22.0	21.0	20.0



Full Power								
LTE Band 2			Actual output Power (dBm)			Tune up		
Band -width	RB No. / RB offset	Frequency	Modulation			Modulation		
			QPSK	16QAM	64QAM	QPSK	16QAM	64QAM
5 MHz	1RB_24	1907.5MHz	22.27	21.82	20.57	23.0	22.0	21.0
		1880MHz	22.17	21.91	20.24	23.0	22.0	21.0
		1852.5MHz	22.26	21.99	20.49	23.0	22.0	21.0
	1RB_12	1907.5MHz	22.25	21.79	20.49	23.0	22.0	21.0
		1880MHz	22.26	21.82	20.20	23.0	22.0	21.0
		1852.5MHz	22.33	21.99	20.57	23.0	22.0	21.0
	1RB_0	1907.5MHz	22.30	21.84	20.48	23.0	22.0	21.0
		1880MHz	22.25	21.94	20.24	23.0	22.0	21.0
		1852.5MHz	22.26	21.91	20.53	23.0	22.0	21.0
	12RB_13	1907.5MHz	21.42	20.55	19.62	22.0	21.0	20.0
		1880MHz	21.30	20.56	19.53	22.0	21.0	20.0
		1852.5MHz	21.35	20.56	19.53	22.0	21.0	20.0
	12RB_6	1907.5MHz	21.30	20.57	19.53	22.0	21.0	20.0
		1880MHz	21.30	20.51	19.51	22.0	21.0	20.0
		1852.5MHz	21.33	20.53	19.53	22.0	21.0	20.0
	12RB_0	1907.5MHz	21.44	20.57	19.55	22.0	21.0	20.0
		1880MHz	21.37	20.54	19.48	22.0	21.0	20.0
		1852.5MHz	21.38	20.57	19.57	22.0	21.0	20.0
	25RB_0	1907.5MHz	21.39	20.76	19.47	22.0	21.0	20.0
		1880MHz	21.36	20.45	19.54	22.0	21.0	20.0
		1852.5MHz	21.49	20.74	19.61	22.0	21.0	20.0



Full Power								
LTE Band 2			Actual output Power (dBm)			Tune up		
Band -width	RB No. / RB offset	Frequency	Modulation			Modulation		
			QPSK	16QAM	64QAM	QPSK	16QAM	64QAM
10 MHz	1RB_49	1905MHz	22.29	21.81	20.59	23.0	22.0	21.0
		1880MHz	22.25	21.80	20.24	23.0	22.0	21.0
		1855MHz	22.24	21.85	20.55	23.0	22.0	21.0
	1RB_24	1905MHz	22.25	21.94	20.53	23.0	22.0	21.0
		1880MHz	22.27	21.95	20.26	23.0	22.0	21.0
		1855MHz	22.29	21.87	20.47	23.0	22.0	21.0
	1RB_0	1905MHz	22.32	21.77	20.54	23.0	22.0	21.0
		1880MHz	22.32	21.75	20.17	23.0	22.0	21.0
		1855MHz	22.34	21.81	20.47	23.0	22.0	21.0
	25RB_25	1905MHz	21.36	20.52	19.57	22.0	21.0	20.0
		1880MHz	21.38	20.48	19.48	22.0	21.0	20.0
		1855MHz	21.42	20.49	19.63	22.0	21.0	20.0
	25RB_12	1905MHz	21.31	20.48	19.60	22.0	21.0	20.0
		1880MHz	21.38	20.47	19.43	22.0	21.0	20.0
		1855MHz	21.42	20.47	19.52	22.0	21.0	20.0
	25RB_0	1905MHz	21.35	20.50	19.62	22.0	21.0	20.0
		1880MHz	21.36	20.42	19.44	22.0	21.0	20.0
		1855MHz	21.42	20.52	19.66	22.0	21.0	20.0
	50RB_0	1905MHz	21.49	20.60	19.63	22.0	21.0	20.0
		1880MHz	21.35	20.48	19.53	22.0	21.0	20.0
		1855MHz	21.42	20.49	19.54	22.0	21.0	20.0



Full Power								
LTE Band 2			Actual output Power (dBm)			Tune up		
Band -width	RB No. / RB offset	Frequency	Modulation			Modulation		
			QPSK	16QAM	64QAM	QPSK	16QAM	64QAM
15 MHz	1RB_74	1902.5MHz	22.31	21.79	20.61	23.0	22.0	21.0
		1880MHz	22.31	21.88	20.44	23.0	22.0	21.0
		1857.5MHz	22.27	21.85	20.49	23.0	22.0	21.0
	1RB_37	1902.5MHz	22.30	21.86	20.60	23.0	22.0	21.0
		1880MHz	22.19	21.72	20.57	23.0	22.0	21.0
		1857.5MHz	22.30	21.89	20.54	23.0	22.0	21.0
	1RB_0	1902.5MHz	22.28	21.91	20.53	23.0	22.0	21.0
		1880MHz	22.27	21.86	20.43	23.0	22.0	21.0
		1857.5MHz	22.30	21.93	20.52	23.0	22.0	21.0
	36RB_38	1902.5MHz	21.43	20.61	19.58	22.0	21.0	20.0
		1880MHz	21.44	20.46	19.52	22.0	21.0	20.0
		1857.5MHz	21.41	20.54	19.55	22.0	21.0	20.0
	36RB_19	1902.5MHz	21.45	20.63	19.57	22.0	21.0	20.0
		1880MHz	21.40	20.45	19.49	22.0	21.0	20.0
		1857.5MHz	21.43	20.59	19.49	22.0	21.0	20.0
	36RB_0	1902.5MHz	21.48	20.64	19.56	22.0	21.0	20.0
		1880MHz	21.47	20.46	19.52	22.0	21.0	20.0
		1857.5MHz	21.43	20.59	19.53	22.0	21.0	20.0
	75RB_0	1902.5MHz	21.45	20.58	19.54	22.0	21.0	20.0
		1880MHz	21.42	20.61	19.56	22.0	21.0	20.0
		1857.5MHz	21.44	20.57	19.60	22.0	21.0	20.0



Full Power								
LTE Band 2			Actual output Power (dBm)			Tune up		
Band -width	RB No. / RB offset	Frequency	Modulation			Modulation		
			QPSK	16QAM	64QAM	QPSK	16QAM	64QAM
20 MHz	1RB_99	1900MHz	22.38	21.77	20.61	23.0	22.0	21.0
		1880MHz	22.44	21.65	20.40	23.0	22.0	21.0
		1860MHz	22.36	21.84	20.61	23.0	22.0	21.0
	1RB_50	1900MHz	22.39	21.89	20.58	23.0	22.0	21.0
		1880MHz	22.43	21.69	20.78	23.0	22.0	21.0
		1860MHz	22.35	21.74	20.62	23.0	22.0	21.0
	1RB_0	1900MHz	22.32	21.82	20.57	23.0	22.0	21.0
		1880MHz	22.41	21.58	20.83	23.0	22.0	21.0
		1860MHz	22.42	21.62	20.59	23.0	22.0	21.0
	50RB_50	1900MHz	21.43	20.56	19.61	22.0	21.0	20.0
		1880MHz	21.43	20.61	19.59	22.0	21.0	20.0
		1860MHz	21.40	20.55	19.60	22.0	21.0	20.0
	50RB_25	1900MHz	21.44	20.57	19.62	22.0	21.0	20.0
		1880MHz	21.39	20.56	19.57	22.0	21.0	20.0
		1860MHz	21.42	20.50	19.60	22.0	21.0	20.0
	50RB_0	1900MHz	21.45	20.49	19.60	22.0	21.0	20.0
		1880MHz	21.39	20.53	19.58	22.0	21.0	20.0
		1860MHz	21.39	20.59	19.58	22.0	21.0	20.0
	100RB_0	1900MHz	21.47	20.65	19.54	22.0	21.0	20.0
		1880MHz	21.48	20.53	19.59	22.0	21.0	20.0
		1860MHz	21.45	20.60	19.58	22.0	21.0	20.0



Sensor on								
LTE Band 2			Actual output Power (dBm)			Tune up		
Band -width	RB No. / RB offset	Frequency	Modulation			Modulation		
			QPSK	16QAM	64QAM	QPSK	16QAM	64QAM
1.4 MHz	1RB_5	1909.3MHz	10.24	9.62	8.53	11.5	10.5	9.5
		1880MHz	10.36	9.82	8.82	11.5	10.5	9.5
		1850.7MHz	10.28	9.63	8.78	11.5	10.5	9.5
	1RB_3	1909.3MHz	10.27	9.95	8.77	11.5	10.5	9.5
		1880MHz	10.56	10.08	9.06	11.5	10.5	9.5
		1850.7MHz	10.47	9.82	8.99	11.5	10.5	9.5
	1RB_0	1909.3MHz	10.09	9.72	8.58	11.5	10.5	9.5
		1880MHz	10.35	9.87	8.84	11.5	10.5	9.5
		1850.7MHz	10.35	9.69	8.86	11.5	10.5	9.5
	3RB_3	1909.3MHz	10.18	9.61	8.61	11.5	10.5	9.5
		1880MHz	10.49	9.79	8.99	11.5	10.5	9.5
		1850.7MHz	10.40	9.68	8.87	11.5	10.5	9.5
	3RB_1	1909.3MHz	10.32	9.69	8.71	11.5	10.5	9.5
		1880MHz	10.57	9.89	9.06	11.5	10.5	9.5
		1850.7MHz	10.49	9.76	8.93	11.5	10.5	9.5
	3RB_0	1909.3MHz	10.27	9.65	8.65	11.5	10.5	9.5
		1880MHz	10.49	9.80	9.00	11.5	10.5	9.5
		1850.7MHz	10.45	9.73	8.93	11.5	10.5	9.5
	6RB_0	1909.3MHz	9.56	8.63	7.82	10.5	9.5	8.5
		1880MHz	9.65	8.95	8.09	10.5	9.5	8.5
		1850.7MHz	9.70	8.85	8.00	10.5	9.5	8.5



Sensor on								
LTE Band 2			Actual output Power (dBm)			Tune up		
Band -width	RB No. / RB offset	Frequency	Modulation			Modulation		
			QPSK	16QAM	64QAM	QPSK	16QAM	64QAM
3 MHz	1RB_14	1908.5MHz	10.20	9.71	8.52	11.5	10.5	9.5
		1880MHz	10.49	9.78	8.89	11.5	10.5	9.5
		1851.5MHz	10.31	9.61	8.72	11.5	10.5	9.5
	1RB_7	1908.5MHz	10.44	9.93	8.77	11.5	10.5	9.5
		1880MHz	10.59	9.98	9.06	11.5	10.5	9.5
		1851.5MHz	10.55	9.87	8.98	11.5	10.5	9.5
	1RB_0	1908.5MHz	10.19	9.67	8.54	11.5	10.5	9.5
		1880MHz	10.43	9.72	8.85	11.5	10.5	9.5
		1851.5MHz	10.42	9.76	8.88	11.5	10.5	9.5
	8RB_7	1908.5MHz	9.60	8.57	7.95	10.5	9.5	8.5
		1880MHz	9.75	8.88	8.22	10.5	9.5	8.5
		1851.5MHz	9.59	8.75	8.09	10.5	9.5	8.5
	8RB_4	1908.5MHz	9.65	8.63	8.02	10.5	9.5	8.5
		1880MHz	9.78	8.93	8.26	10.5	9.5	8.5
		1851.5MHz	9.65	8.81	8.13	10.5	9.5	8.5
	8RB_0	1908.5MHz	9.60	8.60	7.98	10.5	9.5	8.5
		1880MHz	9.73	8.88	8.20	10.5	9.5	8.5
		1851.5MHz	9.63	8.80	8.15	10.5	9.5	8.5
	15RB_0	1908.5MHz	9.59	8.54	7.91	10.5	9.5	8.5
		1880MHz	9.73	8.85	8.19	10.5	9.5	8.5
		1851.5MHz	9.60	8.76	8.09	10.5	9.5	8.5



Sensor on								
LTE Band 2			Actual output Power (dBm)			Tune up		
Band -width	RB No. / RB offset	Frequency	Modulation			Modulation		
			QPSK	16QAM	64QAM	QPSK	16QAM	64QAM
5 MHz	1RB_24	1907.5MHz	9.79	9.34	8.18	11.5	10.5	9.5
		1880MHz	9.99	9.48	8.45	11.5	10.5	9.5
		1852.5MHz	9.81	9.23	8.24	11.5	10.5	9.5
	1RB_12	1907.5MHz	10.35	9.89	8.78	11.5	10.5	9.5
		1880MHz	10.66	10.13	9.13	11.5	10.5	9.5
		1852.5MHz	10.49	9.91	8.98	11.5	10.5	9.5
	1RB_0	1907.5MHz	9.83	9.38	8.25	11.5	10.5	9.5
		1880MHz	10.05	9.52	8.53	11.5	10.5	9.5
		1852.5MHz	10.09	9.53	8.53	11.5	10.5	9.5
	12RB_13	1907.5MHz	9.46	8.46	7.89	10.5	9.5	8.5
		1880MHz	9.62	8.76	8.16	10.5	9.5	8.5
		1852.5MHz	9.40	8.54	7.93	10.5	9.5	8.5
	12RB_6	1907.5MHz	9.57	8.58	8.00	10.5	9.5	8.5
		1880MHz	9.80	8.95	8.34	10.5	9.5	8.5
		1852.5MHz	9.63	8.78	8.16	10.5	9.5	8.5
	12RB_0	1907.5MHz	9.39	8.38	7.82	10.5	9.5	8.5
		1880MHz	9.63	8.77	8.16	10.5	9.5	8.5
		1852.5MHz	9.54	8.68	8.06	10.5	9.5	8.5
	25RB_0	1907.5MHz	9.43	8.42	7.82	10.5	9.5	8.5
		1880MHz	9.63	8.78	8.13	10.5	9.5	8.5
		1852.5MHz	9.48	8.62	7.96	10.5	9.5	8.5



Sensor on								
LTE Band 2			Actual output Power (dBm)			Tune up		
Band -width	RB No. / RB offset	Frequency	Modulation			Modulation		
			QPSK	16QAM	64QAM	QPSK	16QAM	64QAM
10 MHz	1RB_49	1905MHz	10.55	10.10	8.96	11.5	10.5	9.5
		1880MHz	10.69	10.13	9.09	11.5	10.5	9.5
		1855MHz	10.44	10.02	8.83	11.5	10.5	9.5
	1RB_24	1905MHz	10.31	9.82	8.75	11.5	10.5	9.5
		1880MHz	10.62	10.07	9.07	11.5	10.5	9.5
		1855MHz	10.39	9.97	8.83	11.5	10.5	9.5
	1RB_0	1905MHz	9.81	9.32	8.22	11.5	10.5	9.5
		1880MHz	10.18	9.59	8.59	11.5	10.5	9.5
		1855MHz	10.39	9.92	8.77	11.5	10.5	9.5
	25RB_25	1905MHz	9.78	8.73	8.12	10.5	9.5	8.5
		1880MHz	9.84	8.92	8.31	10.5	9.5	8.5
		1855MHz	9.78	8.74	8.10	10.5	9.5	8.5
	25RB_12	1905MHz	9.59	8.55	7.94	10.5	9.5	8.5
		1880MHz	9.80	8.89	8.28	10.5	9.5	8.5
		1855MHz	9.75	8.73	8.08	10.5	9.5	8.5
	25RB_0	1905MHz	9.43	8.37	7.77	10.5	9.5	8.5
		1880MHz	9.68	8.76	8.14	10.5	9.5	8.5
		1855MHz	9.80	8.77	8.12	10.5	9.5	8.5
	50RB_0	1905MHz	9.60	8.57	7.95	10.5	9.5	8.5
		1880MHz	9.75	8.86	8.22	10.5	9.5	8.5
		1855MHz	9.79	8.76	8.12	10.5	9.5	8.5



Sensor on								
LTE Band 2			Actual output Power (dBm)			Tune up		
Band -width	RB No. / RB offset	Frequency	Modulation			Modulation		
			QPSK	16QAM	64QAM	QPSK	16QAM	64QAM
15 MHz	1RB_74	1902.5MHz	10.11	9.73	8.45	11.5	10.5	9.5
		1880MHz	10.26	9.77	8.65	11.5	10.5	9.5
		1857.5MHz	10.04	9.64	8.46	11.5	10.5	9.5
	1RB_37	1902.5MHz	9.97	9.58	8.40	11.5	10.5	9.5
		1880MHz	10.60	10.10	9.02	11.5	10.5	9.5
		1857.5MHz	10.26	9.86	8.76	11.5	10.5	9.5
	1RB_0	1902.5MHz	9.84	9.46	8.23	11.5	10.5	9.5
		1880MHz	10.18	9.68	8.56	11.5	10.5	9.5
		1857.5MHz	10.55	10.16	9.02	11.5	10.5	9.5
	36RB_38	1902.5MHz	9.48	8.45	7.85	10.5	9.5	8.5
		1880MHz	9.66	8.76	8.17	10.5	9.5	8.5
		1857.5MHz	9.50	8.48	7.87	10.5	9.5	8.5
	36RB_19	1902.5MHz	9.32	8.31	7.71	10.5	9.5	8.5
		1880MHz	9.69	8.81	8.22	10.5	9.5	8.5
		1857.5MHz	9.57	8.57	7.95	10.5	9.5	8.5
	36RB_0	1902.5MHz	9.23	8.20	7.61	10.5	9.5	8.5
		1880MHz	9.68	8.77	8.18	10.5	9.5	8.5
		1857.5MHz	9.82	8.81	8.19	10.5	9.5	8.5
	75RB_0	1902.5MHz	9.35	8.33	7.71	10.5	9.5	8.5
		1880MHz	9.66	8.77	8.14	10.5	9.5	8.5
		1857.5MHz	9.66	8.63	7.99	10.5	9.5	8.5



Sensor on								
LTE Band 2			Actual output Power (dBm)			Tune up		
Band -width	RB No. / RB offset	Frequency	Modulation			Modulation		
			QPSK	16QAM	64QAM	QPSK	16QAM	64QAM
20 MHz	1RB_99	1900MHz	10.54	9.97	8.81	11.5	10.5	9.5
		1880MHz	10.75	10.21	9.37	11.5	10.5	9.5
		1860MHz	10.58	10.03	8.76	11.5	10.5	9.5
	1RB_50	1900MHz	9.99	9.47	8.26	11.5	10.5	9.5
		1880MHz	10.47	10.11	8.98	11.5	10.5	9.5
		1860MHz	10.31	9.69	8.50	11.5	10.5	9.5
	1RB_0	1900MHz	10.52	9.94	8.82	11.5	10.5	9.5
		1880MHz	10.78	10.27	9.22	11.5	10.5	9.5
		1860MHz	11.10	10.51	9.19	11.5	10.5	9.5
	50RB_50	1900MHz	9.54	8.51	7.90	10.5	9.5	8.5
		1880MHz	9.71	8.97	8.35	10.5	9.5	8.5
		1860MHz	9.67	8.59	7.97	10.5	9.5	8.5
	50RB_25	1900MHz	9.25	8.26	7.65	10.5	9.5	8.5
		1880MHz	9.58	8.88	8.26	10.5	9.5	8.5
		1860MHz	9.60	8.52	7.92	10.5	9.5	8.5
	50RB_0	1900MHz	9.40	8.40	7.78	10.5	9.5	8.5
		1880MHz	9.70	9.00	8.38	10.5	9.5	8.5
		1860MHz	9.97	8.88	8.27	10.5	9.5	8.5
	100RB_0	1900MHz	9.45	8.43	7.83	10.5	9.5	8.5
		1880MHz	9.68	8.96	8.35	10.5	9.5	8.5
		1860MHz	9.81	8.71	8.10	10.5	9.5	8.5



Full Power								
LTE Band 5			Actual output Power (dBm)			Tune up		
Band -width	RB No. / RB offset	Frequency	Modulation			Modulation		
			QPSK	16QAM	64QAM	QPSK	16QAM	64QAM
1.4 MHz	1RB_5	848.3MHz	23.84	23.16	22.02	24.5	23.5	22.5
		836.5MHz	23.72	23.20	22.26	24.5	23.5	22.5
		824.7MHz	23.61	23.12	21.56	24.5	23.5	22.5
	1RB_3	848.3MHz	23.84	23.17	22.15	24.5	23.5	22.5
		836.5MHz	23.74	23.21	22.01	24.5	23.5	22.5
		824.7MHz	23.58	23.14	21.71	24.5	23.5	22.5
	1RB_0	848.3MHz	23.83	23.14	22.15	24.5	23.5	22.5
		836.5MHz	23.71	23.21	22.17	24.5	23.5	22.5
		824.7MHz	23.64	23.08	21.61	24.5	23.5	22.5
	3RB_3	848.3MHz	23.91	23.07	21.83	24.5	23.5	22.5
		836.5MHz	23.85	23.11	21.89	24.5	23.5	22.5
		824.7MHz	23.84	23.07	21.67	24.5	23.5	22.5
	3RB_1	848.3MHz	23.97	23.08	21.84	24.5	23.5	22.5
		836.5MHz	23.86	23.08	21.81	24.5	23.5	22.5
		824.7MHz	23.80	23.13	21.59	24.5	23.5	22.5
	3RB_0	848.3MHz	23.92	23.02	21.82	24.5	23.5	22.5
		836.5MHz	23.82	23.12	21.86	24.5	23.5	22.5
		824.7MHz	23.75	23.11	21.67	24.5	23.5	22.5
	6RB_0	848.3MHz	22.97	21.82	20.93	23.5	22.5	21.5
		836.5MHz	22.86	21.83	20.94	23.5	22.5	21.5
		824.7MHz	22.70	21.44	20.76	23.5	22.5	21.5



Full Power								
LTE Band 5			Actual output Power (dBm)			Tune up		
Band -width	RB No. / RB offset	Frequency	Modulation			Modulation		
			QPSK	16QAM	64QAM	QPSK	16QAM	64QAM
3 MHz	1RB_14	847.5MHz	23.87	23.16	22.20	24.5	23.5	22.5
		836.5MHz	23.67	23.29	22.32	24.5	23.5	22.5
		825.5MHz	23.52	23.07	22.19	24.5	23.5	22.5
	1RB_7	847.5MHz	23.94	23.38	22.16	24.5	23.5	22.5
		836.5MHz	23.77	23.23	22.35	24.5	23.5	22.5
		825.5MHz	23.65	23.03	22.32	24.5	23.5	22.5
	1RB_0	847.5MHz	23.87	23.42	22.26	24.5	23.5	22.5
		836.5MHz	23.69	23.24	22.23	24.5	23.5	22.5
		825.5MHz	23.54	23.06	22.29	24.5	23.5	22.5
	8RB_7	847.5MHz	22.89	22.02	20.89	23.5	22.5	21.5
		836.5MHz	22.91	22.03	20.95	23.5	22.5	21.5
		825.5MHz	22.75	21.82	21.04	23.5	22.5	21.5
	8RB_4	847.5MHz	22.99	22.37	21.13	23.5	22.5	21.5
		836.5MHz	22.82	22.06	20.94	23.5	22.5	21.5
		825.5MHz	22.68	21.75	20.58	23.5	22.5	21.5
	8RB_0	847.5MHz	22.96	22.42	21.34	23.5	22.5	21.5
		836.5MHz	22.87	21.97	20.87	23.5	22.5	21.5
		825.5MHz	22.70	21.77	20.63	23.5	22.5	21.5
	15RB_0	847.5MHz	22.97	22.02	21.05	23.5	22.5	21.5
		836.5MHz	22.90	22.04	21.06	23.5	22.5	21.5
		825.5MHz	22.66	21.72	20.86	23.5	22.5	21.5



Full Power								
LTE Band 5			Actual output Power (dBm)			Tune up		
Band -width	RB No. / RB offset	Frequency	Modulation			Modulation		
			QPSK	16QAM	64QAM	QPSK	16QAM	64QAM
5 MHz	1RB_24	846.5MHz	23.77	23.26	21.93	24.5	23.5	22.5
		836.5MHz	23.89	23.26	22.22	24.5	23.5	22.5
		826.5MHz	23.76	23.26	22.14	24.5	23.5	22.5
	1RB_12	846.5MHz	23.74	23.35	22.22	24.5	23.5	22.5
		836.5MHz	23.84	23.29	22.14	24.5	23.5	22.5
		826.5MHz	23.68	23.21	21.97	24.5	23.5	22.5
	1RB_0	846.5MHz	23.90	23.28	21.98	24.5	23.5	22.5
		836.5MHz	23.84	23.23	22.19	24.5	23.5	22.5
		826.5MHz	23.66	23.20	21.95	24.5	23.5	22.5
	12RB_13	846.5MHz	22.99	22.40	21.36	23.5	22.5	21.5
		836.5MHz	22.98	21.93	21.05	23.5	22.5	21.5
		826.5MHz	22.75	21.69	21.29	23.5	22.5	21.5
	12RB_6	846.5MHz	22.88	22.37	21.36	23.5	22.5	21.5
		836.5MHz	22.92	22.00	20.90	23.5	22.5	21.5
		826.5MHz	22.75	21.64	21.24	23.5	22.5	21.5
	12RB_0	846.5MHz	22.89	21.97	21.36	23.5	22.5	21.5
		836.5MHz	22.91	21.95	20.88	23.5	22.5	21.5
		826.5MHz	22.72	21.75	20.84	23.5	22.5	21.5
	25RB_0	846.5MHz	22.99	22.02	21.12	23.5	22.5	21.5
		836.5MHz	22.96	21.90	20.82	23.5	22.5	21.5
		826.5MHz	22.62	21.66	21.22	23.5	22.5	21.5



Full Power								
LTE Band 5			Actual output Power (dBm)			Tune up		
Band -width	RB No. / RB offset	Frequency	Modulation			Modulation		
			QPSK	16QAM	64QAM	QPSK	16QAM	64QAM
10 MHz	1RB_49	844MHz	23.88	23.40	22.05	24.5	23.5	22.5
		836.5MHz	23.89	23.42	22.36	24.5	23.5	22.5
		829MHz	23.73	23.33	22.02	24.5	23.5	22.5
	1RB_24	844MHz	23.87	23.42	21.91	24.5	23.5	22.5
		836.5MHz	23.73	23.30	21.97	24.5	23.5	22.5
		829MHz	23.62	23.26	21.84	24.5	23.5	22.5
	1RB_0	844MHz	23.74	23.35	21.87	24.5	23.5	22.5
		836.5MHz	23.62	23.17	21.67	24.5	23.5	22.5
		829MHz	23.63	23.22	21.80	24.5	23.5	22.5
	25RB_25	844MHz	23.02	22.32	21.29	23.5	22.5	21.5
		836.5MHz	22.91	22.10	21.26	23.5	22.5	21.5
		829MHz	22.86	21.77	21.20	23.5	22.5	21.5
	25RB_12	844MHz	22.96	21.88	21.28	23.5	22.5	21.5
		836.5MHz	22.98	22.17	20.87	23.5	22.5	21.5
		829MHz	22.91	21.84	20.73	23.5	22.5	21.5
	25RB_0	844MHz	22.89	22.41	21.27	23.5	22.5	21.5
		836.5MHz	22.93	22.11	20.83	23.5	22.5	21.5
		829MHz	22.74	21.70	21.09	23.5	22.5	21.5
	50RB_0	844MHz	23.01	21.86	21.45	23.5	22.5	21.5
		836.5MHz	22.98	21.90	20.94	23.5	22.5	21.5
		829MHz	22.83	21.76	20.92	23.5	22.5	21.5



Sensor on								
LTE Band 5			Actual output Power (dBm)			Tune up		
Band -width	RB No. / RB offset	Frequency	Modulation			Modulation		
			QPSK	16QAM	64QAM	QPSK	16QAM	64QAM
1.4 MHz	1RB_5	848.3MHz	17.76	16.68	15.79	19.5	18.5	17.5
		836.5MHz	17.95	17.23	16.09	19.5	18.5	17.5
		824.7MHz	17.98	17.42	16.36	19.5	18.5	17.5
	1RB_3	848.3MHz	17.70	17.03	16.04	19.5	18.5	17.5
		836.5MHz	18.15	17.41	16.46	19.5	18.5	17.5
		824.7MHz	18.16	17.63	16.60	19.5	18.5	17.5
	1RB_0	848.3MHz	17.73	17.06	15.96	19.5	18.5	17.5
		836.5MHz	17.74	17.17	16.04	19.5	18.5	17.5
		824.7MHz	17.97	17.46	16.42	19.5	18.5	17.5
	3RB_3	848.3MHz	17.71	16.85	15.93	19.5	18.5	17.5
		836.5MHz	17.94	17.09	16.21	19.5	18.5	17.5
		824.7MHz	18.07	17.33	16.42	19.5	18.5	17.5
	3RB_1	848.3MHz	17.88	17.00	16.08	19.5	18.5	17.5
		836.5MHz	18.00	17.18	16.22	19.5	18.5	17.5
		824.7MHz	18.15	17.42	16.51	19.5	18.5	17.5
	3RB_0	848.3MHz	17.87	16.97	16.02	19.5	18.5	17.5
		836.5MHz	17.91	17.09	16.15	19.5	18.5	17.5
		824.7MHz	18.09	17.32	16.45	19.5	18.5	17.5
	6RB_0	848.3MHz	16.89	15.96	14.91	18.5	17.5	16.5
		836.5MHz	17.04	16.15	15.08	18.5	17.5	16.5
		824.7MHz	17.25	16.41	15.38	18.5	17.5	16.5



Sensor on								
LTE Band 5			Actual output Power (dBm)			Tune up		
Band -width	RB No. / RB offset	Frequency	Modulation			Modulation		
			QPSK	16QAM	64QAM	QPSK	16QAM	64QAM
3 MHz	1RB_14	847.5MHz	17.73	16.81	15.81	19.5	18.5	17.5
		836.5MHz	17.87	17.33	16.13	19.5	18.5	17.5
		825.5MHz	17.87	17.27	16.23	19.5	18.5	17.5
	1RB_7	847.5MHz	18.13	17.23	16.22	19.5	18.5	17.5
		836.5MHz	17.96	17.43	16.27	19.5	18.5	17.5
		825.5MHz	18.16	17.58	16.55	19.5	18.5	17.5
	1RB_0	847.5MHz	18.08	17.17	16.19	19.5	18.5	17.5
		836.5MHz	17.72	17.19	15.98	19.5	18.5	17.5
		825.5MHz	18.01	17.44	16.38	19.5	18.5	17.5
	8RB_7	847.5MHz	16.97	15.98	14.97	18.5	17.5	16.5
		836.5MHz	17.09	16.12	15.11	18.5	17.5	16.5
		825.5MHz	17.20	16.25	15.34	18.5	17.5	16.5
	8RB_4	847.5MHz	17.09	16.10	15.08	18.5	17.5	16.5
		836.5MHz	17.09	16.12	15.16	18.5	17.5	16.5
		825.5MHz	17.28	16.34	15.41	18.5	17.5	16.5
	8RB_0	847.5MHz	17.12	16.13	15.12	18.5	17.5	16.5
		836.5MHz	17.02	16.05	15.07	18.5	17.5	16.5
		825.5MHz	17.29	16.35	15.43	18.5	17.5	16.5
	15RB_0	847.5MHz	17.03	16.01	15.00	18.5	17.5	16.5
		836.5MHz	17.06	16.03	15.15	18.5	17.5	16.5
		825.5MHz	17.24	16.27	15.38	18.5	17.5	16.5



Sensor on								
LTE Band 5			Actual output Power (dBm)			Tune up		
Band -width	RB No. / RB offset	Frequency	Modulation			Modulation		
			QPSK	16QAM	64QAM	QPSK	16QAM	64QAM
5 MHz	1RB_24	846.5MHz	17.72	16.54	15.53	19.5	18.5	17.5
		836.5MHz	17.89	17.11	15.90	19.5	18.5	17.5
		826.5MHz	17.87	16.78	15.58	19.5	18.5	17.5
	1RB_12	846.5MHz	18.11	17.49	16.30	19.5	18.5	17.5
		836.5MHz	18.24	17.45	16.29	19.5	18.5	17.5
		826.5MHz	18.05	17.60	16.36	19.5	18.5	17.5
	1RB_0	846.5MHz	18.20	17.53	16.36	19.5	18.5	17.5
		836.5MHz	17.54	16.78	15.62	19.5	18.5	17.5
		826.5MHz	17.71	17.19	15.99	19.5	18.5	17.5
	12RB_13	846.5MHz	16.98	15.96	15.02	18.5	17.5	16.5
		836.5MHz	17.15	16.12	15.11	18.5	17.5	16.5
		826.5MHz	16.90	15.92	14.95	18.5	17.5	16.5
	12RB_6	846.5MHz	17.28	16.29	15.29	18.5	17.5	16.5
		836.5MHz	17.21	16.17	15.19	18.5	17.5	16.5
		826.5MHz	17.22	16.24	15.27	18.5	17.5	16.5
	12RB_0	846.5MHz	17.32	16.33	15.31	18.5	17.5	16.5
		836.5MHz	17.01	15.94	15.00	18.5	17.5	16.5
		826.5MHz	17.14	16.16	15.21	18.5	17.5	16.5
	25RB_0	846.5MHz	17.15	16.16	15.15	18.5	17.5	16.5
		836.5MHz	17.09	16.07	15.05	18.5	17.5	16.5
		826.5MHz	17.06	16.05	15.06	18.5	17.5	16.5



Sensor on								
LTE Band 5			Actual output Power (dBm)			Tune up		
Band -width	RB No. / RB offset	Frequency	Modulation			Modulation		
			QPSK	16QAM	64QAM	QPSK	16QAM	64QAM
10 MHz	1RB_49	844MHz	18.14	17.41	16.24	19.5	18.5	17.5
		836.5MHz	18.46	17.80	16.59	19.5	18.5	17.5
		829MHz	18.29	17.84	16.67	19.5	18.5	17.5
	1RB_24	844MHz	18.70	18.15	16.92	19.5	18.5	17.5
		836.5MHz	18.12	17.50	16.80	19.5	18.5	17.5
		829MHz	18.07	17.63	16.49	19.5	18.5	17.5
	1RB_0	844MHz	18.97	18.34	17.20	19.5	18.5	17.5
		836.5MHz	17.54	16.88	15.71	19.5	18.5	17.5
		829MHz	18.20	17.94	16.66	19.5	18.5	17.5
	25RB_25	844MHz	17.41	16.43	15.47	18.5	17.5	16.5
		836.5MHz	17.43	16.59	15.51	18.5	17.5	16.5
		829MHz	17.36	16.52	15.47	18.5	17.5	16.5
	25RB_12	844MHz	17.69	16.75	15.79	18.5	17.5	16.5
		836.5MHz	17.16	16.30	15.29	18.5	17.5	16.5
		829MHz	17.29	16.46	15.42	18.5	17.5	16.5
	25RB_0	844MHz	17.99	17.06	16.11	18.5	17.5	16.5
		836.5MHz	16.91	16.05	15.02	18.5	17.5	16.5
		829MHz	17.37	16.55	15.50	18.5	17.5	16.5
	50RB_0	844MHz	17.69	16.77	15.80	18.5	17.5	16.5
		836.5MHz	17.17	16.32	15.29	18.5	17.5	16.5
		829MHz	17.39	16.56	15.47	18.5	17.5	16.5



Full Power								
LTE Band 7			Actual output Power (dBm)			Tune up		
Band -width	RB No. / RB offset	Frequency	Modulation			Modulation		
			QPSK	16QAM	64QAM	QPSK	16QAM	64QAM
5 MHz	1RB_24	2567.4MHz	21.08	20.80	19.13	22.0	21.0	20.0
		2535MHz	21.03	20.81	19.69	22.0	21.0	20.0
		2502.5MHz	21.07	20.93	19.73	22.0	21.0	20.0
	1RB_12	2567.4MHz	21.03	20.79	19.09	22.0	21.0	20.0
		2535MHz	20.99	20.81	19.87	22.0	21.0	20.0
		2502.5MHz	21.04	20.92	19.83	22.0	21.0	20.0
	1RB_0	2567.4MHz	21.05	20.82	19.20	22.0	21.0	20.0
		2535MHz	20.97	20.71	19.36	22.0	21.0	20.0
		2502.5MHz	21.01	20.99	18.99	22.0	21.0	20.0
	12RB_13	2567.4MHz	20.18	19.27	17.95	21.0	20.0	19.0
		2535MHz	20.13	19.23	17.98	21.0	20.0	19.0
		2502.5MHz	20.09	19.26	17.75	21.0	20.0	19.0
	12RB_6	2567.4MHz	20.17	19.34	18.04	21.0	20.0	19.0
		2535MHz	20.07	19.21	17.98	21.0	20.0	19.0
		2502.5MHz	20.10	19.25	17.66	21.0	20.0	19.0
	12RB_0	2567.4MHz	20.15	19.28	18.08	21.0	20.0	19.0
		2535MHz	20.08	19.13	17.95	21.0	20.0	19.0
		2502.5MHz	20.15	19.25	17.72	21.0	20.0	19.0
	25RB_0	2567.4MHz	20.11	19.22	17.71	21.0	20.0	19.0
		2535MHz	20.19	19.12	17.88	21.0	20.0	19.0
		2502.5MHz	20.10	19.21	17.63	21.0	20.0	19.0



Full Power								
LTE Band 7			Actual output Power (dBm)			Tune up		
Band -width	RB No. / RB offset	Frequency	Modulation			Modulation		
			QPSK	16QAM	64QAM	QPSK	16QAM	64QAM
10 MHz	1RB_49	2565MHz	21.11	20.81	19.18	22.0	21.0	20.0
		2535MHz	21.02	20.77	19.13	22.0	21.0	20.0
		2505MHz	21.09	20.77	18.29	22.0	21.0	20.0
	1RB_24	2565MHz	20.98	20.75	19.13	22.0	21.0	20.0
		2535MHz	20.99	20.74	19.03	22.0	21.0	20.0
		2505MHz	21.03	20.73	18.02	22.0	21.0	20.0
	1RB_0	2565MHz	20.99	20.74	19.18	22.0	21.0	20.0
		2535MHz	20.92	20.73	19.17	22.0	21.0	20.0
		2505MHz	20.99	20.72	19.02	22.0	21.0	20.0
	25RB_25	2565MHz	20.17	19.26	18.04	21.0	20.0	19.0
		2535MHz	20.07	19.52	17.73	21.0	20.0	19.0
		2505MHz	20.21	19.47	17.99	21.0	20.0	19.0
	25RB_12	2565MHz	20.19	19.20	17.97	21.0	20.0	19.0
		2535MHz	20.12	19.43	17.71	21.0	20.0	19.0
		2505MHz	20.24	19.41	17.91	21.0	20.0	19.0
	25RB_0	2565MHz	20.09	19.23	18.00	21.0	20.0	19.0
		2535MHz	20.07	19.36	17.69	21.0	20.0	19.0
		2505MHz	20.13	19.39	17.85	21.0	20.0	19.0
	50RB_0	2565MHz	20.21	19.26	18.00	21.0	20.0	19.0
		2535MHz	20.09	19.26	17.97	21.0	20.0	19.0
		2505MHz	20.23	19.26	18.03	21.0	20.0	19.0



Full Power								
LTE Band 7			Actual output Power (dBm)			Tune up		
Band -width	RB No. / RB offset	Frequency	Modulation			Modulation		
			QPSK	16QAM	64QAM	QPSK	16QAM	64QAM
15 MHz	1RB_74	2562.5MHz	21.19	20.93	19.43	22.0	21.0	20.0
		2535MHz	21.10	20.92	19.30	22.0	21.0	20.0
		2507.5MHz	21.05	20.90	19.29	22.0	21.0	20.0
	1RB_37	2562.5MHz	21.02	20.87	19.43	22.0	21.0	20.0
		2535MHz	20.97	20.84	19.19	22.0	21.0	20.0
		2507.5MHz	21.04	20.89	19.24	22.0	21.0	20.0
	1RB_0	2562.5MHz	21.00	20.92	19.32	22.0	21.0	20.0
		2535MHz	20.92	20.83	19.21	22.0	21.0	20.0
		2507.5MHz	21.00	20.88	19.23	22.0	21.0	20.0
	36RB_38	2562.5MHz	20.26	19.27	17.95	21.0	20.0	19.0
		2535MHz	20.09	19.41	17.93	21.0	20.0	19.0
		2507.5MHz	20.19	19.25	17.90	21.0	20.0	19.0
	36RB_19	2562.5MHz	20.23	19.22	17.93	21.0	20.0	19.0
		2535MHz	20.10	19.22	17.94	21.0	20.0	19.0
		2507.5MHz	20.22	19.22	17.97	21.0	20.0	19.0
	36RB_0	2562.5MHz	20.23	19.26	17.95	21.0	20.0	19.0
		2535MHz	20.17	19.37	17.93	21.0	20.0	19.0
		2507.5MHz	20.19	19.19	17.95	21.0	20.0	19.0
	75RB_0	2562.5MHz	20.23	19.28	18.09	21.0	20.0	19.0
		2535MHz	20.17	19.33	17.72	21.0	20.0	19.0
		2507.5MHz	20.22	19.34	17.98	21.0	20.0	19.0



Full Power								
LTE Band 7			Actual output Power (dBm)			Tune up		
Band -width	RB No. / RB offset	Frequency	Modulation			Modulation		
			QPSK	16QAM	64QAM	QPSK	16QAM	64QAM
20 MHz	1RB_99	2560MHz	21.31	20.98	19.38	22.0	21.0	20.0
		2535MHz	21.33	20.66	19.24	22.0	21.0	20.0
		2510MHz	21.23	20.93	19.51	22.0	21.0	20.0
	1RB_50	2560MHz	21.12	20.85	19.31	22.0	21.0	20.0
		2535MHz	21.12	20.48	19.08	22.0	21.0	20.0
		2510MHz	21.09	20.79	19.43	22.0	21.0	20.0
	1RB_0	2560MHz	21.01	20.79	19.13	22.0	21.0	20.0
		2535MHz	21.05	20.45	19.01	22.0	21.0	20.0
		2510MHz	21.06	20.76	19.34	22.0	21.0	20.0
	50RB_50	2560MHz	20.26	19.39	18.05	21.0	20.0	19.0
		2535MHz	20.28	19.31	18.02	21.0	20.0	19.0
		2510MHz	20.17	19.31	17.99	21.0	20.0	19.0
	50RB_25	2560MHz	20.21	19.34	18.02	21.0	20.0	19.0
		2535MHz	20.10	19.23	17.96	21.0	20.0	19.0
		2510MHz	20.16	19.31	17.99	21.0	20.0	19.0
	50RB_0	2560MHz	20.08	19.32	17.97	21.0	20.0	19.0
		2535MHz	20.15	19.23	17.88	21.0	20.0	19.0
		2510MHz	20.14	19.28	17.93	21.0	20.0	19.0
	100RB_0	2560MHz	20.13	19.36	18.03	21.0	20.0	19.0
		2535MHz	20.10	19.35	17.89	21.0	20.0	19.0
		2510MHz	20.23	19.36	17.89	21.0	20.0	19.0



Sensor on								
LTE Band 7			Actual output Power (dBm)			Tune up		
Band -width	RB No. / RB offset	Frequency	Modulation			Modulation		
			QPSK	16QAM	64QAM	QPSK	16QAM	64QAM
5 MHz	1RB_24	2567.4MHz	11.06	10.29	9.66	12.5	11.5	10.5
		2535MHz	11.21	10.51	9.95	12.5	11.5	10.5
		2502.5MHz	11.28	10.88	10.10	12.5	11.5	10.5
	1RB_12	2567.4MHz	11.67	10.91	10.29	12.5	11.5	10.5
		2535MHz	11.74	11.05	10.32	12.5	11.5	10.5
		2502.5MHz	11.53	11.13	10.37	12.5	11.5	10.5
	1RB_0	2567.4MHz	11.26	10.49	9.84	12.5	11.5	10.5
		2535MHz	11.21	10.51	9.96	12.5	11.5	10.5
		2502.5MHz	10.64	10.24	9.47	12.5	11.5	10.5
	12RB_13	2567.4MHz	10.71	9.90	8.29	11.5	10.5	9.5
		2535MHz	10.55	10.21	8.54	11.5	10.5	9.5
		2502.5MHz	10.78	10.19	8.55	11.5	10.5	9.5
	12RB_6	2567.4MHz	10.92	10.10	8.49	11.5	10.5	9.5
		2535MHz	10.71	10.37	8.71	11.5	10.5	9.5
		2502.5MHz	10.77	10.18	8.54	11.5	10.5	9.5
	12RB_0	2567.4MHz	10.82	10.01	8.39	11.5	10.5	9.5
		2535MHz	10.56	10.21	8.55	11.5	10.5	9.5
		2502.5MHz	10.45	9.86	8.22	11.5	10.5	9.5
	25RB_0	2567.4MHz	10.77	9.96	8.30	11.5	10.5	9.5
		2535MHz	10.56	10.21	8.52	11.5	10.5	9.5
		2502.5MHz	10.63	10.04	8.36	11.5	10.5	9.5



Sensor on								
LTE Band 7			Actual output Power (dBm)			Tune up		
Band -width	RB No. / RB offset	Frequency	Modulation			Modulation		
			QPSK	16QAM	64QAM	QPSK	16QAM	64QAM
10 MHz	1RB_49	2565MHz	11.80	10.94	10.35	12.5	11.5	10.5
		2535MHz	11.97	11.16	10.29	12.5	11.5	10.5
		2505MHz	11.85	11.27	10.19	12.5	11.5	10.5
	1RB_24	2565MHz	11.79	11.02	10.39	12.5	11.5	10.5
		2535MHz	11.68	10.92	10.40	12.5	11.5	10.5
		2505MHz	11.40	11.21	10.41	12.5	11.5	10.5
	1RB_0	2565MHz	11.75	10.93	10.34	12.5	11.5	10.5
		2535MHz	11.36	10.56	10.08	12.5	11.5	10.5
		2505MHz	11.45	10.27	9.49	12.5	11.5	10.5
	25RB_25	2565MHz	11.14	10.30	8.61	11.5	10.5	9.5
		2535MHz	10.88	10.50	8.82	11.5	10.5	9.5
		2505MHz	11.28	10.34	9.00	11.5	10.5	9.5
	25RB_12	2565MHz	11.11	10.28	8.60	11.5	10.5	9.5
		2535MHz	10.72	10.35	8.66	11.5	10.5	9.5
		2505MHz	10.95	10.31	8.67	11.5	10.5	9.5
	25RB_0	2565MHz	11.13	10.30	8.62	11.5	10.5	9.5
		2535MHz	10.60	10.24	8.55	11.5	10.5	9.5
		2505MHz	10.59	9.94	8.31	11.5	10.5	9.5
	50RB_0	2565MHz	11.13	10.28	8.61	11.5	10.5	9.5
		2535MHz	10.74	10.37	8.69	11.5	10.5	9.5
		2505MHz	10.94	10.31	8.66	11.5	10.5	9.5



Sensor on								
LTE Band 7			Actual output Power (dBm)			Tune up		
Band -width	RB No. / RB offset	Frequency	Modulation			Modulation		
			QPSK	16QAM	64QAM	QPSK	16QAM	64QAM
15 MHz	1RB_74	2562.5MHz	11.29	10.45	9.83	12.5	11.5	10.5
		2535MHz	11.76	10.99	10.33	12.5	11.5	10.5
		2507.5MHz	11.64	11.43	10.42	12.5	11.5	10.5
	1RB_37	2562.5MHz	11.71	10.92	10.29	12.5	11.5	10.5
		2535MHz	11.70	10.96	10.35	12.5	11.5	10.5
		2507.5MHz	11.58	11.39	10.38	12.5	11.5	10.5
	1RB_0	2562.5MHz	11.88	11.06	10.44	12.5	11.5	10.5
		2535MHz	11.56	10.79	10.37	12.5	11.5	10.5
		2507.5MHz	10.69	10.47	9.80	12.5	11.5	10.5
	36RB_38	2562.5MHz	10.88	10.02	8.38	11.5	10.5	9.5
		2535MHz	10.78	10.40	8.73	11.5	10.5	9.5
		2507.5MHz	11.27	10.33	9.00	11.5	10.5	9.5
	36RB_19	2562.5MHz	11.02	10.17	8.53	11.5	10.5	9.5
		2535MHz	10.69	10.31	8.64	11.5	10.5	9.5
		2507.5MHz	11.10	10.45	8.82	11.5	10.5	9.5
	36RB_0	2562.5MHz	11.23	10.38	8.73	11.5	10.5	9.5
		2535MHz	10.71	10.33	8.67	11.5	10.5	9.5
		2507.5MHz	10.83	10.18	8.54	11.5	10.5	9.5
	75RB_0	2562.5MHz	11.05	10.19	8.51	11.5	10.5	9.5
		2535MHz	10.74	10.35	8.67	11.5	10.5	9.5
		2507.5MHz	11.06	10.40	8.75	11.5	10.5	9.5



Sensor on								
LTE Band 7			Actual output Power (dBm)			Tune up		
Band -width	RB No. / RB offset	Frequency	Modulation			Modulation		
			QPSK	16QAM	64QAM	QPSK	16QAM	64QAM
20 MHz	1RB_99	2560MHz	11.51	10.78	10.18	12.5	11.5	10.5
		2535MHz	12.06	11.42	10.32	12.5	11.5	10.5
		2510MHz	11.79	11.36	10.21	12.5	11.5	10.5
	1RB_50	2560MHz	11.73	11.12	10.39	12.5	11.5	10.5
		2535MHz	11.68	10.94	10.40	12.5	11.5	10.5
		2510MHz	11.62	11.47	10.28	12.5	11.5	10.5
	1RB_0	2560MHz	12.22	11.44	10.33	12.5	11.5	10.5
		2535MHz	12.04	11.21	10.29	12.5	11.5	10.5
		2510MHz	11.16	10.83	10.07	12.5	11.5	10.5
	50RB_50	2560MHz	11.08	10.30	8.62	11.5	10.5	9.5
		2535MHz	10.97	10.36	8.95	11.5	10.5	9.5
		2510MHz	11.13	10.38	9.15	11.5	10.5	9.5
	50RB_25	2560MHz	11.19	10.45	8.76	11.5	10.5	9.5
		2535MHz	10.79	10.44	8.75	11.5	10.5	9.5
		2510MHz	10.98	10.37	9.00	11.5	10.5	9.5
	50RB_0	2560MHz	11.46	10.37	9.02	11.5	10.5	9.5
		2535MHz	10.92	10.28	8.89	11.5	10.5	9.5
		2510MHz	10.88	10.50	8.83	11.5	10.5	9.5
	100RB_0	2560MHz	11.26	10.48	8.81	11.5	10.5	9.5
		2535MHz	10.94	10.28	8.90	11.5	10.5	9.5
		2510MHz	10.99	10.33	8.97	11.5	10.5	9.5



Full Power								
LTE Band 12			Actual output Power (dBm)			Tune up		
Band -width	RB No. / RB offset	Frequency	Modulation			Modulation		
			QPSK	16QAM	64QAM	QPSK	16QAM	64QAM
1.4 MHz	1RB_5	715.3MHz	24.12	23.11	22.21	24.5	23.5	22.5
		707.5MHz	24.10	23.11	22.36	24.5	23.5	22.5
		699.7MHz	24.21	23.21	22.28	24.5	23.5	22.5
	1RB_3	715.3MHz	24.24	23.09	22.19	24.5	23.5	22.5
		707.5MHz	24.05	23.12	22.40	24.5	23.5	22.5
		699.7MHz	24.20	23.17	22.34	24.5	23.5	22.5
	1RB_0	715.3MHz	24.11	23.12	22.36	24.5	23.5	22.5
		707.5MHz	24.14	23.22	22.20	24.5	23.5	22.5
		699.7MHz	24.25	23.25	22.32	24.5	23.5	22.5
	3RB_3	715.3MHz	24.23	23.36	22.01	24.5	23.5	22.5
		707.5MHz	24.30	23.35	22.33	24.5	23.5	22.5
		699.7MHz	24.34	23.42	22.12	24.5	23.5	22.5
	3RB_1	715.3MHz	24.27	23.40	22.01	24.5	23.5	22.5
		707.5MHz	24.30	23.36	22.38	24.5	23.5	22.5
		699.7MHz	24.31	23.21	22.18	24.5	23.5	22.5
	3RB_0	715.3MHz	24.20	23.36	22.32	24.5	23.5	22.5
		707.5MHz	24.24	23.31	22.45	24.5	23.5	22.5
		699.7MHz	24.37	23.46	22.14	24.5	23.5	22.5
	6RB_0	715.3MHz	23.17	21.91	21.47	23.5	22.5	21.5
		707.5MHz	23.27	22.31	21.33	23.5	22.5	21.5
		699.7MHz	23.39	22.08	21.43	23.5	22.5	21.5



Full Power								
LTE Band 12			Actual output Power (dBm)			Tune up		
Band -width	RB No. / RB offset	Frequency	Modulation			Modulation		
			QPSK	16QAM	64QAM	QPSK	16QAM	64QAM
3 MHz	1RB_14	714.5MHz	24.14	23.17	22.03	24.5	23.5	22.5
		707.5MHz	24.11	23.16	22.33	24.5	23.5	22.5
		700.5MHz	24.26	23.17	22.41	24.5	23.5	22.5
	1RB_7	714.5MHz	24.10	23.08	22.36	24.5	23.5	22.5
		707.5MHz	24.08	23.17	22.46	24.5	23.5	22.5
		700.5MHz	24.25	23.23	22.39	24.5	23.5	22.5
	1RB_0	714.5MHz	24.17	23.10	22.38	24.5	23.5	22.5
		707.5MHz	24.13	23.19	22.42	24.5	23.5	22.5
		700.5MHz	24.26	23.28	22.32	24.5	23.5	22.5
	8RB_7	714.5MHz	23.24	22.22	21.29	23.5	22.5	21.5
		707.5MHz	23.33	22.38	21.32	23.5	22.5	21.5
		700.5MHz	23.29	22.28	21.35	23.5	22.5	21.5
	8RB_4	714.5MHz	23.28	22.31	21.33	23.5	22.5	21.5
		707.5MHz	23.29	22.40	21.28	23.5	22.5	21.5
		700.5MHz	23.25	22.37	21.17	23.5	22.5	21.5
	8RB_0	714.5MHz	23.22	22.36	21.35	23.5	22.5	21.5
		707.5MHz	23.32	22.36	21.40	23.5	22.5	21.5
		700.5MHz	23.43	22.39	21.36	23.5	22.5	21.5
	15RB_0	714.5MHz	23.16	22.28	21.30	23.5	22.5	21.5
		707.5MHz	23.32	22.31	21.26	23.5	22.5	21.5
		700.5MHz	23.26	22.43	21.41	23.5	22.5	21.5



Full Power								
LTE Band 12			Actual output Power (dBm)			Tune up		
Band -width	RB No. / RB offset	Frequency	Modulation			Modulation		
			QPSK	16QAM	64QAM	QPSK	16QAM	64QAM
5 MHz	1RB_24	713.5MHz	24.07	23.11	22.11	24.5	23.5	22.5
		707.5MHz	24.08	23.15	22.17	24.5	23.5	22.5
		701.5MHz	24.30	23.21	22.26	24.5	23.5	22.5
	1RB_12	713.5MHz	24.04	23.09	22.38	24.5	23.5	22.5
		707.5MHz	24.09	23.17	22.44	24.5	23.5	22.5
		701.5MHz	24.26	23.21	22.33	24.5	23.5	22.5
	1RB_0	713.5MHz	24.02	23.17	22.17	24.5	23.5	22.5
		707.5MHz	24.16	22.75	22.10	24.5	23.5	22.5
		701.5MHz	24.32	22.81	21.96	24.5	23.5	22.5
	12RB_13	713.5MHz	23.23	22.25	21.23	24.5	23.5	22.5
		707.5MHz	23.31	22.23	21.27	23.5	22.5	21.5
		701.5MHz	23.27	22.33	21.45	23.5	22.5	21.5
	12RB_6	713.5MHz	23.19	22.15	21.30	23.5	22.5	21.5
		707.5MHz	23.31	22.28	21.17	23.5	22.5	21.5
		701.5MHz	23.23	22.29	21.36	23.5	22.5	21.5
	12RB_0	713.5MHz	23.13	22.15	21.23	23.5	22.5	21.5
		707.5MHz	23.26	21.83	21.20	23.5	22.5	21.5
		701.5MHz	23.39	21.89	21.40	23.5	22.5	21.5
	25RB_0	713.5MHz	23.26	22.41	21.16	23.5	22.5	21.5
		707.5MHz	23.24	22.41	21.17	23.5	22.5	21.5
		701.5MHz	23.23	22.41	21.34	23.5	22.5	21.5



Full Power								
LTE Band 12			Actual output Power (dBm)			Tune up		
Band -width	RB No. / RB offset	Frequency	Modulation			Modulation		
			QPSK	16QAM	64QAM	QPSK	16QAM	64QAM
10 MHz	1RB_49	711MHz	24.15	23.34	21.98	24.5	23.5	22.5
		707.5MHz	24.15	23.26	22.30	24.5	23.5	22.5
		704MHz	24.19	22.87	22.31	24.5	23.5	22.5
	1RB_24	711MHz	24.10	23.38	22.47	24.5	23.5	22.5
		707.5MHz	24.18	23.32	22.29	24.5	23.5	22.5
		704MHz	24.16	22.82	22.20	24.5	23.5	22.5
	1RB_0	711MHz	24.15	23.39	22.08	24.5	23.5	22.5
		707.5MHz	24.06	23.24	22.21	24.5	23.5	22.5
		704MHz	24.16	22.87	21.72	24.5	23.5	22.5
	25RB_25	711MHz	23.32	22.34	21.43	23.5	22.5	21.5
		707.5MHz	23.22	22.29	21.27	23.5	22.5	21.5
		704MHz	23.44	22.20	21.35	23.5	22.5	21.5
	25RB_12	711MHz	23.35	22.49	21.36	23.5	22.5	21.5
		707.5MHz	23.31	22.32	21.27	23.5	22.5	21.5
		704MHz	23.28	22.40	21.36	23.5	22.5	21.5
	25RB_0	711MHz	23.31	22.32	21.36	23.5	22.5	21.5
		707.5MHz	23.38	21.97	21.26	23.5	22.5	21.5
		704MHz	23.30	22.44	21.33	23.5	22.5	21.5
	50RB_0	711MHz	23.34	22.36	21.36	23.5	22.5	21.5
		707.5MHz	23.29	22.32	21.38	23.5	22.5	21.5
		704MHz	23.19	22.37	21.33	23.5	22.5	21.5



Sensor on								
LTE Band 12			Actual output Power (dBm)			Tune up		
Band -width	RB No. / RB offset	Frequency	Modulation			Modulation		
			QPSK	16QAM	64QAM	QPSK	16QAM	64QAM
1.4 MHz	1RB_5	715.3MHz	18.00	17.48	16.43	19.5	18.5	17.5
		707.5MHz	18.64	18.03	17.12	19.5	18.5	17.5
		699.7MHz	18.74	18.10	17.12	19.5	18.5	17.5
	1RB_3	715.3MHz	18.21	17.68	16.63	19.5	18.5	17.5
		707.5MHz	18.85	18.25	17.35	19.5	18.5	17.5
		699.7MHz	18.95	18.30	17.35	19.5	18.5	17.5
	1RB_0	715.3MHz	17.95	17.43	16.40	19.5	18.5	17.5
		707.5MHz	18.66	18.03	17.19	19.5	18.5	17.5
		699.7MHz	18.79	18.15	17.16	19.5	18.5	17.5
	3RB_3	715.3MHz	18.15	17.31	16.52	19.5	18.5	17.5
		707.5MHz	18.78	17.94	17.16	19.5	18.5	17.5
		699.7MHz	18.86	18.02	17.20	19.5	18.5	17.5
	3RB_1	715.3MHz	18.20	17.36	16.57	19.5	18.5	17.5
		707.5MHz	18.86	18.03	17.24	19.5	18.5	17.5
		699.7MHz	18.95	18.11	17.34	19.5	18.5	17.5
	3RB_0	715.3MHz	18.12	17.28	16.49	19.5	18.5	17.5
		707.5MHz	18.80	17.97	17.18	19.5	18.5	17.5
		699.7MHz	18.91	18.06	17.29	19.5	18.5	17.5
	6RB_0	715.3MHz	17.25	16.46	15.36	18.5	17.5	16.5
		707.5MHz	17.92	17.14	16.06	18.5	17.5	16.5
		699.7MHz	18.02	17.22	16.14	18.5	17.5	16.5



Sensor on								
LTE Band 12			Actual output Power (dBm)			Tune up		
Band -width	RB No. / RB offset	Frequency	Modulation			Modulation		
			QPSK	16QAM	64QAM	QPSK	16QAM	64QAM
3 MHz	1RB_14	714.5MHz	18.25	17.56	16.55	19.5	18.5	17.5
		707.5MHz	18.81	18.23	17.26	19.5	18.5	17.5
		700.5MHz	18.90	18.33	17.36	19.5	18.5	17.5
	1RB_7	714.5MHz	18.54	17.85	16.87	19.5	18.5	17.5
		707.5MHz	18.88	18.30	17.35	19.5	18.5	17.5
		700.5MHz	18.90	18.33	17.37	19.5	18.5	17.5
	1RB_0	714.5MHz	18.62	17.92	16.92	19.5	18.5	17.5
		707.5MHz	18.69	18.13	17.13	19.5	18.5	17.5
		700.5MHz	18.82	18.25	17.31	19.5	18.5	17.5
	8RB_7	714.5MHz	17.32	16.50	15.51	18.5	17.5	16.5
		707.5MHz	17.99	17.22	16.17	18.5	17.5	16.5
		700.5MHz	18.05	17.23	16.21	18.5	17.5	16.5
	8RB_4	714.5MHz	17.44	16.62	15.63	18.5	17.5	16.5
		707.5MHz	18.00	17.22	16.19	18.5	17.5	16.5
		700.5MHz	18.05	17.23	16.22	18.5	17.5	16.5
	8RB_0	714.5MHz	17.57	16.76	15.77	18.5	17.5	16.5
		707.5MHz	17.97	17.19	16.15	18.5	17.5	16.5
		700.5MHz	18.03	17.21	16.20	18.5	17.5	16.5
	15RB_0	714.5MHz	17.44	16.63	15.58	18.5	17.5	16.5
		707.5MHz	17.98	17.17	16.12	18.5	17.5	16.5
		700.5MHz	18.05	17.20	16.18	18.5	17.5	16.5



Sensor on								
LTE Band 12			Actual output Power (dBm)			Tune up		
Band -width	RB No. / RB offset	Frequency	Modulation			Modulation		
			QPSK	16QAM	64QAM	QPSK	16QAM	64QAM
5 MHz	1RB_24	713.5MHz	17.70	16.88	15.92	19.5	18.5	17.5
		707.5MHz	18.56	17.98	16.96	19.5	18.5	17.5
		701.5MHz	18.51	17.92	16.90	19.5	18.5	17.5
	1RB_12	713.5MHz	18.51	17.74	16.74	19.5	18.5	17.5
		707.5MHz	18.89	18.31	17.28	19.5	18.5	17.5
		701.5MHz	19.01	18.42	17.45	19.5	18.5	17.5
	1RB_0	713.5MHz	18.63	17.82	16.91	19.5	18.5	17.5
		707.5MHz	18.25	17.67	16.66	19.5	18.5	17.5
		701.5MHz	18.46	17.91	16.91	19.5	18.5	17.5
	12RB_13	713.5MHz	17.10	16.22	15.24	18.5	17.5	16.5
		707.5MHz	17.97	17.11	16.12	18.5	17.5	16.5
		701.5MHz	18.04	17.16	16.17	18.5	17.5	16.5
	12RB_6	713.5MHz	17.56	16.68	15.71	18.5	17.5	16.5
		707.5MHz	18.05	17.20	16.20	18.5	17.5	16.5
		701.5MHz	18.13	17.26	16.28	18.5	17.5	16.5
	12RB_0	713.5MHz	17.74	16.86	15.89	18.5	17.5	16.5
		707.5MHz	17.86	17.01	15.99	18.5	17.5	16.5
		701.5MHz	17.92	17.05	16.06	18.5	17.5	16.5
	25RB_0	713.5MHz	17.43	16.54	15.56	18.5	17.5	16.5
		707.5MHz	17.92	17.06	16.03	18.5	17.5	16.5
		701.5MHz	17.99	17.11	16.09	18.5	17.5	16.5



Sensor on								
LTE Band 12			Actual output Power (dBm)			Tune up		
Band -width	RB No. / RB offset	Frequency	Modulation			Modulation		
			QPSK	16QAM	64QAM	QPSK	16QAM	64QAM
10 MHz	1RB_49	711MHz	18.57	17.76	16.81	19.5	18.5	17.5
		707.5MHz	18.98	18.42	17.43	19.5	18.5	17.5
		704MHz	19.18	18.37	17.38	19.5	18.5	17.5
	1RB_24	711MHz	19.21	18.36	17.27	19.5	18.5	17.5
		707.5MHz	18.77	18.24	17.31	19.5	18.5	17.5
		704MHz	18.52	17.95	17.00	19.5	18.5	17.5
	1RB_0	711MHz	18.98	18.26	17.28	19.5	18.5	17.5
		707.5MHz	18.20	17.60	16.58	19.5	18.5	17.5
		704MHz	18.12	17.62	16.58	19.5	18.5	17.5
	25RB_25	711MHz	17.86	17.07	16.04	18.5	17.5	16.5
		707.5MHz	18.25	17.49	16.47	18.5	17.5	16.5
		704MHz	18.18	17.36	16.34	18.5	17.5	16.5
	25RB_12	711MHz	18.18	17.43	16.42	18.5	17.5	16.5
		707.5MHz	18.03	17.26	16.23	18.5	17.5	16.5
		704MHz	17.82	16.97	15.93	18.5	17.5	16.5
	25RB_0	711MHz	18.20	17.45	16.41	18.5	17.5	16.5
		707.5MHz	17.78	16.95	15.91	18.5	17.5	16.5
		704MHz	17.56	16.70	15.65	18.5	17.5	16.5
	50RB_0	711MHz	18.03	17.28	16.24	18.5	17.5	16.5
		707.5MHz	18.02	17.22	16.20	18.5	17.5	16.5
		704MHz	17.88	17.05	16.02	18.5	17.5	16.5



Full Power								
LTE Band 13			Actual output Power (dBm)			Tune up		
Band -width	RB No. / RB offset	Frequency	Modulation			Modulation		
			QPSK	16QAM	64QAM	QPSK	16QAM	64QAM
5 MHz	1RB_24	784.5MHz	23.19	22.13	21.68	24.0	23.0	22.0
		782MHz	23.28	22.11	21.70	24.0	23.0	22.0
		779.5MHz	23.23	22.14	21.79	24.0	23.0	22.0
	1RB_12	784.5MHz	23.26	22.18	21.79	24.0	23.0	22.0
		782MHz	23.26	22.10	21.67	24.0	23.0	22.0
		779.5MHz	23.30	22.37	21.73	24.0	23.0	22.0
	1RB_0	784.5MHz	23.20	22.16	21.78	24.0	23.0	22.0
		782MHz	23.18	22.40	21.70	24.0	23.0	22.0
		779.5MHz	23.41	22.32	21.64	24.0	23.0	22.0
	12RB_13	784.5MHz	22.31	21.46	19.56	23.0	22.0	21.0
		782MHz	22.33	21.49	19.13	23.0	22.0	21.0
		779.5MHz	22.57	21.54	19.57	23.0	22.0	21.0
	12RB_6	784.5MHz	22.23	21.46	19.61	23.0	22.0	21.0
		782MHz	22.27	21.49	19.10	23.0	22.0	21.0
		779.5MHz	22.54	21.49	19.66	23.0	22.0	21.0
	12RB_0	784.5MHz	22.24	21.54	19.17	23.0	22.0	21.0
		782MHz	22.50	21.55	19.32	23.0	22.0	21.0
		779.5MHz	22.48	21.88	19.18	23.0	22.0	21.0
25RB_0	784.5MHz	22.31	21.43	19.37	23.0	22.0	21.0	
	782MHz	22.22	21.54	19.11	23.0	22.0	21.0	
	779.5MHz	22.55	21.49	19.36	23.0	22.0	21.0	
Full Power								
LTE Band 13			Actual output Power (dBm)			Tune up		
Band -width	RB No. / RB offset	Frequency	Modulation			Modulation		
			QPSK	16QAM	64QAM	QPSK	16QAM	64QAM
10 MHz	1RB_49	782MHz	23.17	22.21	21.70	24.5	23.5	22.5
	1RB_24	782MHz	23.22	22.18	21.69	24.5	23.5	22.5
	1RB_0	782MHz	23.45	22.37	21.59	24.5	23.5	22.5
	25RB_25	782MHz	22.30	21.69	20.41	23.5	22.5	21.5
	25RB_12	782MHz	22.35	21.70	20.56	23.5	22.5	21.5
	25RB_0	782MHz	22.54	21.72	20.78	23.5	22.5	21.5
	50RB_0	782MHz	22.30	21.60	20.25	23.5	22.5	21.5



Sensor on								
LTE Band 13			Actual output Power (dBm)			Tune up		
Band -width	RB No. / RB offset	Frequency	Modulation			Modulation		
			QPSK	16QAM	64QAM	QPSK	16QAM	64QAM
5 MHz	1RB_24	784.5MHz	17.50	16.73	15.70	18.5	17.5	16.5
		782MHz	17.45	16.89	15.78	18.5	17.5	16.5
		779.5MHz	17.41	16.98	15.72	18.5	17.5	16.5
	1RB_12	784.5MHz	18.25	17.47	16.46	18.5	17.5	16.5
		782MHz	17.41	16.90	15.80	18.5	17.5	16.5
		779.5MHz	17.92	17.48	16.27	18.5	17.5	16.5
	1RB_0	784.5MHz	17.12	16.35	15.30	18.5	17.5	16.5
		782MHz	16.88	16.33	15.25	18.5	17.5	16.5
		779.5MHz	16.93	16.78	15.52	18.5	17.5	16.5
	12RB_13	784.5MHz	17.09	16.08	14.64	17.5	16.5	15.5
		782MHz	16.69	15.67	14.20	17.5	16.5	15.5
		779.5MHz	16.87	15.91	14.44	17.5	16.5	15.5
	12RB_6	784.5MHz	17.17	16.17	14.71	17.5	16.5	15.5
		782MHz	16.59	15.60	14.12	17.5	16.5	15.5
		779.5MHz	16.98	16.01	14.55	17.5	16.5	15.5
	12RB_0	784.5MHz	16.73	15.72	14.25	17.5	16.5	15.5
		782MHz	16.40	15.40	13.92	17.5	16.5	15.5
		779.5MHz	16.51	15.53	14.06	17.5	16.5	15.5
25RB_0	784.5MHz	16.93	15.92	14.42	17.5	16.5	15.5	
	782MHz	16.55	15.54	14.03	17.5	16.5	15.5	
	779.5MHz	16.71	15.73	14.24	17.5	16.5	15.5	
Sensor on								
LTE Band 13			Actual output Power (dBm)			Tune up		
Band -width	RB No. / RB offset	Frequency	Modulation			Modulation		
			QPSK	16QAM	64QAM	QPSK	16QAM	64QAM
10 MHz	1RB_49	782MHz	18.11	17.59	16.37	18.5	17.5	16.5
	1RB_24	782MHz	17.34	16.84	15.64	18.5	17.5	16.5
	1RB_0	782MHz	16.18	16.71	15.44	18.5	17.5	16.5
	25RB_25	782MHz	17.19	16.23	14.71	17.5	16.5	15.5
	25RB_12	782MHz	16.67	15.70	14.18	17.5	16.5	15.5
	25RB_0	782MHz	16.33	15.35	13.83	17.5	16.5	15.5
	50RB_0	782MHz	16.78	15.82	14.30	17.5	16.5	15.5



Full Power								
LTE Band 66			Actual output Power (dBm)			Tune up		
Band -width	RB No. / RB offset	Frequency	Modulation			Modulation		
			QPSK	16QAM	64QAM	QPSK	16QAM	64QAM
1.4 MHz	1RB_5	1779.3MHz	22.56	22.19	20.75	23.5	22.5	21.5
		1745MHz	22.59	22.27	20.55	23.5	22.5	21.5
		1710.7MHz	22.56	22.31	20.73	23.5	22.5	21.5
	1RB_3	1779.3MHz	22.51	22.26	20.90	23.5	22.5	21.5
		1745MHz	22.55	22.31	20.52	23.5	22.5	21.5
		1710.7MHz	22.59	22.21	20.75	23.5	22.5	21.5
	1RB_0	1779.3MHz	22.54	22.23	20.80	23.5	22.5	21.5
		1745MHz	22.57	22.26	20.49	23.5	22.5	21.5
		1710.7MHz	22.58	22.23	20.77	23.5	22.5	21.5
	3RB_3	1779.3MHz	22.67	21.94	20.61	23.5	22.5	21.5
		1745MHz	22.76	21.97	20.72	23.5	22.5	21.5
		1710.7MHz	22.62	21.92	20.66	23.5	22.5	21.5
	3RB_1	1779.3MHz	22.69	21.88	20.64	23.5	22.5	21.5
		1745MHz	22.78	21.89	20.68	23.5	22.5	21.5
		1710.7MHz	22.70	21.96	20.65	23.5	22.5	21.5
	3RB_0	1779.3MHz	22.71	21.99	20.64	23.5	22.5	21.5
		1745MHz	22.76	22.00	20.69	23.5	22.5	21.5
		1710.7MHz	22.65	21.98	20.72	23.5	22.5	21.5
	6RB_0	1779.3MHz	21.57	20.59	19.73	22.5	21.5	20.5
		1745MHz	21.70	20.66	19.84	22.5	21.5	20.5
		1710.7MHz	21.68	20.57	19.77	22.5	21.5	20.5



Full Power								
LTE Band 66			Actual output Power (dBm)			Tune up		
Band -width	RB No. / RB offset	Frequency	Modulation			Modulation		
			QPSK	16QAM	64QAM	QPSK	16QAM	64QAM
3 MHz	1RB_14	1778.5MHz	22.58	22.22	20.68	23.5	22.5	21.5
		1745MHz	22.52	22.21	21.02	23.5	22.5	21.5
		1711.5MHz	22.50	22.19	20.80	23.5	22.5	21.5
	1RB_7	1778.5MHz	22.50	22.24	20.72	23.5	22.5	21.5
		1745MHz	22.51	22.30	21.11	23.5	22.5	21.5
		1711.5MHz	22.60	22.23	20.81	23.5	22.5	21.5
	1RB_0	1778.5MHz	22.58	22.28	20.68	23.5	22.5	21.5
		1745MHz	22.55	22.25	20.94	23.5	22.5	21.5
		1711.5MHz	22.55	22.22	20.83	23.5	22.5	21.5
	8RB_7	1778.5MHz	21.60	20.80	19.70	22.5	21.5	20.5
		1745MHz	21.73	21.00	19.92	22.5	21.5	20.5
		1711.5MHz	21.67	20.87	19.81	22.5	21.5	20.5
	8RB_4	1778.5MHz	21.66	20.85	19.75	22.5	21.5	20.5
		1745MHz	21.64	20.92	19.86	22.5	21.5	20.5
		1711.5MHz	21.73	20.83	19.78	22.5	21.5	20.5
	8RB_0	1778.5MHz	21.78	20.89	19.77	22.5	21.5	20.5
		1745MHz	21.69	20.98	19.92	22.5	21.5	20.5
		1711.5MHz	21.74	20.85	19.67	22.5	21.5	20.5
	15RB_0	1778.5MHz	21.64	20.77	19.87	22.5	21.5	20.5
		1745MHz	21.72	20.98	20.01	22.5	21.5	20.5
		1711.5MHz	21.70	20.79	19.88	22.5	21.5	20.5



Full Power								
LTE Band 66			Actual output Power (dBm)			Tune up		
Band -width	RB No. / RB offset	Frequency	Modulation			Modulation		
			QPSK	16QAM	64QAM	QPSK	16QAM	64QAM
5 MHz	1RB_24	1777.5MHz	22.53	22.25	20.75	23.5	22.5	21.5
		1745MHz	22.53	22.20	20.79	23.5	22.5	21.5
		1712.5MHz	22.49	22.31	20.78	23.5	22.5	21.5
	1RB_12	1777.5MHz	22.49	22.19	20.89	23.5	22.5	21.5
		1745MHz	22.53	22.27	20.77	23.5	22.5	21.5
		1712.5MHz	22.53	22.26	20.78	23.5	22.5	21.5
	1RB_0	1777.5MHz	22.52	22.20	20.83	23.5	22.5	21.5
		1745MHz	22.52	22.24	20.87	23.5	22.5	21.5
		1712.5MHz	22.48	22.30	20.78	23.5	22.5	21.5
	12RB_13	1777.5MHz	21.63	20.75	19.80	22.5	21.5	20.5
		1745MHz	21.65	20.76	19.87	22.5	21.5	20.5
		1712.5MHz	21.57	20.75	19.79	22.5	21.5	20.5
	12RB_6	1777.5MHz	21.63	20.77	19.84	22.5	21.5	20.5
		1745MHz	21.72	20.87	19.93	22.5	21.5	20.5
		1712.5MHz	21.68	20.67	19.76	22.5	21.5	20.5
	12RB_0	1777.5MHz	21.66	20.81	19.89	22.5	21.5	20.5
		1745MHz	21.66	20.87	19.94	22.5	21.5	20.5
		1712.5MHz	21.61	20.72	19.75	22.5	21.5	20.5
	25RB_0	1777.5MHz	21.58	20.98	19.70	22.5	21.5	20.5
		1745MHz	21.59	21.02	19.87	22.5	21.5	20.5
		1712.5MHz	21.56	20.67	19.82	22.5	21.5	20.5



Full Power								
LTE Band 66			Actual output Power (dBm)			Tune up		
Band -width	RB No. / RB offset	Frequency	Modulation			Modulation		
			QPSK	16QAM	64QAM	QPSK	16QAM	64QAM
10 MHz	1RB_49	1715MHz	22.52	22.22	20.74	23.5	22.5	21.5
		1715MHz	22.63	22.34	20.83	23.5	22.5	21.5
		1715MHz	22.50	22.27	20.75	23.5	22.5	21.5
	1RB_24	1715MHz	22.49	22.26	20.73	23.5	22.5	21.5
		1715MHz	22.68	22.36	20.80	23.5	22.5	21.5
		1715MHz	22.53	22.25	20.76	23.5	22.5	21.5
	1RB_0	1715MHz	22.58	22.40	20.79	23.5	22.5	21.5
		1715MHz	22.64	22.41	20.84	23.5	22.5	21.5
		1715MHz	22.58	22.30	20.73	23.5	22.5	21.5
	25RB_25	1715MHz	21.64	20.73	19.81	22.5	21.5	20.5
		1715MHz	21.64	20.73	19.89	22.5	21.5	20.5
		1715MHz	21.61	20.61	19.68	22.5	21.5	20.5
	25RB_12	1715MHz	21.69	20.77	19.85	22.5	21.5	20.5
		1715MHz	21.73	20.78	19.94	22.5	21.5	20.5
		1715MHz	21.67	20.65	19.71	22.5	21.5	20.5
	25RB_0	1715MHz	21.72	20.75	19.89	22.5	21.5	20.5
		1715MHz	21.73	20.70	19.86	22.5	21.5	20.5
		1715MHz	21.55	20.68	19.76	22.5	21.5	20.5
	50RB_0	1715MHz	21.70	20.85	19.90	22.5	21.5	20.5
		1715MHz	21.69	20.81	19.90	22.5	21.5	20.5
		1715MHz	21.61	20.76	19.86	22.5	21.5	20.5



Full Power								
LTE Band 66			Actual output Power (dBm)			Tune up		
Band -width	RB No. / RB offset	Frequency	Modulation			Modulation		
			QPSK	16QAM	64QAM	QPSK	16QAM	64QAM
15 MHz	1RB_74	1772.5MHz	22.49	22.14	20.88	23.5	22.5	21.5
		1745MHz	22.60	22.36	20.78	23.5	22.5	21.5
		1717.5MHz	22.52	22.19	20.76	23.5	22.5	21.5
	1RB_37	1772.5MHz	22.60	22.33	20.81	23.5	22.5	21.5
		1745MHz	22.68	22.38	20.89	23.5	22.5	21.5
		1717.5MHz	22.48	22.26	20.79	23.5	22.5	21.5
	1RB_0	1772.5MHz	22.61	22.40	21.03	23.5	22.5	21.5
		1745MHz	22.69	22.39	20.79	23.5	22.5	21.5
		1717.5MHz	22.62	22.31	20.70	23.5	22.5	21.5
	36RB_38	1772.5MHz	21.66	20.77	19.81	22.5	21.5	20.5
		1745MHz	21.73	20.85	19.83	22.5	21.5	20.5
		1717.5MHz	21.57	20.89	19.72	22.5	21.5	20.5
	36RB_19	1772.5MHz	21.70	20.78	19.78	22.5	21.5	20.5
		1745MHz	21.74	20.82	19.85	22.5	21.5	20.5
		1717.5MHz	21.61	20.82	19.69	22.5	21.5	20.5
	36RB_0	1772.5MHz	21.71	20.73	19.81	22.5	21.5	20.5
		1745MHz	21.77	20.77	19.83	22.5	21.5	20.5
		1717.5MHz	21.71	20.81	19.82	22.5	21.5	20.5
	75RB_0	1772.5MHz	21.69	20.80	19.78	22.5	21.5	20.5
		1745MHz	21.66	20.82	19.80	22.5	21.5	20.5
		1717.5MHz	21.69	20.79	19.75	22.5	21.5	20.5



Full Power								
LTE Band 66			Actual output Power (dBm)			Tune up		
Band -width	RB No. / RB offset	Frequency	Modulation			Modulation		
			QPSK	16QAM	64QAM	QPSK	16QAM	64QAM
20 MHz	1RB_99	1770MHz	22.50	22.18	20.65	23.5	22.5	21.5
		1745MHz	22.55	22.22	20.88	23.5	22.5	21.5
		1720MHz	22.53	22.28	20.83	23.5	22.5	21.5
	1RB_50	1770MHz	22.53	22.20	20.70	23.5	22.5	21.5
		1745MHz	22.55	22.30	21.00	23.5	22.5	21.5
		1720MHz	22.51	22.23	20.81	23.5	22.5	21.5
	1RB_0	1770MHz	22.67	22.36	20.81	23.5	22.5	21.5
		1745MHz	22.61	22.32	20.98	23.5	22.5	21.5
		1720MHz	22.68	22.31	20.79	23.5	22.5	21.5
	50RB_50	1770MHz	21.70	20.85	19.81	22.5	21.5	20.5
		1745MHz	21.70	20.78	19.83	22.5	21.5	20.5
		1720MHz	21.68	20.75	19.76	22.5	21.5	20.5
	50RB_25	1770MHz	21.72	20.86	19.81	22.5	21.5	20.5
		1745MHz	21.73	20.81	19.88	22.5	21.5	20.5
		1720MHz	21.65	20.72	19.94	22.5	21.5	20.5
	50RB_0	1770MHz	21.71	20.79	19.92	22.5	21.5	20.5
		1745MHz	21.72	20.81	19.84	22.5	21.5	20.5
		1720MHz	21.68	20.72	19.81	22.5	21.5	20.5
	100RB_0	1770MHz	21.69	20.88	19.84	22.5	21.5	20.5
		1745MHz	21.70	20.81	19.84	22.5	21.5	20.5
		1720MHz	21.60	20.80	19.70	22.5	21.5	20.5



Sensor on								
LTE Band 66			Actual output Power (dBm)			Tune up		
Band -width	RB No. / RB offset	Frequency	Modulation			Modulation		
			QPSK	16QAM	64QAM	QPSK	16QAM	64QAM
1.4 MHz	1RB_5	1779.3MHz	12.24	11.66	10.45	13.5	12.5	11.5
		1745MHz	12.22	11.35	10.42	13.5	12.5	11.5
		1710.7MHz	12.29	11.37	10.57	13.5	12.5	11.5
	1RB_3	1779.3MHz	12.41	11.81	10.63	13.5	12.5	11.5
		1745MHz	12.43	11.60	10.64	13.5	12.5	11.5
		1710.7MHz	12.52	11.54	10.78	13.5	12.5	11.5
	1RB_0	1779.3MHz	12.20	11.63	10.42	13.5	12.5	11.5
		1745MHz	12.22	11.38	10.43	13.5	12.5	11.5
		1710.7MHz	12.36	11.36	10.61	13.5	12.5	11.5
	3RB_3	1779.3MHz	12.36	11.47	10.50	13.5	12.5	11.5
		1745MHz	12.36	11.14	10.57	13.5	12.5	11.5
		1710.7MHz	12.45	11.46	10.61	13.5	12.5	11.5
	3RB_1	1779.3MHz	12.40	11.51	10.56	13.5	12.5	11.5
		1745MHz	12.43	11.21	10.64	13.5	12.5	11.5
		1710.7MHz	12.55	11.56	10.73	13.5	12.5	11.5
	3RB_0	1779.3MHz	12.34	11.44	10.49	13.5	12.5	11.5
		1745MHz	12.36	11.14	10.58	13.5	12.5	11.5
		1710.7MHz	12.49	11.50	10.66	13.5	12.5	11.5
	6RB_0	1779.3MHz	11.44	10.43	9.28	12.5	11.5	10.5
		1745MHz	11.14	10.49	9.31	12.5	11.5	10.5
		1710.7MHz	11.43	10.63	9.41	12.5	11.5	10.5



Sensor on								
LTE Band 66			Actual output Power (dBm)			Tune up		
Band -width	RB No. / RB offset	Frequency	Modulation			Modulation		
			QPSK	16QAM	64QAM	QPSK	16QAM	64QAM
3 MHz	1RB_14	1778.5MHz	12.30	11.43	10.43	13.5	12.5	11.5
		1745MHz	11.97	11.43	10.49	13.5	12.5	11.5
		1711.5MHz	12.28	11.28	10.54	13.5	12.5	11.5
	1RB_7	1778.5MHz	12.46	11.61	10.60	13.5	12.5	11.5
		1745MHz	12.16	11.64	10.67	13.5	12.5	11.5
		1711.5MHz	12.55	11.54	10.77	13.5	12.5	11.5
	1RB_0	1778.5MHz	12.33	11.46	10.48	13.5	12.5	11.5
		1745MHz	11.95	11.45	10.48	13.5	12.5	11.5
		1711.5MHz	12.43	11.42	10.66	13.5	12.5	11.5
	8RB_7	1778.5MHz	11.48	10.47	9.37	12.5	11.5	10.5
		1745MHz	11.19	10.50	9.41	12.5	11.5	10.5
		1711.5MHz	11.41	10.55	9.43	12.5	11.5	10.5
	8RB_4	1778.5MHz	11.52	10.51	9.41	12.5	11.5	10.5
		1745MHz	11.23	10.55	9.46	12.5	11.5	10.5
		1711.5MHz	11.48	10.63	9.47	12.5	11.5	10.5
	8RB_0	1778.5MHz	11.51	10.49	9.40	12.5	11.5	10.5
		1745MHz	11.20	10.51	9.42	12.5	11.5	10.5
		1711.5MHz	11.48	10.62	9.48	12.5	11.5	10.5
	15RB_0	1778.5MHz	11.49	10.46	9.36	12.5	11.5	10.5
		1745MHz	11.19	10.47	9.36	12.5	11.5	10.5
		1711.5MHz	11.45	10.54	9.40	12.5	11.5	10.5



Sensor on								
LTE Band 66			Actual output Power (dBm)			Tune up		
Band -width	RB No. / RB offset	Frequency	Modulation			Modulation		
			QPSK	16QAM	64QAM	QPSK	16QAM	64QAM
5 MHz	1RB_24	1777.5MHz	11.95	11.42	10.16	13.5	12.5	11.5
		1745MHz	11.94	11.07	10.14	13.5	12.5	11.5
		1712.5MHz	11.90	10.96	10.08	13.5	12.5	11.5
	1RB_12	1777.5MHz	12.49	11.94	10.69	13.5	12.5	11.5
		1745MHz	12.49	11.61	10.69	13.5	12.5	11.5
		1712.5MHz	12.48	11.52	10.67	13.5	12.5	11.5
	1RB_0	1777.5MHz	12.14	11.60	10.37	13.5	12.5	11.5
		1745MHz	11.95	11.08	10.16	13.5	12.5	11.5
		1712.5MHz	12.10	11.14	10.32	13.5	12.5	11.5
	12RB_13	1777.5MHz	11.39	10.34	9.27	12.5	11.5	10.5
		1745MHz	11.11	10.37	9.30	12.5	11.5	10.5
		1712.5MHz	11.24	10.32	9.23	12.5	11.5	10.5
	12RB_6	1777.5MHz	11.60	10.55	9.48	12.5	11.5	10.5
		1745MHz	11.27	10.52	9.46	12.5	11.5	10.5
		1712.5MHz	11.46	10.53	9.45	12.5	11.5	10.5
	12RB_0	1777.5MHz	11.54	10.49	9.42	12.5	11.5	10.5
		1745MHz	11.13	10.38	9.32	12.5	11.5	10.5
		1712.5MHz	11.38	10.46	9.37	12.5	11.5	10.5
	25RB_0	1777.5MHz	11.46	10.41	9.31	12.5	11.5	10.5
		1745MHz	11.12	10.38	9.27	12.5	11.5	10.5
		1712.5MHz	11.31	10.40	9.26	12.5	11.5	10.5



Sensor on								
LTE Band 66			Actual output Power (dBm)			Tune up		
Band -width	RB No. / RB offset	Frequency	Modulation			Modulation		
			QPSK	16QAM	64QAM	QPSK	16QAM	64QAM
10 MHz	1RB_49	1715MHz	12.68	12.14	10.92	13.5	12.5	11.5
		1715MHz	12.67	11.79	10.89	13.5	12.5	11.5
		1715MHz	12.57	11.69	10.81	13.5	12.5	11.5
	1RB_24	1715MHz	12.61	12.03	10.84	13.5	12.5	11.5
		1715MHz	12.40	11.52	10.60	13.5	12.5	11.5
		1715MHz	12.20	11.35	10.41	13.5	12.5	11.5
	1RB_0	1715MHz	12.58	11.99	10.83	13.5	12.5	11.5
		1715MHz	12.18	11.31	10.40	13.5	12.5	11.5
		1715MHz	12.20	11.36	10.41	13.5	12.5	11.5
	25RB_25	1715MHz	11.81	10.76	9.65	12.5	11.5	10.5
		1715MHz	11.45	10.69	9.59	12.5	11.5	10.5
		1715MHz	11.60	10.53	9.42	12.5	11.5	10.5
	25RB_12	1715MHz	11.80	10.74	9.65	12.5	11.5	10.5
		1715MHz	11.28	10.53	9.44	12.5	11.5	10.5
		1715MHz	11.41	10.33	9.25	12.5	11.5	10.5
	25RB_0	1715MHz	11.84	10.79	9.70	12.5	11.5	10.5
		1715MHz	11.20	10.45	9.35	12.5	11.5	10.5
		1715MHz	11.39	10.33	9.23	12.5	11.5	10.5
	50RB_0	1715MHz	11.84	10.78	9.67	12.5	11.5	10.5
		1715MHz	11.33	10.57	9.47	12.5	11.5	10.5
		1715MHz	11.49	10.44	9.32	12.5	11.5	10.5



Sensor on								
LTE Band 66			Actual output Power (dBm)			Tune up		
Band -width	RB No. / RB offset	Frequency	Modulation			Modulation		
			QPSK	16QAM	64QAM	QPSK	16QAM	64QAM
15 MHz	1RB_74	1772.5MHz	11.95	11.05	10.15	13.5	12.5	11.5
		1745MHz	11.89	11.34	10.48	13.5	12.5	11.5
		1717.5MHz	12.24	11.63	10.44	13.5	12.5	11.5
	1RB_37	1772.5MHz	12.36	11.58	10.63	13.5	12.5	11.5
		1745MHz	12.07	11.53	10.66	13.5	12.5	11.5
		1717.5MHz	12.21	11.62	10.47	13.5	12.5	11.5
	1RB_0	1772.5MHz	12.27	11.38	10.52	13.5	12.5	11.5
		1745MHz	11.99	11.45	10.58	13.5	12.5	11.5
		1717.5MHz	12.36	11.79	10.53	13.5	12.5	11.5
	36RB_38	1772.5MHz	11.01	10.27	9.21	12.5	11.5	10.5
		1745MHz	11.22	10.47	9.39	12.5	11.5	10.5
		1717.5MHz	11.43	10.34	9.27	12.5	11.5	10.5
	36RB_19	1772.5MHz	11.14	10.40	9.34	12.5	11.5	10.5
		1745MHz	11.19	10.44	9.37	12.5	11.5	10.5
		1717.5MHz	11.33	10.26	9.19	12.5	11.5	10.5
	36RB_0	1772.5MHz	11.24	10.49	9.42	12.5	11.5	10.5
		1745MHz	11.25	10.50	9.44	12.5	11.5	10.5
		1717.5MHz	11.43	10.35	9.28	12.5	11.5	10.5
	75RB_0	1772.5MHz	11.13	10.37	9.29	12.5	11.5	10.5
		1745MHz	11.23	10.47	9.39	12.5	11.5	10.5
		1717.5MHz	11.42	10.34	9.25	12.5	11.5	10.5



Sensor on								
LTE Band 66			Actual output Power (dBm)			Tune up		
Band -width	RB No. / RB offset	Frequency	Modulation			Modulation		
			QPSK	16QAM	64QAM	QPSK	16QAM	64QAM
20 MHz	1RB_99	1770MHz	11.73	11.32	10.36	13.5	12.5	11.5
		1745MHz	12.28	11.83	10.89	13.5	12.5	11.5
		1720MHz	12.58	12.06	10.80	13.5	12.5	11.5
	1RB_50	1770MHz	11.93	11.46	10.48	13.5	12.5	11.5
		1745MHz	11.94	11.44	10.83	13.5	12.5	11.5
		1720MHz	12.23	11.68	10.88	13.5	12.5	11.5
	1RB_0	1770MHz	11.96	11.54	10.56	13.5	12.5	11.5
		1745MHz	12.41	11.92	11.00	13.5	12.5	11.5
		1720MHz	12.81	12.18	11.05	13.5	12.5	11.5
	50RB_50	1770MHz	11.13	10.45	9.38	12.5	11.5	10.5
		1745MHz	11.31	10.62	9.56	12.5	11.5	10.5
		1720MHz	11.49	10.63	9.51	12.5	11.5	10.5
	50RB_25	1770MHz	11.17	10.47	9.40	12.5	11.5	10.5
		1745MHz	11.20	10.49	9.44	12.5	11.5	10.5
		1720MHz	11.38	10.51	9.39	12.5	11.5	10.5
	50RB_0	1770MHz	11.25	10.55	9.50	12.5	11.5	10.5
		1745MHz	11.41	10.70	9.66	12.5	11.5	10.5
		1720MHz	11.58	10.67	9.56	12.5	11.5	10.5
	100RB_0	1770MHz	11.18	10.48	9.42	12.5	11.5	10.5
		1745MHz	11.35	10.64	9.58	12.5	11.5	10.5
		1720MHz	11.53	10.62	9.51	12.5	11.5	10.5

10.4. Bluetooth and WLAN Measurement result

Table 10.4: The conducted Power measurement results for Bluetooth

Bluetooth Mode	Tune up	Averaged Power (dBm)		
		Ch.0 (2402MHz)	Ch.39 (2441MHz)	Ch.78 (2480MHz)
GFSK	7.5	5.92	6.79	6.16
EDR2M-4_DQPSK	9.0	7.68	8.52	7.79
EDR3M-8DPSK	9.5	8.04	8.87	8.07
/	/	Ch.0 (2402MHz)	Ch.19 (2440MHz)	Ch.39 (2480MHz)
BLE(1M)	6.5	5.19	5.73	5.66
BLE(2M)	6.5	5.09	5.59	5.52
BLE(Coded=S8)	6.5	5.00	5.46	5.34
BLE(Coded=S2)	6.5	5.13	5.62	5.47

Table 10.5: The conducted Power measurement results for WLAN 2.4G

Full Power				
WLAN 2.4GHz Mode	Tune up	Averaged Power (dBm) Duty Cycle: 100%		
		Ch.1 (2412MHz)	Ch.6 (2437Mhz)	Ch.11 (2462MHz)
802.11b	16.0	15.89	15.65	14.12
802.11g	16.0	15.22	15.17	15.74
802.11n(20MHz)	16.0	15.41	15.36	15.91
/	/	Ch.3 (2422MHz)	Ch.6 (2437Mhz)	Ch.9 (2452MHz)
802.11n(40MHz)	16.0	15.57	14.65	14.11
Sensor on				
WLAN 2.4GHz Mode	Tune up	Averaged Power (dBm) Duty Cycle: 100%		
		Ch.1 (2412MHz)	Ch.6 (2437Mhz)	Ch.11 (2462MHz)
802.11b	12.5	11.32	11.42	12.11
802.11g	12.5	10.88	11.04	11.73
802.11n(20MHz)	12.5	11.03	11.22	11.89
/	/	Ch.3 (2422MHz)	Ch.6 (2437Mhz)	Ch.9 (2452MHz)
802.11n(40MHz)	11.5	10.92	10.62	10.21

Table 10.6: The conducted Power measurement results for WLAN 5G

Full Power								
Averaged Power (dBm) Duty Cycle: 100%								
Mode	802.11a	802.11n -20MHz	802.11ac -20MHz	Mode	802.11n -40MHz	802.11ac -40MHz	Mode	802.11ac -80MHz
Channel	6Mbps	MCS0	MCS0	Channel	MCS0	MCS0	Channel	MCS0
<U-NII-1>								
Tune up	15.5	15.5	15.5	/	14.0	14.0	/	13.0
36(5180MHz)	14.77	14.52	14.39	38(5190MHz)	13.52	13.44	42(5210MHz)	12.52
40(5200MHz)	14.90	14.65	14.58	46(5230MHz)	13.41	13.31	/	/
44(5220MHz)	14.65	14.45	14.35	/	/	/	/	/
48(5240MHz)	14.95	14.66	14.56	/	/	/	/	/
<U-NII-2A>								
Tune up	15.5	15.5	15.5	/	14.0	14.0	/	13.0
52(5260MHz)	14.82	14.53	14.47	54(5270MHz)	13.12	13.05	58(5290MHz)	12.75
56(5280MHz)	14.67	14.46	14.33	62(5310MHz)	13.23	13.11	/	/
60(5300MHz)	14.95	14.65	14.56	/	/	/	/	/
64(5320MHz)	14.88	14.52	14.40	/	/	/	/	/
<U-NII-2C>								
Tune up	16.5	16.5	16.5	/	15.0	15.0	/	14.0
100(5500MHz)	/	/	/	102(5510MHz)	14.16	14.05	106(5530MHz)	13.35
116(5580MHz)	/	/	/	110(5550MHz)	13.95	13.76	122(5610MHz)	13.42
124(5620MHz)	/	/	/	126(5630MHz)	13.96	13.88	138(5690MHz)	13.49
132(5660MHz)	15.53	15.13	15.02	134(5670MHz)	14.27	14.12	/	/
140(5700MHz)	15.79	15.45	15.33	/	/	/	/	/
<U-NII-3>								
Tune up	16.5	16.5	16.5	/	15.0	15.0	/	14.0
149(5745MHz)	15.65	15.40	15.31	151(5755MHz)	14.41	14.32	155(5775MHz)	13.68
157(5785MHz)	15.98	15.56	15.53	159(5795MHz)	14.15	14.03	/	/
165(5825MHz)	16.00	15.71	15.67	/	/	/	/	/

Full Power			
Averaged Power (dBm) Duty Cycle: 100%			
Mode	802.11a	802.11n-20MHz	802.11ac-20MHz
Channel	6Mbps	MCS0	MCS0
<U-NII-2C>			
Tune up	15.5	15.5	15.5
100(5500MHz)	14.09	14.02	14.98
116(5580MHz)	14.23	14.10	14.04
124(5620MHz)	14.45	14.26	14.25



Sensor on								
Averaged Power (dBm) Duty Cycle: 100%								
Mode	802.11a	802.11n -20MHz	802.11ac -20MHz	Mode	802.11n -40MHz	802.11ac -40MHz	Mode	802.11ac -80MHz
Channel	6Mbps	MCS0	MCS0	Channel	MCS0	MCS0	Channel	MCS0
<U-NII-1>								
Tune up	8.0	8.0	8.0	/	6.5	6.5	/	6.5
36(5180MHz)	7.30	7.05	6.92	38(5190MHz)	6.05	5.97	42(5210MHz)	5.98
40(5200MHz)	7.43	7.18	7.11	46(5230MHz)	5.94	5.84	/	/
44(5220MHz)	7.18	6.98	6.88	/	/	/	/	/
48(5240MHz)	7.48	7.19	7.09	/	/	/	/	/
<U-NII-2A>								
Tune up	8.0	8.0	8.0	/	6.5	6.5	/	6.5
52(5260MHz)	7.35	7.06	7.00	54(5270MHz)	5.65	5.58	58(5290MHz)	6.33
56(5280MHz)	7.20	6.99	6.86	62(5310MHz)	5.76	5.64	/	/
60(5300MHz)	7.48	7.18	7.09	/	/	/	/	/
64(5320MHz)	7.41	7.05	6.93	/	/	/	/	/
<U-NII-2C>								
Tune up	9.0	9.0	9.0	/	7.5	7.5	/	7.5
100(5500MHz)	/	/	/	102(5510MHz)	6.69	6.58	106(5530MHz)	5.92
116(5580MHz)	/	/	/	110(5550MHz)	6.48	6.29	122(5610MHz)	6.06
124(5620MHz)	/	/	/	126(5630MHz)	6.49	6.41	138(5690MHz)	7.02
132(5660MHz)	8.06	7.66	7.55	134(5670MHz)	6.80	6.65	/	/
140(5700MHz)	8.32	7.98	7.86	/	/	/	/	/
<U-NII-3>								
Tune up	9.0	9.0	9.0	/	7.5	7.5	/	7.5
149(5745MHz)	8.18	7.93	7.84	151(5755MHz)	6.94	6.85	155(5775MHz)	7.33
157(5785MHz)	8.51	8.09	8.06	159(5795MHz)	6.68	6.56	/	/
165(5825MHz)	8.53	8.24	8.20	/	/	/	/	/

Sensor on			
Averaged Power (dBm) Duty Cycle: 100%			
Mode	802.11a	802.11n-20MHz	802.11ac-20MHz
Channel	6Mbps	MCS0	MCS0
<U-NII-2C>			
Tune up	8.0	8.0	8.0
100(5500MHz)	6.62	6.55	7.51
116(5580MHz)	6.76	6.63	6.57
124(5620MHz)	6.98	6.79	6.78

11. Simultaneous TX SAR Considerations

11.1. Introduction

The following procedures adopted from “FCC SAR Considerations for Cell Phones with Multiple Transmitters” are applicable to handsets with built-in unlicensed transmitters such as 802.11 a/b/g and Bluetooth devices which may simultaneously transmit with the licensed transmitter. For this device, the BT and WLAN can transmit simultaneous with other transmitters.

11.2. Transmit Antenna Separation Distances

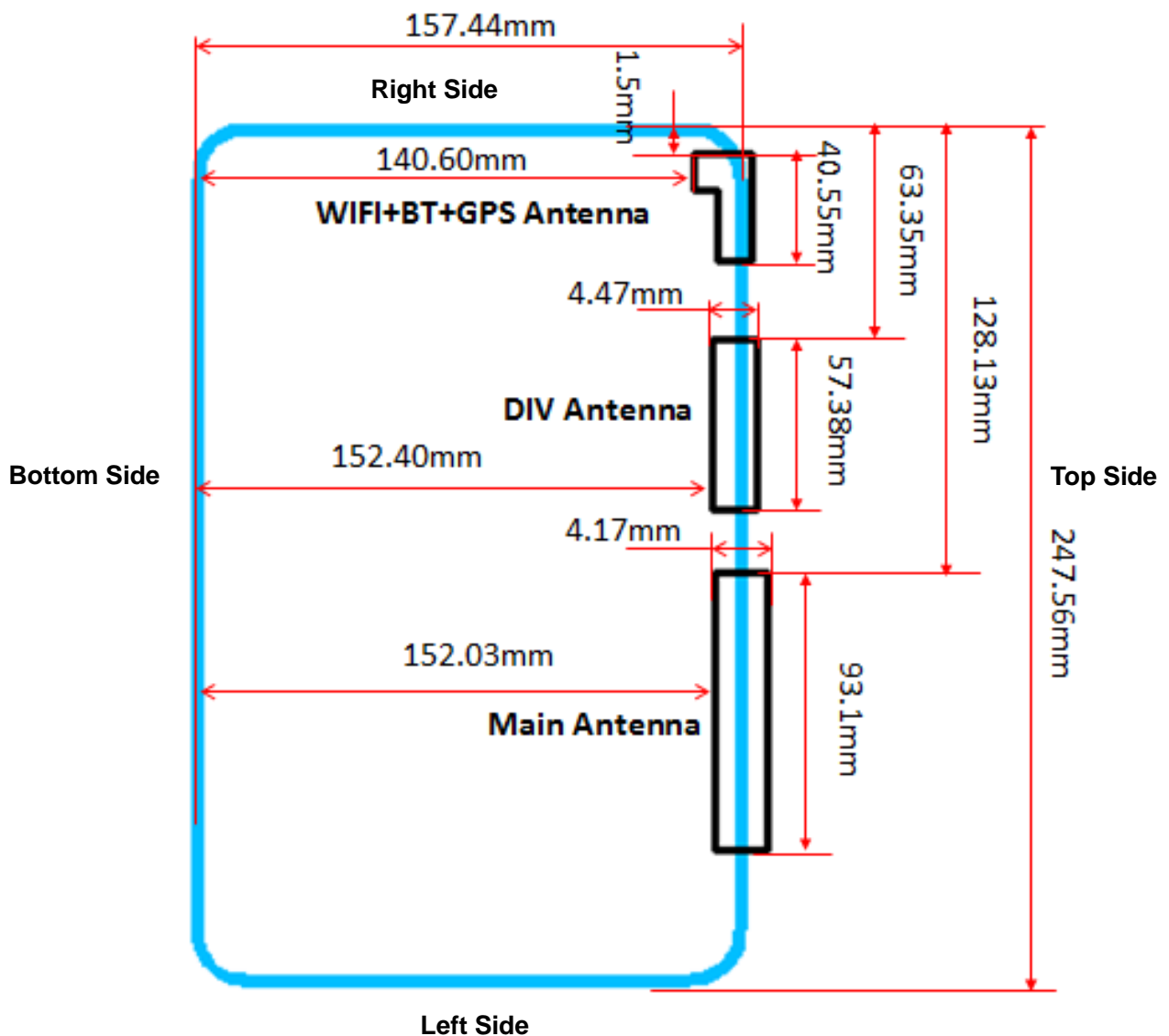

Picture 16: Antenna Locations (Back View)

11.3. SAR Measurement Positions

SAR measurement positions					
Antenna	Rear	Left edge	Right edge	Top edge	Bottom edge
WWAN	Yes	Yes	No	Yes	No
WLAN / BT	Yes	No	Yes	Yes	No

Note:

1. Per KDB 447498 D01v06, the 1-g SAR test exclusion thresholds for 100 MHz to 6 GHz at *test separation distances* ≤ 50 mm are determined by:

$[(\text{max. power of channel, including tune-up tolerance, mW}) / (\text{min. test separation distance, mm})] \cdot [\sqrt{f(\text{GHz})}] \leq 3.0$ for 1-g SAR, where

$f(\text{GHz})$ is the RF channel transmit frequency in GHz

Power and distance are rounded to the nearest mW and mm before calculation

2. Per KDB 447498 D01v06, For 100 MHz to 6 GHz and *test separation distances* > 50 mm, the 1-g and 10-g SAR test exclusion thresholds are determined by the following

1) $\{[\text{Power allowed at numeric threshold for 50 mm in step a}]\} + [(\text{test separation distance} - 50 \text{ mm}) \cdot (f(\text{MHz})/150)]$ mW, for 100 MHz to 1500 MHz

2) $\{[\text{Power allowed at numeric threshold for 50 mm in step a}]\} + [(\text{test separation distance} - 50 \text{ mm}) \cdot 10]$ mW, for > 1500 MHz and ≤ 6 GHz

12. Evaluation of Simultaneous

According to the KDB 447498 D01, when the sum of SAR is larger than the limit, SAR test exclusion is determined by the SAR to peak location separation ratio. The ratio is determined by $(SAR1 + SAR2)^{1.5}/R_i$, rounded to two decimal digits, and must be ≤ 0.04 for all antenna pairs in the configuration to qualify for 1-g SAR test exclusion.

The sum of SAR values for Main Antenna and WLAN

Position	Main Antenna (W/kg)		WLAN 2.4G (W/kg)	Sum (W/kg)	SPLSR
Rear (0mm)	LTE B5	1.01	0.65	1.66	Yes
	LTE B12	1.00	0.65	1.65	Yes
The sum of SAR values for Main Antenna and WLAN					
Position	Main Antenna (W/kg)		WLAN 5G (W/kg)	Sum (W/kg)	SPLSR
Rear (0mm)	GSM850	0.55	1.07	1.62	Yes
	GSM1900	0.75	1.07	1.82	Yes
	WCDMA B2	0.54	1.07	1.61	Yes
	LTE B5	1.01	1.07	2.08	Yes
	LTE B7	0.66	1.07	1.73	Yes
	LTE B12	1.00	1.07	2.07	Yes
	LTE B13	0.58	1.07	1.65	Yes
	LTE B66	0.68	1.07	1.75	Yes
Rear (13mm)	LTE B2	1.09	0.58	1.67	Yes
Top (0mm)	GSM1900	1.34	1.15	2.49	Yes
	WCDMA B2	1.06	1.15	2.21	Yes
	WCDMA B4	0.69	1.15	1.84	Yes
	WCDMA B5	0.50	1.15	1.65	Yes
	LTE B2	1.16	1.15	2.31	Yes
	LTE B5	0.98	1.15	2.13	Yes
	LTE B7	0.71	1.15	1.86	Yes
	LTE B12	0.92	1.15	2.07	Yes
	LTE B13	0.58	1.15	1.73	Yes
	LTE B66	0.79	1.15	1.94	Yes

Band	Position	SAR (W/kg)	Gap (cm)	SAR peak location (m)			3D distance (mm)	Pair SAR sum (W/kg)	SPLSR	Simultaneous SAR
				X	Y	Z				
LTE B5	Rear	1.01	0	-0.0655	-0.0570	-0.171	149.1	1.66	0.014	Not required
WLAN 2.4G		0.65	0	0.0835	-0.0515	-0.172				

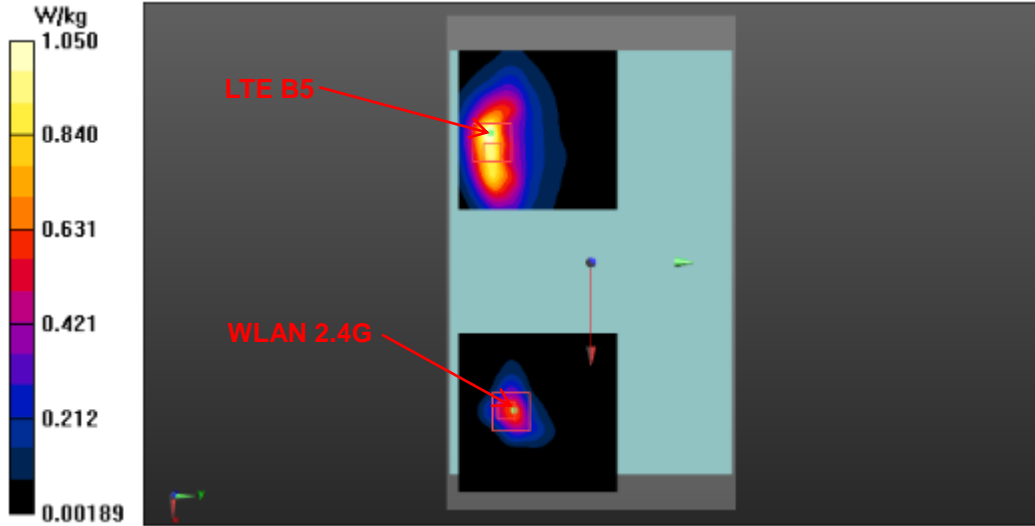

Band	Position	SAR (W/kg)	Gap (cm)	SAR peak location (m)			3D distance (mm)	Pair SAR sum (W/kg)	SPLSR	Simultaneous SAR
				X	Y	Z				
LTE B12	Rear	1.00	0	-0.0575	-0.0475	-0.171	141.1	1.65	0.015	Not required
WLAN 2.4G		0.65	0	0.0835	-0.0515	-0.172				

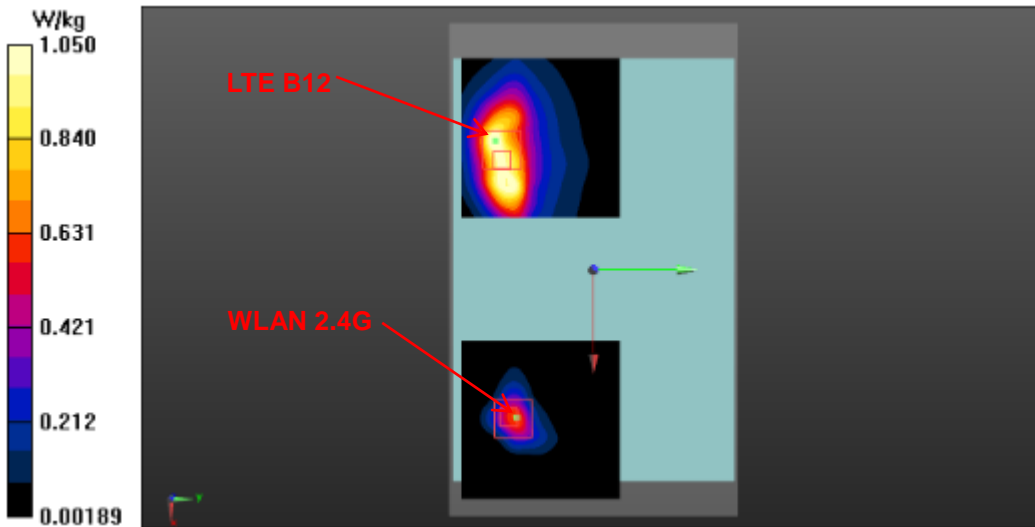

Band	Position	SAR (W/kg)	Gap (cm)	SAR peak location (m)			3D distance (mm)	Pair SAR sum (W/kg)	SPLSR	Simultaneous SAR
				X	Y	Z				
GSM850	Rear	0.55	0	-0.0465	-0.0450	-0.171	123.5	1.62	0.017	Not required
WLAN 5G		1.07	0	0.0768	-0.0516	-0.172				

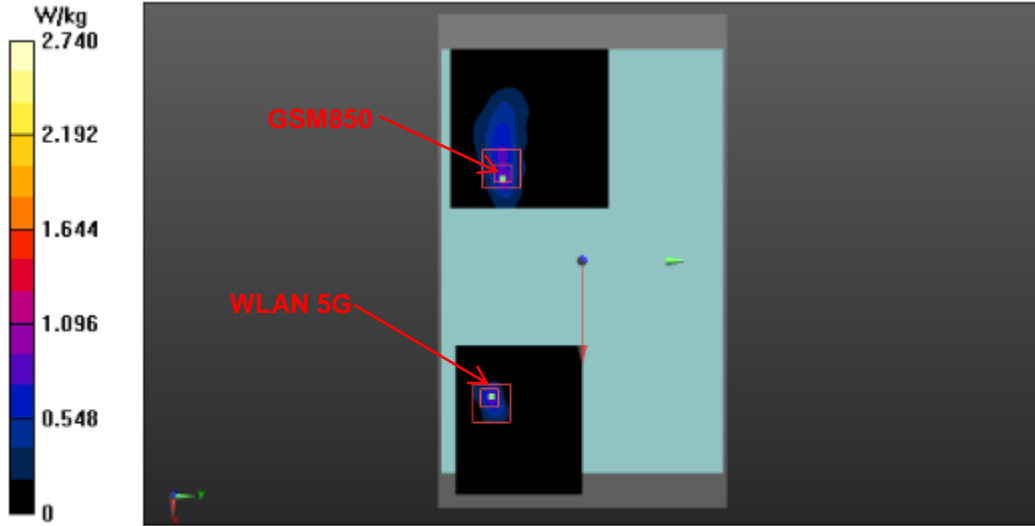

Band	Position	SAR (W/kg)	Gap (cm)	SAR peak location (m)			3D distance (mm)	Pair SAR sum (W/kg)	SPLSR	Simultaneous SAR
				X	Y	Z				
GSM1900	Rear	0.75	0	-0.0885	-0.0450	-0.172	165.4	1.82	0.015	Not required
WLAN 5G		1.07	0	0.0768	-0.0516	-0.172				

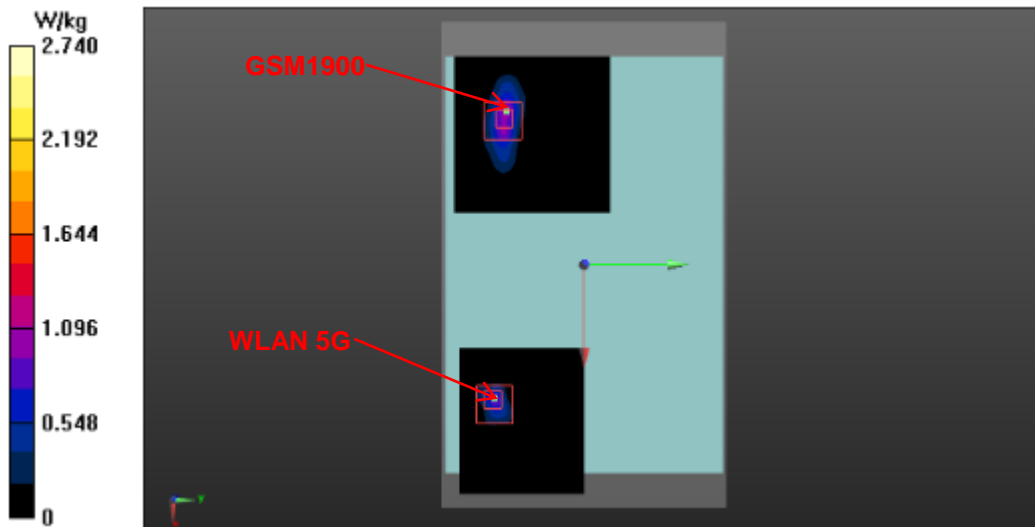

Band	Position	SAR (W/kg)	Gap (cm)	SAR peak location (m)			3D distance (mm)	Pair SAR sum (W/kg)	SPLSR	Simultaneous SAR
				X	Y	Z				
WCDMA B2	Rear	0.54	0	-0.0870	-0.0585	-0.171	163.9	1.61	0.012	Not required
WLAN 5G		1.07	0	0.0768	-0.0516	-0.172				

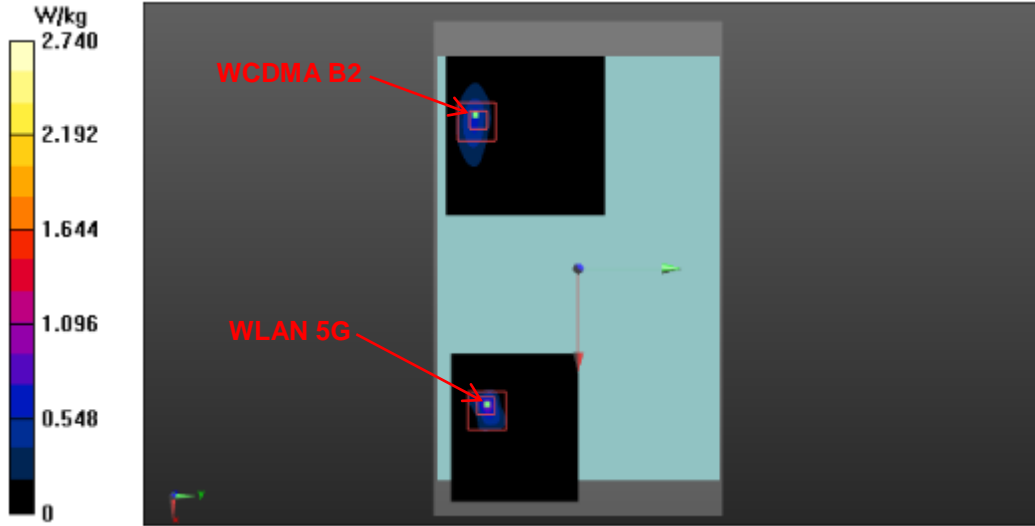

Band	Position	SAR (W/kg)	Gap (cm)	SAR peak location (m)			3D distance (mm)	Pair SAR sum (W/kg)	SPLSR	Simultaneous SAR
				X	Y	Z				
LTE B5	Rear	1.01	0	-0.0655	-0.0570	-0.171	142.4	2.08	0.021	Not required
WLAN 5G		1.07	0	0.0768	-0.0516	-0.172				

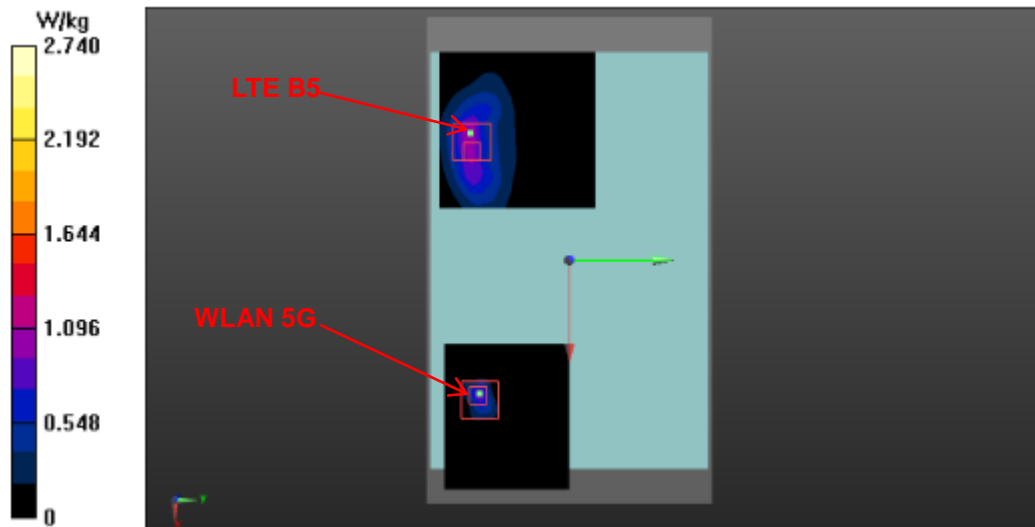

Band	Position	SAR (W/kg)	Gap (cm)	SAR peak location (m)			3D distance (mm)	Pair SAR sum (W/kg)	SPLSR	Simultaneous SAR
				X	Y	Z				
LTE B7	Rear	0.66	0	-0.0885	-0.0540	-0.172	165.3	1.73	0.014	Not required
WLAN 5G		1.07	0	0.0768	-0.0516	-0.172				

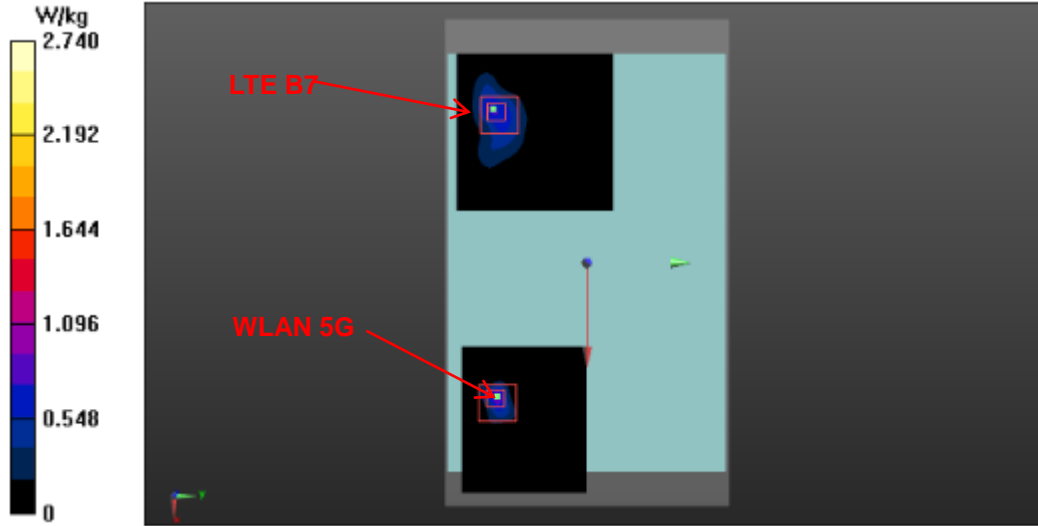

Band	Position	SAR (W/kg)	Gap (cm)	SAR peak location (m)			3D distance (mm)	Pair SAR sum (W/kg)	SPLSR	Simultaneous SAR
				X	Y	Z				
LTE B12	Rear	1.00	0	-0.0575	-0.0475	-0.171	134.4	2.07	0.022	Not required
WLAN 5G		1.07	0	0.0768	-0.0516	-0.172				

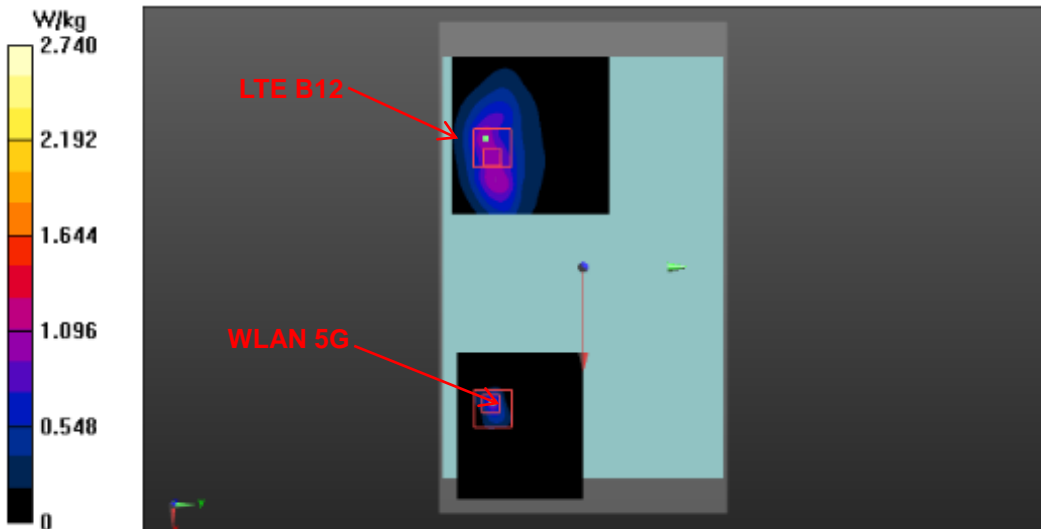

Band	Position	SAR (W/kg)	Gap (cm)	SAR peak location (m)			3D distance (mm)	Pair SAR sum (W/kg)	SPLSR	Simultaneous SAR
				X	Y	Z				
LTE B13	Rear	0.58	0	-0.0575	-0.0490	-0.171	134.3	1.65	0.016	Not required
WLAN 5G		1.07	0	0.0768	-0.0516	-0.172				

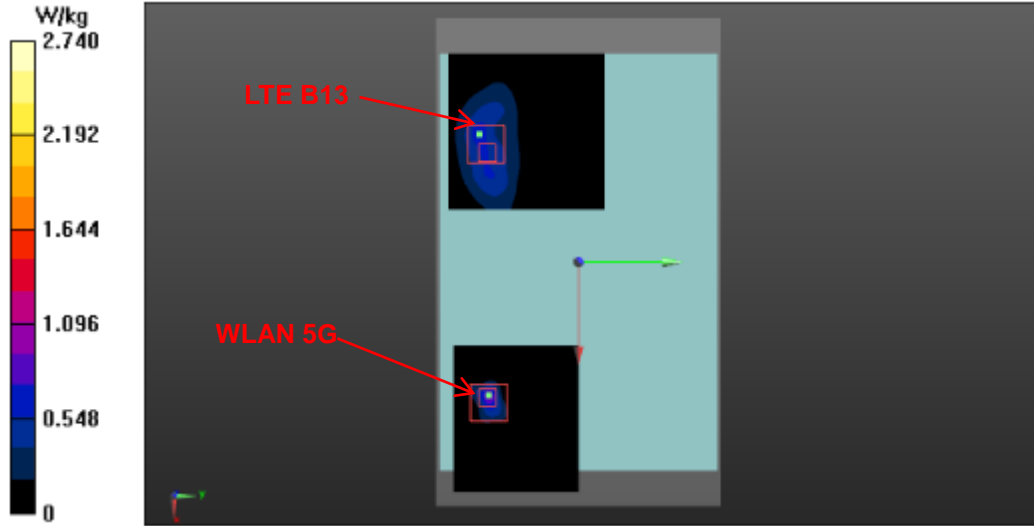

Band	Position	SAR (W/kg)	Gap (cm)	SAR peak location (m)			3D distance (mm)	Pair SAR sum (W/kg)	SPLSR	Simultaneous SAR
				X	Y	Z				
LTE B66	Rear	0.68	0	-0.0885	-0.0545	-0.170	165.3	1.75	0.014	Not required
WLAN 5G		1.07	0	0.0768	-0.0516	-0.172				

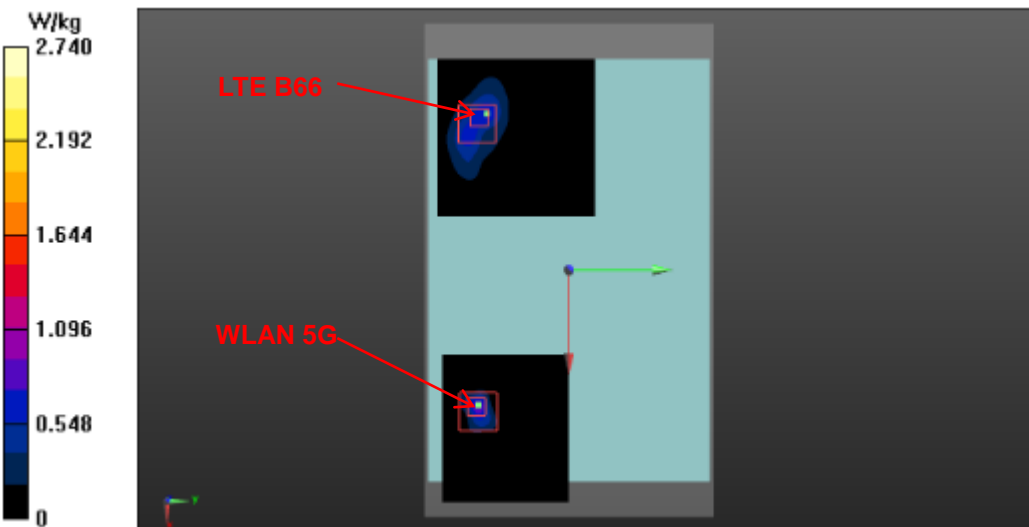

Band	Position	SAR (W/kg)	Gap (cm)	SAR peak location (m)			3D distance (mm)	Pair SAR sum (W/kg)	SPLSR	Simultaneous SAR
				X	Y	Z				
LTE B2	Rear	1.09	13mm	-0.084	-0.057	-0.171	160.8	1.67	0.013	Not required
WLAN 5G		0.58	9mm	0.0768	-0.0576	-0.172				

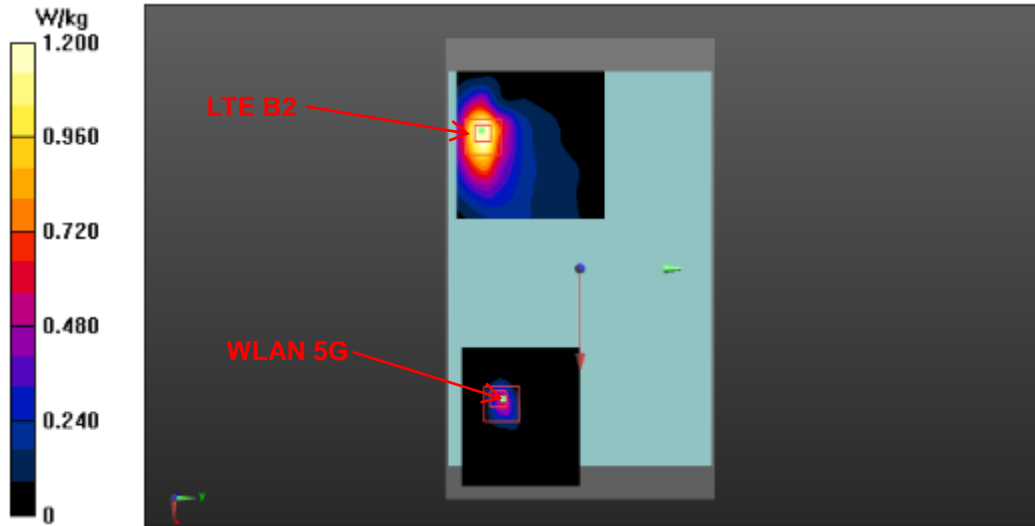

Band	Position	SAR (W/kg)	Gap (cm)	SAR peak location (m)			3D distance (mm)	Pair SAR sum (W/kg)	SPLSR	Simultaneous SAR
				X	Y	Z				
GSM1900	Top	1.34	0	-0.0720	0.0015	-0.171	162.6	2.49	0.024	Not required
WLAN 5G		1.15	0	0.0906	-0.0024	-0.172				

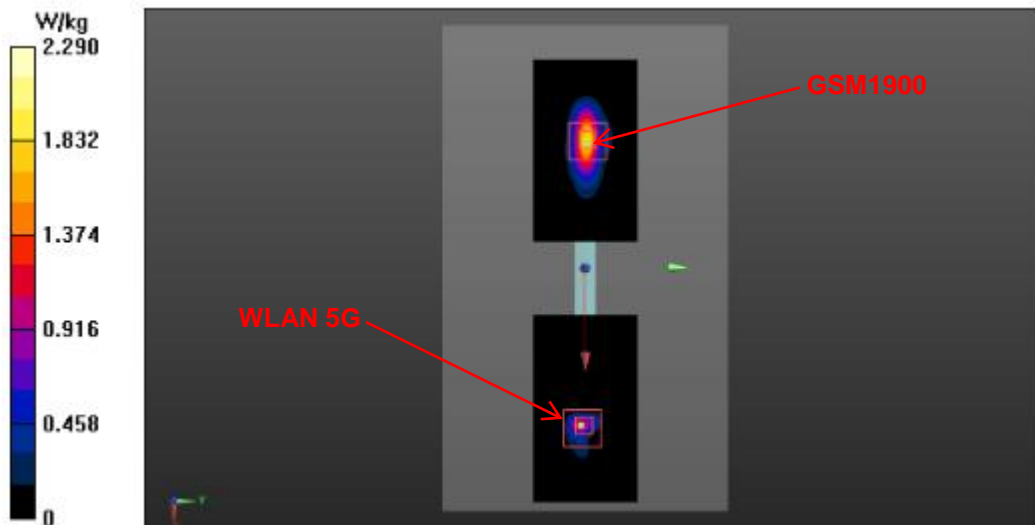

Band	Position	SAR (W/kg)	Gap (cm)	SAR peak location (m)			3D distance (mm)	Pair SAR sum (W/kg)	SPLSR	Simultaneous SAR
				X	Y	Z				
WCDMA B2	Top	1.06	0	-0.0690	0	-0.172	159.6	2.21	0.021	Not required
WLAN 5G		1.15	0	0.0906	-0.0024	-0.172				

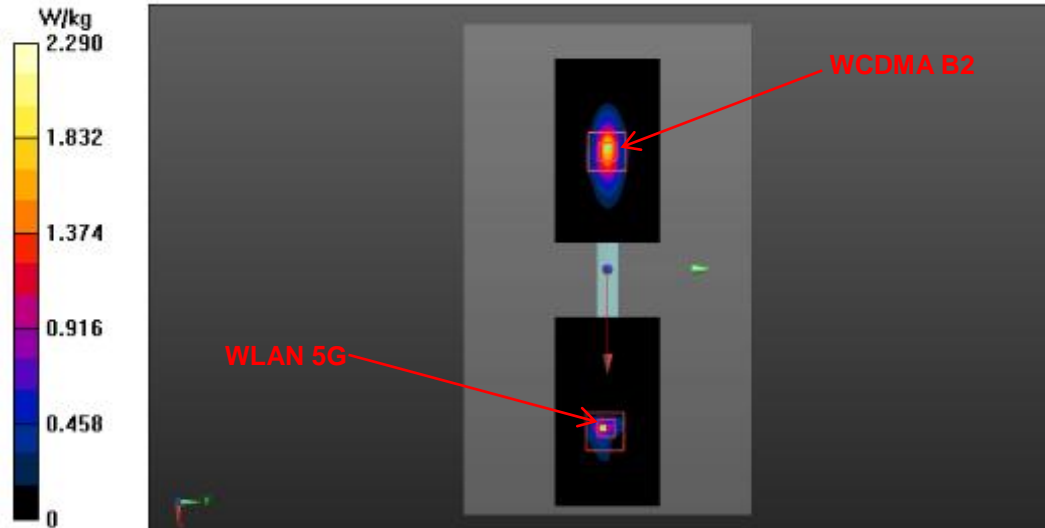

Band	Position	SAR (W/kg)	Gap (cm)	SAR peak location (m)			3D distance (mm)	Pair SAR sum (W/kg)	SPLSR	Simultaneous SAR
				X	Y	Z				
WCDMA B4	Top	0.69	0	-0.0750	-0.0095	-0.171	165.8	1.84	0.015	Not required
WLAN 5G		1.15	0	0.0906	-0.0024	-0.172				

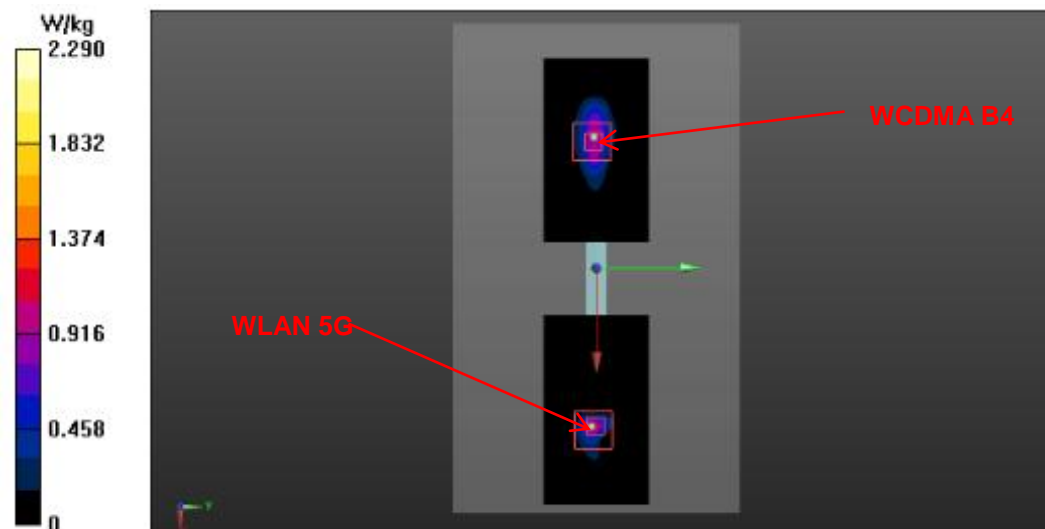

Band	Position	SAR (W/kg)	Gap (cm)	SAR peak location (m)			3D distance (mm)	Pair SAR sum (W/kg)	SPLSR	Simultaneous SAR
				X	Y	Z				
WCDMA B5	Top	0.50	0	-0.0385	0.0015	-0.172	129.2	1.65	0.016	Not required
WLAN 5G		1.15	0	0.0906	-0.0024	-0.172				

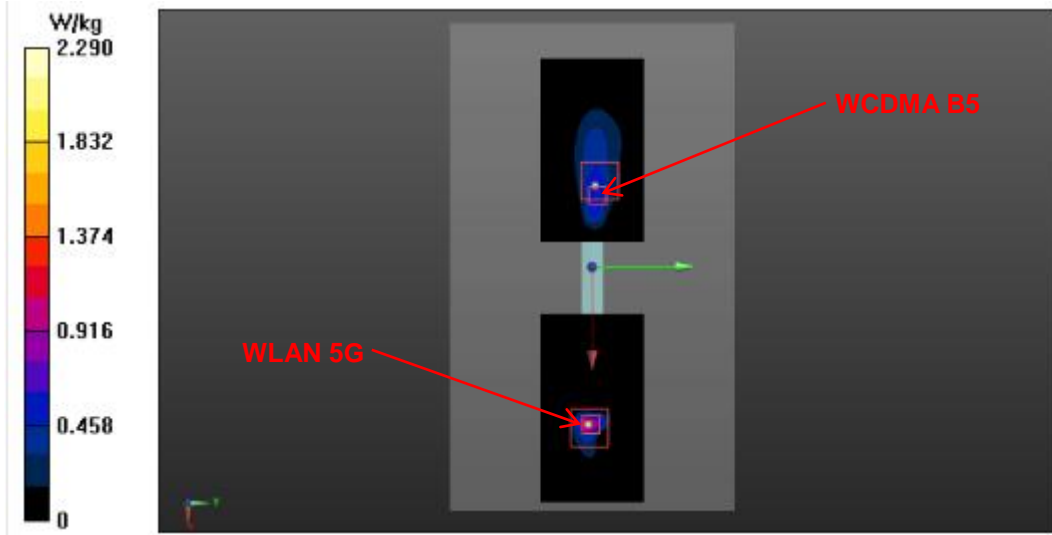

Band	Position	SAR (W/kg)	Gap (cm)	SAR peak location (m)			3D distance (mm)	Pair SAR sum (W/kg)	SPLSR	Simultaneous SAR
				X	Y	Z				
LTE B2	Top	1.16	0	-0.0705	0.0015	-0.171	161.2	2.31	0.022	Not required
WLAN 5G		1.15	0	0.0906	-0.0024	-0.172				

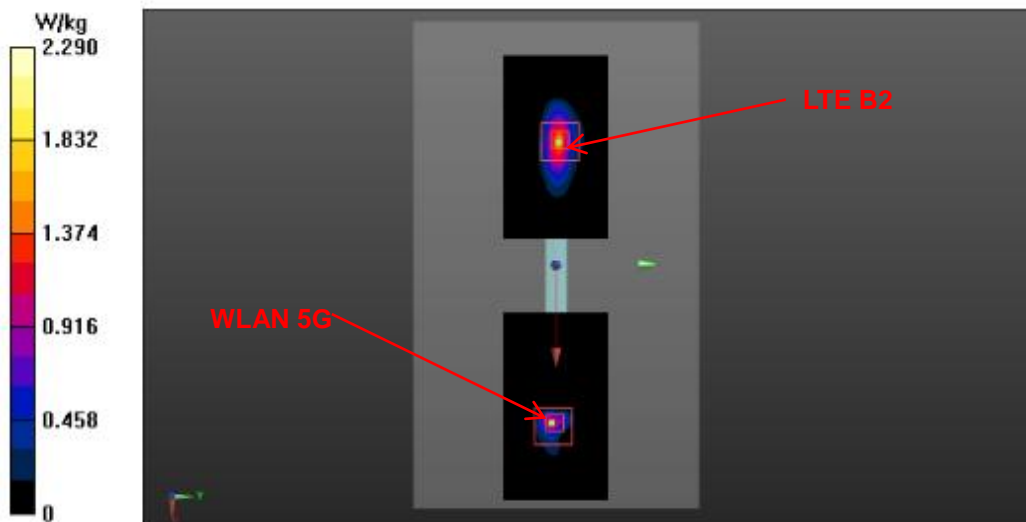

Band	Position	SAR (W/kg)	Gap (cm)	SAR peak location (m)			3D distance (mm)	Pair SAR sum (W/kg)	SPLSR	Simultaneous SAR
				X	Y	Z				
LTE B5	Top	0.98	0	-0.048	0	-0.171	138.6	2.13	0.022	Not required
WLAN 5G		1.15	0	0.0906	-0.0024	-0.172				

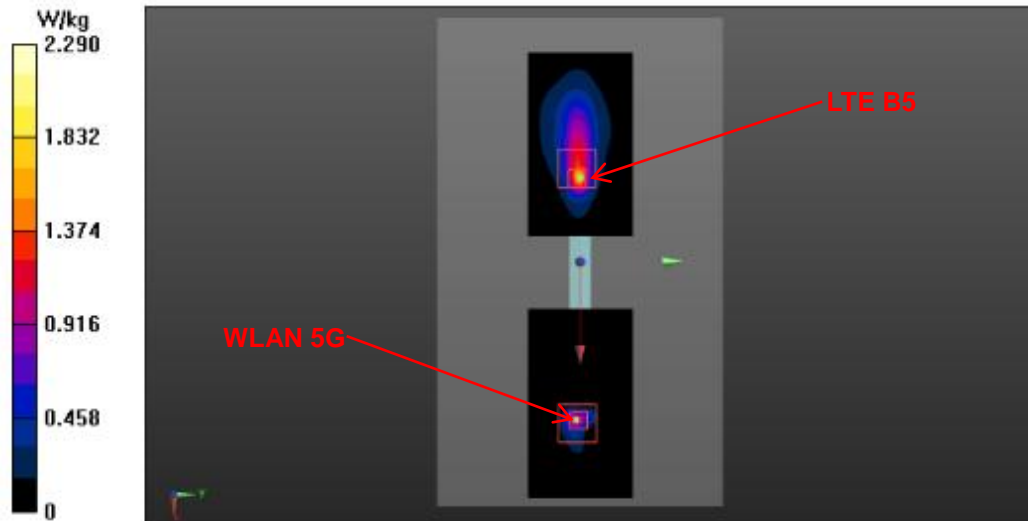

Band	Position	SAR (W/kg)	Gap (cm)	SAR peak location (m)			3D distance (mm)	Pair SAR sum (W/kg)	SPLSR	Simultaneous SAR
				X	Y	Z				
LTE B7	Top	0.71	0	-0.0735	-0.0015	-0.172	164.1	1.86	0.015	Not required
WLAN 5G		1.15	0	0.0906	-0.0024	-0.172				

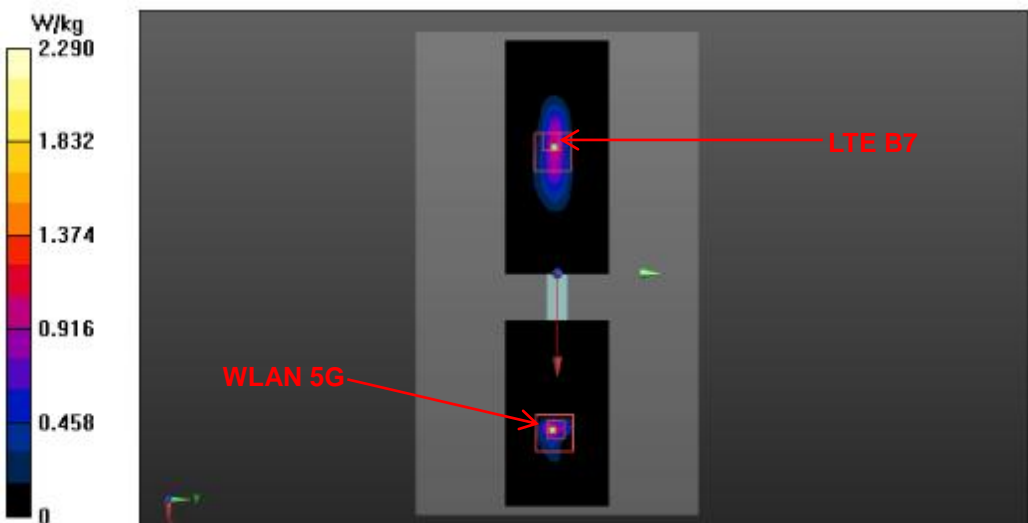

Band	Position	SAR (W/kg)	Gap (cm)	SAR peak location (m)			3D distance (mm)	Pair SAR sum (W/kg)	SPLSR	Simultaneous SAR
				X	Y	Z				
LTE B12	Top	0.92	0	-0.0480	0	-0.171	138.6	2.07	0.021	Not required
WLAN 5G		1.15	0	0.0906	-0.0024	-0.172				

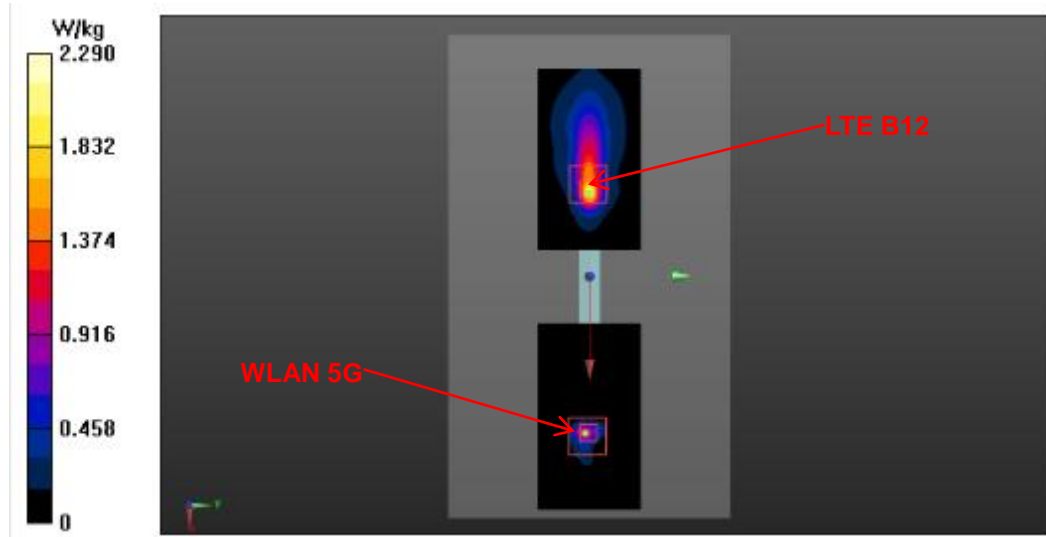

Band	Position	SAR (W/kg)	Gap (cm)	SAR peak location (m)			3D distance (mm)	Pair SAR sum (W/kg)	SPLSR	Simultaneous SAR
				X	Y	Z				
LTE B13	Top	0.58	0	-0.0480	0	-0.171	138.6	1.73	0.016	Not required
WLAN 5G		1.15	0	0.0906	-0.0024	-0.172				

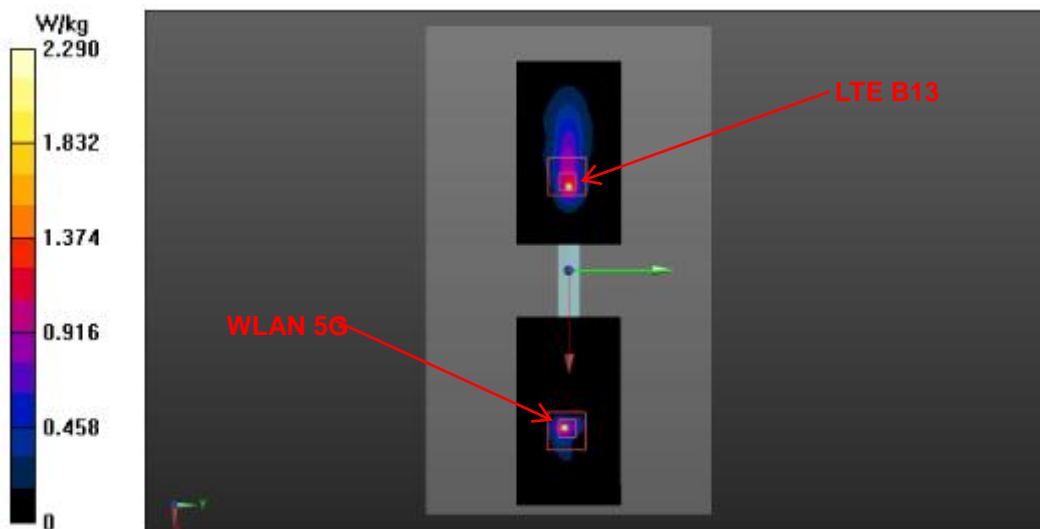

Band	Position	SAR (W/kg)	Gap (cm)	SAR peak location (m)			3D distance (mm)	Pair SAR sum (W/kg)	SPLSR	Simultaneous SAR
				X	Y	Z				
LTE B66	Top	0.79	0	-0.0795	-0.003	-0.171	170.1	1.94	0.016	Not required
WLAN 5G		1.15	0	0.0906	-0.0024	-0.172				

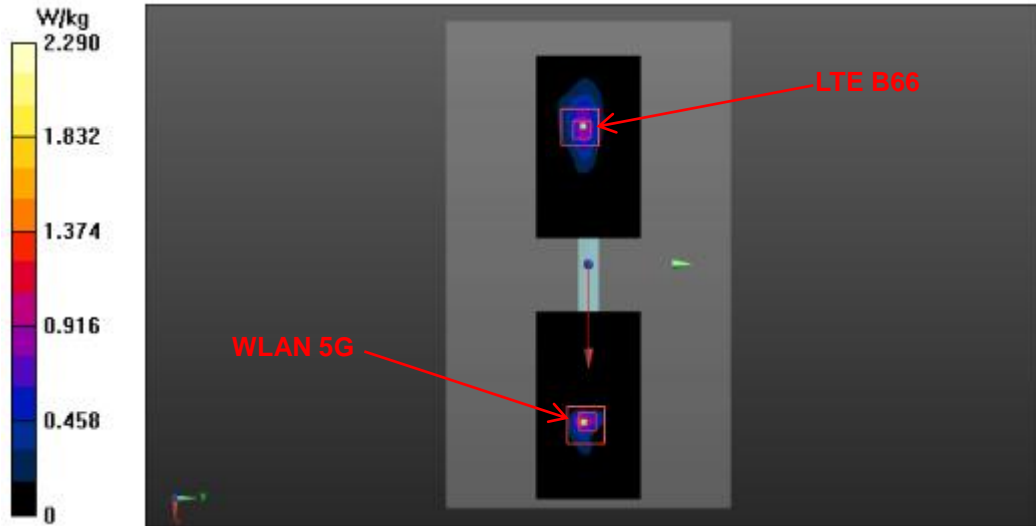

Table 12.1: The sum of reported SAR values for WWAN antenna and WLAN antenna

/	Position	WWAN (W/kg)	WLAN (W/kg)	Sum (W/kg)
Highest reported SAR value for Body	Top	0.42	1.15	1.57

Note: the test positions of above tables are for the worse case that has been evaluated.

Table 12.2: The sum of reported SAR values for WWAN antenna and Bluetooth antenna

/	Position	WWAN (W/kg)	Bluetooth (W/kg)	Sum (W/kg)
Highest reported SAR value for Body	Top	1.34	0.02	1.36

Note: the test positions of above tables are for the worse case that has been evaluated.

Conclusion:

According to the above tables, the sum of reported SAR values is 1.57 W/kg. So the simultaneous transmission SAR with volume scans is not required.

13. Summary of Test Results

According to the client's decision rule in the test registration form, which is "based on the measurement results as the basis of the conformity statement", the test conclusion of this report meets the limit requirements.

The calculated SAR is obtained by the following formula:

$$\text{Reported SAR} = \text{Measured SAR} \times 10^{(P_{\text{Target}} - P_{\text{Measured}})/10}$$

Where P_{Target} is the power of manufacturing upper limit;

P_{Measured} is the measured power in chapter 10.

Duty Cycle

Mode	Duty Cycle
GPRS for GSM850	1:4
GPRS for GSM 1900	1:2.67
GPRS for GSM850/1900 (Sensor-on mode)	1:2
WCDMA Band 2/4/5	1:1
FDD_LTE Band 2/5/7/12/13/66	1:1

13.1. Testing Environment

Temperature:	18°C~25°C
Relative humidity:	30%~70%
Ground system resistance:	<4Ω
Ambient noise & Reflection:	< 0.012 W/kg

13.2. SAR results

Table 13.1: SAR Values (GSM 850 - Body)

Frequency		Test Mode	Test Position	Figure No./ Note	Conducted Power (dBm)	Max. tune-up Power (dBm)	Measured SAR(1g) (W/kg)	Reported SAR(1g) (W/kg)	Power Drift(dB)
Ch.	MHz								
Ambient Temperature: 22.5°C Liquid Temperature: 22.0°C									
0mm Test Data									
251	848.8	GPRS4	Rear	/	18.32	19.0	0.468	0.55	0.05
251	848.8	GPRS4	Top	/	18.32	19.0	0.361	0.42	0.08
128	824.2	GPRS2	Left	/	30.95	31.5	0.334	0.38	-0.12
Sensor off Test Data									
128	824.2	GPRS2	Rear	1/13mm	30.95	31.5	0.475	0.54	0.07
128	824.2	GPRS2	Top	15mm	30.95	31.5	0.351	0.40	0.01

Table 13.2: SAR Values (GSM 1900 - Body)

Frequency		Test Mode	Test Position	Figure No./ Note	Conducted Power (dBm)	Max. tune-up Power (dBm)	Measured SAR(1g) (W/kg)	Reported SAR(1g) (W/kg)	Power Drift(dB)
Ch.	MHz								
Ambient Temperature: 22.8°C Liquid Temperature: 22.3°C									
0mm Test Data									
512	1850.2	GPRS4	Rear	/	15.92	16.5	0.660	0.75	0.02
512	1850.2	GPRS4	Top	2	15.92	16.5	1.110	1.27	0.06
512	1850.2	GPRS3	Left	/	26.66	27.0	0.100	0.11	-0.16
810	1909.8	GPRS4	Top	/	15.44	16.5	1.050	1.34	0.07
661	1880.0	GPRS4	Top	/	15.64	16.5	1.100	1.34	0.05
Sensor off Test Data									
512	1850.2	GPRS3	Rear	13mm	26.66	27.0	0.408	0.44	0.02
512	1850.2	GPRS3	Top	15mm	26.66	27.0	0.371	0.40	-0.14

Table 13.3: SAR Values (WCDMA Band 2 - Body)

Frequency		Test Mode	Test Position	Figure No./ Note	Conducted Power (dBm)	Max. tune-up Power (dBm)	Measured SAR(1g) (W/kg)	Reported SAR(1g) (W/kg)	Power Drift(dB)
Ch.	MHz								
Ambient Temperature: 22.8°C Liquid Temperature: 22.3°C									
0mm Test Data									
9400	1880.0	RMC	Rear	/	11.60	12.0	0.488	0.54	0.06
9400	1880.0	RMC	Top	/	11.60	12.0	0.882	0.97	0.09
9400	1880.0	RMC	Left	/	21.20	22.0	0.075	0.09	0.00
9538	1907.6	RMC	Top	3	11.50	12.0	0.946	1.06	0.01
9262	1852.4	RMC	Top	/	11.60	12.0	0.888	0.97	0.08
Sensor off Test Data									
9400	1880.0	RMC	Rear	13mm	21.20	22.0	0.579	0.70	0.03
9400	1880.0	RMC	Top	15mm	21.20	22.0	0.570	0.69	-0.06

Table 13.4: SAR Values (WCDMA Band 4 - Body)

Frequency		Test Mode	Test Position	Figure No./ Note	Conducted Power (dBm)	Max. tune-up Power (dBm)	Measured SAR(1g) (W/kg)	Reported SAR(1g) (W/kg)	Power Drift(dB)
Ch.	MHz								
Ambient Temperature: 22.3°C Liquid Temperature: 21.8°C									
0mm Test Data									
1413	1732.6	RMC	Rear	/	11.50	12.0	0.385	0.43	0.08
1413	1732.6	RMC	Top	4	11.50	12.0	0.616	0.69	0.09
1413	1732.6	RMC	Left	/	21.50	22.0	0.180	0.20	-0.03
Sensor off Test Data									
1413	1732.6	RMC	Rear	13mm	21.50	22.0	0.425	0.48	0.07
1413	1732.6	RMC	Top	15mm	21.50	22.0	0.339	0.38	0.04

Table 13.5: SAR Values (WCDMA Band 5 -Body)

Frequency		Test Mode	Test Position	Figure No./ Note	Conducted Power (dBm)	Max. tune-up Power (dBm)	Measured SAR(1g) (W/kg)	Reported SAR(1g) (W/kg)	Power Drift(dB)
Ch.	MHz								
Ambient Temperature: 22.5°C Liquid Temperature: 22.0°C									
0mm Test Data									
4182	836.4	RMC	Rear	/	17.50	18.0	0.434	0.49	0.07
4182	836.4	RMC	Top	5	17.50	18.0	0.444	0.50	0.08
4182	836.4	RMC	Left	/	22.30	23.0	0.268	0.31	-0.15
Sensor off Test Data									
4182	836.4	RMC	Rear	13mm	22.30	23.0	0.389	0.46	0.12
4182	836.4	RMC	Top	15mm	22.30	23.0	0.250	0.29	-0.16

Table 13.6: SAR Values (LTE Band 2 - Body)

Frequency		Test Mode	Test Position	Figure No./ Note	Ambient Temperature: 22.8°C		Liquid Temperature: 22.3°C		
Ch.	MHz				Conducted Power (dBm)	Max. tune-up Power (dBm)	Measured SAR(1g) (W/kg)	Reported SAR(1g) (W/kg)	Power Drift(dB)
0mm Test Data									
18700	1860.0	1RB0	Rear	/	11.10	11.5	0.447	0.49	0.09
18700	1860.0	50RB0	Rear	/	9.97	10.5	0.359	0.41	0.09
18700	1860.0	1RB0	Top	/	11.10	11.5	0.762	0.84	0.07
18700	1860.0	50RB0	Top	/	9.97	10.5	0.577	0.65	0.04
18900	1880.0	1RB99	Left	/	22.44	23.0	0.085	0.10	0.06
19100	1900.0	50RB0	Left	/	21.45	22.0	0.061	0.07	0.09
19100	1900.0	1RB0	Top	/	10.52	11.5	0.929	1.16	0.07
18900	1880.0	1RB0	Top	/	10.78	11.5	0.903	1.07	0.03
18700	1860.0	100RB	Top	/	9.81	10.5	0.714	0.84	0.04
Sensor off Test Data									
18900	1880.0	1RB99	Rear	13mm	22.44	23.0	0.865	0.98	0.04
19100	1900.0	50RB0	Rear	13mm	21.45	22.0	0.753	0.85	0.11
18900	1880.0	1RB99	Top	15mm	22.44	23.0	0.897	1.02	-0.06
19100	1900.0	50RB0	Top	15mm	21.45	22.0	0.773	0.88	0.08
19100	1900.0	1RB50	Rear	13mm	22.39	23.0	0.946	1.09	0.07
18700	1860.0	1RB0	Rear	13mm	22.42	23.0	0.543	0.62	0.08
18900	1880.0	50RB50	Rear	13mm	21.43	22.0	0.635	0.72	0.16
18700	1860.0	50RB25	Rear	13mm	21.42	22.0	0.472	0.54	0.07
19100	1900.0	1RB50	Top	6/15mm	22.39	23.0	0.981	1.13	0.04
18700	1860.0	1RB0	Top	15mm	22.42	23.0	0.563	0.64	-0.08
18900	1880.0	50RB50	Top	15mm	21.43	22.0	0.658	0.75	-0.10
18700	1860.0	50RB25	Top	15mm	21.42	22.0	0.489	0.56	-0.07
18900	1880.0	100RB0	Top	15mm	21.48	22.0	0.620	0.70	-0.08

Table 13.7: SAR Values (LTE Band 5 - Body)

Frequency		Test Mode	Test Position	Figure No./ Note	Conducted Power (dBm)	Max. tune-up Power (dBm)	Measured SAR(1g) (W/kg)	Reported SAR(1g) (W/kg)	Power Drift(dB)
Ch.	MHz								
Ambient Temperature: 22.5°C Liquid Temperature: 22.0°C									
0mm Test Data									
20600	844.0	1RB0	Rear	/	18.97	19.5	0.760	0.86	0.04
20600	844.0	25RB0	Rear	/	17.99	18.5	0.764	0.86	0.04
20600	844.0	1RB0	Top	/	18.97	19.5	0.783	0.88	0.03
20600	844.0	25RB0	Top	/	17.99	18.5	0.711	0.80	-0.05
20600	844.0	1RB49	Left	/	23.89	24.5	0.188	0.22	0.02
20525	836.5	25RB25	Left	/	23.02	23.5	0.141	0.16	0.03
20525	836.5	1RB49	Rear	7	18.46	19.5	0.794	1.01	0.19
20450	829.0	1RB49	Rear	/	18.29	19.5	0.533	0.70	0.03
20525	836.5	25RB25	Rear	/	17.43	18.5	0.505	0.65	0.07
20450	829.0	25RB0	Rear	/	17.37	18.5	0.736	0.95	0.01
20525	836.5	1RB49	Top	/	18.46	19.5	0.774	0.98	0.05
20450	829.0	1RB49	Top	/	18.29	19.5	0.473	0.62	-0.05
20525	836.5	25RB25	Top	/	17.43	18.5	0.525	0.67	-0.17
20450	829.0	25RB0	Top	/	17.37	18.5	0.599	0.78	-0.07
20450	829.0	50RB0	Top	/	17.39	18.5	0.451	0.58	0.07
Sensor off Test Data									
20600	844.0	1RB49	Rear	13mm	23.89	24.5	0.488	0.56	-0.18
20525	836.5	25RB25	Rear	13mm	23.02	23.5	0.375	0.42	0.10
20600	844.0	1RB49	Top	15mm	23.89	24.5	0.350	0.40	-0.13
20525	836.5	25RB25	Top	15mm	23.02	23.5	0.291	0.33	0.01



Table 13.8: SAR Values (LTE Band 7 - Body)

Frequency		Test Mode	Test Position	Figure No./ Note	Conducted Power (dBm)	Max. tune-up Power (dBm)	Measured SAR(1g) (W/kg)	Reported SAR(1g) (W/kg)	Power Drift(dB)
Ch.	MHz								
Ambient Temperature: 22.6°C Liquid Temperature: 22.1°C									
0mm Test Data									
21350	2560.0	1RB0	Rear	/	12.22	12.5	0.619	0.66	0.06
21350	2560.0	50RB0	Rear	/	11.46	11.5	0.399	0.40	0.04
21350	2560.0	1RB0	Top	/	12.22	12.5	0.668	0.71	0.06
21350	2560.0	50RB0	Top	/	11.46	11.5	0.490	0.49	0.01
21100	2535.0	1RB99	Left	/	21.33	22.0	0.020	0.02	0.10
21100	2535.0	50RB50	Left	/	20.28	21.0	0.015	0.02	0.02
Sensor off Test Data									
21100	2535.0	1RB99	Rear	13mm	21.33	22.0	0.770	0.90	0.05
21100	2535.0	50RB50	Rear	13mm	20.28	21.0	0.638	0.75	0.02
21100	2535.0	1RB99	Top	8/15mm	21.33	22.0	0.935	1.09	0.03
21100	2535.0	50RB50	Top	15mm	20.28	21.0	0.806	0.95	0.01
21350	2560.0	1RB99	Rear	13mm	21.31	22.0	0.752	0.88	-0.11
20850	2510.0	1RB99	Rear	13mm	21.23	22.0	0.737	0.88	0.05
21350	2560.0	1RB99	Top	15mm	21.31	22.0	0.913	1.07	0.10
20850	2510.0	1RB99	Top	15mm	21.23	22.0	0.895	1.07	0.03
21350	2560.0	1RB99	Top	15mm	20.26	21.0	0.731	0.87	-0.07
20850	2510.0	1RB99	Top	15mm	20.17	21.0	0.728	0.88	-0.13
20850	2510.0	100RB	Top	15mm	20.23	21.0	0.701	0.84	-0.03

Table 13.9: SAR Values (LTE Band 12 - Body)

Frequency		Test Mode	Test Position	Figure No./ Note	Conducted Power (dBm)	Max. tune-up Power (dBm)	Measured SAR(1g) (W/kg)	Reported SAR(1g) (W/kg)	Power Drift(dB)
Ch.	MHz								
Ambient Temperature: 22.5°C Liquid Temperature: 22.0°C									
0mm Test Data									
23130	711.0	1RB24	Rear	9	19.21	19.5	0.935	1.00	0.03
23130	711.0	25RB0	Rear	/	18.20	18.5	0.648	0.69	0.04
23130	711.0	1RB24	Top	/	19.21	19.5	0.856	0.92	0.01
23130	711.0	25RB0	Top	/	18.20	18.5	0.676	0.72	0.02
23060	704.0	1RB49	Left	/	24.19	24.5	0.183	0.20	0.08
23060	704.0	25RB25	Left	/	23.44	23.5	0.145	0.15	0.10
23095	707.5	1RB49	Rear	/	18.98	19.5	0.809	0.91	0.03
23060	704.0	1RB49	Rear	/	19.18	19.5	0.800	0.86	0.05
23130	711.0	50RB0	Rear	/	18.03	18.5	0.584	0.65	0.04
23095	707.5	1RB49	Top	/	18.98	19.5	0.804	0.91	0.03
23060	704.0	1RB49	Top	/	19.18	19.5	0.859	0.92	0.16
Sensor off Test Data									
23060	704.0	1RB49	Rear	13mm	24.19	24.5	0.288	0.31	0.04
23060	704.0	25RB25	Rear	13mm	23.44	23.5	0.230	0.23	0.19
23060	704.0	1RB49	Top	15mm	24.19	24.5	0.163	0.18	0.01
23060	704.0	25RB25	Top	15mm	23.44	23.5	0.127	0.13	-0.11

Note: SAR for LTE Band 17 is covered by LTE Band 12 due to similar frequency range, same maximum tune-up limit and same channel bandwidth.

Table 13.1: SAR Values (LTE Band 13 - Body)

Frequency		Test Mode	Test Position	Figure No./ Note	Conducted Power (dBm)	Max. tune-up Power (dBm)	Measured SAR(1g) (W/kg)	Reported SAR(1g) (W/kg)	Power Drift(dB)
Ch.	MHz								
Ambient Temperature: 22.5°C Liquid Temperature: 22.0°C									
0mm Test Data									
23230	782.0	1RB49	Rear	/	18.11	18.5	0.446	0.49	0.09
23230	782.0	25RB25	Rear	/	17.19	17.5	0.539	0.58	0.08
23230	782.0	1RB49	Top	/	18.11	18.5	0.498	0.54	0.02
23230	782.0	25RB25	Top	10	17.19	17.5	0.541	0.58	0.03
23230	782.0	1RB0	Left	/	23.45	24.0	0.212	0.24	0.17
23230	782.0	25RB0	Left	/	22.54	23.0	0.160	0.18	-0.02
Sensor off Test Data									
23230	782.0	1RB0	Rear	13mm	23.45	24.0	0.345	0.39	0.19
23230	782.0	25RB0	Rear	13mm	22.54	23.0	0.267	0.30	0.08
23230	782.0	1RB0	Top	15mm	23.45	24.0	0.218	0.25	0.18
23230	782.0	25RB0	Top	15mm	22.54	23.0	0.171	0.19	0.06

Table 13.2: SAR Values (LTE Band 66 - Body)

Frequency		Test Mode	Test Position	Figure No./ Note	Conducted Power (dBm)	Max. tune-up Power (dBm)	Measured SAR(1g) (W/kg)	Reported SAR(1g) (W/kg)	Power Drift(dB)
Ch.	MHz								
Ambient Temperature: 22.3°C Liquid Temperature: 21.8°C									
0mm Test Data									
132072	1720.0	1RB0	Rear	/	12.81	13.5	0.577	0.68	0.06
132072	1720.0	50RB0	Rear	/	11.58	12.5	0.364	0.45	0.05
132072	1720.0	1RB0	Top	11	12.81	13.5	0.678	0.79	0.04
132072	1720.0	50RB0	Top	/	11.58	12.5	0.443	0.55	0.06
132072	1720.0	1RB0	Left	/	22.68	23.5	0.444	0.54	0.02
132322	1745.0	50RB25	Left	/	21.73	22.5	0.359	0.43	0.07
Sensor off Test Data									
132072	1720.0	1RB0	Rear	13mm	22.68	23.5	0.476	0.57	0.03
132322	1745.0	50RB25	Rear	13mm	21.73	22.5	0.447	0.53	0.14
132072	1720.0	1RB0	Top	15mm	22.68	23.5	0.173	0.21	0.05
132322	1745.0	50RB25	Top	15mm	21.73	22.5	0.246	0.29	0.07

Note: SAR for LTE Band 4 is covered by LTE Band 66 due to similar frequency range, same maximum tune-up limit and same channel bandwidth.

Table 13.1: SAR Values (Bluetooth - Body)

Frequency		Test Mode	Test Position	Figure No./ Note	Conducted Power (dBm)	Max. tune-up Power (dBm)	Measured SAR(1g) (W/kg)	Reported SAR(1g) (W/kg)	Power Drift(dB)
Ch.	MHz								
Ambient Temperature: 22.2°C Liquid Temperature: 21.7°C									
0mm Test Data									
39	2441.0	8DPSK	Rear	12	8.87	9.5	0.064	0.07	0.09
39	2441.0	8DPSK	Top	/	8.87	9.5	0.020	0.02	0.09
39	2441.0	8DPSK	Right	/	8.87	9.5	0.019	0.02	0.06

13.3. WLAN Evaluation for 2.4G

According to the KDB248227 D01, SAR is measured for 2.4GHz 802.11b DSSS using the initial test position procedure.

Table 13.2: SAR Values (WLAN 2.4G - Body)

Ambient Temperature: 22.2°C					Liquid Temperature: 21.7°C				
Frequency		Test Mode	Test Position	Figure No./ Note	Conducted Power (dBm)	Max. tune-up Power (dBm)	Measured SAR(1g) (W/kg)	Reported SAR(1g) (W/kg)	Power Drift(dB)
Ch.	MHz								
0mm Test Data									
11	2462.0	802.11b	Rear	13	12.11	12.5	0.590	0.65	0.09
11	2462.0	802.11b	Top	/	12.11	12.5	0.195	0.21	0.09
1	2412.0	802.11b	Right	/	15.89	16.5	0.565	0.65	0.10
Sensor off Test Data									
1	2412.0	802.11b	Rear	9mm	15.89	16.5	0.250	0.29	0.01
1	2412.0	802.11b	Top	13mm	15.89	16.5	0.066	0.08	0.05

Note: For all positions/configurations tested using the initial test position and subsequent test positions, when the reported SAR is > 0.8 W/kg, SAR is measured for these test positions/configurations on the subsequent next highest measured output power channel until the reported SAR is ≤ 1.2 W/kg or all required channels are tested.

According to the KDB248227 D01, The reported SAR must be scaled to 100% transmission duty factor to determine compliance at the maximum tune-up tolerance limit.

Table 13.3: SAR Values (WLAN - Body) – 802.11b (Scaled Reported SAR)

Frequency		Test Position	Actual duty factor	maximum duty factor	Reported SAR (1g)(W/kg)	Scaled reported SAR (1g)(W/kg)
Ch.	MHz					
11	2462.0	Rear	100%	100%	0.65	0.65

SAR is not required for OFDM because the 802.11b adjusted SAR ≤ 1.2 W/kg.

13.4. WLAN Evaluation for 5G

Table 13.4: SAR Values (WLAN 5G - Body)

Frequency		Test Mode	Test Position	Figure No./ Note	Ambient Temperature: 21.9°C		Liquid Temperature: 21.4°C		
Ch.	MHz				Conducted Power (dBm)	Max. tune-up Power (dBm)	Measured SAR(1g) (W/kg)	Reported SAR(1g) (W/kg)	Power Drift(dB)
U-NII-2A - 0mm Test Data									
60	5300.0	802.11a	Rear	/	7.48	8.0	0.942	1.06	0.08
60	5300.0	802.11a	Top	/	7.48	8.0	0.998	1.12	0.09
60	5300.0	802.11a	Right	/	14.95	15.5	0.497	0.56	0.04
64	5320.0	802.11a	Rear	/	7.41	8.0	0.934	1.07	0.07
64	5320.0	802.11a	Top	14	7.41	8.0	1.000	1.15	0.09
U-NII-2A - Sensor off Test Data									
60	5300.0	802.11a	Rear	9mm	14.95	15.5	0.105	0.12	0.11
60	5300.0	802.11a	Top	13mm	14.95	15.5	0.174	0.20	0.09
U-NII-2C - 0mm Test Data									
140	5700.0	802.11a	Rear	/	8.32	9.0	0.498	0.58	0.09
140	5700.0	802.11a	Top	/	8.32	9.0	0.377	0.44	0.09
140	5700.0	802.11a	Right	/	15.79	16.5	0.924	1.09	0.05
132	5660.0	802.11a	Right	/	15.53	16.5	0.913	1.14	0.02
U-NII-2C - Sensor off Test Data									
140	5700.0	802.11a	Rear	9mm	15.79	16.5	0.491	0.58	0.09
140	5700.0	802.11a	Top	13mm	15.79	16.5	0.316	0.37	0.01
U-NII-3 - 0mm Test Data									
165	5825.0	802.11a	Rear	/	8.53	9.0	0.324	0.36	0.09
165	5825.0	802.11a	Top	/	8.53	9.0	0.242	0.27	0.09
165	5825.0	802.11a	Right	/	16.00	16.5	0.441	0.49	0.02
U-NII-3 - Sensor off Test Data									
165	5825.0	802.11a	Rear	9mm	16.00	16.5	0.272	0.31	0.09
165	5825.0	802.11a	Top	13mm	16.00	16.5	0.192	0.22	0.08

Note:

1. U-NII-1 and U-NII-2A bands have the same specified maximum output and tolerance; SAR is measured for U-NII-2A band first. Adjusted SAR of U-NII-2A band is ≤ 1.2 W/kg, SAR is not required for U-NII-1 band.
2. For all positions/configurations tested using the initial test position and subsequent test positions, when the reported SAR is > 0.8 W/kg, SAR is measured for these test positions/configurations on the subsequent next highest measured output power channel until the reported SAR is ≤ 1.2 W/kg or all required channels are tested.



According to the KDB248227 D01, The reported SAR must be scaled to 100% transmission duty factor to determine compliance at the maximum tune-up tolerance limit.

Table 13.5: SAR Values (WLAN - Body) – 802.11a (Scaled Reported SAR)

Frequency		Test Position	Actual duty factor	maximum duty factor	Reported SAR (1g)(W/kg)	Scaled reported SAR (1g)(W/kg)
Ch.	MHz					
64	5320.0	Rear	100%	100%	1.15	1.15

14. SAR Measurement Variability

SAR measurement variability must be assessed for each frequency band, which is determined by the SAR probe calibration point and tissue-equivalent medium used for the device measurements. When both head and body tissue-equivalent media are required for SAR measurements in a frequency band, the variability measurement procedures should be applied to the tissue medium with the highest measured SAR, using the highest measured SAR configuration for that tissue-equivalent medium.

The following procedures are applied to determine if repeated measurements are required.

- 1) Repeated measurement is not required when the original highest measured SAR is < 0.80 W/kg; steps 2) through 4) do not apply.
- 2) When the original highest measured SAR is ≥ 0.80 W/kg, repeat that measurement once.
- 3) Perform a second repeated measurement only if the ratio of largest to smallest SAR for the original and first repeated measurements is > 1.20 or when the original or repeated measurement is ≥ 1.45 W/kg (~ 10% from the 1-g SAR limit).
- 4) Perform a third repeated measurement only if the original, first or second repeated measurement is ≥ 1.5 W/kg and the ratio of largest to smallest SAR for the original, first and second repeated measurements is > 1.20 .

Table 14.1: SAR Measurement Variability for Body – GSM1900

Frequency		Test Position	Original	1 st Repeated	Ratio	2 nd Repeated
Ch.	MHz		SAR (W/kg)	SAR (W/kg)		SAR (W/kg)
661	1880.0	Top	1.10	1.06	1.04	/

Table 14.2: SAR Measurement Variability for Body – WCDMA Band 2

Frequency		Test Position	Original	1 st Repeated	Ratio	2 nd Repeated
Ch.	MHz		SAR (W/kg)	SAR (W/kg)		SAR (W/kg)
9538	1908.0	Top	0.946	0.935	1.01	/

Table 14.3: SAR Measurement Variability for Body – LTE Band 2

Frequency		Test Position	Original	1 st Repeated	Ratio	2 nd Repeated
Ch.	MHz		SAR (W/kg)	SAR (W/kg)		SAR (W/kg)
19100	1900.0	Top	0.981	0.965	1.02	/

Table 14.4: SAR Measurement Variability for Body – LTE Band 7

Frequency		Test Position	Original	1 st Repeated	Ratio	2 nd Repeated
Ch.	MHz		SAR (W/kg)	SAR (W/kg)		SAR (W/kg)
21100	2535.0	Top	0.935	0.922	1.01	/

Table 14.5: SAR Measurement Variability for Body – LTE Band 12

Frequency		Test Position	Original	1 st Repeated	Ratio	2 nd Repeated
Ch.	MHz		SAR (W/kg)	SAR (W/kg)		SAR (W/kg)
23130	711.0	Rear	0.935	0.918	1.02	/



Table 14.6: SAR Measurement Variability for Body – WLAN 5G

Frequency		Test Position	Original	1 st Repeated	Ratio	2 nd Repeated
Ch.	MHz		SAR (W/kg)	SAR (W/kg)		SAR (W/kg)
64	5320.0	Top	1.000	0.991	1.01	/

15. Measurement Uncertainty

15.1. Measurement Uncertainty for Normal SAR Tests (300MHz~3GHz)

No.	Error Description	Type	Uncertainty value	Probably Distribution	Div.	(Ci) 1g	(Ci) 10g	Std. Unc. (1g)	Std. Unc. (10g)	Degree of freedom
Measurement system										
1	Probe calibration	B	12	N	2	1	1	6.0	6.0	∞
2	Axial isotropy	B	4.7	R	$\sqrt{3}$	$\sqrt{0.5}$	$\sqrt{0.5}$	4.3	4.3	∞
3	Hemispherical isotropy	B	9.6	R	$\sqrt{3}$	1	1	4.8	4.8	∞
4	Boundary effect	B	1.1	R	$\sqrt{3}$	1	1	0.6	0.6	∞
5	Linearity	B	4.7	R	$\sqrt{3}$	1	1	2.7	2.7	∞
6	Detection limit	B	1.0	R	$\sqrt{3}$	1	1	0.6	0.6	∞
7	Modulation response	B	4.0	R	$\sqrt{3}$	1	1	2.3	2.3	∞
8	Readout electronics	B	1.0	N	1	1	1	1.0	1.0	∞
9	Response time	B	0.8	R	$\sqrt{3}$	1	1	0.5	0.5	∞
10	Integration time	B	1.7	R	$\sqrt{3}$	1	1	1.0	1.0	∞
11	RF ambient conditions-noise	B	3.0	R	$\sqrt{3}$	1	1	1.7	1.7	∞
12	RF ambient conditions-reflection	B	3.0	R	$\sqrt{3}$	1	1	1.7	1.7	∞
13	Probe positioned mech. restrictions	B	0.35	R	$\sqrt{3}$	1	1	0.2	0.2	∞
14	Probe positioning with respect to phantom shell	B	2.9	R	$\sqrt{3}$	1	1	1.7	1.7	∞
15	Post-processing	B	1.0	R	$\sqrt{3}$	1	1	0.6	0.6	∞
Test sample related										
16	Test sample positioning	A	3.3	N	1	1	1	3.3	3.3	5
17	Device holder uncertainty	A	3.4	N	1	1	1	3.4	3.4	5
18	Drift of output power	B	5.0	R	$\sqrt{3}$	1	1	2.9	2.9	∞
Phantom and set-up										
19	Phantom uncertainty	B	1.0	R	$\sqrt{3}$	1	1	0.6	0.6	∞
20	Liquid conductivity (target)	B	5.0	R	$\sqrt{3}$	0.64	0.43	1.8	1.2	∞
21	Liquid conductivity (meas.)	A	1.3	N	1	0.64	0.43	0.83	0.56	9
22	Liquid permittivity (target)	B	5.0	R	$\sqrt{3}$	0.6	0.49	1.7	1.4	∞
23	Liquid permittivity (meas.)	A	1.6	N	1	0.6	0.49	0.96	0.78	9
Combined standard uncertainty		$u_c = \sqrt{\sum_{i=1}^{23} c_i^2 u_i^2}$						11.3	11.2	95.5
Expanded uncertainty (Confidence interval of 95 %)		$u_e = 2u_c$						22.6	22.4	

15.2. Measurement Uncertainty for Normal SAR Tests (3GHz~6GHz)

No.	Error Description	Type	Uncertainty value	Probably Distribution	Div.	(Ci) 1g	(Ci) 10g	Std. Unc. (1g)	Std. Unc. (10g)	Degree of freedom
Measurement system										
1	Probe calibration	B	13	N	2	1	1	6.5	6.5	∞
2	Axial isotropy	B	4.7	R	$\sqrt{3}$	$\sqrt{0.5}$	$\sqrt{0.5}$	4.3	4.3	∞
3	Hemispherical isotropy	B	9.6	R	$\sqrt{3}$	1	1	4.8	4.8	∞
4	Boundary effect	B	2.3	R	$\sqrt{3}$	1	1	1.3	1.3	∞
5	Linearity	B	4.7	R	$\sqrt{3}$	1	1	2.7	2.7	∞
6	Detection limit	B	1.0	R	$\sqrt{3}$	1	1	0.6	0.6	∞
7	Modulation response	B	4.0	R	$\sqrt{3}$	1	1	2.3	2.3	∞
8	Readout electronics	B	1.0	N	1	1	1	1.0	1.0	∞
9	Response time	B	0.8	R	$\sqrt{3}$	1	1	0.5	0.5	∞
10	Integration time	B	1.7	R	$\sqrt{3}$	1	1	1.0	1.0	∞
11	RF ambient conditions-noise	B	3.0	R	$\sqrt{3}$	1	1	1.7	1.7	∞
12	RF ambient conditions-reflection	B	3.0	R	$\sqrt{3}$	1	1	1.7	1.7	∞
13	Probe positioned mech. restrictions	B	0.71	R	$\sqrt{3}$	1	1	0.4	0.4	∞
14	Probe positioning with respect to phantom shell	B	5.7	R	$\sqrt{3}$	1	1	3.3	3.3	∞
15	Post-processing	B	4.0	R	$\sqrt{3}$	1	1	2.3	2.3	∞
Test sample related										
16	Test sample positioning	A	3.3	N	1	1	1	3.3	3.3	5
17	Device holder uncertainty	A	3.4	N	1	1	1	3.4	3.4	5
18	Drift of output power	B	5.0	R	$\sqrt{3}$	1	1	2.9	2.9	∞
Phantom and set-up										
19	Phantom uncertainty	B	1.0	R	$\sqrt{3}$	1	1	0.6	0.6	∞
20	Liquid conductivity (target)	B	5.0	R	$\sqrt{3}$	0.64	0.43	1.8	1.2	∞
21	Liquid conductivity (meas.)	A	1.3	N	1	0.64	0.43	0.83	0.56	9
22	Liquid permittivity (target)	B	5.0	R	$\sqrt{3}$	0.6	0.49	1.7	1.4	∞
23	Liquid permittivity (meas.)	A	1.6	N	1	0.6	0.49	0.96	0.78	9
Combined standard uncertainty		$u_c = \sqrt{\sum_{i=1}^{23} c_i^2 u_i^2}$						12.2	12.1	95.5
Expanded uncertainty (Confidence interval of 95 %)		$u_e = 2u_c$						24.4	24.2	

16. Main Test Instruments

Table 16.1: List of Main Instruments

No.	Name	Type	Serial Number	Calibration Date	Valid Period
01	Network analyzer	E5071C	MY46103759	2020-11-15	One year
02	Dielectric probe	85070E	MY44300317	/	/
03	Power meter	E4418B	MY50000366	2020-12-13	One year
04	Power sensor	E9304A	MY50000188		
05	Power meter	NRP	101460	2021-01-15	One year
06	Power sensor	NRP-Z91	100553		
07	Signal Generator	E8257D	MY47461211	2021-01-15	One year
08	Amplifier	VTL5400	0404	/	/
09	E-field Probe	EX3DV4	7621	2020-11-30 & 2020-10-05	One year
10	DAE	DAE4	1527	2020-11-06	One year
11	Dipole Validation Kit	D750V3	1163	2019-09-03	Three year
12	Dipole Validation Kit	D835V2	4d057	2018-10-09	Three year
13	Dipole Validation Kit	D1750V2	1152	2019-08-30	Three year
14	Dipole Validation Kit	D1900V2	5d088	2018-10-24	Three year
15	Dipole Validation Kit	D2450V2	873	2018-10-26	Three year
16	Dipole Validation Kit	D2550V2	1010	2021-05-21	Three year
17	Dipole Validation Kit	D5GHzV2	1238	2019-08-29	Three year
18	BTS	MT8820C	6201341853	2021-01-15	One year
19	BTS	E5515C	GB46110722	2021-01-15	One year
20	BTS	CMW500	158344	2020-07-17	One year
21	Software	DASY5	52.8.8.1222	/	/

ANNEX A: Graph Results

GSM850 Body

Date: 2021-8-6

Electronics: DAE4 Sn1527

Medium: Head 835MHz

Medium parameters used (interpolated): $f = 824.2$ MHz; $\sigma = 0.915$ S/m; $\epsilon_r = 40.587$; $\rho = 1000$ kg/m³

Communication System: UID 0, GPRS 2Txslot (0) Frequency: 824.2 MHz Duty Cycle: 1:4

Probe: EX3DV4 – SN7621 ConvF (10.35, 10.35, 10.35);

Rear Side Low/Area Scan (61x61x1): Interpolated grid: dx=1.500 mm, dy=1.500 mm

Maximum value of SAR (interpolated) = 0.620 W/kg

Rear Side Low -13mm/Zoom Scan (5x5x7)/Cube 0: Measurement grid: dx=8mm, dy=8mm, dz=5mm

Reference Value = 7.086 V/m; Power Drift = 0.07 dB

Peak SAR (extrapolated) = 0.776 W/kg

SAR(1 g) = 0.475 W/kg; SAR(10 g) = 0.294 W/kg

Maximum value of SAR (measured) = 0.625 W/kg

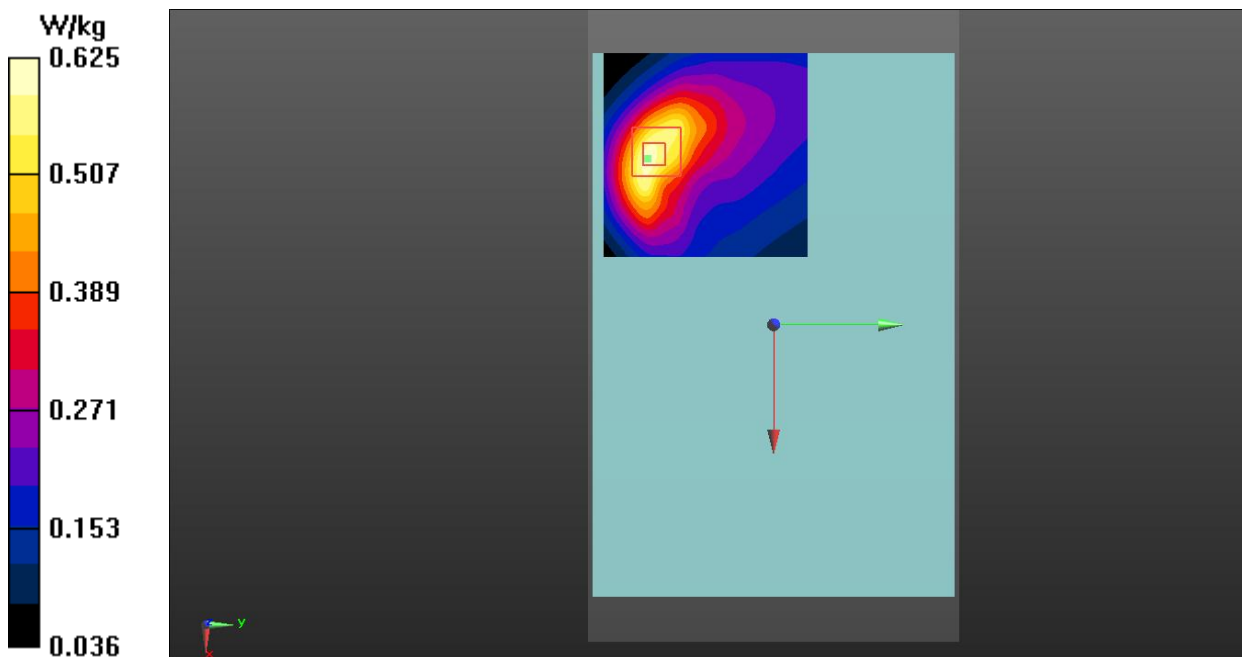

Fig.1 GSM 850 Body

GSM1900 Body

Date: 2021-8-16

Electronics: DAE4 Sn1527

Medium: Head 1900MHz

Medium parameters used (interpolated): $f = 1850.2$ MHz; $\sigma = 1.341$ S/m; $\epsilon_r = 39.423$; $\rho = 1000$ kg/m³

Communication System: UID 0, GPRS 4Txslot (0) Frequency: 1850.2 MHz Duty Cycle: 1:2

Probe: EX3DV4 – SN7621 ConvF (8.77, 8.77, 8.77);

Top Side Low/Area Scan (71x41x1): Interpolated grid: dx=1.500 mm, dy=1.500 mm

Maximum value of SAR (interpolated) = 1.86 W/kg

Top Side Low/Zoom Scan (5x5x7)/Cube 0: Measurement grid: dx=8mm, dy=8mm, dz=5mm

Reference Value = 1.428 V/m; Power Drift = 0.06 dB

Peak SAR (extrapolated) = 2.54 W/kg

SAR(1 g) = 1.11 W/kg; SAR(10 g) = 0.458 W/kg

Maximum value of SAR (measured) = 1.89 W/kg

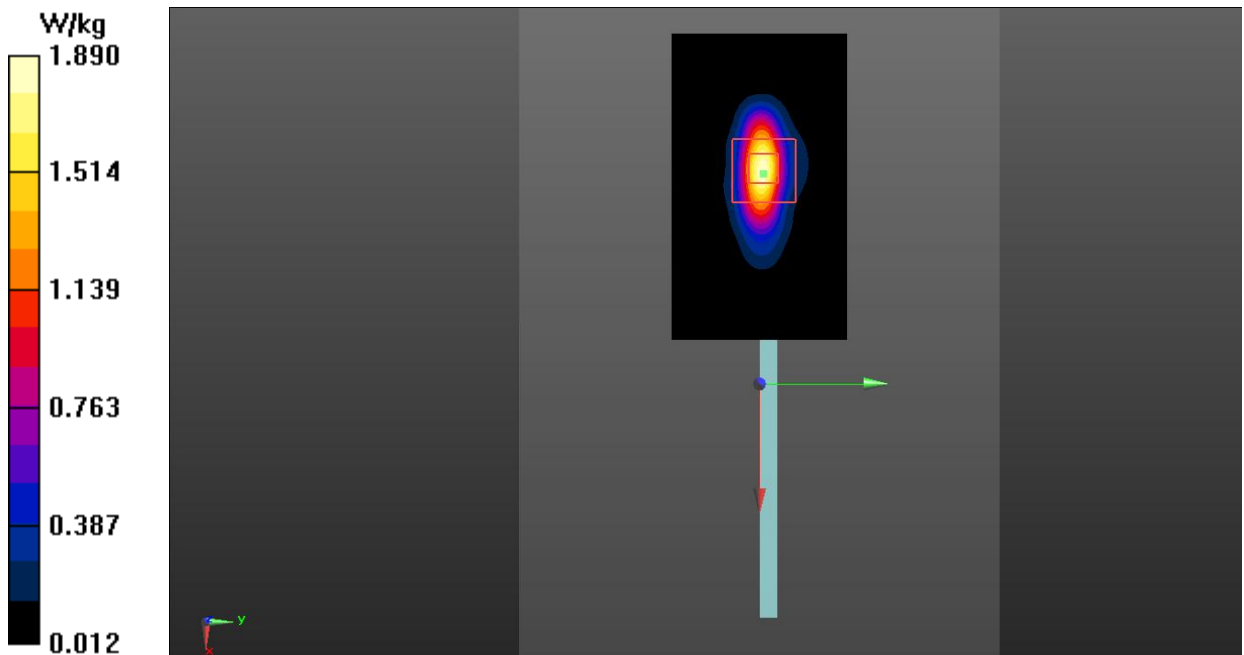

Fig.2 GSM 1900 Body

WCDMA Band 2 Body

Date: 2021-8-16

Electronics: DAE4 Sn1527

Medium: Head 1900MHz

Medium parameters used: $f = 1908$ MHz; $\sigma = 1.392$ S/m; $\epsilon_r = 39.198$; $\rho = 1000$ kg/m³

Communication System: UID 0, WCDMA (0) Frequency: 1907.6 MHz Duty Cycle: 1:1

Probe: EX3DV4 – SN7621 ConvF (8.77, 8.77, 8.77);

Top Side High/Area Scan (71x41x1): Interpolated grid: $dx=1.500$ mm, $dy=1.500$ mm

Maximum value of SAR (interpolated) = 1.79 W/kg

Top Side High/Zoom Scan (5x5x7)/Cube 0: Measurement grid: $dx=8$ mm, $dy=8$ mm, $dz=5$ mm

Reference Value = 1.148 V/m; Power Drift = 0.01 dB

Peak SAR (extrapolated) = 2.22 W/kg

SAR(1 g) = 0.946 W/kg; SAR(10 g) = 0.389 W/kg

Maximum value of SAR (measured) = 1.68 W/kg

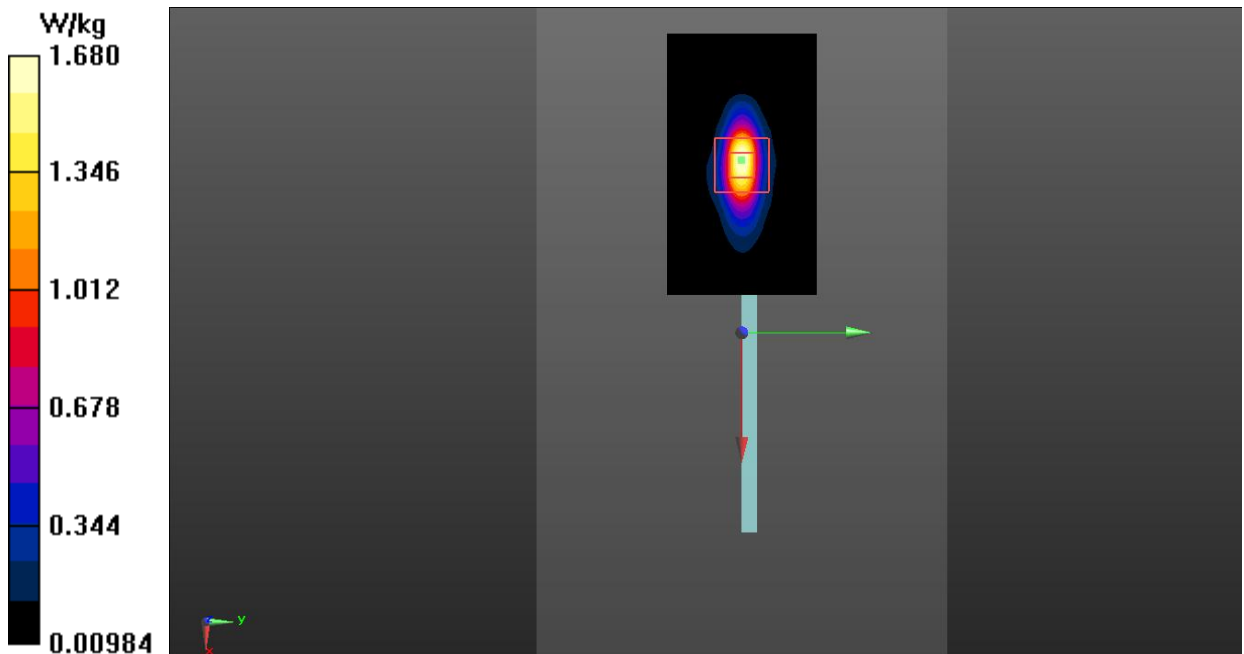
**Fig.3 WCDMA Band 2 Body**

WCDMA Band 4 Body

Date: 2021-8-15

Electronics: DAE4 Sn1527

Medium: Head 1750MHz

Medium parameters used: $f = 1733 \text{ MHz}$; $\sigma = 1.347 \text{ S/m}$; $\epsilon_r = 39.81$; $\rho = 1000 \text{ kg/m}^3$

Communication System: UID 0, WCDMA (0) Frequency: 1732.6 MHz Duty Cycle: 1:1

Probe: EX3DV4 – SN7621 ConvF (9.14, 9.14, 9.14);

Top Side Middle/Area Scan (71x41x1): Interpolated grid: $dx=1.500 \text{ mm}$, $dy=1.500 \text{ mm}$

Maximum value of SAR (interpolated) = 0.965 W/kg

Top Side Middle/Zoom Scan (5x5x7)/Cube 0: Measurement grid: $dx=8\text{mm}$, $dy=8\text{mm}$, $dz=5\text{mm}$

Reference Value = 2.849 V/m; Power Drift = 0.09 dB

Peak SAR (extrapolated) = 1.31 W/kg

SAR(1 g) = 0.616 W/kg; SAR(10 g) = 0.267 W/kg

Maximum value of SAR (measured) = 1.00 W/kg

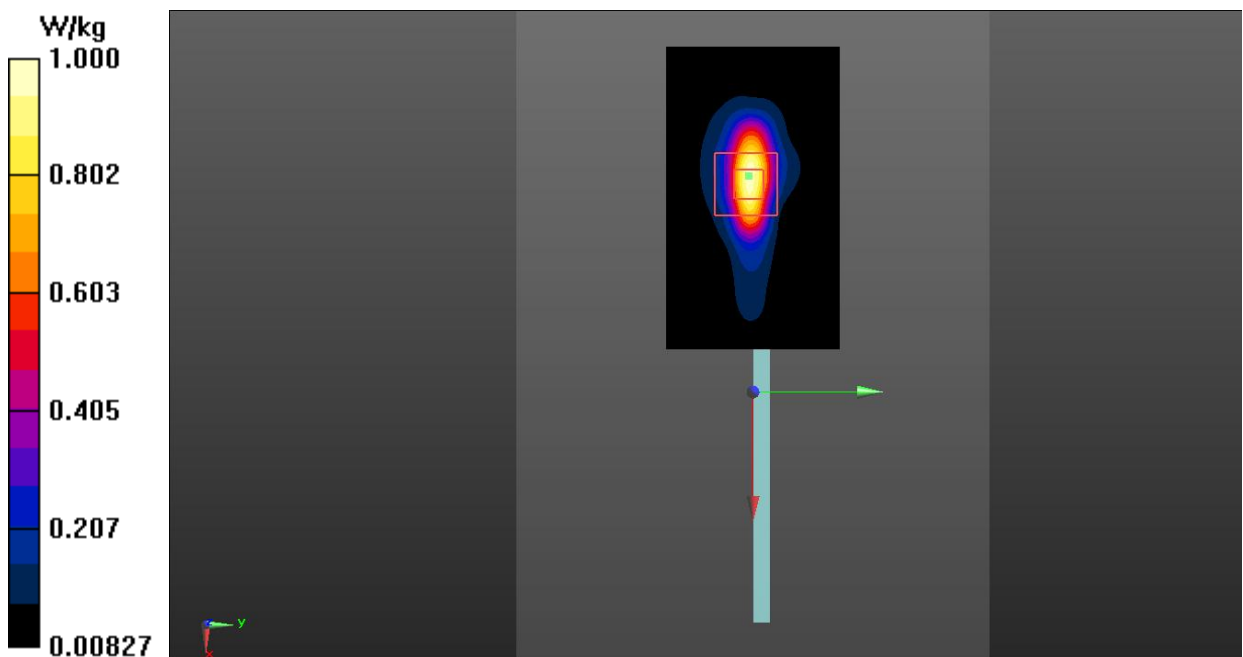

Fig.4 WCDMA Band 4 Body

WCDMA Band 5 Body

Date: 2021-8-6

Electronics: DAE4 Sn1527

Medium: Head 835MHz

Medium parameters used (interpolated): $f = 836.4$ MHz; $\sigma = 0.926$ S/m; $\epsilon_r = 40.44$; $\rho = 1000$ kg/m³

Communication System: UID 0, WCDMA (0) Frequency: 836.4 MHz Duty Cycle: 1:1

Probe: EX3DV4 – SN7621 ConvF (10.35, 10.35, 10.35);

Top Side Middle/Area Scan (71x41x1): Interpolated grid: $dx=1.500$ mm, $dy=1.500$ mm

Maximum value of SAR (interpolated) = 0.642 W/kg

Top Side Middle/Zoom Scan (5x5x7)/Cube 0: Measurement grid: $dx=8$ mm, $dy=8$ mm, $dz=5$ mm

Reference Value = 6.163 V/m; Power Drift = 0.08 dB

Peak SAR (extrapolated) = 1.65 W/kg

SAR(1 g) = 0.444 W/kg; SAR(10 g) = 0.188 W/kg

Maximum value of SAR (measured) = 0.943 W/kg

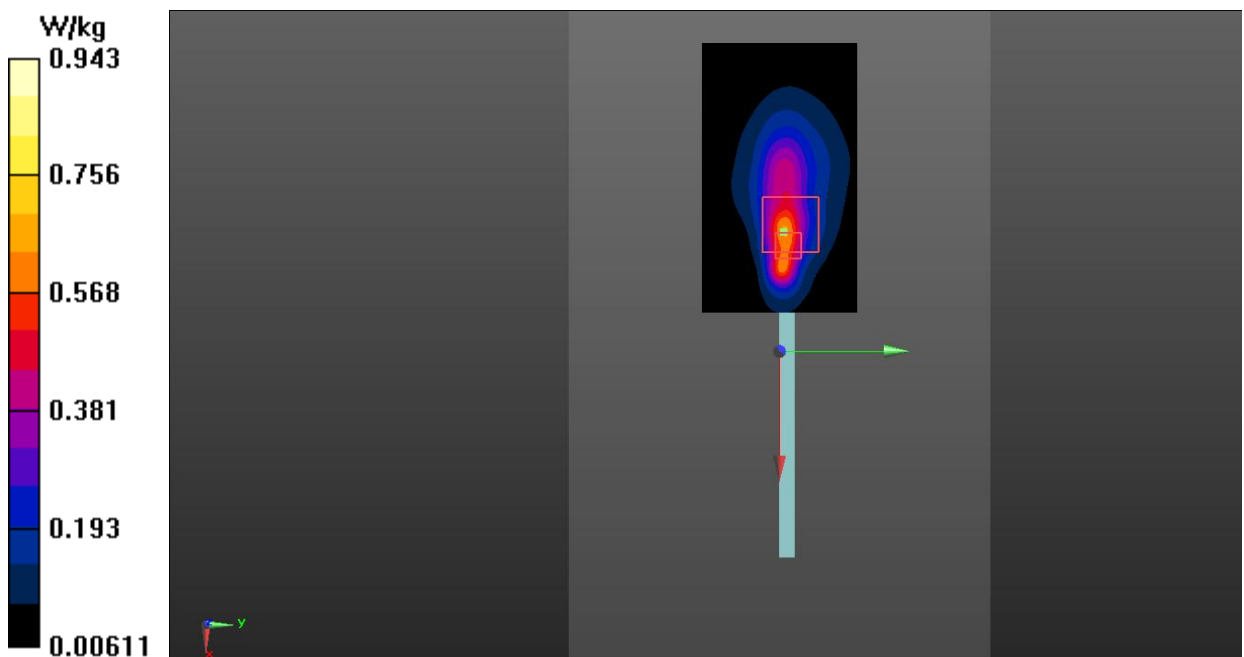

Fig.5 WCDMA Band 5 Body

LTE Band 2 Body

Date: 2021-8-16

Electronics: DAE4 Sn1527

Medium: Head 1900MHz

Medium parameters used: $f = 1900$ MHz; $\sigma = 1.385$ S/m; $\epsilon_r = 39.229$; $\rho = 1000$ kg/m³

Communication System: UID 0, LTE_FDD (0) Frequency: 1900 MHz Duty Cycle: 1:1

Probe: EX3DV4 – SN7621 ConvF (8.77, 8.77, 8.77);

Top Side High 1RB50/Area Scan (71x41x1): Interpolated grid: dx=1.500 mm, dy=1.500 mm

Maximum value of SAR (interpolated) = 1.51 W/kg

Top Side High 1RB50/Zoom Scan (5x5x7)/Cube 0: Measurement grid: dx=8mm, dy=8mm, dz=5mm

Reference Value = 1.643 V/m; Power Drift = 0.04 dB

Peak SAR (extrapolated) = 2.12 W/kg

SAR(1 g) = 0.981 W/kg; SAR(10 g) = 0.552 W/kg

Maximum value of SAR (measured) = 1.57 W/kg

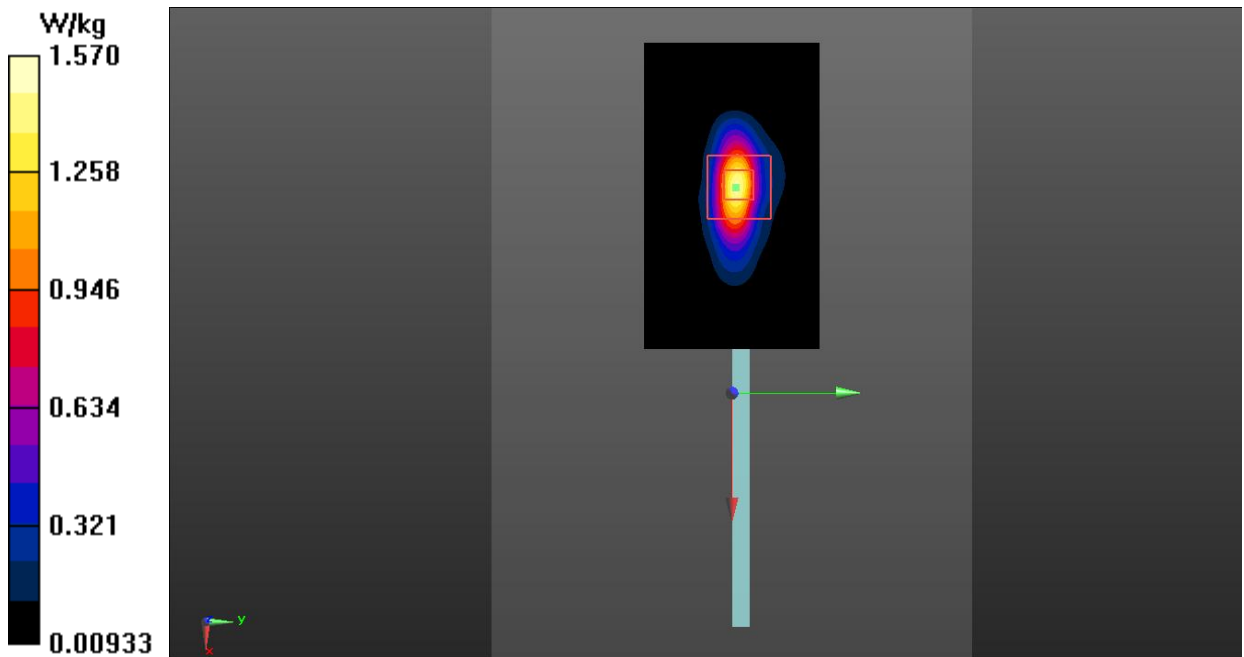

Fig.6 LTE Band 2 Body

LTE Band 5 Body

Date: 2021-8-6

Electronics: DAE4 Sn1527

Medium: Head 835MHz

Medium parameters used (interpolated): $f = 836.5$ MHz; $\sigma = 0.926$ S/m; $\epsilon_r = 40.439$; $\rho = 1000$ kg/m³

Communication System: UID 0, LTE_FDD (0) Frequency: 836.5 MHz Duty Cycle: 1:1

Probe: EX3DV4 – SN7621 ConvF (10.35, 10.35, 10.35);

Rear Side Middle 1RB49/Area Scan (61x61x1): Interpolated grid: $dx=1.500$ mm, $dy=1.500$ mm
Maximum value of SAR (interpolated) = 1.09 W/kg**Rear Side Middle 1RB49/Zoom Scan (5x5x7)/Cube 0:** Measurement grid: $dx=8$ mm, $dy=8$ mm, $dz=5$ mm

Reference Value = 2.729 V/m; Power Drift = 0.19 dB

Peak SAR (extrapolated) = 1.88 W/kg

SAR(1 g) = 0.794 W/kg; SAR(10 g) = 0.403 W/kg

Maximum value of SAR (measured) = 1.30 W/kg

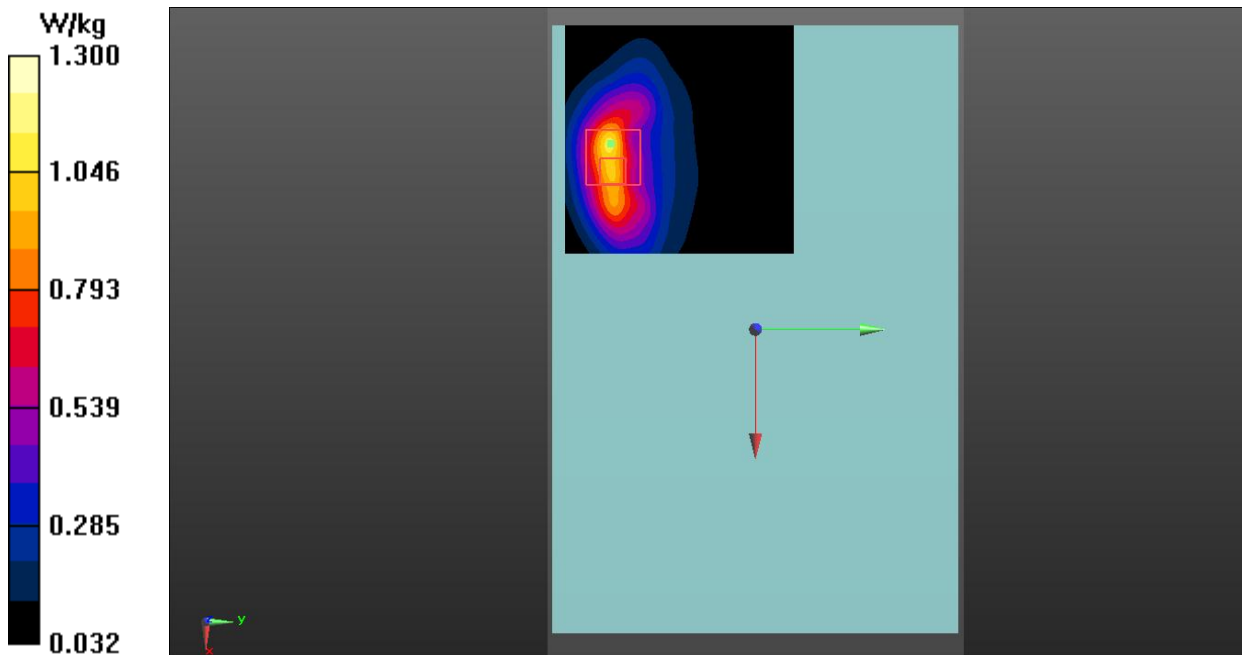

Fig.7 LTE Band 5 Body

LTE Band 7 Body

Date: 2021-8-13

Electronics: DAE4 Sn1527

Medium: Head 2550MHz

Medium parameters used (interpolated): $f = 2535$ MHz; $\sigma = 1.928$ S/m; $\epsilon_r = 38.028$; $\rho = 1000$ kg/m³

Communication System: UID 0, LTE_FDD (0) Frequency: 2535 MHz Duty Cycle: 1:1

Probe: EX3DV4 – SN7621 ConvF (8.01, 8.01, 8.01);

Top Side Middle 1RB99/Area Scan (121x61x1): Interpolated grid: dx=1.000 mm, dy=1.000 mm
Maximum value of SAR (interpolated) = 1.35 W/kg**Top Side Middle 1RB99/Zoom Scan (7x7x7)/Cube 0:** Measurement grid: dx=5mm, dy=5mm, dz=5mm

Reference Value = 7.648 V/m; Power Drift = 0.03 dB

Peak SAR (extrapolated) = 1.68 W/kg

SAR(1 g) = 0.935 W/kg; SAR(10 g) = 0.510 W/kg

Maximum value of SAR (measured) = 1.31 W/kg

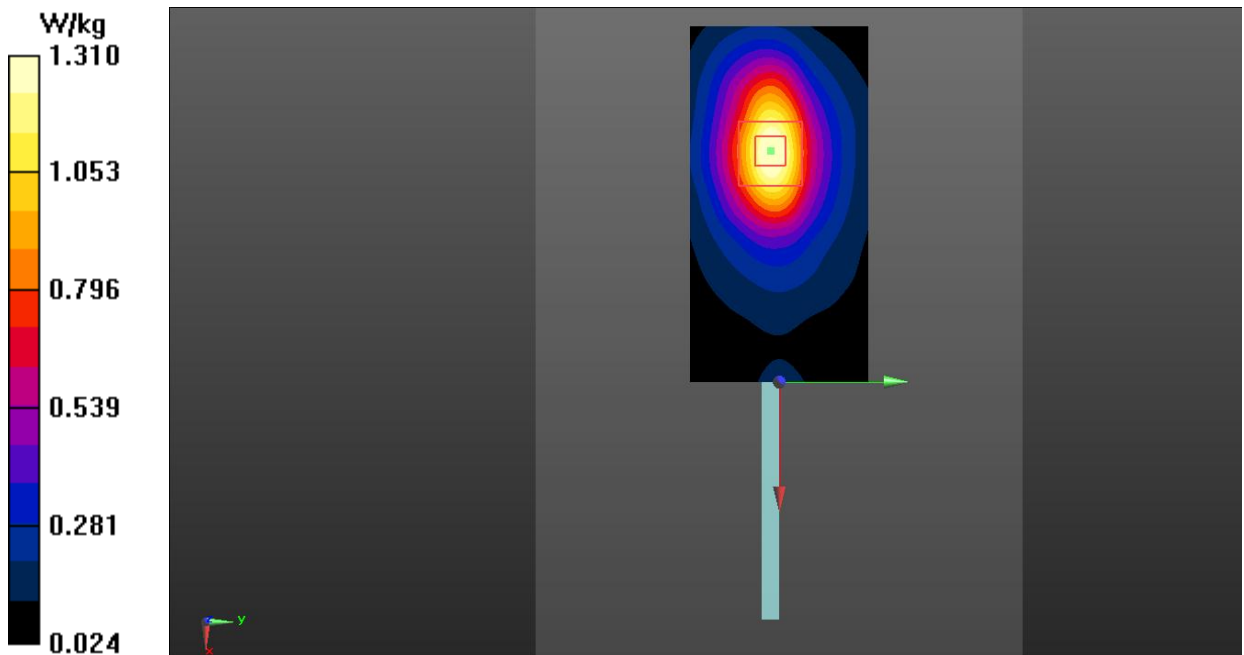

Fig.8 LTE Band 7 Body

LTE Band 12 Body

Date: 2021-8-9

Electronics: DAE4 Sn1527

Medium: Head 750MHz

Medium parameters used (interpolated): $f = 711$ MHz; $\sigma = 0.894$ S/m; $\epsilon_r = 41.492$; $\rho = 1000$ kg/m³

Communication System: UID 0, LTE_FDD (0) Frequency: 711 MHz Duty Cycle: 1:1

Probe: EX3DV4 – SN7621 ConvF (10.88, 10.88, 10.88);

Rear Side High 1RB24/Area Scan (61x61x1): Interpolated grid: $dx=1.500$ mm, $dy=1.500$ mm
Maximum value of SAR (interpolated) = 1.12 W/kg**Rear Side High 1RB24/Zoom Scan (5x5x7)/Cube 0:** Measurement grid: $dx=8$ mm, $dy=8$ mm, $dz=5$ mm

Reference Value = 4.260 V/m; Power Drift = 0.03 dB

Peak SAR (extrapolated) = 2.40 W/kg

SAR(1 g) = 0.935 W/kg; SAR(10 g) = 0.486 W/kg

Maximum value of SAR (measured) = 1.51 W/kg

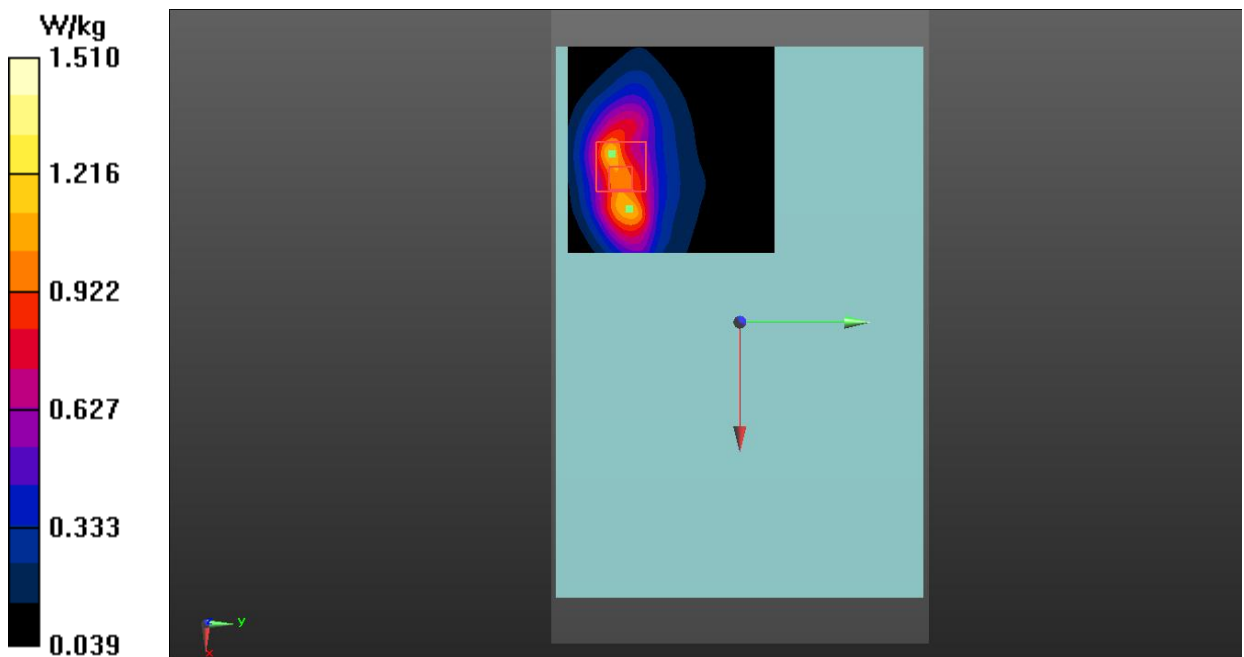
**Fig.9 LTE Band 12 Body**

LTE Band 13 Body

Date: 2021-8-9

Electronics: DAE4 Sn1527

Medium: Head 750MHz

Medium parameters used: $f = 782$ MHz; $\sigma = 0.929$ S/m; $\epsilon_r = 40.641$; $\rho = 1000$ kg/m³

Communication System: UID 0, LTE_FDD (0) Frequency: 782 MHz Duty Cycle: 1:1

Probe: EX3DV4 – SN7621 ConvF (10.88, 10.88, 10.88);

Top Side Middle 25RB25/Area Scan (71x41x1): Interpolated grid: $dx=1.500$ mm, $dy=1.500$ mm
Maximum value of SAR (interpolated) = 1.35 W/kg**Top Side Middle 25RB25/Zoom Scan (5x5x7)/Cube 0:** Measurement grid: $dx=8$ mm, $dy=8$ mm, $dz=5$ mm

Reference Value = 5.771 V/m; Power Drift = 0.03 dB

Peak SAR (extrapolated) = 1.98 W/kg

SAR(1 g) = 0.541 W/kg; SAR(10 g) = 0.219 W/kg

Maximum value of SAR (measured) = 1.13 W/kg

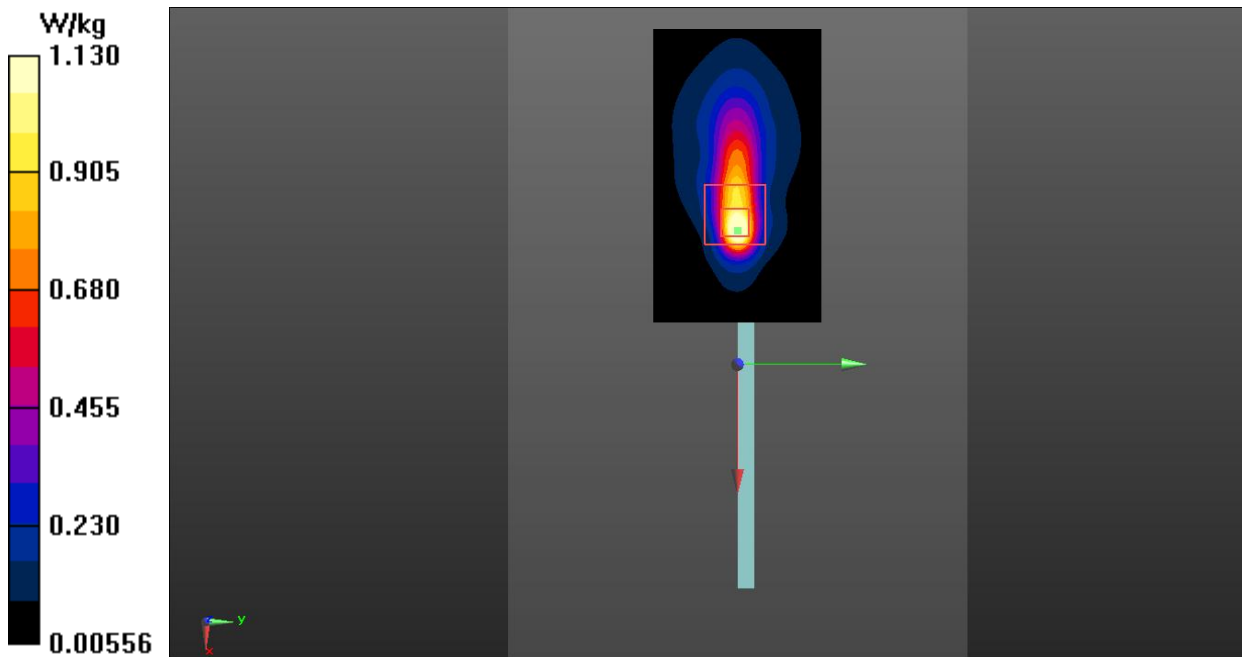

Fig.10 LTE Band 13 Body

LTE Band 66 Body

Date: 2021-8-15

Electronics: DAE4 Sn1527

Medium: Head 1750MHz

Medium parameters used: $f = 1720$ MHz; $\sigma = 1.336$ S/m; $\epsilon_r = 39.861$; $\rho = 1000$ kg/m³

Communication System: UID 0, LTE_FDD (0) Frequency: 1720 MHz Duty Cycle: 1:1

Probe: EX3DV4 – SN7621 ConvF (9.14, 9.14, 9.14);

Top Side Low 1RB0/Area Scan (71x41x1): Interpolated grid: dx=1.500 mm, dy=1.500 mm

Maximum value of SAR (interpolated) = 0.926 W/kg

Top Side Low 1RB0/Zoom Scan (5x5x7)/Cube 0: Measurement grid: dx=8mm, dy=8mm, dz=5mm

Reference Value = 3.087 V/m; Power Drift = 0.04 dB

Peak SAR (extrapolated) = 1.41 W/kg

SAR(1 g) = 0.678 W/kg; SAR(10 g) = 0.297 W/kg

Maximum value of SAR (measured) = 1.08 W/kg

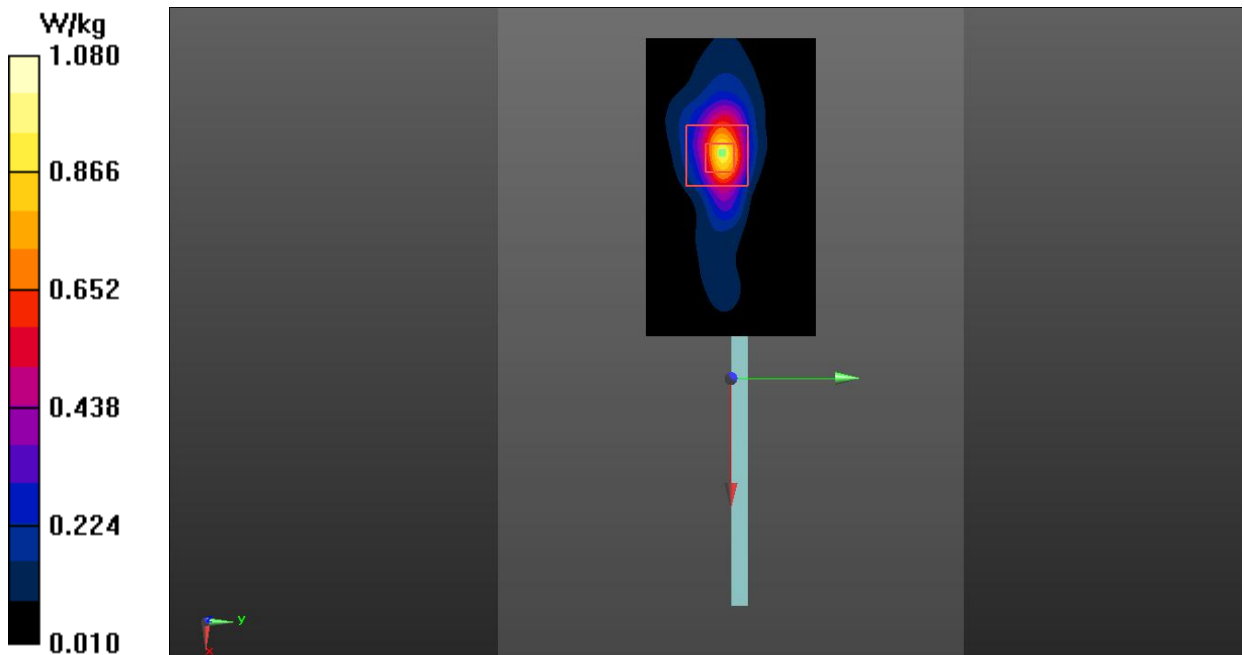

Fig.11 LTE Band 66 Body

Bluetooth Body

Date: 2021-8-8

Electronics: DAE4 Sn1527

Medium: Head 2450MHz

Medium parameters used (interpolated): $f = 2441$ MHz; $\sigma = 1.838$ S/m; $\epsilon_r = 38.471$; $\rho = 1000$ kg/m³

Communication System: UID 0, BT (0) Frequency: 2441 MHz Duty Cycle: 1:1

Probe: EX3DV4 – SN7621 ConvF (8.01, 8.01, 8.01);

Rear Side Ch.39/Area Scan (91x91x1): Interpolated grid: $dx=1.000$ mm, $dy=1.000$ mm

Maximum value of SAR (interpolated) = 0.0658 W/kg

Rear Side Ch.39/Zoom Scan (7x7x7)/Cube 0: Measurement grid: $dx=5$ mm, $dy=5$ mm, $dz=5$ mm

Reference Value = 1.103 V/m; Power Drift = 0.09 dB

Peak SAR (extrapolated) = 0.211 W/kg

SAR(1 g) = 0.064 W/kg; SAR(10 g) = 0.024 W/kg

Maximum value of SAR (measured) = 0.104 W/kg

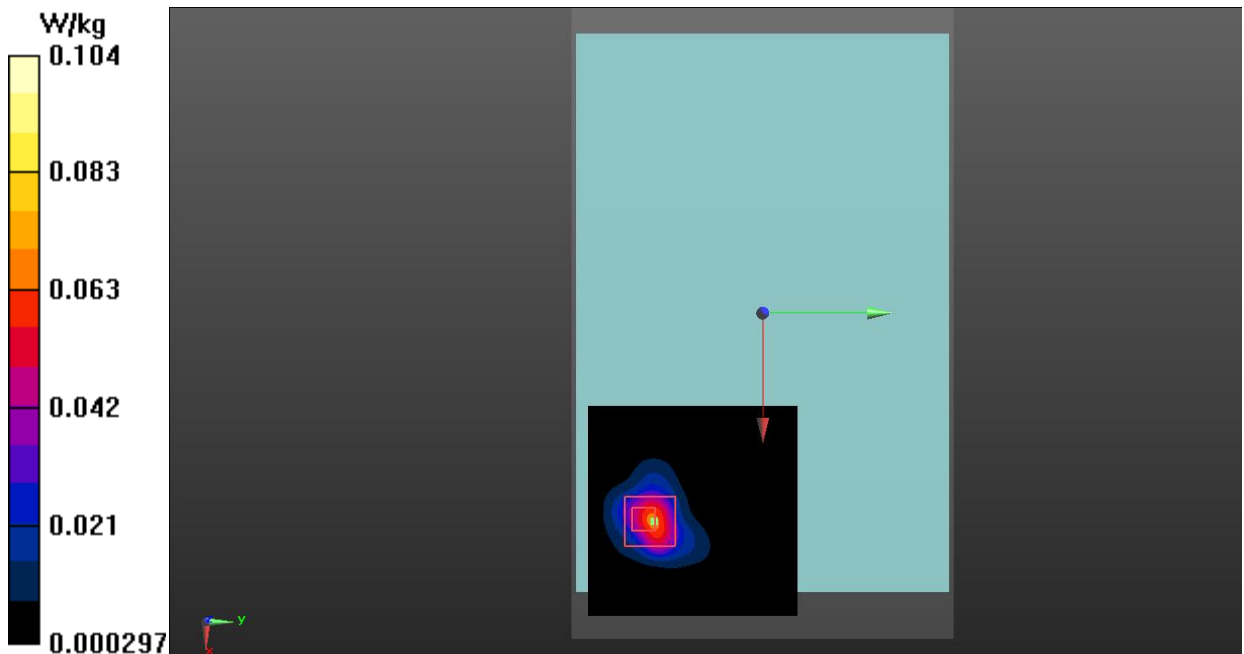

Fig.12 Bluetooth Body

WLAN 2.4G Body

Date: 2021-8-8

Electronics: DAE4 Sn1527

Medium: Head 2450MHz

Medium parameters used: $f = 2462$ MHz; $\sigma = 1.863$ S/m; $\epsilon_r = 38.401$; $\rho = 1000$ kg/m³

Communication System: UID 0, WiFi (0) Frequency: 2462 MHz Duty Cycle: 1:1

Probe: EX3DV4 – SN7621 ConvF (8.01, 8.01, 8.01);

Rear Side Ch.11/Area Scan (91x91x1): Interpolated grid: $dx=1.000$ mm, $dy=1.000$ mm

Maximum value of SAR (interpolated) = 0.645 W/kg

Rear Side Ch.11/Zoom Scan (7x7x7)/Cube 0: Measurement grid: $dx=5$ mm, $dy=5$ mm, $dz=5$ mm

Reference Value = 1.230 V/m; Power Drift = 0.09 dB

Peak SAR (extrapolated) = 1.87 W/kg

SAR(1 g) = 0.590 W/kg; SAR(10 g) = 0.225 W/kg

Maximum value of SAR (measured) = 1.05 W/kg

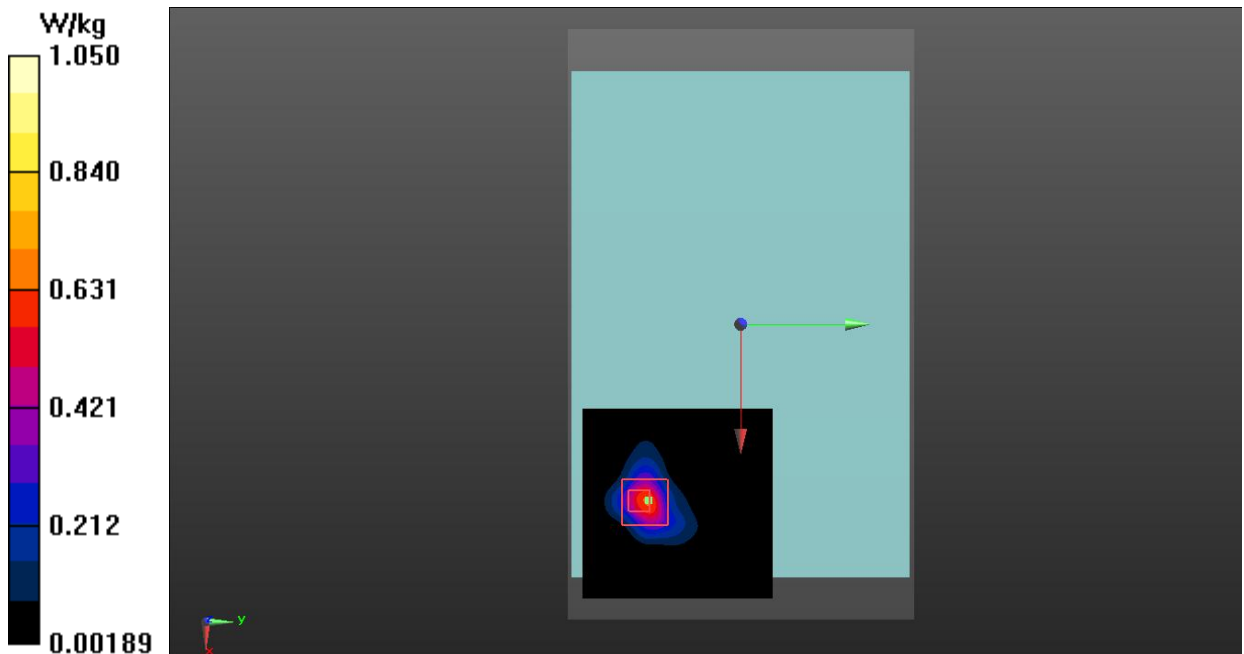
**Fig.13 WLAN 2.4G Body**

WLAN 5G Body

Date: 2021-8-10

Electronics: DAE4 Sn1527

Medium: Head 5250MHz

Medium parameters used: $f = 5320$ MHz; $\sigma = 4.747$ S/m; $\epsilon_r = 36.347$; $\rho = 1000$ kg/m³

Communication System: UID 0, WIFI 5G (0) Frequency: 5320 MHz Duty Cycle: 1:1

Probe: EX3DV4 - SN7621 ConvF (5.97, 5.97, 5.97);

Top Side Ch.64/Area Scan (111x61x1): Interpolated grid: $dx=1.000$ mm, $dy=1.000$ mm

Maximum value of SAR (interpolated) = 1.36 W/kg

Top Side Ch.64/Zoom Scan (8x8x21)/Cube 0: Measurement grid: $dx=4$ mm, $dy=4$ mm, $dz=1.4$ mm

Reference Value = 1.452 V/m; Power Drift = 0.09 dB

Peak SAR (extrapolated) = 6.84 W/kg

SAR(1 g) = 1.00 W/kg; SAR(10 g) = 0.191 W/kg

Maximum value of SAR (measured) = 2.29 W/kg

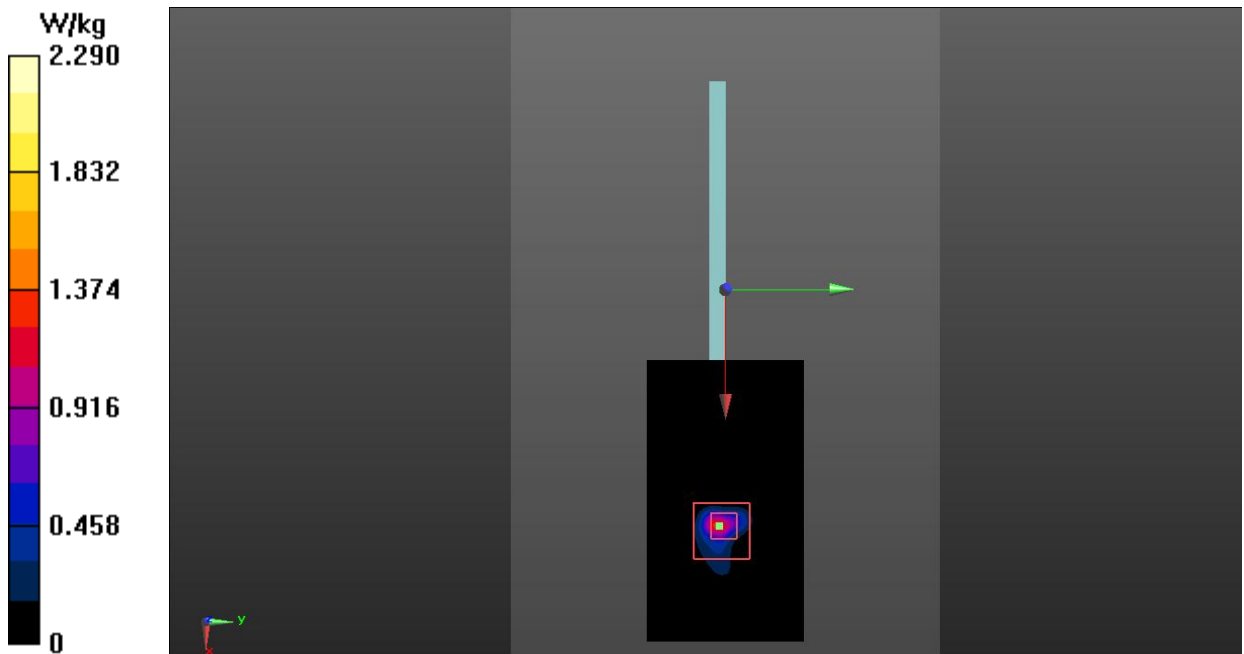

Fig.14 WLAN 5G Body

ANNEX B: SystemVerification Results

750MHz

Date: 2021-8-9

Electronics: DAE4 Sn1527

Medium: Head 750MHz

Medium parameters used: $f = 750$ MHz; $\sigma = 0.919$ S/m; $\epsilon_r = 41.025$; $\rho = 1000$ kg/m³

Communication System: CW_TMC Frequency: 750 MHz Duty Cycle: 1:1

Probe: EX3DV4 – SN7621 ConvF (10.88, 10.88, 10.88);

System Validation /Area Scan (81x161x1): Interpolated grid: $dx=1.000$ mm, $dy=1.000$ mm

Reference Value = 61.029 V/m; Power Drift = 0.13 dB

SAR(1 g) = 2.18 W/kg; SAR(10 g) = 1.44 W/kg

Maximum value of SAR (interpolated) = 2.85 W/kg

System Validation /Zoom Scan (7x7x7)/Cube 0: Measurement grid: $dx=5$ mm, $dy=5$ mm, $dz=5$ mm

Reference Value = 61.029 V/m; Power Drift = 0.13 dB

Peak SAR (extrapolated) = 3.38 W/kg

SAR(1 g) = 2.22 W/kg; SAR(10 g) = 1.46 W/kg

Maximum value of SAR (measured) = 2.90 W/kg

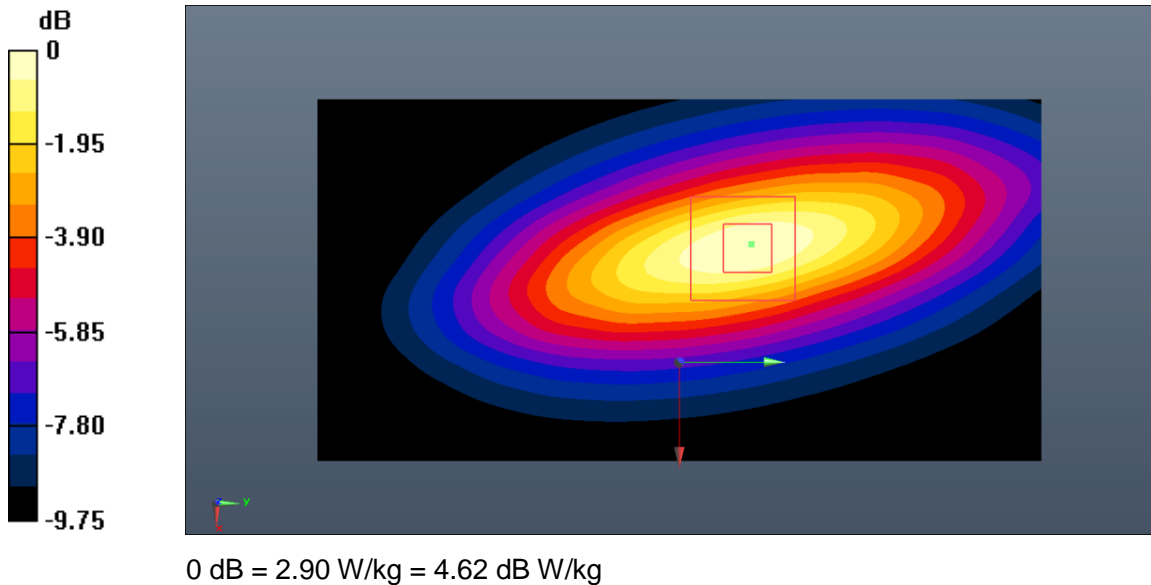

Fig.B.1. Validation 750MHz 250mW

835MHz

Date: 2021-8-6

Electronics: DAE4 Sn1527

Medium: Head 835MHz

Medium parameters used: $f = 835 \text{ MHz}$; $\sigma = 0.925 \text{ S/m}$; $\epsilon_r = 40.457$; $\rho = 1000 \text{ kg/m}^3$

Communication System: CW Frequency: 835 MHz Duty Cycle: 1:1

Probe: EX3DV4 – SN7621 ConvF (10.35, 10.35, 10.35);

System Validation /Area Scan (81x151x1): Interpolated grid: $dx=1.000 \text{ mm}$, $dy=1.000 \text{ mm}$

Reference Value = 64.842 V/m; Power Drift = 0.04 dB

SAR(1 g) = 2.46 W/kg; SAR(10 g) = 1.58 W/kg

Maximum value of SAR (interpolated) = 3.35 W/kg

System Validation /Zoom Scan (7x7x7)/Cube 0: Measurement grid: $dx=5\text{mm}$, $dy=5\text{mm}$, $dz=5\text{mm}$

Reference Value = 64.842 V/m; Power Drift = 0.04 dB

Peak SAR (extrapolated) = 3.69 W/kg

SAR(1 g) = 2.48 W/kg; SAR(10 g) = 1.60 W/kg

Maximum value of SAR (measured) = 3.39 W/kg

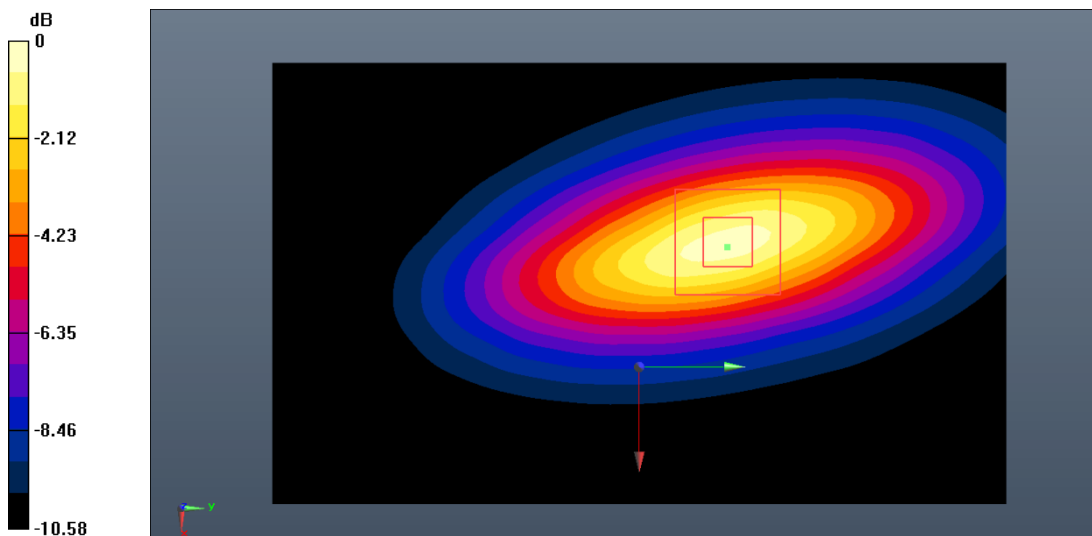

0 dB = 3.39 W/kg = 5.30 dB W/kg

Fig.B.2. Validation 835MHz 250mW

1750MHz

Date: 2021-8-15

Electronics: DAE4 Sn1527

Medium: Head 1750MHz

Medium parameters used: $f = 1750 \text{ MHz}$; $\sigma = 1.362 \text{ S/m}$; $\epsilon_r = 39.744$; $\rho = 1000 \text{ kg/m}^3$

Communication System: CW_TMC Frequency: 1750 MHz Duty Cycle: 1:1

Probe: EX3DV4 – SN7621 ConvF (9.14, 9.14, 9.14);

System Validation /Area Scan (81x121x1): Interpolated grid: $dx=1.000 \text{ mm}$, $dy=1.000 \text{ mm}$

Reference Value = 78.146 V/m; Power Drift = -0.08 dB

SAR(1 g) = 9.11 W/kg; SAR(10 g) = 4.85 W/kg

Maximum value of SAR (interpolated) = 11.0 W/kg

System Validation /Zoom Scan (7x7x7)/Cube0: Measurement grid: $dx=5\text{mm}$, $dy=5\text{mm}$, $dz=5\text{mm}$

Reference Value = 78.146 V/m; Power Drift = -0.08 dB

Peak SAR (extrapolated) = 20.3 W/kg

SAR(1 g) = 8.92 W/kg; SAR(10 g) = 4.78 W/kg

Maximum value of SAR (measured) = 10.7 W/kg

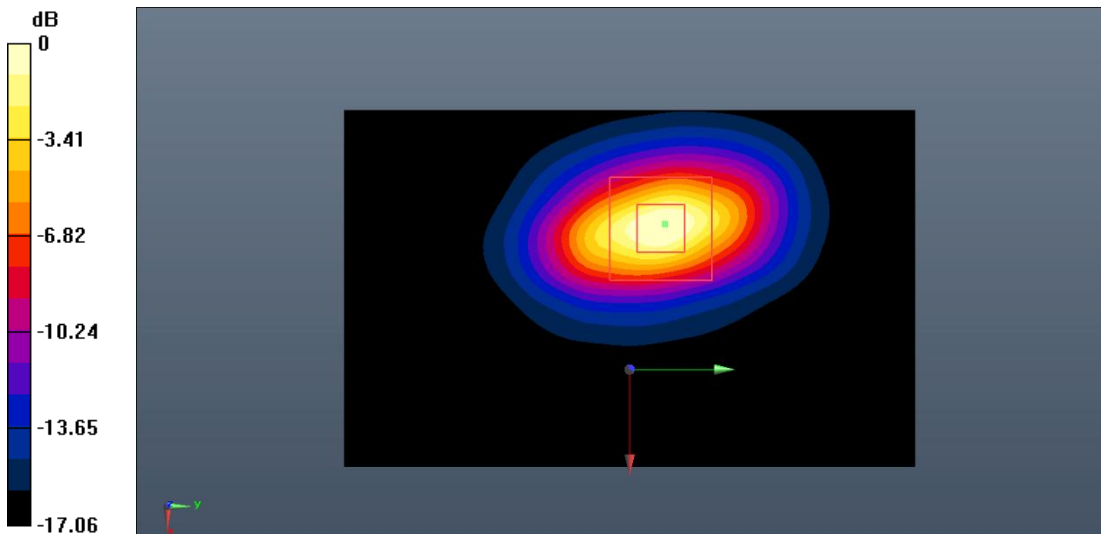

0 dB = 10.7 W/kg = 10.29 dB W/kg

Fig.B.3. Validation 1750MHz 250mW

1900MHz

Date: 2021-8-16

Electronics: DAE4 Sn1527

Medium: Head 1900MHz

Medium parameters used: $f = 1900$ MHz; $\sigma = 1.385$ S/m; $\epsilon_r = 39.229$; $\rho = 1000$ kg/m³

Communication System: CW_TMC Frequency: 1900 MHz Duty Cycle: 1:1

Probe: EX3DV4 – SN7621 ConvF (8.77, 8.77, 8.77);

System Validation /Area Scan (91x91x1): Interpolated grid: dx=1.000 mm, dy=1.000 mm

Reference Value = 81.042 V/m; Power Drift = -0.05 dB

SAR(1 g) = 10.0 W/kg; SAR(10 g) = 5.22 W/kg

Maximum value of SAR (interpolated) = 12.1 W/kg

System Validation /Zoom Scan (7x7x7)/Cube0: Measurement grid: dx=5mm, dy=5mm, dz=5mm

Reference Value = 81.042 V/m; Power Drift = -0.05 dB

Peak SAR (extrapolated) = 24.2 W/kg

SAR(1 g) = 9.83 W/kg; SAR(10 g) = 5.15 W/kg

Maximum value of SAR (measured) = 11.9 W/kg

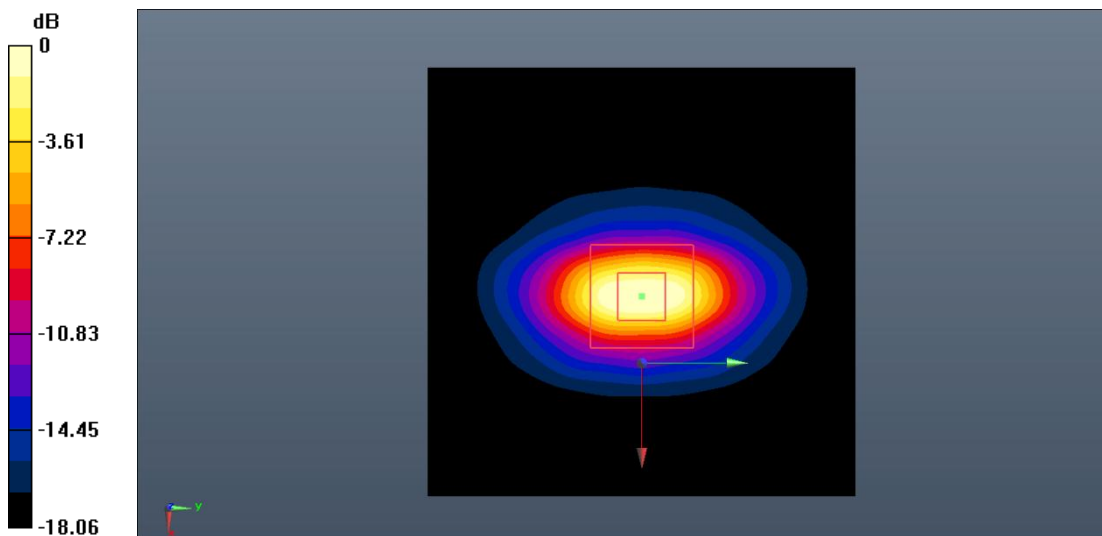

0 dB = 11.9 W/kg = 10.76 dB W/kg

Fig.B.4. Validation 1900MHz 250mW

2450MHz

Date: 2021-8-8

Electronics: DAE4 Sn1527

Medium: Head 2450MHz

Medium parameters used: $f = 2450 \text{ MHz}$; $\sigma = 1.849 \text{ S/m}$; $\epsilon_r = 38.441$; $\rho = 1000 \text{ kg/m}^3$

Communication System: CW_TMC Frequency: 2450 MHz Duty Cycle: 1:1

Probe: EX3DV4 – SN7621 ConvF (8.01, 8.01, 8.01);

System Validation /Area Scan (81x121x1): Interpolated grid: $dx=1.000 \text{ mm}$, $dy=1.000 \text{ mm}$

Reference Value = 92.014 V/m; Power Drift = 0.01 dB

SAR(1 g) = 13.3 W/kg; SAR(10 g) = 6.07 W/kg

Maximum value of SAR (interpolated) = 15.3 W/kg

System Validation /Zoom Scan (7x7x7)/Cube0: Measurement grid: $dx=5\text{mm}$, $dy=5\text{mm}$, $dz=5\text{mm}$

Reference Value = 92.014 V/m; Power Drift = 0.01 dB

Peak SAR (extrapolated) = 34.6 W/kg

SAR(1 g) = 13.6 W/kg; SAR(10 g) = 6.19 W/kg

Maximum value of SAR (measured) = 15.5 W/kg

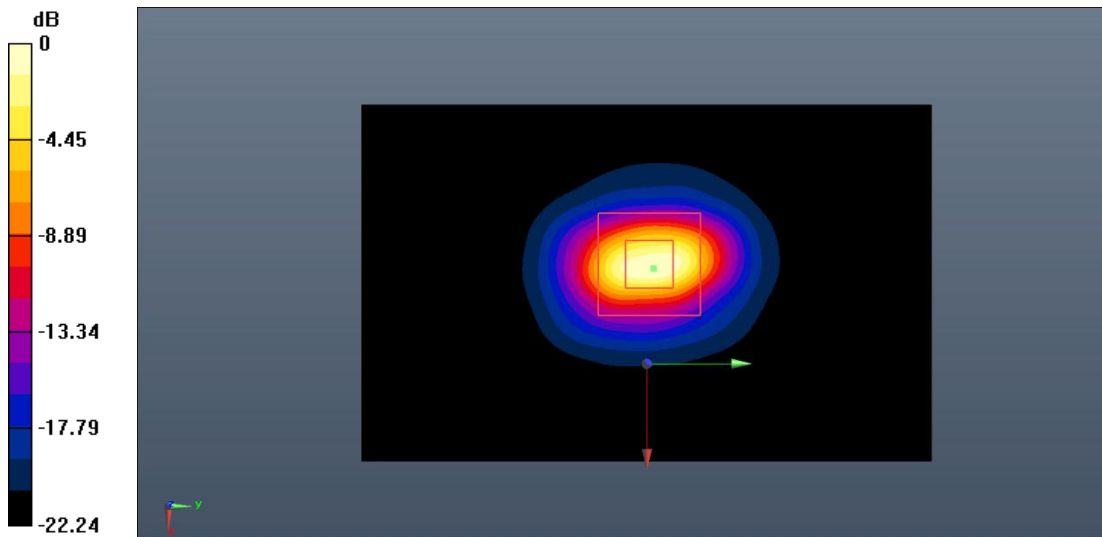

0 dB = 15.5 W/kg = 11.90 dB W/kg

Fig.B.5. Validation 2450MHz 250mW

2550MHz

Date: 2021-8-13

Electronics: DAE4 Sn1527

Medium: Head 2550MHz

Medium parameters used: $f = 2550 \text{ MHz}$; $\sigma = 1.946 \text{ S/m}$; $\epsilon_r = 37.978$; $\rho = 1000 \text{ kg/m}^3$

Communication System: CW_TMC Frequency: 2550 MHz Duty Cycle: 1:1

Probe: EX3DV4 – SN7621 ConvF (8.01, 8.01, 8.01);

System Validation /Area Scan (91x91x1): Interpolated grid: $dx=1.000 \text{ mm}$, $dy=1.000 \text{ mm}$

Reference Value = 93.815 V/m; Power Drift = 0.10 dB

SAR(1 g) = 14.1 W/kg; SAR(10 g) = 6.31 W/kg

Maximum value of SAR (interpolated) = 16.0 W/kg

System Validation /Zoom Scan (7x7x7)/Cube0: Measurement grid: $dx=5\text{mm}$, $dy=5\text{mm}$, $dz=5\text{mm}$

Reference Value = 93.815 V/m; Power Drift = 0.10 dB

Peak SAR (extrapolated) = 37.1 W/kg

SAR(1 g) = 14.4 W/kg; SAR(10 g) = 6.42 W/kg

Maximum value of SAR (measured) = 16.3 W/kg

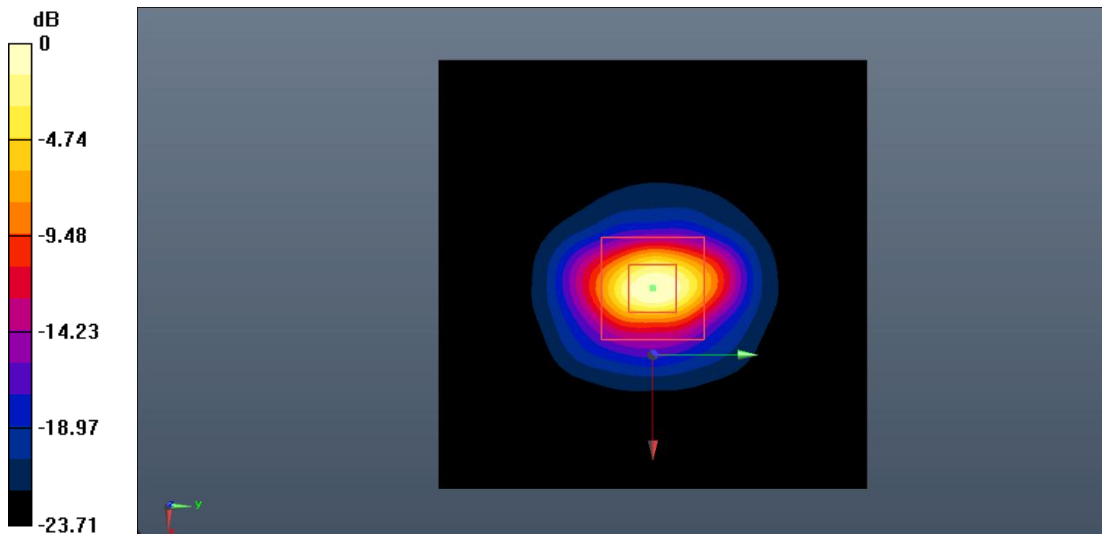

0 dB = 16.3 W/kg = 12.12 dB W/kg

Fig.B.6. Validation 2550MHz 250mW

5250MHz

Date: 2021-8-10

Electronics: DAE4 Sn1527

Medium: Head 5250MHz

Medium parameters used: $f = 5250$ MHz; $\sigma = 4.652$ S/m; $\epsilon_r = 36.536$; $\rho = 1000$ kg/m³

Communication System: CW Frequency: 5250 MHz Duty Cycle: 1:1

Probe: EX3DV4 – SN7621 ConvF (5.97, 5.97, 5.97);

System Validation /Area Scan (61x91x1): Interpolated grid: dx=1.000 mm, dy=1.000 mm

Reference Value = 63.715 V/m; Power Drift = -0.09 dB

SAR(1 g) = 7.73 W/kg; SAR(10 g) = 2.21 W/kg

Maximum value of SAR (interpolated) = 9.89 W/kg

System Validation /Zoom Scan (8x8x21)/Cube0: Measurement grid: dx=4mm, dy=4mm, dz=1.4mm

Reference Value = 63.715 V/m; Power Drift = -0.09 dB

Peak SAR (extrapolated) = 22.6 W/kg

SAR(1 g) = 7.52 W/kg; SAR(10 g) = 2.18 W/kg

Maximum value of SAR (measured) = 9.81 W/kg

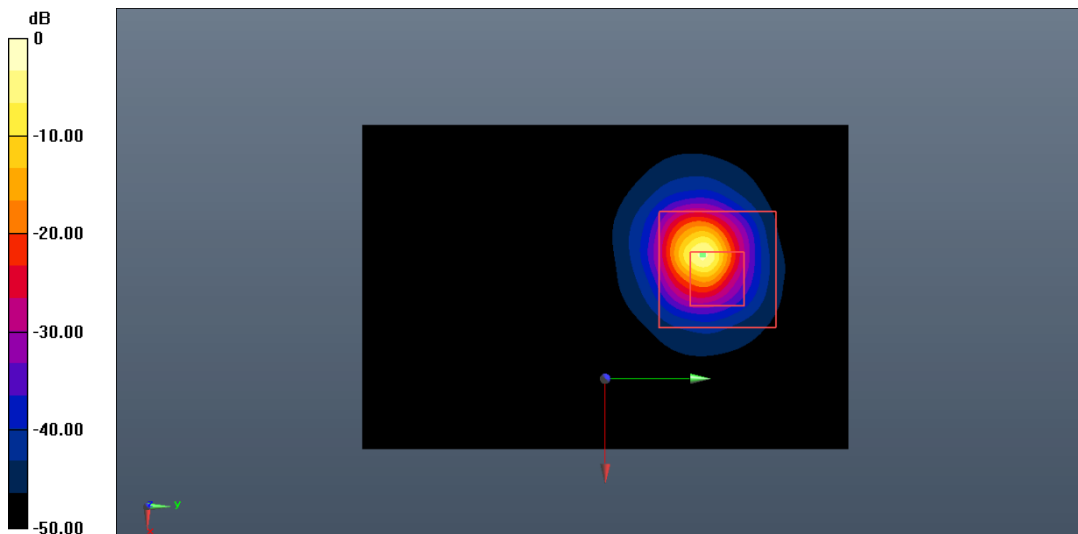

0 dB = 9.81 W/kg = 9.92 dB W/kg

Fig.B.7. Validation 5250MHz 100mW

5600MHz

Date: 2021-8-10

Electronics: DAE4 Sn1527

Medium: Head 5600MHz

Medium parameters used: $f = 5600$ MHz; $\sigma = 5.143$ S/m; $\epsilon_r = 35.153$; $\rho = 1000$ kg/m³

Communication System: CW Frequency: 5600 MHz Duty Cycle: 1:1

Probe: EX3DV4 – SN7621 ConvF (5.43, 5.43, 5.43);

System Validation /Area Scan (61x91x1): Interpolated grid: dx=1.000 mm, dy=1.000 mm

Reference Value = 66.513 V/m; Power Drift = 0.02 dB

SAR(1 g) = 8.04 W/kg; SAR(10 g) = 2.26 W/kg

Maximum value of SAR (interpolated) = 10.0 W/kg

System Validation /Zoom Scan (8x8x21)/Cube0: Measurement grid: dx=4mm, dy=4mm, dz=1.4mm

Reference Value = 66.513 V/m; Power Drift = 0.02 dB

Peak SAR (extrapolated) = 25.9 W/kg

SAR(1 g) = 8.25 W/kg; SAR(10 g) = 2.33 W/kg

Maximum value of SAR (measured) = 10.2 W/kg

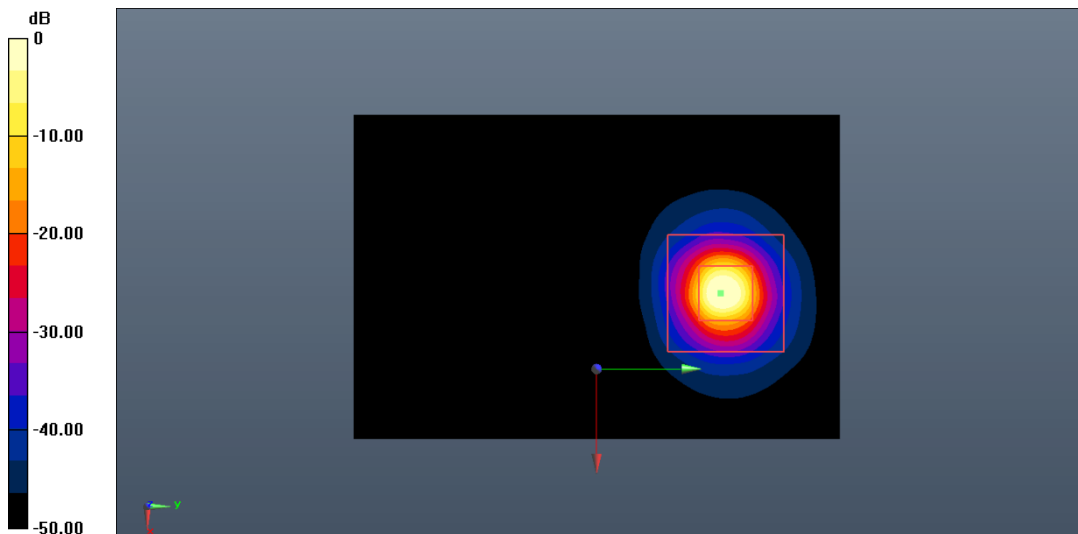

0 dB = 10.2 W/kg = 10.09 dB W/kg

Fig.B.8. Validation 5600MHz 100mW

5750MHz

Date: 2021-8-10

Electronics: DAE4 Sn1527

Medium: Head 5750 MHz

Medium parameters used: $f = 5750$ MHz; $\sigma = 5.309$ S/m; $\epsilon_r = 34.823$; $\rho = 1000$ kg/m³

Communication System: CW Frequency: 5750 MHz Duty Cycle: 1:1

Probe: EX3DV4 – SN7621 ConvF (5.38, 5.38, 5.38);

System Validation /Area Scan (61x91x1): Interpolated grid: dx=1.000 mm, dy=1.000 mm

Reference Value = 65.654 V/m; Power Drift = 0.08 dB

SAR(1 g) = 7.97 W/kg; SAR(10 g) = 2.23 W/kg

Maximum value of SAR (interpolated) = 10.1 W/kg

System Validation /Zoom Scan (8x8x21)/Cube0: Measurement grid: dx=4mm, dy=4mm, dz=1.4mm

Reference Value = 65.654 V/m; Power Drift = 0.08 dB

Peak SAR (extrapolated) = 25.3 W/kg

SAR(1 g) = 8.14 W/kg; SAR(10 g) = 2.26 W/kg

Maximum value of SAR (measured) = 10.2 W/kg

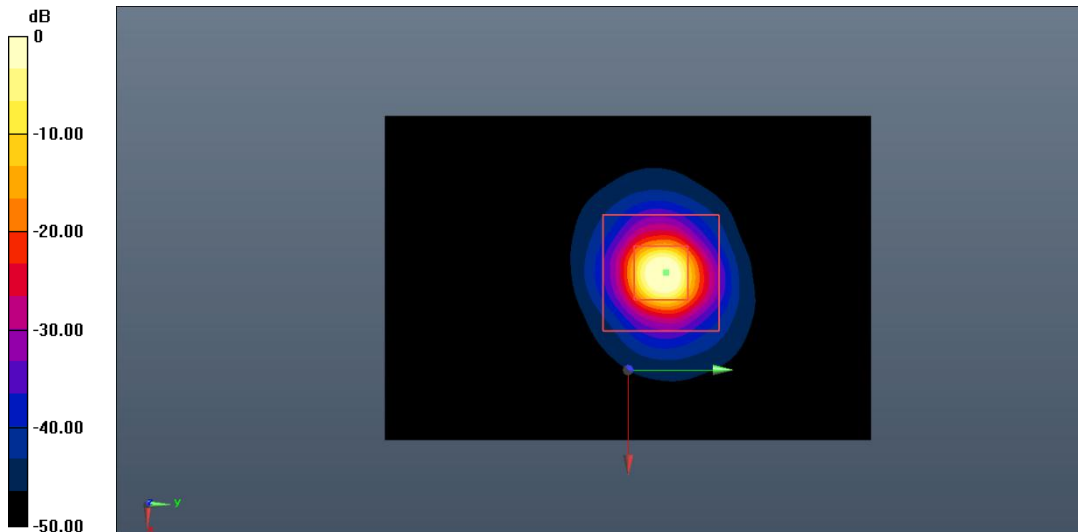

0 dB = 10.2 W/kg = 10.09 dB W/kg

Fig.B.9. Validation 5750MHz 100mW

ANNEX C: SAR Measurement Setup

C.1. Measurement Set-up

DASY5 system for performing compliance tests is illustrated above graphically. This system consists of the following items:

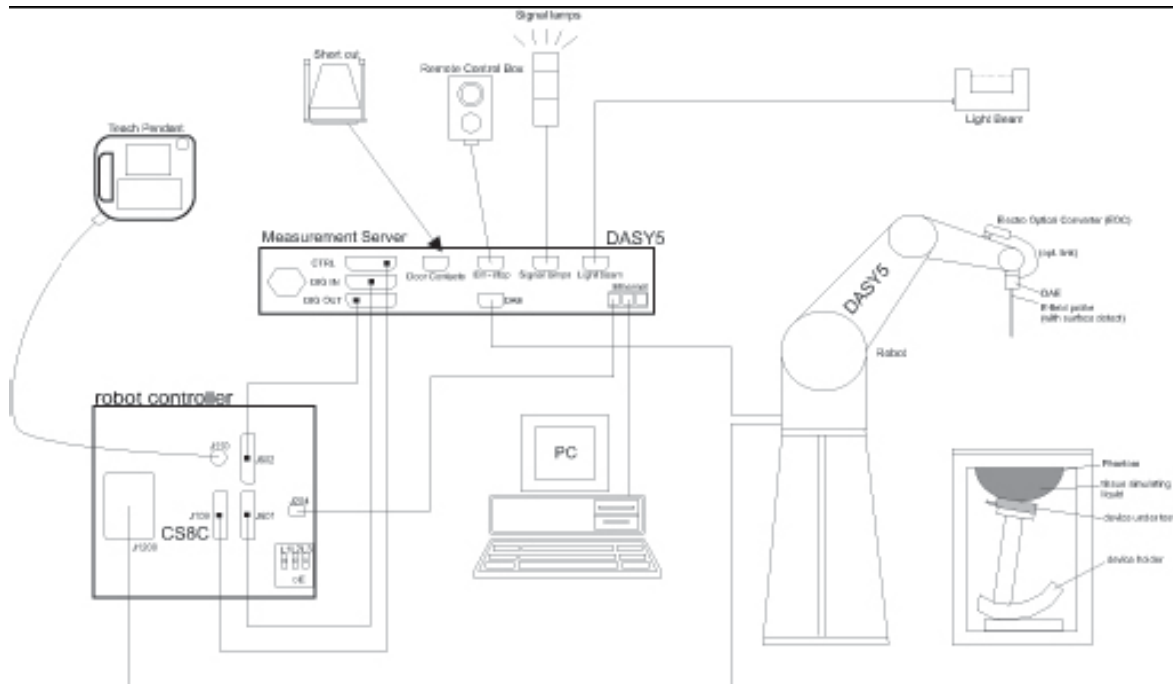

Picture C.1 SAR Lab Test Measurement Set-up

- A standard high precision 6-axis robot (Stäubli TX=RX family) with controller, teach pendant and software. An arm extension for accommodating the data acquisition electronics (DAE).
- An isotropic field probe optimized and calibrated for the targeted measurement.
- A data acquisition electronics (DAE) which performs the signal amplification, signal multiplexing, AD-conversion, offset measurements, mechanical surface detection, collision detection, etc. The unit is battery powered with standard or rechargeable batteries. The signal is optically transmitted to the EOC.
- The Electro-optical converter (EOC) performs the conversion from optical to electrical signals for the digital communication to the DAE. To use optical surface detection, a special version of the EOC is required. The EOC signal is transmitted to the measurement server.
- The function of the measurement server is to perform the time critical tasks such as signal filtering, control of the robot operation and fast movement interrupts.
- The Light Beam used is for probe alignment. This improves the (absolute) accuracy of the probe positioning.
- A computer running WinXP and the DASY5 software.
- Remote control and teach pendant as well as additional circuitry for robot safety such as
- warning lamps, etc.
- The phantom, the device holder and other accessories according to the targeted measurement.

C.2. DASY5 E-field Probe System

The SAR measurements were conducted with the dosimetric probe designed in the classical triangular configuration and optimized for dosimetric evaluation. The probe is constructed using the thick film technique; with printed resistive lines on ceramic substrates. The probe is equipped with an optical multifiber line ending at the front of the probe tip. It is connected to the EOC box on the robot arm and provides an automatic detection of the phantom surface. Half of the fibers are connected to a pulsed infrared transmitter, the other half to a synchronized receiver. As the probe approaches the surface, the reflection from the surface produces a coupling from the transmitting to the receiving fibers. This reflection increases first during the approach, reaches maximum and then decreases. If the probe is flatly touching the surface, the coupling is zero. The distance of the coupling maximum to the surface is independent of the surface reflectivity and largely independent of the surface to probe angle. The DASY5 software reads the reflection during a software approach and looks for the maximum using 2nd order curve fitting. The approach is stopped at reaching the maximum.

Probe Specifications:

Model:	ES3DV3, EX3DV4
Frequency	10MHz — 6.0GHz(EX3DV4)
Range:	10MHz — 4GHz(ES3DV3)
Calibration:	In head and body simulating tissue at Frequencies from 835 up to 5800MHz
Linearity:	± 0.2 dB(30 MHz to 6 GHz) for EX3DV4 ± 0.2 dB(30 MHz to 4 GHz) for ES3DV3
Dynamic Range:	10 mW/kg — 100W/kg
Probe Length:	330 mm
Probe Tip	
Length:	20 mm
Body Diameter:	12 mm
Tip Diameter:	2.5 mm (3.9 mm for ES3DV3)
Tip-Center:	1 mm (2.0mm for ES3DV3)
Application:	SAR Dosimetry Testing Compliance tests of mobile phones Dosimetry in strong gradient fields



Picture C.2 Near-field Probe



Picture C.3 E-field Probe

C.3. E-field Probe Calibration

Each E-Probe/Probe Amplifier combination has unique calibration parameters. A TEM cell calibration procedure is conducted to determine the proper amplifier settings to enter in the probe parameters. The amplifier settings are determined for a given frequency by subjecting the probe to a known E-field density (1 mW/cm²) using an RF Signal generator, TEM cell, and RF Power Meter.

The free space E-field from amplified probe outputs is determined in a test chamber. This calibration can be performed in a TEM cell if the frequency is below 1 GHz and in a waveguide or other methodologies above 1 GHz for free space. For the free space calibration, the probe is placed in the volumetric center of the cavity and at the proper orientation with the field. The probe is then rotated 360 degrees until the three channels show the maximum reading. The power density readings equate to 1 mW/cm².

E-field temperature correlation calibration is performed in a flat phantom filled with the appropriate simulated brain tissue. The E-field in the medium correlates with the temperature rise in the dielectric medium. For temperature correlation calibration a RF transparent thermistor-based temperature probe is used in conjunction with the E-field probe.

$$SAR = C \frac{\Delta T}{\Delta t}$$

Where:

Δt = Exposure time (30 seconds),

C = Heat capacity of tissue (brain or muscle),

ΔT = Temperature increase due to RF exposure.

$$SAR = \frac{|E|^2 \cdot \sigma}{\rho}$$

Where:

σ = Simulated tissue conductivity,

ρ = Tissue density (kg/m³).

C.4. Other Test Equipment

C.4.1. Data Acquisition Electronics (DAE)

The data acquisition electronics consist of a highly sensitive electrometer-grade preamplifier with auto-zeroing, a channel and gain-switching multiplexer, a fast 16 bit AD-converter and a command decoder with a control logic unit. Transmission to the measurement server is accomplished through an optical downlink for data and status information, as well as an optical uplink for commands and the clock.

The mechanical probe mounting device includes two different sensor systems for frontal and sideways probe contacts. They are used for mechanical surface detection and probe collision detection.

The input impedance of the DAE is 200 MOhm; the inputs are symmetrical and floating. Common mode rejection is above 80 dB.



PictureC.4: DAE

C.4.2. Robot

The SPEAG DASY system uses the high precision robots (DASY5: RX160L) type from Stäubli SA (France). For the 6-axis controller system, the robot controller version from Stäubli is used. The Stäubli robot series have many features that are important for our application:

- High precision (repeatability 0.02mm)
- High reliability (industrial design)
- Low maintenance costs (virtually maintenance free due to direct drive gears; no belt drives)
- Jerk-free straight movements (brushless synchron motors; no stepper motors)
- Low ELF interference (motor control fields shielded via the closed metallic construction shields)



Picture C.5 DASY 5

C.4.3. Measurement Server

The Measurement server is based on a PC/104 CPU board with CPU (DASY5: 400 MHz, Intel Celeron), chipdisk (DASY5:128MB), RAM (DASY5:128MB). The necessary circuits for communication with the DAE electronic box, as well as the 16 bit AD converter system for optical detection and digital I/O interface are contained on the DASY I/O board, which is directly connected to the PC/104 bus of the CPU board.

The measurement server performs all real-time data evaluation of field measurements and surface detection, controls robot movements and handles safety operation. The PC operating system cannot interfere with these time critical processes. All connections are supervised by a watchdog, and disconnection of any of the cables to the measurement server will automatically disarm the robot and disable all program-controlled robot movements. Furthermore, the measurement server is equipped with an expansion port which is reserved for future applications. Please note that this expansion port does not have a standardized pinout, and therefore only devices provided by SPEAG can be connected. Devices from any other supplier could seriously damage the measurement server.



Picture C.6 Server for DASY 5

C.4.4. Device Holder for Phantom

The SAR in the phantom is approximately inversely proportional to the square of the distance between the source and the liquid surface. For a source at 5mm distance, a positioning uncertainty of $\pm 0.5\text{mm}$ would produce a SAR uncertainty of $\pm 20\%$. Accurate device positioning is therefore crucial for accurate and repeatable measurements. The positions in which the devices must be measured are defined by the standards.

The DASY device holder is designed to cope with the different positions given in the standard. It has two scales for device rotation (with respect to the body axis) and device inclination (with respect to the line between the ear reference points). The rotation centers for both scales is the ear reference point (ERP). Thus the device needs no repositioning when changing the angles.

The DASY device holder is constructed of low-loss POM material having the following dielectric

parameters: relative permittivity $\epsilon = 3$ and loss tangent $\delta = 0.02$. The amount of dielectric material has been reduced in the closest vicinity of the device, since measurements have suggested that the influence of the clamp on the test results could thus be lowered.

<Laptop Extension Kit>

The extension is lightweight and made of POM, acrylic glass and foam. It fits easily on the upper part of the Mounting Device in place of the phone positioner. The extension is fully compatible with the Twin-SAM and ELI phantoms.



Picture C.7-1: Device Holder



Picture C.7-2: Laptop Extension Kit

C.4.5. Phantom

The SAM Twin Phantom V4.0 is constructed of a fiberglass shell integrated in a table. The shape of the shell is based on data from an anatomical study designed to represent the 90th percentile of the population. The phantom enables the dissymmetric evaluation of SAR for both left and right handed handset usage, as well as body-worn usage using the flat phantom region. Reference markings on the Phantom allow the complete setup of all predefined phantom positions and measurement grids by manually teaching three points in the robot. The shell phantom has a 2mm shell thickness (except the ear region where shell thickness increases to 6 mm).

Shell Thickness: 2 ± 0.2 mm
Filling Volume: Approx. 25 liters
Dimensions: 810 x 1000 x 500 mm (H x L x W)
Available: Special



Picture C.8: SAM Twin Phantom

ANNEX D: Position of the wireless device in relation to the phantom

D.1. General considerations

This standard specifies two handset test positions against the head phantom – the “cheek” position and the “tilt” position.

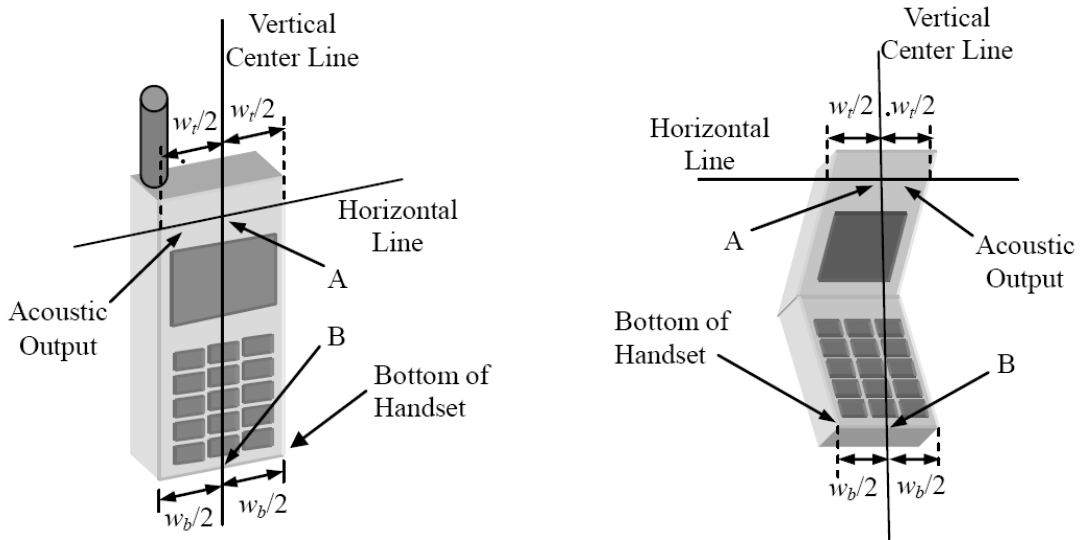

- w_t Width of the handset at the level of the acoustic
- w_b Width of the bottom of the handset
- A Midpoint of the width w_t of the handset at the level of the acoustic output
- B Midpoint of the width w_b of the bottom of the handset

Picture D.1-a Typical “fixed” case handset Picture D.1-b Typical “clam-shell” case handset

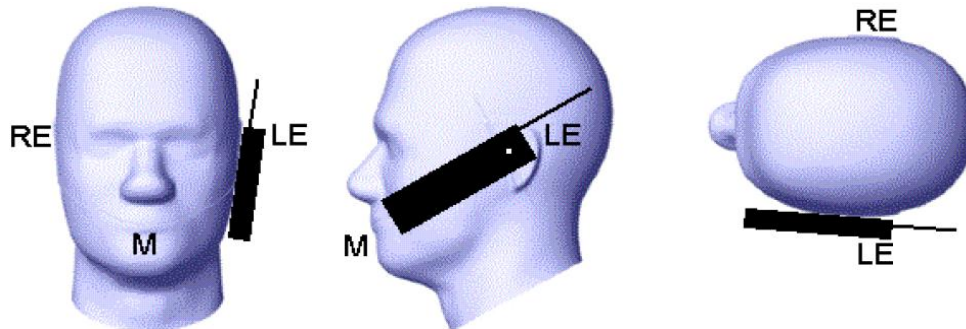

Picture D.2 Cheek position of the wireless device on the left side of SAM

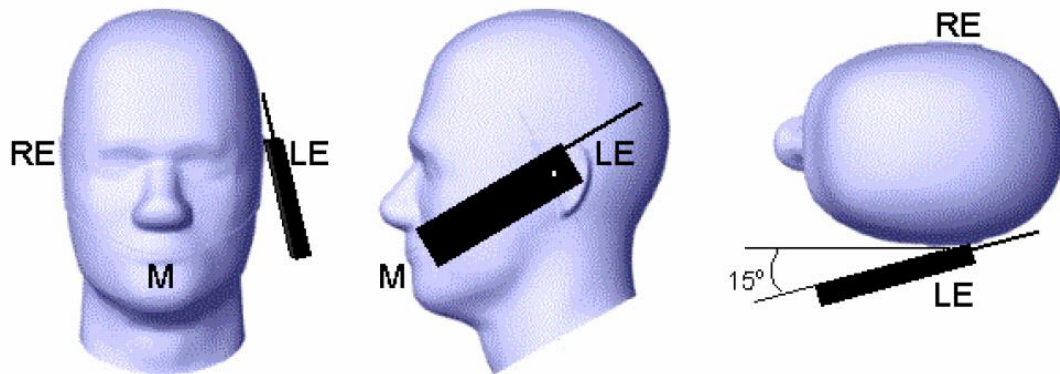

Picture D.3 Tilt position of the wireless device on the left side of SAM

D.2. Body-worn device

A typical example of a body-worn device is a mobile phone, wireless enabled PDA or other battery operated wireless device with the ability to transmit while mounted on a person's body using a carry accessory approved by the wireless device manufacturer.

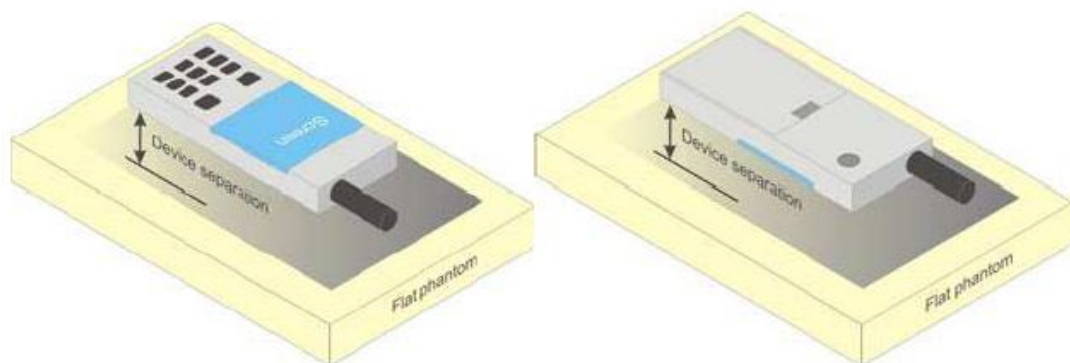

Picture D.4 Test positions for body-worn devices

D.3. Desktop device

A typical example of a desktop device is a wireless enabled desktop computer placed on a table or desk when used.

The DUT shall be positioned at the distance and in the orientation to the phantom that corresponds to the intended use as specified by the manufacturer in the user instructions. For devices that employ an external antenna with variable positions, tests shall be performed for all antenna positions specified. Picture 8.5 show positions for desktop device SAR tests. If the intended use is not specified, the device shall be tested directly against the flat phantom.

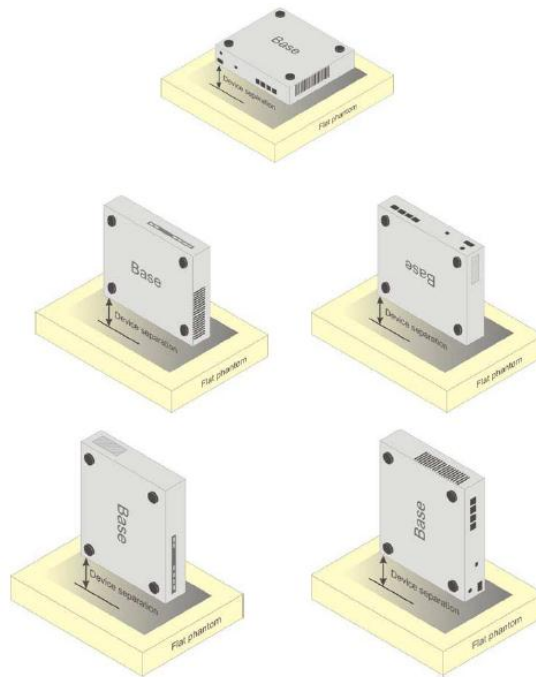

Picture D.5 Test positions for desktop devices

D.4. DUT Setup Photos

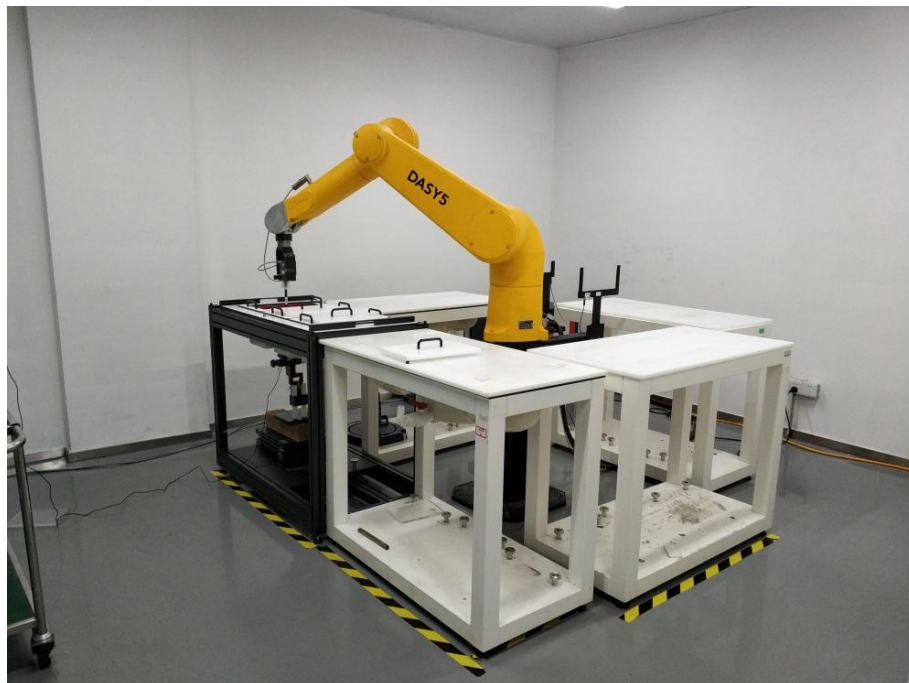

Picture D.6

ANNEX E: Equivalent Media Recipes

The liquid used for the frequency range of 700-6000 MHz consisted of water, sugar, salt, preventol, glycol monobutyl and Cellulose. The liquid has been previously proven to be suited for worst-case. The Table E.1 shows the detail solution. It's satisfying the latest tissue dielectric parameters requirements proposed by the IEEE 1528 and IEC 62209.

Table E.1: Composition of the Tissue Equivalent Matter

Frequency (MHz)	835	1750	1900	2450	2600	5200	5800
Water	41.45	55.242	55.242	58.79	58.79	65.53	66.10
Sugar	56.0	/	/	/	/	/	/
Salt	1.45	0.306	0.306	0.06	0.06		
Preventol	0.1	/	/	/	/	17.24	16.95
Cellulose	1.0	/	/	/	/	17.24	16.95
Glycol Monobutyl	/	44.452	44.452	41.15	41.15	/	/
Diethylenglycol monohexylether	/	/	/	/	/	/	/
Triton X-100	/	/	/	/	/	/	/
Dielectric Parameters Target Value	$\epsilon=41.5$ $\sigma=0.90$	$\epsilon=40.08$ $\sigma=1.37$	$\epsilon=40.0$ $\sigma=1.40$	$\epsilon=39.20$ $\sigma=1.80$	$\epsilon=39.01$ $\sigma=1.96$	$\epsilon=35.99$ $\sigma=4.66$	$\epsilon=35.30$ $\sigma=5.27$

Note: There is a little adjustment respectively for 750, 5300 and 5600, based on the recipe of closest frequency in table E.1

ANNEX F: System Validation

The SAR system must be validated against its performance specifications before it is deployed. When SAR probes, system components or software are changed, upgraded or recalibrated, these must be validated with the SAR system(s) that operates with such components.

Table F.1: System Validation

Probe SN.	Liquid name	Validation date	Frequency point	Status (OK or Not)
7621	Head 750MHz	2020-12-02	750 MHz	OK
7621	Head 835MHz	2020-04-03	835 MHz	OK
7621	Head 1750MHz	2020-10-20	1750 MHz	OK
7621	Head 1900MHz	2020-12-02	1900 MHz	OK
7621	Head 2300MHz	2020-12-03	2300 MHz	OK
7621	Head 2450MHz	2020-12-03	2450 MHz	OK
7621	Head 2550MHz	2020-12-03	2550 MHz	OK
7621	Head 5200MHz	2020-12-04	5250 MHz	OK
7621	Head 5600MHz	2020-12-04	5600 MHz	OK
7621	Head 5750MHz	2020-12-04	5750 MHz	OK



ANNEX G: DAE Calibration Certificate



Add: No.51 Xueyuan Road, Haidian District, Beijing, 100191, China
Tel: +86-10-62304633-2512 Fax: +86-10-62304633-2504
E-mail: cttl@chinattl.com Http://www.chinattl.cn



中国认可
国际互认
校准
CALIBRATION
CNAS L0570

Client : CTTL(South Branch)

Certificate No: Z20-60433

CALIBRATION CERTIFICATE

Object: DAE4 - SN: 1527

Calibration Procedure(s): FF-Z11-002-01
Calibration Procedure for the Data Acquisition Electronics (DAEx)

Calibration date: November 06, 2020

This calibration Certificate documents the traceability to national standards, which realize the physical units of measurements(SI). The measurements and the uncertainties with confidence probability are given on the following pages and are part of the certificate.

All calibrations have been conducted in the closed laboratory facility: environment temperature(22±3)°C and humidity<70%.

Calibration Equipment used (M&TE critical for calibration)

Primary Standards	ID #	Cal Date(Calibrated by, Certificate No.)	Scheduled Calibration
Process Calibrator 753	1971018	16-Jun-20 (CTTL, No.J20X04342)	Jun-21

	Name	Function	Signature
Calibrated by:	Yu Zongying	SAR Test Engineer	
Reviewed by:	Lin Hao	SAR Test Engineer	
Approved by:	Qi Dianyuan	SAR Project Leader	

Issued: November 08, 2020

This calibration certificate shall not be reproduced except in full without written approval of the laboratory.



Add: No.51 Xueyuan Road, Haidian District, Beijing, 100191, China
Tel: +86-10-62304633-2512 Fax: +86-10-62304633-2504
E-mail: cttl@chinattl.com Http://www.chinattl.cn

Glossary:

DAE data acquisition electronics
Connector angle information used in DASY system to align probe sensor X to the robot coordinate system.

Methods Applied and Interpretation of Parameters:

- *DC Voltage Measurement:* Calibration Factor assessed for use in DASY system by comparison with a calibrated instrument traceable to national standards. The figure given corresponds to the full scale range of the voltmeter in the respective range.
- *Connector angle:* The angle of the connector is assessed measuring the angle mechanically by a tool inserted. Uncertainty is not required.
- The report provide only calibration results for DAE, it does not contain other performance test results.



Add: No.51 Xueyuan Road, Haidian District, Beijing, 100191, China
Tel: +86-10-62304633-2512 Fax: +86-10-62304633-2504
E-mail: cttl@chinattl.com Http://www.chinattl.cn

DC Voltage Measurement

A/D - Converter Resolution nominal
High Range: 1LSB = 6.1μV, full range = -100...+300 mV
Low Range: 1LSB = 61nV, full range = -1.....+3mV
DASY measurement parameters: Auto Zero Time: 3 sec; Measuring time: 3 sec

Calibration Factors	X	Y	Z
High Range	403.863 ± 0.15% (k=2)	403.582 ± 0.15% (k=2)	403.801 ± 0.15% (k=2)
Low Range	3.95875 ± 0.7% (k=2)	3.98892 ± 0.7% (k=2)	3.96720 ± 0.7% (k=2)

Connector Angle

Connector Angle to be used in DASY system	223.5° ± 1 °
---	--------------



ANNEX H: Probe Calibration Certificate

Probe EX3DV4-SN: 7621 Calibration Certificate (2020-11-30)



In Collaboration with
s p e a g
CALIBRATION LABORATORY



中国认可
国际互认
校准
CALIBRATION
CNAS L0570

Add: No.51 Xueyuan Road, Haidian District, Beijing, 100191, China
Tel: +86-10-62304633-2512 Fax: +86-10-62304633-2504
E-mail: cttl@chinattl.com [Http://www.chinattl.cn](http://www.chinattl.cn)

Client **CTTL(South Branch)**

Certificate No: **Z20-60434**

CALIBRATION CERTIFICATE			
Object	EX3DV4 - SN : 7621		
Calibration Procedure(s)	FF-Z11-004-02 Calibration Procedures for Dosimetric E-field Probes		
Calibration date:	November 30, 2020		
This calibration Certificate documents the traceability to national standards, which realize the physical units of measurements(SI). The measurements and the uncertainties with confidence probability are given on the following pages and are part of the certificate.			
All calibrations have been conducted in the closed laboratory facility: environment temperature(22±3)°C and humidity<70%.			
Calibration Equipment used (M&TE critical for calibration)			
Primary Standards	ID #	Cal Date(Calibrated by, Certificate No.)	Scheduled Calibration
Power Meter NRP2	101919	16-Jun-20(CTTL, No.J20X04344)	Jun-21
Power sensor NRP-Z91	101547	16-Jun-20(CTTL, No.J20X04344)	Jun-21
Power sensor NRP-Z91	101548	16-Jun-20(CTTL, No.J20X04344)	Jun-21
Reference 10dBAttenuator	18N50W-10dB	10-Feb-20(CTTL, No.J20X00525)	Feb-22
Reference 20dBAttenuator	18N50W-20dB	10-Feb-20(CTTL, No.J20X00526)	Feb-22
Reference Probe EX3DV4	SN 7307	29-May-20(SPEAG, No.EX3-7307_May20)	May-21
DAE4	SN 1556	4-Feb-20(SPEAG, No.DAE4-1556_Feb20)	Feb-21
Secondary Standards	ID #	Cal Date(Calibrated by, Certificate No.)	Scheduled Calibration
SignalGenerator MG3700A	6201052605	23-Jun-20(CTTL, No.J20X04343)	Jun-21
Network Analyzer E5071C	MY46110673	10-Feb-20(CTTL, No.J20X00515)	Feb-21
Calibrated by:	Name Yu Zongying	Function SAR Test Engineer	Signature
Reviewed by:	Name Lin Hao	Function SAR Test Engineer	Signature
Approved by:	Name Qi Dianyuan	Function SAR Project Leader	Signature
Issued: December 02, 2020			
This calibration certificate shall not be reproduced except in full without written approval of the laboratory.			