



SAR TEST REPORT

No. I18Z62361-SEM01

For

HMD Global OY

**Multi-band GSM/WCDMA/LTE phone with Bluetooth, WLAN GSM
850,900,1800,1900 WCDMA : 1,2,4,5,8 LTE : 1,2, 3,4,5,7,8,12/17,28,38,66
mobile phone, Bluetooth 4.2, WIFI 802.11 b/g/n**

Model name: TA-1133

With

Hardware Version: 89571_1_12

Software Version: 00XX_1_XXX

FCC ID: 2AJOTTA-1133

Issued Date: 2019-2-1



Note:

The test results in this test report relate only to the devices specified in this report. This report shall not be reproduced except in full without the written approval of CTTL.

The report must not be used by the client to claim product certification, approval, or endorsement by NVLAP, NIST, or any agency of the U.S. Government.

Test Laboratory:

CTTL, Telecommunication Technology Labs, CAICT

No. 51, Xueyuan Road, Haidian District, Beijing, P. R. China 100191.

Tel:+86(0)10-62304633-2512, Fax:+86(0)10-62304633-2504

Email: ctl_terminals@caict.ac.cn, website: www.caict.ac.cn



REPORT HISTORY

Report Number	Revision	Issue Date	Description
I18Z62361-SEM01	Rev.0	2019-2-1	Initial creation of test report



TABLE OF CONTENT

1 TEST LABORATORY	5
1.1 TESTING LOCATION	5
1.2 TESTING ENVIRONMENT.....	5
1.3 PROJECT DATA	5
1.4 SIGNATURE.....	5
2 STATEMENT OF COMPLIANCE	6
3 CLIENT INFORMATION.....	8
3.1 APPLICANT INFORMATION	8
3.2 MANUFACTURER INFORMATION	8
4 EQUIPMENT UNDER TEST (EUT) AND ANCILLARY EQUIPMENT (AE)	9
4.1 ABOUT EUT	9
4.2 INTERNAL IDENTIFICATION OF EUT USED DURING THE TEST	10
4.3 INTERNAL IDENTIFICATION OF AE USED DURING THE TEST.....	10
5 TEST METHODOLOGY	11
5.1 APPLICABLE LIMIT REGULATIONS	11
5.2 APPLICABLE MEASUREMENT STANDARDS.....	11
6 SPECIFIC ABSORPTION RATE (SAR).....	12
6.1 INTRODUCTION.....	12
6.2 SAR DEFINITION.....	12
7 TISSUE SIMULATING LIQUIDS.....	13
7.1 TARGETS FOR TISSUE SIMULATING LIQUID	13
7.2 DIELECTRIC PERFORMANCE	13
8 SYSTEM VERIFICATION.....	20
8.1 SYSTEM SETUP.....	20
8.2 SYSTEM VERIFICATION.....	21
9 MEASUREMENT PROCEDURES	22
9.1 TESTS TO BE PERFORMED	22
9.2 GENERAL MEASUREMENT PROCEDURE.....	24
9.3 WCDMA MEASUREMENT PROCEDURES FOR SAR	25
9.4 SAR MEASUREMENT FOR LTE.....	26
9.5 BLUETOOTH & WI-FI MEASUREMENT PROCEDURES FOR SAR	28
9.6 POWER DRIFT.....	28
10 AREA SCAN BASED 1-G SAR	29
10.1 REQUIREMENT OF KDB.....	29
10.2 FAST SAR ALGORITHMS	29
11 CONDUCTED OUTPUT POWER.....	30



11.1 GSM MEASUREMENT RESULT	30
11.2 WCDMA MEASUREMENT RESULT.....	32
11.3 LTE MEASUREMENT RESULT	34
11.4 WI-FI AND BT MEASUREMENT RESULT	57
12 SIMULTANEOUS TX SAR CONSIDERATIONS	58
12.1 INTRODUCTION.....	58
12.2 TRANSMIT ANTENNA SEPARATION DISTANCES	58
12.3 SAR MEASUREMENT POSITIONS	59
12.4 STANDALONE SAR TEST EXCLUSION CONSIDERATIONS	59
13 EVALUATION OF SIMULTANEOUS.....	60
14 SAR TEST RESULT.....	61
14.1 SAR RESULTS FOR FAST SAR.....	63
14.2 SAR RESULTS FOR STANDARD PROCEDURE	74
14.3 WLAN EVALUATION FOR 2.4G	78
15 SAR MEASUREMENT VARIABILITY.....	81
16 MEASUREMENT UNCERTAINTY	82
16.1 MEASUREMENT UNCERTAINTY FOR NORMAL SAR TESTS (300MHZ~3GHZ)	82
16.2 MEASUREMENT UNCERTAINTY FOR NORMAL SAR TESTS (3~6GHZ)	83
16.3 MEASUREMENT UNCERTAINTY FOR FAST SAR TESTS (300MHZ~3GHZ)	84
16.4 MEASUREMENT UNCERTAINTY FOR FAST SAR TESTS (3~6GHZ).....	85
17 MAIN TEST INSTRUMENTS	86
ANNEX A GRAPH RESULTS.....	87
ANNEX B SYSTEM VERIFICATION RESULTS.....	135
ANNEX C SAR MEASUREMENT SETUP	148
ANNEX D POSITION OF THE WIRELESS DEVICE IN RELATION TO THE PHANTOM	154
ANNEX E EQUIVALENT MEDIA RECIPES	157
ANNEX F SYSTEM VALIDATION	158
ANNEX G PROBE CALIBRATION CERTIFICATE	159
ANNEX H DIPOLE CALIBRATION CERTIFICATE.....	170
ANNEX I SENSOR TRIGGERING DATA SUMMARY	218
ANNEX J ACCREDITATION CERTIFICATE.....	221

1 Test Laboratory

1.1 Testing Location

Company Name:	CTTL(Shouxiang)
Address:	No. 51 Shouxiang Science Building, Xueyuan Road, Haidian District, Beijing, P. R. China100191

1.2 Testing Environment

Temperature:	18°C~25°C,
Relative humidity:	30%~ 70%
Ground system resistance:	< 0.5 Ω
Ambient noise & Reflection:	< 0.012 W/kg

1.3 Project Data

Project Leader:	Qi Dianyuan
Test Engineer:	Lin Xiaojun
Testing Start Date:	January 16, 2019
Testing End Date:	January 21, 2019

1.4 Signature



Lin Xiaojun
(Prepared this test report)

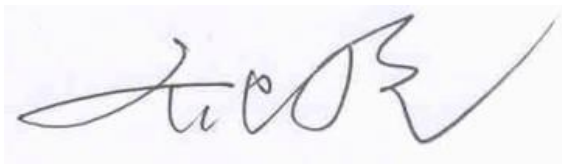

Qi Dianyuan
(Reviewed this test report)

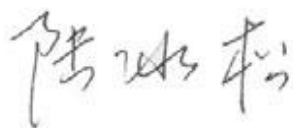

Lu Bingsong
Deputy Director of the laboratory
(Approved this test report)

2 Statement of Compliance

The maximum results of SAR found during testing for HMD Global OY Multi-band GSM/WCDMA/LTE phone with Bluetooth, WLAN GSM 850,900,1800,1900 WCDMA : 1,2,4,5,8 LTE : 1,2,3,4,5,7,8,12/17,28,38,66 mobile phone, Bluetooth 4.2, WIFI 802.11 b/g/n TA-1133 are as follows:

Table 2.1: Highest Reported SAR (1g)

Exposure Configuration	Technology Band	Highest Reported SAR 1g(W/kg)	Equipment Class
Head (Separation Distance 0mm)	GSM 850	0.31	PCE
	PCS 1900	0.11	
	UMTS FDD 5	0.40	
	UMTS FDD 4	0.09	
	UMTS FDD 2	0.20	
	LTE Band 2	0.18	
	LTE Band 5	0.36	
	LTE Band 7	0.17	
	LTE Band 12	0.16	
	LTE Band 38	0.08	
	LTE Band 66	0.09	
	WLAN 2.4 GHz	0.26	
	Hotspot (Separation Distance 10mm)	GSM 850	0.45
PCS 1900		0.33	
UMTS FDD 5		0.60	
UMTS FDD 4		0.89	
UMTS FDD 2		1.03	
LTE Band 2		1.16	
LTE Band 5		0.55	
LTE Band 7		1.05	
LTE Band 12		0.41	
LTE Band 38		0.75	
LTE Band 66		0.97	
WLAN 2.4 GHz		0.10	DTS

The SAR values found for the Mobile Phone are below the maximum recommended levels of 1.6 W/Kg as averaged over any 1g tissue according to the ANSI C95.1-1992.

For body operation, this device has been tested and meets FCC RF exposure guidelines when used with any accessory that contains no metal and which provides a minimum separation distance of 10 mm between this device and the body of the user. Use of other accessories may not ensure compliance with FCC RF exposure guidelines.

The EUT battery must be fully charged and checked periodically during the test to ascertain uniform power output.

The measurement together with the test system set-up is described in annex C of this test report. A detailed description of the equipment under test can be found in chapter 4 of this test report. The highest reported SAR value is obtained at the case of **(Table 2.1)**, and the values are: **1.16 W/kg(1g)**.

Table 2.2: The sum of reported SAR values for main antenna and WiFi

	Position	Main antenna	WiFi	Sum
Highest reported SAR value for Head	Left hand, Touch cheek	0.27	0.26	0.53
	Right hand, Touch cheek	0.40	0.11	0.51
Highest reported SAR value for Body	Front	1.03	0.03	1.06
	Rear	1.05	0.10	1.15
	Bottom	1.16	/	1.16

Table 2.3: The sum of reported SAR values for main antenna and BT

	Position	Main antenna	BT	Sum
Maximum reported SAR value for Head	Right hand, Touch cheek	0.40	0.21 ^[1]	0.61
Maximum reported SAR value for Body	Rear	1.05	0.10 ^[1]	1.15
	Bottom	1.16	/	1.16

[1] - Estimated SAR for Bluetooth (see the table 13.3)

According to the above tables, the highest sum of reported SAR values is **1.16 W/kg (1g)**. The detail for simultaneous transmission consideration is described in chapter 13.

3 Client Information

3.1 Applicant Information

Company Name:	HMD Global OY
Address/Post:	Bertel Jungin aukio 9, 02600 ESPOO, FINLAND
Contact Person:	Rosario Casillo
E-mail:	Rosario.Casillo@hmdglobal.com
Telephone:	/
Fax:	/

3.2 Manufacturer Information

Company Name:	HMD Global OY
Address/Post:	Bertel Jungin aukio 9, 02600 ESPOO, FINLAND
Contact Person:	Rosario Casillo
E-mail:	Rosario.Casillo@hmdglobal.com
Telephone:	/
Fax:	/

4 Equipment Under Test (EUT) and Ancillary Equipment (AE)

4.1 About EUT

Description:	Multi-band GSM/WCDMA/LTE phone with Bluetooth, WLAN GSM 850,900,1800,1900 WCDMA : 1,2,4,5,8 LTE : 1,2, 3,4,5,7,8,12/17,28,38,66 mobile phone, Bluetooth 4.2, WIFI 802.11 b/g/n
Model name:	TA-1133
Operating mode(s):	GSM 850/900/1800/1900, UMTS FDD 1/2/4/5/8, BT, Wi-Fi LTE Band 1/2/3/4/5/7/8/12/17/28/38/66
Tested Tx Frequency:	825 – 848.8 MHz (GSM 850)
	1850.2 – 1910 MHz (GSM 1900)
	826.4–846.6 MHz (WCDMA 850 Band V)
	1712.4 – 1752.6 MHz (WCDMA 1700 Band IV)
	1852.4–1907.6 MHz (WCDMA1900 Band II)
	1860 – 1900 MHz (LTE Band 2)
	824.7 – 848.3 MHz (LTE Band 5)
	2502.5 – 2567.5 MHz (LTE Band 7)
	699.7 – 715.3 MHz (LTE Band 12)
	2570 – 2620 MHz (LTE Band 38)
	1710.7 –1779.3 MHz (LTE Band 66)
	2412 – 2462 MHz (Wi-Fi 2.4G)
GPRS/EGPRS Multislot Class:	33
GPRS capability Class:	B
Test device Production information:	Production unit
Device type:	Portable device
Antenna type:	Integrated antenna
Accessories/Body-worn configurations:	Headset
Hotspot mode:	Support
Product Dimension:	L: 148.95mm W: 71.3mm overall diagonal: 165.14mm

4.2 Internal Identification of EUT used during the test

EUT ID*	IMEI	HW	SW Version
EUT1	352901100005845 352901100005852	89571_1_12	00XX_1_XXX
EUT2	352901100005324 352901100005332	89571_1_12	00XX_1_XXX
EUT3	352901100008245 352901100008252	89571_1_12	00XX_1_XXX
EUT4	352901100005324 352901100008435	89571_1_12	00XX_1_XXX
EUT5	352901100008203 352901100008211	89571_1_12	00XX_1_XXX
EUT6	352901100005324 352901100008112	89571_1_12	00XX_1_XXX
EUT7	352901100008500 352901100008518	89571_1_12	00XX_1_XXX
EUT8	352901100005340 352901100005357	89571_1_12	00XX_1_XXX
EUT9	352901100005522 352901100005530	89571_1_12	00XX_1_XXX
EUT10	352901100005282 352901100005290	89571_1_12	00XX_1_XXX

*EUT ID: is used to identify the test sample in the lab internally.

Note: It is performed to test SAR with the EUT1-6 and conducted power with the EUT7-10.

4.3 Internal Identification of AE used during the test

AE ID*	Description	Model	SN	Manufacturer
AE1	Battery	WT330	/	Jiade Energy Technology(Zhuhai) Co.,Ltd.
AE2	Battery	WT330	/	Sunwoda Electronic Co.,Ltd
AE3	Headset	HS-34	/	New Leader Industry Co.,Ltd

*AE ID: is used to identify the test sample in the lab internally.



5 TEST METHODOLOGY

5.1 Applicable Limit Regulations

ANSI C95.1–1992:IEEE Standard for Safety Levels with Respect to Human Exposure to Radio Frequency Electromagnetic Fields, 3 kHz to 300 GHz.

It specifies the maximum exposure limit of **1.6 W/kg** as averaged over any 1 gram of tissue for portable devices being used within 20 cm of the user in the uncontrolled environment.

5.2 Applicable Measurement Standards

IEEE 1528–2013: Recommended Practice for Determining the Peak Spatial-Average Specific Absorption Rate (SAR) in the Human Head from Wireless Communications Devices: Measurement Techniques.

KDB447498 D01: General RF Exposure Guidance v06: Mobile and Portable Devices RF Exposure Procedures and Equipment Authorization Policies.

KDB648474 D04 Handset SAR v01r03: SAR Evaluation Considerations for Wireless Handsets.

KDB941225 D01 SAR test for 3G devices v03r01: SAR Measurement Procedures for 3G Devices

KDB941225 D05 SAR for LTE Devices v02r05: SAR Evaluation Considerations for LTE Devices

KDB941225 D06 Hotspot Mode SAR v02r01: SAR Evaluation Procedures for Portable Devices with Wireless Router Capabilities

KDB248227 D01 802.11 Wi-Fi SAR v02r02: SAR GUIDANCE FOR IEEE 802.11 (Wi-Fi) TRANSMITTERS

KDB865664 D01 SAR measurement 100 MHz to 6 GHz v01r04: SAR Measurement Requirements for 100 MHz to 6 GHz.

KDB865664 D02 RF Exposure Reporting v01r02: RF Exposure Compliance Reporting and Documentation Considerations

6 Specific Absorption Rate (SAR)

6.1 Introduction

SAR is related to the rate at which energy is absorbed per unit mass in an object exposed to a radio field. The SAR distribution in a biological body is complicated and is usually carried out by experimental techniques or numerical modeling. The standard recommends limits for two tiers of groups, occupational/controlled and general population/uncontrolled, based on a person's awareness and ability to exercise control over his or her exposure. In general, occupational/controlled exposure limits are higher than the limits for general population/uncontrolled.

6.2 SAR Definition

The SAR definition is the time derivative (rate) of the incremental energy (dW) absorbed by (dissipated in) an incremental mass (dm) contained in a volume element (dv) of a given density (ρ). The equation description is as below:

$$SAR = \frac{d}{dt} \left(\frac{dW}{dm} \right) = \frac{d}{dt} \left(\frac{dW}{\rho dv} \right)$$

SAR is expressed in units of Watts per kilogram (W/kg)

SAR measurement can be either related to the temperature elevation in tissue by

$$SAR = c \left(\frac{\delta T}{\delta t} \right)$$

Where: C is the specific heat capacity, δT is the temperature rise and δt is the exposure duration, or related to the electrical field in the tissue by

$$SAR = \frac{\sigma |E|^2}{\rho}$$

Where: σ is the conductivity of the tissue, ρ is the mass density of tissue and E is the RMS electrical field strength.

However for evaluating SAR of low power transmitter, electrical field measurement is typically applied.

7 Tissue Simulating Liquids

7.1 Targets for tissue simulating liquid

Table 7.1: Targets for tissue simulating liquid

Frequency(MHz)	Liquid Type	Conductivity(σ)	$\pm 5\%$ Range	Permittivity(ϵ)	$\pm 5\%$ Range
750	Head	0.89	0.85~0.93	41.94	39.8~44.0
750	Body	0.96	0.91~1.01	55.5	52.7~58.3
835	Head	0.90	0.86~0.95	41.5	39.4~43.6
835	Body	0.97	0.92~1.02	55.2	52.4~58.0
1750	Head	1.37	1.30~1.44	40.08	38.1~42.1
1750	Body	1.49	1.42~1.56	53.4	50.7~56.1
1900	Head	1.40	1.33~1.47	40.0	38.0~42.0
1900	Body	1.52	1.44~1.60	53.3	50.6~56.0
2450	Head	1.80	1.71~1.89	39.2	37.2~41.2
2450	Body	1.95	1.85~2.05	52.7	50.1~55.3
2600	Head	1.96	1.86~2.06	39.01	37.1~41.0
2600	Body	2.16	2.05~2.27	52.5	49.9~55.1

7.2 Dielectric Performance

Table 7.2: Dielectric Performance of Tissue Simulating Liquid

Measurement Date (yyyy-mm-dd)	Type	Frequency	Permittivity ϵ	Drift (%)	Conductivity σ (S/m)	Drift (%)
2019-1-16	Head	750 MHz	42.51	1.36	0.886	-0.45
	Body	750 MHz	54.98	-0.94	0.988	2.92
2019-1-17	Head	835 MHz	41.8	0.72	0.877	-2.56
	Body	835 MHz	55.06	-0.25	0.966	-0.41
2019-1-18	Head	1750 MHz	40.49	1.02	1.407	2.70
	Body	1750 MHz	54.4	1.87	1.473	-1.14
2019-1-19	Head	1900 MHz	40.5	1.25	1.388	-0.86
	Body	1900 MHz	52.41	-1.67	1.559	2.57
2019-1-20	Head	2450 MHz	39.16	-0.10	1.805	0.28
	Body	2450 MHz	51.99	-1.35	1.966	0.82
2019-1-21	Head	2600 MHz	38.37	-1.64	1.938	-1.12
	Body	2600 MHz	51.7	-1.52	2.14	-0.93

Note: The liquid temperature is 22.0°C

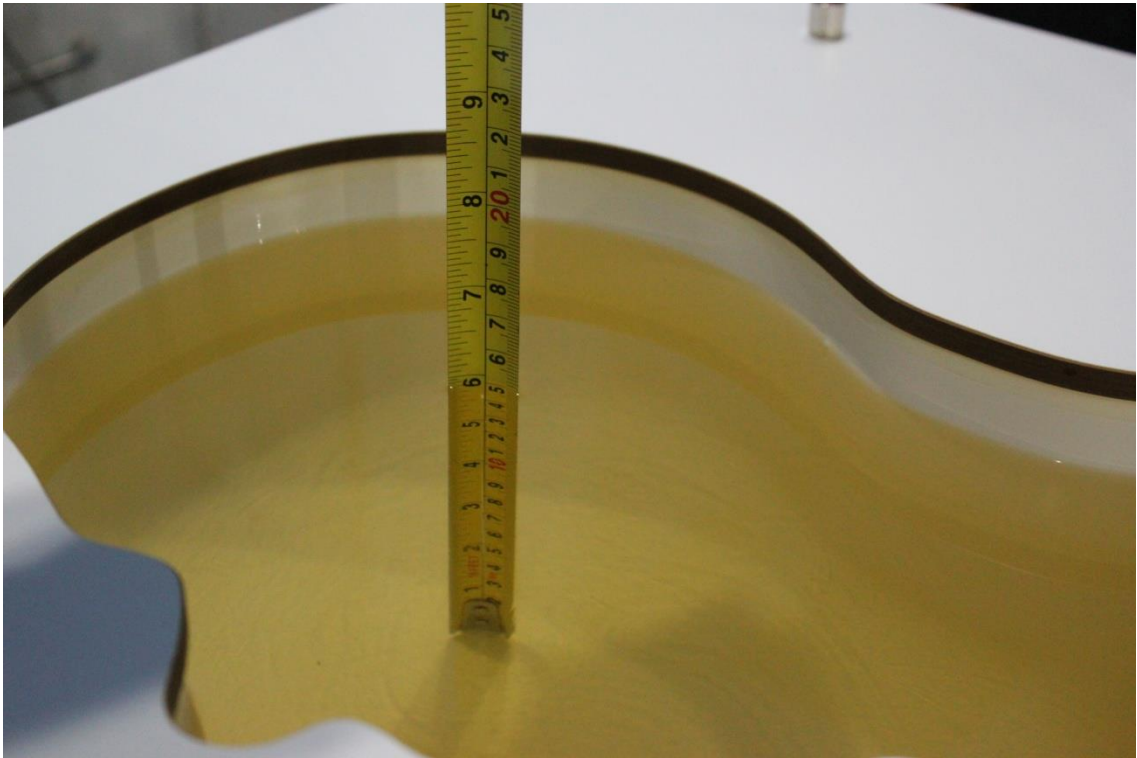

Picture 7-1 Liquid depth in the Head Phantom (750MHz)



Picture 7-2 Liquid depth in the Flat Phantom (750MHz)

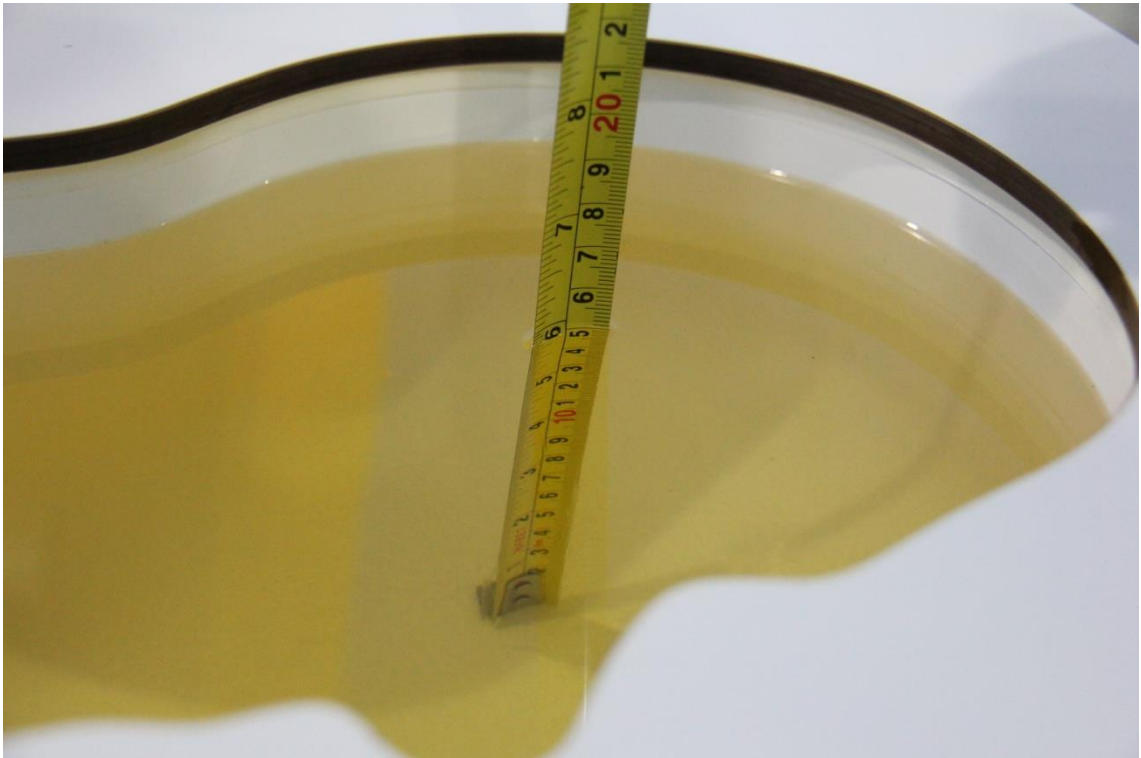

Picture 7-3 Liquid depth in the Head Phantom (835 MHz)

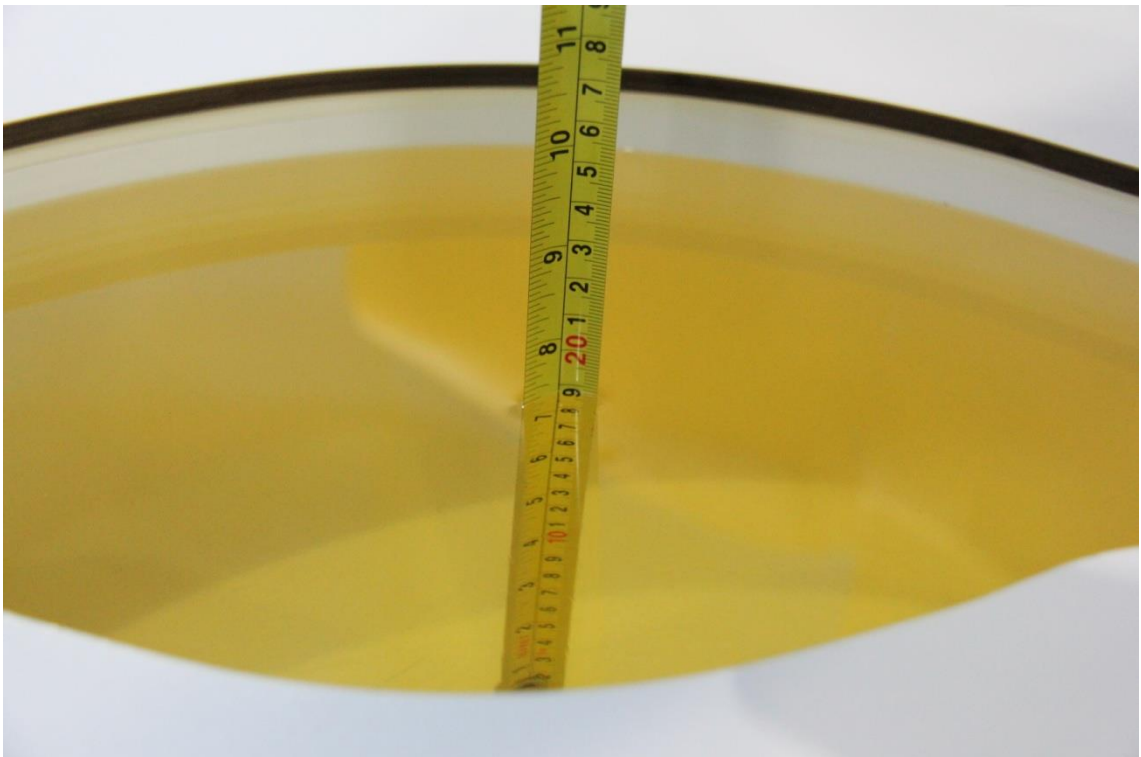

Picture 7-4 Liquid depth in the Flat Phantom (835 MHz)



Picture 7-5 Liquid depth in the Head Phantom (1750 MHz)

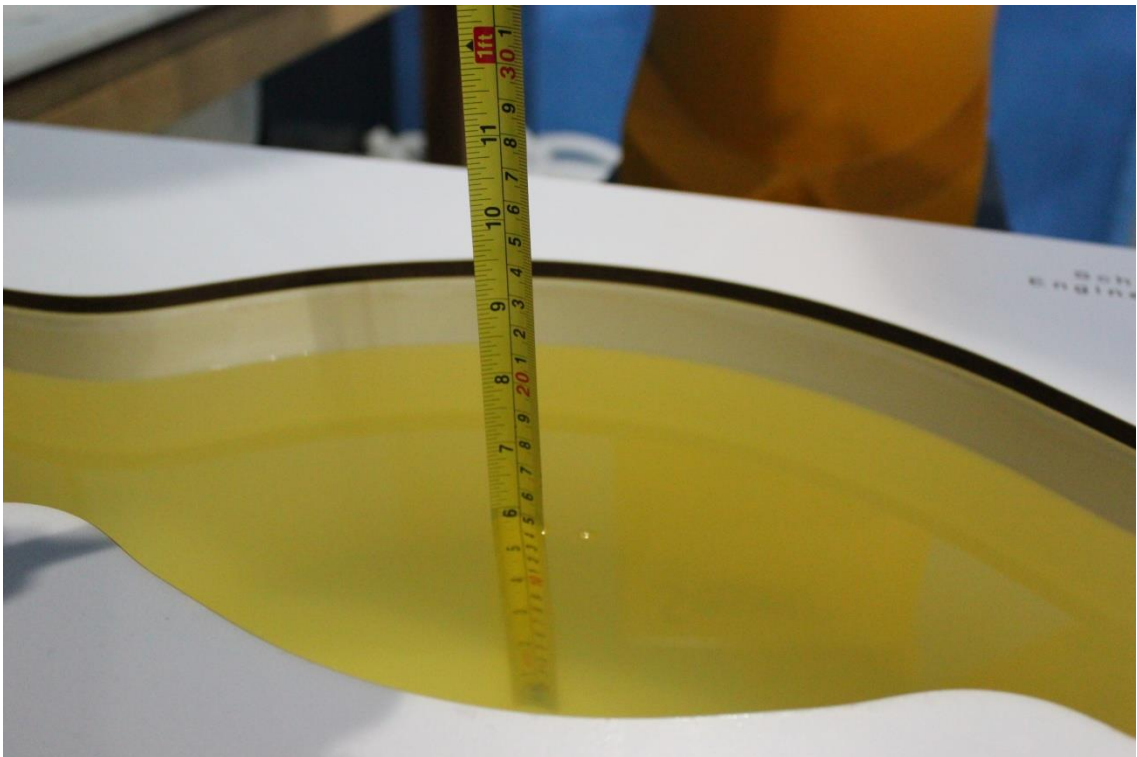

Picture 7-6 Liquid depth in the Flat Phantom (1750MHz)

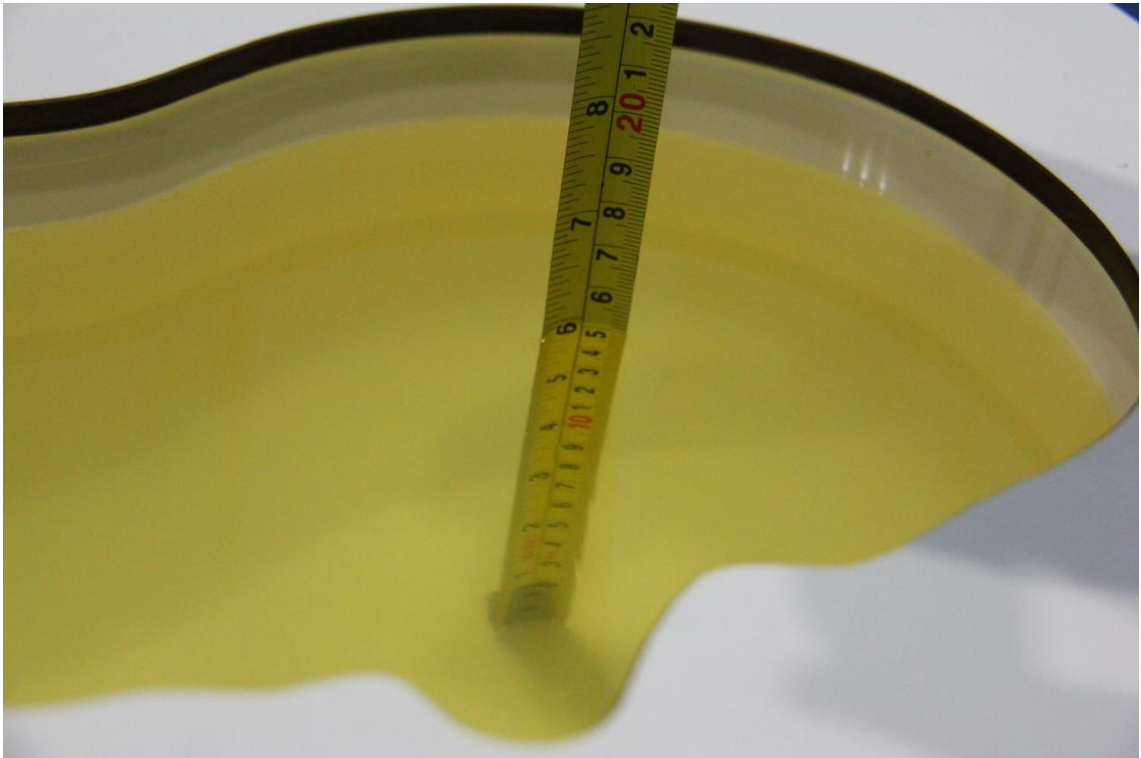

Picture 7-7 Liquid depth in the Head Phantom (1900 MHz)



Picture 7-8 Liquid depth in the Flat Phantom (1900MHz)



Picture 7-9 Liquid depth in the Head Phantom (2450MHz)

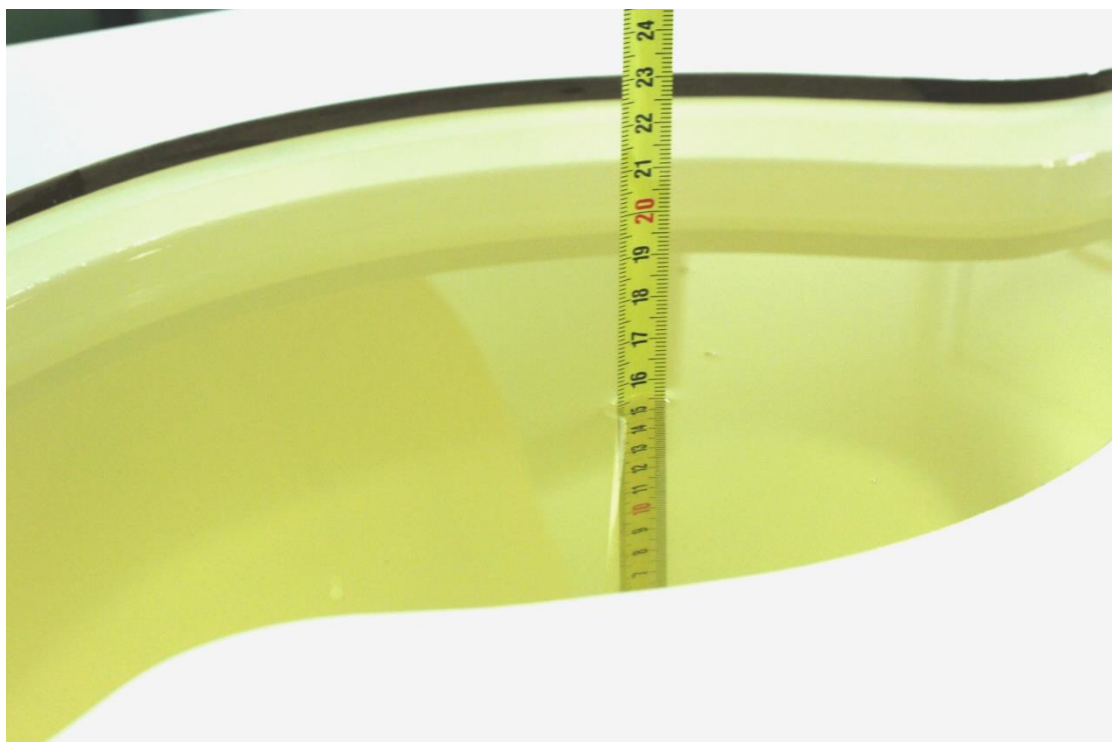

Picture 7-10 Liquid depth in the Flat Phantom (2450MHz)



Picture 7-11 Liquid depth in the Head Phantom (2600 MHz Head)

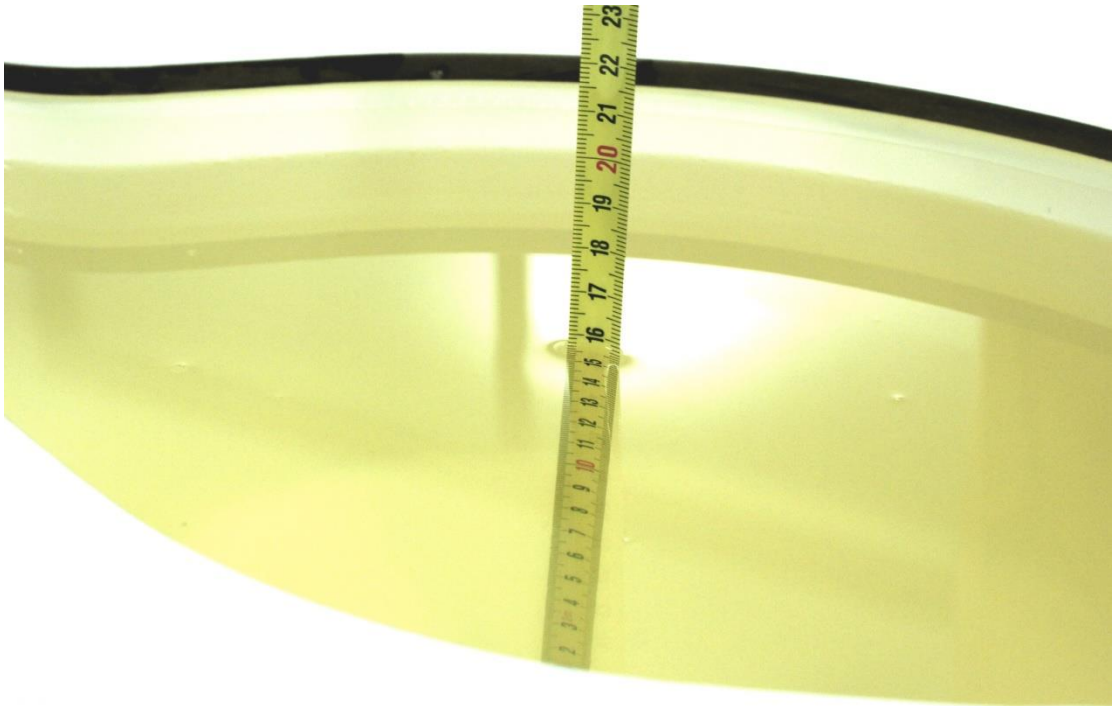

Picture 7-12 Liquid depth in the Flat Phantom (2600MHz)

8 System verification

8.1 System Setup

In the simplified setup for system evaluation, the DUT is replaced by a calibrated dipole and the power source is replaced by a continuous wave that comes from a signal generator. The calibrated dipole must be placed beneath the flat phantom section of the SAM twin phantom with the correct distance holder. The distance holder should touch the phantom surface with a light pressure at the reference marking and be oriented parallel to the long side of the phantom. The equipment setup is shown below:

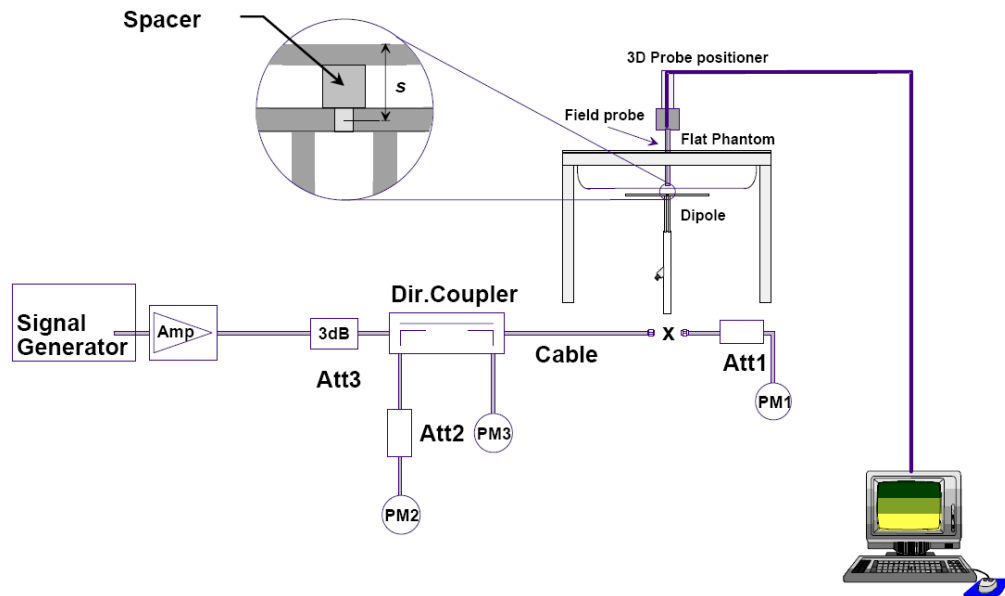

Picture 8.1 System Setup for System Evaluation



Picture 8.2 Photo of Dipole Setup

8.2 System Verification

SAR system verification is required to confirm measurement accuracy, according to the tissue dielectric media, probe calibration points and other system operating parameters required for measuring the SAR of a test device. The system verification must be performed for each frequency band and within the valid range of each probe calibration point required for testing the device.

The system verification results are required that the area scan estimated 1-g SAR is within 3% of the zoom scan 1-g SAR. The details are presented in annex B.

Table 8.1: System Verification of Head

Measurement Date (yyyy-mm-dd)	Frequency	Target value (W/kg)		Measured value(W/kg)		Deviation	
		10 g Average	1 g Average	10 g Average	1 g Average	10 g Average	1 g Average
2019-1-16	750 MHz	5.34	8.20	5.48	8.44	2.62%	2.93%
2019-1-17	835 MHz	6.06	9.40	5.92	9.20	-2.31%	-2.13%
2019-1-18	1750 MHz	18.9	35.9	19.4	36.6	2.43%	1.95%
2019-1-19	1900 MHz	21.3	40.4	21.5	41.6	1.03%	2.97%
2019-1-20	2450 MHz	24.2	51.7	25.0	52.8	3.31%	2.13%
2019-1-21	2600 MHz	24.9	55.4	25.3	56.8	1.53%	2.53%

Table 8.2: System Verification of Body

Measurement Date (yyyy-mm-dd)	Frequency	Target value (W/kg)		Measured value (W/kg)		Deviation	
		10 g Average	1 g Average	10 g Average	1 g Average	10 g Average	1 g Average
2019-1-16	750 MHz	5.68	8.63	5.80	8.84	2.11%	2.43%
2019-1-17	835 MHz	6.28	9.53	6.16	9.52	-1.91%	-0.10%
2019-1-18	1750 MHz	19.3	36.4	19.96	36.56	3.42%	0.44%
2019-1-19	1900 MHz	21.4	40.4	21.20	40.80	-0.93%	0.99%
2019-1-20	2450 MHz	24.1	51.3	24.48	53.20	1.58%	3.70%
2019-1-21	2600 MHz	24.5	54.1	24.84	55.60	1.39%	2.77%

9 Measurement Procedures

9.1 Tests to be performed

In order to determine the highest value of the peak spatial-average SAR of a handset, all device positions, configurations and operational modes shall be tested for each frequency band according to steps 1 to 3 below. A flowchart of the test process is shown in picture 9.1.

Step 1: The tests described in 9.2 shall be performed at the channel that is closest to the centre of the transmit frequency band (f_c) for:

- a) all device positions (cheek and tilt, for both left and right sides of the SAM phantom, as described in annex D),
- b) all configurations for each device position in a), e.g., antenna extended and retracted, and
- c) all operational modes, e.g., analogue and digital, for each device position in a) and configuration in b) in each frequency band.

If more than three frequencies need to be tested according to 11.1 (i.e., $N_c > 3$), then all frequencies, configurations and modes shall be tested for all of the above test conditions.

Step 2: For the condition providing highest peak spatial-average SAR determined in Step 1, perform all tests described in 9.2 at all other test frequencies, i.e., lowest and highest frequencies. In addition, for all other conditions (device position, configuration and operational mode) where the peak spatial-average SAR value determined in Step 1 is within 3 dB of the applicable SAR limit, it is recommended that all other test frequencies shall be tested as well.

Step 3: Examine all data to determine the highest value of the peak spatial-average SAR found in Steps 1 to 2.

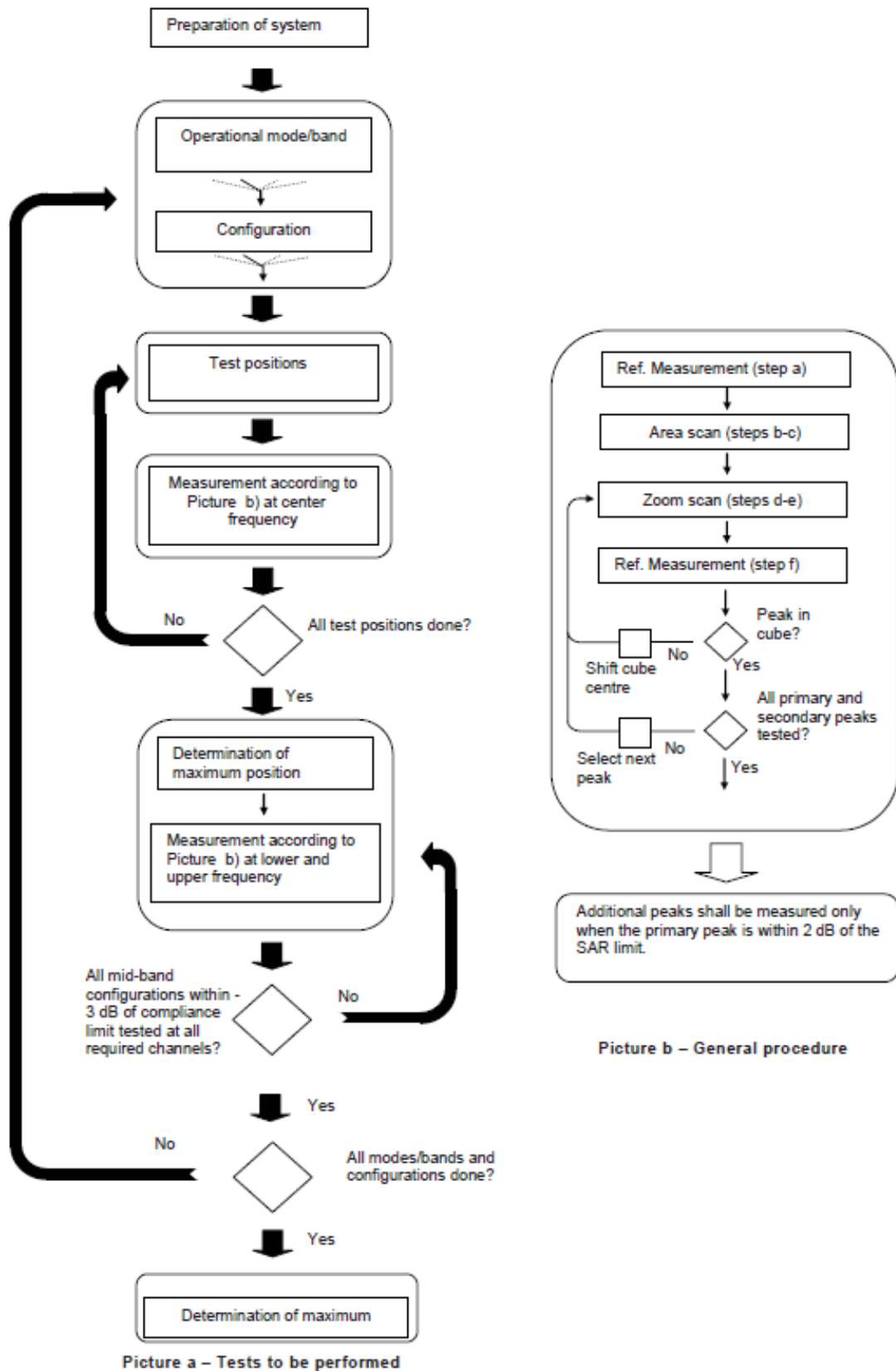

Picture 9.1 Block diagram of the tests to be performed

9.2 General Measurement Procedure

The area and zoom scan resolutions specified in the table below must be applied to the SAR measurements and fully documented in SAR reports to qualify for TCB approval. Probe boundary effect error compensation is required for measurements with the probe tip closer than half a probe tip diameter to the phantom surface. Both the probe tip diameter and sensor offset distance must satisfy measurement protocols; to ensure probe boundary effect errors are minimized and the higher fields closest to the phantom surface can be correctly measured and extrapolated to the phantom surface for computing 1-g SAR. Tolerances of the post-processing algorithms must be verified by the test laboratory for the scan resolutions used in the SAR measurements, according to the reference distribution functions specified in IEEE Std 1528-2003. The results should be documented as part of the system validation records and may be requested to support test results when all the measurement parameters in the following table are not satisfied.

		≤ 3 GHz	> 3 GHz	
Maximum distance from closest measurement point (geometric center of probe sensors) to phantom surface		5 ± 1 mm	$\frac{1}{2} \cdot \delta \cdot \ln(2) \pm 0.5$ mm	
Maximum probe angle from probe axis to phantom surface normal at the measurement location		$30^\circ \pm 1^\circ$	$20^\circ \pm 1^\circ$	
Maximum area scan spatial resolution: Δx_{Area} , Δy_{Area}		≤ 2 GHz: ≤ 15 mm 2 – 3 GHz: ≤ 12 mm	3 – 4 GHz: ≤ 12 mm 4 – 6 GHz: ≤ 10 mm	
		When the x or y dimension of the test device, in the measurement plane orientation, is smaller than the above, the measurement resolution must be \leq the corresponding x or y dimension of the test device with at least one measurement point on the test device.		
Maximum zoom scan spatial resolution: Δx_{Zoom} , Δy_{Zoom}		≤ 2 GHz: ≤ 8 mm 2 – 3 GHz: ≤ 5 mm*	3 – 4 GHz: ≤ 5 mm* 4 – 6 GHz: ≤ 4 mm*	
Maximum zoom scan spatial resolution, normal to phantom surface	uniform grid: $\Delta z_{Zoom}(n)$	≤ 5 mm	3 – 4 GHz: ≤ 4 mm 4 – 5 GHz: ≤ 3 mm 5 – 6 GHz: ≤ 2 mm	
	graded grid	$\Delta z_{Zoom}(1)$: between 1 st two points closest to phantom surface	≤ 4 mm	3 – 4 GHz: ≤ 3 mm 4 – 5 GHz: ≤ 2.5 mm 5 – 6 GHz: ≤ 2 mm
		$\Delta z_{Zoom}(n>1)$: between subsequent points	$\leq 1.5 \cdot \Delta z_{Zoom}(n-1)$	
Minimum zoom scan volume	x, y, z	≥ 30 mm	3 – 4 GHz: ≥ 28 mm 4 – 5 GHz: ≥ 25 mm 5 – 6 GHz: ≥ 22 mm	
<p>Note: δ is the penetration depth of a plane-wave at normal incidence to the tissue medium; see draft standard IEEE P1528-2011 for details.</p> <p>* When zoom scan is required and the <i>reported</i> SAR from the area scan based 1-g SAR estimation procedures of KDB 447498 is ≤ 1.4 W/kg, ≤ 8 mm, ≤ 7 mm and ≤ 5 mm zoom scan resolution may be applied, respectively, for 2 GHz to 3 GHz, 3 GHz to 4 GHz and 4 GHz to 6 GHz.</p>				

9.3 WCDMA Measurement Procedures for SAR

The following procedures are applicable to WCDMA handsets operating under 3GPP Release99, Release 5 and Release 6. The default test configuration is to measure SAR with an established radio link between the DUT and a communication test set using a 12.2kbps RMC (reference measurement channel) configured in Test Loop Mode 1. SAR is selectively confirmed for other physical channel configurations (DPCCH & DPDCH_n), HSDPA and HSPA (HSUPA/HSDPA) modes according to output power, exposure conditions and device operating capabilities. Both uplink and downlink should be configured with the same RMC or AMR, when required. SAR for Release 5 HSDPA and Release 6 HSPA are measured using the applicable FRC (fixed reference channel) and E-DCH reference channel configurations. Maximum output power is verified according to applicable versions of 3GPP TS 34.121 and SAR must be measured according to these maximum output conditions. When Maximum Power Reduction (MPR) is not implemented according to Cubic Metric (CM) requirements for Release 6 HSPA, the following procedures do not apply.

For Release 5 HSDPA Data Devices:

Sub-test	β_c	β_d	β_d (SF)	β_c / β_d	β_{hs}	CM/dB
1	2/15	15/15	64	2/15	4/15	0.0
2	12/15	15/15	64	12/15	24/25	1.0
3	15/15	8/15	64	15/8	30/15	1.5
4	15/15	4/15	64	15/4	30/15	1.5

For Release 6 HSPA Data Devices

Sub-test	β_c	β_d	β_d (SF)	β_c / β_d	β_{hs}	β_{ec}	β_{ed}	β_{ed} (SF)	β_{ed} (codes)	CM (dB)	MPR (dB)	AG Index	E-TFCI
1	11/15	15/15	64	11/15	22/15	209/225	1039/225	4	1	1.5	1.5	20	75
2	6/15	15/15	64	6/15	12/15	12/15	12/15	4	1	1.5	1.5	12	67
3	15/15	9/15	64	15/9	30/15	30/15	$\beta_{ed1}:47/15$ $\beta_{ed2}:47/15$	4	2	1.5	1.5	15	92
4	2/15	15/15	64	2/15	4/15	4/15	56/75	4	1	1.5	1.5	17	71
5	15/15	15/15	64	15/15	24/15	30/15	134/15	4	1	1.5	1.5	21	81

Rel.8 DC-HSDPA (Cat 24)

SAR test exclusion for Rel.8 DC-HSDPA must satisfy the SAR test exclusion requirements of Rel.5 HSDPA. SAR test exclusion for DC-HSDPA devices is determined by power measurements according to the H-Set 12, Fixed Reference Channel (FRC) configuration in Table C.8.1.12 of 3GPP TS 34.121-1. A primary and a secondary serving HS-DSCH Cell are required to perform the power measurement and for the results to qualify for SAR test exclusion.

9.4 SAR Measurement for LTE

SAR tests for LTE are performed with a base station simulator, Rohde & Schwarz CMW500. Closed loop power control was used so the UE transmits with maximum output power during SAR testing. All powers were measured with the CMW 500.

It is performed for conducted power and SAR based on the KDB941225 D05.

SAR is evaluated separately according to the following procedures for the different test positions in each exposure condition – head, body, body-worn accessories and other use conditions. The procedures in the following subsections are applied separately to test each LTE frequency band.

1) QPSK with 1 RB allocation

Start with the largest channel bandwidth and measure SAR for QPSK with 1 RB allocation, using the RB offset and required test channel combination with the highest maximum output power among RB offsets at the upper edge, middle and lower edge of each required test channel. When the reported SAR is ≤ 0.8 W/kg, testing of the remaining RB offset configurations and required test channels is not required for 1 RB allocation; otherwise, SAR is required for the remaining required test channels and only for the RB offset configuration with the highest output power for that channel. When the reported SAR of a required test channel is > 1.45 W/kg, SAR is required for all three RB offset configurations for that required test channel.

2) QPSK with 50% RB allocation

The procedures required for 1 RB allocation in 1) are applied to measure the SAR for QPSK with 50% RB allocation.

3) QPSK with 100% RB allocation

For QPSK with 100% RB allocation, SAR is not required when the highest maximum output power for 100 % RB allocation is less than the highest maximum output power in 50% and 1 RB allocations and the highest reported SAR for 1 RB and 50% RB allocation in 1) and 2) are ≤ 0.8 W/kg. Otherwise, SAR is measured for the highest output power channel; and if the reported SAR is > 1.45 W/kg, the remaining required test channels must also be tested.

TDD test:

TDD testing is performed using guidance from FCC KDB 941225 D05 v02r05 and the SAR test guidance provided in April 2013 TCB works hop notes. TDD is tested at the highest duty factor using UL-DL configuration 0 with special subframe configuration 6 and applying the FDD LTE procedures in KDB 941225 D05 v02r05. SAR testing is performed using the extended cyclic prefix listed in 3GPP TS 36.211.

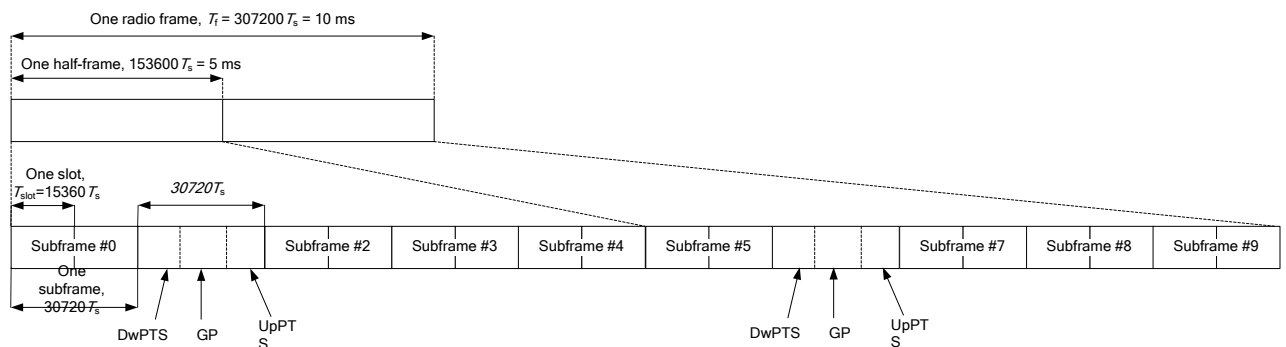

Figure 9.2: Frame structure type 2 (for 5 ms switch-point periodicity)

Table 9.1: Configuration of special subframe (lengths of DwPTS/GP/UpPTS)

Special subframe configuration	Normal cyclic prefix in downlink			Extended cyclic prefix in downlink		
	DwPTS	UpPTS		DwPTS	UpPTS	
		Normal cyclic prefix in uplink	Extended cyclic prefix in uplink		Normal cyclic prefix in uplink	Extended cyclic prefix in uplink
0	$6592 \cdot T_s$	$2192 \cdot T_s$	$2560 \cdot T_s$	$7680 \cdot T_s$	$2192 \cdot T_s$	$2560 \cdot T_s$
1	$19760 \cdot T_s$			$20480 \cdot T_s$		
2	$21952 \cdot T_s$			$23040 \cdot T_s$		
3	$24144 \cdot T_s$			$25600 \cdot T_s$		
4	$26336 \cdot T_s$			$7680 \cdot T_s$		
5	$6592 \cdot T_s$	$4384 \cdot T_s$	$5120 \cdot T_s$	$20480 \cdot T_s$	$4384 \cdot T_s$	$5120 \cdot T_s$
6	$19760 \cdot T_s$			$23040 \cdot T_s$		
7	$21952 \cdot T_s$			$12800 \cdot T_s$		
8	$24144 \cdot T_s$			-		
9	$13168 \cdot T_s$			-		

Table 9.2: Uplink-downlink configurations

Uplink-downlink configuration	Downlink-to-Uplink Switch-point periodicity	Subframe number									
		0	1	2	3	4	5	6	7	8	9
0	5 ms	D	S	U	U	U	D	S	U	U	U
1	5 ms	D	S	U	U	D	D	S	U	U	D
2	5 ms	D	S	U	D	D	D	S	U	D	D
3	10 ms	D	S	U	U	U	D	D	D	D	D
4	10 ms	D	S	U	U	D	D	D	D	D	D
5	10 ms	D	S	U	D	D	D	D	D	D	D
6	5 ms	D	S	U	U	U	D	S	U	U	D

Duty factor is calculated by:

$$\begin{aligned}
 \text{Duty factor} &= \text{uplink frame} \cdot 6 + \text{UpPTS} \cdot 2 / \text{one frame length} \\
 &= (30720 \cdot T_s \cdot 6 + 5120 \cdot T_s \cdot 2) / 307200 \cdot T_s \\
 &= 0.633
 \end{aligned}$$

According to the KDB 447498 D01, SAR should be evaluated at more than 3 frequencies for devices supporting transmit bands wider than 100MHz. Oct.2014 FCC-TCB conference notes (Dec. 2014 rev.) specifies the 5 test channels to use for 3GPP band 41 SAR evaluation.

9.5 Bluetooth & Wi-Fi Measurement Procedures for SAR

Normal network operating configurations are not suitable for measuring the SAR of 802.11 transmitters in general. Unpredictable fluctuations in network traffic and antenna diversity conditions can introduce undesirable variations in SAR results. The SAR for these devices should be measured using chipset based test mode software to ensure that the results are consistent and reliable.

Chipset based test mode software is hardware dependent and generally varies among manufacturers. The device operating parameters established in a test mode for SAR measurements must be identical to those programmed in production units, including output power levels, amplifier gain settings and other RF performance tuning parameters. The test frequencies should correspond to actual channel frequencies defined for domestic use. SAR for devices with switched diversity should be measured with only one antenna transmitting at a time during each SAR measurement, according to a fixed modulation and data rate. The same data pattern should be used for all measurements.

9.6 Power Drift

To control the output power stability during the SAR test, DASY4 system calculates the power drift by measuring the E-field at the same location at the beginning and at the end of the measurement for each test position. These drift values can be found in section 14 labeled as: (Power Drift [dB]). This ensures that the power drift during one measurement is within 5%.

10 Area Scan Based 1-g SAR

10.1 Requirement of KDB

According to the KDB447498 D01 v05, when the implementation is based the specific polynomial fit algorithm as presented at the 29th Bioelectromagnetics Society meeting (2007) and the estimated 1-gSAR is ≤ 1.2 W/kg, a zoom scan measurement is not required provided it is also not needed for any other purpose; for example, if the peak SAR location required for simultaneous transmission SAR test exclusion can be determined accurately by the SAR system or manually to discriminate between distinctive peaks and scattered noisy SAR distributions from area scans.

There must not be any warning or alert messages due to various measurement concerns identified by the SAR system; for example, noise in measurements, peaks too close to scan boundary, peaks are too sharp, spatial resolution and uncertainty issues etc. The SAR system verification must also demonstrate that the area scan estimated 1-g SAR is within 3% of the zoom scan 1-g SAR (See Annex B). When all the SAR results for each exposure condition in a frequency band and wireless mode are based on estimated 1-g SAR, the 1-g SAR for the highest SAR configuration must be determined by a zoom scan.

10.2 Fast SAR Algorithms

The approach is based on the area scan measurement applying a frequency dependent attenuation parameter. This attenuation parameter was empirically determined by analyzing a large number of phones. The MOTOROLA FAST SAR was developed and validated by the MOTOROLA Research Group in Ft. Lauderdale.

In the initial study, an approximation algorithm based on Linear fit was developed. The accuracy of the algorithm has been demonstrated across a broad frequency range (136-2450 MHz) and for both 1- and 10-g averaged SAR using a sample of 264 SAR measurements from 55 wireless handsets. For the sample size studied, the root-mean-squared errors of the algorithm are 1.2% and 5.8% for 1- and 10-g averaged SAR, respectively. The paper describing the algorithm in detail is expected to be published in August 2004 within the Special Issue of Transactions on MTT.

In the second step, the same research group optimized the fitting algorithm to an Polynomial fit whereby the frequency validity was extended to cover the range 30-6000MHz. Details of this study can be found in the BEMS 2007 Proceedings.

Both algorithms are implemented in DASYS software.

11 Conducted Output Power

There are two sets of tune-up power, Normal power and Low power, for GSM1900, WCDMA1700/1900 and LTE B2/7/66 by proximity sensor. The detail of proximity sensor is presented in annex I.

11.1 GSM Measurement result

During the process of testing, the EUT was controlled via Agilent Digital Radio Communication tester (E5515C) to ensure the maximum power transmission and proper modulation. This result contains conducted output power for the EUT. In all cases, the measured peak output power should be greater and within 5% than EMI measurement.

Table 11.1-1: The conducted power measurement results for GSM/GPRS/EGPRS – Normal power

GSM 850 Speech (GMSK)	Measured Power (dBm)			Tune up	calculation	Averaged Power (dBm)		
	251	190	128			251	190	128
1 Txslot	32.45	32.43	32.32	34	/	/	/	/
GSM 850 GPRS (GMSK)	Measured Power (dBm)				calculation	Averaged Power (dBm)		
	251	190	128			251	190	128
1 Txslot	32.49	32.40	32.71	34	-9.03	23.46	23.37	23.68
2 Txslots	29.24	29.14	29.10	31	-6.02	23.22	23.12	23.08
3Txslots	27.31	27.33	27.31	29	-4.26	23.05	23.07	23.05
4 Txslots	26.41	26.35	26.34	28	-3.01	23.40	23.34	23.33
GSM 850 EGPRS (GMSK)	Measured Power (dBm)				calculation	Averaged Power (dBm)		
	251	190	128			251	190	128
1 Txslot	32.44	32.41	32.73	34	-9.03	23.41	23.38	23.70
2 Txslots	29.23	29.19	29.15	31	-6.02	23.21	23.17	23.13
3Txslots	27.33	27.39	27.30	29	-4.26	23.07	23.13	23.04
4 Txslots	26.40	26.38	26.41	28	-3.01	23.39	23.37	23.40
GSM 850 EGPRS (8PSK)	Measured Power (dBm)				calculation	Averaged Power (dBm)		
	251	190	128			251	190	128
1 Txslot	27.14	27.50	27.37	29	-9.03	18.11	18.47	18.34
2 Txslots	23.49	23.68	23.66	25	-6.02	17.47	17.66	17.64
3Txslots	23.07	22.38	22.45	24	-4.26	18.81	18.12	18.19
4 Txslots	22.27	22.50	22.30	24	-3.01	19.26	19.49	19.29
PCS1900 Speech (GMSK)	Measured Power (dBm)			Tune up	calculation	Averaged Power (dBm)		
	810	661	512			810	661	512
1 Txslot	30.15	30.02	30.42	32	/	/	/	/
PCS1900 GPRS (GMSK)	Measured Power (dBm)				calculation	Averaged Power (dBm)		
	810	661	512			810	661	512
1 Txslot	30.08	30.02	30.16	31.5	-9.03	21.05	20.99	21.13
2 Txslots	26.63	26.99	26.90	28.5	-6.02	20.61	20.97	20.88
3Txslots	24.42	24.29	24.29	26	-4.26	20.16	20.03	20.03
4 Txslots	24.27	24.16	24.17	26	-3.01	21.26	21.15	21.16

PCS1900 EGPRS (GMSK)	Measured Power (dBm)				calculation	Averaged Power (dBm)		
	810	661	512			810	661	512
1 Txslot	30.11	30.02	30.12	31.5	-9.03	21.08	20.99	21.09
2 Txslots	26.65	26.99	26.91	28.5	-6.02	20.63	20.97	20.89
3Txslots	24.35	24.29	24.30	26	-4.26	20.09	20.03	20.04
4 Txslots	24.21	24.17	24.18	26	-3.01	21.20	21.16	21.17
PCS1900 EGPRS (8PSK)	Measured Power (dBm)				calculation	Averaged Power (dBm)		
	810	661	512			810	661	512
1 Txslot	25.99	25.52	25.63	27.5	-9.03	16.96	16.49	16.60
2 Txslots	22.30	22.18	22.17	24	-6.02	16.28	16.16	16.15
3Txslots	22.07	22.25	22.21	24	-4.26	17.81	17.99	17.95
4 Txslots	21.93	21.94	22.03	23.5	-3.01	18.92	18.93	19.02

Table 11.1-2: The conducted power measurement results for GSM/GPRS/EGPRS – Low power

PCS1900 Speech (GMSK)	Measured Power (dBm)			Tune up	calculation	Averaged Power (dBm)		
	810	661	512			810	661	512
1 Txslot	30.38	30.33	30.65	32	/	/	/	/
PCS1900 GPRS (GMSK)	Measured Power (dBm)				calculation	Averaged Power (dBm)		
	810	661	512			810	661	512
1 Txslot	30.46	30.39	30.73	32	-9.03	21.43	21.36	21.70
2 Txslots	25.13	24.99	24.95	26.5	-6.02	19.11	18.97	18.93
3Txslots	22.45	22.40	22.67	24	-4.26	18.19	18.14	18.41
4 Txslots	22.34	22.31	22.57	24	-3.01	19.33	19.30	19.56
PCS1900 EGPRS (GMSK)	Measured Power (dBm)				calculation	Averaged Power (dBm)		
	810	661	512			810	661	512
1 Txslot	30.47	30.41	30.74	32	-9.03	21.44	21.38	21.71
2 Txslots	25.15	25.02	24.98	26.5	-6.02	19.13	19.00	18.96
3Txslots	22.47	22.43	22.70	24	-4.26	18.21	18.17	18.44
4 Txslots	22.37	22.34	22.60	24	-3.01	19.36	19.33	19.59
PCS1900 EGPRS (8PSK)	Measured Power (dBm)				calculation	Averaged Power (dBm)		
	810	661	512			810	661	512
1 Txslot	25.51	25.67	25.56	27.5	-9.03	16.36	16.64	16.53
2 Txslots	20.46	20.19	20.24	21.5	-6.02	14.44	14.17	14.22
3Txslots	20.07	20.08	20.24	21.5	-4.26	15.81	15.82	15.98
4 Txslots	19.95	20.02	20.06	21	-3.01	16.94	17.01	17.05

NOTES:

To average the power, the division factor is as follows:

1TX-slot = 1 transmit time slot out of 8 time slots=> conducted power divided by (8/1) => -9.03dB

2TX-slots = 2 transmit time slots out of 8 time slots=> conducted power divided by (8/2) => -6.02dB

3TX-slots = 3 transmit time slots out of 8 time slots=> conducted power divided by (8/3) => -4.26dB

4TX-slots = 4 transmit time slots out of 8 time slots=> conducted power divided by (8/4) => -3.01dB

According to the conducted power as above, the body measurements are performed with 1Txslot for GSM850, 4Txslots (Normal power) and 1Txslot (Low power) for GSM1900.

11.2 WCDMA Measurement result

Table 11.2-1: The conducted Power for WCDMA – Normal power

Item	band	FDDV result			
	ARFCN	4233 (846.6MHz)	4182 (836.4MHz)	4132 (826.4MHz)	Tune up
WCDMA	\	24.11	24.05	24.18	25
HSUPA	1	22.93	22.86	22.89	24
	2	22.49	22.36	22.41	24
	3	22.90	22.83	22.86	24
	4	22.98	22.89	22.95	24
	5	23.04	22.82	22.90	24
DC-HSDPA	1	22.61	22.59	22.62	24
	2	22.63	22.58	22.65	24
	3	22.64	22.57	22.66	24
	4	22.62	22.58	22.65	24
Item	band	FDDIV result			
	ARFCN	1513 (1752.6MHz)	1412 (1732.4MHz)	1312 (1712.4MHz)	
WCDMA	\	24.38	24.42	24.31	25
HSUPA	1	22.99	22.96	22.97	24
	2	22.51	22.47	22.49	24
	3	22.93	23.03	23.01	24
	4	22.89	22.95	22.99	24
	5	22.90	22.93	22.95	24
DC-HSDPA	1	22.83	22.76	22.74	24
	2	22.81	22.77	22.75	24
	3	22.82	22.79	22.72	24
	4	23.8	22.75	22.73	24
Item	band	FDDII result			
	ARFCN	9538 (1907.6MHz)	9400 (1880MHz)	9262 (1852.4MHz)	
WCDMA	\	24.40	24.26	24.33	25
HSUPA	1	23.02	23.01	23.05	24
	2	22.48	22.50	22.46	24
	3	22.94	22.96	22.97	24
	4	22.97	22.91	22.95	24
	5	23.05	23.04	23.08	24
DC-HSDPA	1	23.15	23.12	23.13	24
	2	23.17	23.15	23.16	24
	3	23.18	23.16	23.15	24
	4	23.18	23.14	23.12	24

Table 11.2-2: The conducted Power for WCDMA – Low power

Item	band	FDDIV result			
	ARFCN	1513 (1752.6MHz)	1412 (1732.4MHz)	1312 (1712.4MHz)	
WCDMA	\	20.08	20.10	19.94	21
HSUPA	1	19.98	19.96	20.00	21
	2	19.47	19.46	19.39	21
	3	19.95	19.92	19.91	21
	4	20.03	20.01	19.92	21
	5	20.01	20.07	19.95	21
DC-HSDPA	1	19.76	19.78	19.74	21
	2	19.75	19.79	19.75	21
	3	19.77	19.80	19.73	21
	4	19.74	19.77	19.72	21
Item	band	FDDII result			
	ARFCN	9538 (1907.6MHz)	9400 (1880MHz)	9262 (1852.4MHz)	
WCDMA	\	18.90	18.98	19.05	20.5
HSUPA	1	18.99	18.91	18.96	20.5
	2	18.57	18.56	18.54	20.5
	3	19.06	19.03	19.07	20.5
	4	19.10	19.09	19.04	20.5
	5	19.07	19.00	19.01	20.5
DC-HSDPA	1	19.15	19.08	19.12	20.5
	2	19.16	19.07	19.10	20.5
	3	19.14	19.09	19.11	20.5
	4	19.17	19.10	19.09	20.5

11.3 LTE Measurement result

Table 11.3-1: Tune up for LTE

Band	Tune up (dBm)	
	Normal power	Low power
Band 2	25	22.5
Band 5	24.5	/
Band 7	25	24
Band 12	24.5	/
Band 38	24.5	/
Band 66	25	23

Table 11.3-2: Maximum Power Reduction (MPR) for LTE

Modulation	Channel bandwidth / Transmission bandwidth configuration [RB]						MPR (dB)
	1.4 MHz	3 MHz	5 MHz	10 MHz	15 MHz	20 MHz	
QPSK	> 5	> 4	> 8	> 12	> 16	> 18	1
16 QAM	≤ 5	≤ 4	≤ 8	≤ 12	≤ 16	≤ 18	1
16 QAM	> 5	> 4	> 8	> 12	> 16	> 18	2

Table 11.3-3: The conducted Power for LTE – Normal power

Band 2						
Bandwidth (MHz)	RB allocation	Frequency (MHz)	QPSK	16QAM	64QAM	
	RB offset (Start RB)		Actual output power (dBm)	Actual output power (dBm)	Actual output power (dBm)	
1.4 MHz	1RB High (5)	1909.3	24.14	23.31	21.42	
		1880	24.24	23.23	21.19	
		1850.7	24.16	22.93	21.25	
	1RB Middle (3)	1909.3	24.29	23.36	21.50	
		1880	24.32	23.30	21.11	
		1850.7	24.20	23.23	21.58	
	1RB Low (0)	1909.3	24.33	23.31	21.45	
		1880	24.22	23.27	21.24	
		1850.7	24.25	23.66	21.16	
	3RB High (3)	1909.3	24.20	23.13	21.42	
		1880	24.26	23.10	21.36	
		1850.7	24.28	23.18	21.15	
	3RB Middle (1)	1909.3	24.34	23.53	21.37	
		1880	24.30	22.99	21.39	
		1850.7	24.42	23.37	21.07	
	3RB Low (0)	1909.3	24.30	23.52	21.43	
		1880	24.26	23.20	21.32	
		1850.7	24.29	23.16	21.05	
	6RB (0)	1909.3	23.34	22.31	20.35	
		1880	23.18	22.49	20.40	
		1850.7	23.02	22.05	20.32	
	3 MHz	1RB High (14)	1908.5	24.04	23.33	21.43
			1880	24.05	23.32	21.38
			1851.5	24.32	23.64	21.17
1RB Middle (7)		1908.5	24.29	23.39	21.26	
		1880	24.22	23.76	21.42	
		1851.5	24.39	23.07	21.26	
1RB Low (0)		1908.5	24.29	23.27	21.45	
		1880	24.21	23.34	21.35	
		1851.5	24.27	23.09	21.03	
8RB High (7)		1908.5	23.24	22.43	20.57	
		1880	23.22	22.62	20.41	
		1851.5	23.12	22.41	20.29	
8RB Middle (4)		1908.5	23.26	22.13	20.51	
		1880	23.09	22.43	20.35	
		1851.5	23.16	22.30	20.23	
8RB Low (0)		1908.5	23.29	22.37	20.63	
		1880	23.22	22.45	20.31	
		1851.5	23.06	22.49	20.25	
15RB (0)		1908.5	23.24	22.19	20.42	
		1880	23.19	22.44	20.49	
		1851.5	23.14	22.35	20.27	

5 MHz	1RB High (24)	1907.5	23.98	22.82	21.74
		1880	24.45	22.61	21.37
		1852.5	24.11	22.80	21.18
	1RB Middle (12)	1907.5	24.47	23.01	21.59
		1880	24.60	22.78	21.25
		1852.5	24.19	22.79	21.23
	1RB Low (0)	1907.5	24.50	22.69	21.49
		1880	24.27	22.63	21.23
		1852.5	24.05	22.77	21.19
	12RB High (13)	1907.5	23.13	22.28	20.67
		1880	23.35	22.29	20.33
		1852.5	23.24	22.22	20.37
	12RB Middle (6)	1907.5	23.31	22.39	20.45
		1880	23.19	22.30	20.37
		1852.5	23.17	22.07	20.45
	12RB Low (0)	1907.5	23.31	22.40	20.52
		1880	23.20	22.18	20.25
		1852.5	23.13	22.15	20.35
25RB (0)	1907.5	23.23	22.25	20.41	
	1880	23.28	22.33	20.35	
	1852.5	23.27	22.16	20.26	
10 MHz	1RB High (49)	1905	24.15	22.59	21.56
		1880	24.32	23.06	21.58
		1855	24.36	23.50	21.35
	1RB Middle (24)	1905	24.31	23.50	21.51
		1880	24.47	23.77	21.23
		1855	24.46	23.01	21.57
	1RB Low (0)	1905	24.11	23.25	21.38
		1880	24.25	23.41	21.43
		1855	24.30	22.69	21.30
	25RB High (25)	1905	23.11	22.37	20.69
		1880	23.19	22.38	20.56
		1855	23.42	22.57	20.34
	25RB Middle (12)	1905	23.31	22.49	20.56
		1880	23.23	22.25	20.67
		1855	23.31	22.43	20.39
	25RB Low (0)	1905	23.06	22.37	20.65
		1880	23.23	22.22	20.58
		1855	23.17	22.29	20.38
50RB (0)	1905	23.13	22.27	20.56	
	1880	23.20	22.20	20.52	
	1855	23.20	22.35	20.49	
15 MHz	1RB High (74)	1902.5	24.35	23.70	21.26
		1880	24.55	23.64	21.52
		1857.5	24.10	23.49	21.67
	1RB Middle (37)	1902.5	24.26	23.70	21.88
		1880	24.40	23.72	21.19
		1857.5	24.37	23.62	21.46

	1RB Low (0)	1902.5	24.13	23.23	21.40	
		1880	24.31	23.17	21.53	
		1857.5	24.09	23.01	21.28	
	36RB High (38)	1902.5	23.14	22.15	20.41	
		1880	23.20	22.16	20.45	
		1857.5	23.28	22.40	20.50	
	36RB Middle (19)	1902.5	23.05	22.27	20.30	
		1880	23.19	22.22	20.59	
		1857.5	23.33	22.36	20.58	
	36RB Low (0)	1902.5	22.99	21.93	20.45	
		1880	23.13	22.19	20.53	
		1857.5	23.18	22.32	20.54	
	75RB (0)	1902.5	22.97	22.12	20.28	
		1880	23.18	22.24	20.58	
		1857.5	23.25	22.35	20.48	
	20 MHz	1RB High (99)	1900	23.93	23.12	21.47
			1880	24.00	22.54	21.13
			1860	23.89	22.82	21.69
1RB Middle (50)		1900	24.20	23.05	21.65	
		1880	24.43	23.77	21.59	
		1860	24.27	23.33	21.39	
1RB Low (0)		1900	23.88	22.84	21.05	
		1880	23.91	23.06	21.46	
		1860	23.98	22.69	21.15	
50RB High (50)		1900	23.18	22.43	20.57	
		1880	23.16	22.17	20.49	
		1860	23.22	22.22	20.47	
50RB Middle (25)		1900	23.10	22.16	20.49	
		1880	23.16	22.18	20.57	
		1860	23.20	22.32	20.49	
50RB Low (0)		1900	22.97	21.96	20.63	
		1880	23.10	22.01	20.36	
		1860	23.20	22.09	20.63	
100RB (0)		1900	23.12	22.02	20.59	
		1880	23.17	22.13	20.30	
		1860	23.27	22.20	20.57	

Band 5						
Bandwidth (MHz)	RB allocation RB offset (Start RB)	Frequency (MHz)	QPSK	16QAM	64QAM	
			Actual output power (dBm)	Actual output power (dBm)	Actual output power (dBm)	
1.4 MHz	1RB High (5)	848.3	23.30	21.93	21.32	
		836.5	23.27	22.30	20.76	
		824.7	23.43	22.18	21.07	
	1RB Middle (3)	848.3	23.39	22.75	20.75	
		836.5	23.40	22.30	20.56	
		824.7	23.37	22.26	21.38	
	1RB Low (0)	848.3	23.33	21.80	20.65	
		836.5	23.28	22.10	20.59	
		824.7	23.36	22.17	20.59	
	3RB High (3)	848.3	23.21	22.17	20.55	
		836.5	23.39	22.53	20.58	
		824.7	23.44	22.31	20.61	
	3RB Middle (1)	848.3	23.24	22.22	20.52	
		836.5	23.46	22.40	20.58	
		824.7	23.49	22.26	20.95	
	3RB Low (0)	848.3	23.28	22.18	21.12	
		836.5	23.39	22.32	20.81	
		824.7	23.40	22.34	21.34	
	6RB (0)	848.3	22.27	21.27	19.97	
		836.5	22.32	21.36	19.80	
		824.7	22.36	21.59	20.06	
	3 MHz	1RB High (14)	847.5	23.08	22.16	20.79
			836.5	23.25	22.64	21.02
			825.5	23.23	22.40	20.86
		1RB Middle (7)	847.5	23.38	22.51	20.83
			836.5	23.47	22.67	20.70
			825.5	23.46	22.37	20.86
1RB Low (0)		847.5	23.44	22.41	20.76	
		836.5	23.37	22.60	20.80	
		825.5	23.32	22.43	20.81	
8RB High (7)		847.5	22.23	21.28	19.96	
		836.5	22.27	21.37	19.82	
		825.5	22.37	21.52	19.68	
8RB Middle (4)		847.5	22.20	21.52	20.13	
		836.5	22.38	21.40	19.81	
		825.5	22.38	21.55	20.12	
8RB Low (0)		847.5	22.29	21.61	19.93	
		836.5	22.32	21.44	20.02	
		825.5	22.28	21.54	20.01	
15RB (0)		847.5	22.27	21.52	19.90	
		836.5	22.23	21.21	19.76	
		825.5	22.33	21.51	19.94	
5 MHz		1RB High (24)	846.5	23.24	21.56	20.59
			836.5	23.10	21.90	20.63
			826.5	23.11	21.96	20.84

	1RB Middle (12)	846.5	23.34	21.61	20.81	
		836.5	23.15	21.90	20.67	
		826.5	23.35	22.08	20.57	
	1RB Low (0)	846.5	23.48	21.55	20.75	
		836.5	23.06	21.68	20.86	
		826.5	23.46	21.95	20.76	
	12RB High (13)	846.5	22.28	21.21	19.79	
		836.5	22.27	21.11	19.93	
		826.5	22.32	21.21	19.83	
	12RB Middle (6)	846.5	22.40	21.34	19.93	
		836.5	22.19	21.11	19.86	
		826.5	22.45	21.33	20.09	
	12RB Low (0)	846.5	22.31	21.22	19.68	
		836.5	22.18	21.12	19.74	
		826.5	22.36	21.34	19.98	
	25RB (0)	846.5	22.21	21.25	19.72	
		836.5	22.16	21.21	20.07	
		826.5	22.28	21.39	20.07	
	10 MHz	1RB High (49)	844.0	23.21	22.27	20.81
			836.5	23.44	22.27	20.93
			829.0	23.11	21.82	21.17
		1RB Middle (24)	844.0	23.59	22.41	20.89
			836.5	23.51	22.71	20.89
			829.0	23.53	22.77	21.26
1RB Low (0)		844.0	23.17	22.09	20.71	
		836.5	23.39	22.21	20.76	
		829.0	23.30	22.13	20.59	
25RB High (25)		844.0	22.21	21.35	20.07	
		836.5	22.28	21.25	20.17	
		829.0	22.22	21.26	19.82	
25RB Middle (12)		844.0	22.23	21.32	20.15	
		836.5	22.31	21.15	20.05	
		829.0	22.31	21.42	20.05	
25RB Low (0)		844.0	22.18	21.14	20.04	
		836.5	22.24	21.24	19.92	
		829.0	22.33	21.40	20.02	
50RB (0)		844.0	22.18	21.16	20.02	
		836.5	22.28	21.13	20.03	
		829.0	22.23	21.22	20.07	

Band 7					
Bandwidth (MHz)	RB allocation	Frequency (MHz)	QPSK	16QAM	64QAM
	RB offset (Start RB)		Actual output power (dBm)	Actual output power (dBm)	Actual output power (dBm)
5 MHz	1RB High (24)	2567.5	23.94	22.77	21.06
		2535	24.03	22.74	21.09
		2502.5	23.88	22.81	21.28
	1RB Middle (12)	2567.5	24.09	22.72	21.02
		2535	24.54	22.80	21.37
		2502.5	23.81	22.78	21.08
	1RB Low (0)	2567.5	23.89	23.00	21.16
		2535	24.10	22.49	21.07
		2502.5	24.27	22.81	21.17
	12RB High (13)	2567.5	23.03	21.92	20.35
		2535	23.16	22.17	20.17
		2502.5	23.14	21.97	20.15
	12RB Middle (6)	2567.5	23.15	22.06	20.32
		2535	23.10	22.14	20.03
		2502.5	23.16	22.09	20.27
	12RB Low (0)	2567.5	23.12	22.16	20.26
		2535	23.23	22.05	20.28
		2502.5	23.16	22.08	20.19
	25RB (0)	2567.5	23.06	22.08	20.01
		2535	23.21	22.23	21.18
		2502.5	23.19	22.03	20.17
10 MHz	1RB High (49)	2565	24.00	22.88	21.37
		2535	23.96	23.37	21.16
		2505	24.01	23.63	21.37
	1RB Middle (24)	2565	24.33	23.50	21.49
		2535	24.15	23.67	21.47
		2505	24.23	23.60	21.88
	1RB Low (0)	2565	23.95	23.31	21.37
		2535	23.78	23.67	21.02
		2505	23.87	23.10	21.36
	25RB High (25)	2565	22.95	22.16	20.09
		2535	23.15	22.15	20.14
		2505	23.07	22.11	20.17
	25RB Middle (12)	2565	23.15	22.34	20.13
		2535	23.08	22.08	20.06
		2505	22.98	22.24	20.15
	25RB Low (0)	2565	23.11	22.16	20.19
		2535	23.22	22.11	20.15
		2505	23.07	22.23	20.26
	50RB (0)	2565	23.09	22.09	20.13
		2535	23.16	22.13	20.37
		2505	23.09	22.18	20.16
15 MHz	1RB High (74)	2562.5	24.18	23.33	21.47
		2535	24.07	22.55	21.49
		2507.5	23.87	23.46	21.47

	1RB Middle (37)	2562.5	24.30	23.64	21.56	
		2535	24.10	22.70	21.48	
		2507.5	24.16	23.27	21.39	
	1RB Low (0)	2562.5	24.52	23.90	21.46	
		2535	24.11	23.05	21.54	
		2507.5	24.53	23.86	21.36	
	36RB High (38)	2562.5	23.10	22.22	20.19	
		2535	23.15	22.13	20.18	
		2507.5	23.13	22.15	20.28	
	36RB Middle (19)	2562.5	23.24	22.31	20.30	
		2535	23.14	22.10	20.25	
		2507.5	23.21	22.29	20.23	
	36RB Low (0)	2562.5	23.17	22.31	20.16	
		2535	23.24	22.24	20.28	
		2507.5	23.12	22.07	20.21	
	75RB (0)	2562.5	23.15	22.06	20.07	
		2535	23.19	22.16	20.03	
		2507.5	23.19	22.17	20.15	
	20 MHz	1RB High (99)	2560	24.02	23.19	21.11
			2535	23.89	22.65	21.58
			2510	23.53	22.58	21.36
1RB Middle (50)		2560	24.56	23.29	21.32	
		2535	24.04	23.08	21.43	
		2510	23.80	23.20	21.59	
1RB Low (0)		2560	24.51	23.03	21.37	
		2535	23.81	22.98	21.48	
		2510	23.78	22.84	21.47	
50RB High (50)		2560	23.06	21.91	20.16	
		2535	23.17	22.06	20.17	
		2510	23.02	22.06	20.15	
50RB Middle (25)		2560	23.09	22.04	20.28	
		2535	23.18	22.11	20.27	
		2510	23.00	22.13	20.18	
50RB Low (0)		2560	23.19	22.04	20.07	
		2535	23.18	22.11	20.19	
		2510	23.10	22.00	20.28	
100RB (0)		2560	23.13	22.11	20.27	
		2535	23.12	22.08	20.08	
		2510	23.06	22.02	20.21	

Band 12						
Bandwidth (MHz)	RB allocation RB offset (Start RB)	Frequency (MHz)	QPSK	16QAM	64QAM	
			Actual output power (dBm)	Actual output power (dBm)	Actual output power (dBm)	
1.4 MHz	1RB High (5)	715.3	23.30	22.63	20.91	
		707.5	23.07	22.29	20.77	
		699.7	23.06	22.04	21.03	
	1RB Middle (3)	715.3	23.42	22.23	20.94	
		707.5	23.62	22.42	21.02	
		699.7	23.19	22.21	20.85	
	1RB Low (0)	715.3	23.13	21.74	20.89	
		707.5	23.37	22.25	20.73	
		699.7	23.37	22.23	20.87	
	3RB High (3)	715.3	23.31	22.08	20.81	
		707.5	23.34	22.50	20.68	
		699.7	23.24	22.16	21.02	
	3RB Middle (1)	715.3	23.30	22.08	20.90	
		707.5	23.56	22.52	20.94	
		699.7	23.34	22.17	20.83	
	3RB Low (0)	715.3	23.30	22.20	20.92	
		707.5	23.44	22.57	20.73	
		699.7	23.17	22.30	20.91	
	6RB (0)	715.3	22.23	21.07	19.84	
		707.5	22.31	21.50	19.65	
		699.7	22.15	21.40	19.66	
	3 MHz	1RB High (14)	714.5	23.42	22.46	20.84
			707.5	23.29	22.07	20.70
			700.5	23.29	22.56	20.99
		1RB Middle (7)	714.5	23.28	22.15	20.86
			707.5	23.49	22.43	21.00
			700.5	23.30	22.24	20.87
1RB Low (0)		714.5	23.53	22.38	20.92	
		707.5	23.44	22.56	20.68	
		700.5	23.39	22.38	20.86	
8RB High (7)		714.5	22.25	21.35	19.90	
		707.5	22.28	21.41	19.91	
		700.5	22.36	21.48	19.70	
8RB Middle (4)		714.5	22.29	21.27	19.87	
		707.5	22.34	20.97	19.68	
		700.5	22.16	21.21	19.73	
8RB Low (0)		714.5	22.23	21.26	19.78	
		707.5	22.28	21.53	19.78	
		700.5	22.25	21.38	19.66	
15RB (0)		714.5	22.29	21.22	19.94	
		707.5	22.36	21.31	19.75	
		700.5	22.26	21.22	19.64	
5 MHz		1RB High (24)	713.5	23.30	21.69	20.85
			707.5	22.97	21.73	20.70
			701.5	23.01	21.84	20.91

	1RB Middle (12)	713.5	23.63	21.58	20.92	
		707.5	23.45	21.89	20.98	
		701.5	23.19	22.25	20.84	
	1RB Low (0)	713.5	23.66	21.66	20.85	
		707.5	23.06	21.78	20.65	
		701.5	23.61	21.93	20.90	
	12RB High (13)	713.5	22.19	21.28	19.96	
		707.5	22.33	21.09	19.85	
		701.5	22.12	21.02	19.70	
	12RB Middle (6)	713.5	22.23	21.11	19.86	
		707.5	22.35	21.21	19.76	
		701.5	22.25	21.04	19.79	
	12RB Low (0)	713.5	22.29	21.21	19.78	
		707.5	22.28	21.07	19.74	
		701.5	22.29	21.08	19.72	
	25RB (0)	713.5	22.21	21.32	19.90	
		707.5	22.29	21.29	19.74	
		701.5	22.17	20.97	19.68	
	10 MHz	1RB High (49)	711	23.36	22.33	20.89
			707.5	23.32	21.55	20.75
			704	23.30	22.16	20.98
		1RB Middle (24)	711	23.41	22.62	20.91
			707.5	23.64	22.81	20.98
			704	23.25	22.16	20.90
1RB Low (0)		711	23.43	22.66	20.89	
		707.5	23.29	22.43	20.70	
		704	23.22	22.28	20.92	
25RB High (25)		711	22.28	21.43	19.94	
		707.5	22.34	21.29	19.89	
		704	22.24	21.14	19.69	
25RB Middle (12)		711	22.34	21.27	19.92	
		707.5	22.37	21.41	19.73	
		704	22.12	21.37	19.75	
25RB Low (0)		711	22.33	21.33	19.79	
		707.5	22.32	21.23	19.78	
		704	22.06	21.09	19.73	
50RB (0)		711	22.34	21.38	19.91	
		707.5	22.18	21.22	19.71	
		704	22.15	21.13	19.68	

Band 38					
Bandwidth (MHz)	RB allocation	Frequency (MHz)	QPSK	16QAM	64QAM
	RB offset (Start RB)		Actual output power (dBm)	Actual output power (dBm)	Actual output power (dBm)
5 MHz	1RB High (24)	2617.5	23.40	22.40	20.51
		2595	23.32	21.99	20.55
		2572.5	23.19	22.06	20.54
	1RB Middle (12)	2617.5	23.71	22.68	20.56
		2595	23.64	22.33	20.50
		2572.5	23.52	22.54	20.51
	1RB Low (0)	2617.5	23.39	22.24	20.66
		2595	23.40	22.03	20.61
		2572.5	23.42	22.14	20.55
	12RB High (13)	2617.5	22.66	21.60	19.75
		2595	22.65	21.66	19.74
		2572.5	22.49	21.54	19.54
	12RB Middle (6)	2617.5	22.69	21.63	19.77
		2595	22.75	21.73	19.83
		2572.5	22.61	21.47	19.61
	12RB Low (0)	2617.5	22.60	21.55	19.78
		2595	22.62	21.72	19.76
		2572.5	22.65	21.39	19.68
	25RB (0)	2617.5	22.67	21.47	19.96
		2595	22.65	21.60	19.83
		2572.5	22.63	21.50	19.67
10 MHz	1RB High (49)	2615	23.33	23.32	20.51
		2595	23.40	22.87	20.63
		2575	23.39	22.36	20.50
	1RB Middle (24)	2615	23.62	23.28	20.66
		2595	23.54	23.09	20.65
		2575	23.57	21.92	20.57
	1RB Low (0)	2615	23.52	23.35	20.62
		2595	23.24	22.72	20.52
		2575	23.27	21.85	20.53
	25RB High (25)	2615	22.54	21.68	19.84
		2595	22.75	21.58	20.09
		2575	22.64	21.54	19.87
	25RB Middle (12)	2615	22.64	21.47	19.89
		2595	22.68	21.78	20.11
		2575	22.69	21.57	19.91
	25RB Low (0)	2615	22.45	21.46	19.77
		2595	22.59	21.61	20.05
		2575	22.66	21.40	19.89
	50RB (0)	2615	22.49	21.54	19.75
		2595	22.62	21.47	19.89
		2575	22.64	21.61	19.67
15 MHz	1RB High (74)	2612.5	23.23	22.33	20.55
		2595	23.17	22.34	20.50
		2577.5	23.14	22.43	20.57

	1RB Middle (37)	2612.5	23.50	22.66	20.56	
		2595	23.55	22.88	20.67	
		2577.5	23.49	22.13	20.55	
	1RB Low (0)	2612.5	23.46	22.60	20.67	
		2595	23.28	22.76	20.59	
		2577.5	23.31	22.07	20.55	
	36RB High (38)	2612.5	22.59	21.42	19.86	
		2595	22.59	21.42	19.76	
		2577.5	22.56	21.55	19.57	
	36RB Middle (19)	2612.5	22.67	21.52	19.72	
		2595	22.66	21.55	19.74	
		2577.5	22.73	21.65	19.66	
	36RB Low (0)	2612.5	22.47	21.51	19.89	
		2595	22.54	21.48	19.72	
		2577.5	22.71	21.57	19.55	
	75RB (0)	2612.5	22.52	21.63	19.95	
		2595	22.61	21.65	19.65	
		2577.5	22.51	21.63	19.62	
	20 MHz	1RB High (99)	2610	23.46	21.77	20.56
			2595	23.01	22.31	20.53
			2580	22.97	21.97	20.57
1RB Middle (50)		2610	24.04	22.12	20.67	
		2595	23.86	23.31	20.58	
		2580	23.62	22.50	20.55	
1RB Low (0)		2610	23.59	21.93	20.51	
		2595	23.45	22.63	20.53	
		2580	23.16	22.23	20.60	
50RB High (50)		2610	22.53	21.50	19.91	
		2595	22.59	21.56	19.79	
		2580	22.55	21.56	19.75	
50RB Middle (25)		2610	22.67	21.56	19.93	
		2595	22.80	21.61	19.92	
		2580	22.68	21.59	19.88	
50RB Low (0)		2610	22.58	21.58	19.87	
		2595	22.62	21.62	19.90	
		2580	22.64	21.72	19.87	
100RB (0)		2610	22.55	21.46	19.89	
		2595	22.62	21.53	19.92	
		2580	22.67	21.55	19.92	

Band 66					
Bandwidth (MHz)	RB allocation	Frequency (MHz)	QPSK	16QAM	64QAM
	RB offset (Start RB)		Actual output power (dBm)	Actual output power (dBm)	Actual output power (dBm)
1.4 MHz	1RB High (5)	1779.3	24.08	23.26	21.79
		1745	24.11	23.11	21.94
		1710.7	24.18	22.79	21.92
	1RB Middle (3)	1779.3	24.15	23.39	21.69
		1745	24.27	22.89	21.95
		1710.7	24.21	23.67	21.83
	1RB Low (0)	1779.3	24.31	23.24	21.82
		1745	24.20	22.87	21.92
		1710.7	24.05	22.78	21.93
	3RB High (3)	1779.3	24.24	23.46	21.80
		1745	24.24	22.98	21.87
		1710.7	24.21	22.75	21.88
	3RB Middle (1)	1779.3	24.23	23.50	21.77
		1745	24.33	22.82	21.90
		1710.7	24.26	23.22	21.79
	3RB Low (0)	1779.3	24.25	23.37	21.89
		1745	24.27	23.13	21.99
		1710.7	24.30	23.35	21.83
	6RB (0)	1779.3	23.19	22.28	20.62
		1745	23.21	22.50	20.75
		1710.7	23.26	22.05	20.73
3 MHz	1RB High (14)	1778.5	24.12	23.38	21.75
		1745	24.20	23.19	21.90
		1711.5	24.21	23.50	21.97
	1RB Middle (7)	1778.5	24.37	23.36	21.69
		1745	24.27	23.01	21.93
		1711.5	24.24	22.95	21.85
	1RB Low (0)	1778.5	24.25	23.33	21.83
		1745	24.33	23.17	21.94
		1711.5	24.20	22.83	21.94
	8RB High (7)	1778.5	23.22	21.95	20.72
		1745	23.23	21.91	20.72
		1711.5	23.20	22.26	20.59
	8RB Middle (4)	1778.5	23.13	22.21	20.69
		1745	23.23	21.96	20.72
		1711.5	23.24	22.31	20.73
	8RB Low (0)	1778.5	23.09	22.17	20.72
		1745	23.16	21.84	20.81
		1711.5	23.11	22.27	20.65
15RB (0)	1778.5	23.22	22.24	20.61	
	1745	23.17	22.16	20.77	
	1711.5	23.20	22.28	20.67	
5 MHz	1RB High (24)	1777.5	24.35	22.57	21.80
		1745	23.94	23.04	21.88
		1712.5	23.94	22.83	21.93

	1RB Middle (12)	1777.5	24.36	22.46	21.71	
		1745	24.01	22.78	21.97	
		1712.5	24.22	22.98	21.83	
	1RB Low (0)	1777.5	24.17	22.78	21.80	
		1745	23.80	22.89	21.90	
		1712.5	24.10	22.79	21.92	
	12RB High (13)	1777.5	23.10	22.22	20.71	
		1745	23.10	22.04	20.70	
		1712.5	23.00	21.94	20.56	
	12RB Middle (6)	1777.5	23.12	22.22	20.65	
		1745	23.16	22.09	20.77	
		1712.5	23.25	22.03	20.75	
	12RB Low (0)	1777.5	23.21	22.31	20.73	
		1745	23.19	22.24	20.85	
		1712.5	23.25	22.12	20.62	
	25RB (0)	1777.5	23.23	22.38	20.61	
		1745	23.21	22.26	20.80	
		1712.5	23.22	22.12	20.75	
	10 MHz	1RB High (49)	1775	24.12	23.15	21.73
			1745	24.26	23.25	21.88
			1715	24.08	22.95	21.88
		1RB Middle (24)	1775	24.36	23.35	21.77
			1745	24.44	23.65	21.90
			1715	24.28	22.82	21.81
1RB Low (0)		1775	24.33	23.16	21.81	
		1745	24.41	23.31	21.92	
		1715	24.27	23.19	21.89	
25RB High (25)		1775	23.01	22.46	20.71	
		1745	23.07	22.16	20.73	
		1715	23.13	22.30	20.53	
25RB Middle (12)		1775	23.16	22.44	20.71	
		1745	23.18	22.36	20.74	
		1715	23.08	22.24	20.66	
25RB Low (0)		1775	23.18	22.28	20.72	
		1745	23.23	22.25	20.77	
		1715	23.20	22.32	20.66	
50RB (0)		1775	23.20	22.26	20.65	
		1745	23.17	22.24	20.78	
		1715	23.12	22.24	20.75	
15 MHz		1RB High (74)	1772.5	24.24	23.34	21.97
			1745	23.97	23.47	21.97
			1717.5	24.07	23.99	21.47
	1RB Middle (37)	1772.5	24.37	23.22	21.65	
		1745	24.16	22.91	21.80	
		1717.5	23.99	23.69	21.69	
	1RB Low (0)	1772.5	24.35	23.25	21.48	
		1745	24.25	22.90	21.91	
		1717.5	24.07	23.99	21.63	

	36RB High (38)	1772.5	23.22	22.17	20.77
		1745	23.10	22.12	20.91
		1717.5	23.19	22.23	20.81
	36RB Middle (19)	1772.5	23.16	22.04	20.69
		1745	23.18	22.31	20.86
		1717.5	23.07	22.12	20.78
	36RB Low (0)	1772.5	23.10	22.00	20.68
		1745	23.12	22.27	20.83
		1717.5	23.09	22.16	20.78
	75RB (0)	1772.5	23.08	22.09	20.56
		1745	23.18	22.24	20.67
		1717.5	23.19	22.28	20.65
20 MHz	1RB High (99)	1770	23.95	22.91	21.78
		1745	24.12	23.08	21.92
		1720	23.75	23.10	21.93
	1RB Middle (50)	1770	23.96	23.06	21.73
		1745	24.42	22.88	21.97
		1720	24.03	22.61	21.86
	1RB Low (0)	1770	23.92	22.70	21.86
		1745	24.25	22.94	21.95
		1720	24.05	22.54	21.90
	50RB High (50)	1770	23.01	22.13	20.76
		1745	23.15	21.99	20.74
		1720	23.14	22.09	20.59
	50RB Middle (25)	1770	23.12	22.24	20.69
		1745	23.11	22.31	20.76
		1720	23.23	22.19	20.72
	50RB Low (0)	1770	23.05	22.20	20.78
		1745	23.17	22.32	20.83
		1720	23.11	22.07	20.67
	100RB (0)	1770	23.00	22.17	20.64
		1745	23.11	22.28	20.83
		1720	23.14	22.12	20.73

Table 11.3-3: The conducted Power for LTE – Low power

Band 2						
Bandwidth (MHz)	RB allocation	Frequency (MHz)	QPSK	16QAM	64QAM	
	RB offset (Start RB)		Actual output power (dBm)	Actual output power (dBm)	Actual output power (dBm)	
1.4 MHz	1RB High (5)	1909.3	20.85	19.94	19.09	
		1880	20.98	20.20	19.08	
		1850.7	20.88	20.07	19.08	
	1RB Middle (3)	1909.3	20.89	20.16	19.34	
		1880	20.96	20.13	19.16	
		1850.7	21.06	20.09	19.21	
	1RB Low (0)	1909.3	20.92	20.04	19.18	
		1880	20.97	20.29	19.26	
		1850.7	20.89	20.05	19.02	
	3RB High (3)	1909.3	20.93	20.01	19.08	
		1880	21.11	20.27	19.03	
		1850.7	20.99	19.92	19.08	
	3RB Middle (1)	1909.3	21.04	20.13	19.30	
		1880	21.07	20.42	19.17	
		1850.7	21.09	20.02	19.24	
	3RB Low (0)	1909.3	21.01	19.72	19.18	
		1880	21.12	20.21	19.23	
		1850.7	21.03	20.23	18.95	
	6RB (0)	1909.3	20.11	19.15	17.75	
		1880	20.00	19.05	17.61	
		1850.7	20.15	19.16	17.61	
	3 MHz	1RB High (14)	1908.5	21.14	19.75	19.10
			1880	21.08	19.71	19.04
			1851.5	20.99	19.95	19.11
1RB Middle (7)		1908.5	21.26	20.21	19.33	
		1880	21.24	20.35	19.07	
		1851.5	21.19	20.16	19.21	
1RB Low (0)		1908.5	21.22	20.19	19.15	
		1880	21.17	20.29	19.25	
		1851.5	21.20	20.08	18.96	
8RB High (7)		1908.5	20.00	19.07	17.70	
		1880	20.06	19.11	17.62	
		1851.5	20.06	19.07	17.59	
8RB Middle (4)		1908.5	20.08	19.42	17.78	
		1880	20.02	19.27	17.60	
		1851.5	20.12	19.02	17.91	
8RB Low (0)		1908.5	20.03	19.04	17.71	
		1880	20.01	19.16	17.54	
		1851.5	20.08	19.11	17.63	
15RB (0)		1908.5	20.06	18.96	17.80	
		1880	20.01	19.15	17.68	
		1851.5	20.11	18.94	17.67	

5 MHz	1RB High (24)	1907.5	21.02	19.68	19.08	
		1880	21.11	19.93	19.04	
		1852.5	20.86	19.79	19.16	
	1RB Middle (12)	1907.5	21.29	19.78	19.33	
		1880	21.37	20.20	19.10	
		1852.5	21.14	19.78	19.27	
	1RB Low (0)	1907.5	21.11	19.72	19.16	
		1880	21.07	19.69	19.24	
		1852.5	20.88	19.72	19.03	
	12RB High (13)	1907.5	20.02	18.89	17.65	
		1880	20.07	19.14	17.56	
		1852.5	20.15	19.12	17.55	
	12RB Middle (6)	1907.5	20.09	18.98	17.73	
		1880	20.15	19.22	17.59	
		1852.5	20.17	19.15	17.91	
	12RB Low (0)	1907.5	20.05	19.00	17.73	
		1880	20.12	19.19	17.57	
		1852.5	20.11	19.09	17.58	
	25RB (0)	1907.5	20.06	18.87	17.76	
		1880	20.04	19.24	17.70	
		1852.5	20.14	19.15	17.65	
	10 MHz	1RB High (49)	1905	20.83	19.74	19.05
			1880	21.16	20.21	19.01
			1855	21.28	19.90	19.10
		1RB Middle (24)	1905	21.09	20.28	19.26
			1880	21.19	20.57	19.14
			1855	21.43	20.38	19.27
1RB Low (0)		1905	21.04	20.17	19.14	
		1880	21.12	20.15	19.24	
		1855	21.16	19.63	19.01	
25RB High (25)		1905	20.03	19.10	17.66	
		1880	20.15	19.08	17.57	
		1855	20.20	19.15	17.59	
25RB Middle (12)		1905	20.06	19.14	17.71	
		1880	20.16	19.10	17.56	
		1855	20.20	19.32	17.87	
25RB Low (0)		1905	20.00	19.03	17.72	
		1880	20.06	19.10	17.61	
		1855	19.99	19.15	17.61	
50RB (0)		1905	19.93	18.97	17.81	
		1880	20.02	19.02	17.63	
		1855	19.95	19.01	17.65	
15 MHz		1RB High (74)	1902.5	21.05	20.06	19.13
			1880	21.02	20.15	19.00
			1857.5	20.90	20.31	19.14
		1RB Middle (37)	1902.5	21.21	20.85	19.28
			1880	21.07	20.57	19.10
			1857.5	21.03	20.25	19.21

	1RB Low (0)	1902.5	21.10	20.20	19.11
		1880	21.18	19.91	19.26
		1857.5	20.96	19.56	18.97
	36RB High (38)	1902.5	19.95	18.90	17.64
		1880	20.01	19.00	17.55
		1857.5	20.07	19.21	17.51
	36RB Middle (19)	1902.5	20.02	19.05	17.74
		1880	20.00	19.00	17.57
		1857.5	20.12	19.30	17.89
	36RB Low (0)	1902.5	19.92	18.92	17.67
		1880	19.99	18.89	17.61
		1857.5	19.84	19.02	17.62
	75RB (0)	1902.5	19.95	18.90	17.82
		1880	19.92	19.01	17.67
		1857.5	19.89	19.04	17.66
20 MHz	1RB High (99)	1900	20.95	19.53	19.11
		1880	20.90	19.52	19.06
		1860	20.58	19.59	19.15
	1RB Middle (50)	1900	21.16	20.16	19.31
		1880	21.31	20.23	19.13
		1860	21.16	20.26	19.24
	1RB Low (0)	1900	21.10	19.64	19.16
		1880	20.88	19.83	19.29
		1860	20.86	19.51	19.01
	50RB High (50)	1900	20.03	19.12	17.69
		1880	20.08	18.93	17.59
		1860	20.03	19.04	17.56
	50RB Middle (25)	1900	20.03	19.11	17.76
		1880	20.10	19.12	17.61
		1860	20.09	19.21	17.91
	50RB Low (0)	1900	19.91	18.80	17.71
		1880	19.87	18.85	17.58
		1860	19.87	19.01	17.61
	100RB (0)	1900	19.98	18.99	17.79
		1880	19.97	19.06	17.67
		1860	19.88	19.03	17.65

Band 7					
Bandwidth (MHz)	RB allocation	Frequency (MHz)	QPSK	16QAM	64QAM
	RB offset (Start RB)		Actual output power (dBm)	Actual output power (dBm)	Actual output power (dBm)
5 MHz	1RB High (24)	2567.5	23.20	21.84	20.12
		2535	23.12	22.07	20.30
		2502.5	23.30	22.19	20.19
	1RB Middle (12)	2567.5	23.60	21.90	20.74
		2535	23.12	22.15	20.69
		2502.5	23.34	22.17	20.69
	1RB Low (0)	2567.5	23.18	22.17	20.23
		2535	23.31	22.52	20.19
		2502.5	23.41	22.06	20.45
	12RB High (13)	2567.5	22.33	21.20	19.44
		2535	22.38	21.36	19.16
		2502.5	22.44	21.42	19.36
	12RB Middle (6)	2567.5	22.34	21.17	19.26
		2535	22.41	21.23	19.21
		2502.5	22.44	21.41	19.49
	12RB Low (0)	2567.5	22.39	21.51	19.22
		2535	22.44	21.29	19.25
		2502.5	22.34	21.51	19.41
	25RB (0)	2567.5	22.28	21.52	19.15
		2535	22.47	21.48	19.01
		2502.5	22.45	21.44	19.18
10 MHz	1RB High (49)	2565	23.45	22.51	20.10
		2535	23.37	22.16	20.34
		2505	23.17	22.35	20.20
	1RB Middle (24)	2565	23.70	22.97	20.75
		2535	23.54	21.94	20.70
		2505	23.64	22.79	20.76
	1RB Low (0)	2565	23.56	22.45	20.25
		2535	23.53	22.23	20.19
		2505	23.52	22.47	20.40
	25RB High (25)	2565	22.38	21.34	19.43
		2535	22.45	21.39	19.15
		2505	22.51	21.50	19.37
	25RB Middle (12)	2565	22.44	21.40	19.26
		2535	22.47	21.55	19.20
		2505	22.56	21.56	19.56
	25RB Low (0)	2565	22.43	21.49	19.24
		2535	22.42	21.56	19.24
		2505	22.80	21.55	19.35
	50RB (0)	2565	22.32	21.36	19.22
		2535	22.45	21.44	19.03
		2505	22.41	21.42	19.13
15 MHz	1RB High (74)	2562.5	23.42	22.85	20.11
		2535	23.71	22.67	20.28
		2507.5	23.37	22.12	20.22

	1RB Middle (37)	2562.5	23.45	22.99	20.80	
		2535	23.68	22.63	20.75	
		2507.5	23.45	22.35	20.76	
	1RB Low (0)	2562.5	23.64	23.00	20.22	
		2535	23.93	22.90	20.22	
		2507.5	23.53	22.53	20.41	
	36RB High (38)	2562.5	22.43	21.37	19.41	
		2535	22.46	21.37	19.15	
		2507.5	22.44	21.59	19.39	
	36RB Middle (19)	2562.5	22.32	21.24	19.29	
		2535	22.37	21.30	19.20	
		2507.5	22.46	21.61	19.47	
	36RB Low (0)	2562.5	22.33	21.17	19.25	
		2535	22.35	21.27	19.24	
		2507.5	22.52	21.59	19.32	
	75RB (0)	2562.5	22.40	21.41	19.13	
		2535	22.38	21.32	19.01	
		2507.5	22.41	21.45	19.17	
	20 MHz	1RB High (99)	2560	22.75	22.00	20.13
			2535	23.29	22.01	20.31
			2510	22.94	22.30	20.22
1RB Middle (50)		2560	23.26	22.08	20.78	
		2535	23.38	22.22	20.73	
		2510	23.10	22.39	20.72	
1RB Low (0)		2560	23.03	21.76	20.28	
		2535	23.39	22.08	20.25	
		2510	23.05	22.20	20.46	
50RB High (50)		2560	22.30	21.41	19.42	
		2535	22.36	21.42	19.16	
		2510	22.38	21.27	19.41	
50RB Middle (25)		2560	22.38	21.39	19.29	
		2535	22.41	21.54	19.25	
		2510	22.52	21.32	19.52	
50RB Low (0)		2560	22.43	21.43	19.27	
		2535	22.42	21.41	19.22	
		2510	22.39	21.32	19.38	
100RB (0)		2560	22.37	21.43	19.19	
		2535	22.36	21.42	19.03	
		2510	22.41	21.34	19.17	

Band 66						
Bandwidth (MHz)	RB allocation	Frequency (MHz)	QPSK	16QAM	64QAM	
	RB offset (Start RB)		Actual output power (dBm)	Actual output power (dBm)	Actual output power (dBm)	
1.4 MHz	1RB High (5)	1779.3	21.88	21.09	19.69	
		1745	22.02	20.95	19.25	
		1710.7	21.95	21.15	19.42	
	1RB Middle (3)	1779.3	22.09	21.30	19.81	
		1745	22.07	21.03	19.31	
		1710.7	22.32	21.13	19.74	
	1RB Low (0)	1779.3	21.94	21.17	19.70	
		1745	21.92	20.76	19.82	
		1710.7	22.01	20.74	19.61	
	3RB High (3)	1779.3	22.00	21.24	19.69	
		1745	22.09	21.02	19.30	
		1710.7	22.12	20.93	19.51	
	3RB Middle (1)	1779.3	22.16	21.69	19.89	
		1745	22.15	21.02	19.30	
		1710.7	22.24	20.98	19.68	
	3RB Low (0)	1779.3	22.06	21.72	19.79	
		1745	22.15	20.76	19.72	
		1710.7	22.11	21.25	19.60	
	6RB (0)	1779.3	21.13	20.64	18.49	
		1745	21.01	19.98	18.53	
		1710.7	21.07	19.91	18.38	
	3 MHz	1RB High (14)	1778.5	22.14	21.23	19.68
			1745	22.22	20.85	19.26
			1711.5	22.01	21.13	19.51
1RB Middle (7)		1778.5	22.16	21.26	19.83	
		1745	22.19	21.20	19.28	
		1711.5	22.09	21.29	19.69	
1RB Low (0)		1778.5	22.12	21.24	19.70	
		1745	22.28	20.86	19.77	
		1711.5	22.11	20.65	19.55	
8RB High (7)		1778.5	20.98	20.08	18.45	
		1745	21.08	20.11	18.68	
		1711.5	21.05	19.89	18.54	
8RB Middle (4)		1778.5	21.07	20.30	18.45	
		1745	21.05	19.76	18.61	
		1711.5	21.07	20.01	18.53	
8RB Low (0)		1778.5	21.14	20.06	18.50	
		1745	21.11	19.85	18.58	
		1711.5	21.03	20.05	18.48	
15RB (0)		1778.5	21.15	20.09	18.51	
		1745	21.04	19.98	18.47	
		1711.5	21.04	20.12	18.38	
5 MHz		1RB High (24)	1777.5	22.10	21.12	19.77
			1745	21.77	20.90	19.22
			1712.5	21.89	20.74	19.50

	1RB Middle (12)	1777.5	22.24	20.83	19.91	
		1745	22.14	20.77	19.27	
		1712.5	22.03	20.92	19.70	
	1RB Low (0)	1777.5	22.18	20.90	19.75	
		1745	22.01	20.99	19.76	
		1712.5	21.89	20.73	19.57	
	12RB High (13)	1777.5	21.18	20.19	18.43	
		1745	21.02	20.00	18.68	
		1712.5	21.01	19.98	18.55	
	12RB Middle (6)	1777.5	21.25	20.24	18.43	
		1745	21.08	20.03	18.62	
		1712.5	21.12	20.10	18.49	
	12RB Low (0)	1777.5	21.24	20.22	18.53	
		1745	21.13	20.02	18.51	
		1712.5	21.12	19.95	18.49	
	25RB (0)	1777.5	21.16	20.36	18.49	
		1745	21.15	19.96	18.56	
		1712.5	21.12	19.96	18.44	
	10 MHz	1RB High (49)	1775	22.27	21.16	19.71
			1745	22.39	21.16	19.27
			1715	22.05	20.79	19.44
		1RB Middle (24)	1775	22.42	21.41	19.85
			1745	22.44	21.33	19.28
			1715	22.22	20.76	19.73
1RB Low (0)		1775	22.39	21.21	19.71	
		1745	22.40	21.28	19.73	
		1715	21.99	20.75	19.58	
25RB High (25)		1775	21.19	20.19	18.46	
		1745	21.23	20.30	18.64	
		1715	21.10	20.04	18.55	
25RB Middle (12)		1775	21.06	20.35	18.43	
		1745	21.14	20.02	18.61	
		1715	21.14	20.09	18.54	
25RB Low (0)		1775	21.13	20.28	18.47	
		1745	21.23	20.19	18.55	
		1715	21.13	20.13	18.55	
50RB (0)		1775	21.16	20.19	18.52	
		1745	21.25	20.19	18.52	
		1715	21.09	20.01	18.47	
15 MHz		1RB High (74)	1772.5	22.34	21.19	19.67
			1745	22.00	21.07	19.29
			1717.5	22.12	21.83	19.48
	1RB Middle (37)	1772.5	22.37	21.54	19.81	
		1745	21.91	21.11	19.29	
		1717.5	21.81	21.72	19.72	
	1RB Low (0)	1772.5	22.30	21.32	19.74	
		1745	22.01	21.57	19.74	
		1717.5	22.00	21.72	19.60	

	36RB High (38)	1772.5	21.25	20.06	18.43
		1745	21.16	20.07	18.62
		1717.5	21.17	20.07	18.61
	36RB Middle (19)	1772.5	21.17	20.07	18.37
		1745	21.10	20.10	18.60
		1717.5	21.07	20.08	18.47
	36RB Low (0)	1772.5	21.16	20.07	18.51
		1745	21.21	20.24	18.55
		1717.5	20.97	19.91	18.49
	75RB (0)	1772.5	21.08	20.08	18.45
		1745	21.14	20.09	18.52
		1717.5	20.99	19.95	18.40
20 MHz	1RB High (99)	1770	22.21	21.10	19.73
		1745	22.02	20.67	19.27
		1720	21.87	20.92	19.47
	1RB Middle (50)	1770	22.32	21.09	19.87
		1745	22.19	20.86	19.28
		1720	22.13	20.71	19.72
	1RB Low (0)	1770	22.18	20.71	19.75
		1745	21.97	20.63	19.79
		1720	21.74	20.59	19.57
	50RB High (50)	1770	21.10	19.89	18.49
		1745	21.14	20.06	18.65
		1720	21.10	20.10	18.58
	50RB Middle (25)	1770	21.10	20.25	18.43
		1745	21.12	20.16	18.62
		1720	21.18	20.17	18.52
	50RB Low (0)	1770	21.14	20.20	18.52
		1745	21.20	20.08	18.56
		1720	21.04	20.04	18.53
	100RB (0)	1770	21.09	20.07	18.51
		1745	21.15	20.13	18.53
		1720	21.09	20.10	18.44



11.4 Wi-Fi and BT Measurement result

The tune up of BT is 7dBm.

The average conducted power for Wi-Fi is as following:

802.11b (dBm)

Channel\data rate	1Mbps	2Mbps	5.5Mbps	11Mbps
11	16.92	/	/	/
6	17.03	16.85	16.83	16.82
1	16.75	/	/	/
Tune up	18	18	18	18

802.11g (dBm)

Channel\data rate	6Mbps	9Mbps	12Mbps	18Mbps	24Mbps	36Mbps	48Mbps	54Mbps
11	15.08	/	/	/	/	/	/	/
6	15.17	14.87	14.84	14.82	14.77	14.74	14.71	14.70
1	14.96	/	/	/	/	/	/	/
Tune up	16	16	16	16	16	16	16	16

802.11n (dBm) - HT20 (2.4G)

Channel\data rate	MCS0	MCS1	MCS2	MCS3	MCS4	MCS5	MCS6	MCS7
11	12.89	/	/	/	/	/	/	/
6	13.02	12.99	12.97	12.92	12.91	12.89	12.88	12.87
1	12.82	/	/	/	/	/	/	/
Tune up	14	14	14	14	14	14	14	14

12 Simultaneous TX SAR Considerations

12.1 Introduction

The following procedures adopted from “FCC SAR Considerations for Cell Phones with Multiple Transmitters” are applicable to handsets with built-in unlicensed transmitters such as 802.11 a/b/g and Bluetooth devices which may simultaneously transmit with the licensed transmitter.

For this device, the BT and Wi-Fi can transmit simultaneous with other transmitters.

12.2 Transmit Antenna Separation Distances

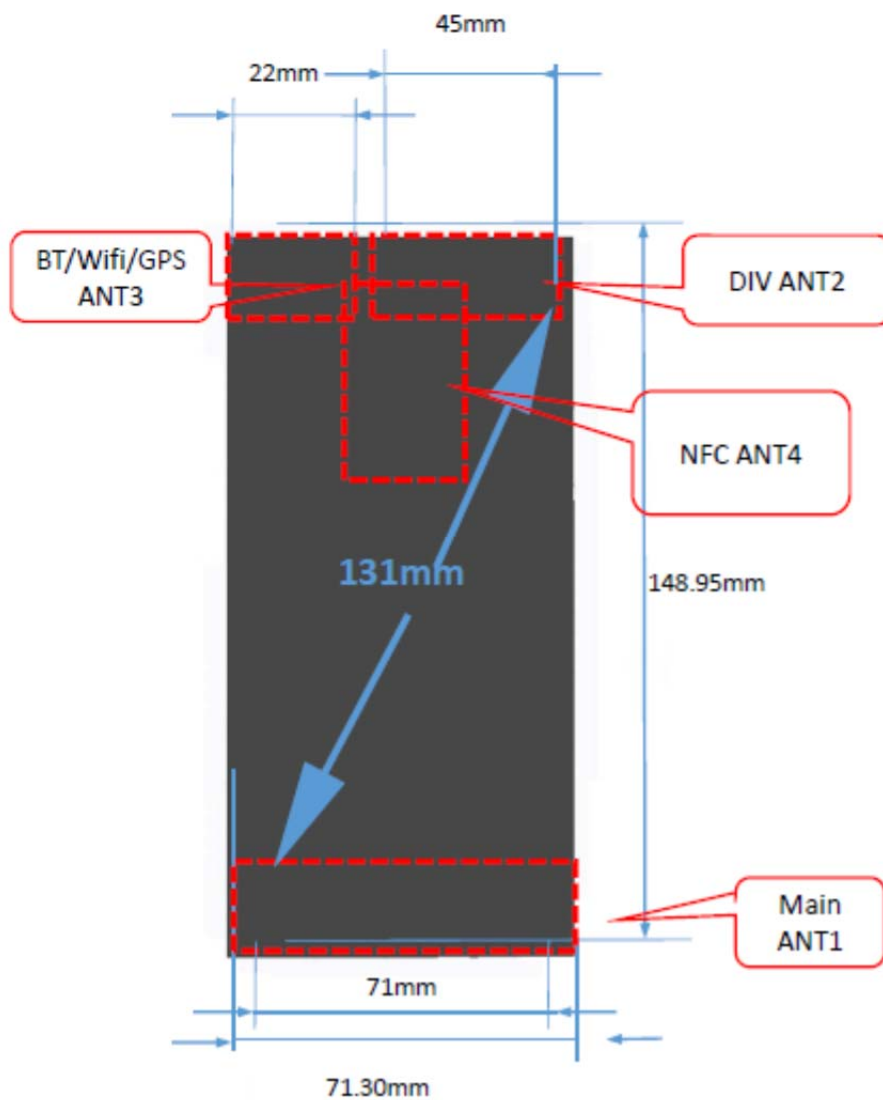

Picture 12.1 Antenna Locations

12.3 SAR Measurement Positions

According to the KDB941225 D06 Hot Spot SAR v01, the edges with less than 2.5 cm distance to the antennas need to be tested for SAR.

SAR measurement positions						
Mode	Front	Rear	Left edge	Right edge	Top edge	Bottom edge
Main antenna	Yes	Yes	Yes	Yes	No	Yes
WLAN	Yes	Yes	No	Yes	Yes	No

12.4 Standalone SAR Test Exclusion Considerations

Standalone 1-g head or body SAR evaluation by measurement or numerical simulation is not required when the corresponding SAR Exclusion Threshold condition, listed below, is satisfied. The 1-g SAR test exclusion threshold for 100 MHz to 6 GHz at test separation distances ≤ 50 mm are determined by:

$$[(\text{max. power of channel, including tune-up tolerance, mW}) / (\text{min. test separation distance, mm})] \cdot [\sqrt{f(\text{GHz})}] \leq 3.0 \text{ for 1-g SAR, where}$$

- $f(\text{GHz})$ is the RF channel transmit frequency in GHz
- Power and distance are rounded to the nearest mW and mm before calculation
- The result is rounded to one decimal place for comparison

Table 12.1: Standalone SAR test exclusion considerations

Band/Mode	F(GHz)	Position	SAR test exclusion threshold(mW)	RF output power		SAR test exclusion
				dBm	mW	
Bluetooth	2.441	Head	9.60	7	5.01	Yes
		Body	19.20	7	5.01	Yes
2.4GHz WLAN	2.45	Head	9.58	18	63.10	No
		Body	19.17	18	63.10	No

13 Evaluation of Simultaneous

Table 13.1: The sum of reported SAR values for main antenna and WiFi

	Position	Main antenna	WiFi	Sum
Highest reported SAR value for Head	Left hand, Touch cheek	0.27	0.26	0.53
	Right hand, Touch cheek	0.40	0.11	0.51
Highest reported SAR value for Body	Front	1.03	0.03	1.06
	Rear	1.05	0.10	1.15
	Bottom	1.16	/	1.16

Table 13.2: The sum of reported SAR values for main antenna and BT

	Position	Main antenna	BT	Sum
Maximum reported SAR value for Head	Right hand, Touch cheek	0.40	0.21 ^[1]	0.61
Maximum reported SAR value for Body	Rear	1.05	0.10 ^[1]	1.15
	Bottom	1.16	/	1.16

[1] - Estimated SAR for Bluetooth (see the table 13.3)

Table 13.3: Estimated SAR for Bluetooth

Mode/Band	F (GHz)	Position	Distance (mm)	Upper limit of power *		Estimated _{1g} (W/kg)
				dBm	mW	
Bluetooth	2.441	Head	5	7	5.01	0.21
Bluetooth	2.441	Body	10	7	5.01	0.10

* - Maximum possible output power declared by manufacturer

When standalone SAR test exclusion applies to an antenna that transmits simultaneously with other antennas, the standalone SAR must be estimated according to following to determine simultaneous transmission SAR test exclusion:

(max. power of channel, including tune-up tolerance, mW)/(min. test separation distance,mm)·[√f(GHz)/x] W/kg for test separation distances ≤ 50 mm;
where x = 7.5 for 1-g SAR.

When the minimum test separation distance is < 5 mm, a distance of 5 mm is applied to determine SAR test exclusion

Conclusion:

According to the above tables, the sum of reported SAR values is < 1.6W/kg. So the simultaneous transmission SAR with volume scans is not required.

14 SAR Test Result

It is determined by user manual for the distance between the EUT and the phantom bottom. The distance is 10 mm and just applied to the condition of body worn accessory.

It is performed for all SAR measurements with area scan based 1-g SAR estimation (Fast SAR). A zoom scan measurement is added when the estimated 1-gSAR is the highest measured SAR in each exposure configuration, wireless mode and frequency band combination or more than 1.2W/kg.

The calculated SAR is obtained by the following formula:

$$\text{Reported SAR} = \text{Measured SAR} \times 10^{(P_{\text{Target}} - P_{\text{Measured}})/10}$$

Where P_{Target} is the power of manufacturing upper limit;

P_{Measured} is the measured power in chapter 11.

Table 14.1: Duty Cycle

Mode	Duty Cycle
Speech for GSM850/1900	1:8.3
GPRS&EGPRS for GSM850	1:8.3
GPRS&EGPRS for GSM1900 – Normal power	1:2
GPRS&EGPRS for GSM1900 – Low power	1:8.3
WCDMA<E FDD	1:1
LTE TDD	1:1.58

We'll perform the head measurement in all bands with the primary battery and SIM card depending on the evaluation of multi-batteries and multi-SIM cards and retest on highest value point with other batteries and SIM cards. Then, repeat the measurement in the Body test.

Table 14.2: The evaluation of multi-batteries for Head Test

Frequency		Side	Test Position	Battery Type	SAR(1g) (W/kg)	Power Drift(dB)
MHz	Ch.					
836.4	4182	Left	Touch	B1	0.218	0.06
836.4	4182	Left	Touch	B2	0.197	0.05

Note: According to the values in the above table, the battery of **B1** is the primary battery.

We'll perform the head measurement with this battery and retest on highest value point with others.

Table 14.3: The evaluation of multi-batteries for Body Test

Frequency		Test Position	Spacing (mm)	Battery Type	SAR(1g) (W/kg)	Power Drift(dB)
MHz	Ch.					
836.4	4182	Front	10	B1	0.445	0.06
836.4	4182	Front	10	B2	0.402	-0.04

Note: According to the values in the above table, the battery of **B1** is the primary battery.

We'll perform the body measurement with this battery and retest on highest value point with others.

Table 14.4: The evaluation of multi-SIM cards for Head Test

Frequency		Side	Test Position	SIM	SAR(1g) (W/kg)	Power Drift(dB)
MHz	Ch.					
836.4	4182	Left	Touch	SIM1	0.207	0.08
836.4	4182	Left	Touch	SIM2	0.218	0.06

Note: According to the values in the above table, the **SIM2** is the primary SIM card.

We'll perform the head measurement with the SIM2 and retest on highest value point with others.

Table 14.5: The evaluation of multi-SIM cards for Body Test

Frequency		Test Position	Spacing (mm)	SIM	SAR(1g) (W/kg)	Power Drift(dB)
MHz	Ch.					
836.4	4182	Front	10	SIM1	0.422	0.05
836.4	4182	Front	10	SIM2	0.445	0.06

Note: According to the values in the above table, the **SIM2** is the primary SIM card.

We'll perform the body measurement with the SIM2 and retest on highest value point with others.

Note:

B1: WT330 of Jiade Energy Technology(Zhuhai) Co.,Ltd.

B2: WT330 of Sunwoda Electronic Co.,Ltd

S1: SIM1

S2: SIM2

14.1 SAR results for Fast SAR

Table 14.1-1: SAR Values (GSM 850 MHz Band - Head)

Frequency		Side	Test Position	Figure No./Note	Conducted Power (dBm)	Max. tune-up Power (dBm)	Ambient Temperature: 22.9°C		Liquid Temperature: 22.5°C		Power Drift (dB)
Ch.	MHz						Measured SAR(10g) (W/kg)	Reported SAR(10g) (W/kg)	Measured SAR(1g) (W/kg)	Reported SAR(1g) (W/kg)	
190	836.6	Left	Touch	/	32.43	34	0.110	0.16	0.148	0.21	0.09
190	836.6	Left	Tilt	/	32.43	34	0.079	0.11	0.108	0.16	0.05
251	848.8	Right	Touch	Fig.1	32.45	34	0.163	0.23	0.217	0.31	-0.17
190	836.6	Right	Touch	/	32.43	34	0.143	0.21	0.202	0.29	0.06
128	824.2	Right	Touch	/	32.32	34	0.138	0.20	0.189	0.28	-0.07
190	836.6	Right	Tilt	/	32.43	34	0.089	0.13	0.120	0.17	0.08
251	848.8	Right	Touch	S1	32.45	34	0.136	0.19	0.191	0.27	0.05
251	848.8	Right	Touch	B2	32.45	34	0.143	0.20	0.202	0.29	0.06

Table 14.1-2: SAR Values (GSM 850 MHz Band - Body)

Frequency		Mode (number of timeslots)	Test Position	Figure No./Note	Conducted Power (dBm)	Max. tune-up Power (dBm)	Ambient Temperature: 22.9°C		Liquid Temperature: 22.5°C		Power Drift (dB)
Ch.	MHz						Measured SAR(10g) (W/kg)	Reported SAR(10g) (W/kg)	Measured SAR(1g) (W/kg)	Reported SAR(1g) (W/kg)	
251	848.8	GPRS (1)	Front	Fig.2	32.49	34	0.182	0.26	0.319	0.45	0.01
190	836.6	GPRS (1)	Front	/	32.40	34	0.156	0.22	0.276	0.40	0.06
128	824.2	GPRS (1)	Front	/	32.71	34	0.153	0.21	0.264	0.35	0.05
190	836.6	GPRS (1)	Rear	/	32.40	34	0.178	0.26	0.241	0.35	0.05
190	836.6	GPRS (1)	Left	/	32.40	34	0.084	0.12	0.129	0.19	-0.08
190	836.6	GPRS (1)	Right	/	32.40	34	0.109	0.16	0.161	0.23	0.03
190	836.6	GPRS (1)	Bottom	/	32.40	34	0.070	0.10	0.129	0.19	0.07
251	848.8	EGPRS (1)	Front	/	32.44	34	0.169	0.24	0.302	0.43	0.06
251	848.8	GPRS (1)	Front	S1	32.49	34	0.164	0.23	0.287	0.41	0.04
251	848.8	GPRS (1)	Front	B2	32.49	34	0.173	0.25	0.304	0.43	-0.08

Note: The distance between the EUT and the phantom bottom is 10mm.

Table 14.1-3: SAR Values (GSM 1900 MHz Band - Head)

Ambient Temperature: 22.9°C						Liquid Temperature: 22.5°C					
Frequency		Side	Test Position	Figure No./ Note	Conducted Power (dBm)	Max. tune-up Power (dBm)	Measured SAR(10g) (W/kg)	Reported SAR(10g) (W/kg)	Measured SAR(1g) (W/kg)	Reported SAR(1g) (W/kg)	Power Drift (dB)
Ch.	MHz										
810	1909.8	Left	Touch	/	30.15	32	0.028	0.04	0.051	0.08	0.09
661	1880	Left	Touch	Fig.3	30.02	32	0.039	0.06	0.072	0.11	0.07
512	1850.2	Left	Touch	/	30.42	32	0.030	0.04	0.052	0.08	0.11
661	1880	Left	Tilt	/	30.02	32	0.025	0.04	0.040	0.06	-0.10
661	1880	Right	Touch	/	30.02	32	0.035	0.05	0.060	0.09	0.06
661	1880	Right	Tilt	/	30.02	32	0.026	0.04	0.041	0.06	0.05
661	1880	Left	Touch	S1	30.02	32	0.036	0.06	0.065	0.10	0.08
661	1880	Left	Touch	B2	30.02	32	0.037	0.06	0.068	0.11	-0.09

Table 14.1-4: SAR Values (GSM 1900 MHz Band - Body)

Ambient Temperature: 22.9°C						Liquid Temperature: 22.5°C					
Frequency		Mode (number of timeslots)	Test Position	Figure No./ Note	Conducted Power (dBm)	Max. tune-up Power (dBm)	Measured SAR(10g) (W/kg)	Reported SAR(10g) (W/kg)	Measured SAR(1g) (W/kg)	Reported SAR(1g) (W/kg)	Power Drift (dB)
Ch.	MHz										
661	1880	GPRS (4)	Front	/	24.16	26	0.112	0.17	0.189	0.29	0.09
661	1880	GPRS (1)	Rear	/	30.39	32	0.061	0.09	0.099	0.14	0.06
661	1880	GPRS (4)	Left	/	24.16	26	0.032	0.05	0.061	0.09	0.05
661	1880	GPRS (4)	Right	/	24.16	26	0.013	0.02	0.026	0.04	0.08
661	1880	GPRS (1)	Bottom	/	30.39	32	0.089	0.13	0.169	0.24	-0.11
810	1909.8	GPRS (4)	Rear	Note2	24.27	26	0.115	0.17	0.194	0.29	0.03
661	1880	GPRS (4)	Rear	Fig.4/ Note2	24.16	26	0.130	0.20	0.217	0.33	0.06
512	1850.2	GPRS (4)	Rear	Note2	24.17	26	0.074	0.11	0.116	0.18	0.05
661	1880	GPRS (4)	Bottom	Note2	24.16	26	0.109	0.17	0.184	0.28	-0.04
661	1880	EGPRS (4)	Rear	/	24.17	26	0.123	0.19	0.211	0.32	0.06
661	1880	GPRS (4)	Rear	S1	24.16	26	0.123	0.19	0.206	0.31	0.03
661	1880	GPRS (4)	Rear	B2	24.16	26	0.117	0.18	0.196	0.30	0.08

Note1: The distance between the EUT and the phantom bottom is 10mm.

Note2: The distance between the EUT and the phantom bottom is 15mm by sensor (See detail in annex I).

Table 14.1-5: SAR Values (WCDMA 850 MHz Band - Head)

Frequency		Side	Test Position	Figure No./Note	Conducted Power (dBm)	Max. tune-up Power (dBm)	Ambient Temperature: 22.9 °C		Liquid Temperature: 22.5 °C		Power Drift (dB)
Ch.	MHz						Measured SAR(10g) (W/kg)	Reported SAR(10g) (W/kg)	Measured SAR(1g) (W/kg)	Reported SAR(1g) (W/kg)	
4182	836.4	Left	Touch	/	24.05	25	0.169	0.21	0.218	0.27	0.06
4182	836.4	Left	Tilt	/	24.05	25	0.111	0.14	0.142	0.18	-0.05
4233	846.6	Right	Touch	/	24.11	25	0.246	0.30	0.329	0.40	-0.08
4182	836.4	Right	Touch	/	24.05	25	0.228	0.28	0.303	0.38	0.03
4132	826.4	Right	Touch	Fig.5	24.18	25	0.252	0.30	0.335	0.40	-0.02
4182	836.4	Right	Tilt	/	24.05	25	0.129	0.16	0.165	0.21	0.04
4132	826.4	Right	Touch	S1	24.18	25	0.240	0.29	0.318	0.38	0.06
4132	826.4	Right	Touch	B2	24.18	25	0.227	0.27	0.302	0.36	-0.05

Table 14.1-6: SAR Values (WCDMA 850 MHz Band - Body)

Frequency		Test Position	Figure No./Note	Conducted Power (dBm)	Max. tune-up Power (dBm)	Ambient Temperature: 22.9 °C		Liquid Temperature: 22.5 °C		Power Drift (dB)
Ch.	MHz					Measured SAR(10g) (W/kg)	Reported SAR(10g) (W/kg)	Measured SAR(1g) (W/kg)	Reported SAR(1g) (W/kg)	
4233	846.6	Front	Fig.6	24.11	25	0.281	0.34	0.489	0.60	0.07
4182	836.4	Front	/	24.05	25	0.258	0.32	0.445	0.55	0.06
4132	826.4	Front	/	24.18	25	0.250	0.30	0.427	0.52	0.03
4182	836.4	Rear	/	24.05	25	0.246	0.31	0.407	0.51	-0.09
4182	836.4	Left	/	24.05	25	0.173	0.22	0.237	0.29	0.05
4182	836.4	Right	/	24.05	25	0.294	0.37	0.425	0.53	0.05
4182	836.4	Bottom	/	24.05	25	0.185	0.23	0.345	0.43	0.07
4233	846.6	Front	S1	24.11	25	0.267	0.33	0.464	0.57	0.04
4233	846.6	Front	B2	24.11	25	0.253	0.31	0.440	0.54	0.06

Note: The distance between the EUT and the phantom bottom is 10mm.

Table 14.1-7: SAR Values (WCDMA 1700 MHz Band - Head)

Frequency		Side	Test Position	Figure No./Note	Conducted Power (dBm)	Max. tune-up Power (dBm)	Measured SAR(10g) (W/kg)	Reported SAR(10g) (W/kg)	Measured SAR(1g) (W/kg)	Reported SAR(1g) (W/kg)	Power Drift (dB)
Ch.	MHz										
Ambient Temperature: 22.9°C Liquid Temperature: 22.5°C											
1513	1752.6	Left	Touch	/	24.38	25	0.033	0.04	0.055	0.06	0.09
1412	1732.4	Left	Touch	Fig.7	24.42	25	0.045	0.05	0.076	0.09	0.06
1312	1712.4	Left	Touch	/	24.31	25	0.033	0.04	0.053	0.06	0.06
1412	1732.4	Left	Tilt	/	24.42	25	0.016	0.02	0.026	0.03	-0.11
1412	1732.4	Right	Touch	/	24.42	25	0.026	0.03	0.046	0.05	0.03
1412	1732.4	Right	Tilt	/	24.42	25	0.009	0.01	0.011	0.01	0.15
1412	1732.4	Left	Touch	S1	24.42	25	0.043	0.05	0.072	0.08	0.09
1412	1732.4	Left	Touch	B2	24.42	25	0.041	0.05	0.068	0.08	-0.08

Table 14.1-8: SAR Values (WCDMA 1700 MHz Band - Body)

Frequency		Test Position	Figure No./Note	Conducted Power (dBm)	Max. tune-up Power (dBm)	Measured SAR(10g) (W/kg)	Reported SAR(10g) (W/kg)	Measured SAR(1g) (W/kg)	Reported SAR(1g) (W/kg)	Power Drift (dB)
Ch.	MHz									
Ambient Temperature: 22.9°C Liquid Temperature: 22.5°C										
1412	1732.4	Front	/	24.42	25	0.389	0.44	0.694	0.79	0.06
1412	1732.4	Rear	/	20.10	21	0.195	0.24	0.348	0.43	0.08
1412	1732.4	Left	/	24.42	25	0.130	0.15	0.263	0.30	-0.03
1412	1732.4	Right	/	24.42	25	0.032	0.04	0.049	0.06	0.04
1513	1752.6	Bottom	/	20.08	21	0.371	0.46	0.693	0.86	-0.07
1412	1732.4	Bottom	Fig.8	20.10	21	0.388	0.48	0.723	0.89	0.10
1312	1712.4	Bottom	/	19.94	21	0.373	0.48	0.701	0.89	0.08
1412	1732.4	Rear	Note2	24.42	25	0.227	0.26	0.379	0.43	-0.10
1412	1732.4	Bottom	Note2	24.42	25	0.393	0.45	0.678	0.77	0.11
1412	1732.4	Bottom	S1	20.10	21	0.407	0.50	0.713	0.88	0.06
1412	1732.4	Bottom	B2	20.10	21	0.401	0.49	0.696	0.86	-0.05

Note1: The distance between the EUT and the phantom bottom is 10mm.

Note2: The distance between the EUT and the phantom bottom is 15mm by sensor (See detail in annex I).

Table 14.1-9: SAR Values (WCDMA 1900 MHz Band - Head)

Frequency		Side	Test Position	Figure No./ Note	Conducted Power (dBm)	Max. tune-up Power (dBm)	Measured SAR(10g) (W/kg)	Reported SAR(10g) (W/kg)	Measured SAR(1g) (W/kg)	Reported SAR(1g) (W/kg)	Power Drift (dB)
Ch.	MHz										
Ambient Temperature: 22.9°C Liquid Temperature: 22.5°C											
9538	1907.6	Left	Touch	/	24.40	25	0.092	0.11	0.154	0.18	0.11
9400	1880	Left	Touch	/	24.26	25	0.080	0.09	0.135	0.16	0.06
9262	1852.4	Left	Touch	Fig.9	24.33	25	0.096	0.11	0.171	0.20	0.09
9400	1880	Left	Tilt	/	24.26	25	0.027	0.03	0.047	0.06	-0.07
9400	1880	Right	Touch	/	24.26	25	0.059	0.07	0.097	0.12	0.05
9400	1880	Right	Tilt	/	24.26	25	0.033	0.04	0.053	0.06	0.08
9262	1852.4	Left	Touch	S1	24.33	25	0.094	0.11	0.157	0.18	0.03
9262	1852.4	Left	Touch	B2	24.33	25	0.089	0.10	0.149	0.17	0.05

Table 14.1-10: SAR Values (WCDMA 1900 MHz Band - Body)

Frequency		Test Position	Figure No./ Note	Conducted Power (dBm)	Max. tune-up Power (dBm)	Measured SAR(10g) (W/kg)	Reported SAR(10g) (W/kg)	Measured SAR(1g) (W/kg)	Reported SAR(1g) (W/kg)	Power Drift (dB)
Ch.	MHz									
Ambient Temperature: 22.9°C Liquid Temperature: 22.5°C										
9538	1907.6	Front	/	24.40	25	0.497	0.57	0.838	0.96	0.09
9400	1880	Front	/	24.26	25	0.503	0.60	0.841	1.00	0.06
9262	1852.4	Front	Fig.10	24.33	25	0.526	0.61	0.879	1.03	-0.14
9400	1880	Rear	/	18.98	20.5	0.228	0.32	0.383	0.54	0.08
9400	1880	Left	/	24.26	25	0.134	0.16	0.272	0.32	0.08
9400	1880	Right	/	24.26	25	0.058	0.07	0.090	0.11	-0.05
9538	1907.6	Bottom	/	18.90	20.5	0.307	0.44	0.553	0.80	0.06
9400	1880	Bottom	/	18.98	20.5	0.357	0.51	0.639	0.91	0.03
9262	1852.4	Bottom	/	19.05	20.5	0.372	0.52	0.681	0.95	0.07
9400	1880	Rear	Note2	24.26	25	0.298	0.35	0.479	0.57	-0.11
9538	1907.6	Bottom	Note2	24.40	25	0.417	0.48	0.712	0.82	0.12
9400	1880	Bottom	Note2	24.26	25	0.439	0.52	0.731	0.87	0.08
9262	1852.4	Bottom	Note2	24.33	25	0.482	0.56	0.826	0.96	0.14
9262	1852.4	Front	S1	24.33	25	0.511	0.60	0.862	1.01	0.07
9262	1852.4	Front	B2	24.33	25	0.502	0.59	0.840	0.98	-0.13

Note1: The distance between the EUT and the phantom bottom is 10mm.

Note2: The distance between the EUT and the phantom bottom is 15mm by sensor (See detail in annex I).

Table 14.1-11: SAR Values (LTE Band2 - Head)

Frequency		Mode	Side	Test Position	Figure No./ Note	Conducted Power (dBm)	Max. tune-up Power (dBm)	Measured SAR(10g) (W/kg)	Reported SAR(10g) (W/kg)	Measured SAR(1g) (W/kg)	Reported SAR(1g) (W/kg)	Power Drift (dB)
Ch.	MHz											
18900	1880	1RB_Mid	Left	Touch	/	24.43	25	0.072	0.08	0.121	0.14	0.05
18900	1880	1RB_Mid	Left	Tilt	/	24.43	25	0.035	0.04	0.060	0.07	-0.08
18900	1880	1RB_Mid	Right	Touch	Fig.11	24.43	25	0.095	0.11	0.156	0.18	0.07
18900	1880	1RB_Mid	Right	Tilt	/	24.43	25	0.044	0.05	0.070	0.08	0.05
18700	1860	50RB_High	Left	Touch	/	23.22	24	0.062	0.07	0.101	0.12	0.06
18700	1860	50RB_High	Left	Tilt	/	23.22	24	0.022	0.03	0.041	0.05	0.03
18700	1860	50RB_High	Right	Touch	/	23.22	24	0.068	0.08	0.112	0.13	0.07
18700	1860	50RB_High	Right	Tilt	/	23.22	24	0.040	0.05	0.063	0.08	-0.09
18900	1880	1RB_Mid	Right	Touch	S1	24.43	25	0.091	0.10	0.148	0.17	0.08
18900	1880	1RB_Mid	Right	Touch	B2	24.43	25	0.085	0.10	0.141	0.16	-0.11

Note1: The LTE mode is QPSK_20MHz.

Table 14.1-12: SAR Values (LTE Band2 - Body)

Frequency		Mode	Test Position	Figure No./ Note	Conducted Power (dBm)	Max. tune-up Power (dBm)	Measured SAR(10g) (W/kg)	Reported SAR(10g) (W/kg)	Measured SAR(1g) (W/kg)	Reported SAR(1g) (W/kg)	Power Drift (dB)
Ch.	MHz										
19100	1900	1RB_Mid	Front	/	24.20	25	0.420	0.50	0.715	0.86	0.06
18900	1880	1RB_Mid	Front	/	24.43	25	0.453	0.52	0.770	0.88	0.08
18700	1860	1RB_Mid	Front	/	24.27	25	0.479	0.57	0.813	0.96	-0.11
18900	1880	1RB_Mid	Rear	/	21.31	22.5	0.272	0.36	0.473	0.62	0.05
18900	1880	1RB_Mid	Left	/	24.43	25	0.131	0.15	0.257	0.29	0.08
18900	1880	1RB_Mid	Right	/	24.43	25	0.051	0.06	0.081	0.09	-0.09
19100	1900	1RB_Mid	Bottom	/	21.16	22.5	0.404	0.55	0.741	1.01	-0.11
18900	1880	1RB_Mid	Bottom	/	21.31	22.5	0.396	0.52	0.722	0.95	0.14
18700	1860	1RB_Mid	Bottom	Fig.12	21.16	22.5	0.466	0.63	0.852	1.16	0.05
18900	1880	1RB_Mid	Rear	Note2	24.43	25	0.288	0.33	0.473	0.54	0.06
18900	1880	1RB_Mid	Bottom	Note2	24.43	25	0.390	0.44	0.669	0.76	0.04
18700	1860	50RB_High	Front	/	23.22	24	0.331	0.40	0.561	0.67	0.07
18900	1880	50RB_Mid	Rear	/	20.10	21.5	0.223	0.31	0.389	0.54	0.09
18700	1860	50RB_High	Left	/	23.22	24	0.112	0.13	0.222	0.27	-0.09
18700	1860	50RB_High	Right	/	23.22	24	0.030	0.04	0.046	0.06	-0.08
18900	1880	50RB_Mid	Bottom	/	20.10	21.5	0.312	0.43	0.579	0.80	0.05
18700	1860	50RB_High	Rear	Note2	23.22	24	0.240	0.29	0.397	0.48	-0.04
18700	1860	50RB_High	Bottom	Note2	23.22	24	0.327	0.39	0.556	0.67	0.07
18700	1860	100RB	Front	/	23.27	24	0.352	0.42	0.600	0.71	0.08
19100	1900	100RB	Bottom	/	19.98	21.5	0.339	0.48	0.588	0.83	0.06

18700	1860	1RB_Mid	Bottom	S1	21.16	22.5	0.463	0.63	0.809	1.10	0.05
18700	1860	1RB_Mid	Bottom	B2	21.16	22.5	0.456	0.62	0.779	1.06	-0.03

Note1: The distance between the EUT and the phantom bottom is 10mm.

Note2: The distance between the EUT and the phantom bottom is 15mm by sensor (See detail in annex I).

Note3: The LTE mode is QPSK_20MHz.

Table 14.1-13: SAR Values (LTE Band5 - Head)

Ambient Temperature: 22.9°C						Liquid Temperature: 22.5°C						
Frequency		Mode	Side	Test Position	Figure No.	Conducted Power (dBm)	Max. tune-up Power (dBm)	Measured SAR(10g) (W/kg)	Reported SAR(10g) (W/kg)	Measured SAR(1g) (W/kg)	Reported SAR(1g) (W/kg)	Power Drift (dB)
Ch.	MHz											
20600	844	1RB_Mid	Left	Touch	/	23.59	24.5	0.168	0.21	0.214	0.26	-0.11
20600	844	1RB_Mid	Left	Tilt	/	23.59	24.5	0.100	0.12	0.129	0.16	0.05
20600	844	1RB_Mid	Right	Touch	Fig.13	23.59	24.5	0.222	0.27	0.295	0.36	0.09
20600	844	1RB_Mid	Right	Tilt	/	23.59	24.5	0.115	0.14	0.146	0.18	0.06
20450	829	25RB_Low	Left	Touch	/	22.33	23.5	0.143	0.19	0.185	0.24	0.07
20450	829	25RB_Low	Left	Tilt	/	22.33	23.5	0.100	0.13	0.128	0.17	-0.07
20450	829	25RB_Low	Right	Touch	/	22.33	23.5	0.184	0.24	0.241	0.32	0.06
20450	829	25RB_Low	Right	Tilt	/	22.33	23.5	0.103	0.13	0.135	0.18	-0.10
20600	844	1RB_Mid	Right	Touch	S1	23.59	24.5	0.211	0.26	0.280	0.35	0.05
20600	844	1RB_Mid	Right	Touch	B2	23.59	24.5	0.200	0.25	0.265	0.33	0.04

Note1: The LTE mode is QPSK_10MHz.

Table 14.1-14: SAR Values (LTE Band5 - Body)

Ambient Temperature: 22.9°C						Liquid Temperature: 22.5°C					
Frequency		Mode	Test Position	Figure No.	Conducted Power (dBm)	Max. tune-up Power (dBm)	Measured SAR(10g) (W/kg)	Reported SAR(10g) (W/kg)	Measured SAR(1g) (W/kg)	Reported SAR(1g) (W/kg)	Power Drift (dB)
Ch.	MHz										
20600	844	1RB_Mid	Front	Fig.14	23.59	24.5	0.259	0.32	0.449	0.55	-0.03
20600	844	1RB_Mid	Rear	/	23.59	24.5	0.254	0.31	0.423	0.52	0.05
20600	844	1RB_Mid	Left	/	23.59	24.5	0.139	0.17	0.201	0.25	-0.04
20600	844	1RB_Mid	Right	/	23.59	24.5	0.281	0.35	0.406	0.50	0.04
20600	844	1RB_Mid	Bottom	/	23.59	24.5	0.185	0.23	0.349	0.43	0.06
20450	829	25RB_Low	Front	/	22.33	23.5	0.186	0.24	0.309	0.40	0.02
20450	829	25RB_Low	Rear	/	22.33	23.5	0.175	0.23	0.290	0.38	0.05
20450	829	25RB_Low	Left	/	22.33	23.5	0.128	0.17	0.189	0.25	-0.07
20450	829	25RB_Low	Right	/	22.33	23.5	0.229	0.30	0.333	0.44	0.08
20450	829	25RB_Low	Bottom	/	22.33	23.5	0.128	0.17	0.240	0.31	0.05
20600	844	1RB_Mid	Front	S1	23.59	24.5	0.246	0.30	0.427	0.53	0.06
20600	844	1RB_Mid	Front	B2	23.59	24.5	0.233	0.29	0.404	0.50	-0.03

Note1: The distance between the EUT and the phantom bottom is 10mm.

Note2: The LTE mode is QPSK_10MHz.

Table 14.1-15: SAR Values (LTE Band7 - Head)

Ambient Temperature: 22.9°C						Liquid Temperature: 22.5°C						
Frequency		Mode	Side	Test Position	Figure No./ Note	Conduct Power (dBm)	tune-up Power (dBm)	Measured SAR(10g) (W/kg)	Reported SAR(10g) (W/kg)	Measured SAR(1g) (W/kg)	Reported SAR(1g) (W/kg)	Power Drift (dB)
Ch.	MHz											
21350	2560	1RB_Mid	Left	Touch	/	24.56	25	0.060	0.07	0.130	0.14	-0.07
21350	2560	1RB_Mid	Left	Tilt	/	24.56	25	0.047	0.05	0.099	0.11	0.05
21350	2560	1RB_Mid	Right	Touch	Fig.15	24.56	25	0.073	0.08	0.152	0.17	-0.10
21350	2560	1RB_Mid	Right	Tilt	/	24.56	25	0.061	0.07	0.137	0.15	0.08
21350	2560	50RB_Low	Left	Touch	/	23.19	24	0.048	0.06	0.104	0.13	0.07
21350	2560	50RB_Low	Left	Tilt	/	23.19	24	0.034	0.04	0.070	0.08	0.06
21350	2560	50RB_Low	Right	Touch	/	23.19	24	0.057	0.07	0.119	0.14	0.05
21350	2560	50RB_Low	Right	Tilt	/	23.19	24	0.049	0.06	0.110	0.13	-0.09
21350	2560	1RB_Mid	Right	Touch	S1	24.56	25	0.069	0.08	0.144	0.16	0.04
21350	2560	1RB_Mid	Right	Touch	B2	24.56	25	0.066	0.07	0.137	0.15	0.05

Note1: The LTE mode is QPSK_20MHz.

Table 14.1-16: SAR Values (LTE Band7 - Body)

Ambient Temperature: 22.9°C						Liquid Temperature: 22.5°C					
Frequency		Mode	Test Position	Figure No./ Note	Conduct Power (dBm)	tune-up Power (dBm)	Measured SAR(10g) (W/kg)	Reported SAR(10g) (W/kg)	Measured SAR(1g) (W/kg)	Reported SAR(1g) (W/kg)	Power Drift (dB)
Ch.	MHz										
21350	2560	1RB_Mid	Front	/	24.56	25	0.361	0.40	0.703	0.78	0.09
21350	2560	1RB_Mid	Rear	/	23.26	24	0.452	0.54	0.863	1.02	0.07
21100	2535	1RB_Low	Rear	Fig.16	23.39	24	0.477	0.55	0.914	1.05	0.13
20850	2510	1RB_Mid	Rear	/	23.10	24	0.442	0.54	0.818	1.01	0.05
21350	2560	1RB_Mid	Left	/	24.56	25	0.233	0.26	0.443	0.49	-0.09
21350	2560	1RB_Mid	Right	/	24.56	25	0.152	0.17	0.271	0.30	0.07
21100	2535	1RB_Low	Bottom	/	23.39	24	0.335	0.38	0.665	0.77	0.06
21350	2560	1RB_Mid	Rear	Note2	24.56	25	0.270	0.30	0.486	0.54	-0.07
21350	2560	1RB_Mid	Bottom	Note2	24.56	25	0.168	0.19	0.333	0.37	0.05
21350	2560	50RB_Low	Front	/	23.19	24	0.278	0.33	0.531	0.64	0.08
20850	2510	50RB_Mid	Rear	/	22.52	23	0.358	0.40	0.680	0.76	-0.11
21350	2560	50RB_Low	Left	/	23.19	24	0.195	0.23	0.376	0.45	0.06
21350	2560	50RB_Low	Right	/	23.19	24	0.119	0.14	0.213	0.26	0.14
20850	2510	50RB_Mid	Bottom	/	22.52	23	0.249	0.28	0.495	0.55	-0.07
21350	2560	50RB_Low	Rear	Note2	23.19	24	0.225	0.27	0.405	0.49	0.06
21350	2560	50RB_Low	Bottom	Note2	23.19	24	0.180	0.22	0.352	0.42	0.08
20850	2510	100RB	Rear	/	22.41	23	0.369	0.42	0.766	0.88	-0.09
21100	2535	1RB_Low	Rear	S1	23.39	24	0.463	0.53	0.897	1.03	0.06
21100	2535	1RB_Low	Rear	B2	23.39	24	0.456	0.52	0.872	1.00	0.04

Note1: The distance between the EUT and the phantom bottom is 10mm.

Note2: The distance between the EUT and the phantom bottom is 15mm by sensor (See detail in annex I).

Note3: The LTE mode is QPSK_20MHz.

Table 14.1-17: SAR Values (LTE Band12 - Head)

Ambient Temperature: 22.9°C						Liquid Temperature: 22.5°C						
Frequency		Mode	Side	Test Position	Figure No./ Note	Conducted Power (dBm)	Max. tune-up Power (dBm)	Measured SAR(10g) (W/kg)	Reported SAR(10g) (W/kg)	Measured SAR(1g) (W/kg)	Reported SAR(1g) (W/kg)	Power Drift (dB)
Ch.	MHz											
23095	707.5	1RB_Mid	Left	Touch	/	23.64	24.5	0.095	0.12	0.121	0.15	-0.06
23095	707.5	1RB_Mid	Left	Tilt	/	23.64	24.5	0.075	0.09	0.095	0.12	0.08
23095	707.5	1RB_Mid	Right	Touch	Fig.17	23.64	24.5	0.102	0.12	0.130	0.16	0.11
23095	707.5	1RB_Mid	Right	Tilt	/	23.64	24.5	0.075	0.09	0.093	0.11	0.07
23095	707.5	25RB_Mid	Left	Touch	/	22.37	23.5	0.076	0.10	0.098	0.13	0.05
23095	707.5	25RB_Mid	Left	Tilt	/	22.37	23.5	0.059	0.08	0.076	0.10	0.06
23095	707.5	25RB_Mid	Right	Touch	/	22.37	23.5	0.080	0.10	0.101	0.13	-0.09
23095	707.5	25RB_Mid	Right	Tilt	/	22.37	23.5	0.058	0.07	0.072	0.09	0.08
23095	707.5	1RB_Mid	Right	Touch	S1	23.64	24.5	0.091	0.11	0.115	0.14	0.05
23095	707.5	1RB_Mid	Right	Touch	B2	23.64	24.5	0.086	0.10	0.110	0.13	0.11

Note1: The LTE mode is QPSK_10MHz.

Table 14.1-18: SAR Values (LTE Band12 - Body)

Ambient Temperature: 22.9°C						Liquid Temperature: 22.5°C					
Frequency		Mode	Test Position	Figure No./ Note	Conducted Power (dBm)	Max. tune-up Power (dBm)	Measured SAR(10g) (W/kg)	Reported SAR(10g) (W/kg)	Measured SAR(1g) (W/kg)	Reported SAR(1g) (W/kg)	Power Drift (dB)
Ch.	MHz										
23095	707.5	1RB_Mid	Front	/	23.64	24.5	0.191	0.23	0.247	0.30	0.05
23095	707.5	1RB_Mid	Rear	/	23.64	24.5	0.215	0.26	0.276	0.34	0.06
23095	707.5	1RB_Mid	Left	/	23.64	24.5	0.158	0.19	0.225	0.27	-0.09
23095	707.5	1RB_Mid	Right	Fig.18	23.64	24.5	0.233	0.28	0.333	0.41	0.03
23095	707.5	1RB_Mid	Bottom	/	23.64	24.5	0.052	0.06	0.092	0.11	0.05
23095	707.5	25RB_Mid	Front	/	22.37	23.5	0.151	0.20	0.195	0.25	-0.02
23095	707.5	25RB_Mid	Rear	/	22.37	23.5	0.158	0.21	0.203	0.26	0.04
23095	707.5	25RB_Mid	Left	/	22.37	23.5	0.113	0.15	0.160	0.21	0.07
23095	707.5	25RB_Mid	Right	/	22.37	23.5	0.180	0.23	0.259	0.34	0.03
23095	707.5	25RB_Mid	Bottom	/	22.37	23.5	0.038	0.05	0.068	0.09	0.03
23095	707.5	1RB_Mid	Right	S1	23.64	24.5	0.222	0.27	0.316	0.38	0.05
23095	707.5	1RB_Mid	Right	B2	23.64	24.5	0.210	0.26	0.300	0.37	-0.04

Note1: The distance between the EUT and the phantom bottom is 10mm.

Note2: The LTE mode is QPSK_10MHz.

Table 14.1-19: SAR Values (LTE Band38 - Head)

Ambient Temperature: 22.9°C						Liquid Temperature: 22.5°C						
Frequency		Mode	Side	Test Position	Figure No./ Note	Conducted Power (dBm)	Max. tune-up Power (dBm)	Measured SAR(10g) (W/kg)	Reported SAR(10g) (W/kg)	Measured SAR(1g) (W/kg)	Reported SAR(1g) (W/kg)	Power Drift (dB)
Ch.	MHz											
38150	2610	1RB_Mid	Left	Touch	/	24.04	24.5	0.035	0.04	0.068	0.08	0.09
38150	2610	1RB_Mid	Left	Tilt	/	24.04	24.5	0.025	0.03	0.044	0.05	0.06
38150	2610	1RB_Mid	Right	Touch	Fig.19	24.04	24.5	0.036	0.04	0.075	0.08	0.12
38150	2610	1RB_Mid	Right	Tilt	/	24.04	24.5	0.033	0.04	0.067	0.07	-0.11
38000	2595	50RB_Mid	Left	Touch	/	22.80	23.5	0.029	0.03	0.056	0.07	0.07
38000	2595	50RB_Mid	Left	Tilt	/	22.80	23.5	0.026	0.03	0.053	0.06	0.06
38000	2595	50RB_Mid	Right	Touch	/	22.80	23.5	0.029	0.03	0.055	0.06	0.05
38000	2595	50RB_Mid	Right	Tilt	/	22.80	23.5	0.027	0.03	0.053	0.06	-0.08
38150	2610	1RB_Mid	Right	Touch	S1	24.04	24.5	0.038	0.04	0.071	0.08	0.07
38150	2610	1RB_Mid	Right	Touch	B2	24.04	24.5	0.036	0.04	0.068	0.08	0.08

Note1: The LTE mode is QPSK_20MHz.

Table 14.1-20: SAR Values (LTE Band38 - Body)

Ambient Temperature: 22.9°C						Liquid Temperature: 22.5°C					
Frequency		Mode	Test Position	Figure No./ Note	Conducted Power (dBm)	Max. tune-up Power (dBm)	Measured SAR(10g) (W/kg)	Reported SAR(10g) (W/kg)	Measured SAR(1g) (W/kg)	Reported SAR(1g) (W/kg)	Power Drift (dB)
Ch.	MHz										
38150	2610	1RB_Mid	Front	/	24.04	24.5	0.220	0.24	0.450	0.50	0.05
38150	2610	1RB_Mid	Rear	Fig.20	24.04	24.5	0.350	0.39	0.672	0.75	-0.03
38150	2610	1RB_Mid	Left	/	24.04	24.5	0.127	0.14	0.271	0.30	0.06
38150	2610	1RB_Mid	Right	/	24.04	24.5	0.091	0.10	0.173	0.19	0.05
38150	2610	1RB_Mid	Bottom	/	24.04	24.5	0.241	0.27	0.508	0.56	-0.07
38000	2595	50RB_Mid	Front	/	22.80	23.5	0.169	0.20	0.352	0.41	0.06
38000	2595	50RB_Mid	Rear	/	22.80	23.5	0.276	0.32	0.568	0.67	0.02
38000	2595	50RB_Mid	Left	/	22.80	23.5	0.118	0.14	0.243	0.29	0.04
38000	2595	50RB_Mid	Right	/	22.80	23.5	0.069	0.08	0.132	0.15	-0.05
38000	2595	50RB_Mid	Bottom	/	22.80	23.5	0.186	0.22	0.390	0.46	0.03
38150	2610	1RB_Mid	Rear	S1	24.04	24.5	0.332	0.37	0.638	0.71	0.04
38150	2610	1RB_Mid	Rear	B2	24.04	24.5	0.315	0.35	0.605	0.67	0.06

Note1: The distance between the EUT and the phantom bottom is 10mm.

Note2: The LTE mode is QPSK_20MHz.

Table 14.1-21: SAR Values (LTE band66 - Head)

Frequency		Mode	Side	Test Position	Figure No.	Ambient Temperature: 22.9°C		Liquid Temperature: 22.5°C				
Ch.	MHz					Conducted Power (dBm)	tune-up Power (dBm)	Measured SAR(10g) (W/kg)	Reported SAR(10g) (W/kg)	Measured SAR(1g) (W/kg)	Reported SAR(1g) (W/kg)	Power Drift (dB)
132322	1745	1RB_Mid	Left	Touch	Fig.21	24.42	25	0.045	0.05	0.077	0.09	0.16
132322	1745	1RB_Mid	Left	Tilt	/	24.42	25	0.018	0.02	0.031	0.04	0.12
132322	1745	1RB_Mid	Right	Touch	/	24.42	25	0.033	0.04	0.059	0.07	-0.09
132322	1745	1RB_Mid	Right	Tilt	/	24.42	25	0.014	0.02	0.024	0.03	0.08
132072	1720	50RB_Mid	Left	Touch	/	23.23	24	0.036	0.04	0.061	0.07	0.10
132072	1720	50RB_Mid	Left	Tilt	/	23.23	24	0.014	0.02	0.024	0.03	0.13
132072	1720	50RB_Mid	Right	Touch	/	23.23	24	0.027	0.03	0.047	0.06	-0.08
132072	1720	50RB_Mid	Right	Tilt	/	23.23	24	0.011	0.01	0.019	0.02	0.08
132322	1745	1RB_Mid	Left	Touch	S1	24.42	25	0.043	0.05	0.074	0.08	0.09
132322	1745	1RB_Mid	Left	Touch	B2	24.42	25	0.041	0.05	0.069	0.08	0.06

Note1: The LTE mode is QPSK_20MHz.

Table 14.1-22: SAR Values (LTE band66 - Body)

Frequency		Mode	Test Position	Figure No./ Note	Ambient Temperature: 22.9°C		Liquid Temperature: 22.5°C				
Ch.	MHz				Conducted Power (dBm)	tune-up Power (dBm)	Measured SAR(10g) (W/kg)	Reported SAR(10g) (W/kg)	Measured SAR(1g) (W/kg)	Reported SAR(1g) (W/kg)	Power Drift (dB)
132322	1745	1RB_Mid	Front	/	24.42	25	0.337	0.39	0.588	0.67	0.05
132572	1770	1RB_Mid	Rear	/	22.32	23	0.240	0.28	0.409	0.48	0.09
132322	1745	1RB_Mid	Left	/	24.42	25	0.094	0.11	0.187	0.21	0.02
132322	1745	1RB_Mid	Right	/	24.42	25	0.036	0.04	0.055	0.06	0.06
132572	1770	1RB_Mid	Bottom	Fig.22	22.32	23	0.453	0.53	0.828	0.97	-0.07
132322	1745	1RB_Mid	Bottom	/	22.19	23	0.421	0.51	0.771	0.93	0.07
132072	1720	1RB_Mid	Bottom	/	22.13	23	0.404	0.49	0.745	0.91	-0.05
132322	1745	1RB_Mid	Rear	Note2	24.42	25	0.199	0.23	0.319	0.36	0.06
132322	1745	1RB_Mid	Bottom	Note2	24.42	25	0.353	0.40	0.605	0.69	-0.08
132072	1720	50RB_Mid	Front	/	23.23	24	0.233	0.28	0.414	0.49	0.07
132322	1745	50RB_Low	Rear	/	21.20	22	0.180	0.22	0.312	0.38	-0.13
132072	1720	50RB_Mid	Left	/	23.23	24	0.059	0.07	0.120	0.14	0.05
132072	1720	50RB_Mid	Right	/	23.23	24	0.026	0.03	0.038	0.05	0.08
132322	1745	50RB_Low	Bottom	/	21.20	22	0.336	0.40	0.618	0.74	0.06
132072	1720	50RB_Mid	Rear	Note2	23.23	24	0.139	0.17	0.226	0.27	-0.05
132072	1720	50RB_Mid	Bottom	Note2	23.23	24	0.227	0.27	0.403	0.48	0.07
132322	1745	100RB	Bottom	/	21.15	22	0.337	0.41	0.620	0.75	0.07
132572	1770	1RB_Mid	Bottom	S1	22.32	23	0.440	0.51	0.812	0.95	0.12
132572	1770	1RB_Mid	Bottom	B2	22.32	23	0.432	0.51	0.789	0.92	0.06

Note1: The distance between the EUT and the phantom bottom is 10mm.

Note2: The distance between the EUT and the phantom bottom is 15mm by sensor (See detail in annex I).

Note3: The LTE mode is QPSK_20MHz.

14.2 SAR results for Standard procedure

There is zoom scan measurement to be added for the highest measured SAR in each exposure configuration/band.

Table 14.2-1: SAR Values (GSM 850 MHz Band - Head)

Ambient Temperature: 22.9 °C						Liquid Temperature: 22.5 °C					
Frequency		Side	Test Position	Figure No./Note	Conducted Power (dBm)	Max. tune-up Power (dBm)	Measured SAR(10g) (W/kg)	Reported SAR(10g) (W/kg)	Measured SAR(1g) (W/kg)	Reported SAR(1g) (W/kg)	Power Drift (dB)
Ch.	MHz										
251	848.8	Right	Touch	Fig.1	32.45	34	0.163	0.23	0.217	0.31	-0.17

Table 14.2-2: SAR Values (GSM 850 MHz Band - Body)

Ambient Temperature: 22.9 °C						Liquid Temperature: 22.5 °C					
Frequency		Mode (number of timeslots)	Test Position	Figure No./ Note	Conducted Power (dBm)	Max. tune-up Power (dBm)	Measured SAR(10g) (W/kg)	Reported SAR(10g) (W/kg)	Measured SAR(1g) (W/kg)	Reported SAR(1g) (W/kg)	Power Drift (dB)
Ch.	MHz										
251	848.8	GPRS (1)	Front	Fig.2	32.49	34	0.182	0.26	0.319	0.45	0.01

Note: The distance between the EUT and the phantom bottom is 10mm.

Table 14.2-3: SAR Values (GSM 1900 MHz Band - Head)

Ambient Temperature: 22.9 °C						Liquid Temperature: 22.5 °C					
Frequency		Side	Test Position	Figure No./ Note	Conducted Power (dBm)	Max. tune-up Power (dBm)	Measured SAR(10g) (W/kg)	Reported SAR(10g) (W/kg)	Measured SAR(1g) (W/kg)	Reported SAR(1g) (W/kg)	Power Drift (dB)
Ch.	MHz										
661	1880	Left	Touch	Fig.3	30.02	32	0.039	0.06	0.072	0.11	0.07

Table 14.2-4: SAR Values (GSM 1900 MHz Band - Body)

Ambient Temperature: 22.9 °C						Liquid Temperature: 22.5 °C					
Frequency		Mode (number of timeslots)	Test Position	Figure No./ Note	Conducted Power (dBm)	tune-up Power (dBm)	Measured SAR(10g) (W/kg)	Reported SAR(10g) (W/kg)	Measured SAR(1g) (W/kg)	Reported SAR(1g) (W/kg)	Power Drift (dB)
Ch.	MHz										
661	1880	GPRS (4)	Rear	Fig.4/ Note2	24.16	26	0.130	0.20	0.217	0.33	0.06

Note2: The distance between the EUT and the phantom bottom is 15mm by sensor (See detail in annex I).

Table 14.2-5: SAR Values (WCDMA 850 MHz Band - Head)

Ambient Temperature: 22.9 °C						Liquid Temperature: 22.5 °C					
Frequency		Side	Test Position	Figure No./Note	Conducted Power (dBm)	tune-up Power (dBm)	Measured SAR(10g) (W/kg)	Reported SAR(10g) (W/kg)	Measured SAR(1g) (W/kg)	Reported SAR(1g) (W/kg)	Power Drift (dB)
Ch.	MHz										
4132	826.4	Right	Touch	Fig.5	24.18	25	0.252	0.30	0.335	0.40	-0.02

Table 14.2-6: SAR Values (WCDMA 850 MHz Band - Body)

Ambient Temperature: 22.9 °C						Liquid Temperature: 22.5 °C				
Frequency		Test Position	Figure No./ Note	Conducted Power (dBm)	Max. tune-up Power (dBm)	Measured SAR(10g) (W/kg)	Reported SAR(10g) (W/kg)	Measured SAR(1g) (W/kg)	Reported SAR(1g) (W/kg)	Power Drift (dB)
Ch.	MHz									
4233	846.6	Front	Fig.6	24.11	25	0.281	0.34	0.489	0.60	0.07

Note: The distance between the EUT and the phantom bottom is 10mm.

Table 14.2-7: SAR Values (WCDMA 1700 MHz Band - Head)

Frequency		Side	Test Position	Figure No./Note	Conducted Power (dBm)	Max. tune-up Power (dBm)	Measured SAR(10g) (W/kg)	Reported SAR(10g) (W/kg)	Measured SAR(1g) (W/kg)	Reported SAR(1g) (W/kg)	Power Drift (dB)
Ch.	MHz										
1412	1732.4	Left	Touch	Fig.7	24.42	25	0.045	0.05	0.076	0.09	0.06

Table 14.2-8: SAR Values (WCDMA 1700 MHz Band - Body)

Frequency		Test Position	Figure No./Note	Conducted Power (dBm)	Max. tune-up Power (dBm)	Measured SAR(10g) (W/kg)	Reported SAR(10g) (W/kg)	Measured SAR(1g) (W/kg)	Reported SAR(1g) (W/kg)	Power Drift (dB)
Ch.	MHz									
1412	1732.4	Bottom	Fig.8	20.10	21	0.388	0.48	0.723	0.89	0.10

Note1: The distance between the EUT and the phantom bottom is 10mm.

Table 14.2-9: SAR Values (WCDMA 1900 MHz Band - Head)

Frequency		Side	Test Position	Figure No./Note	Conducted Power (dBm)	Max. tune-up Power (dBm)	Measured SAR(10g) (W/kg)	Reported SAR(10g) (W/kg)	Measured SAR(1g) (W/kg)	Reported SAR(1g) (W/kg)	Power Drift (dB)
Ch.	MHz										
9262	1852.4	Left	Touch	Fig.9	24.33	25	0.096	0.11	0.171	0.20	0.09

Table 14.2-10: SAR Values (WCDMA 1900 MHz Band - Body)

Frequency		Test Position	Figure No./Note	Conducted Power (dBm)	Max. tune-up Power (dBm)	Measured SAR(10g) (W/kg)	Reported SAR(10g) (W/kg)	Measured SAR(1g) (W/kg)	Reported SAR(1g) (W/kg)	Power Drift (dB)
Ch.	MHz									
9262	1852.4	Front	Fig.10	24.33	25	0.526	0.61	0.879	1.03	-0.14

Note1: The distance between the EUT and the phantom bottom is 10mm.

Table 14.2-11: SAR Values (LTE Band2 - Head)

Frequency		Mode	Side	Test Position	Figure No./Note	Conducted Power (dBm)	Max. tune-up Power (dBm)	Measured SAR(10g) (W/kg)	Reported SAR(10g) (W/kg)	Measured SAR(1g) (W/kg)	Reported SAR(1g) (W/kg)	Power Drift (dB)
Ch.	MHz											
18900	1880	1RB_Mid	Right	Touch	Fig.11	24.43	25	0.095	0.11	0.156	0.18	0.07

Note1: The LTE mode is QPSK_20MHz.

Table 14.2-12: SAR Values (LTE Band2 - Body)

Frequency		Mode	Test Position	Figure No./Note	Conducted Power (dBm)	Max. tune-up Power (dBm)	Measured SAR(10g) (W/kg)	Reported SAR(10g) (W/kg)	Measured SAR(1g) (W/kg)	Reported SAR(1g) (W/kg)	Power Drift (dB)
Ch.	MHz										
18700	1860	1RB_Mid	Bottom	Fig.12	21.16	22.5	0.466	0.63	0.852	1.16	0.05

Note1: The distance between the EUT and the phantom bottom is 10mm. Note2: The LTE mode is QPSK_20MHz.

Table 14.2-13: SAR Values (LTE Band5 - Head)

Ambient Temperature: 22.9°C						Liquid Temperature: 22.5°C						
Frequency		Mode	Side	Test Position	Figure No.	Conducted Power (dBm)	Max. tune-up Power (dBm)	Measured SAR(10g) (W/kg)	Reported SAR(10g) (W/kg)	Measured SAR(1g) (W/kg)	Reported SAR(1g) (W/kg)	Power Drift (dB)
Ch.	MHz											
20600	844	1RB_Mid	Right	Touch	Fig.13	23.59	24.5	0.222	0.27	0.295	0.36	0.09

Note1: The LTE mode is QPSK_10MHz.

Table 14.2-14: SAR Values (LTE Band5 - Body)

Ambient Temperature: 22.9°C						Liquid Temperature: 22.5°C					
Frequency		Mode	Test Position	Figure No.	Conducted Power (dBm)	Max. tune-up Power (dBm)	Measured SAR(10g) (W/kg)	Reported SAR(10g) (W/kg)	Measured SAR(1g) (W/kg)	Reported SAR(1g) (W/kg)	Power Drift (dB)
Ch.	MHz										
20600	844	1RB_Mid	Front	Fig.14	23.59	24.5	0.259	0.32	0.449	0.55	-0.03

Note1: The distance between the EUT and the phantom bottom is 10mm. Note2: The LTE mode is QPSK_10MHz.

Table 14.2-15: SAR Values (LTE Band7 - Head)

Ambient Temperature: 22.9°C						Liquid Temperature: 22.5°C						
Frequency		Mode	Side	Test Position	Figure No./ Note	Conduct Power (dBm)	tune-up Power (dBm)	Measured SAR(10g) (W/kg)	Reported SAR(10g) (W/kg)	Measured SAR(1g) (W/kg)	Reported SAR(1g) (W/kg)	Power Drift (dB)
Ch.	MHz											
21350	2560	1RB_Mid	Right	Touch	Fig.15	24.56	25	0.073	0.08	0.152	0.17	-0.10

Note1: The LTE mode is QPSK_20MHz.

Table 14.2-16: SAR Values (LTE Band7 - Body)

Ambient Temperature: 22.9°C						Liquid Temperature: 22.5°C					
Frequency		Mode	Test Position	Figure No./ Note	Conduct Power (dBm)	tune-up Power (dBm)	Measured SAR(10g) (W/kg)	Reported SAR(10g) (W/kg)	Measured SAR(1g) (W/kg)	Reported SAR(1g) (W/kg)	Power Drift (dB)
Ch.	MHz										
21100	2535	1RB_Low	Rear	Fig.16	23.39	24	0.477	0.55	0.914	1.05	0.13

Note1: The distance between the EUT and the phantom bottom is 10mm. Note2: The LTE mode is QPSK_20MHz.

Table 14.2-17: SAR Values (LTE Band12 - Head)

Ambient Temperature: 22.9°C						Liquid Temperature: 22.5°C						
Frequency		Mode	Side	Test Position	Figure No./ Note	Conduct ed Power (dBm)	Max. tune-up Power (dBm)	Measured SAR(10g) (W/kg)	Reported SAR(10g) (W/kg)	Measured SAR(1g) (W/kg)	Reported SAR(1g) (W/kg)	Power Drift (dB)
Ch.	MHz											
23095	707.5	1RB_Mid	Right	Touch	Fig.17	23.64	24.5	0.102	0.12	0.130	0.16	0.11

Note1: The LTE mode is QPSK_10MHz.

Table 14.2-18: SAR Values (LTE Band12 - Body)

Ambient Temperature: 22.9 °C						Liquid Temperature: 22.5 °C					
Frequency		Mode	Test Position	Figure No./ Note	Conducted Power (dBm)	Max. tune-up Power (dBm)	Measured SAR(10g) (W/kg)	Reported SAR(10g) (W/kg)	Measured SAR(1g) (W/kg)	Reported SAR(1g) (W/kg)	Power Drift (dB)
Ch.	MHz										
23095	707.5	1RB_Mid	Right	Fig.18	23.64	24.5	0.233	0.28	0.333	0.41	0.03

Note1: The distance between the EUT and the phantom bottom is 10mm.

Note2: The LTE mode is QPSK_10MHz.

Table 14.2-19: SAR Values (LTE Band38 - Head)

Ambient Temperature: 22.9 °C						Liquid Temperature: 22.5 °C						
Frequency		Mode	Side	Test Position	Figure No./ Note	Conducted Power (dBm)	Max. tune-up Power (dBm)	Measured SAR(10g) (W/kg)	Reported SAR(10g) (W/kg)	Measured SAR(1g) (W/kg)	Reported SAR(1g) (W/kg)	Power Drift (dB)
Ch.	MHz											
38150	2610	1RB_Mid	Right	Touch	Fig.19	24.04	24.5	0.036	0.04	0.075	0.08	0.12

Note1: The LTE mode is QPSK_20MHz.

Table 14.2-20: SAR Values (LTE Band38 - Body)

Ambient Temperature: 22.9 °C						Liquid Temperature: 22.5 °C					
Frequency		Mode	Test Position	Figure No./ Note	Conducted Power (dBm)	Max. tune-up Power (dBm)	Measured SAR(10g) (W/kg)	Reported SAR(10g) (W/kg)	Measured SAR(1g) (W/kg)	Reported SAR(1g) (W/kg)	Power Drift (dB)
Ch.	MHz										
38150	2610	1RB_Mid	Rear	Fig.20	24.04	24.5	0.350	0.39	0.672	0.75	-0.03

Note1: The distance between the EUT and the phantom bottom is 10mm.

Note2: The LTE mode is QPSK_20MHz.

Table 14.2-21: SAR Values (LTE band66 - Head)

Ambient Temperature: 22.9 °C						Liquid Temperature: 22.5 °C						
Frequency		Mode	Side	Test Position	Figure No.	Conducted Power (dBm)	tune-up Power (dBm)	Measured SAR(10g) (W/kg)	Reported SAR(10g) (W/kg)	Measured SAR(1g) (W/kg)	Reported SAR(1g) (W/kg)	Power Drift (dB)
Ch.	MHz											
132322	1745	1RB_Mid	Left	Touch	Fig.21	24.42	25	0.045	0.05	0.077	0.09	0.16

Note1: The LTE mode is QPSK_20MHz.

Table 14.2-22: SAR Values (LTE band66 - Body)

Ambient Temperature: 22.9 °C						Liquid Temperature: 22.5 °C					
Frequency		Mode	Test Position	Figure No./ Note	Conducted Power (dBm)	tune-up Power (dBm)	Measured SAR(10g) (W/kg)	Reported SAR(10g) (W/kg)	Measured SAR(1g) (W/kg)	Reported SAR(1g) (W/kg)	Power Drift (dB)
Ch.	MHz										
132572	1770	1RB_Mid	Bottom	Fig.22	22.32	23	0.453	0.53	0.828	0.97	-0.07

Note1: The distance between the EUT and the phantom bottom is 10mm.

Note2: The LTE mode is QPSK_20MHz.

14.3 WLAN Evaluation for 2.4G

According to the KDB248227 D01, SAR is measured for 2.4GHz 802.11b DSSS using the initial test position procedure.

Head Evaluation

Table 14.3-1: SAR Values (WLAN - Head)– 802.11b (Fast SAR)

Frequency		Side	Test Position	Figure No./ Note	Conducted Power (dBm)	Max. tune-up Power (dBm)	Ambient Temperature: 22.9°C		Liquid Temperature: 22.5°C		Power Drift (dB)
MHz	Ch.						Measured SAR(10g) (W/kg)	Reported SAR(10g) (W/kg)	Measured SAR(1g) (W/kg)	Reported SAR(1g) (W/kg)	
2437	6	Left	Touch	/	17.03	18	0.104	0.13	0.207	0.26	0.03
2437	6	Left	Tilt	/	17.03	18	0.089	0.11	0.193	0.24	0.06
2437	6	Right	Touch	/	17.03	18	0.049	0.06	0.091	0.11	0.01
2437	6	Right	Tilt	/	17.03	18	0.069	0.09	0.143	0.18	0.17
2437	6	Left	Touch	S1	17.03	18	0.082	0.10	0.187	0.23	-0.03
2437	6	Left	Touch	B2	17.03	18	0.080	0.10	0.174	0.22	0.01

As shown above table, the initial test position for head is “Left Touch”. So the head SAR of WLAN is presented as below:

Table 14.3-2: SAR Values (WLAN - Head)– 802.11b (Full SAR)

Frequency		Side	Test Position	Figure No./ Note	Conducted Power (dBm)	Max. tune-up Power (dBm)	Ambient Temperature: 22.9°C		Liquid Temperature: 22.5°C		Power Drift (dB)
MHz	Ch.						Measured SAR(10g) (W/kg)	Reported SAR(10g) (W/kg)	Measured SAR(1g) (W/kg)	Reported SAR(1g) (W/kg)	
2437	6	Left	Touch	Fig.23	17.03	18	0.095	0.12	0.205	0.26	0.03

Note1: When the reported SAR of the initial test position is > 0.4 W/kg, SAR is repeated for the 802.11 transmission mode configuration tested in the initial test position using subsequent highest estimated 1-g SAR conditions determined by area scans, on the highest maximum output power channel, until the reported SAR is \leq 0.8 W/kg.

Note2: For all positions/configurations tested using the initial test position and subsequent test positions, when the reported SAR is > 0.8 W/kg, SAR is measured for these test positions/configurations on the subsequent next highest measured output power channel until the reported SAR is \leq 1.2 W/kg or all required channels are tested.

According to the KDB248227 D01, The reported SAR must be scaled to 100% transmission duty factor to determine compliance at the maximum tune-up tolerance limit. The scaled reported SAR is presented as below.

Table 14.3-3: SAR Values (WLAN - Head) – 802.11b (Scaled Reported SAR)

Frequency		Side	Test Position	Ambient Temperature: 22.9°C		Liquid Temperature: 22.5°C	
MHz	Ch.			Actual duty factor	maximum duty factor	Reported SAR (1g)(W/kg)	Scaled reported SAR (1g)(W/kg)
2437	6	Left	Touch	100%	100%	0.26	0.26
2437	6	Right	Touch	100%	100%	0.11	0.11

SAR is not required for OFDM because the 802.11b adjusted SAR \leq 1.2 W/kg.

Body Evaluation

Table 14.3-4: SAR Values (WLAN - Body)– 802.11b (Fast SAR)

Frequency		Test Position	Figure No./ Note	Conducted Power (dBm)	Max. tune-up Power (dBm)	Ambient Temperature: 22.9°C		Liquid Temperature: 22.5°C		Power Drift (dB)
MHz	Ch.					Measured SAR(10g) (W/kg)	Reported SAR(10g) (W/kg)	Measured SAR(1g) (W/kg)	Reported SAR(1g)(W/kg)	
2437	6	Front	/	17.03	18	0.013	0.02	0.023	0.03	-0.03
2437	6	Rear	/	17.03	18	0.027	0.03	0.060	0.08	-0.03
2437	6	Right	/	17.03	18	0.012	0.02	0.020	0.03	0.12
2437	6	Top	/	17.03	18	0.016	0.02	0.030	0.04	-0.03
2437	6	Rear	S1	17.03	18	0.023	0.03	0.051	0.06	0.01
2437	6	Rear	B2	17.03	18	0.020	0.03	0.050	0.06	-0.03

As shown above table, the initial test position for body is “Rear”. So the body SAR of WLAN is presented as below:

Table 14.3-5: SAR Values (WLAN - Body)– 802.11b (Full SAR)

Frequency		Test Position	Figure No./ Note	Conducted Power (dBm)	Max. tune-up Power (dBm)	Ambient Temperature: 22.9°C		Liquid Temperature: 22.5°C		Power Drift (dB)
MHz	Ch.					Measured SAR(10g) (W/kg)	Reported SAR(10g) (W/kg)	Measured SAR(1g) (W/kg)	Reported SAR(1g)(W/kg)	
2437	6	Rear	Fig.24	17.03	18	0.029	0.04	0.077	0.10	-0.03

Note1: When the reported SAR of the initial test position is > 0.4 W/kg, SAR is repeated for the 802.11 transmission mode configuration tested in the initial test position using subsequent highest estimated 1-g SAR conditions determined by area scans, on the highest maximum output power channel, until the reported SAR is ≤ 0.8 W/kg.

Note2: For all positions/configurations tested using the initial test position and subsequent test positions, when the reported SAR is > 0.8 W/kg, SAR is measured for these test positions/configurations on the subsequent next highest measured output power channel until the reported SAR is ≤ 1.2 W/kg or all required channels are tested.

According to the KDB248227 D01, The reported SAR must be scaled to 100% transmission duty factor to determine compliance at the maximum tune-up tolerance limit. The scaled reported SAR is presented as below.

Table 14.3-6: SAR Values (WLAN - Body) – 802.11b (Scaled Reported SAR)

Frequency		Test Position	Ambient Temperature: 22.9°C		Liquid Temperature: 22.5°C	
MHz	Ch.		Actual duty factor	maximum duty factor	Reported SAR (1g)(W/kg)	Scaled reported SAR (1g)(W/kg)
2437	6	Rear	100%	100%	0.10	0.10

SAR is not required for OFDM because the 802.11b adjusted SAR ≤ 1.2 W/kg.

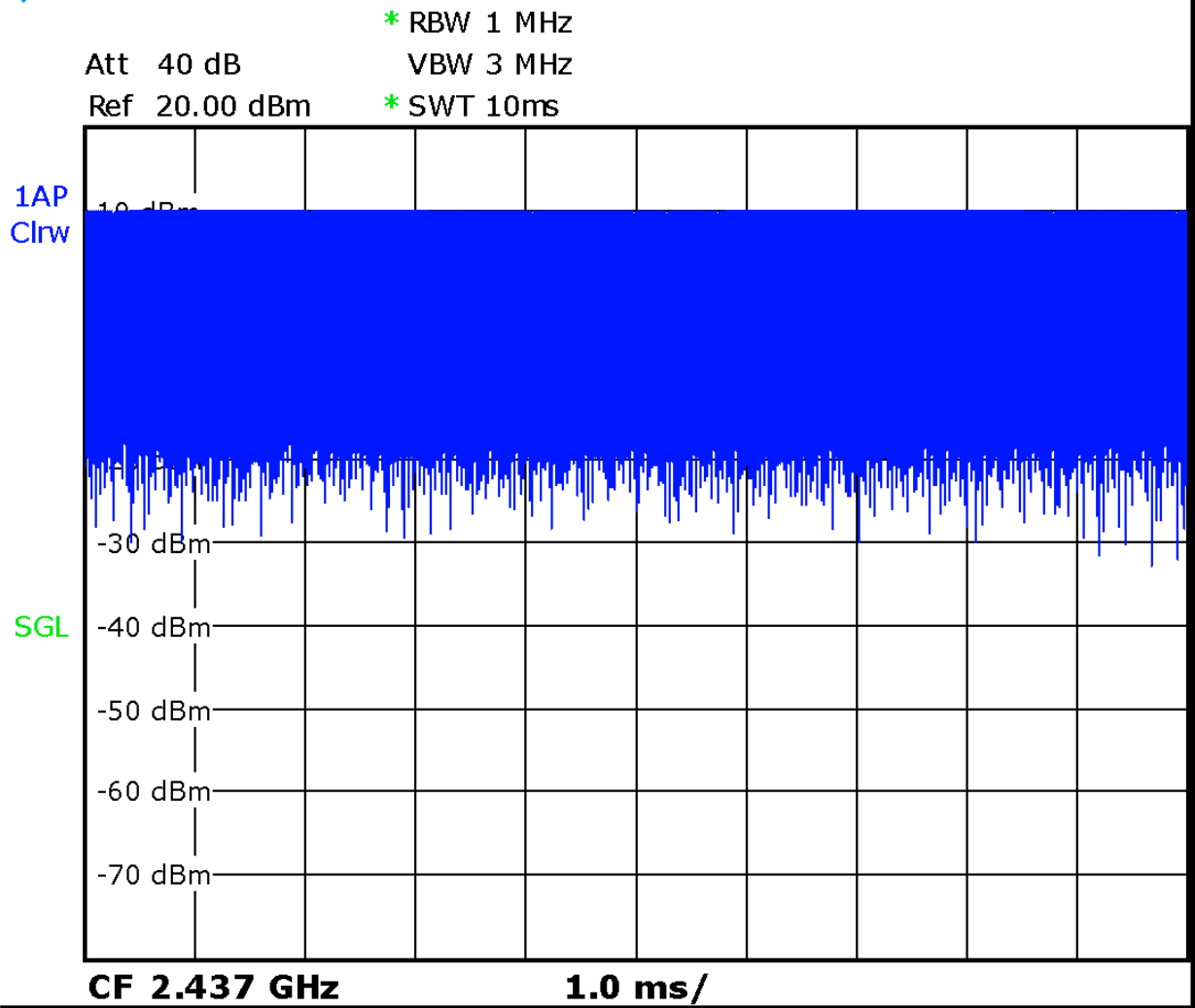

Picture 14.1 Duty factor plot for CH6

15 SAR Measurement Variability

SAR measurement variability must be assessed for each frequency band, which is determined by the SAR probe calibration point and tissue-equivalent medium used for the device measurements. When both head and body tissue-equivalent media are required for SAR measurements in a frequency band, the variability measurement procedures should be applied to the tissue medium with the highest measured SAR, using the highest measured SAR configuration for that tissue-equivalent medium.

The following procedures are applied to determine if repeated measurements are required.

- 1) Repeated measurement is not required when the original highest measured SAR is < 0.80 W/kg; steps 2) through 4) do not apply.
- 2) When the original highest measured SAR is ≥ 0.80 W/kg, repeat that measurement once.
- 3) Perform a second repeated measurement only if the ratio of largest to smallest SAR for the original and first repeated measurements is > 1.20 or when the original or repeated measurement is ≥ 1.45 W/kg ($\sim 10\%$ from the 1-g SAR limit).
- 4) Perform a third repeated measurement only if the original, first or second repeated measurement is ≥ 1.5 W/kg and the ratio of largest to smallest SAR for the original, first and second repeated measurements is > 1.20 .

Table 15.1: SAR Measurement Variability for Body W1900 (1g)

Frequency		Test Position	Spacing (mm)	Original SAR (W/kg)	First Repeated SAR (W/kg)	The Ratio	Second Repeated SAR (W/kg)
Ch.	MHz						
9262	1852.4	Front	10	0.879	0.867	1.01	/

Table 15.2: SAR Measurement Variability for Body LTE B2 (1g)

Frequency		Mode	Test Position	Spacing (mm)	Original SAR (W/kg)	First Repeated SAR (W/kg)	The Ratio	Second Repeated SAR (W/kg)
Ch.	MHz							
18700	1860	1RB_Mid	Bottom	10	0.852	0.846	1.01	/

Table 15.3: SAR Measurement Variability for Body LTE B7 (1g)

Frequency		Mode	Test Position	Spacing (mm)	Original SAR (W/kg)	First Repeated SAR (W/kg)	The Ratio	Second Repeated SAR (W/kg)
Ch.	MHz							
21100	2535	1RB_Low	Rear	10	0.914	0.903	1.01	/

Table 15.4: SAR Measurement Variability for Body LTE B66 (1g)

Frequency		Mode	Test Position	Spacing (mm)	Original SAR (W/kg)	First Repeated SAR (W/kg)	The Ratio	Second Repeated SAR (W/kg)
Ch.	MHz							
132572	1770	1RB_Mid	Bottom	10	0.828	0.814	1.02	/

16 Measurement Uncertainty

16.1 Measurement Uncertainty for Normal SAR Tests (300MHz~3GHz)

No.	Error Description	Type	Uncertainty value	Probably Distribution	Div.	(Ci) 1g	(Ci) 10g	Std. Unc. (1g)	Std. Unc. (10g)	Degree of freedom
Measurement system										
1	Probe calibration	B	6.0	N	1	1	1	6.0	6.0	∞
2	Isotropy	B	4.7	R	$\sqrt{3}$	0.7	0.7	1.9	1.9	∞
3	Boundary effect	B	1.0	R	$\sqrt{3}$	1	1	0.6	0.6	∞
4	Linearity	B	4.7	R	$\sqrt{3}$	1	1	2.7	2.7	∞
5	Detection limit	B	1.0	N	1	1	1	0.6	0.6	∞
6	Readout electronics	B	0.3	R	$\sqrt{3}$	1	1	0.3	0.3	∞
7	Response time	B	0.8	R	$\sqrt{3}$	1	1	0.5	0.5	∞
8	Integration time	B	2.6	R	$\sqrt{3}$	1	1	1.5	1.5	∞
9	RF ambient conditions-noise	B	0	R	$\sqrt{3}$	1	1	0	0	∞
10	RF ambient conditions-reflection	B	0	R	$\sqrt{3}$	1	1	0	0	∞
11	Probe positioned mech. restrictions	B	0.4	R	$\sqrt{3}$	1	1	0.2	0.2	∞
12	Probe positioning with respect to phantom shell	B	2.9	R	$\sqrt{3}$	1	1	1.7	1.7	∞
13	Post-processing	B	1.0	R	$\sqrt{3}$	1	1	0.6	0.6	∞
Test sample related										
14	Test sample positioning	A	3.3	N	1	1	1	3.3	3.3	71
15	Device holder uncertainty	A	3.4	N	1	1	1	3.4	3.4	5
16	Drift of output power	B	5.0	R	$\sqrt{3}$	1	1	2.9	2.9	∞
Phantom and set-up										
17	Phantom uncertainty	B	4.0	R	$\sqrt{3}$	1	1	2.3	2.3	∞
18	Liquid conductivity (target)	B	5.0	R	$\sqrt{3}$	0.64	0.43	1.8	1.2	∞
19	Liquid conductivity (meas.)	A	2.06	N	1	0.64	0.43	1.32	0.89	43
20	Liquid permittivity (target)	B	5.0	R	$\sqrt{3}$	0.6	0.49	1.7	1.4	∞
21	Liquid permittivity (meas.)	A	1.6	N	1	0.6	0.49	1.0	0.8	521

Combined standard uncertainty	$u_c = \sqrt{\sum_{i=1}^{21} c_i^2 u_i^2}$							9.55	9.43	257
Expanded uncertainty (confidence interval of 95 %)	$u_e = 2u_c$							19.1	18.9	

16.2 Measurement Uncertainty for Normal SAR Tests (3~6GHz)

No.	Error Description	Type	Uncertainty value	Probably Distribution	Div.	(Ci) 1g	(Ci) 10g	Std. Unc. (1g)	Std. Unc. (10g)	Degree of freedom
Measurement system										
1	Probe calibration	B	6.55	N	1	1	1	6.55	6.55	∞
2	Isotropy	B	4.7	R	$\sqrt{3}$	0.7	0.7	1.9	1.9	∞
3	Boundary effect	B	2.0	R	$\sqrt{3}$	1	1	1.2	1.2	∞
4	Linearity	B	4.7	R	$\sqrt{3}$	1	1	2.7	2.7	∞
5	Detection limit	B	1.0	R	$\sqrt{3}$	1	1	0.6	0.6	∞
6	Readout electronics	B	0.3	R	$\sqrt{3}$	1	1	0.3	0.3	∞
7	Response time	B	0.8	R	$\sqrt{3}$	1	1	0.5	0.5	∞
8	Integration time	B	2.6	R	$\sqrt{3}$	1	1	1.5	1.5	∞
9	RF ambient conditions-noise	B	0	R	$\sqrt{3}$	1	1	0	0	∞
10	RFambient conditions-reflection	B	0	R	$\sqrt{3}$	1	1	0	0	∞
11	Probe positioned mech. restrictions	B	0.8	R	$\sqrt{3}$	1	1	0.5	0.5	∞
12	Probe positioning with respect to phantom shell	B	6.7	R	$\sqrt{3}$	1	1	3.9	3.9	∞
13	Post-processing	B	4.0	R	$\sqrt{3}$	1	1	2.3	2.3	∞
Test sample related										
14	Test sample positioning	A	3.3	N	1	1	1	3.3	3.3	71
15	Device holder uncertainty	A	3.4	N	1	1	1	3.4	3.4	5
16	Drift of output power	B	5.0	R	$\sqrt{3}$	1	1	2.9	2.9	∞
Phantom and set-up										
17	Phantom uncertainty	B	4.0	R	$\sqrt{3}$	1	1	2.3	2.3	∞
18	Liquid conductivity (target)	B	5.0	R	$\sqrt{3}$	0.64	0.43	1.8	1.2	∞
19	Liquid conductivity (meas.)	A	2.06	N	1	0.64	0.43	1.32	0.89	43
20	Liquid permittivity	B	5.0	R	$\sqrt{3}$	0.6	0.49	1.7	1.4	∞

	(target)									
21	Liquid permittivity (meas.)	A	1.6	N	1	0.6	0.49	1.0	0.8	521
Combined standard uncertainty		$u_c = \sqrt{\sum_{i=1}^{21} c_i^2 u_i^2}$						10.7	10.6	257
Expanded uncertainty (confidence interval of 95 %)		$u_e = 2u_c$						21.4	21.1	

16.3 Measurement Uncertainty for Fast SAR Tests (300MHz~3GHz)

No.	Error Description	Type	Uncertainty value	Probably Distribution	Div.	(Ci) 1g	(Ci) 10g	Std. Unc. (1g)	Std. Unc. (10g)	Degree of freedom
Measurement system										
1	Probe calibration	B	6.0	N	1	1	1	6.0	6.0	∞
2	Isotropy	B	4.7	R	$\sqrt{3}$	0.7	0.7	1.9	1.9	∞
3	Boundary effect	B	1.0	R	$\sqrt{3}$	1	1	0.6	0.6	∞
4	Linearity	B	4.7	R	$\sqrt{3}$	1	1	2.7	2.7	∞
5	Detection limit	B	1.0	R	$\sqrt{3}$	1	1	0.6	0.6	∞
6	Readout electronics	B	0.3	R	$\sqrt{3}$	1	1	0.3	0.3	∞
7	Response time	B	0.8	R	$\sqrt{3}$	1	1	0.5	0.5	∞
8	Integration time	B	2.6	R	$\sqrt{3}$	1	1	1.5	1.5	∞
9	RF ambient conditions-noise	B	0	R	$\sqrt{3}$	1	1	0	0	∞
10	RF ambient conditions-reflection	B	0	R	$\sqrt{3}$	1	1	0	0	∞
11	Probe positioned mech. Restrictions	B	0.4	R	$\sqrt{3}$	1	1	0.2	0.2	∞
12	Probe positioning with respect to phantom shell	B	2.9	R	$\sqrt{3}$	1	1	1.7	1.7	∞
13	Post-processing	B	1.0	R	$\sqrt{3}$	1	1	0.6	0.6	∞
14	Fast SAR z-Approximation	B	7.0	R	$\sqrt{3}$	1	1	4.0	4.0	∞
Test sample related										
15	Test sample positioning	A	3.3	N	1	1	1	3.3	3.3	71
16	Device holder uncertainty	A	3.4	N	1	1	1	3.4	3.4	5
17	Drift of output power	B	5.0	R	$\sqrt{3}$	1	1	2.9	2.9	∞
Phantom and set-up										
18	Phantom uncertainty	B	4.0	R	$\sqrt{3}$	1	1	2.3	2.3	∞

19	Liquid conductivity (target)	B	5.0	R	$\sqrt{3}$	0.64	0.43	1.8	1.2	∞
20	Liquid conductivity (meas.)	A	2.06	N	1	0.64	0.43	1.32	0.89	43
21	Liquid permittivity (target)	B	5.0	R	$\sqrt{3}$	0.6	0.49	1.7	1.4	∞
22	Liquid permittivity (meas.)	A	1.6	N	1	0.6	0.49	1.0	0.8	521
Combined standard uncertainty		$u_c = \sqrt{\sum_{i=1}^{22} c_i^2 u_i^2}$						10.4	10.3	257
Expanded uncertainty (confidence interval of 95 %)		$u_e = 2u_c$						20.8	20.6	

16.4 Measurement Uncertainty for Fast SAR Tests (3~6GHz)

No.	Error Description	Type	Uncertainty value	Probably Distribution	Div.	(Ci) 1g	(Ci) 10g	Std. Unc. (1g)	Std. Unc. (10g)	Degree of freedom
Measurement system										
1	Probe calibration	B	6.55	N	1	1	1	6.55	6.55	∞
2	Isotropy	B	4.7	R	$\sqrt{3}$	0.7	0.7	1.9	1.9	∞
3	Boundary effect	B	2.0	R	$\sqrt{3}$	1	1	1.2	1.2	∞
4	Linearity	B	4.7	R	$\sqrt{3}$	1	1	2.7	2.7	∞
5	Detection limit	B	1.0	R	$\sqrt{3}$	1	1	0.6	0.6	∞
6	Readout electronics	B	0.3	R	$\sqrt{3}$	1	1	0.3	0.3	∞
7	Response time	B	0.8	R	$\sqrt{3}$	1	1	0.5	0.5	∞
8	Integration time	B	2.6	R	$\sqrt{3}$	1	1	1.5	1.5	∞
9	RF ambient conditions-noise	B	0	R	$\sqrt{3}$	1	1	0	0	∞
10	RFambient conditions-reflection	B	0	R	$\sqrt{3}$	1	1	0	0	∞
11	Probe positioned mech. Restrictions	B	0.8	R	$\sqrt{3}$	1	1	0.5	0.5	∞
12	Probe positioning with respect to phantom shell	B	6.7	R	$\sqrt{3}$	1	1	3.9	3.9	∞
13	Post-processing	B	1.0	R	$\sqrt{3}$	1	1	0.6	0.6	∞
14	Fast SAR z-Approximation	B	14.0	R	$\sqrt{3}$	1	1	8.1	8.1	∞
Test sample related										
15	Test sample positioning	A	3.3	N	1	1	1	3.3	3.3	71
16	Device holder	A	3.4	N	1	1	1	3.4	3.4	5

	uncertainty									
17	Drift of output power	B	5.0	R	$\sqrt{3}$	1	1	2.9	2.9	∞
Phantom and set-up										
18	Phantom uncertainty	B	4.0	R	$\sqrt{3}$	1	1	2.3	2.3	∞
19	Liquid conductivity (target)	B	5.0	R	$\sqrt{3}$	0.64	0.43	1.8	1.2	∞
20	Liquid conductivity (meas.)	A	2.06	N	1	0.64	0.43	1.32	0.89	43
21	Liquid permittivity (target)	B	5.0	R	$\sqrt{3}$	0.6	0.49	1.7	1.4	∞
22	Liquid permittivity (meas.)	A	1.6	N	1	0.6	0.49	1.0	0.8	521
Combined standard uncertainty		$u_c = \sqrt{\sum_{i=1}^{22} c_i^2 u_i^2}$						13.5	13.4	257
Expanded uncertainty (confidence interval of 95 %)		$u_e = 2u_c$						27.0	26.8	

17 MAIN TEST INSTRUMENTS

Table 17.1: List of Main Instruments

No.	Name	Type	Serial Number	Calibration Date	Valid Period
01	Network analyzer	E5071C	MY46110673	January 24, 2018	One year
02	Power meter	NRVD	102196	March 07, 2018	One year
03	Power sensor	NRV-Z5	100596		
04	Signal Generator	E4438C	MY49071430	January 23, 2018	One Year
05	Amplifier	60S1G4	0331848	No Calibration Requested	
06	BTS	E5515C	MY50263375	January 23, 2018	One year
07	BTS	CMW500	159890	January 3, 2019	One year
08	E-field Probe	SPEAG EX3DV4	7514	August 27, 2018	One year
09	DAE	SPEAG DAE4	1525	September 18, 2018	One year
10	Dipole Validation Kit	SPEAG D750V3	1017	July 23, 2018	One year
11	Dipole Validation Kit	SPEAG D835V2	4d069	July 23, 2018	One year
12	Dipole Validation Kit	SPEAG D1750V2	1003	July 20, 2018	One year
13	Dipole Validation Kit	SPEAG D1900V2	5d101	July 24, 2018	One year
14	Dipole Validation Kit	SPEAG D2450V2	853	July 24, 2018	One year
15	Dipole Validation Kit	SPEAG D2600V2	1012	July 26, 2018	One year

END OF REPORT BODY

ANNEX A Graph Results

850 Right Cheek High

Date: 2019-1-17

Electronics: DAE4 Sn1525

Medium: Head 850 MHz

Medium parameters used: $f = 848.8$ MHz; $\sigma = 0.881$ mho/m; $\epsilon_r = 41.76$; $\rho = 1000$ kg/m³

Ambient Temperature: 22.9°C Liquid Temperature: 22.5°C

Communication System: GSM 850 Frequency: 848.8 MHz Duty Cycle: 1:8.3

Probe: EX3DV4 – SN7514 ConvF(9.09, 9.09, 9.09)

Area Scan (71x131x1): Interpolated grid: dx=1.000 mm, dy=1.000 mm

Maximum value of SAR (interpolated) = 0.260 W/kg

Zoom Scan (7x7x7)/Cube 0: Measurement grid: dx=5mm, dy=5mm, dz=5mm

Reference Value = 3.268 V/m; Power Drift = -0.17 dB

Peak SAR (extrapolated) = 0.285 W/kg

SAR(1 g) = 0.217 W/kg; SAR(10 g) = 0.163 W/kg

Maximum value of SAR (measured) = 0.253 W/kg

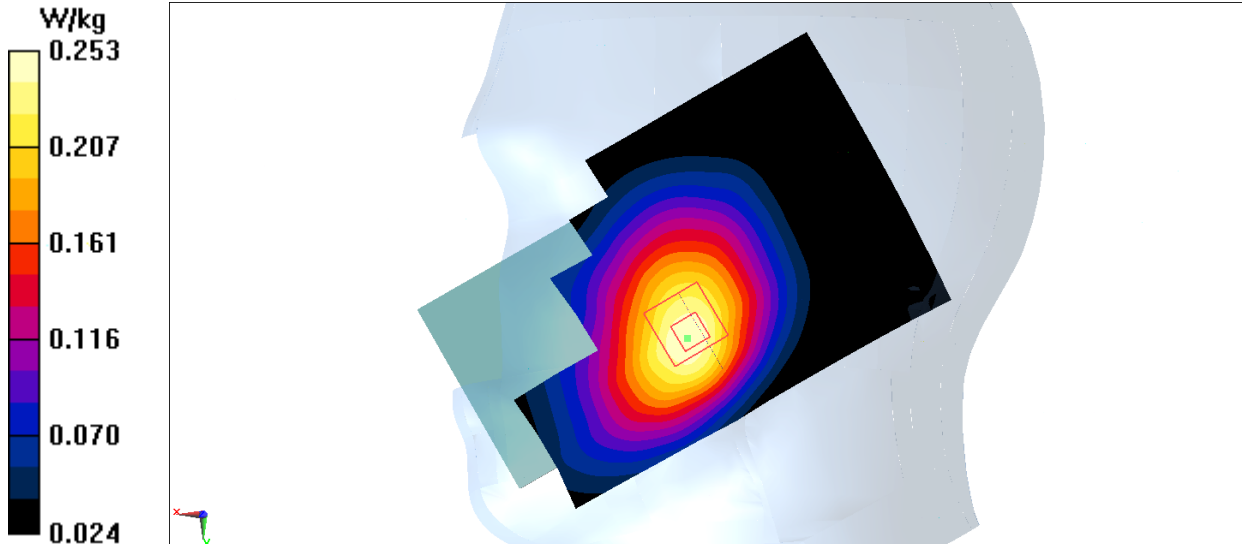

Fig.1 850MHz

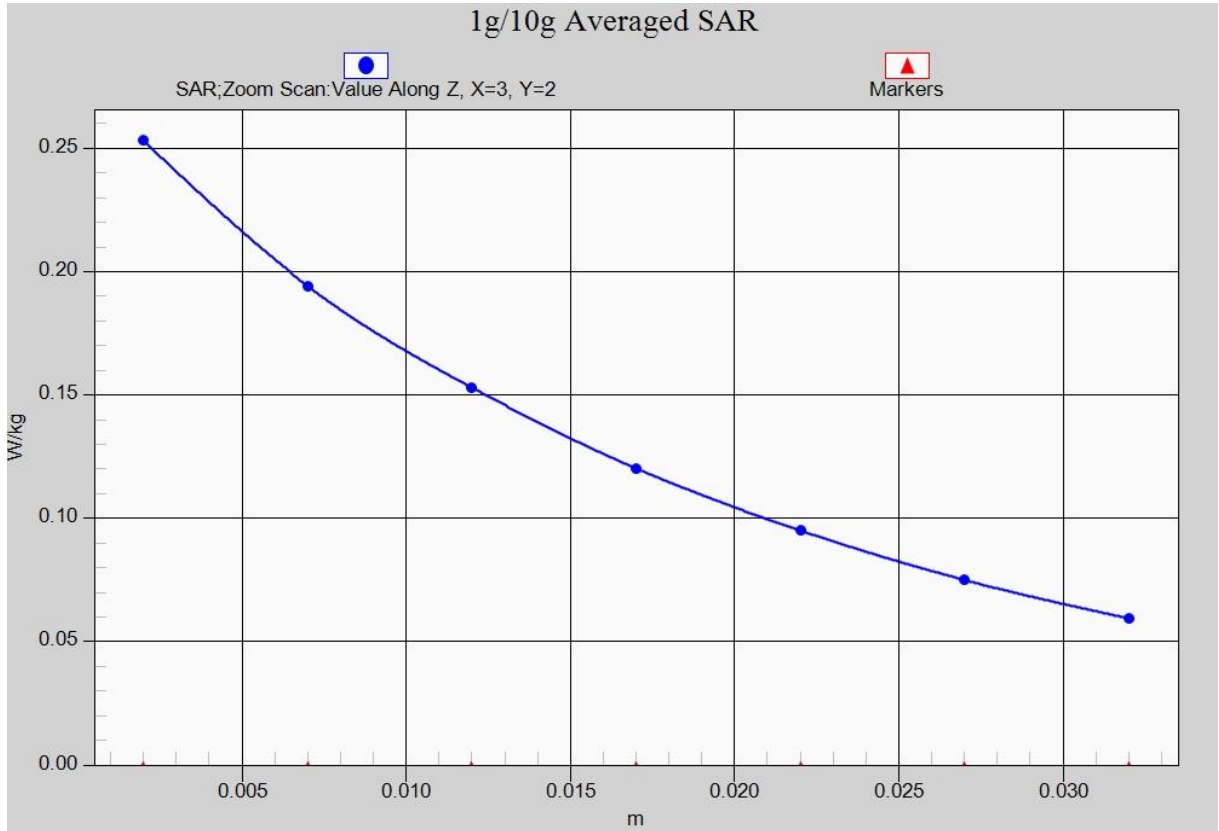

Fig. 1-1 Z-Scan at power reference point (850 MHz)

850 Body Front High

Date: 2019-1-17

Electronics: DAE4 Sn1525

Medium: Body 850 MHz

Medium parameters used: $f = 848.8$ MHz; $\sigma = 0.971$ mho/m; $\epsilon_r = 55.02$; $\rho = 1000$ kg/m³

Ambient Temperature: 22.9°C Liquid Temperature: 22.5°C

Communication System: GSM 850 GPRS Frequency: 848.8 MHz Duty Cycle: 1:8.3

Probe: EX3DV4 – SN7514 ConvF(9.47, 9.47, 9.47)

Area Scan (81x131x1): Interpolated grid: dx=1.000 mm, dy=1.000 mm

Maximum value of SAR (interpolated) = 0.428 W/kg

Zoom Scan (7x7x7)/Cube 0: Measurement grid: dx=5mm, dy=5mm, dz=5mm

Reference Value = 15.63 V/m; Power Drift = 0.01 dB

Peak SAR (extrapolated) = 0.545 W/kg

SAR(1 g) = 0.319 W/kg; SAR(10 g) = 0.182 W/kg

Maximum value of SAR (measured) = 0.353 W/kg

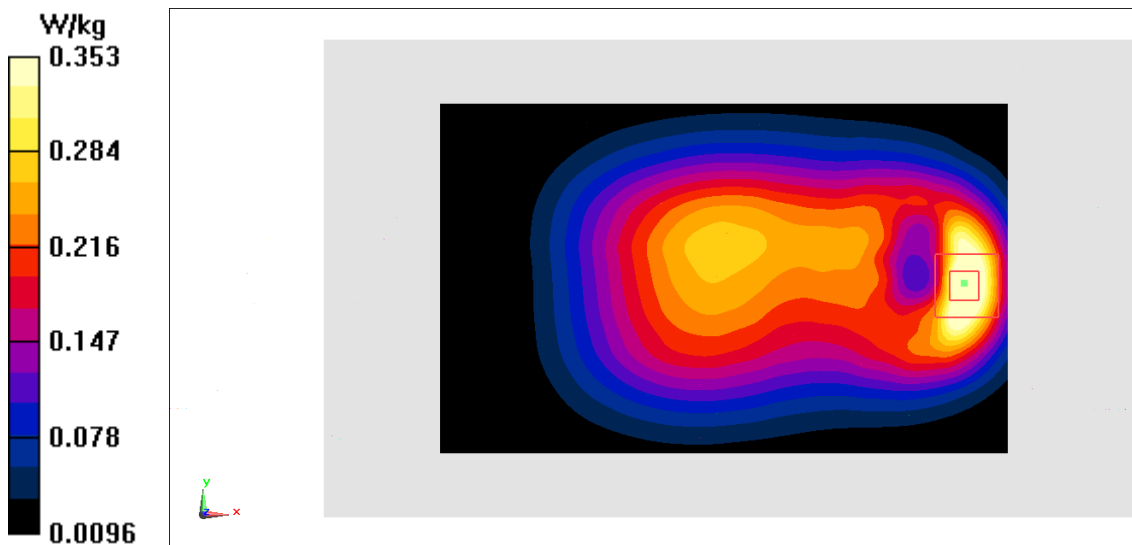

Fig.2 850 MHz

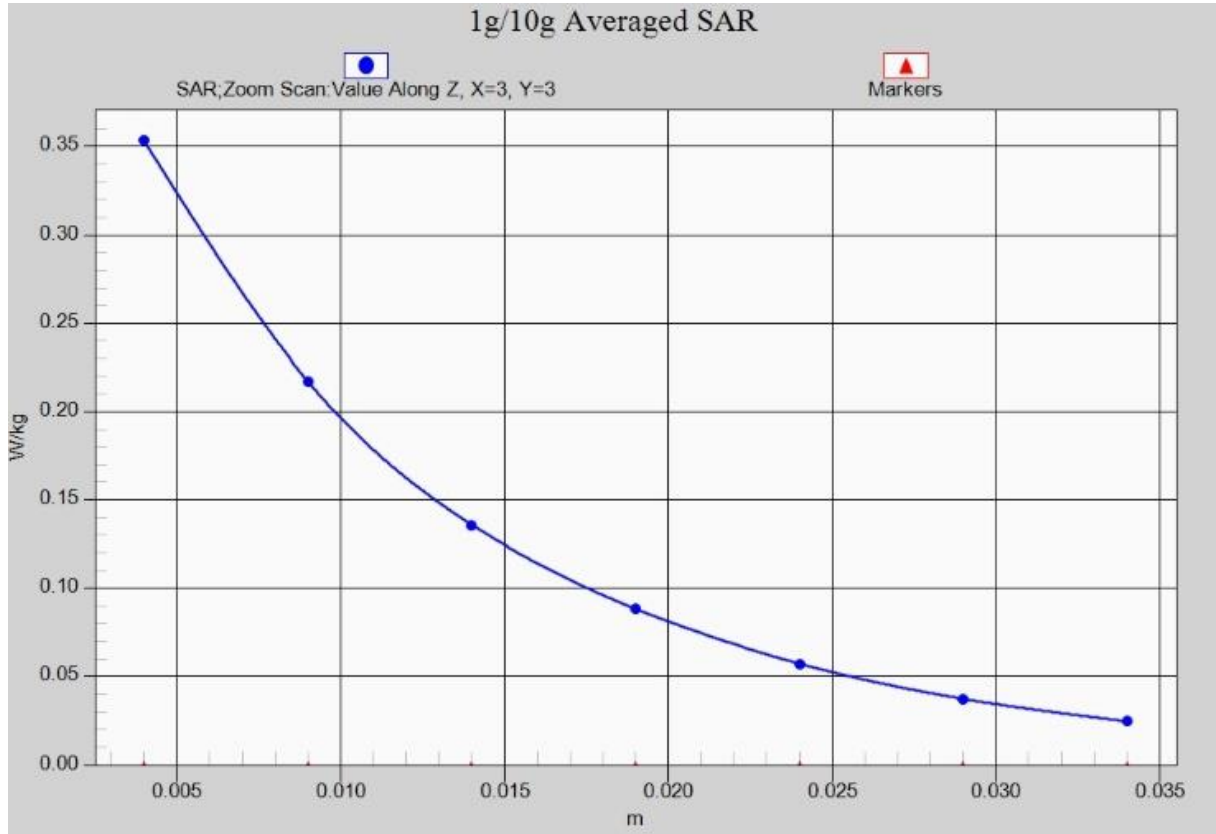

Fig. 2-1 Z-Scan at power reference point (850 MHz)

1900 Left Cheek Middle

Date: 2019-1-19

Electronics: DAE4 Sn1525

Medium: Head 1900 MHz

Medium parameters used: $f = 1880$ MHz; $\sigma = 1.402$ mho/m; $\epsilon_r = 40.4$; $\rho = 1000$ kg/m³

Ambient Temperature: 22.9°C Liquid Temperature: 22.5°C

Communication System: GSM 1900MHz Frequency: 1880 MHz Duty Cycle: 1:8.3

Probe: EX3DV4– SN7514 ConvF(7.73, 7.73, 7.73)

Area Scan (71x131x1): Interpolated grid: $dx=1.000$ mm, $dy=1.000$ mm

Maximum value of SAR (interpolated) = 0.0757 W/kg

Zoom Scan (7x7x7)/Cube 0: Measurement grid: $dx=5$ mm, $dy=5$ mm, $dz=5$ mm

Reference Value = 1.918 V/m; Power Drift = 0.07 dB

Peak SAR (extrapolated) = 0.128 W/kg

SAR(1 g) = 0.072 W/kg; SAR(10 g) = 0.039 W/kg

Maximum value of SAR (measured) = 0.102 W/kg

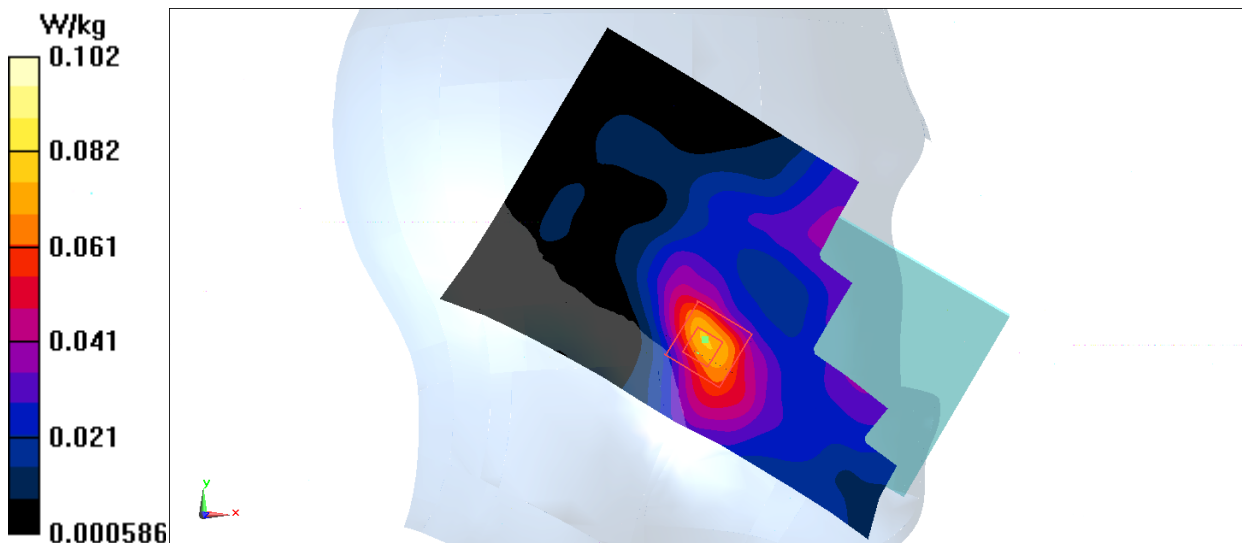

Fig.3 1900 MHz

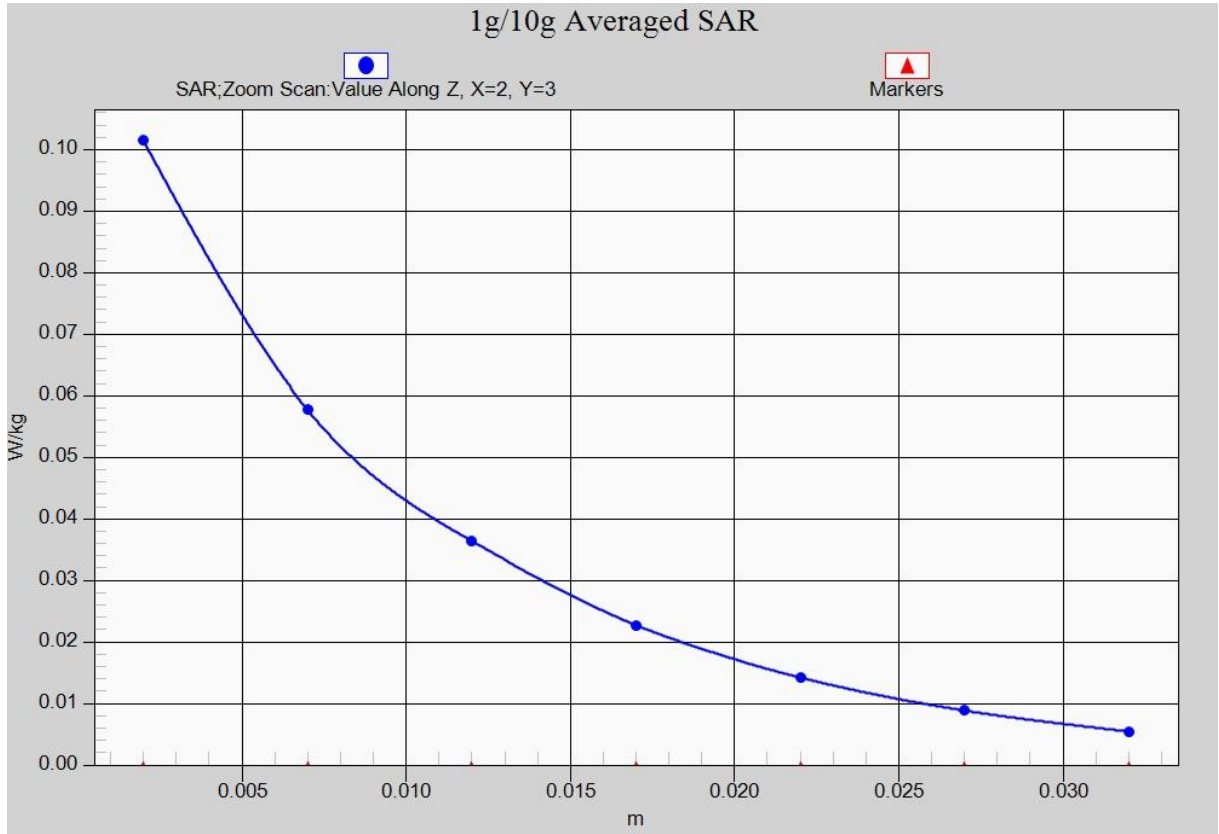

Fig. 3-1 Z-Scan at power reference point (1900 MHz)

1900 Body Rear Middle

Date: 2019-1-19

Electronics: DAE4 Sn1525

Medium: Body 1900 MHz

Medium parameters used: $f = 1880$ MHz; $\sigma = 1.572$ mho/m; $\epsilon_r = 52.43$; $\rho = 1000$ kg/m³

Ambient Temperature: 22.9°C Liquid Temperature: 22.5°C

Communication System: GSM 1900MHz GPRS Frequency: 1909.8 MHz Duty Cycle: 1:2

Probe: EX3DV4- SN7514 ConvF(7.53, 7.53, 7.53)

Area Scan (81x131x1): Interpolated grid: dx=1.000 mm, dy=1.000 mm

Maximum value of SAR (interpolated) = 0.272 W/kg

Zoom Scan (7x7x7)/Cube 0: Measurement grid: dx=5mm, dy=5mm, dz=5mm

Reference Value = 4.024 V/m; Power Drift = 0.06 dB

Peak SAR (extrapolated) = 0.339 W/kg

SAR(1 g) = 0.217 W/kg; SAR(10 g) = 0.130 W/kg

Maximum value of SAR (measured) = 0.279 W/kg

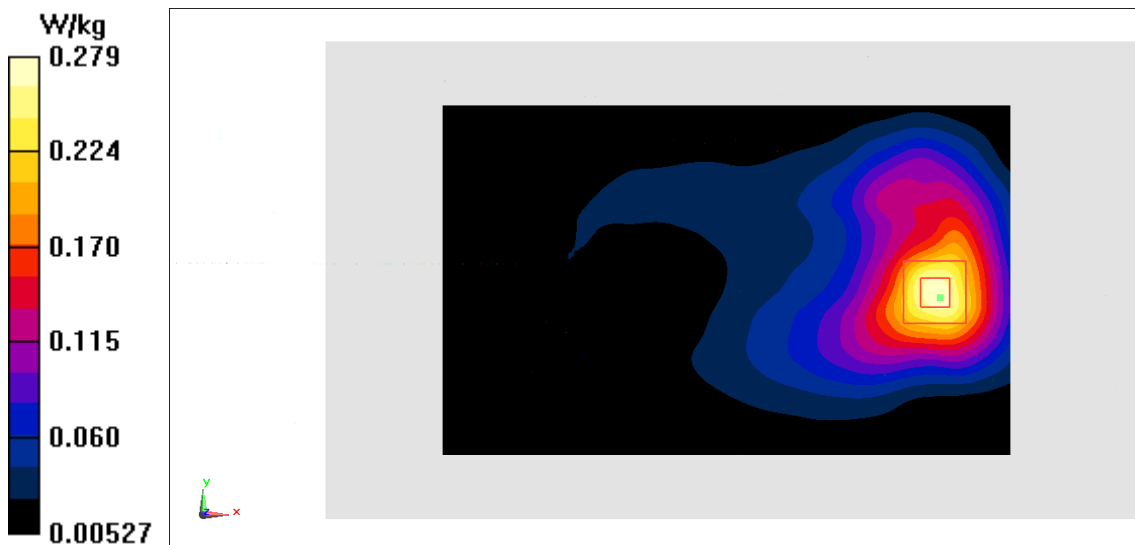

Fig.4 1900 MHz

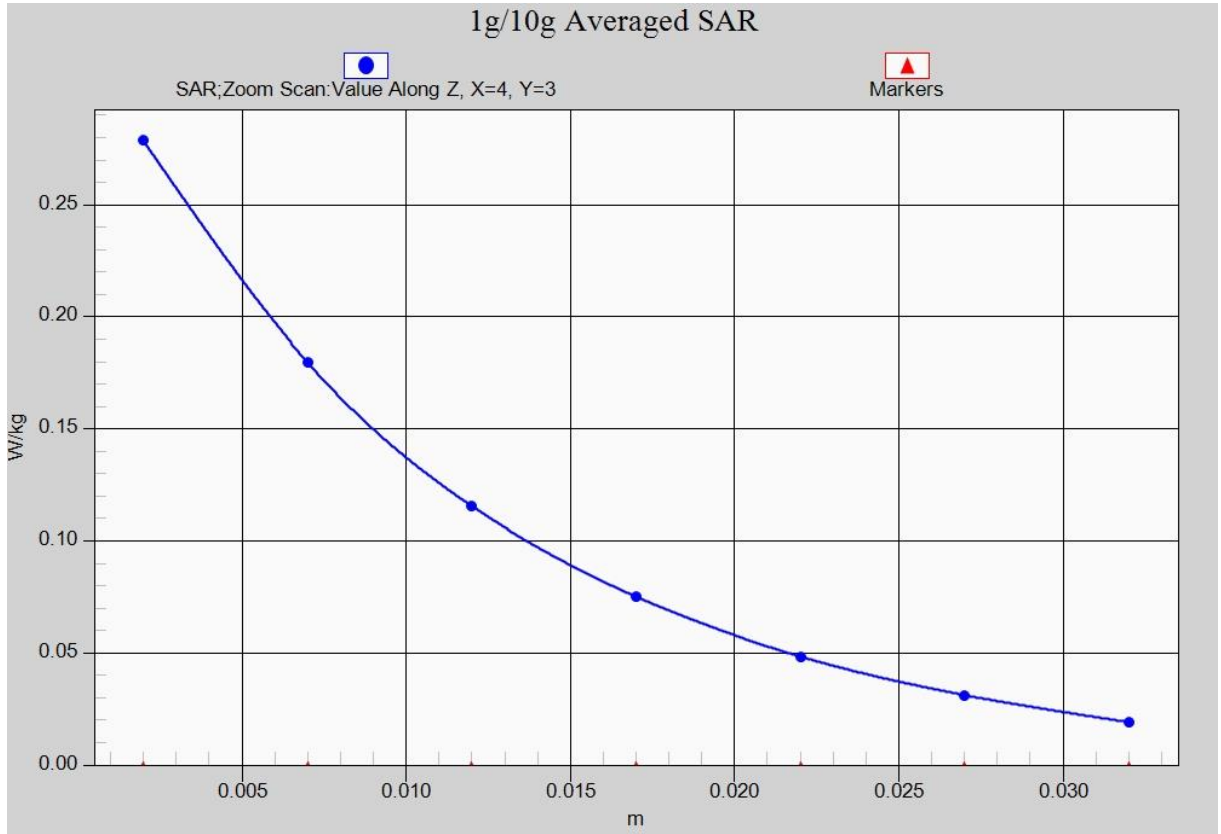

Fig. 4-1 Z-Scan at power reference point (1900 MHz)

WCDMA 850 Right Cheek Low

Date: 2019-1-17

Electronics: DAE4 Sn1525

Medium: Head 850 MHz

Medium parameters used (interpolated): $f = 826.4$ MHz; $\sigma = 0.86$ mho/m; $\epsilon_r = 42.005$; $\rho = 1000$ kg/m³

Ambient Temperature: 22.9°C Liquid Temperature: 22.5°C

Communication System: WCDMA; Frequency: 826.4 MHz; Duty Cycle: 1:1

Probe: EX3DV4 – SN7514 ConvF(9.09, 9.09, 9.09)

Area Scan (71x131x1): Interpolated grid: dx=1.000 mm, dy=1.000 mm

Maximum value of SAR (interpolated) = 0.394 W/kg

Zoom Scan (7x7x7)/Cube 0: Measurement grid: dx=5mm, dy=5mm, dz=5mm

Reference Value = 4.291 V/m; Power Drift = -0.02 dB

Peak SAR (extrapolated) = 0.433 W/kg

SAR(1 g) = 0.335 W/kg; SAR(10 g) = 0.252 W/kg

Maximum value of SAR (measured) = 0.387 W/kg

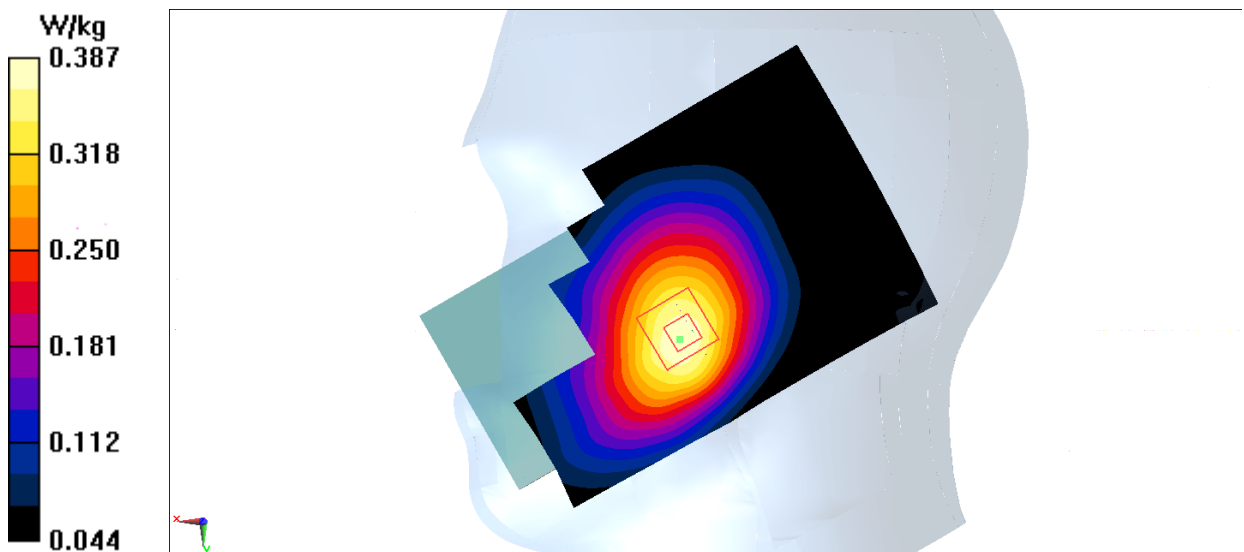

Fig.5 WCDMA 850

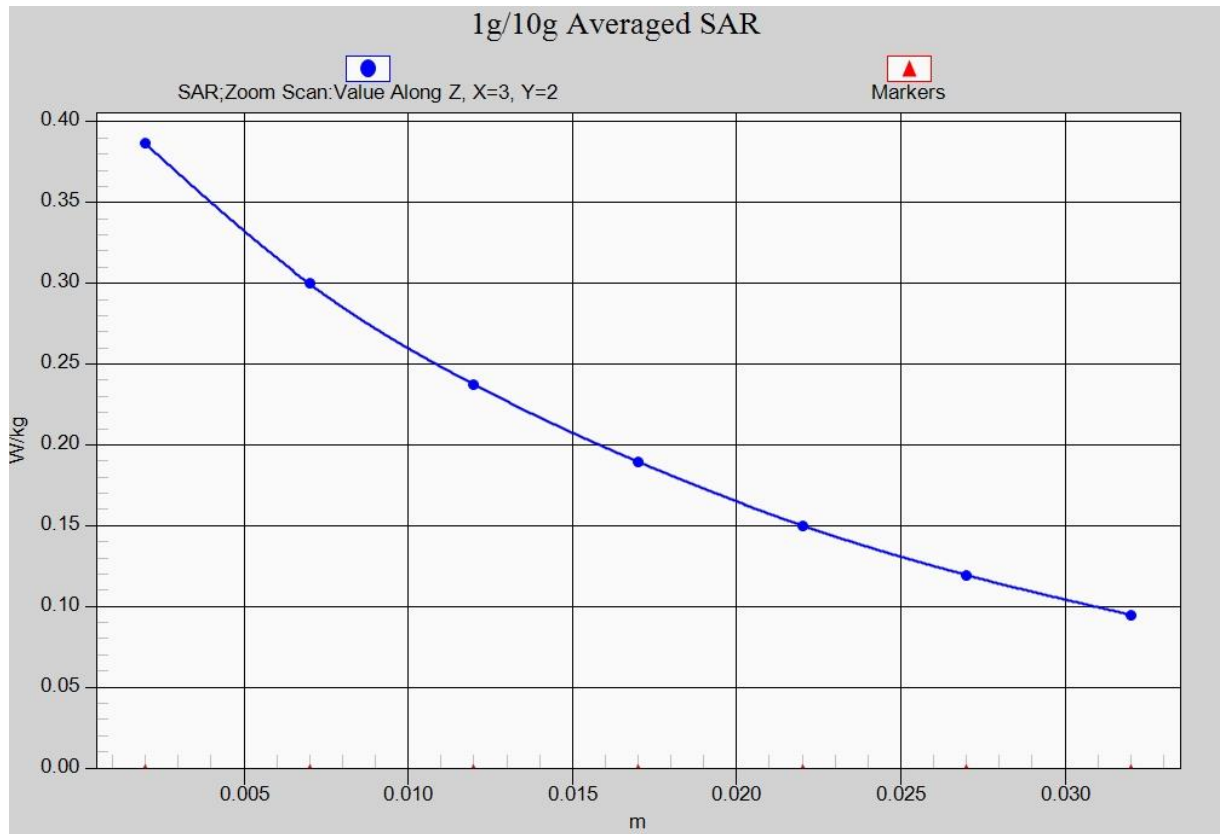

Fig. 5-1 Z-Scan at power reference point (850 MHz)

WCDMA 850 Body Front High

Date: 2019-1-17

Electronics: DAE4 Sn1525

Medium: Body 850 MHz

Medium parameters used (interpolated): $f = 846.6$ MHz; $\sigma = 0.968$ mho/m; $\epsilon_r = 55.026$; $\rho = 1000$ kg/m³

Ambient Temperature: 22.9°C Liquid Temperature: 22.5°C

Communication System: WCDMA; Frequency: 846.6 MHz; Duty Cycle: 1:1

Probe: EX3DV4 – SN7514 ConvF(9.47, 9.47, 9.47)

Area Scan (81x131x1): Interpolated grid: $dx=1.000$ mm, $dy=1.000$ mm

Maximum value of SAR (interpolated) = 0.656 W/kg

Zoom Scan (7x7x7)/Cube 0: Measurement grid: $dx=5$ mm, $dy=5$ mm, $dz=5$ mm

Reference Value = 21.05 V/m; Power Drift = 0.07 dB

Peak SAR (extrapolated) = 0.837 W/kg

SAR(1 g) = 0.489 W/kg; SAR(10 g) = 0.281 W/kg

Maximum value of SAR (measured) = 0.538 W/kg

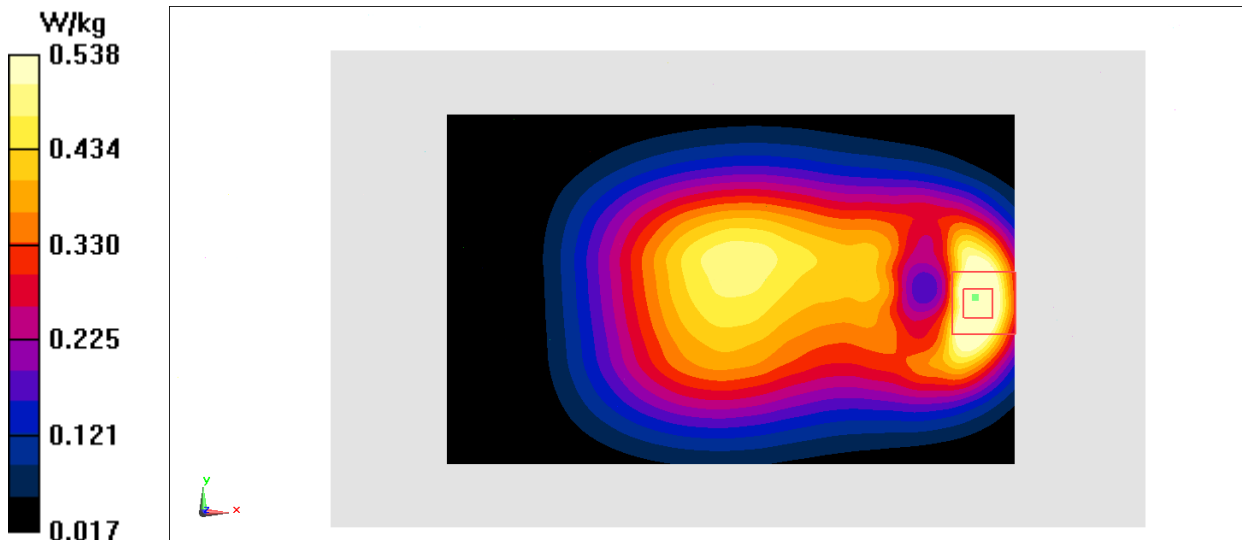

Fig.6 WCDMA 850

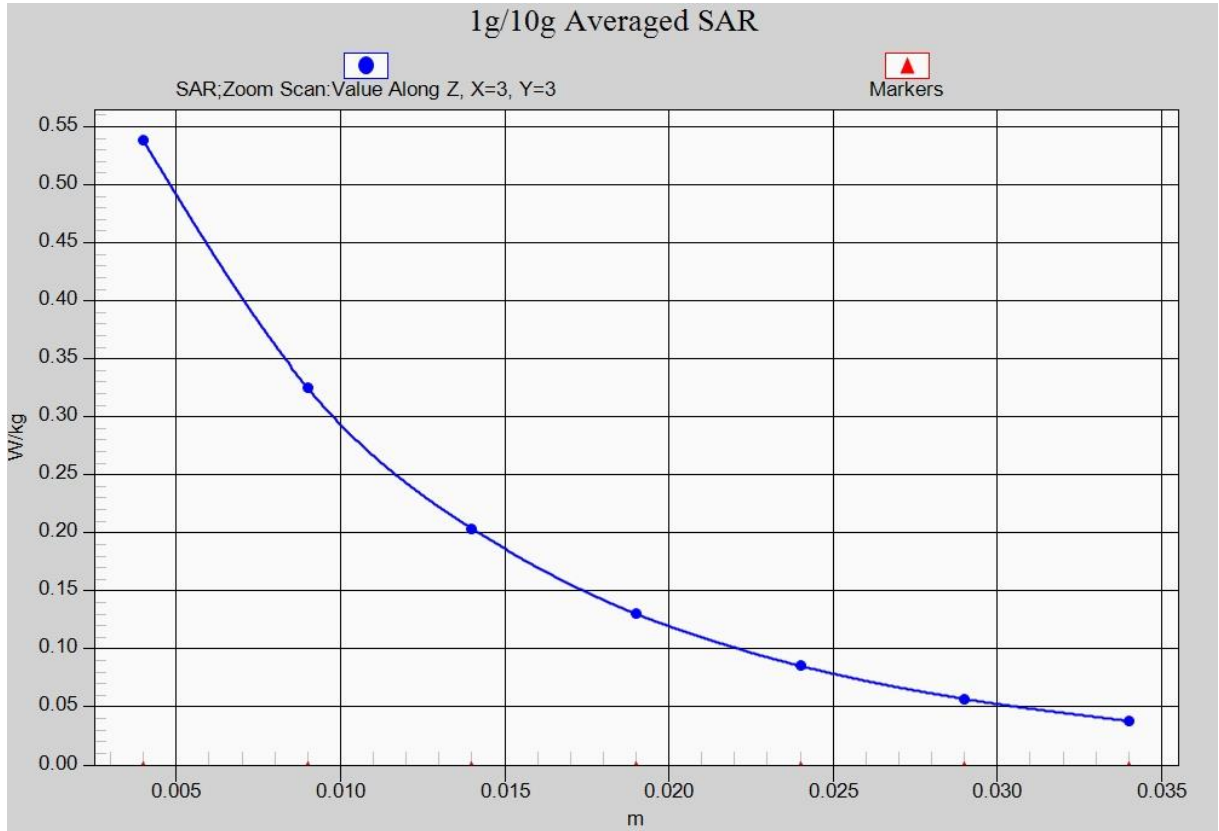

Fig. 6-1 Z-Scan at power reference point (WCDMA850)

WCDMA 1700 Left Cheek Middle

Date: 2019-1-18

Electronics: DAE4 Sn1525

Medium: Head 1750 MHz

Medium parameters used (interpolated): $f = 1732.4$ MHz; $\sigma = 1.326$ mho/m; $\epsilon_r = 40.487$; $\rho = 1000$ kg/m³

Ambient Temperature: 22.9°C Liquid Temperature: 22.5°C

Communication System: WCDMA 1750 Frequency: 1732.4 MHz Duty Cycle: 1:1

Probe: EX3DV4- SN7514 ConvF(8.10, 8.10, 8.10)

Area Scan (71x131x1): Interpolated grid: dx=1.000 mm, dy=1.000 mm

Maximum value of SAR (interpolated) = 0.0906 W/kg

Zoom Scan (7x7x7)/Cube 0: Measurement grid: dx=5mm, dy=5mm, dz=5mm

Reference Value = 2.966 V/m; Power Drift = 0.06 dB

Peak SAR (extrapolated) = 0.131 W/kg

SAR(1 g) = 0.076 W/kg; SAR(10 g) = 0.045 W/kg

Maximum value of SAR (measured) = 0.100 W/kg

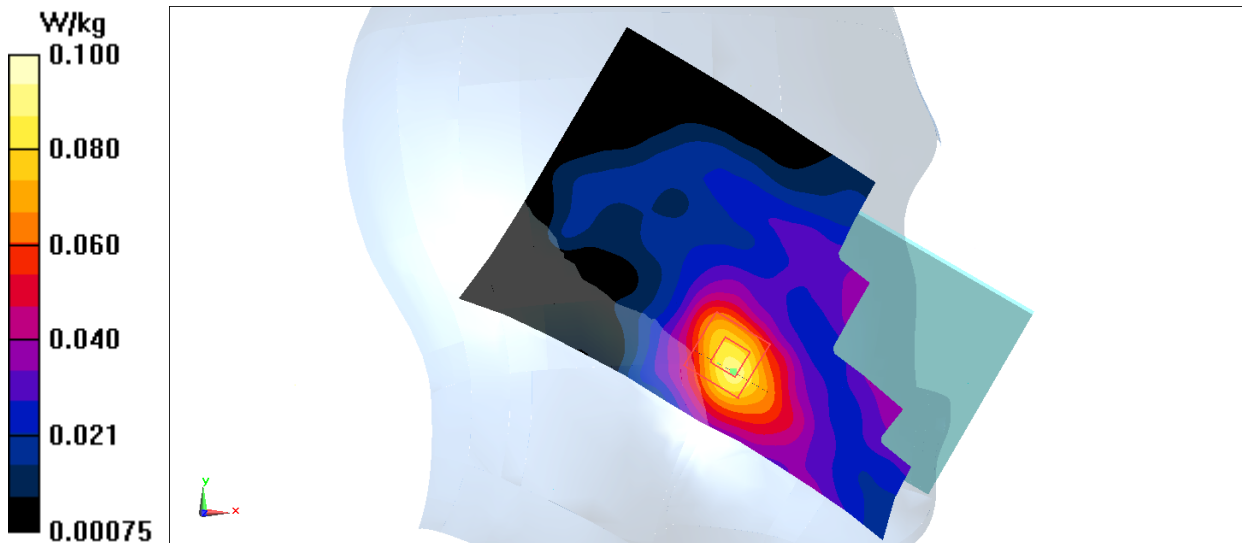

Fig.7 WCDMA1700

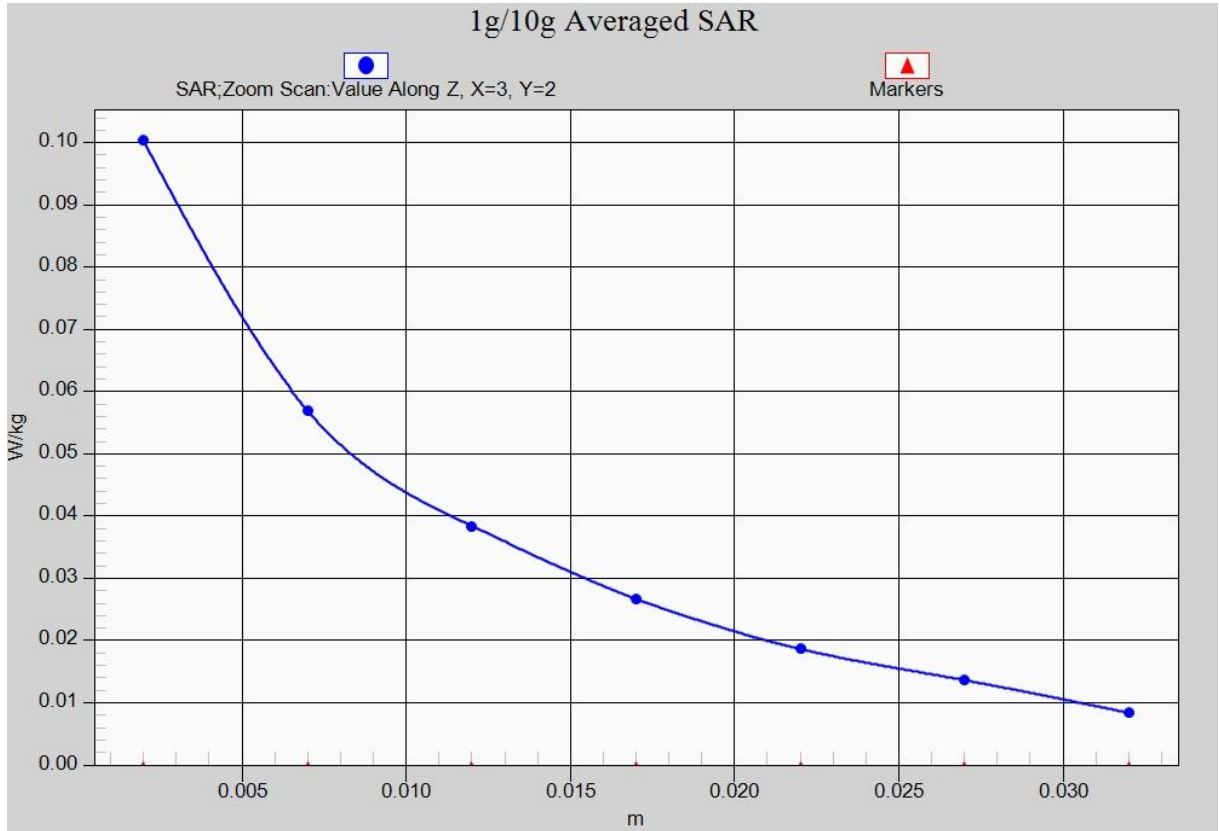

Fig. 7-1 Z-Scan at power reference point (WCDMA1700)

WCDMA 1700 Body Bottom Middle

Date: 2019-1-18

Electronics: DAE4 Sn1525

Medium: Body 1750 MHz

Medium parameters used (interpolated): $f = 1732.4$ MHz; $\sigma = 1.463$ mho/m; $\epsilon_r = 54.478$; $\rho = 1000$ kg/m³

Ambient Temperature: 22.9°C Liquid Temperature: 22.5°C

Communication System: WCDMA 1900 Frequency: 1732.4 MHz Duty Cycle: 1:1

Probe: EX3DV4– SN7514 ConvF(7.82, 7.82, 7.82)

Area Scan (41x81x1): Interpolated grid: dx=1.000 mm, dy=1.000 mm

Maximum value of SAR (interpolated) = 1.03 W/kg

Zoom Scan (7x7x7)/Cube 0: Measurement grid: dx=5mm, dy=5mm, dz=5mm

Reference Value = 22.81 V/m; Power Drift = 0.10 dB

Peak SAR (extrapolated) = 1.24 W/kg

SAR(1 g) = 0.723 W/kg; SAR(10 g) = 0.388 W/kg

Maximum value of SAR (measured) = 0.999 W/kg

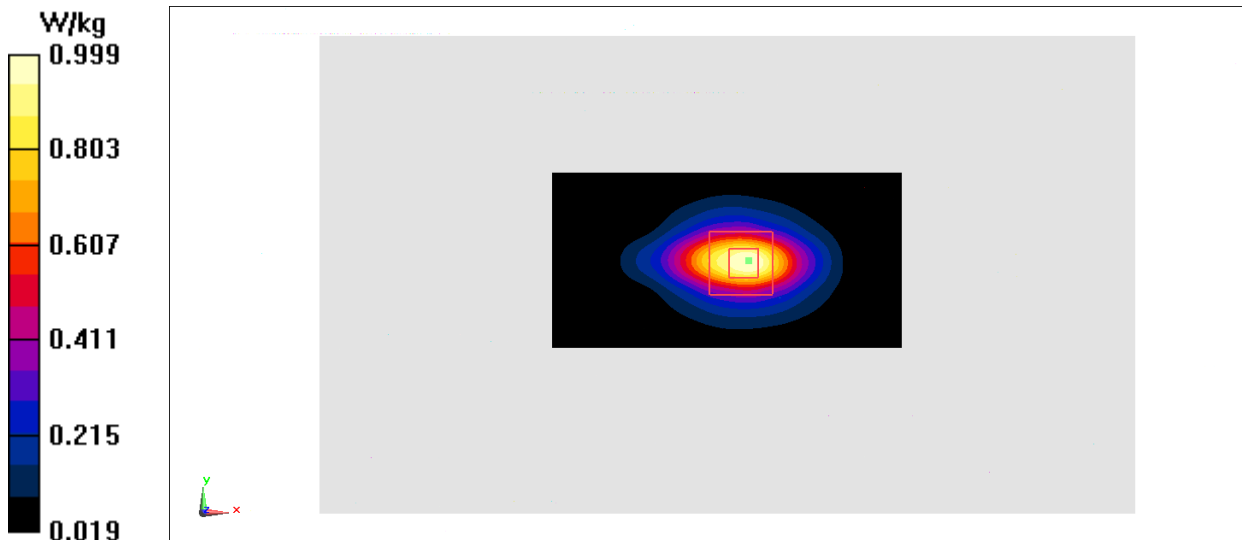

Fig.8 WCDMA1700

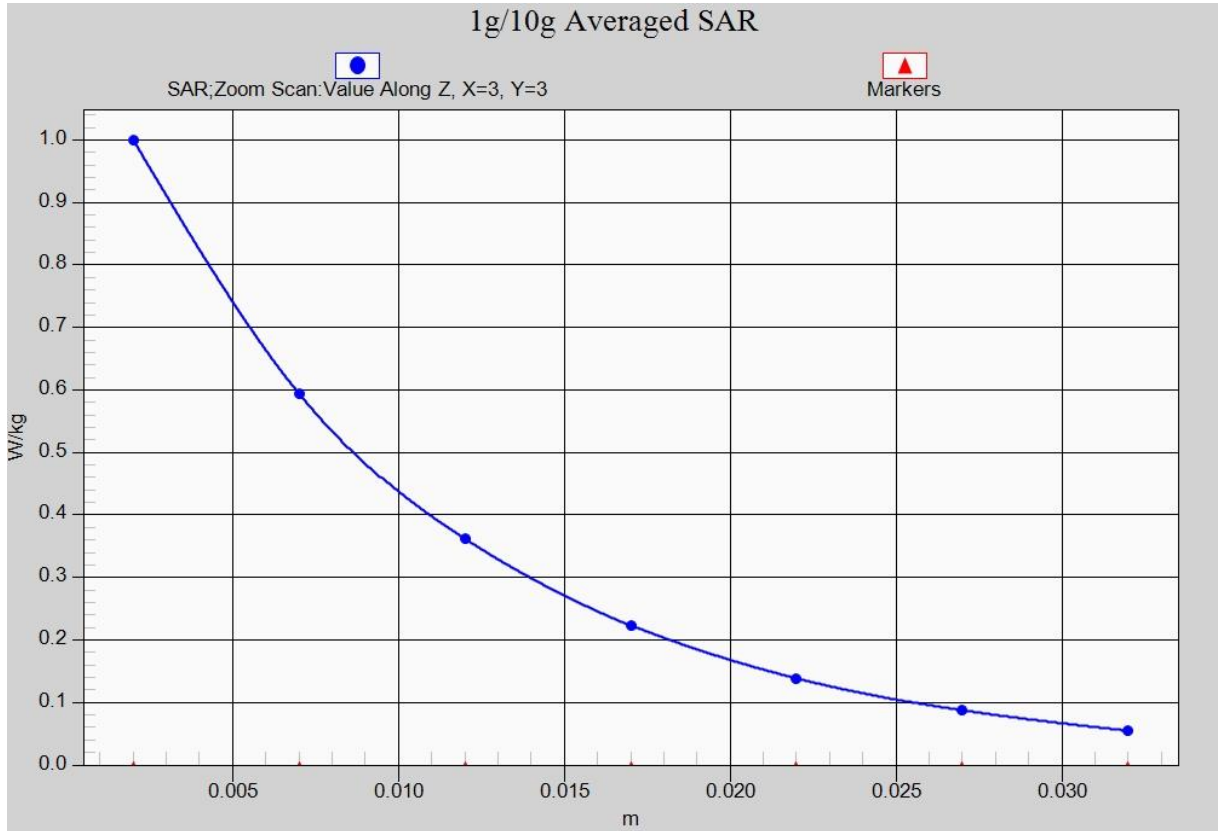

Fig. 8-1 Z-Scan at power reference point (WCDMA1700)

WCDMA 1900 Left Cheek Low

Date: 2019-1-19

Electronics: DAE4 Sn1525

Medium: Head 1900 MHz

Medium parameters used (interpolated): $f = 1852.4$ MHz; $\sigma = 1.376$ mho/m; $\epsilon_r = 40.55$; $\rho = 1000$ kg/m³

Ambient Temperature: 22.9°C Liquid Temperature: 22.5°C

Communication System: WCDMA 1900 Frequency: 1852.4 MHz Duty Cycle: 1:1

Probe: EX3DV4– SN7514 ConvF(7.73, 7.73, 7.73)

Area Scan (71x131x1): Interpolated grid: dx=1.000 mm, dy=1.000 mm

Maximum value of SAR (interpolated) = 0.196 W/kg

Zoom Scan (7x7x7)/Cube 0: Measurement grid: dx=5mm, dy=5mm, dz=5mm

Reference Value = 3.112 V/m; Power Drift = 0.09 dB

Peak SAR (extrapolated) = 0.301 W/kg

SAR(1 g) = 0.171 W/kg; SAR(10 g) = 0.096 W/kg

Maximum value of SAR (measured) = 0.231 W/kg

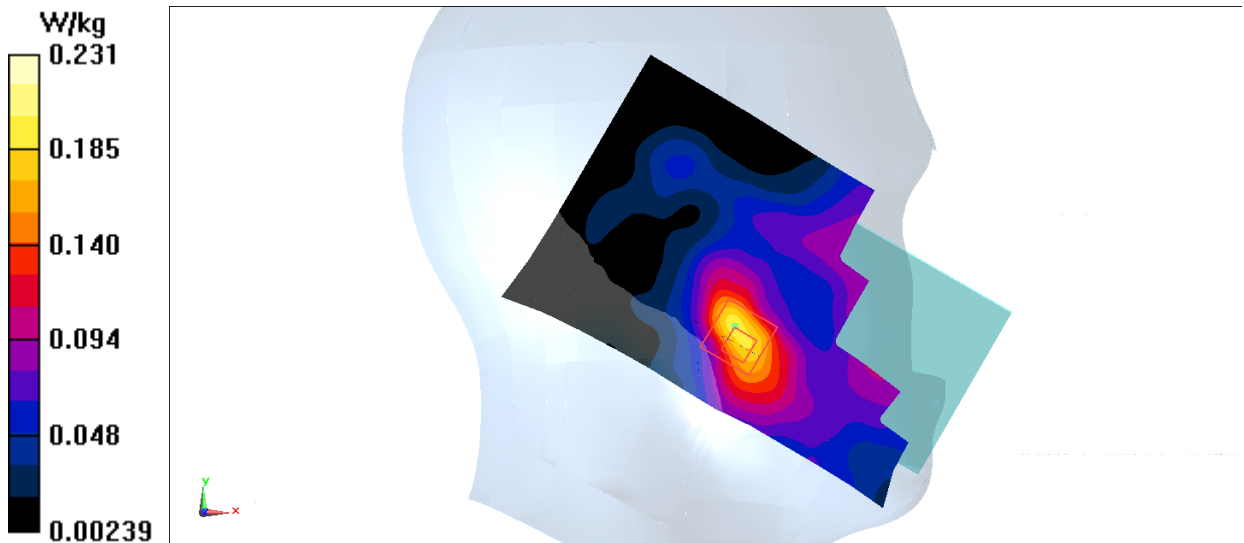

Fig.9 WCDMA1900

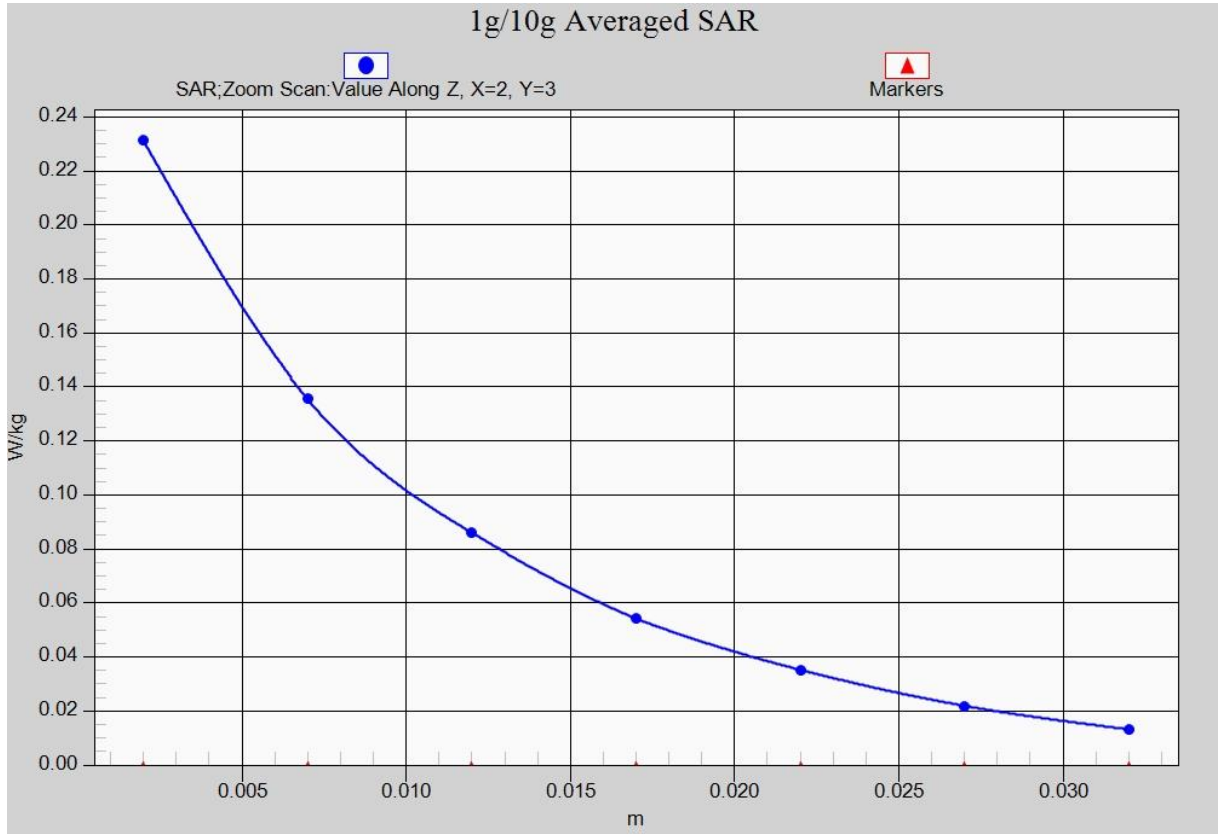

Fig. 9-1 Z-Scan at power reference point (WCDMA1900)

WCDMA 1900 Body Front Low

Date: 2019-1-19

Electronics: DAE4 Sn1525

Medium: Body 1900 MHz

Medium parameters used (interpolated): $f = 1852.4$ MHz; $\sigma = 1.533$ mho/m; $\epsilon_r = 52.8$; $\rho = 1000$ kg/m³

Ambient Temperature: 22.9°C Liquid Temperature: 22.5°C

Communication System: WCDMA 1900 Frequency: 1852.4 MHz Duty Cycle: 1:1

Probe: EX3DV4– SN7514 ConvF(7.53, 7.53, 7.53)

Area Scan (81x131x1): Interpolated grid: dx=1.000 mm, dy=1.000 mm

Maximum value of SAR (interpolated) = 1.16 W/kg

Zoom Scan (7x7x7)/Cube 0: Measurement grid: dx=5mm, dy=5mm, dz=5mm

Reference Value = 6.804 V/m; Power Drift = -0.14 dB

Peak SAR (extrapolated) = 1.39 W/kg

SAR(1 g) = 0.879 W/kg; SAR(10 g) = 0.526 W/kg

Maximum value of SAR (measured) = 1.15 W/kg



Fig.10 WCDMA1900

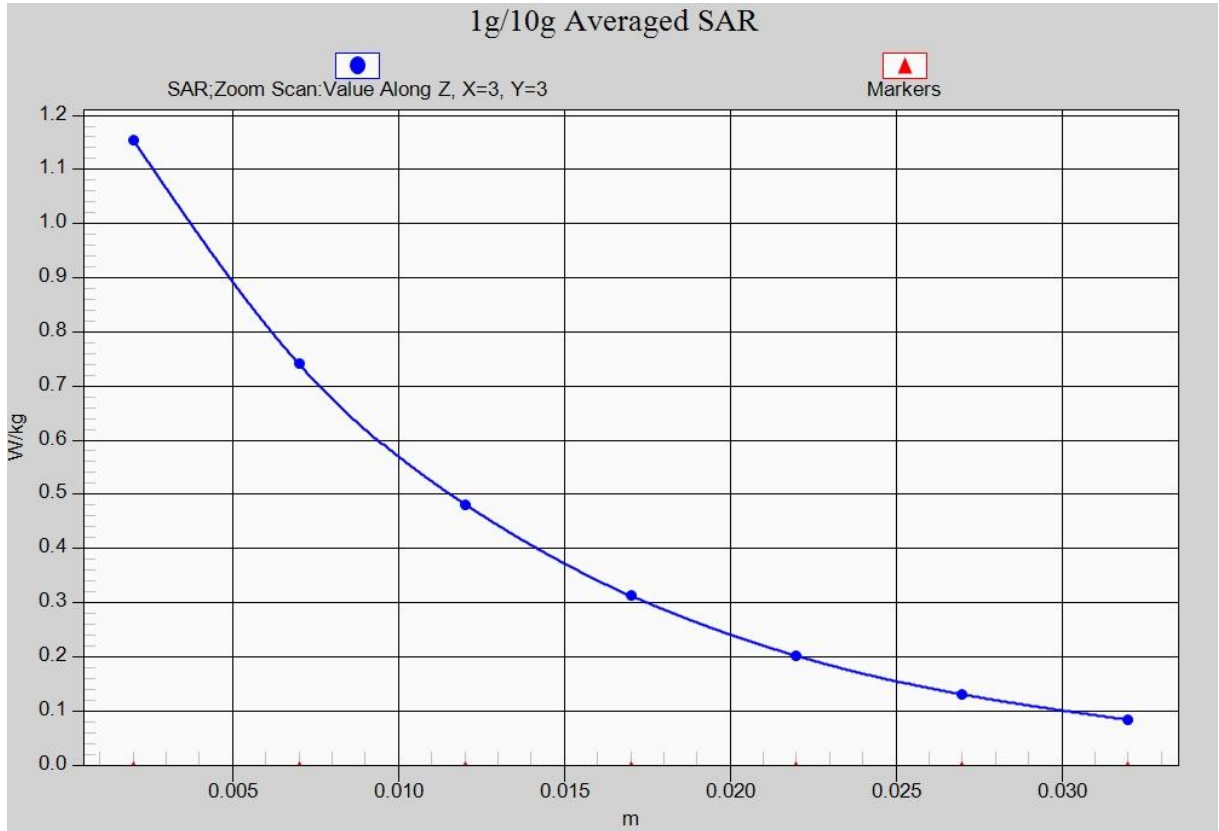

Fig. 10-1 Z-Scan at power reference point (WCDMA1900)

LTE Band2 Right Cheek Middle with QPSK_20M_1RB_Middle

Date: 2019-1-19

Electronics: DAE4 Sn1525

Medium: Head 1900 MHz

Medium parameters used: $f = 1880$ MHz; $\sigma = 1.37$ mho/m; $\epsilon_r = 40.58$; $\rho = 1000$ kg/m³

Ambient Temperature: 22.9°C Liquid Temperature: 22.5°C

Communication System: LTE Band2 Frequency: 1880 MHz Duty Cycle: 1:1

Probe: EX3DV4- SN7514 ConvF(7.73, 7.73, 7.73)

Area Scan (71x131x1): Interpolated grid: dx=1.000 mm, dy=1.000 mm

Maximum value of SAR (interpolated) = 0.220 W/kg

Zoom Scan (7x7x7)/Cube 0: Measurement grid: dx=5mm, dy=5mm, dz=5mm

Reference Value = 2.345 V/m; Power Drift = 0.07 dB

Peak SAR (extrapolated) = 0.259 W/kg

SAR(1 g) = 0.156 W/kg; SAR(10 g) = 0.095 W/kg

Maximum value of SAR (measured) = 0.210 W/kg

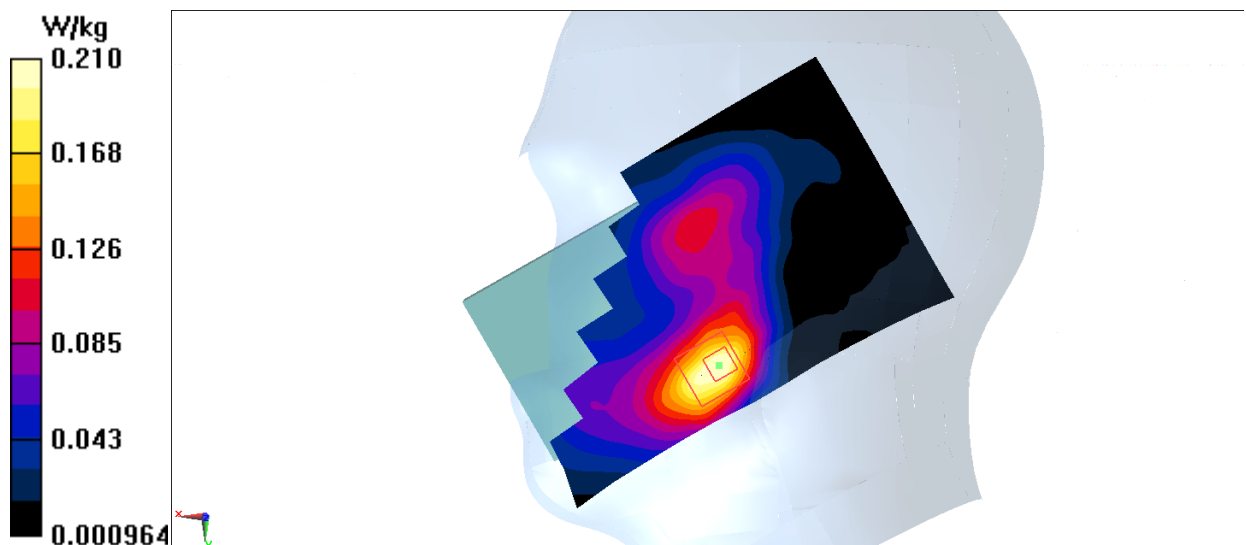

Fig.11 LTE Band2

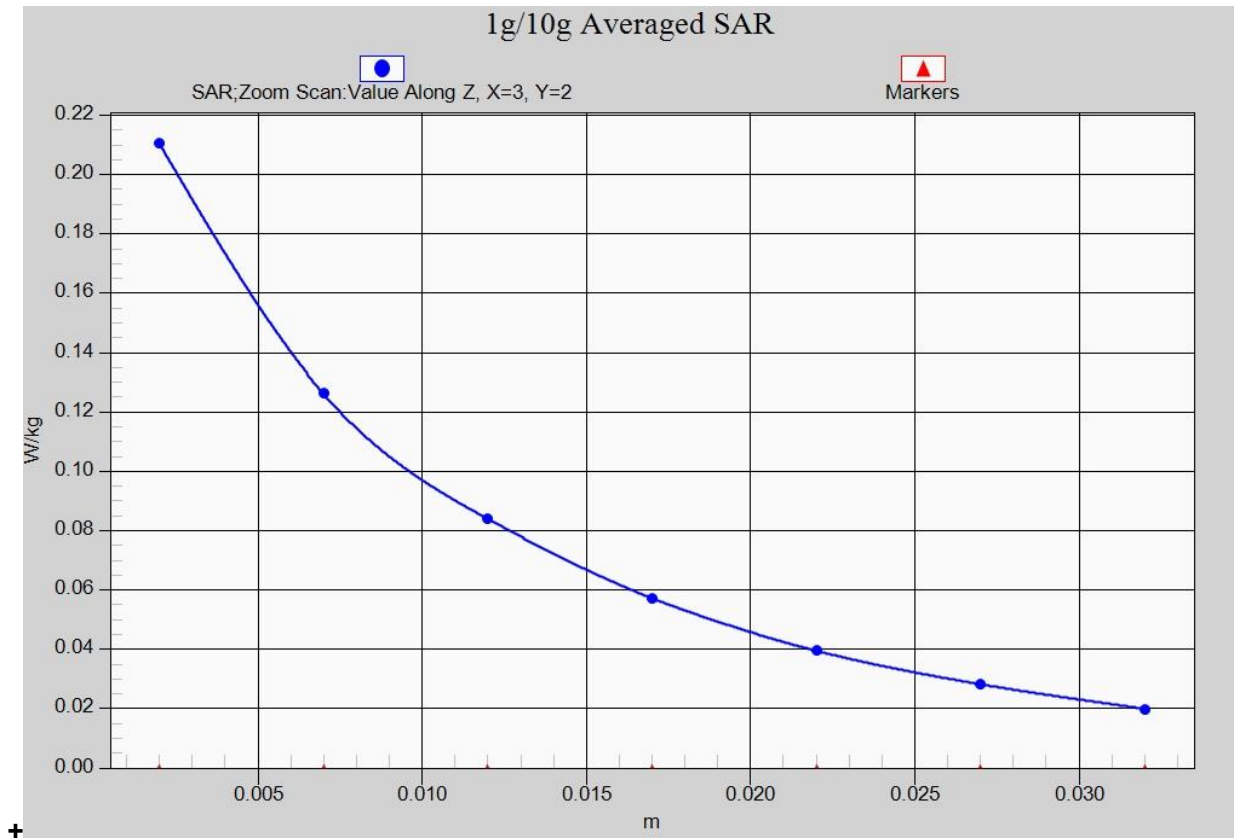

Fig. 11-1 Z-Scan at power reference point (LTE Band2)

LTE Band2 Body Bottom Low with QPSK_20M_1RB_Middle

Date: 2019-1-19

Electronics: DAE4 Sn1525

Medium: Body 1900 MHz

Medium parameters used: $f = 1860$ MHz; $\sigma = 1.52$ mho/m; $\epsilon_r = 52.53$; $\rho = 1000$ kg/m³

Ambient Temperature: 22.9°C Liquid Temperature: 22.5°C

Communication System: LTE Band2 Frequency: 1860 MHz Duty Cycle: 1:1

Probe: EX3DV4– SN7514 ConvF(7.53, 7.53, 7.53)

Area Scan (41x81x1): Interpolated grid: dx=1.000 mm, dy=1.000 mm

Maximum value of SAR (interpolated) = 1.21 W/kg

Zoom Scan (7x7x7)/Cube 0: Measurement grid: dx=5mm, dy=5mm, dz=5mm

Reference Value = 24.87 V/m; Power Drift = 0.05 dB

Peak SAR (extrapolated) = 1.46 W/kg

SAR(1 g) = 0.852 W/kg; SAR(10 g) = 0.466 W/kg

Maximum value of SAR (measured) = 1.17 W/kg

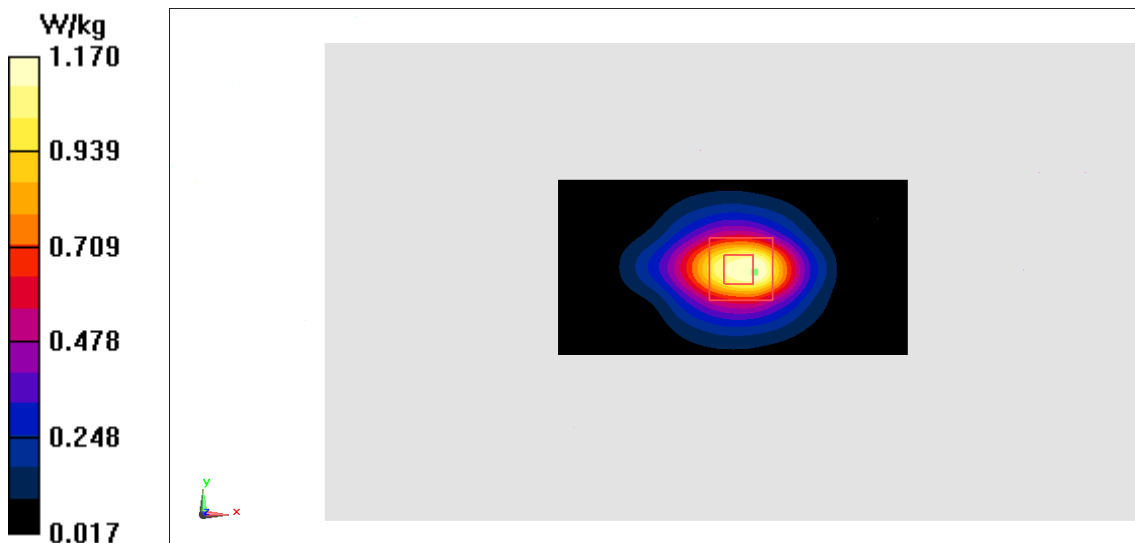

Fig.12 LTE Band2

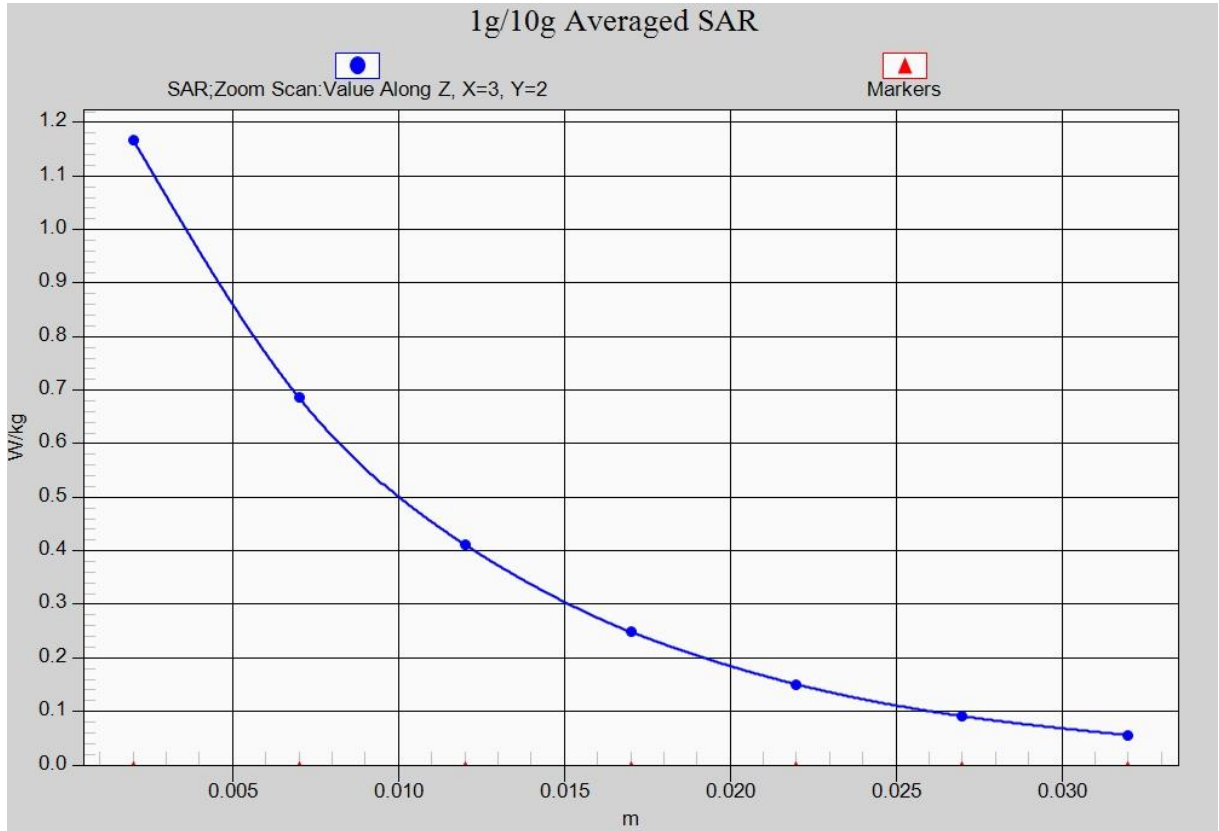

Fig. 12-1 Z-Scan at power reference point (LTE Band2)

LTE Band5 Right Cheek High with QPSK_10M_1RB_Middle

Date: 2019-1-17

Electronics: DAE4 Sn1525

Medium: Head 850 MHz

Medium parameters used (interpolated): $f = 844$ MHz; $\sigma = 0.887$ mho/m; $\epsilon_r = 41.671$; $\rho = 1000$ kg/m³

Ambient Temperature: 22.9°C Liquid Temperature: 22.5°C

Communication System: LTE Band5 Frequency: 844 MHz Duty Cycle: 1:1

Probe: EX3DV4 - SN7514 ConvF(9.09, 9.09, 9.09)

Area Scan (71x131x1): Interpolated grid: $dx=1.000$ mm, $dy=1.000$ mm

Maximum value of SAR (interpolated) = 0.356 W/kg

Zoom Scan (7x7x7)/Cube 0: Measurement grid: $dx=5$ mm, $dy=5$ mm, $dz=5$ mm

Reference Value = 4.692 V/m; Power Drift = 0.09 dB

Peak SAR (extrapolated) = 0.391 W/kg

SAR(1 g) = 0.295 W/kg; SAR(10 g) = 0.222 W/kg

Maximum value of SAR (measured) = 0.342 W/kg

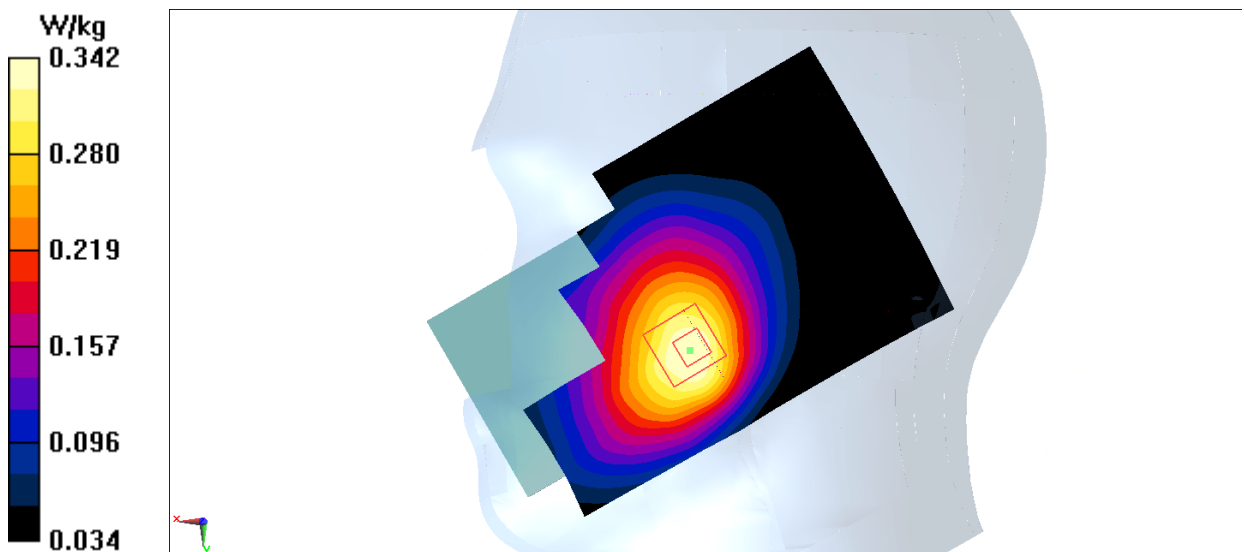

Fig.13 LTE Band5

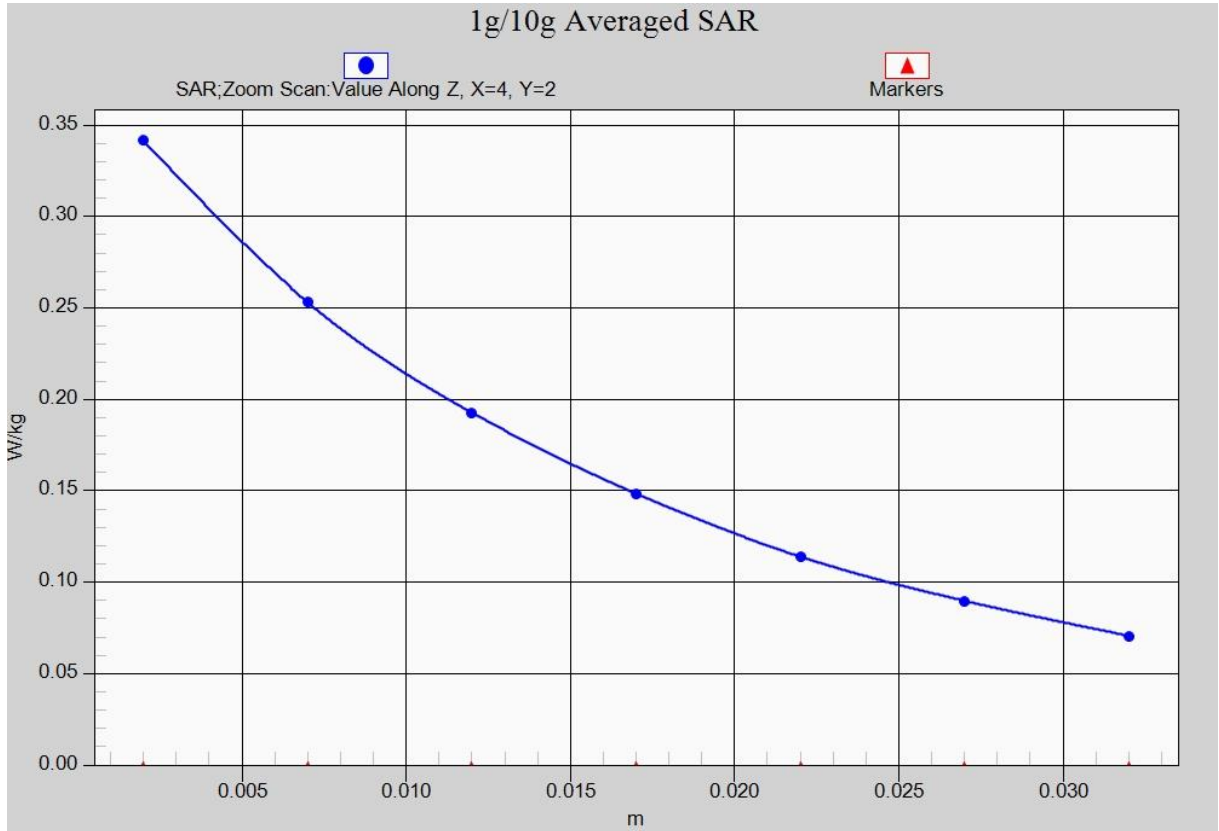

Fig. 13-1 Z-Scan at power reference point (LTE Band5)

LTE Band5 Body Front High with QPSK_10M_1RB_Middle

Date: 2019-1-17

Electronics: DAE4 Sn1525

Medium: Body 850 MHz

Medium parameters used (interpolated): $f = 844$ MHz; $\sigma = 1.003$ mho/m; $\epsilon_r = 54.684$; $\rho = 1000$ kg/m³

Ambient Temperature: 22.9°C Liquid Temperature: 22.5°C

Communication System: LTE Band5 Frequency: 844 MHz Duty Cycle: 1:1

Probe: EX3DV4 - SN7514 ConvF(9.47, 9.47, 9.47)

Area Scan (91x131x1): Interpolated grid: dx=1.000 mm, dy=1.000 mm

Maximum value of SAR (interpolated) = 0.621 W/kg

Zoom Scan (7x7x7)/Cube 0: Measurement grid: dx=5mm, dy=5mm, dz=5mm

Reference Value = 16.98 V/m; Power Drift = -0.03 dB

Peak SAR (extrapolated) = 0.774 W/kg

SAR(1 g) = 0.449 W/kg; SAR(10 g) = 0.259 W/kg

Maximum value of SAR (measured) = 0.607 W/kg

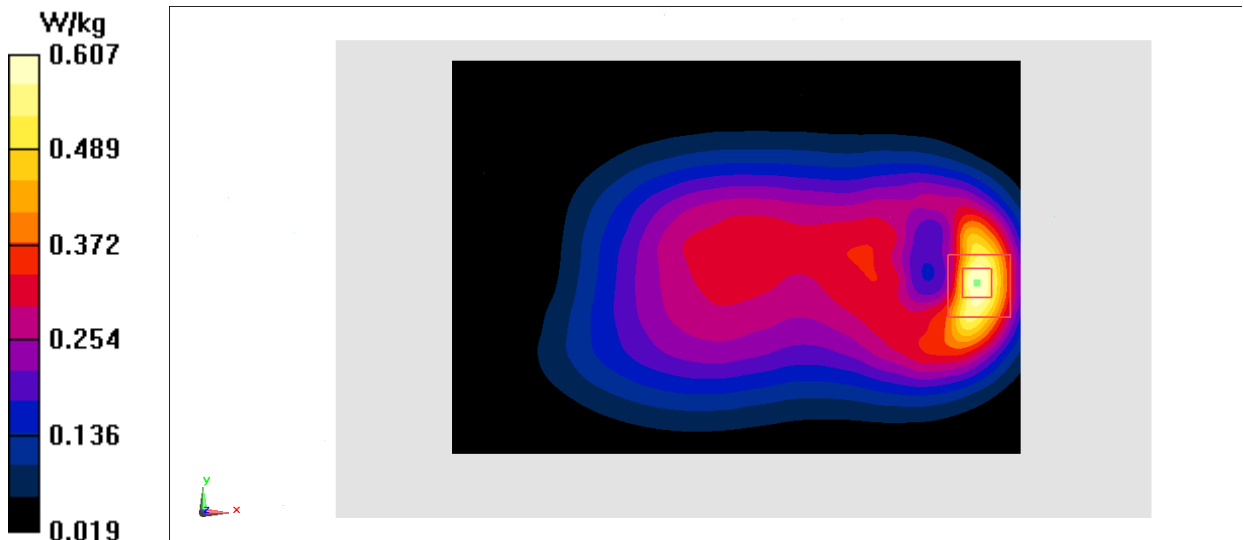

Fig.14 LTE Band5

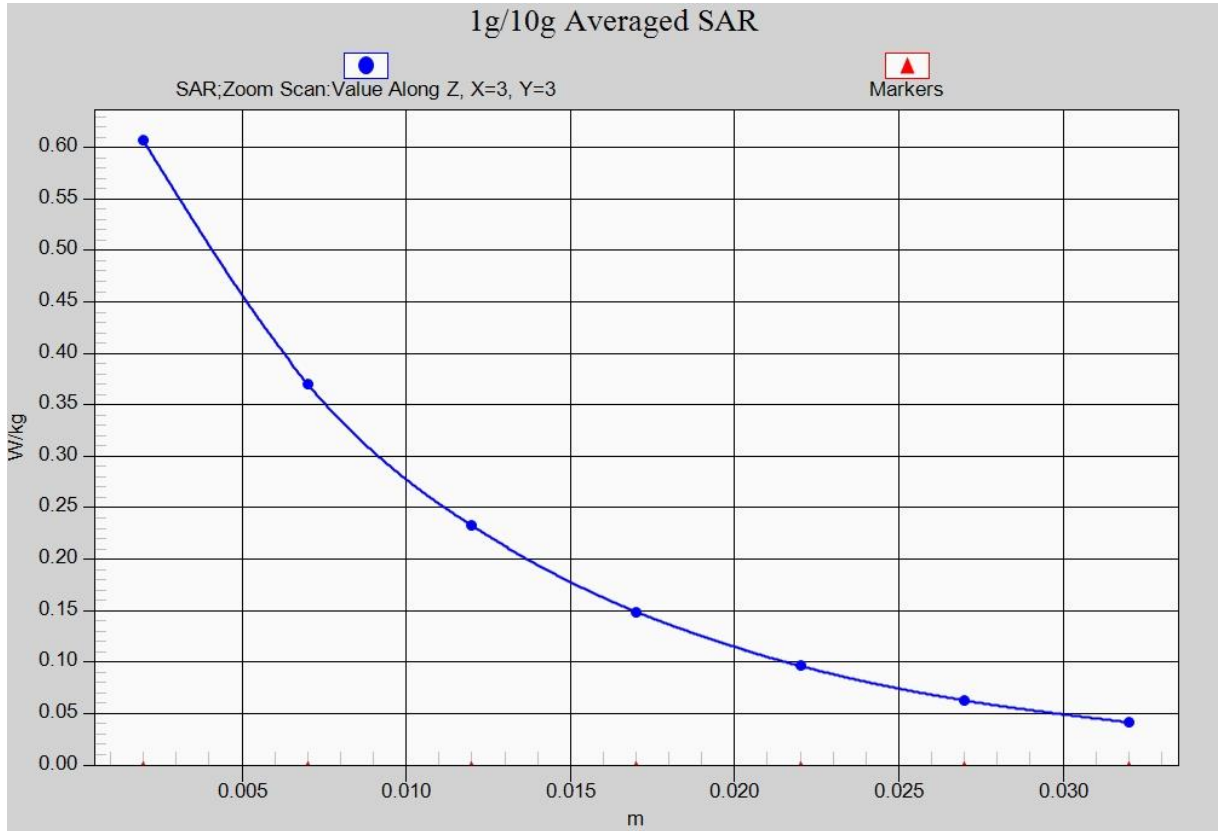

Fig. 14-1 Z-Scan at power reference point (LTE Band5)

LTE Band7 Right Cheek High with QPSK_20M_1RB_Middle

Date: 2019-1-21

Electronics: DAE4 Sn1525

Medium: Head 2600 MHz

Medium parameters used: $f = 2560$ MHz; $\sigma = 1.962$ mho/m; $\epsilon_r = 38.23$; $\rho = 1000$ kg/m³

Ambient Temperature: 22.9°C Liquid Temperature: 22.5°C

Communication System: LTE Band7 Frequency: 2560 MHz Duty Cycle: 1:1

Probe: EX3DV4- SN7514 ConvF(6.92, 6.92, 6.92)

Area Scan (91x151x1): Interpolated grid: dx=1.000 mm, dy=1.000 mm

Maximum value of SAR (interpolated) = 0.258 W/kg

Zoom Scan (7x7x7)/Cube 0: Measurement grid: dx=5mm, dy=5mm, dz=5mm

Reference Value = 2.080 V/m; Power Drift = -0.10 dB

Peak SAR (extrapolated) = 0.314 W/kg

SAR(1 g) = 0.152 W/kg; SAR(10 g) = 0.073 W/kg

Maximum value of SAR (measured) = 0.225 W/kg

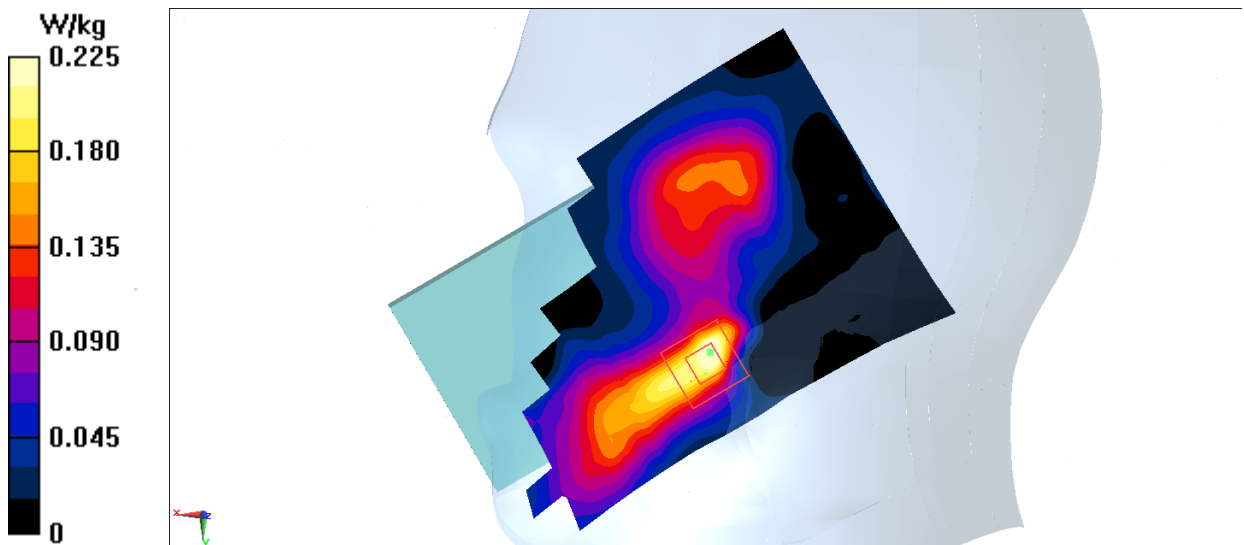

Fig.15 LTE Band7

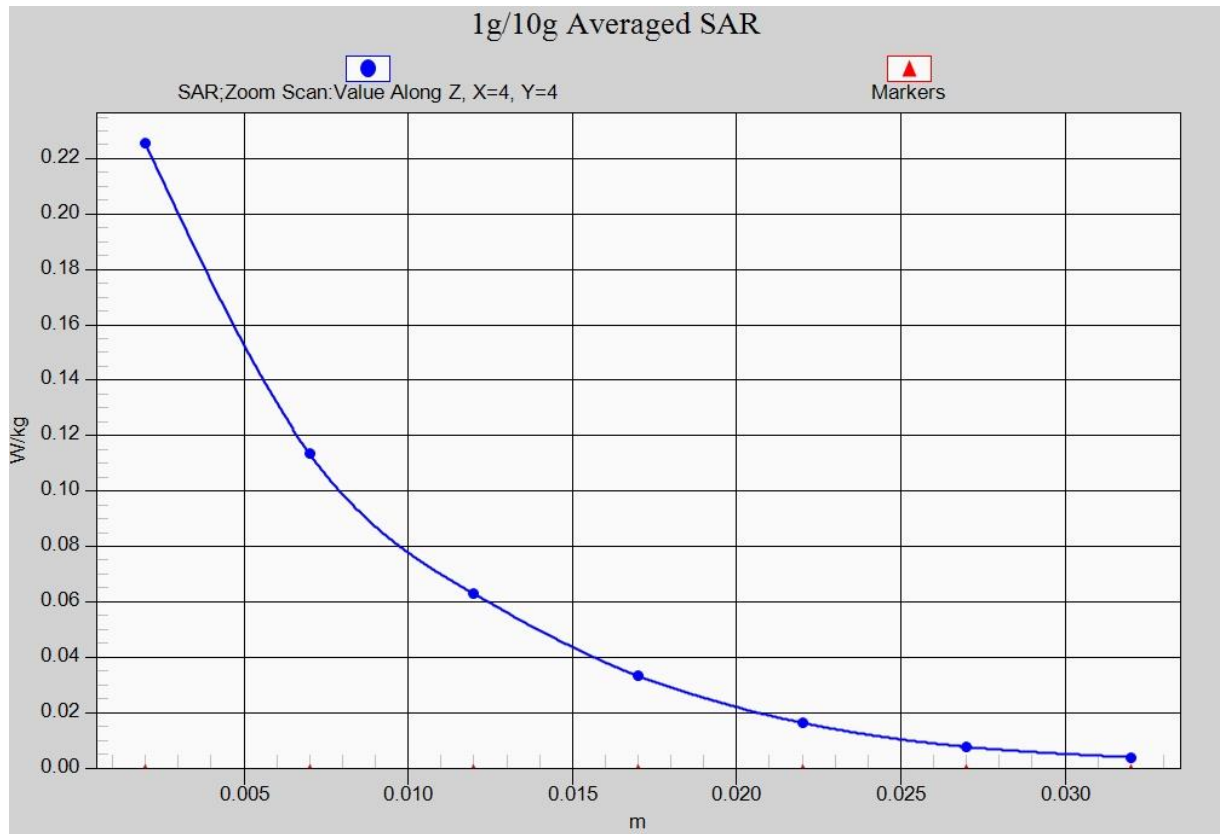

Fig. 15-1 Z-Scan at power reference point (LTE Band7)

LTE Band7 Body Rear Middle with QPSK_20M_1RB_Low

Date: 2019-1-21

Electronics: DAE4 Sn1525

Medium: Body 2600 MHz

Medium parameters used: $f = 2535$ MHz; $\sigma = 2.112$ mho/m; $\epsilon_r = 51.64$; $\rho = 1000$ kg/m³

Ambient Temperature: 22.9°C Liquid Temperature: 22.5°C

Communication System: LTE Band7 Frequency: 2535 MHz Duty Cycle: 1:1

Probe: EX3DV4– SN7514 ConvF(7.06, 7.06, 7.06)

Area Scan (91x161x1): Interpolated grid: dx=1.000 mm, dy=1.000 mm

Maximum value of SAR (interpolated) = 1.22 W/kg

Zoom Scan (7x7x7)/Cube 0: Measurement grid: dx=5mm, dy=5mm, dz=5mm

Reference Value = 4.289 V/m; Power Drift = 0.13 dB

Peak SAR (extrapolated) = 1.69 W/kg

SAR(1 g) = 0.914 W/kg; SAR(10 g) = 0.477 W/kg

Maximum value of SAR (measured) = 1.29 W/kg

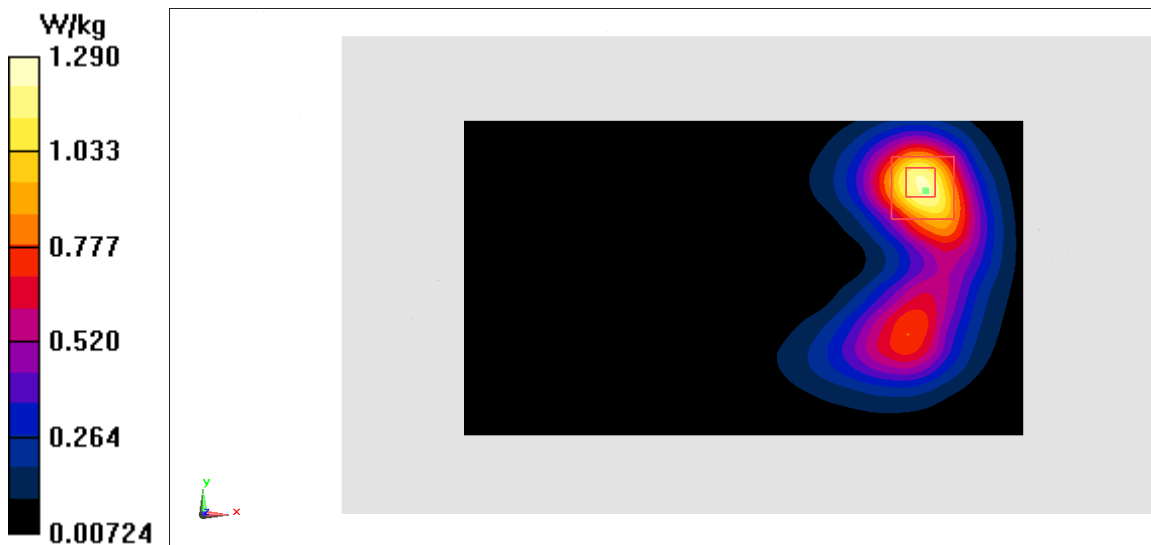

Fig.16 LTE Band7

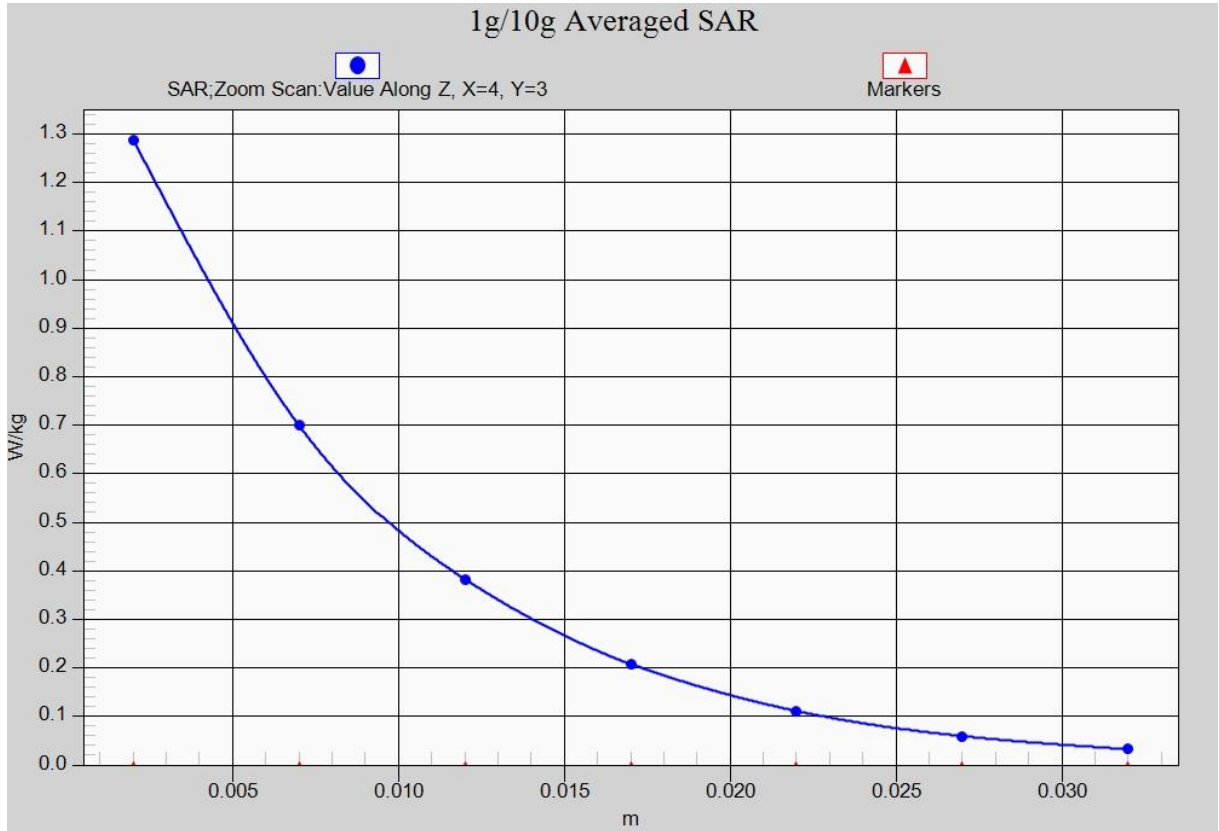

Fig. 16-1 Z-Scan at power reference point (LTE Band7)

LTE Band12 Right Cheek Middle with QPSK_10M_1RB_Middle

Date: 2019-1-18

Electronics: DAE4 Sn1525

Medium: Head 750 MHz

Medium parameters used (interpolated): $f = 707.5$ MHz; $\sigma = 0.871$ mho/m; $\epsilon_r = 42.63$; $\rho = 1000$ kg/m³

Ambient Temperature: 22.9°C Liquid Temperature: 22.5°C

Communication System: LTE Band12 Frequency: 707.5 MHz Duty Cycle: 1:1

Probe: EX3DV4– SN7514 ConvF(9.47, 9.47, 9.47)

Area Scan (71x131x1): Interpolated grid: dx=1.000 mm, dy=1.000 mm

Maximum value of SAR (interpolated) = 0.150 W/kg

Zoom Scan (7x7x7)/Cube 0: Measurement grid: dx=5mm, dy=5mm, dz=5mm

Reference Value = 3.086 V/m; Power Drift = 0.11 dB

Peak SAR (extrapolated) = 0.163 W/kg

SAR(1 g) = 0.130 W/kg; SAR(10 g) = 0.102 W/kg

Maximum value of SAR (measured) = 0.148 W/kg

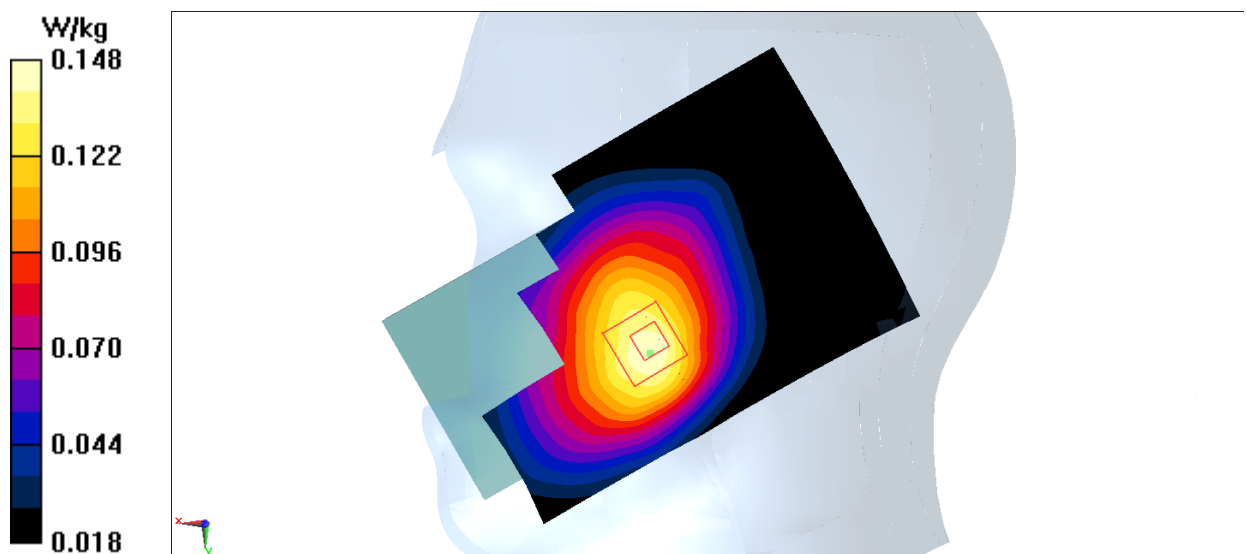

Fig.17 LTE Band12

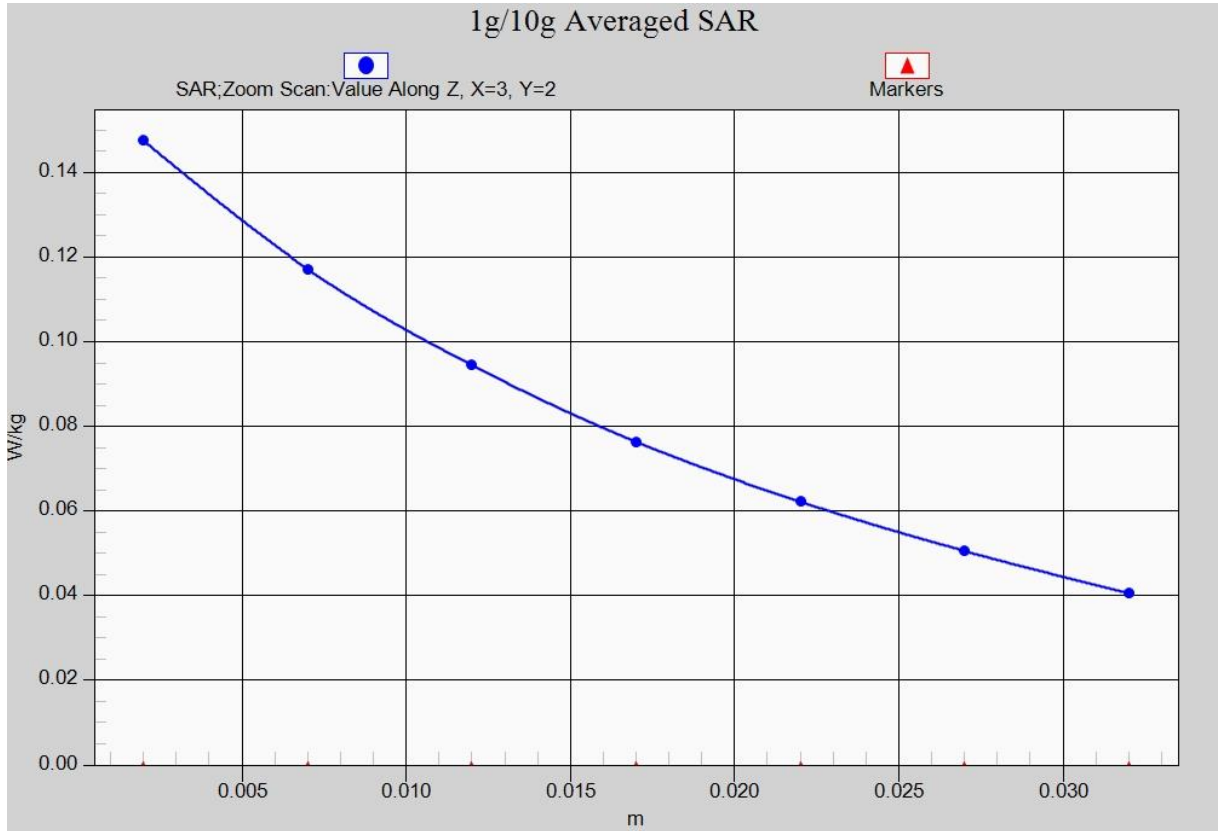

Fig. 17-1 Z-Scan at power reference point (LTE Band12)

LTE Band12 Body Right Edge Middle with QPSK_10M_1RB_Middle

Date: 2019-1-18

Electronics: DAE4 Sn1525

Medium: Body750 MHz

Medium parameters used (interpolated): $f = 707.5$ MHz; $\sigma = 0.976$ mho/m; $\epsilon_r = 55.03$; $\rho = 1000$ kg/m³

Ambient Temperature: 22.9°C Liquid Temperature: 22.5°C

Communication System: LTE Band12 Frequency: 707.5 MHz Duty Cycle: 1:1

Probe: EX3DV4– SN7514 ConvF(9.68, 9.68, 9.68)

Area Scan (31x131x1): Interpolated grid: dx=1.000 mm, dy=1.000 mm

Maximum value of SAR (interpolated) = 0.407 W/kg

Zoom Scan (7x7x7)/Cube 0: Measurement grid: dx=5mm, dy=5mm, dz=5mm

Reference Value = 19.98 V/m; Power Drift = 0.03 dB

Peak SAR (extrapolated) = 0.464 W/kg

SAR(1 g) = 0.333 W/kg; SAR(10 g) = 0.233 W/kg

Maximum value of SAR (measured) = 0.356 W/kg

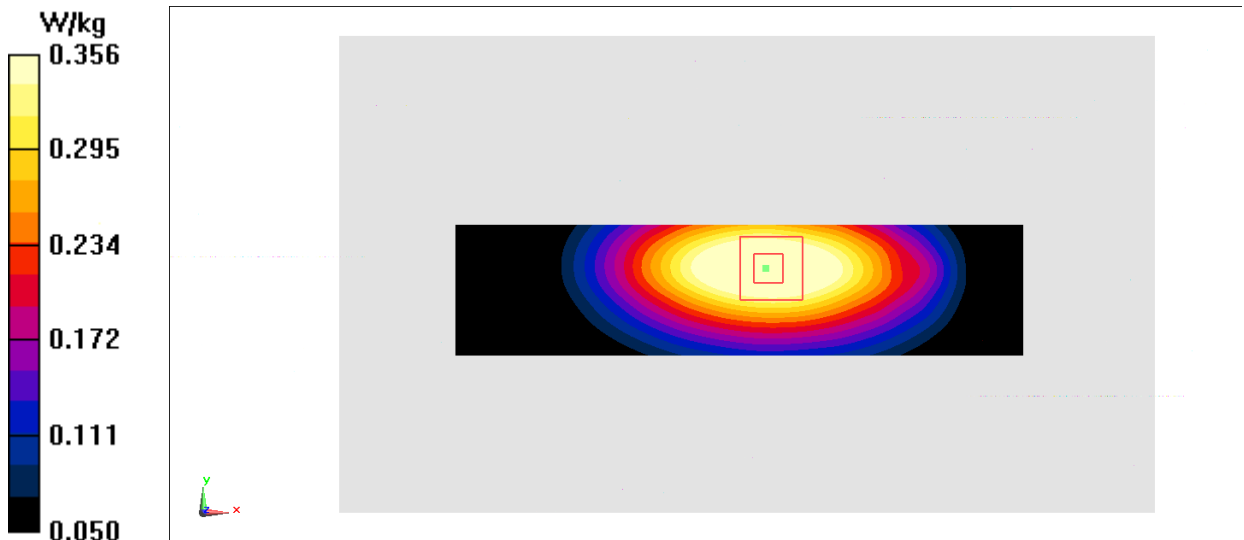

Fig.18 LTE Band12

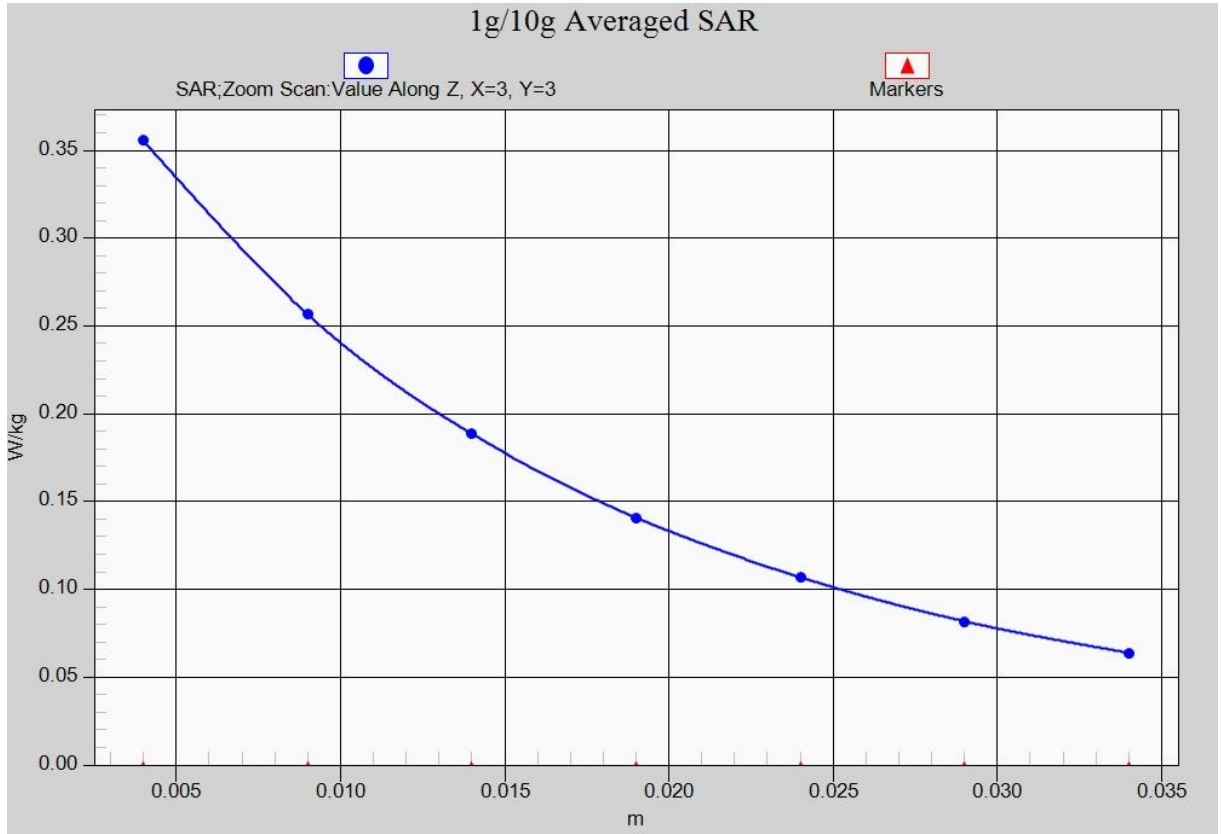

Fig. 18-1 Z-Scan at power reference point (LTE Band12)

LTE Band 38 Right Cheek with QPSK_20M_1RB_Middle

Date: 2019-1-21

Electronics: DAE4 Sn1525

Medium: Head 2600 MHz

Medium parameters used: $f = 2610$ MHz; $\sigma = 1.951$ mho/m; $\epsilon_r = 38.29$; $\rho = 1000$ kg/m³

Ambient Temperature: 22.9°C Liquid Temperature: 22.5°C

Communication System: LTE Band38 Frequency: 2610 MHz Duty Cycle: 1:1.58

Probe: EX3DV4– SN7514 ConvF(6.92, 6.92, 6.92)

Area Scan (91x151x1): Interpolated grid: dx=1.000 mm, dy=1.000 mm

Maximum value of SAR (interpolated) = 0.129 W/kg

Zoom Scan (7x7x7)/Cube 0: Measurement grid: dx=5mm, dy=5mm, dz=5mm

Reference Value = 1.028 V/m; Power Drift = 0.12 dB

Peak SAR (extrapolated) = 0.150 W/kg

SAR(1 g) = 0.075 W/kg; SAR(10 g) = 0.036 W/kg

Maximum value of SAR (measured) = 0.114 W/kg

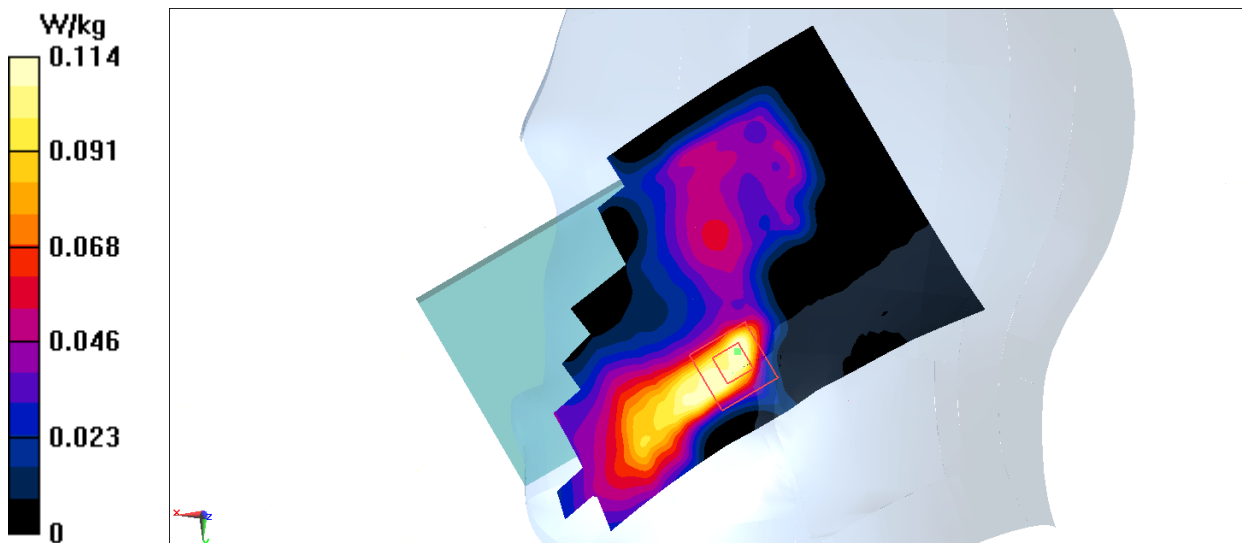

Fig.19 LTE Band 38

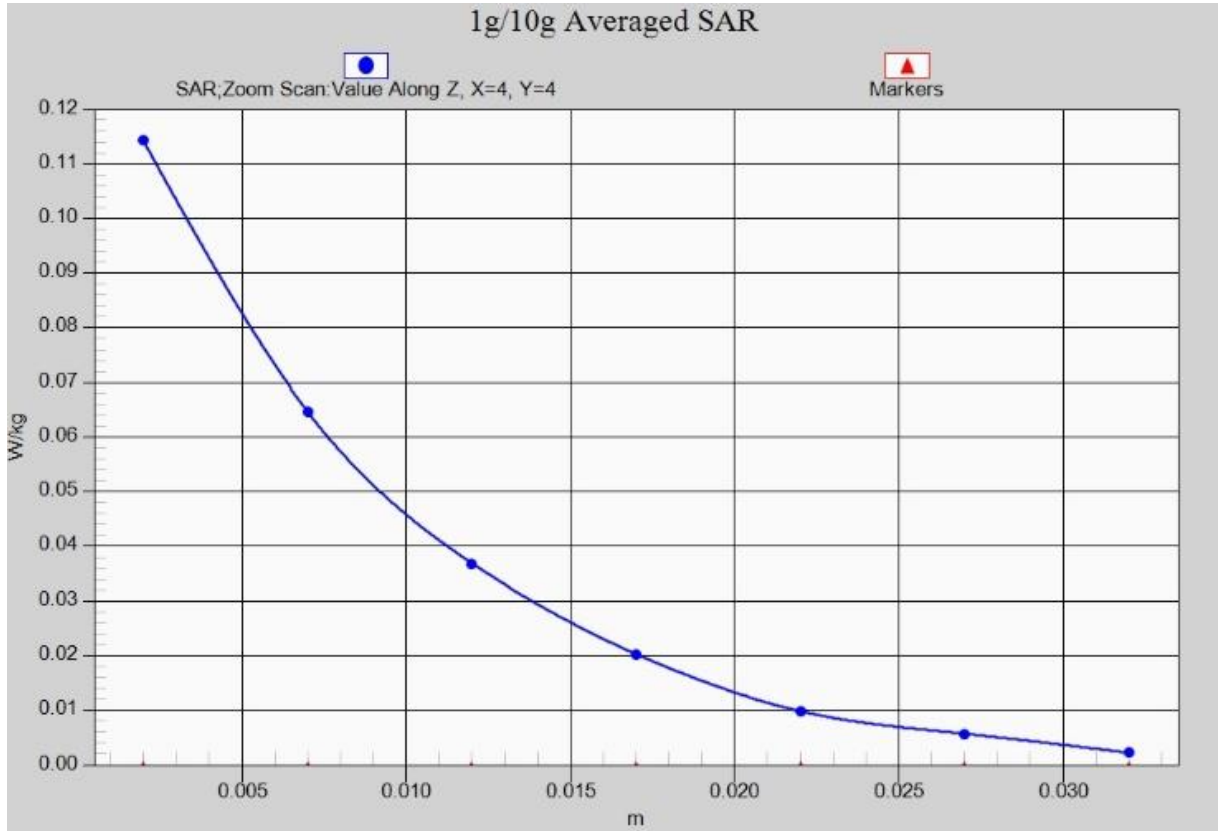

Fig. 19-1 Z-Scan at power reference point (LTE Band 38)

LTE Band 38 Body Rear with QPSK_20M_1RB_Middle

Date: 2019-1-21

Electronics: DAE4 Sn1525

Medium: Body 2600 MHz

Medium parameters used: $f = 2610$ MHz; $\sigma = 2.161$ mho/m; $\epsilon_r = 51.554$; $\rho = 1000$ kg/m³

Ambient Temperature: 22.9°C Liquid Temperature: 22.5°C

Communication System: LTE Band38 Frequency: 2610 MHz Duty Cycle: 1:1.58

Probe: EX3DV4– SN7514 ConvF(7.06, 7.06, 7.06)

Area Scan (91x161x1): Interpolated grid: $dx=1.000$ mm, $dy=1.000$ mm

Maximum value of SAR (interpolated) = 0.901 W/kg

Zoom Scan (7x7x7)/Cube 0: Measurement grid: $dx=5$ mm, $dy=5$ mm, $dz=5$ mm

Reference Value = 3.167 V/m; Power Drift = -0.03 dB

Peak SAR (extrapolated) = 1.27 W/kg

SAR(1 g) = 0.672 W/kg; SAR(10 g) = 0.350 W/kg

Maximum value of SAR (measured) = 0.966 W/kg

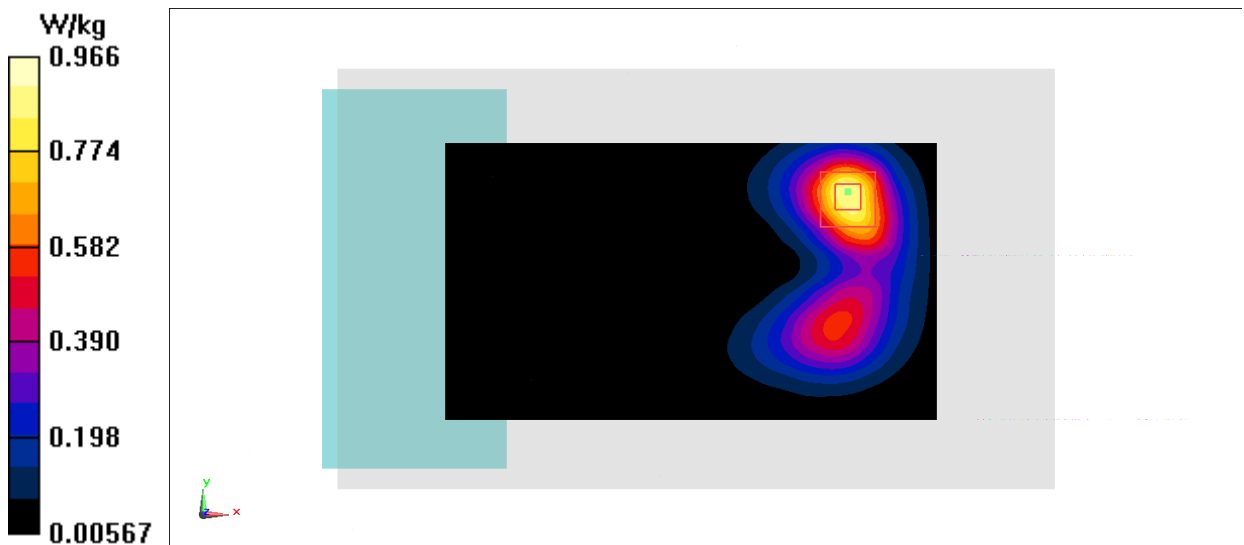

Fig.20 LTE Band 38

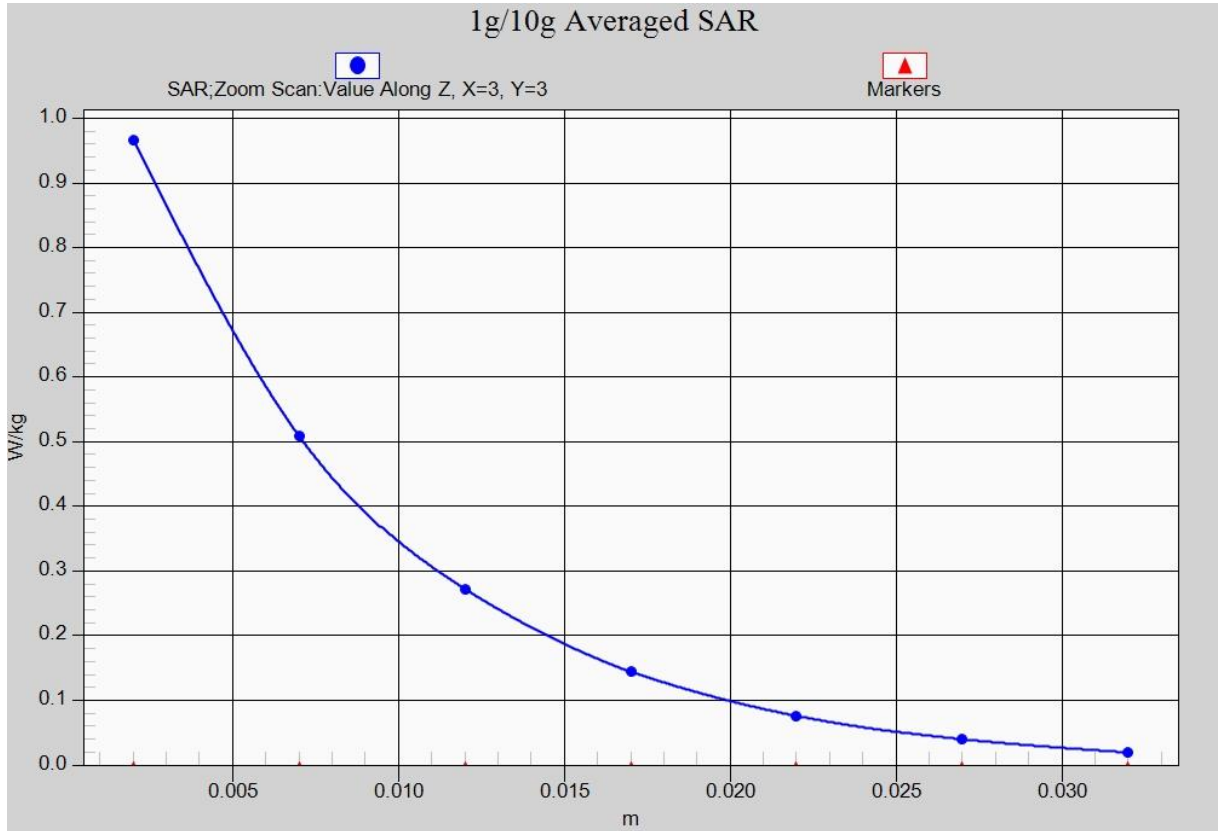

Fig. 20-1 Z-Scan at power reference point (LTE Band 38)

LTE Band66 Left Cheek Middle with QPSK_20M_1RB_Middle

Date: 2019-1-18

Electronics: DAE4 Sn1525

Medium: Head 1750 MHz

Medium parameters used $f = 1745$ MHz; $\sigma = 1.4$ mho/m; $\epsilon_r = 40.495$; $\rho = 1000$ kg/m³

Ambient Temperature: 22.9°C Liquid Temperature: 22.5°C

Communication System: LTE Band66 Frequency: 1745 MHz Duty Cycle: 1:1

Probe: EX3DV4 – SN7514 ConvF(8.10, 8.10, 8.10)

Area Scan (71x131x1): Interpolated grid: dx=1.000 mm, dy=1.000 mm

Maximum value of SAR (interpolated) = 0.0876 W/kg

Zoom Scan (7x7x7)/Cube 0: Measurement grid: dx=5mm, dy=5mm, dz=5mm

Reference Value = 3.303 V/m; Power Drift = 0.16 dB

Peak SAR (extrapolated) = 0.131 W/kg

SAR(1 g) = 0.077 W/kg; SAR(10 g) = 0.045 W/kg

Maximum value of SAR (measured) = 0.105 W/kg

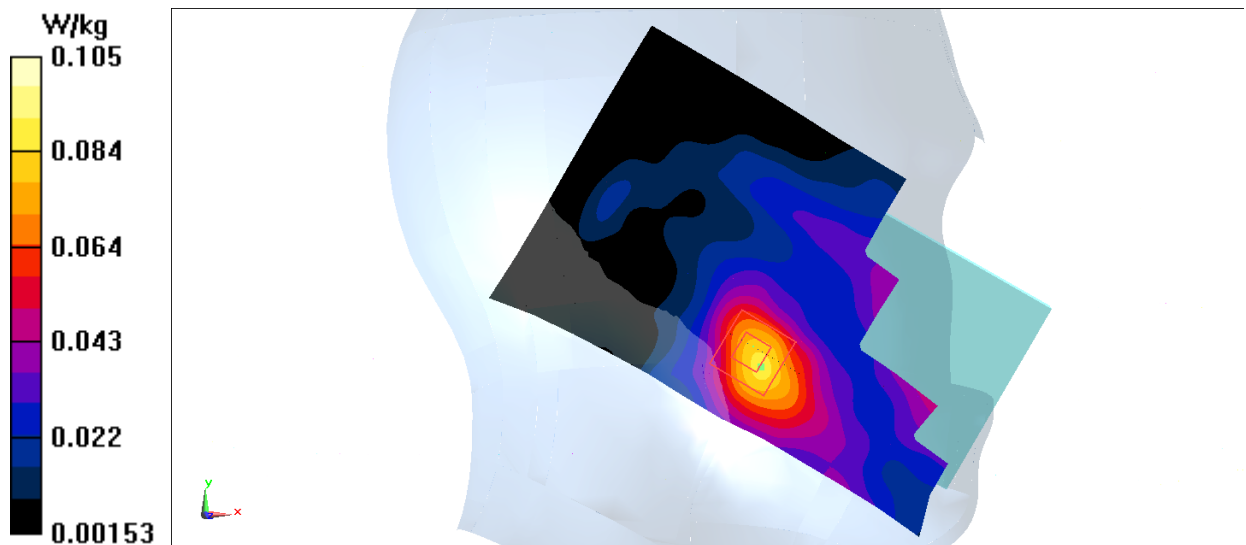

Fig.21 LTE Band66

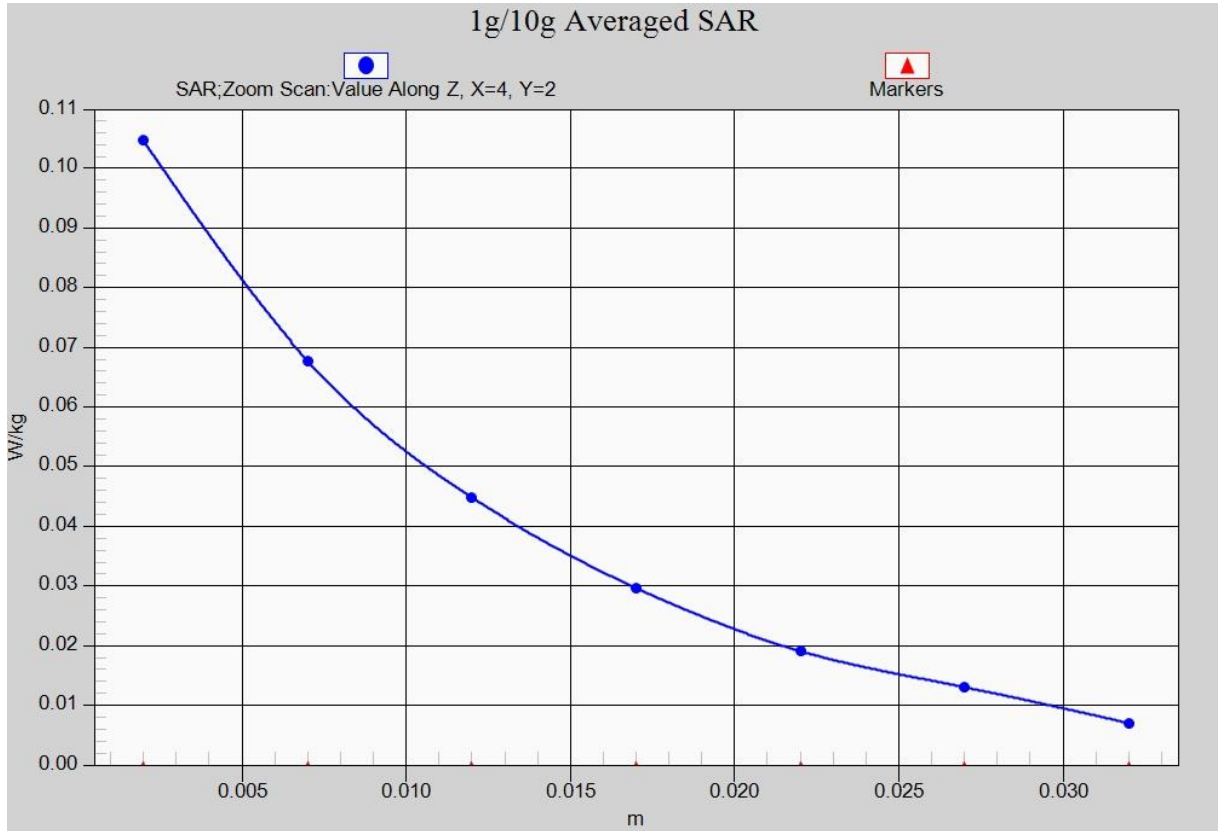

Fig. 21-1 Z-Scan at power reference point (LTE Band66)

LTE Band66 Body Bottom High with QPSK_20M_1RB_Middle

Date: 2019-1-18

Electronics: DAE4 Sn1525

Medium: Body 1750 MHz

Medium parameters used: $f = 1770$ MHz; $\sigma = 1.507$ mho/m; $\epsilon_r = 54.224$; $\rho = 1000$ kg/m³

Ambient Temperature: 22.9°C Liquid Temperature: 22.5°C

Communication System: LTE Band66 Frequency: 1770 MHz Duty Cycle: 1:1

Probe: EX3DV4 – SN7514 ConvF(7.82, 7.82, 7.82)

Area Scan (41x81x1): Interpolated grid: dx=1.000 mm, dy=1.000 mm

Maximum value of SAR (interpolated) = 1.20 W/kg

Zoom Scan (7x7x7)/Cube 0: Measurement grid: dx=5mm, dy=5mm, dz=5mm

Reference Value = 24.59 V/m; Power Drift = -0.07 dB

Peak SAR (extrapolated) = 1.41 W/kg

SAR(1 g) = 0.828 W/kg; SAR(10 g) = 0.453 W/kg

Maximum value of SAR (measured) = 1.14 W/kg

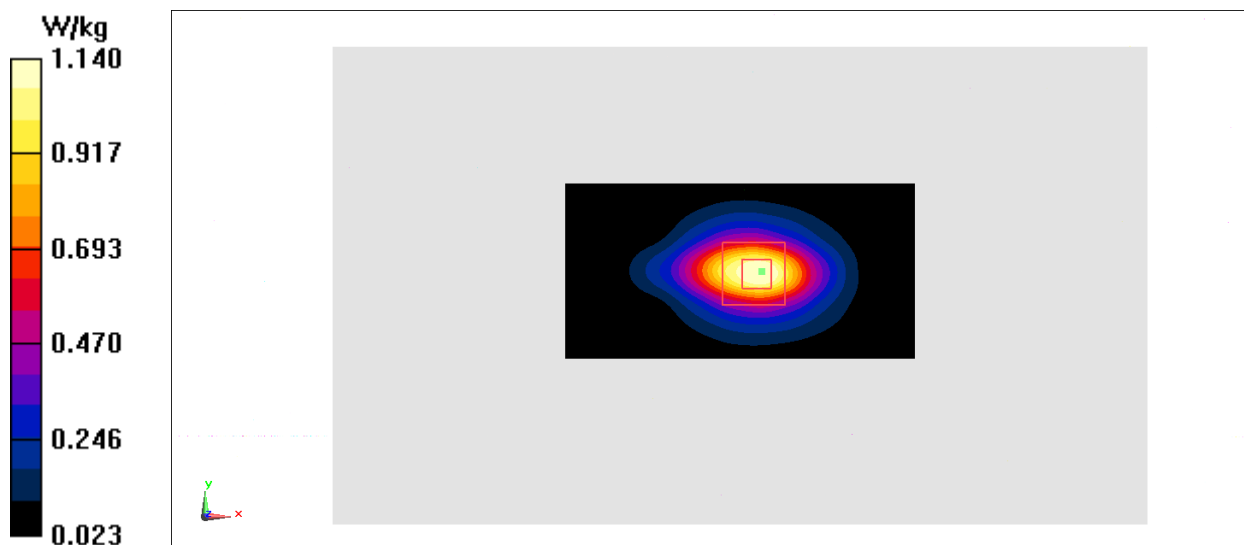

Fig.22 LTE Band66

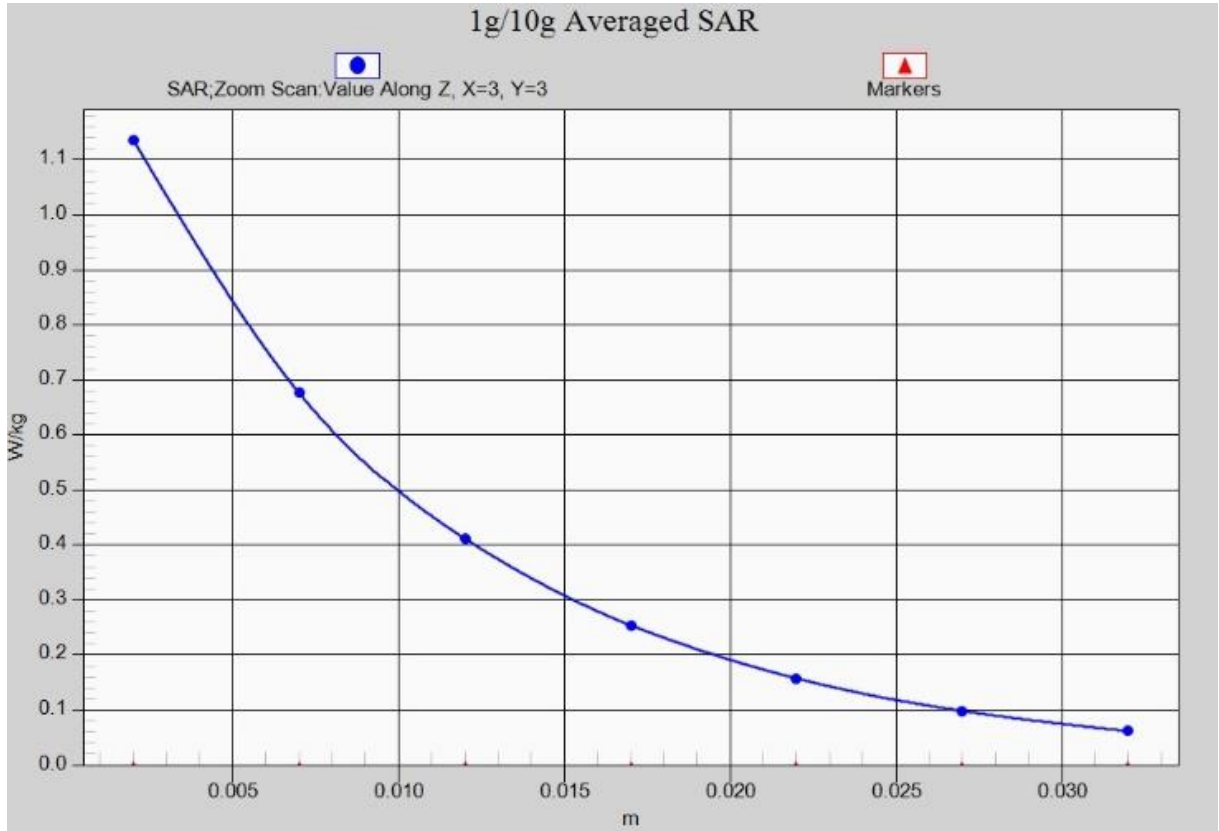

Fig. 22-1 Z-Scan at power reference point (LTE Band66)

Wifi 802.11b Left Cheek Channel 6

Date: 2019-1-20

Electronics: DAE4 Sn1525

Medium: Head 2450 MHz

Medium parameters used (interpolated): $f = 2437$ MHz; $\sigma = 1.793$ mho/m; $\epsilon_r = 39.22$; $\rho = 1000$ kg/m³

Ambient Temperature: 22.9°C Liquid Temperature: 22.5°C

Communication System: WLAN 2450 Frequency: 2437 MHz Duty Cycle: 1:1

Probe: EX3DV4- SN7514 ConvF(6.95, 6.95, 6.95)

Area Scan (91x161x1): Interpolated grid: dx=1.000 mm, dy=1.000 mm

Maximum value of SAR (interpolated) = 0.355 W/kg

Zoom Scan (7x7x7)/Cube 0: Measurement grid: dx=5mm, dy=5mm, dz=5mm

Reference Value = 6.510 V/m; Power Drift = 0.03 dB

Peak SAR (extrapolated) = 0.542 W/kg

SAR(1 g) = 0.205 W/kg; SAR(10 g) = 0.095 W/kg

Maximum value of SAR (measured) = 0.378 W/kg

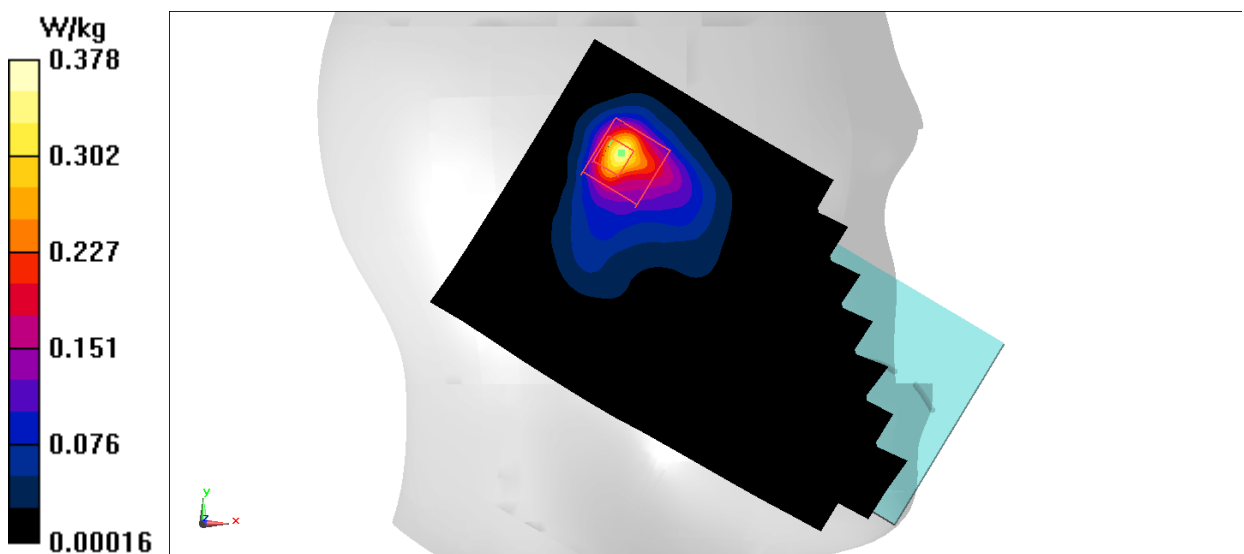

Fig.23 2450 MHz

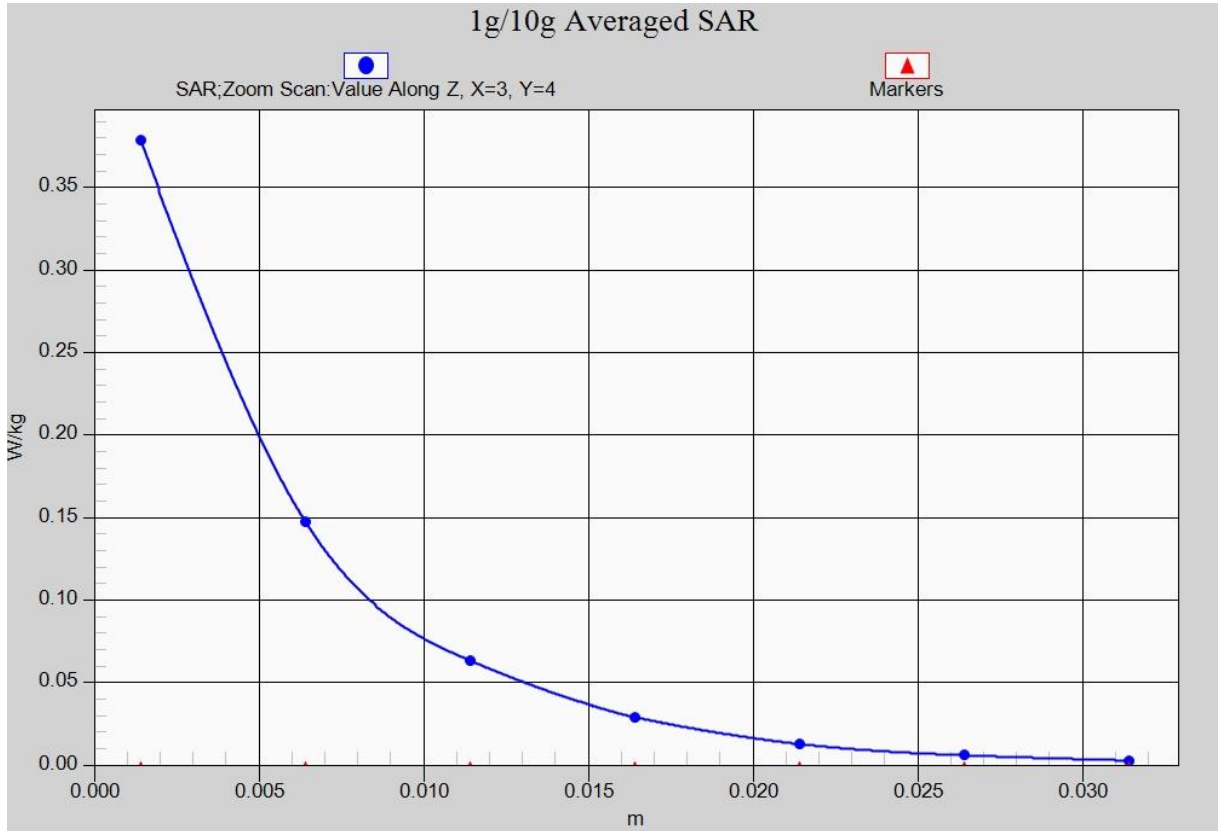

Fig. 23-1 Z-Scan at power reference point (2450 MHz)

Wifi 802.11b Body Rear Channel 6

Date: 2019-1-20

Electronics: DAE4 Sn1525

Medium: Body 2450 MHz

Medium parameters used (interpolated): $f = 2437$ MHz; $\sigma = 1.95$ mho/m; $\epsilon_r = 52.02$; $\rho = 1000$ kg/m³

Ambient Temperature: 22.9°C Liquid Temperature: 22.5°C

Communication System: WLAN 2450 Frequency: 2437 MHz Duty Cycle: 1:1

Probe: EX3DV4 – SN7514 ConvF(7.13, 7.13, 7.13)

Area Scan (161x91x1): Interpolated grid: dx=1.000 mm, dy=1.000 mm

Maximum value of SAR (interpolated) = 0.112 W/kg

Zoom Scan (7x7x7)/Cube 0: Measurement grid: dx=5mm, dy=5mm, dz=5mm

Reference Value = 1.669 V/m; Power Drift = -0.03 dB

Peak SAR (extrapolated) = 0.240 W/kg

SAR(1 g) = 0.077 W/kg; SAR(10 g) = 0.029 W/kg

Maximum value of SAR (measured) = 0.115 W/kg

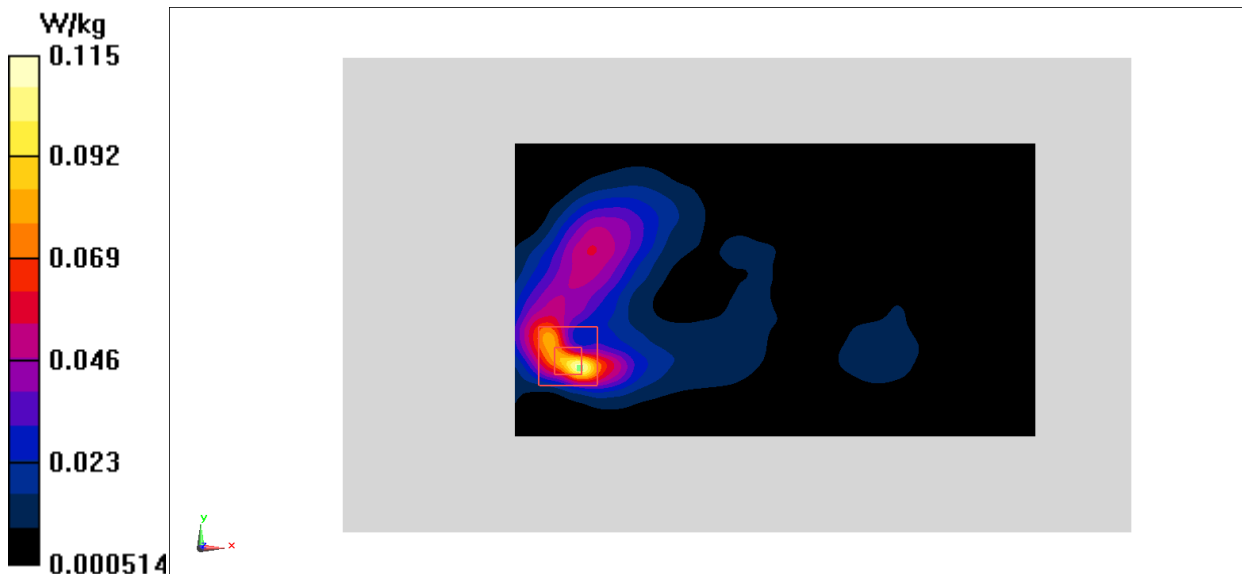

Fig.24 2450 MHz

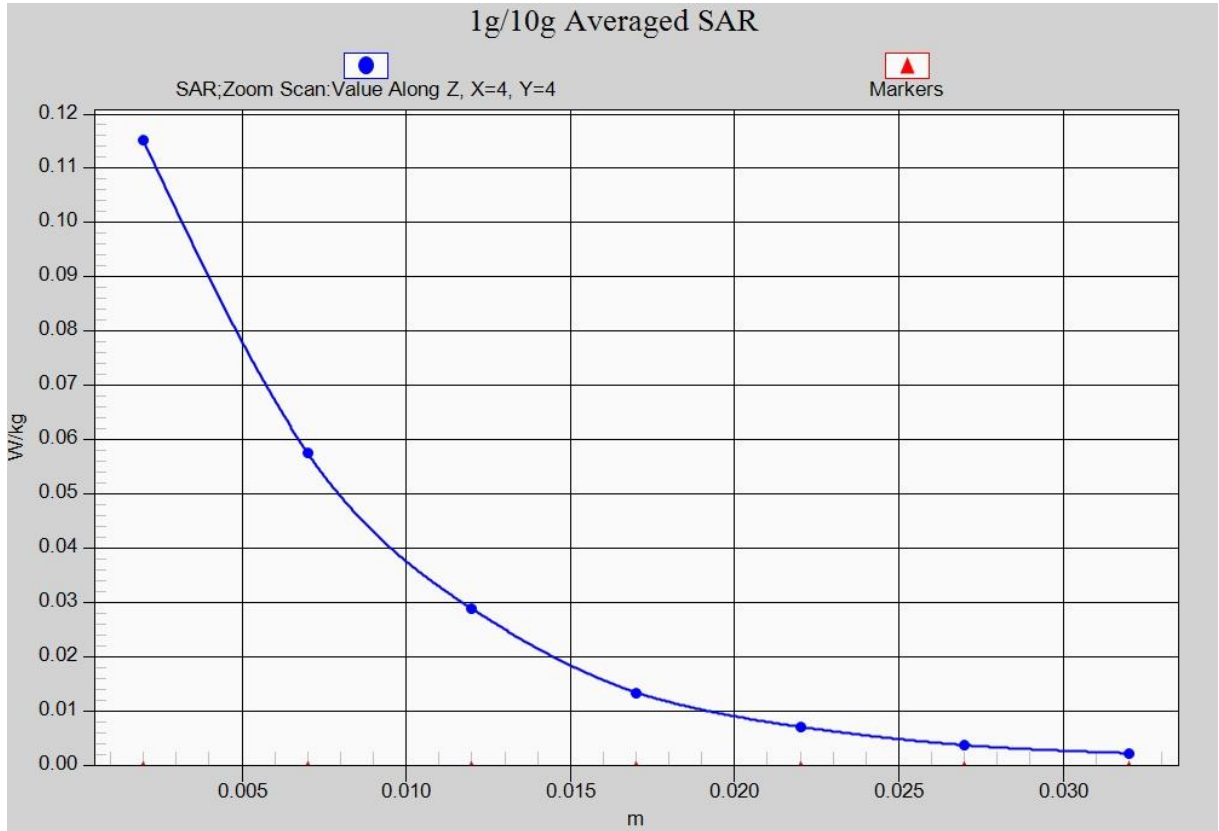

Fig. 24-1 Z-Scan at power reference point (2450 MHz)

ANNEX B System Verification Results

750MHz

Date: 2019-1-16

Electronics: DAE4 Sn1525

Medium: Head 750 MHz

Medium parameters used: $f = 750$ MHz; $\sigma = 0.886$ mho/m; $\epsilon_r = 42.51$; $\rho = 1000$ kg/m³

Ambient Temperature: 22.9°C Liquid Temperature: 22.5°C

Communication System: CW Frequency: 750 MHz Duty Cycle: 1:1

Probe: EX3DV4- SN7514 ConvF(9.47, 9.47, 9.47)

System Validation /Area Scan (81x191x1): Interpolated grid: dx=1.000 mm, dy=1.000 mm

Reference Value = 50.662 V/m; Power Drift = -0.04 dB

Fast SAR: SAR(1 g) = 2.14 W/kg; SAR(10 g) = 1.39 W/kg

Maximum value of SAR (interpolated) = 2.30 W/kg

System Validation /Zoom Scan (7x7x7)/Cube 0: Measurement grid: dx=5mm, dy=5mm, dz=5mm

Reference Value = 50.662 V/m; Power Drift = -0.04 dB

Peak SAR (extrapolated) = 2.97 W/kg

SAR(1 g) = 2.11 W/kg; SAR(10 g) = 1.37 W/kg

Maximum value of SAR (measured) = 2.27 W/kg

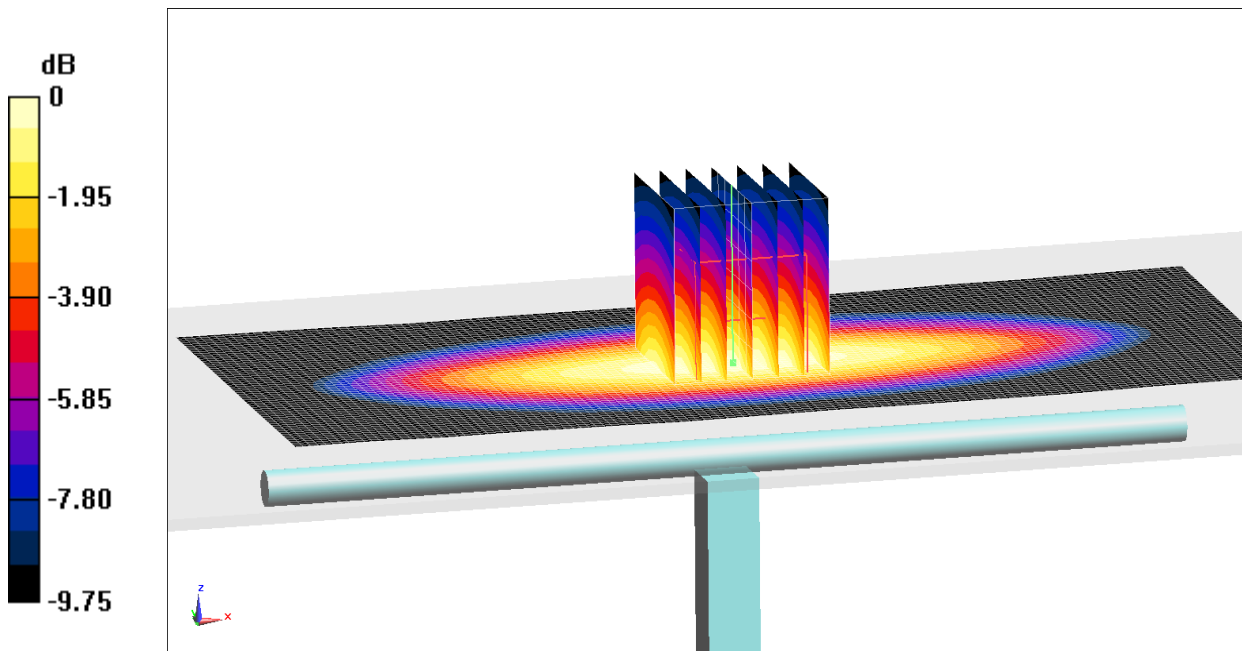

0 dB = 2.27 W/kg = 3.56 dB W/kg

Fig.B.1 validation 750MHz 250mW

750MHz

Date: 2019-1-16

Electronics: DAE4 Sn1525

Medium: Body750 MHz

Medium parameters used: $f = 750 \text{ MHz}$; $\sigma = 0.988 \text{ mho/m}$; $\epsilon_r = 54.98$; $\rho = 1000 \text{ kg/m}^3$

Ambient Temperature: 22.9°C Liquid Temperature: 22.5°C

Communication System: CW Frequency: 750 MHz Duty Cycle: 1:1

Probe: EX3DV4– SN7514 ConvF(9.68, 9.68, 9.68)

System Validation/Area Scan (81x191x1): Interpolated grid: $dx=1.000 \text{ mm}$, $dy=1.000 \text{ mm}$

Reference Value = 50.936 V/m ; Power Drift = 0.09 dB

Fast SAR: SAR(1 g) = 2.26 W/kg ; SAR(10 g) = 1.47 W/kg

Maximum value of SAR (interpolated) = 2.32 W/kg

System Validation/Zoom Scan (7x7x7)/Cube 0: Measurement grid: $dx=5\text{mm}$, $dy=5\text{mm}$, $dz=5\text{mm}$

Reference Value = 50.936 V/m ; Power Drift = 0.09 dB

Peak SAR (extrapolated) = 2.98 W/kg

SAR(1 g) = 2.21 W/kg ; SAR(10 g) = 1.45 W/kg

Maximum value of SAR (measured) = 2.30 W/kg

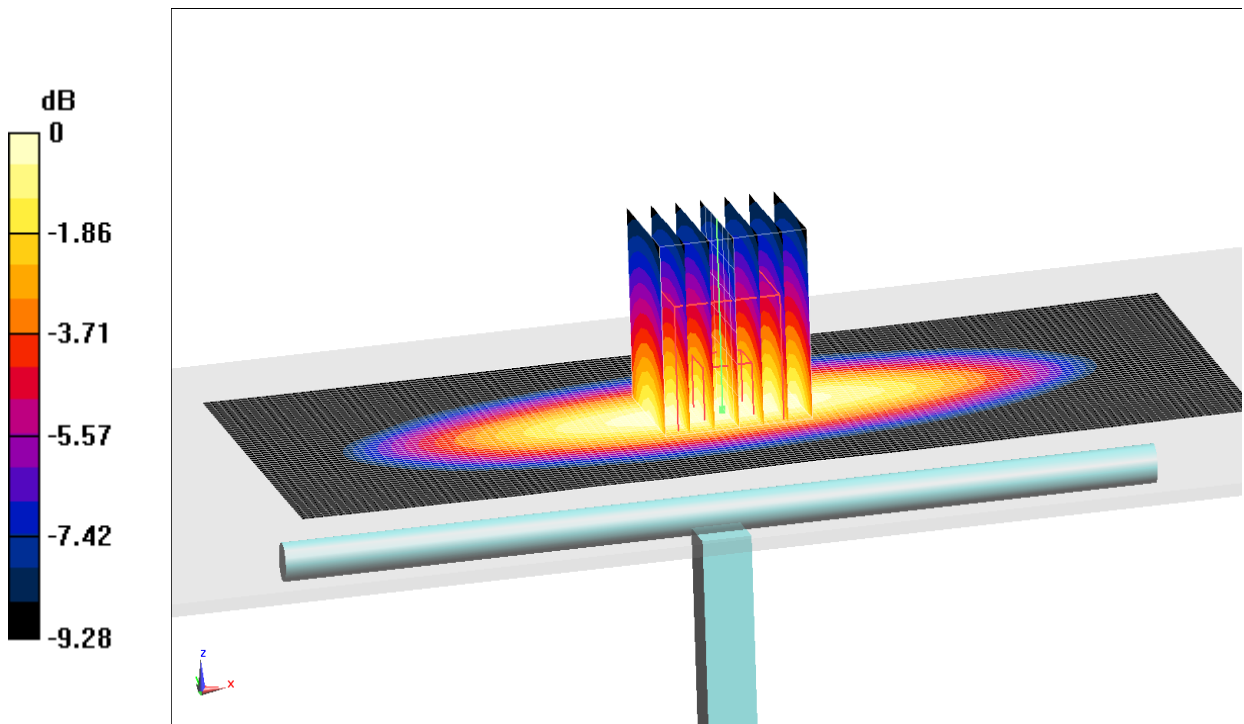

0 dB = $2.30 \text{ W/kg} = 3.62 \text{ dB W/kg}$

Fig.B.2 validation 750MHz 250mW

835MHz

Date: 2019-1-17

Electronics: DAE4 Sn1525

Medium: Head 850 MHz

Medium parameters used: $f = 835 \text{ MHz}$; $\sigma = 0.877 \text{ S/m}$; $\epsilon_r = 41.8$; $\rho = 1000 \text{ kg/m}^3$

Ambient Temperature: 22.9°C Liquid Temperature: 22.5°C

Communication System: CW Frequency: 835 MHz Duty Cycle: 1:1

Probe: EX3DV4 – SN7514 ConvF(9.09, 9.09, 9.09)

System Validation /Area Scan (81x161x1): Interpolated grid: $dx=1.000 \text{ mm}$, $dy=1.000 \text{ mm}$

Reference Value = 51.264 V/m ; Power Drift = 0.08 dB

Fast SAR: SAR(1 g) = 2.26 W/kg ; SAR(10 g) = 1.45 W/kg

Maximum value of SAR (interpolated) = 2.50 W/kg

System Validation /Zoom Scan (7x7x7)/Cube 0: Measurement grid: $dx=5\text{mm}$, $dy=5\text{mm}$, $dz=5\text{mm}$

Reference Value = 51.264 V/m ; Power Drift = 0.08 dB

Peak SAR (extrapolated) = 3.58 W/kg

SAR(1 g) = 2.3 W/kg ; SAR(10 g) = 1.48 W/kg

Maximum value of SAR (measured) = 2.53 W/kg

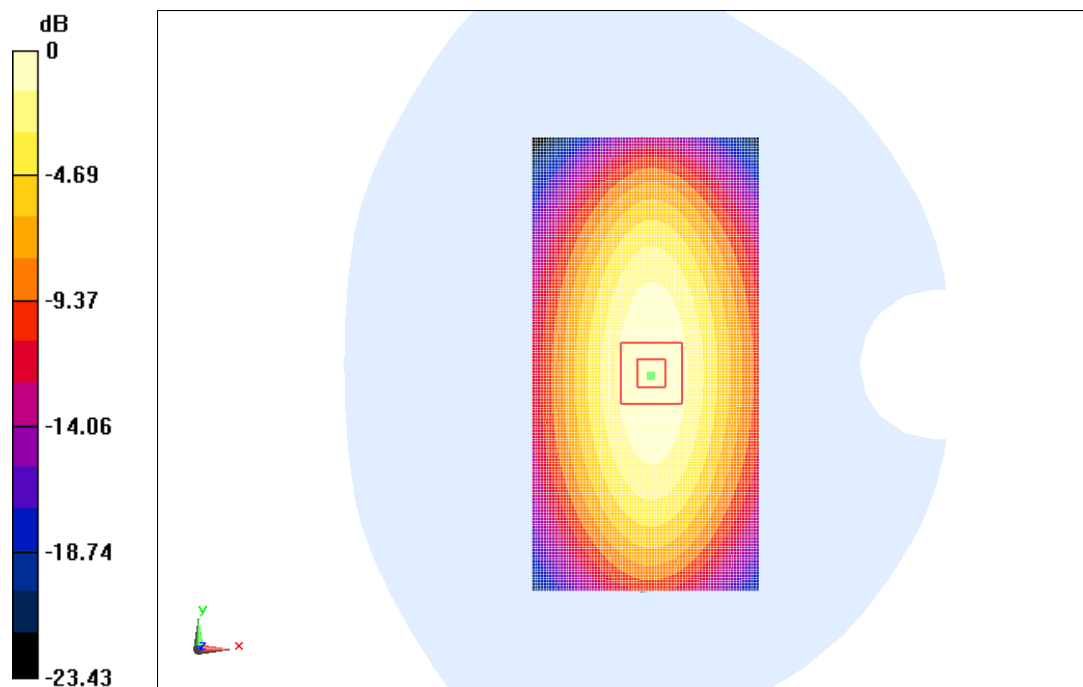

$0 \text{ dB} = 2.53 \text{ W/kg} = 4.03\text{dBW/kg}$

Fig.B.3 validation 835MHz 250mW

835MHz

Date: 2019-1-17

Electronics: DAE4 Sn1525

Medium: Body 850 MHz

Medium parameters used: $f = 835 \text{ MHz}$; $\sigma = 0.966 \text{ S/m}$; $\epsilon_r = 55.06$; $\rho = 1000 \text{ kg/m}^3$

Ambient Temperature: 22.9°C Liquid Temperature: 22.5°C

Communication System: CW Frequency: 835 MHz Duty Cycle: 1:1

Probe: EX3DV4 – SN7514 ConvF(9.47, 9.47, 9.47)

System Validation /Area Scan (81x171x1): Interpolated grid: $dx=1.000 \text{ mm}$, $dy=1.000 \text{ mm}$

Reference Value = 51.433 V/m ; Power Drift = 0.05 dB

Fast SAR: SAR(1 g) = 2.33 W/kg ; SAR(10 g) = 1.52 W/kg

Maximum value of SAR (interpolated) = 2.51 W/kg

System Validation /Zoom Scan (7x7x7)/Cube 0: Measurement grid: $dx=5\text{mm}$, $dy=5\text{mm}$, $dz=5\text{mm}$

Reference Value = 51.433 V/m ; Power Drift = 0.05 dB

Peak SAR (extrapolated) = 3.52 W/kg

SAR(1 g) = 2.38 W/kg ; SAR(10 g) = 1.54 W/kg

Maximum value of SAR (measured) = 2.54 W/kg

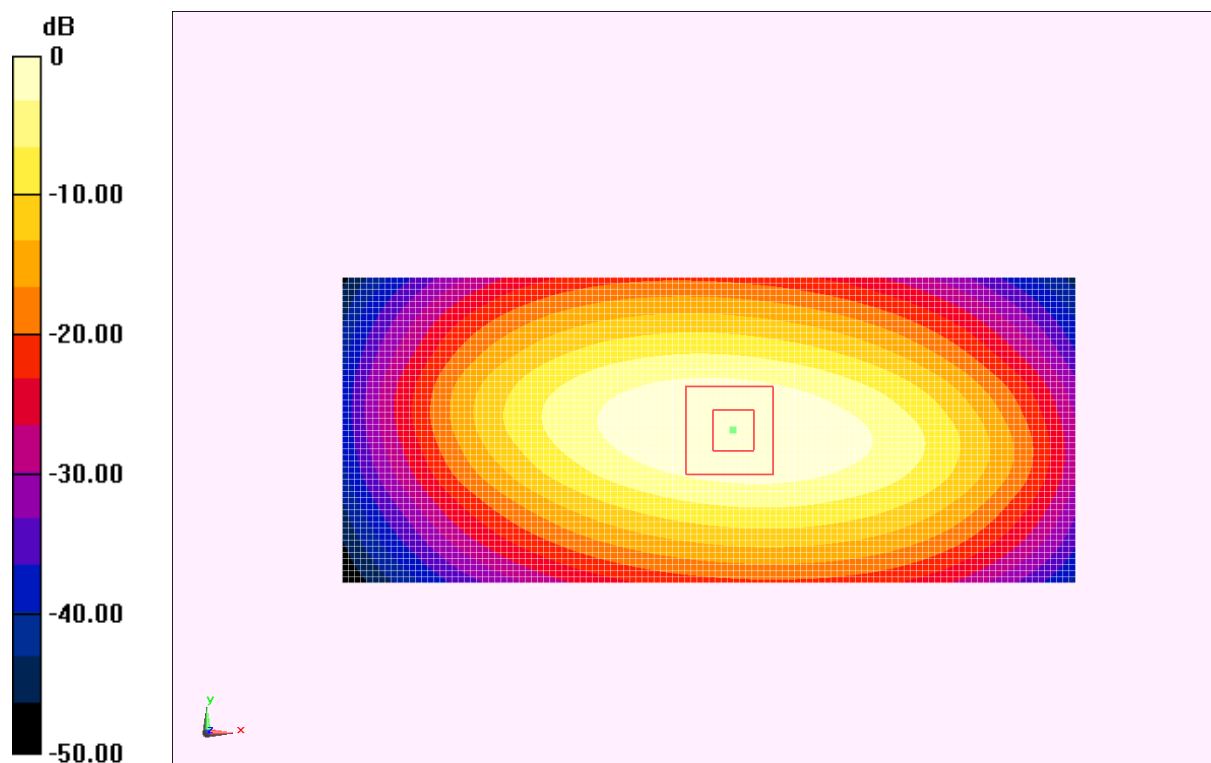

0 dB = 2.54 W/kg = 4.05 dBW/kg

Fig.B.4 validation 835MHz 250mW

1750MHz

Date: 2019-1-18

Electronics: DAE4 Sn1525

Medium: Head 1750 MHz

Medium parameters used: $f=1750$ MHz; $\sigma = 1.407$ mho/m; $\epsilon_r = 40.49$; $\rho = 1000$ kg/m³

Ambient Temperature: 22.9°C Liquid Temperature: 22.5°C

Communication System: CW Frequency: 1750 MHz Duty Cycle: 1:1

Probe: EX3DV4 - SN7514 ConvF(8.10, 8.10, 8.10)

System Validation/Area Scan (81x121x1): Interpolated grid: dx=1.000 mm, dy=1.000 mm

Reference Value = 92.325 V/m; Power Drift = -0.05 dB

Fast SAR: SAR(1 g) = 8.99 W/kg; SAR(10 g) = 4.80 W/kg

Maximum value of SAR (interpolated) = 10.05 W/kg

System Validation/Zoom Scan (7x7x7)/Cube 0: Measurement grid: dx=5mm, dy=5mm, dz=5mm

Reference Value = 92.325 V/m; Power Drift = -0.05 dB

Peak SAR (extrapolated) = 15.64 W/kg

SAR(1 g) = 9.15 W/kg; SAR(10 g) = 4.84 W/kg

Maximum value of SAR (measured) = 10.15 W/kg

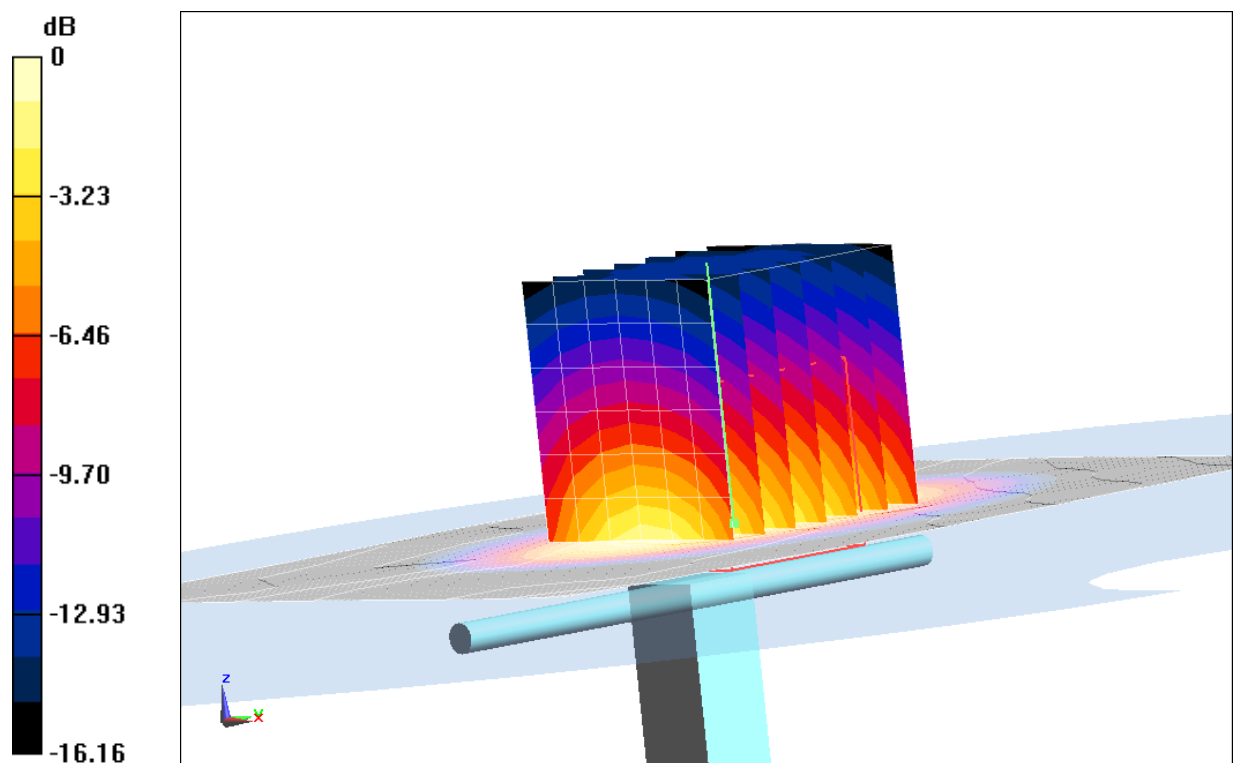

0 dB = 10.15 W/kg = 10.06 dB W/kg

Fig.B.5 validation 1750MHz 250mW

1750MHz

Date: 2019-1-18

Electronics: DAE4 Sn1525

Medium: Body 1750 MHz

Medium parameters used: $f=1750$ MHz; $\sigma = 1.473$ mho/m; $\epsilon_r = 54.4$; $\rho = 1000$ kg/m³

Ambient Temperature: 22.9°C Liquid Temperature: 22.5°C

Communication System: CW Frequency: 1750 MHz Duty Cycle: 1:1

Probe: EX3DV4 – SN7514 ConvF(7.82, 7.82, 7.82)

System Validation/Area Scan (81x121x1): Interpolated grid: dx=1.000 mm, dy=1.000 mm

Reference Value = 95.223 V/m; Power Drift = -0.03 dB

Fast SAR: SAR(1 g) = 9.35 W/kg; SAR(10 g) = 5.02 W/kg

Maximum value of SAR (interpolated) = 10.14 W/kg

System Validation/Zoom Scan (7x7x7)/Cube 0: Measurement grid: dx=5mm, dy=5mm, dz=5mm

Reference Value = 95.223 V/m; Power Drift = -0.03 dB

Peak SAR (extrapolated) = 16.19 W/kg

SAR(1 g) = 9.14 W/kg; SAR(10 g) = 4.99 W/kg

Maximum value of SAR (measured) = 10.11 W/kg

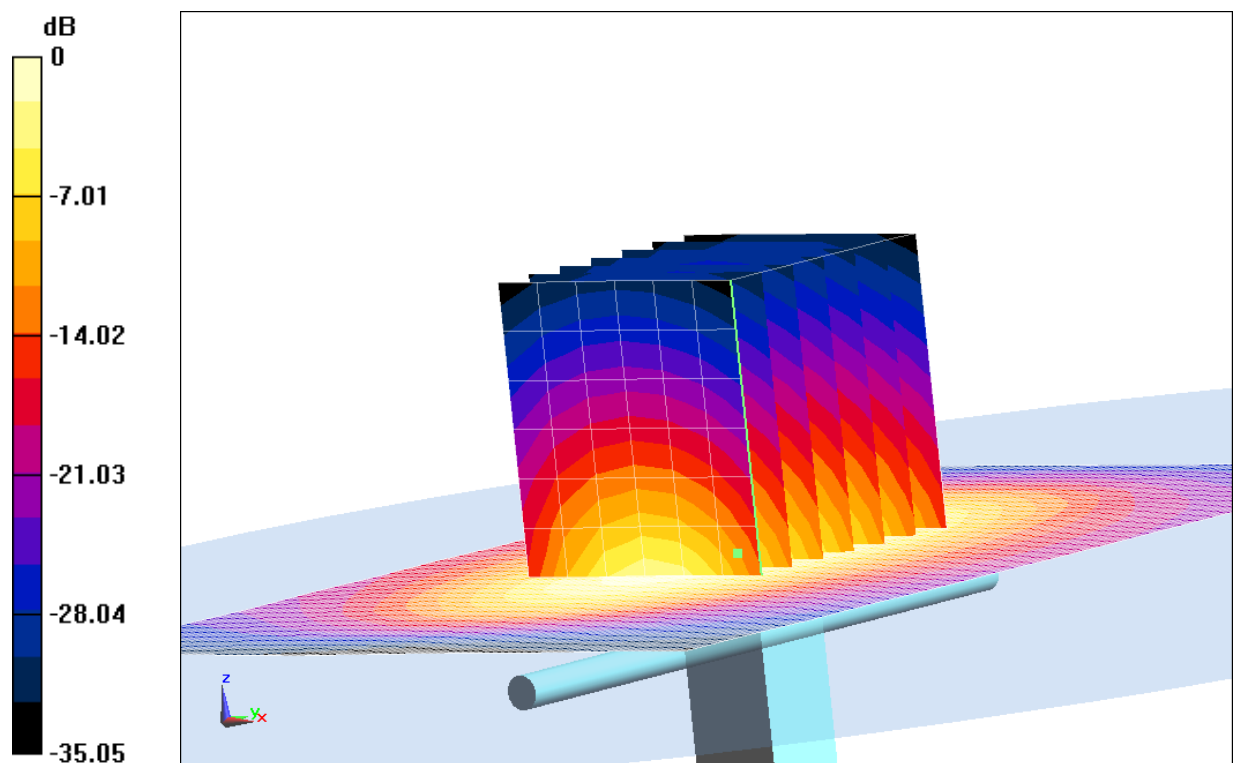

0 dB = 10.11 W/kg = 10.05 dB W/kg

Fig.B.6 validation 1750MHz 250mW

1900MHz

Date: 2019-1-19

Electronics: DAE4 Sn1525

Medium: Head 1900 MHz

Medium parameters used: $f = 1900$ MHz; $\sigma = 1.388$ S/m; $\epsilon_r = 40.5$; $\rho = 1000$ kg/m³

Ambient Temperature: 22.9°C Liquid Temperature: 22.5°C

Communication System: CW Frequency: 1900 MHz Duty Cycle: 1:1

Probe: EX3DV4 - SN7514 ConvF(7.73, 7.73, 7.73)

System Validation /Area Scan (81x121x1): Interpolated grid: dx=1.000 mm, dy=1.000 mm

Reference Value = 93.622 V/m; Power Drift = 0.05 dB

Fast SAR: SAR(1 g) = 10.6 W/kg; SAR(10 g) = 5.60 W/kg

Maximum value of SAR (interpolated) = 11.96 W/kg

System Validation /Zoom Scan (7x7x7)/Cube 0: Measurement grid: dx=5mm, dy=5mm, dz=5mm

Reference Value = 93.622 V/m; Power Drift = 0.05 dB

Peak SAR (extrapolated) = 18.89 W/kg

SAR(1 g) = 10.4 W/kg; SAR(10 g) = 5.38 W/kg

Maximum value of SAR (measured) = 11.79 W/kg

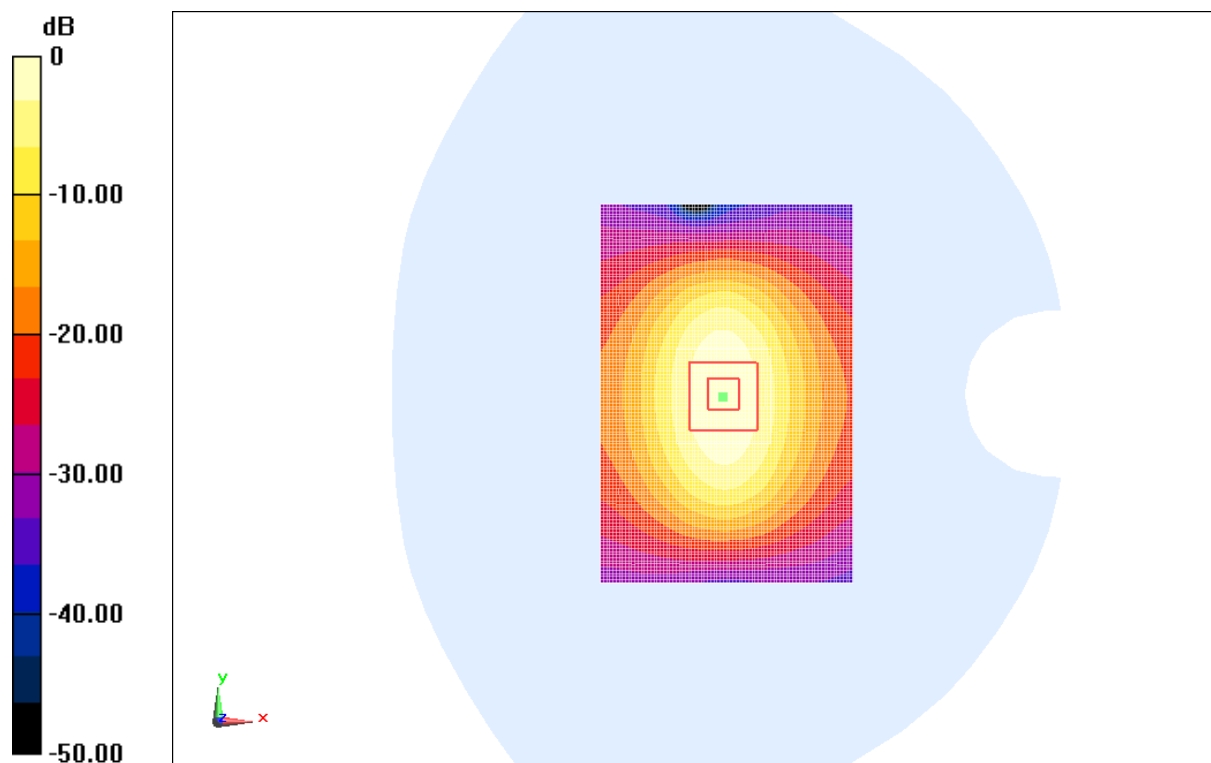

0 dB = 11.79 W/kg = 10.72 dBW/kg

Fig.B.7 validation 1900MHz 250mW

1900MHz

Date: 2019-1-19

Electronics: DAE4 Sn1525

Medium: Body 1900 MHz

Medium parameters used: $f = 1900$ MHz; $\sigma = 1.559$ S/m; $\epsilon_r = 52.41$; $\rho = 1000$ kg/m³

Ambient Temperature: 22.9°C Liquid Temperature: 22.5°C

Communication System: CW Frequency: 1900 MHz Duty Cycle: 1:1

Probe: EX3DV4 – SN7514 ConvF(7.53, 7.53, 7.53)

System validation /Area Scan (81x121x1): Interpolated grid: dx=1.000 mm, dy=1.000 mm

Reference Value = 58.758 V/m; Power Drift = -0.02 dB

Fast SAR: SAR(1 g) = 10.4 W/kg; SAR(10 g) = 5.46 W/kg

Maximum value of SAR (interpolated) = 12.44 W/kg

System validation /Zoom Scan (7x7x7)/Cube 0: Measurement grid: dx=5mm, dy=5mm, dz=5mm

Reference Value = 58.758 V/m; Power Drift = -0.02 dB

Peak SAR (extrapolated) = 19.11 W/kg

SAR(1 g) = 10.2 W/kg; SAR(10 g) = 5.3 W/kg

Maximum value of SAR (measured) = 12.28 W/kg

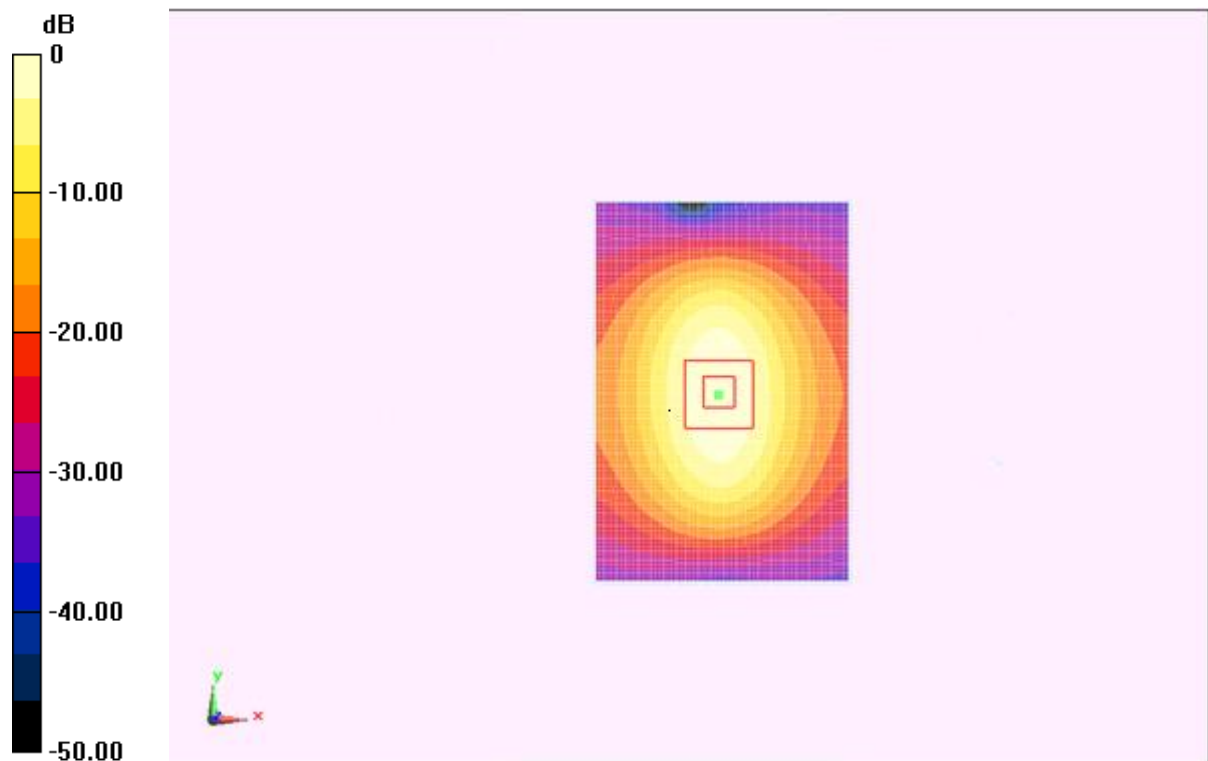

0 dB = 12.28 W/kg = 10.89 dBW/kg

Fig.B.8 validation 1900MHz 250mW

2450 MHz

Date: 2019-1-20

Electronics: DAE4 Sn1525

Medium: Head2450 MHz

Medium parameters used: $f = 2450$ MHz; $\sigma = 1.805$ mho/m; $\epsilon_r = 39.16$; $\rho = 1000$ kg/m³

Ambient Temperature: 22.9°C Liquid Temperature: 22.5°C

Communication System: CW Frequency: 2450 MHz Duty Cycle: 1:1

Probe: EX3DV4 – SN7514 ConvF(6.95, 6.95, 6.95)

System Validation /Area Scan (81x191x1): Interpolated grid: dx=1.000 mm, dy=1.000 mm

Reference Value = 115.9 V/m; Power Drift = 0

Fast SAR: SAR(1 g) = 13.4 W/kg; SAR(10 g) = 6.38 W/kg

Maximum value of SAR (interpolated) = 22.2 W/kg

System Validation /Zoom Scan (7x7x7)/Cube 0: Measurement grid: dx=5mm, dy=5mm, dz=5mm

Reference Value = 115.9 V/m; Power Drift = 0 dB

Peak SAR (extrapolated) = 27.85 W/kg

SAR(1 g) = 13.2 W/kg; SAR(10 g) = 6.25 W/kg

Maximum value of SAR (measured) = 22.0 W/kg

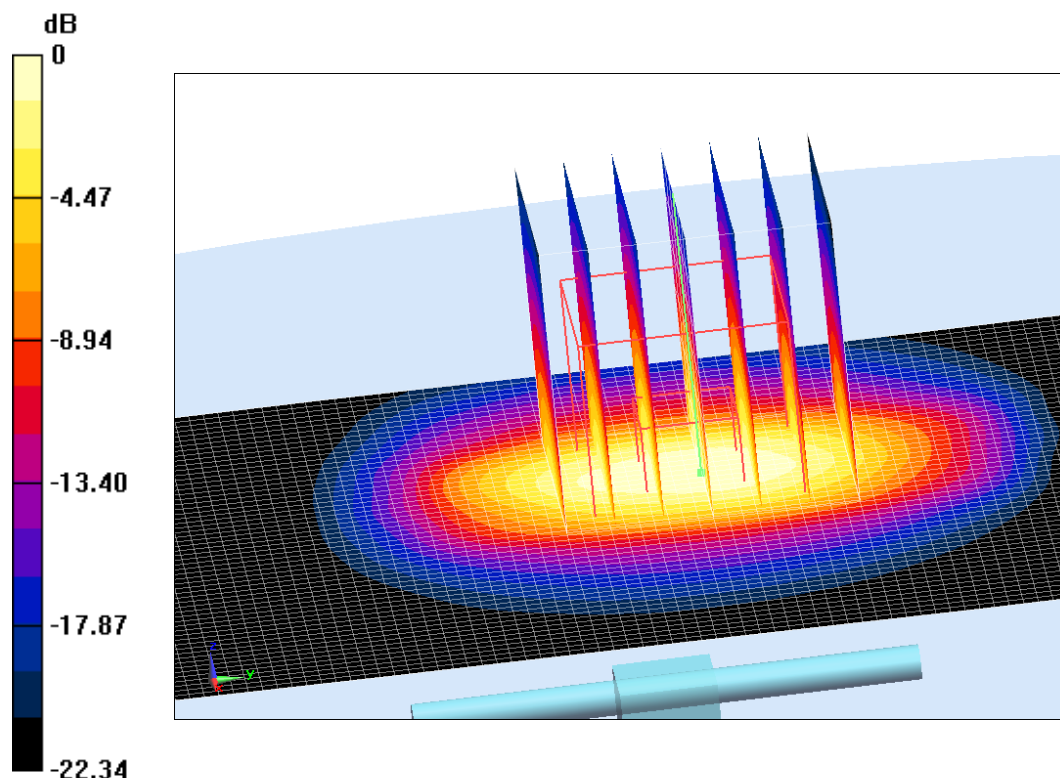

0 dB = 22.0 W/kg = 13.42 dB W/kg

Fig.B.9 validation 2450 MHz 250mW

2450 MHz

Date: 2019-1-20

Electronics: DAE4 Sn1525

Medium: Body2450 MHz

Medium parameters used: $f = 2450$ MHz; $\sigma = 1.966$ mho/m; $\epsilon_r = 51.99$; $\rho = 1000$ kg/m³

Ambient Temperature: 22.9°C Liquid Temperature: 22.5°C

Communication System: CW Frequency: 2450 MHz Duty Cycle: 1:1

Probe: EX3DV4 – SN7514 ConvF(7.13,7.13,7.13)

System Validation /Area Scan (81x191x1): Interpolated grid: dx=1.000 mm, dy=1.000 mm

Reference Value = 106.02 V/m; Power Drift = 0

Fast SAR: SAR(1 g) = 13.2W/kg; SAR(10 g) = 6.18 W/kg

Maximum value of SAR (interpolated) = 21.73 W/kg

System Validation /Zoom Scan (7x7x7)/Cube 0: Measurement grid: dx=5mm, dy=5mm, dz=5mm

Reference Value = 106.02 V/m; Power Drift = 0 dB

Peak SAR (extrapolated) = 26.34 W/kg

SAR(1 g) = 13.3W/kg; SAR(10 g) = 6.12 W/kg

Maximum value of SAR (measured) = 21.42 W/kg

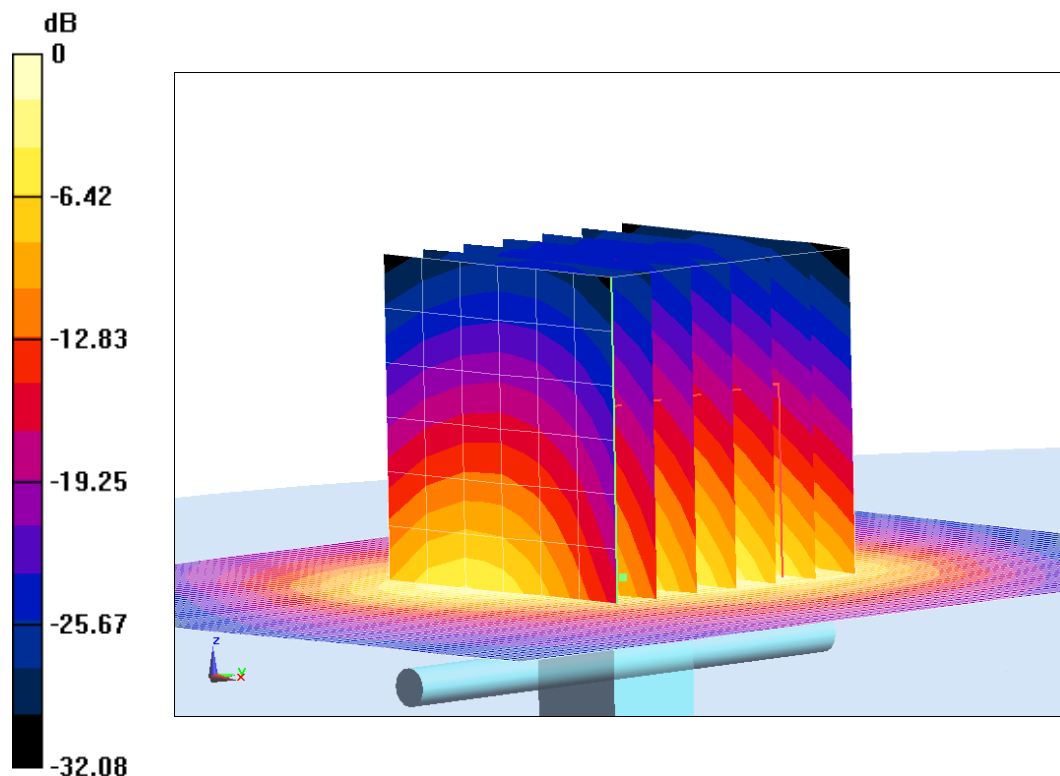

0 dB = 21.42W/kg = 13.31 dB W/kg

Fig.B.10 validation 2450 MHz 250mW

2600MHz

Date: 2019-1-21

Electronics: DAE4 Sn1525

Medium: Head 2600 MHz

Medium parameters used: $f = 2600$ MHz; $\sigma = 1.938$ mho/m; $\epsilon_r = 38.37$; $\rho = 1000$ kg/m³

Ambient Temperature: 22.9°C Liquid Temperature: 22.5°C

Communication System: CW Frequency: 2600 MHz Duty Cycle: 1:1

Probe: EX3DV4 – SN7514 ConvF(6.92, 6.92, 6.92)

System Validation/Area Scan(81x81x1): Interpolated grid: dx=1.000 mm, dy=1.000 mm

Reference Value = 77.33 V/m; Power Drift = -0.05 dB

SAR(1 g) = 14.3 W/kg; SAR(10 g) = 6.41 W/kg

Maximum value of SAR (interpolated) = 21.9 W/kg

System Validation /Zoom Scan (7x7x7)/Cube 0: Measurement grid: dx=5mm, dy=5mm, dz=5mm

Reference Value = 77.33 V/m; Power Drift = -0.05 dB

Peak SAR (extrapolated) = 30.61 W/kg

SAR(1 g) = 14.2 W/kg; SAR(10 g) = 6.32 W/kg

Maximum value of SAR (measured) = 21.8 W/kg

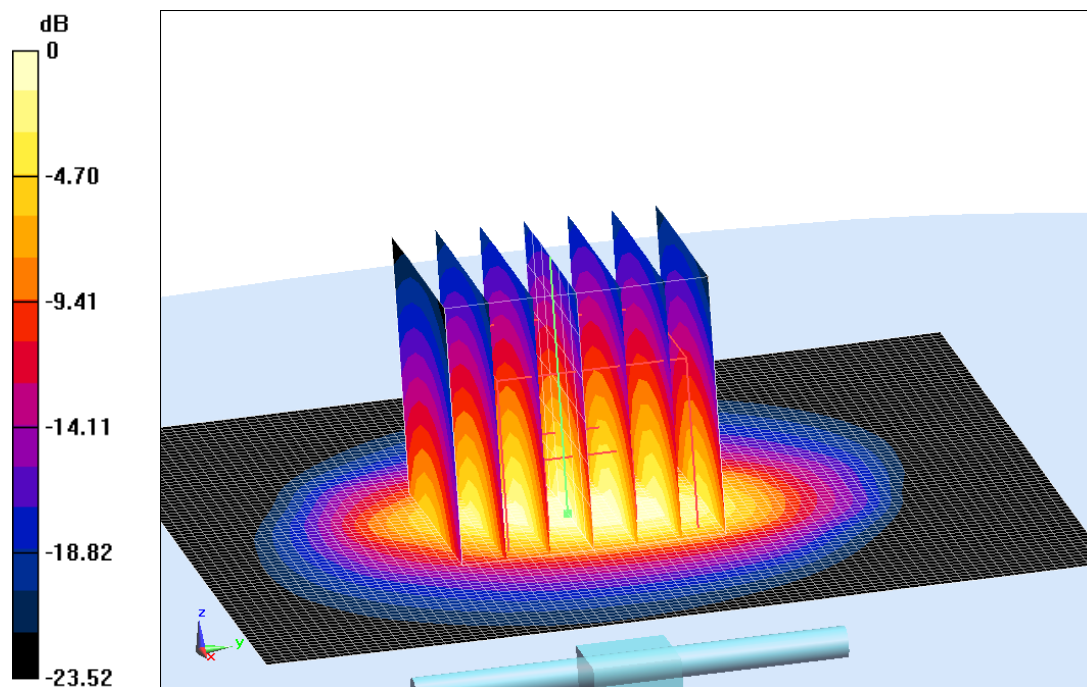

0 dB = 21.8 W/kg = 13.38 dBW/kg

Fig.B.11 validation 2600MHz 250mW

2600MHz

Date: 2019-1-21

Electronics: DAE4 Sn1525

Medium: Body 2600 MHz

Medium parameters used: $f = 2600$ MHz; $\sigma = 2.14$ mho/m; $\epsilon_r = 51.7$; $\rho = 1000$ kg/m³

Ambient Temperature: 22.9°C Liquid Temperature: 22.5°C

Communication System: CW Frequency: 2600 MHz Duty Cycle: 1:1

Probe: EX3DV4 – SN7514 ConvF(7.06, 7.06, 7.06)

System Validation /Area Scan(81x121x1): Interpolated grid: dx=1.000 mm, dy=1.000 mm

Reference Value = 78.86 V/m; Power Drift = 0.02 dB

Fast SAR: SAR(1 g) = 14 W/kg; SAR(10 g) = 6.29 W/kg

Maximum value of SAR (interpolated) = 22.1 W/kg

System Validation /Zoom Scan (7x7x7)/Cube 0: Measurement grid: dx=5mm, dy=5mm, dz=5mm

Reference Value = 78.86 V/m; Power Drift = 0.02 dB

Peak SAR (extrapolated) = 30.65 W/kg

SAR(1 g) = 13.9 W/kg; SAR(10 g) = 6.21 W/kg

Maximum value of SAR (measured) = 22 W/kg

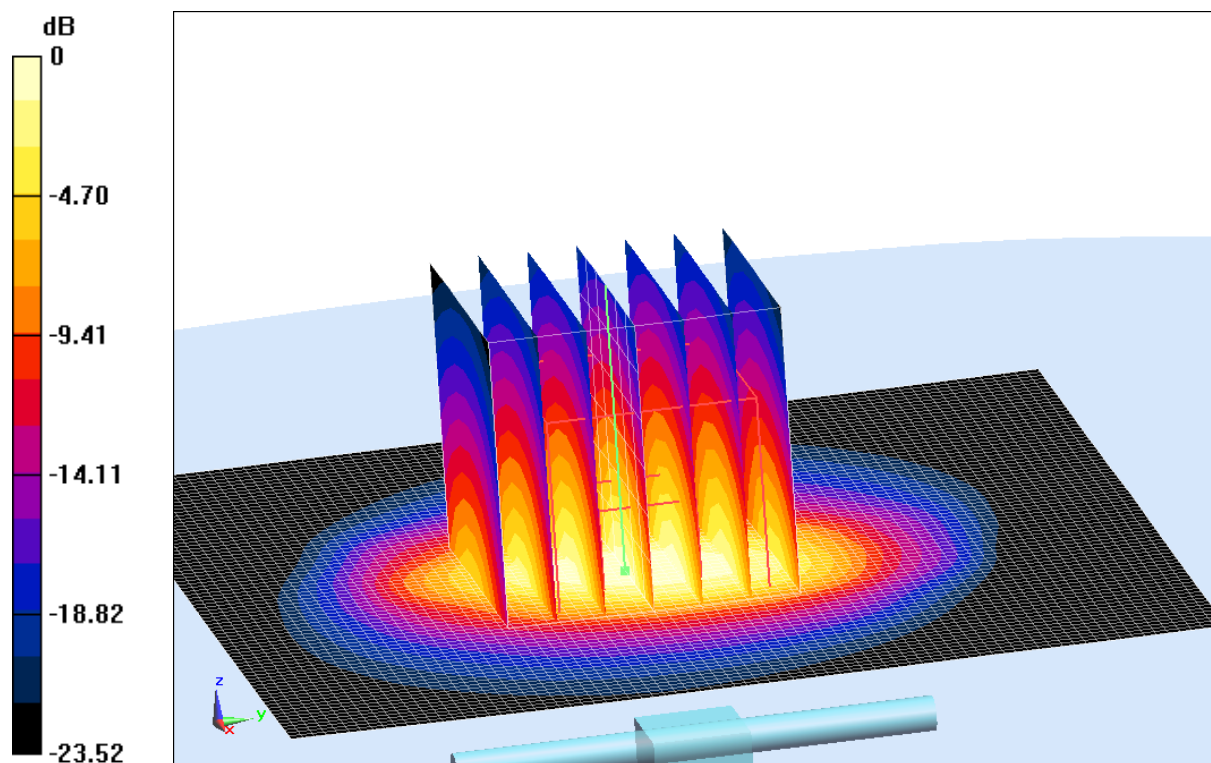

0 dB = 22 W/kg = 13.42 dB W/kg

Fig.B.12 validation 2600MHz 250mW

The SAR system verification must be required that the area scan estimated 1-g SAR is within 3% of the zoom scan 1-g SAR.

Table B.1 Comparison between area scan and zoom scan for system verification

Date	Band	Position	Area scan (1g)	Zoom scan (1g)	Drift (%)
2019-1-16	750	Head	2.14	2.11	1.42
	750	Body	2.26	2.21	2.26
2019-1-17	835	Head	2.26	2.3	-1.74
	835	Body	2.33	2.38	-2.10
2019-1-18	1750	Head	8.99	9.15	-1.75
	1750	Body	9.35	9.14	2.30
2019-1-19	1900	Head	10.6	10.4	1.92
	1900	Body	10.4	10.2	1.96
2019-1-20	2450	Head	13.4	13.2	1.52
	2450	Body	13.2	13.3	-0.75
2019-1-21	2600	Head	14.3	14.2	0.70
	2600	Body	14	13.9	0.72

ANNEX C SAR Measurement Setup

C.1 Measurement Set-up

The Dasy4 or DASY5 system for performing compliance tests is illustrated above graphically. This system consists of the following items:

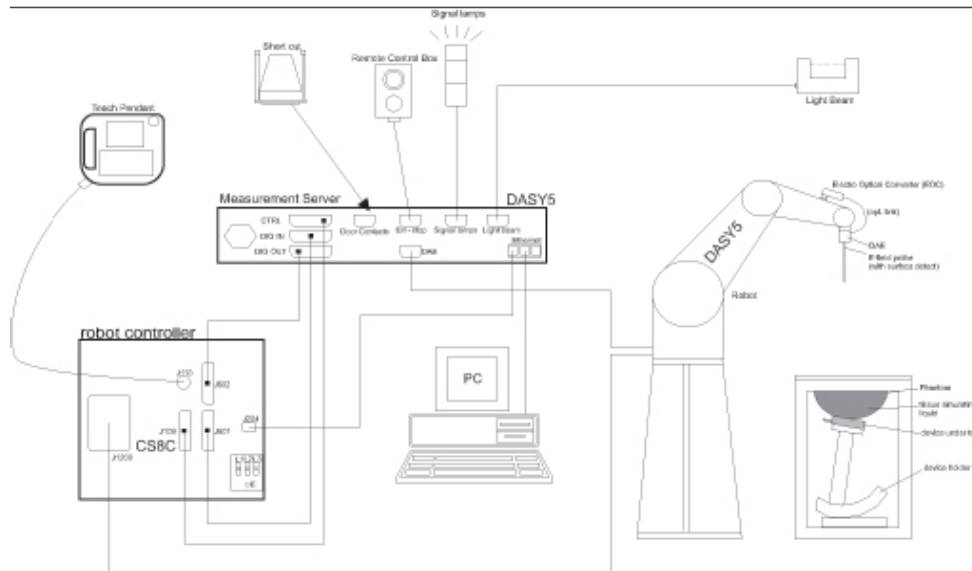

Picture C.1 SAR Lab Test Measurement Set-up

- A standard high precision 6-axis robot (StäubliTX=RX family) with controller, teach pendant and software. An arm extension for accommodating the data acquisition electronics (DAE).
- An isotropic field probe optimized and calibrated for the targeted measurement.
- A data acquisition electronics (DAE) which performs the signal amplification, signal multiplexing, AD-conversion, offset measurements, mechanical surface detection, collision detection, etc. The unit is battery powered with standard or rechargeable batteries. The signal is optically transmitted to the EOC.
- The Electro-optical converter (EOC) performs the conversion from optical to electrical signals for the digital communication to the DAE. To use optical surface detection, a special version of the EOC is required. The EOC signal is transmitted to the measurement server.
- The function of the measurement server is to perform the time critical tasks such as signal filtering, control of the robot operation and fast movement interrupts.
- The Light Beam used is for probe alignment. This improves the (absolute) accuracy of the probe positioning.
- A computer running WinXP and the DASY4 or DASY5 software.
- Remote control and teach pendant as well as additional circuitry for robot safety such as
- warning lamps, etc.
- The phantom, the device holder and other accessories according to the targeted measurement.

C.2 Dasy4 or DASY5 E-field Probe System

The SAR measurements were conducted with the dosimetric probe designed in the classical triangular configuration and optimized for dosimetric evaluation. The probe is constructed using the thick film technique; with printed resistive lines on ceramic substrates. The probe is equipped with an optical multifiber line ending at the front of the probe tip. It is connected to the EOC box on the robot arm and provides an automatic detection of the phantom surface. Half of the fibers are connected to a pulsed infrared transmitter, the other half to a synchronized receiver. As the probe approaches the surface, the reflection from the surface produces a coupling from the transmitting to the receiving fibers. This reflection increases first during the approach, reaches maximum and then decreases. If the probe is flatly touching the surface, the coupling is zero. The distance of the coupling maximum to the surface is independent of the surface reflectivity and largely independent of the surface to probe angle. The DASY4 or DASY5 software reads the reflection during a software approach and looks for the maximum using 2nd order curve fitting. The approach is stopped at reaching the maximum.

Probe Specifications:

Model:	ES3DV3, EX3DV4
Frequency	10MHz — 6.0GHz(EX3DV4)
Range:	10MHz — 4GHz(ES3DV3)
Calibration:	In head and body simulating tissue at Frequencies from 835 up to 5800MHz
Linearity:	± 0.2 dB(30 MHz to 6 GHz) for EX3DV4 ± 0.2 dB(30 MHz to 4 GHz) for ES3DV3
DynamicRange:	10 mW/kg — 100W/kg
Probe Length:	330 mm
Probe Tip	
Length:	20 mm
Body Diameter:	12 mm
Tip Diameter:	2.5 mm (3.9 mm for ES3DV3)
Tip-Center:	1 mm (2.0mm for ES3DV3)
Application:	SAR Dosimetry Testing Compliance tests of mobile phones Dosimetry in strong gradient fields



Picture C.2 Near-field Probe



Picture C.3 E-field Probe

C.3 E-field Probe Calibration

Each E-Probe/Probe Amplifier combination has unique calibration parameters. A TEM cell calibration procedure is conducted to determine the proper amplifier settings to enter in the probe parameters. The amplifier settings are determined for a given frequency by subjecting the probe to a known E-field density (1 mW/cm²) using an RF Signal generator, TEM cell, and RF Power Meter.

The free space E-field from amplified probe outputs is determined in a test chamber. This calibration can be performed in a TEM cell if the frequency is below 1 GHz and in a waveguide or other methodologies above 1 GHz for free space. For the free space calibration, the probe is placed