



# FCC RF Test Report

APPLICANT : Rolling Wireless S.a r.l.  
EQUIPMENT : 5G module  
BRAND NAME : Rolling Wireless  
MODEL NAME : RW350R-GL  
FCC ID : 2AX2URW350RGL  
STANDARD : 47 CFR Part 2, 27  
CLASSIFICATION : PCS Licensed Transmitter (PCB)  
TEST DATE(S) : Apr. 02, 2024 ~ May 20, 2024

We, Sporton International Inc. (Shenzhen), would like to declare that the tested sample has been evaluated in accordance with the procedures given in ANSI C63.26-2015 and shown compliance with the applicable technical standards.

The test results in this report apply exclusively to the tested model / sample. Without written approval of Sporton International Inc. (Shenzhen), the test report shall not be reproduced except in full.

Jason Jia



Approved by: Jason Jia

**Sporton International Inc. (ShenZhen)**

**1/F, 2/F, Bldg 5, Shiling Industrial Zone, Xinwei Village, Xili, Nanshan, Shenzhen, 518055**

**People's Republic of China**



TABLE OF CONTENTS

REVISION HISTORY..... 3
SUMMARY OF TEST RESULT ..... 4
1 GENERAL DESCRIPTION ..... 5
1.1 Applicant ..... 5
1.2 Manufacturer ..... 5
1.3 Product Feature of Equipment Under Test ..... 5
1.4 Product Specification of Equipment Under Test ..... 6
1.5 Modification of EUT ..... 6
1.6 Maximum Conducted Power and Emission Designator ..... 6
1.7 Testing Site ..... 7
1.8 Test Software ..... 7
1.9 Applied Standards ..... 7
2 TEST CONFIGURATION OF EQUIPMENT UNDER TEST ..... 8
2.1 Test Mode ..... 8
2.2 Connection Diagram of Test System ..... 9
2.3 Support Unit used in test configuration and system ..... 9
2.4 Measurement Results Explanation Example ..... 9
2.5 Frequency List of Low/Middle/High Channels ..... 10
3 CONDUCTED TEST ITEMS ..... 11
3.1 Measuring Instruments ..... 11
3.2 Test Setup ..... 11
3.3 Test Result of Conducted Test ..... 11
3.4 Conducted Output Power Measurement ..... 12
3.5 Peak-to-Average Ratio ..... 13
3.6 EIRP ..... 14
3.7 Occupied Bandwidth ..... 15
3.8 Conducted Band Edge Measurement ..... 16
3.9 Conducted Spurious Emission Measurement ..... 17
3.10 Frequency Stability Measurement ..... 18
4 RADIATED TEST ITEMS ..... 19
4.1 Measuring Instruments ..... 19
4.2 Test Setup ..... 19
4.3 Test Result of Radiated Test ..... 20
4.4 Radiated Spurious Emission Measurement ..... 21
5 LIST OF MEASURING EQUIPMENT ..... 22
6 MEASUREMENT UNCERTAINTY ..... 23
APPENDIX A. TEST RESULTS OF CONDUCTED TEST
APPENDIX B. TEST RESULTS OF RADIATED TEST
APPENDIX C. TEST SETUP PHOTOGRAPHS



## REVISION HISTORY

REPORT NO.	VERSION	DESCRIPTION	ISSUED DATE
FG430728P	Rev. 01	Initial issue of report	Jun. 13, 2024



### SUMMARY OF TEST RESULT

Report Section	FCC Rule	Description	Limit	Result	Remark
3.4	§2.1046	Conducted Output Power	—	Report Only	-
3.5	-	Peak-to-Average Ratio	—	Report Only	
3.6	§27.50 (a)(3)	EIRP	EIRP < 250mW/5MHz	PASS	-
3.7	§2.1049	Occupied Bandwidth	—	Report Only	-
3.8	§2.1051 §27.53 (a)(4)	Conducted Band Edge Measurement	Refer standard	PASS	-
3.9	§2.1051 §27.53 (a)(4)	Conducted Spurious Emission	< 70+10log <sub>10</sub> (P[Watts])	PASS	-
3.10	§2.1055 §27.54	Frequency Stability Temperature & Voltage	Within the band	PASS	-
4.4	§2.1053 §27.53 (a)(4)	Radiated Spurious Emission	< 70+10log <sub>10</sub> (P[Watts])	PASS	Under limit 15.82 dB at 9231.000 MHz

**Conformity Assessment Condition:**

1. The test results (PASS/FAIL) with all measurement uncertainty excluded are presented against the regulation limits or in accordance with the requirements stipulated by the applicant/manufacture who shall bear all the risks of non-compliance that may potentially occur if measurement uncertainty is taken into account.
2. The measurement uncertainty please refer to each test result in the section "Measurement Uncertainty"

**Disclaimer:**

The product specifications of the EUT presented in the test report that may affect the test assessments are declared by the manufacturer who shall take full responsibility for the authenticity.

# 1 General Description

## 1.1 Applicant

Rolling Wireless S.a r.l.  
8-10, rue Mathias Hardt 1717, Luxembourg

## 1.2 Manufacturer

Rolling Wireless S.a r.l.  
8-10, rue Mathias Hardt 1717, Luxembourg

## 1.3 Product Feature of Equipment Under Test

Product Feature	
Equipment	5G module
Brand Name	Rolling Wireless
Model Name	RW350R-GL
FCC ID	2AX2URW350RGL
IMEI Code	Conducted: 356413950001763 Radiation: 356413950000682 for Sample 1 356413950000526 for Sample 2
HW Version	V1.1
SW Version	81601.0000.00.29.24.13
EUT Stage	Identical Prototype

## 1.4 Product Specification of Equipment Under Test

Product Feature	
<b>Tx Frequency</b>	5G NR n30 : 2305 MHz ~ 2315 MHz
<b>Rx Frequency</b>	5G NR n30 : 2350 MHz ~ 2360 MHz
<b>SCS / Bandwidth</b>	15kHz : 5MHz / 10MHz 30kHz: 10MHz
<b>Antenn Type</b>	External Monopole Antenna or External PIFA Antenna
<b>Antenna Gain</b>	5G NR n30 : 1.0 dBi
<b>Type of Modulation</b>	DFT-s-OFDM (PI/2 BPSK / QPSK / 16QAM / 64QAM / 256QAM) CP-OFDM (QPSK / 16QAM / 64QAM / 256QAM)

**Remark:**

1. The device has two optional antennas, they are same antenna gain, RSE pretest the two antennas, choose worst antenna to perform final test and recorded in the report.
2. There are two samples under test, sample 1 is 1<sup>st</sup> source and sample 2 is 2<sup>nd</sup> source, the detailed differences could be referred to the RW350R-GL\_Operational Description of Product Equality Declaration which is exhibit separately. According to the differences, sample 1 perform full test, sample 2 verify conducted power and found less than sample 1, and sample 2 additional verify the worst case of RSE.
3. 5G NR n30 supports SA mode only.
4. 5G NR n30 supports SCS 15kHz and SCS 30kHz. According to the maximum power, SCS 15kHz covers SCS 30kHz.

## 1.5 Modification of EUT

No modifications are made to the EUT during all test items.

## 1.6 Maximum Conducted Power and Emission Designator

5G NR n30 -SCS15K		PI/2 BPSK / QPSK		16QAM / 64QAM / 256QAM	
BW (MHz)	Frequency Range (MHz)	Maximum Conducted Power (W)	Emission Designator (99%OBW)	Maximum Conducted Power (W)	Emission Designator (99%OBW)
5	2307.5 ~ 2312.5	0.1726	4M47G7D	0.1253	4M47W7D
10	2310.0	0.1791	9M27G7D	0.1403	9M29W7D

Note: All modulations have been tested, only the worst test results are shown in the report.

### 1.7 Testing Site

Sporton International Inc. (ShenZhen) is accredited to ISO/IEC 17025:2017 by American Association for Laboratory Accreditation with Certificate Number 5145.01.

<b>Test Firm</b>	Sporton International Inc. (ShenZhen)		
<b>Test Site Location</b>	1/F, 2/F, Bldg 5, Shiling Industrial Zone, Xinwei Village, Xili, Nanshan, Shenzhen, 518055 People's Republic of China TEL: +86-755-86379589 FAX: +86-755-86379595		
<b>Test Site No.</b>	<b>Sporton Site No.</b>	<b>FCC Designation No.</b>	<b>FCC Test Firm Registration No.</b>
	TH01-SZ	CN1256	421272

<b>Test Firm</b>	Sporton International Inc. (ShenZhen)		
<b>Test Site Location</b>	101, 1st Floor, Block B, Building 1, No. 2, Tengfeng 4th Road, Fenghuang Community, Fuyong Street, Baoan District, Shenzhen City, Guangdong Province 518103 People's Republic of China TEL: +86-755-86066985		
<b>Test Site No.</b>	<b>Sporton Site No.</b>	<b>FCC Designation No.</b>	<b>FCC Test Firm Registration No.</b>
	03CH03-SZ	CN1256	421272

### 1.8 Test Software

Item	Site	Manufacture	Name	Version
1.	03CH03-SZ	AUDIX	E3	6.2009-8-24

### 1.9 Applied Standards

According to the specifications of the manufacturer, the EUT must comply with the requirements of the following standards:

- ♦ 47 CFR Part 2, Part 27(D)
- ♦ ANSI C63.26-2015
- ♦ FCC KDB 971168 Power Meas License Digital Systems D01 v03r01
- ♦ FCC KDB 412172 D01 Determining ERP and EIRP v01r01

**Remark:**

1. All test items were verified and recorded according to the standards and without any deviation during the test.
2. This EUT has also been tested and complied with the requirements of FCC Part 15, Subpart B, recorded in a separate test report.



## 2 Test Configuration of Equipment Under Test

### 2.1 Test Mode

Antenna port conducted and radiated test items listed below are performed according to KDB 971168 D01 Power Meas. License Digital Systems v03r01 with maximum output power.

Radiated measurements are performed by rotating the EUT in three different orthogonal test planes to find the maximum emission. (X Plane)

Conducted Test Cases	Band	Bandwidth (MHz)						Modulation					RB #			Test Channel		
		1.4	3	5	10	15	20	PI/2 BPSK	QPSK	16QAM	64QAM	256QAM	1	Half	Full	L	M	H
Max. Output Power	30	-	-	V		-	-		V	V			V			V	V	V
		-	-		V	-	-	V	V	V	V	V	V		V		V	
Peak-to-Average Ratio	30	-	-		V	-	-	V	V						V		V	
E.I.R.P	30	-	-	V		-	-		V	V			V			V	V	V
		-	-		V	-	-	V	V	V	V	V	V		V		V	
26dB and 99% Bandwidth	30	-	-	V	V	-	-		V	V	V	V			V		V	
Conducted Band Edge	30	-	-	V		-	-	V	V				V		V	V		V
		-	-		V	-	-	V	V				V		V		V	
Conducted Spurious Emission	30	-	-	V		-	-	V	V				V			V	V	V
		-	-		V	-	-	V	V				V				V	
Frequency Stability	30	-	-		V	-	-		V						V		V	
Radiated Spurious Emission	30				V				V				V			V	V	V
Note	<ol style="list-style-type: none"> <li>The mark "v" means that this configuration is chosen for testing</li> <li>The mark "-" means that this bandwidth is not supported.</li> <li>The device is investigated from 30MHz to 10 times of fundamental signal for radiated spurious emission test under different RB size/offset and modulations in exploratory test. Subsequently, only the worst case emissions are reported.</li> <li>Frequency Stability : Normal Voltage = 3.3V ; Low Voltage =3.14V ; High Voltage =4.4V .</li> </ol>																	



## 2.2 Connection Diagram of Test System

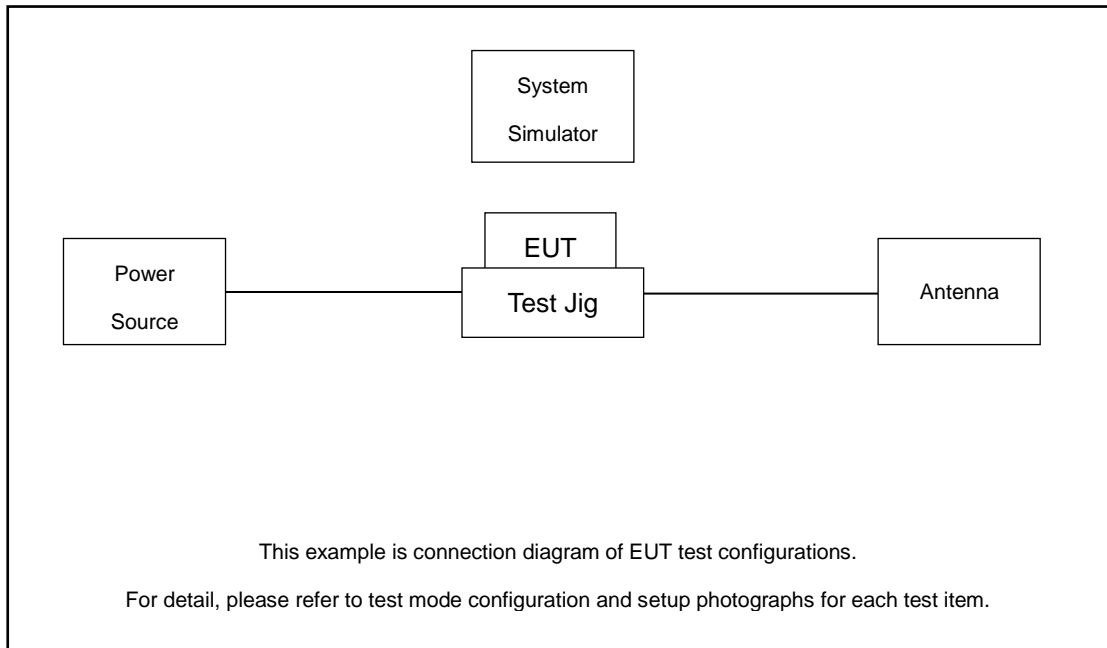

## 2.3 Support Unit used in test configuration and system

Item	Equipment	Trade Name	Model No.	FCC ID	Data Cable	Power Cord
1.	System Simulator	Anritsu	MT8000A	N/A	N/A	Unshielded, 1.8 m
2.	DC Power Supply	GW	GPS-3030D	N/A	N/A	Unshielded, 1.8 m
3.	Antenna	N/A	N/A	N/A	N/A	N/A
4.	Adapter	N/A	N/A	N/A	N/A	N/A
5.	Test Jig	N/A	N/A	N/A	N/A	N/A

## 2.4 Measurement Results Explanation Example

### For all conducted test items:

The offset level is set in the spectrum analyzer to compensate the RF cable loss between EUT conducted output port and spectrum analyzer. With the offset compensation, the spectrum analyzer reading level is exactly the EUT RF output level.

The spectrum analyzer offset is derived from RF cable loss.

*Offset = RF cable loss.*

Following shows an offset computation example with cable loss 8.6 dB.

Example :

$$\begin{aligned} \text{Offset(dB)} &= \text{RF cable loss(dB)} \\ &= 8.6 \text{ (dB)} \end{aligned}$$



## 2.5 Frequency List of Low/Middle/High Channels

5G NR n30 Channel and Frequency List for SCS 15K &30K				
BW [MHz]	Channel/Frequency(MHz)	Lowest	Middle	Highest
10	Channel	-	27710	-
	Frequency	-	2310	-
5	Channel	27685	27710	27735
	Frequency	2307.5	2310	2312.5

Note: SCS 30K does not support 5MHz Bandwidth.

### 3 Conducted Test Items

#### 3.1 Measuring Instruments

See list of measuring instruments of this test report.

#### 3.2 Test Setup

##### 3.2.1 Conducted Output Power

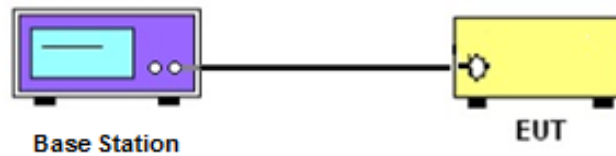

##### 3.2.2 Peak-to-Average Ratio, Occupied / 26dB Bandwidth, Band-Edge and Conducted Spurious Emission

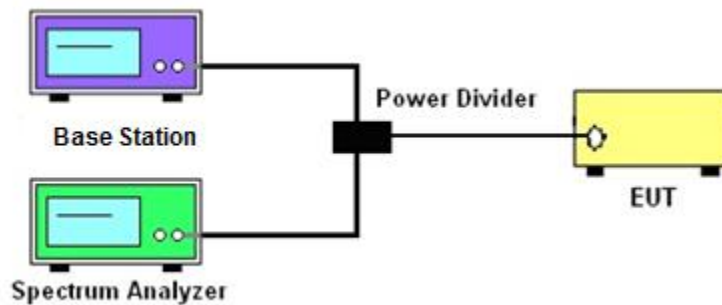

##### 3.2.3 Frequency Stability

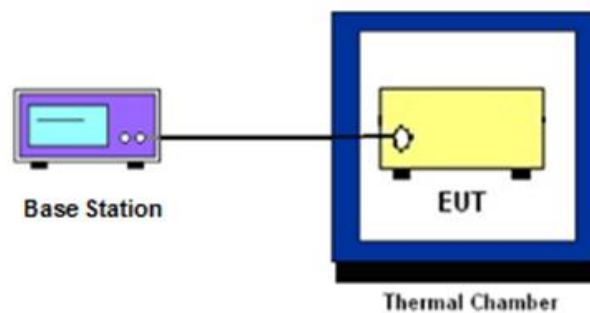

### 3.3 Test Result of Conducted Test

Please refer to Appendix A.



## 3.4 Conducted Output Power Measurement

### 3.4.1 Description of the Conducted Output Power Measurement

A base station simulator was used to establish communication with the EUT. Its parameters were set to transmit the maximum power on the EUT. The measured power in the radio frequency on the transmitter output terminals shall be reported.

### 3.4.2 Test Procedures

1. The testing follows ANSI C63.26 Section 5.2
2. The transmitter output port was connected to the system simulator.
3. Set EUT at maximum power through the system simulator.
4. Select lowest, middle, and highest channels for each band and different modulation.
5. Measure and record the power level from the system simulator.

## 3.5 Peak-to-Average Ratio

### 3.5.1 Description of the PAR Measurement

Power Complementary Cumulative Distribution Function (CCDF) curves provide a means for characterizing the power peaks of a digitally modulated signal on a statistical basis. A CCDF curve depicts the probability of the peak signal amplitude exceeding the average power level. Most contemporary measurement instrumentation include the capability to produce CCDF curves for an input signal provided that the instrument's resolution bandwidth can be set wide enough to accommodate the entire input signal bandwidth. In measuring transmissions in this band using an average power technique, the peak-to-average ratio (PAR) of the transmission may not exceed 13 dB.

### 3.5.2 Test Procedures

1. The testing follows ANSI C63.26 Section 5.2.3.4 (CCDF).
2. The EUT was connected to spectrum and system simulator via a power divider.
3. Set the CCDF (Complementary Cumulative Distribution Function) option in spectrum analyzer.
4. The highest RF powers were measured and recorded the maximum PAPR level associated with a probability of 0.1 %.
5. Record the deviation as Peak to Average Ratio.

## 3.6 EIRP

### 3.6.1 Description of EIRP

For mobile and portable stations transmitting in the 2305-2315 MHz band or the 2350-2360 MHz band, the average EIRP must not exceed 50 milliwatts within any 1 megahertz of authorized bandwidth, *except that* for mobile and portable stations compliant with 3GPP LTE standards or another advanced mobile broadband protocol that avoids concentrating energy at the edge of the operating band the average EIRP must not exceed 250 milliwatts within any 5 megahertz of authorized bandwidth but may exceed 50 milliwatts within any 1 megahertz of authorized bandwidth. For mobile and portable stations using time division duplexing (TDD) technology, the duty cycle must not exceed 38 percent in the 2305-2315 MHz and 2350-2360 MHz bands. Mobile and portable stations using FDD technology are restricted to transmitting in the 2305-2315 MHz band. Power averaging shall not include intervals in which the transmitter is off.

### 3.6.2 Test Procedures

1. According to KDB 412172 D01 Power Approach,
2.  $EIRP = P_T + G_T - L_C$ ,  $ERP = EIRP - 2.15$ , where

$P_T$  = transmitter output power in dBm

$G_T$  = gain of the transmitting antenna in dBi

$L_C$  = signal attenuation in the connecting cable between the transmitter and antenna in dB

## 3.7 Occupied Bandwidth

### 3.7.1 Description of Occupied Bandwidth Measurement

The occupied bandwidth is the width of a frequency band such that, below the lower and above the upper frequency limits, the mean powers emitted are each equal to a specified percentage 0.5% of the total mean transmitted power.

The 26 dB emission bandwidth is defined as the frequency range between two points, one above and one below the carrier frequency, at which the spectral density of the emission is attenuated 26 dB below the maximum in-band spectral density of the modulated signal. Spectral density (power per unit bandwidth) is to be measured with a detector of resolution bandwidth equal to approximately 1.0% of the emission bandwidth.

### 3.7.2 Test Procedures

1. The testing follows ANSI C63.26 Section 5.4
2. The EUT was connected to spectrum analyzer and system simulator via a power divider.
3. The spectrum analyzer center frequency is set to the nominal EUT channel center frequency. The span range for the spectrum analyzer shall be between two and five times the anticipated OBW.
4. The nominal resolution bandwidth (RBW) shall be in the range of 1 to 5 % of the anticipated OBW, and the VBW shall be at least 3 times the RBW.
5. Set the detection mode to peak, and the trace mode to max hold.
6. Determine the reference value: Set the EUT to transmit a modulated signal. Allow the trace to stabilize. Set the spectrum analyzer marker to the highest level of the displayed trace.  
(this is the reference value)
7. Determine the “-26 dB down amplitude” as equal to (Reference Value – X).
8. Place two markers, one at the lowest and the other at the highest frequency of the envelope of the spectral display such that each marker is at or slightly below the “-X dB down amplitude” determined in step 6. If a marker is below this “-X dB down amplitude” value it shall be placed as close as possible to this value. The OBW is the positive frequency difference between the two markers.
9. Use the 99 % power bandwidth function of the spectrum analyzer and report the measured bandwidth.



## 3.8 Conducted Band Edge Measurement

### 3.8.1 Description of Conducted Band Edge Measurement

27.53 (a)(4)

For mobile and portable stations operating in the 2305-2315 MHz and 2350-2360 MHz bands:

- (i) By a factor of not less than:  $43 + 10 \log (P)$  dB on all frequencies between 2305 and 2320 MHz and on all frequencies between 2345 and 2360 MHz that are outside the licensed band(s) of operation, not less than  $55 + 10 \log (P)$  dB on all frequencies between 2320 and 2324 MHz and on all frequencies between 2341 and 2345 MHz, not less than  $61 + 10 \log (P)$  dB on all frequencies between 2324 and 2328 MHz and on all frequencies between 2337 and 2341 MHz, and not less than  $67 + 10 \log (P)$  dB on all frequencies between 2328 and 2337 MHz;
- (ii) By a factor of not less than  $43 + 10 \log (P)$  dB on all frequencies between 2300 and 2305 MHz,  $55 + 10 \log (P)$  dB on all frequencies between 2296 and 2300 MHz,  $61 + 10 \log (P)$  dB on all frequencies between 2292 and 2296 MHz,  $67 + 10 \log (P)$  dB on all frequencies between 2288 and 2292 MHz, and  $70 + 10 \log (P)$  dB below 2288 MHz;
- (iii) By a factor of not less than  $43 + 10 \log (P)$  dB on all frequencies between 2360 and 2365 MHz, and not less than  $70 + 10 \log (P)$  dB above 2365 MHz.

### 3.8.2 Test Procedures

1. The testing follows ANSI C63.26 section 5.7
2. The EUT was connected to spectrum analyzer and system simulator via a power divider.
3. The band edges of low and high channels for the highest RF powers were measured.
4. Set RBW  $\geq$  1% EBW in the 1MHz band immediately outside and adjacent to the band edge.
5. Beyond the 1 MHz band from the band edge, RBW=1MHz was used or a narrower RBW was used and the measured power was integrated over the full required measurement bandwidth of 1 MHz.
6. Set spectrum analyzer with RMS detector.
7. The RF fundamental frequency should be excluded against the limit line in the operating frequency band.
8. Checked that all the results comply with the emission limit line.

Example:

The limit line is derived from  $43 + 10\log(P)$ dB below the transmitter power P(Watts)

$$= P(W) - [43 + 10\log(P)] \text{ (dB)}$$

$$= [30 + 10\log(P)] \text{ (dBm)} - [43 + 10\log(P)] \text{ (dB)} = -13\text{dBm.}$$



## 3.9 Conducted Spurious Emission Measurement

### 3.9.1 Description of Conducted Spurious Emission Measurement

The power of any emission outside of the authorized operating frequency ranges must be lower than the transmitter power (P) by a factor of at least  $70 + 10 \log (P)$  dB.

It is measured by means of a calibrated spectrum analyzer and scanned from 9 kHz up to a frequency including its 10<sup>th</sup> harmonic.

### 3.9.2 Test Procedures

1. The testing follows ANSI C63.26 section 5.7
2. The EUT was connected to spectrum analyzer and system simulator via a power divider.
3. The RF output of EUT was connected to the spectrum analyzer by RF cable and attenuator. The path loss was compensated to the results for each measurement.
4. The middle channel for the highest RF power within the transmitting frequency was measured.
5. The conducted spurious emission for the whole frequency range was taken.
6. Make the measurement with the spectrum analyzer's RBW = 1MHz, VBW = 3MHz.
7. Set spectrum analyzer with RMS detector.
8. Taking the record of maximum spurious emission.
9. The RF fundamental frequency should be excluded against the limit line in the operating frequency band.
10. The limit line is derived from  $70 + 10\log(P)$ dB below the transmitter power P(Watts)  
=  $P(W) - [70 + 10\log(P)]$  (dB)  
=  $[30 + 10\log(P)]$  (dBm) -  $[70 + 10\log(P)]$  (dB)  
= -40dBm

## 3.10 Frequency Stability Measurement

### 3.10.1 Description of Frequency Stability Measurement

The frequency stability shall be measured by variation of ambient temperature and variation of primary supply voltage to ensure that the fundamental emission stays within the authorized frequency block.

### 3.10.2 Test Procedures for Temperature Variation

1. The testing follows ANSI C63.26 section 5.6.4
2. The EUT was set up in the thermal chamber and connected with the system simulator.
3. With power OFF, the temperature was decreased to  $-30^{\circ}\text{C}$  and the EUT was stabilized before testing. Power was applied and the maximum change in frequency was recorded within one minute.
4. With power OFF, the temperature was raised in  $10^{\circ}\text{C}$  step up to  $50^{\circ}\text{C}$ . The EUT was stabilized at each step for at least half an hour. Power was applied and the maximum frequency change was recorded within one minute.

### 3.10.3 Test Procedures for Voltage Variation

1. The testing follows ANSI C63.26 section 5.6.5.
2. The EUT was placed in a temperature chamber at  $20\pm 5^{\circ}\text{C}$  and connected with the system simulator.
3. The power supply voltage to the EUT was varied from 85% to 115% of the nominal value for other than hand carried battery equipment.
4. For hand carried, battery powered equipment, reduce the primary ac or dc supply voltage to the battery operating end point, which shall be specified by the manufacturer.
5. The variation in frequency was measured for the worst case.

## 4 Radiated Test Items

### 4.1 Measuring Instruments

See list of measuring instruments of this test report.

### 4.2 Test Setup

#### 4.2.1 For radiated test below 30MHz



#### 4.2.2 For radiated test from 30MHz to 1GHz

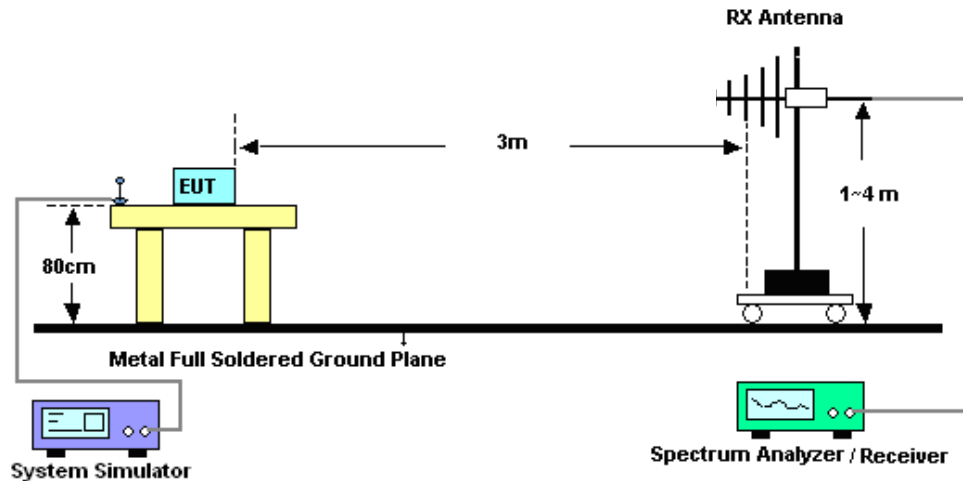

### 4.2.3 For radiated test above 1GHz

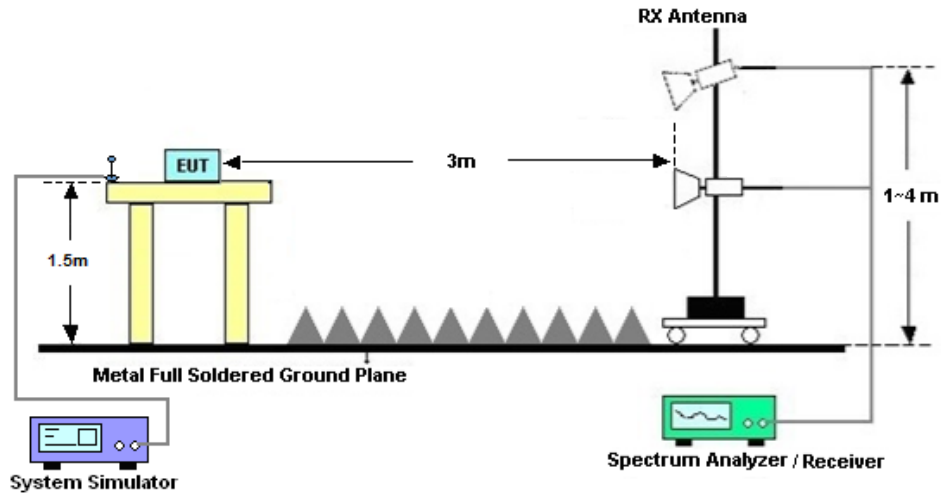

## 4.3 Test Result of Radiated Test

The low frequency, which started from 9 kHz to 30MHz, was pre-scanned and the result which was 20dB lower than the limit line was not reported.

Please refer to Appendix B.

## 4.4 Radiated Spurious Emission Measurement

### 4.4.1 Description of Radiated Spurious Emission

The radiated spurious emission was measured by substitution method according to ANSI/TIA-603-E. The power of any emission outside of the authorized operating frequency ranges must be attenuated below the transmitter power (P) by a factor of at least  $70 + 10 \log(P)$  dB.

The spectrum is scanned from 30 MHz up to a frequency including its 10th harmonic.

### 4.4.2 Test Procedures

1. The testing follows ANSI C63.26 Section 5.5
2. The EUT was placed on a turntable with 0.8 meter height for frequency below 1GHz and 1.5 meter height for frequency above 1GHz respectively above ground.
3. The EUT was set 3 meters from the receiving antenna mounted on the antenna tower.
4. The table was rotated 360 degrees to determine the position of the highest spurious emission.
5. The height of the receiving antenna is varied between 1m to 4m to search the maximum spurious emission for both horizontal and vertical polarizations.
6. During the measurement, the system simulator parameters were set to force the EUT transmitting at maximum output power.
7. Make the measurement with the spectrum analyzer's RBW = 1MHz, VBW = 3MHz, taking the record of maximum spurious emission.
8. A horn antenna was substituted in place of the EUT and was driven by a signal generator.
9. Tune the output power of signal generator to the same emission level with EUT maximum spurious emission.

$$\text{EIRP (dBm)} = \text{S.G. Power} - \text{Tx Cable Loss} + \text{Tx Antenna Gain}$$

$$\text{ERP (dBm)} = \text{EIRP} - 2.15$$

10. The RF fundamental frequency should be excluded against the limit line in the operating frequency band.

The limit line is derived from  $70 + 10\log(P)$ dB below the transmitter power P(Watts)

$$= P(W) - [70 + 10\log(P)] \text{ (dB)}$$

$$= [30 + 10\log(P)] \text{ (dBm)} - [70 + 10\log(P)] \text{ (dB)}$$

$$= -40\text{dBm.}$$



## 5 List of Measuring Equipment

Instrument	Manufacturer	Model No.	Serial No.	Characteristics	Calibration Date	Test Date	Due Date	Remark
EMI Test Receiver&SA	Agilent	N9038A	MY52260185	20Hz~26.5GHz	Dec. 27, 2023	Apr. 02, 2024	Dec. 26, 2024	Conducted (TH01-SZ)
Power Divider	TOJOIN	PS-2SM-04 265	60.06.020.007 7	0.4GHz~26.5GHz	Dec. 25, 2023	Apr. 02, 2024	Dec. 24, 2024	Conducted (TH01-SZ)
Thermal Chamber	Ten Billion Hongzhangroup	LP-150U	H2014081803	-40~+150°C	Jul. 05, 2023	Apr. 02, 2024	Jul. 04, 2024	Conducted (TH01-SZ)
EMI Test Receiver&SA	KEYSIGHT	N9038A	MY54450083	20Hz~8.4GHz	Apr. 09, 2024	Apr. 29, 2024~ May 20, 2024	Apr. 08, 2025	Radiation (03CH03-SZ)
EXA Spectrum Analyzer	KEYSIGHT	N9010A	MY55150246	10Hz~44GHz;	Apr. 09, 2024	Apr. 29, 2024~ May 20, 2024	Apr. 08, 2025	Radiation (03CH03-SZ)
Loop Antenna	R&S	HFH2-Z2	100354	9kHz~30MHz	Jun. 28, 2022	Apr. 29, 2024~ May 20, 2024	Jun. 27, 2024	Radiation (03CH03-SZ)
Bilog Antenna	TeseQ	CBL6112D	35408	30MHz-2GHz	Aug. 20, 2023	Apr. 29, 2024~ May 20, 2024	Aug. 19, 2025	Radiation (03CH03-SZ)
Double Ridge Horn Antenna	SCHWARZBECK	BBHA9120D	9120D-1355	1GHz~18GHz	Apr. 09, 2024	Apr. 29, 2024~ May 20, 2024	Apr. 08, 2025	Radiation (03CH03-SZ)
SHF-EHF Horn	com-power	AH-840	101071	18Ghz-40GHz	Apr. 09, 2024	Apr. 29, 2024~ May 20, 2024	Apr. 08, 2025	Radiation (03CH03-SZ)
Amplifier	Burgeon	BPA-530	102211	0.01Hz ~3000MHz	Oct. 18, 2023	Apr. 29, 2024~ May 20, 2024	Oct. 17, 2024	Radiation (03CH03-SZ)
HF Amplifier	MITEQ	TTA1840-35 -HG	1871923	18GHz~40GHz	Jul. 07, 2023	Apr. 29, 2024~ May 20, 2024	Jul. 06, 2024	Radiation (03CH03-SZ)
Amplifier	Agilent Technologies	83017A	MY39501302	500MHz~26.5GHz	Dec. 27, 2023	Apr. 29, 2024~ May 20, 2024	Dec. 26, 2024	Radiation (03CH03-SZ)
AC Power Source	Chroma	61601	616010002729	N/A	Oct. 18, 2023	Apr. 29, 2024~ May 20, 2024	Oct. 17, 2024	Radiation (03CH03-SZ)
Turn Table	EM	EM1000	N/A	0~360 degree	NCR	Apr. 29, 2024~ May 20, 2024	NCR	Radiation (03CH03-SZ)
Antenna Mast	EM	EM1000	N/A	1 m~4 m	NCR	Apr. 29, 2024~ May 20, 2024	NCR	Radiation (03CH03-SZ)

NCR: No Calibration Required

## 6 Measurement Uncertainty

The measurement uncertainties shown below were calculated in accordance with the requirements of ANSI 63.26-2015. All the measurement uncertainty value were shown with a coverage K=2 to indicate 95% level of confidence. The measurement data show herein meets or exceeds the CISPR measurement uncertainty values specified in CISPR 16-4-2 and can be compared directly to specified limit to determine compliance.

### Uncertainty of Conducted Measurement

Test Item	Uncertainty
Conducted Spurious Emission & Bandedge	±1.34 dB
Occupied Channel Bandwidth	±0.012 MHz
Conducted Power	±1.34 dB
Peak to Average Ratio	±1.34 dB
Frequency Stability	±1.3 Hz

### Uncertainty of Radiated Emission Measurement (30 MHz ~ 1000 MH)

Measuring Uncertainty for a Level of Confidence of 95% (U = 2Uc(y))	3.0 dB
---------------------------------------------------------------------	--------

### Uncertainty of Radiated Emission Measurement (1 GHz ~ 18 GHz)

Measuring Uncertainty for a Level of Confidence of 95% (U = 2Uc(y))	3.6 dB
---------------------------------------------------------------------	--------

### Uncertainty of Radiated Emission Measurement (18 GHz ~ 40 GHz)

Measuring Uncertainty for a Level of Confidence of 95% (U = 2Uc(y))	3.8 dB
---------------------------------------------------------------------	--------

----- THE END -----



## Appendix A. Test Results of Conducted Test

Test Engineer :	Khan	Temperature :	24~26°C
		Relative Humidity :	50~53%



# FR1 N30 -SCS 15K

## Transmitter Conducted Output Power And EIRP, ( $G_T - L_C$ )=1dBi

NR Band	SCS (kHz)	Bandwidth (MHz)	Arfcn	Freq (MHz)	Modulation	RB	Conducted Power(dBm)	EIRP (dBm)	EIRP (W)
30	15	5	461500	2307.5	DFT-s-OFDM QPSK	1@1	22.37	23.37	0.2173
30	15	5	461500	2307.5	DFT-s-OFDM 16 QAM	1@1	20.98	21.98	0.1578
30	15	5	462000	2310	DFT-s-OFDM QPSK	1@1	22.33	23.33	0.2153
30	15	5	462000	2310	DFT-s-OFDM 16 QAM	1@1	20.97	21.97	0.1574
30	15	5	462500	2312.5	DFT-s-OFDM QPSK	1@1	22.35	23.35	0.2163
30	15	5	462500	2312.5	DFT-s-OFDM 16 QAM	1@1	20.97	21.97	0.1574
30	15	10	462000	2310	DFT-s-OFDM PI/2 BPSK	25@12	22.53	23.53	0.2254
30	15	10	462000	2310	DFT-s-OFDM PI/2 BPSK	1@1	22.13	23.13	0.2056
30	15	10	462000	2310	DFT-s-OFDM PI/2 BPSK	1@50	22.19	23.19	0.2084
30	15	10	462000	2310	DFT-s-OFDM QPSK	25@12	22.21	23.21	0.2094
30	15	10	462000	2310	DFT-s-OFDM QPSK	1@1	22.3	23.3	0.2138
30	15	10	462000	2310	DFT-s-OFDM QPSK	1@50	22.27	23.27	0.2123
30	15	10	462000	2310	DFT-s-OFDM 16 QAM	25@12	21.21	22.21	0.1663
30	15	10	462000	2310	DFT-s-OFDM 16 QAM	1@1	21.47	22.47	0.1766
30	15	10	462000	2310	DFT-s-OFDM 16 QAM	1@50	21.36	22.36	0.1722
30	15	10	462000	2310	DFT-s-OFDM 64 QAM	25@12	19.74	20.74	0.1186
30	15	10	462000	2310	DFT-s-OFDM 64 QAM	1@1	19.56	20.56	0.1138
30	15	10	462000	2310	DFT-s-OFDM 64 QAM	1@50	19.64	20.64	0.1159
30	15	10	462000	2310	DFT-s-OFDM 256 QAM	25@12	17.75	18.75	0.0750
30	15	10	462000	2310	DFT-s-OFDM 256 QAM	1@1	17.55	18.55	0.0716
30	15	10	462000	2310	DFT-s-OFDM 256 QAM	1@50	17.56	18.56	0.0718
30	15	10	462000	2310	CP-OFDM QPSK	26@13	20.7	21.7	0.1479
30	15	10	462000	2310	CP-OFDM QPSK	1@1	20.73	21.73	0.1489
30	15	10	462000	2310	CP-OFDM QPSK	1@50	20.65	21.65	0.1462

# FR1 N30 -SCS 30K

## Transmitter Conducted Output Power And EIRP, ( $G_T - L_C$ )=1dBi

NR Band	SCS	BandWidth	Arfcn	Freq(MHz)	Modulation	RB	Conducted Power(dBm)	EIRP(dBm)	EIRP(W)
30	30	10	462000	2310	DFT-s-OFDM PI/2 BPSK	12@6	22.32	23.32	0.2148
30	30	10	462000	2310	DFT-s-OFDM PI/2 BPSK	1@1	22.32	23.32	0.2148
30	30	10	462000	2310	DFT-s-OFDM PI/2 BPSK	1@22	22.21	23.21	0.2094
30	30	10	462000	2310	DFT-s-OFDM QPSK	12@6	22.37	23.37	0.2173
30	30	10	462000	2310	DFT-s-OFDM QPSK	1@1	22.23	23.23	0.2104
30	30	10	462000	2310	DFT-s-OFDM QPSK	1@22	22.11	23.11	0.2046
30	30	10	462000	2310	DFT-s-OFDM 16 QAM	12@6	21.4	22.4	0.1738
30	30	10	462000	2310	DFT-s-OFDM 16 QAM	1@1	21.45	22.45	0.1758
30	30	10	462000	2310	DFT-s-OFDM 16 QAM	1@22	21.37	22.37	0.1726
30	30	10	462000	2310	DFT-s-OFDM 64 QAM	12@6	19.99	20.99	0.1256
30	30	10	462000	2310	DFT-s-OFDM 64 QAM	1@1	19.67	20.67	0.1167
30	30	10	462000	2310	DFT-s-OFDM 64 QAM	1@22	19.59	20.59	0.1146
30	30	10	462000	2310	DFT-s-OFDM 256 QAM	12@6	17.98	18.98	0.0791
30	30	10	462000	2310	DFT-s-OFDM 256 QAM	1@1	17.64	18.64	0.0731
30	30	10	462000	2310	DFT-s-OFDM 256 QAM	1@22	17.57	18.57	0.0719
30	30	10	462000	2310	CP-OFDM QPSK	12@6	20.76	21.76	0.1500
30	30	10	462000	2310	CP-OFDM QPSK	1@1	20.83	21.83	0.1524
30	30	10	462000	2310	CP-OFDM QPSK	1@22	20.69	21.69	0.1476

# FR1 N30 -SCS 30K

## Frequency Stability

NR Band	SCS (kHz)	Bandwidth (MHz)	Arfcn	Freq (MHz)	Modulation	RB	Deviation (ppm)	Verdict	Environment
30	15	10	462000	2310.0	DFT-s-OFDM QPSK	50@0	0.0029	PASS	NV
30	15	10	462000	2310.0	DFT-s-OFDM QPSK	50@0	0.0057	PASS	LV
30	15	10	462000	2310.0	DFT-s-OFDM QPSK	50@0	0.0055	PASS	HV
30	15	10	462000	2310.0	DFT-s-OFDM QPSK	50@0	0.0031	PASS	-30°C
30	15	10	462000	2310.0	DFT-s-OFDM QPSK	50@0	0.0041	PASS	-20°C
30	15	10	462000	2310.0	DFT-s-OFDM QPSK	50@0	0.0051	PASS	-10°C
30	15	10	462000	2310.0	DFT-s-OFDM QPSK	50@0	0.0035	PASS	0°C
30	15	10	462000	2310.0	DFT-s-OFDM QPSK	50@0	0.0066	PASS	10°C
30	15	10	462000	2310.0	DFT-s-OFDM QPSK	50@0	0.0029	PASS	20°C
30	15	10	462000	2310.0	DFT-s-OFDM QPSK	50@0	0.0030	PASS	30°C
30	15	10	462000	2310.0	DFT-s-OFDM QPSK	50@0	0.0036	PASS	40°C
30	15	10	462000	2310.0	DFT-s-OFDM QPSK	50@0	0.0028	PASS	50°C

# Peak to Average Ratio

NR Band	SCS (kHz)	Bandwidth (MHz)	Arfcn	Freq (MHz)	Modulation	RB	Result (dB)	Limit (dB)	Verdict
30	15	10	462000	2310.0	DFT-s-OFDM PI/2 BPSK	50@0	4.01	13	PASS
30	15	10	462000	2310.0	DFT-s-OFDM QPSK	50@0	5.05	13	PASS

N30(10M)\_DFT-s-OFDM\_PI\_2-BPSK\_Outer\_Full\_Low\_CH



N30(10M)\_DFT-s-OFDM\_QPSK\_Outer\_Full\_Low\_CH

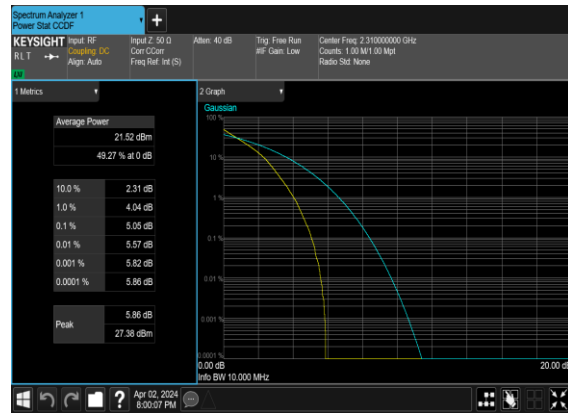

## Occupied Bandwidth

NR Band	SCS (kHz)	Bandwidth (MHz)	Arfcn	Freq (MHz)	Modulation	RB	OBW (MHz)	26dB BW (MHz)
30	15	5	462000	2310.0	CP-OFDM QPSK	25@0	4.4652	5.04
30	15	5	462000	2310.0	CP-OFDM 16 QAM	25@0	4.4695	4.922
30	15	5	462000	2310.0	CP-OFDM 64 QAM	25@0	4.4614	4.83
30	15	5	462000	2310.0	CP-OFDM 256 QAM	25@0	4.4619	4.78
30	15	10	462000	2310.0	CP-OFDM QPSK	52@0	9.2718	9.817
30	15	10	462000	2310.0	CP-OFDM 16 QAM	52@0	9.2933	9.859
30	15	10	462000	2310.0	CP-OFDM 64 QAM	52@0	9.2852	9.754
30	15	10	462000	2310.0	CP-OFDM 256 QAM	52@0	9.2755	9.747

### N30(5M)\_CP-OFDM\_QPSK\_Outer\_Full\_Mid\_CH



### N30(5M)\_CP-OFDM\_16QAM\_Outer\_Full\_Mid\_CH

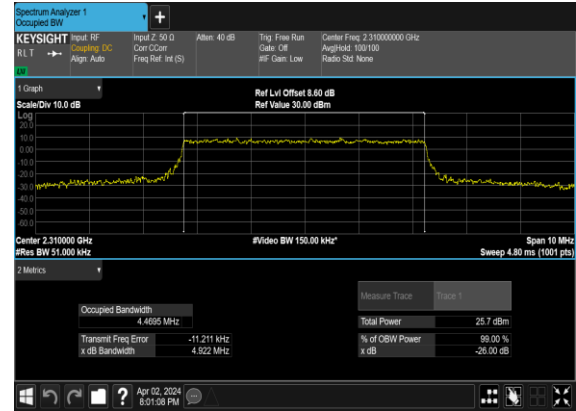

### N30(5M)\_CP-OFDM\_64QAM\_Outer\_Full\_Mid\_CH

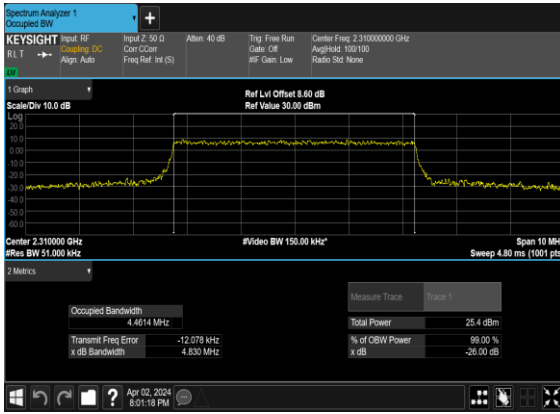

### N30(5M)\_CP-OFDM\_256QAM\_Outer\_Full\_Mid\_CH



### N30(10M)\_CP-OFDM\_QPSK\_Outer\_Full\_Low\_CH

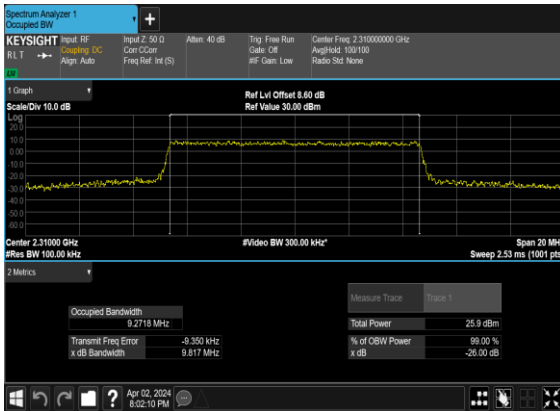

### N30(10M)\_CP-OFDM\_16QAM\_Outer\_Full\_Low\_CH

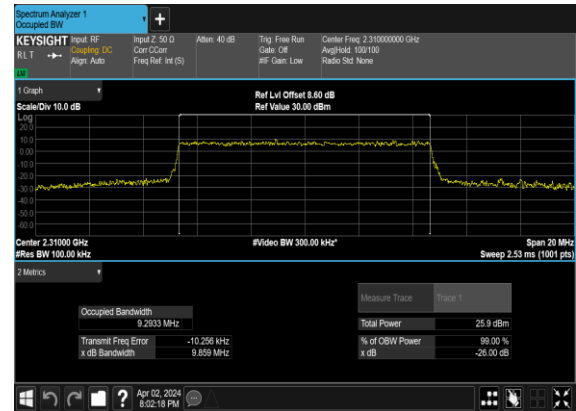

## N30(10M)\_CP-OFDM\_64 QAM\_Outer\_Full\_Low\_CH

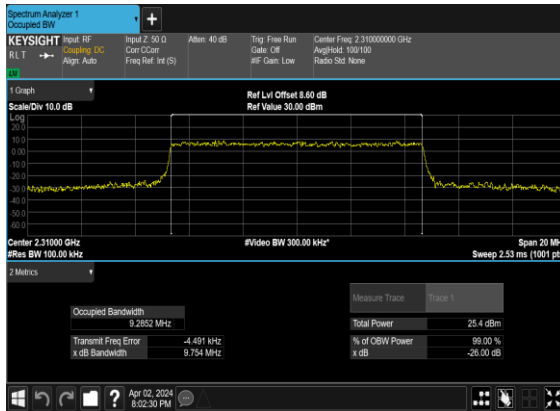

## N30(10M)\_CP-OFDM\_256 QAM\_Outer\_Full\_Low\_CH

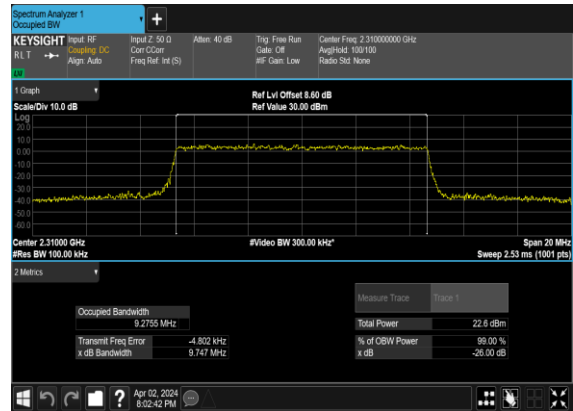

## Conducted Spurious Emissions

NR Band	SCS (kHz)	Bandwidth (MHz)	Arfcn	Freq (MHz)	Modulation	RB	Result	Verdict
30	15	5	461500	2307.5	DFT-s-OFDM BPSK	1@0	see graph	---
30	15	5	461500	2307.5	DFT-s-OFDM BPSK	1@0	see graph	<b>PASS</b>
30	15	5	461500	2307.5	DFT-s-OFDM BPSK	1@0	see graph	<b>PASS</b>
30	15	5	461500	2307.5	DFT-s-OFDM QPSK	1@0	see graph	---
30	15	5	461500	2307.5	DFT-s-OFDM QPSK	1@0	see graph	<b>PASS</b>
30	15	5	461500	2307.5	DFT-s-OFDM QPSK	1@0	see graph	<b>PASS</b>
30	15	5	462000	2310.0	DFT-s-OFDM BPSK	1@0	see graph	---
30	15	5	462000	2310.0	DFT-s-OFDM BPSK	1@0	see graph	<b>PASS</b>
30	15	5	462000	2310.0	DFT-s-OFDM BPSK	1@0	see graph	<b>PASS</b>
30	15	5	462000	2310.0	DFT-s-OFDM QPSK	1@0	see graph	---
30	15	5	462000	2310.0	DFT-s-OFDM QPSK	1@0	see graph	<b>PASS</b>
30	15	5	462000	2310.0	DFT-s-OFDM QPSK	1@0	see graph	<b>PASS</b>
30	15	5	462500	2312.5	DFT-s-OFDM BPSK	1@0	see graph	---
30	15	5	462500	2312.5	DFT-s-OFDM BPSK	1@0	see graph	<b>PASS</b>
30	15	5	462500	2312.5	DFT-s-OFDM BPSK	1@0	see graph	<b>PASS</b>
30	15	5	462500	2312.5	DFT-s-OFDM QPSK	1@0	see graph	---
30	15	5	462500	2312.5	DFT-s-OFDM QPSK	1@0	see graph	<b>PASS</b>
30	15	5	462500	2312.5	DFT-s-OFDM QPSK	1@0	see graph	<b>PASS</b>
30	15	10	462000	2310.0	DFT-s-OFDM BPSK	1@0	see graph	---
30	15	10	462000	2310.0	DFT-s-OFDM BPSK	1@0	see graph	<b>PASS</b>
30	15	10	462000	2310.0	DFT-s-OFDM BPSK	1@0	see graph	<b>PASS</b>
30	15	10	462000	2310.0	DFT-s-OFDM QPSK	1@0	see graph	---
30	15	10	462000	2310.0	DFT-s-OFDM QPSK	1@0	see graph	<b>PASS</b>
30	15	10	462000	2310.0	DFT-s-OFDM QPSK	1@0	see graph	<b>PASS</b>
30	15	10	462000	2310.0	DFT-s-OFDM BPSK	1@0	see graph	---



### N30(5M)\_DFT-s-OFDM\_BPSK\_Edge\_1RB\_Left\_Low\_CH

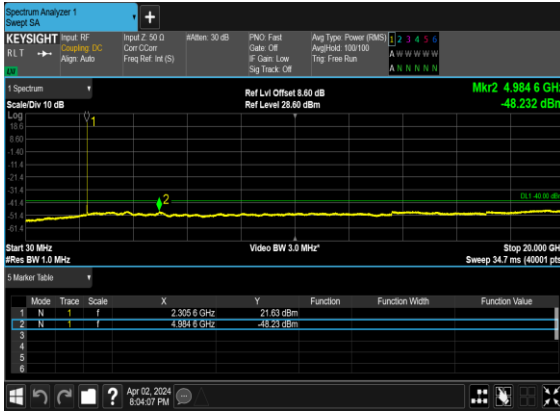

### N30(5M)\_DFT-s-OFDM\_BPSK\_Edge\_1RB\_Left\_Low\_CH

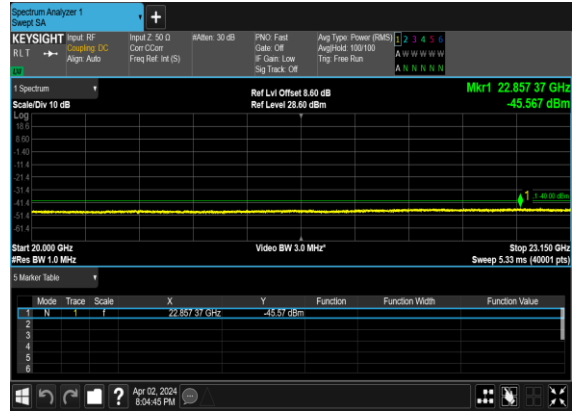

### N30(5M)\_DFT-s-OFDM\_QPSK\_Edge\_1RB\_Left\_Low\_CH

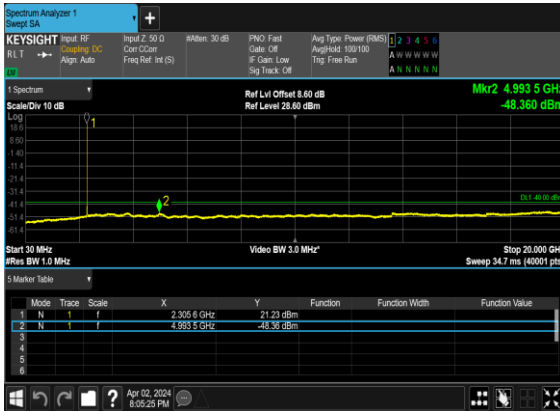

### N30(5M)\_DFT-s-OFDM\_QPSK\_Edge\_1RB\_Left\_Low\_CH

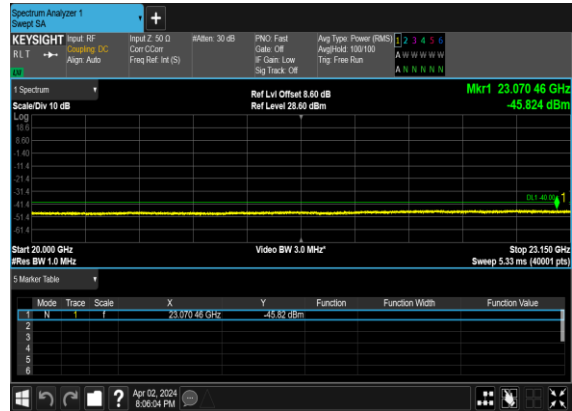

### N30(5M)\_DFT-s-OFDM\_BPSK\_Edge\_1RB\_Left\_Mid\_CH

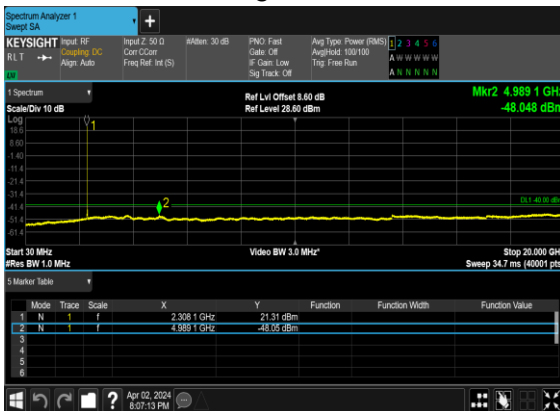

### N30(5M)\_DFT-s-OFDM\_BPSK\_Edge\_1RB\_Left\_Mid\_CH

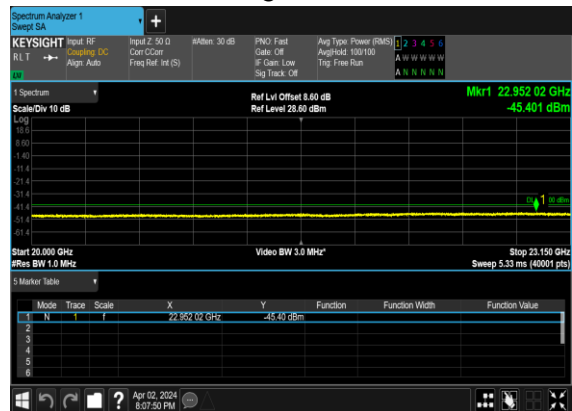

### N30(5M)\_DFT-s-OFDM\_QPSK\_Edge\_1RB\_Left\_Mid\_CH



### N30(5M)\_DFT-s-OFDM\_QPSK\_Edge\_1RB\_Left\_Mid\_CH

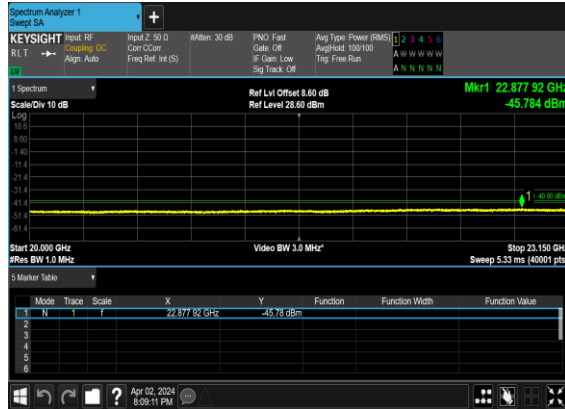

### N30(5M)\_DFT-s-OFDM\_BPSK\_Edge\_1RB\_Left\_High\_CH

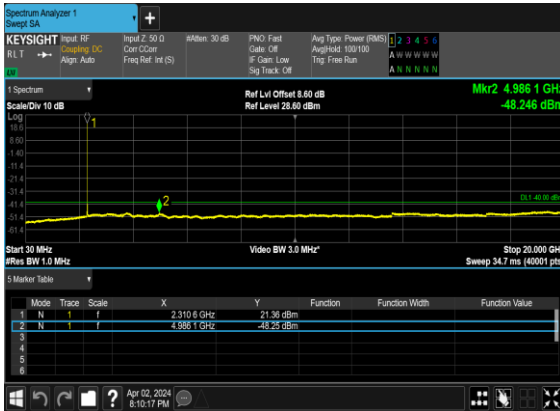

### N30(5M)\_DFT-s-OFDM\_BPSK\_Edge\_1RB\_Left\_High\_CH



### N30(5M)\_DFT-s-OFDM\_QPSK\_Edge\_1RB\_Left\_High\_CH

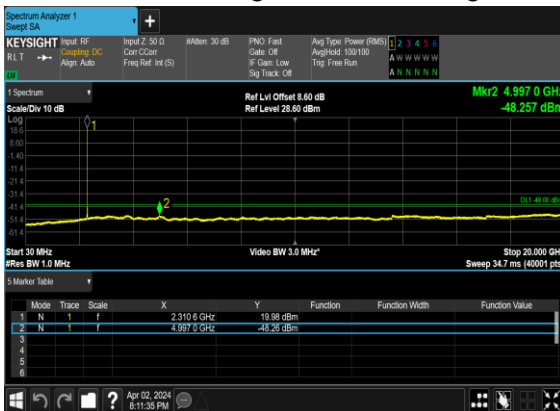

### N30(5M)\_DFT-s-OFDM\_QPSK\_Edge\_1RB\_Left\_High\_CH

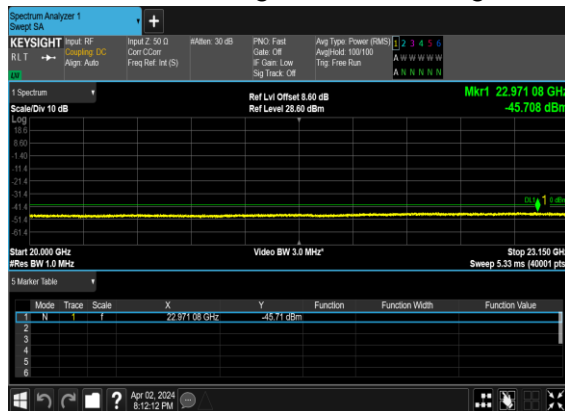

### N30(10M)\_DFT-s-OFDM\_BPSK\_Edge\_1RB\_Left\_Low\_CH



### N30(10M)\_DFT-s-OFDM\_BPSK\_Edge\_1RB\_Left\_Low\_CH

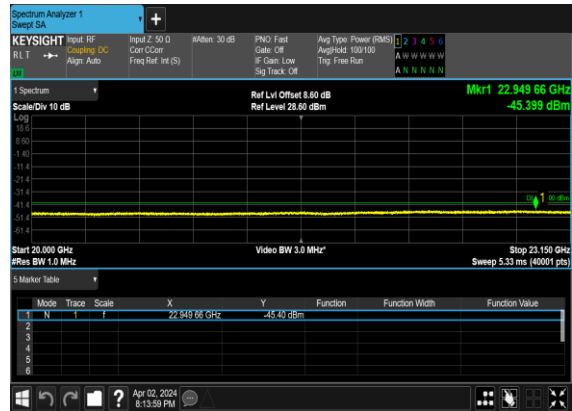

### N30(10M)\_DFT-s-OFDM\_QPSK\_Edge\_1RB\_Left\_Low\_CH



### N30(10M)\_DFT-s-OFDM\_QPSK\_Edge\_1RB\_Left\_Low\_CH



## Conducted Band Edge

NR Band	SCS (kHz)	Bandwidth (MHz)	Arfcn	Freq (MHz)	Modulation	RB	Result	Verdict
30	15	5	461500	2307.5	DFT-s-OFDM BPSK	1@0	see graph	PASS
30	15	5	461500	2307.5	DFT-s-OFDM QPSK	1@0	see graph	PASS
30	15	5	461500	2307.5	DFT-s-OFDM BPSK	25@0	see graph	PASS
30	15	5	461500	2307.5	DFT-s-OFDM QPSK	25@0	see graph	PASS
30	15	5	462500	2312.5	DFT-s-OFDM BPSK	1@24	see graph	PASS
30	15	5	462500	2312.5	DFT-s-OFDM QPSK	1@24	see graph	PASS
30	15	5	462500	2312.5	DFT-s-OFDM BPSK	25@0	see graph	PASS
30	15	5	462500	2312.5	DFT-s-OFDM QPSK	25@0	see graph	PASS
30	15	10	462000	2310.0	DFT-s-OFDM BPSK	1@0	see graph	PASS
30	15	10	462000	2310.0	DFT-s-OFDM QPSK	1@0	see graph	PASS
30	15	10	462000	2310.0	DFT-s-OFDM BPSK	1@51	see graph	PASS
30	15	10	462000	2310.0	DFT-s-OFDM QPSK	1@51	see graph	PASS
30	15	10	462000	2310.0	DFT-s-OFDM BPSK	50@0	see graph	PASS
30	15	10	462000	2310.0	DFT-s-OFDM QPSK	50@0	see graph	PASS

### N30(5M)\_DFT-s-OFDM\_BPSK\_Edge\_1RB\_Left\_Low\_CH

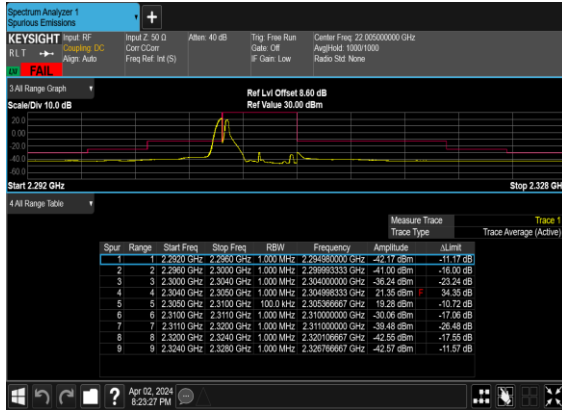

### N30(5M)\_DFT-s-OFDM\_BPSK\_Edge\_1RB\_Left\_Low\_CH\_CHP\_PASS



### N30(5M)\_DFT-s-OFDM\_QPSK\_Edge\_1RB\_Left\_Low\_CH



### N30(5M)\_DFT-s-OFDM\_QPSK\_Edge\_1RB\_Left\_Low\_CH\_CHP\_PASS



### N30(5M)\_DFT-s-OFDM\_BPSK\_Outer\_Full\_Low\_CH

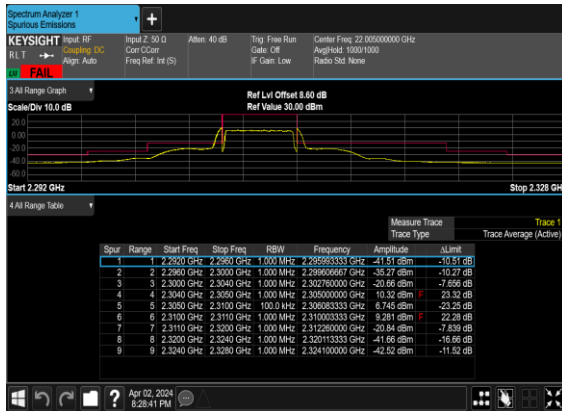

### N30(5M)\_DFT-s-OFDM\_BPSK\_Outer\_Full\_Low\_CH\_CHP\_PASS

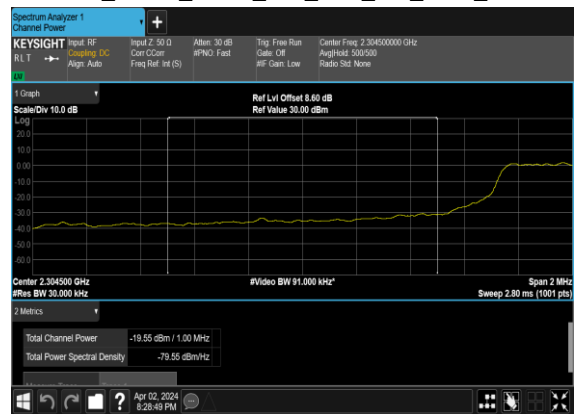

### N30(5M)\_DFT-s-OFDM\_BPSK\_Outer\_Full\_Low\_CH\_CHP\_PASS

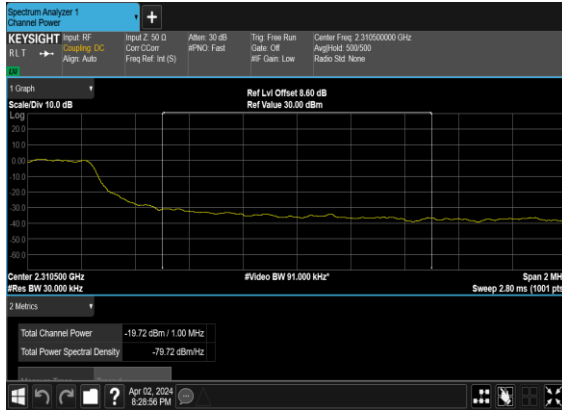

### N30(5M)\_DFT-s-OFDM\_QPSK\_Outer\_Full\_Low\_CH



### N30(5M)\_DFT-s-OFDM\_QPSK\_Outer\_Full\_Low\_CH\_CHP\_PASS

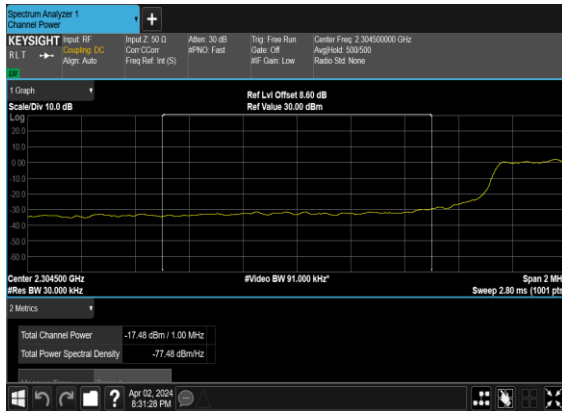

### N30(5M)\_DFT-s-OFDM\_QPSK\_Outer\_Full\_Low\_CH\_CHP\_PASS

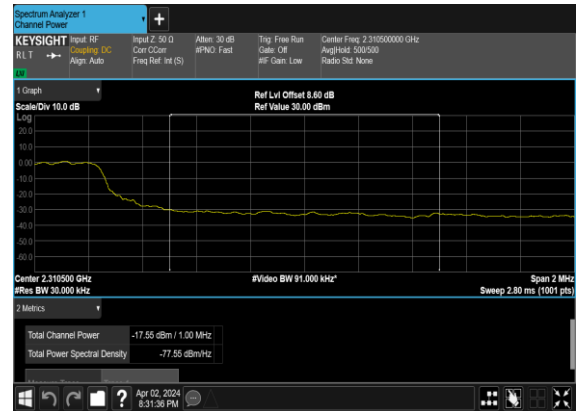

### N30(5M)\_DFT-s-OFDM\_BPSK\_Edge\_1RB\_Right\_High\_CH

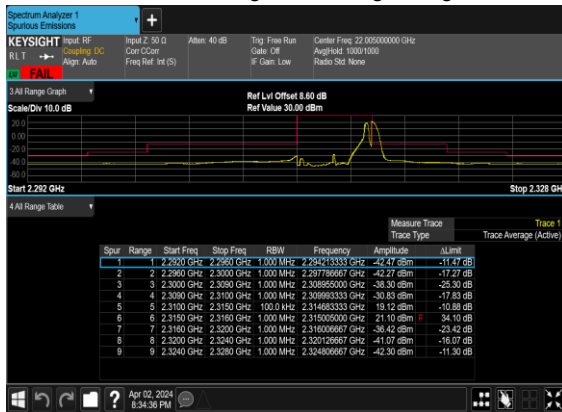

### N30(5M)\_DFT-s-OFDM\_BPSK\_Edge\_1RB\_Right\_High\_CH\_CHP\_PASS

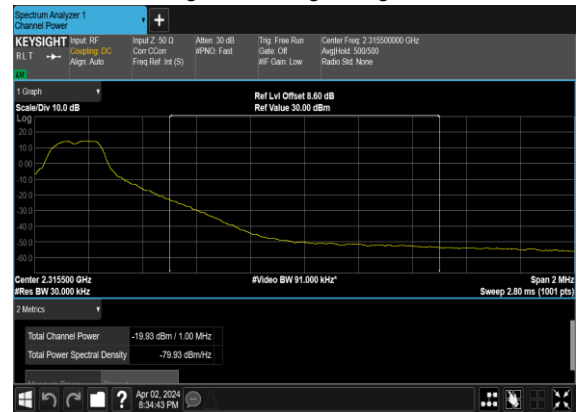

### N30(5M)\_DFT-s-OFDM\_QPSK\_Edge\_1RB\_Right\_High\_CH



### N30(5M)\_DFT-s-OFDM\_QPSK\_Edge\_1RB\_Right\_High\_CH\_CHP\_PASS



### N30(5M)\_DFT-s-OFDM\_BPSK\_Outer\_Full\_High\_CH

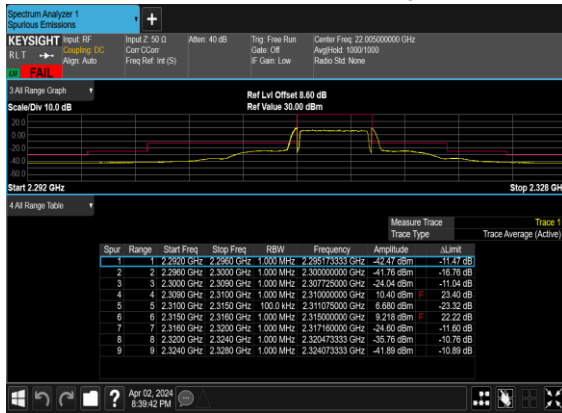

### N30(5M)\_DFT-s-OFDM\_BPSK\_Outer\_Full\_High\_CH\_CHP\_PASS

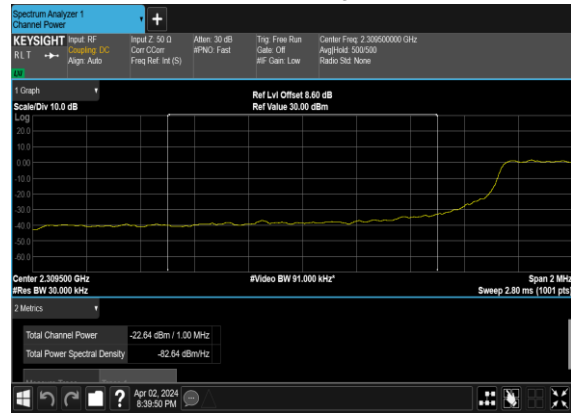

### N30(5M)\_DFT-s-OFDM\_BPSK\_Outer\_Full\_High\_CH\_CHP\_PASS

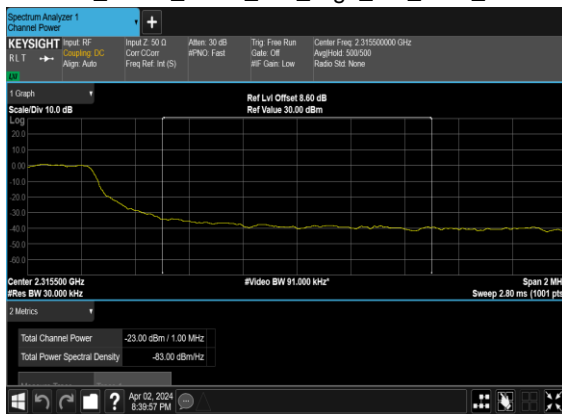

### N30(5M)\_DFT-s-OFDM\_QPSK\_Outer\_Full\_High\_CH

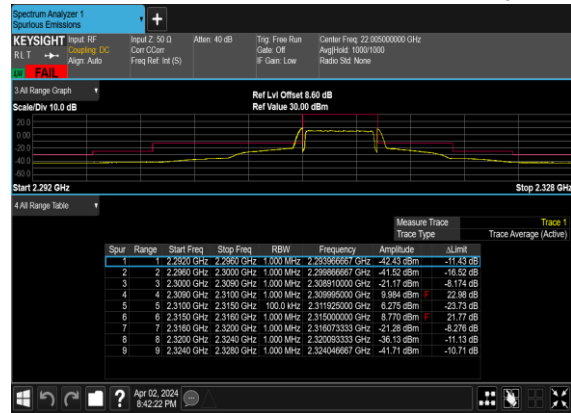

### N30(5M)\_DFT-s-OFDM\_QPSK\_Outer\_Full\_High\_CH\_CHP\_PASS

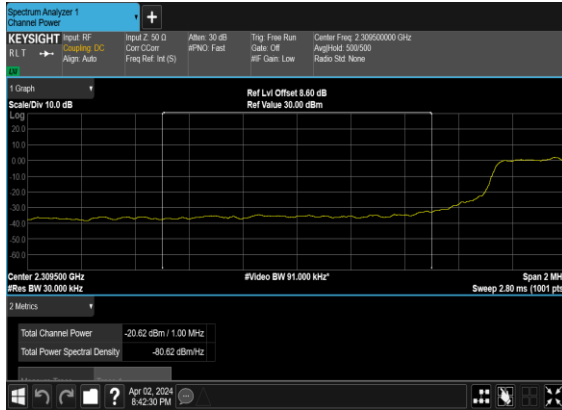

### N30(5M)\_DFT-s-OFDM\_QPSK\_Outer\_Full\_High\_CH\_CHP\_PASS

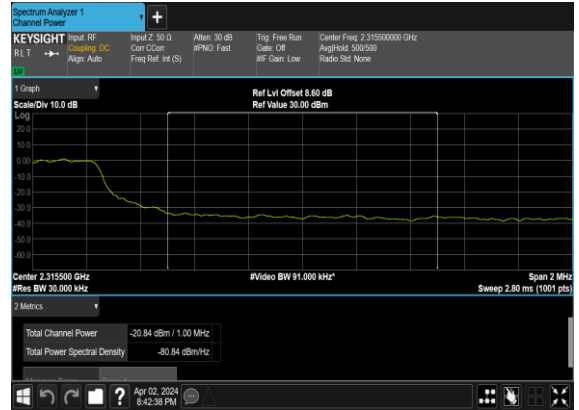

### N30(10M)\_DFT-s-OFDM\_BPSK\_Edge\_1RB\_Left\_Low\_CH

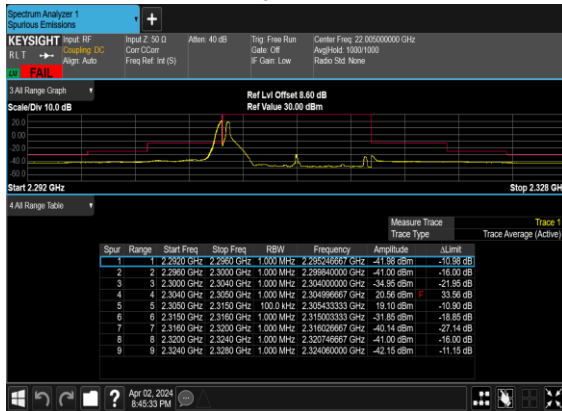

### N30(10M)\_DFT-s-OFDM\_BPSK\_Edge\_1RB\_Left\_Low\_CH\_CHP\_PASS

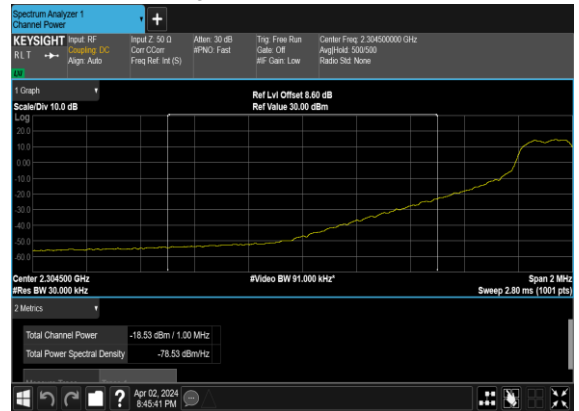

### N30(10M)\_DFT-s-OFDM\_QPSK\_Edge\_1RB\_Left\_Low\_CH



### N30(10M)\_DFT-s-OFDM\_QPSK\_Edge\_1RB\_Left\_Low\_CH\_CHP\_PASS





### N30(10M)\_DFT-s-OFDM\_BPSK\_Edge\_1RB\_Right\_Low\_CH



### N30(10M)\_DFT-s-OFDM\_BPSK\_Edge\_1RB\_Right\_Low\_CH\_CHP\_PASS

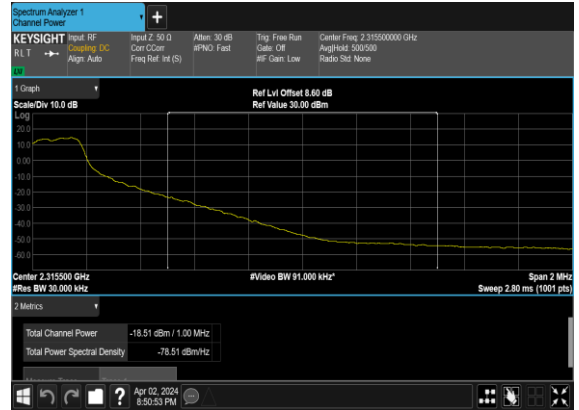

### N30(10M)\_DFT-s-OFDM\_QPSK\_Edge\_1RB\_Right\_Low\_CH

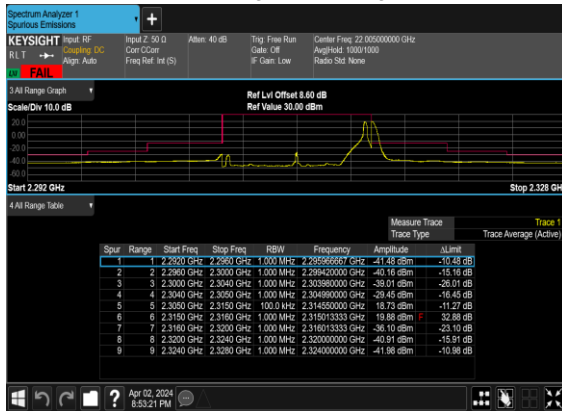

### N30(10M)\_DFT-s-OFDM\_QPSK\_Edge\_1RB\_Right\_Low\_CH\_CHP\_PASS

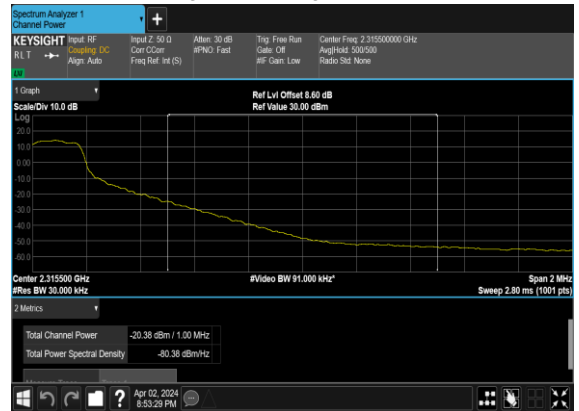

### N30(10M)\_DFT-s-OFDM\_BPSK\_Outer\_Full\_Low\_CH

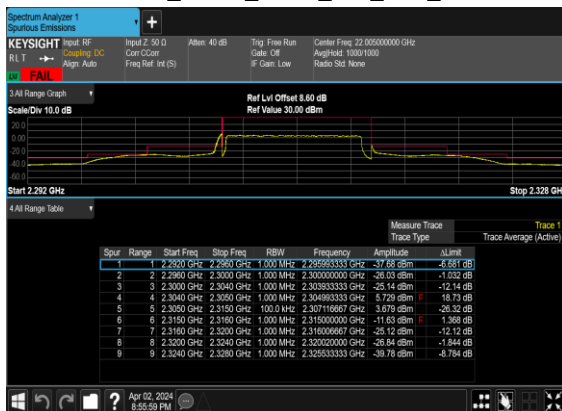

### N30(10M)\_DFT-s-OFDM\_BPSK\_Outer\_Full\_Low\_CH\_CHP\_PASS

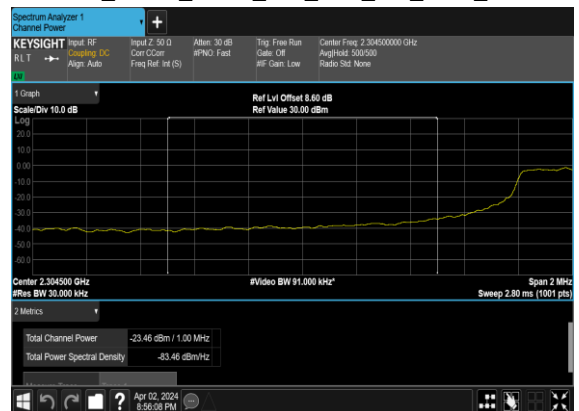

N30(10M)\_DFT-s-  
OFDM\_BPSK\_Outer\_Full\_Low\_CH\_CHP\_PASS

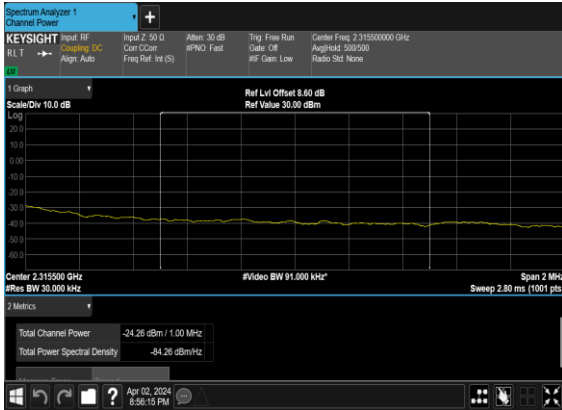

N30(10M)\_DFT-s-OFDM\_QPSK\_Outer\_Full\_Low\_CH

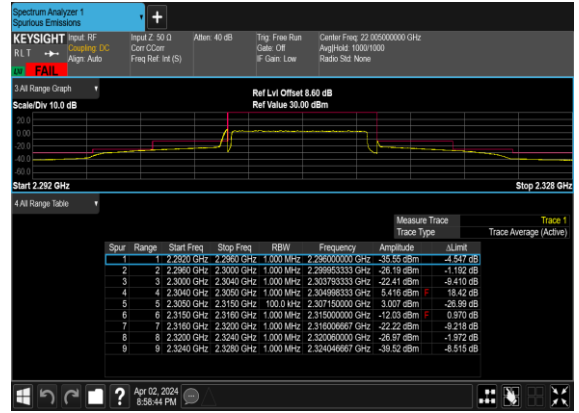

N30(10M)\_DFT-s-  
OFDM\_QPSK\_Outer\_Full\_Low\_CH\_CHP\_PASS

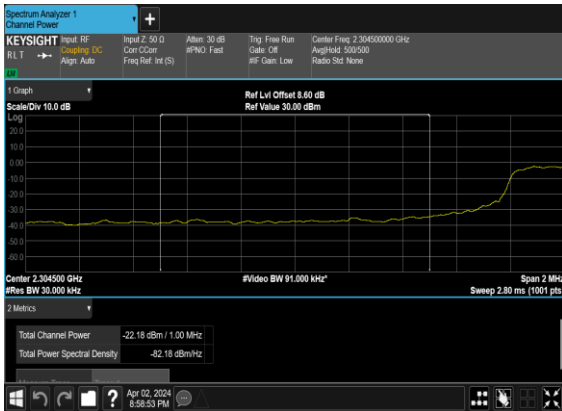

N30(10M)\_DFT-s-  
OFDM\_QPSK\_Outer\_Full\_Low\_CH\_CHP\_PASS



Note: "CHP" means channel power integrated method.



## Appendix B. Test Results of Radiated Test

### Radiated Spurious Emission

Test Engineer :	HuaCong Liang	Temperature :	22~25°C
		Relative Humidity :	48~52%

SA n30 / NR 5MHz / QPSK / Sample 1 & Monopole Antenna									
Channel	Frequency ( MHz )	EIRP ( dBm )	Limit ( dBm )	Over Limit ( dB )	SPA Reading (dBm)	S.G. Power ( dBm )	TX Cable loss ( dB )	TX Antenna Gain (dBi)	Polarization (H/V)
Lowest	4610.50	-59.09	-40	-19.09	-64.04	-65.34	6.30	12.55	H
	6915.75	-58.80	-40	-18.80	-66.30	-62.20	8.25	11.65	H
	9221.00	-59.00	-40	-19.00	-68.52	-61.35	9.50	11.85	H
	4610.50	-59.04	-40	-19.04	-64.12	-65.29	6.30	12.55	V
	6915.75	-57.48	-40	-17.48	-66.08	-60.88	8.25	11.65	V
	9221.00	-56.48	-40	-16.48	-68.23	-58.83	9.50	11.85	V
Middle	4615.50	-58.15	-40	-18.15	-63.08	-64.40	6.45	12.70	H
	6923.25	-57.92	-40	-17.92	-65.42	-61.32	8.40	11.80	H
	9231.00	-58.02	-40	-18.02	-67.54	-60.37	9.65	12.00	H
	4615.50	-58.26	-40	-18.26	-63.35	-64.51	6.45	12.70	V
	6923.25	-57.00	-40	-17.00	-65.6	-60.40	8.40	11.80	V
	9231.00	-55.82	-40	-15.82	-67.57	-58.17	9.65	12.00	V
Highest	4620.50	-58.53	-40	-18.53	-63.46	-64.78	6.61	12.86	H
	6930.75	-58.86	-40	-18.86	-66.41	-62.24	8.56	11.94	H
	9241.00	-58.70	-40	-18.70	-68.27	-61.05	9.81	12.16	H
	4620.50	-58.52	-40	-18.52	-63.61	-64.77	6.61	12.86	V
	6930.75	-57.75	-40	-17.75	-66.22	-61.13	8.56	11.94	V
	9241.00	-56.38	-40	-16.38	-68.1	-58.73	9.81	12.16	V

Remark: Spurious emissions within 30-1000MHz were found more than 20dB below limit line.

SA n30 / NR 10MHz / QPSK / Sample 1 & Monopole Antenna									
Channel	Frequency ( MHz )	EIRP ( dBm )	Limit ( dBm )	Over Limit ( dB )	SPA Reading (dBm)	S.G. Power ( dBm )	TX Cable loss ( dB )	TX Antenna Gain (dBi)	Polarization (H/V)
Middle	4611.00	-59.25	-40	-19.25	-64.20	-65.50	6.45	12.70	H
	6916.50	-58.84	-40	-18.84	-66.34	-62.24	8.40	11.80	H
	9222.00	-58.92	-40	-18.92	-68.44	-61.27	9.65	12.00	H
	4611.00	-58.73	-40	-18.73	-63.81	-64.98	6.45	12.70	V
	6916.50	-57.75	-40	-17.75	-66.35	-61.15	8.40	11.80	V
	9222.00	-56.48	-40	-16.48	-68.23	-58.83	9.65	12.00	V

Remark: Spurious emissions within 30-1000MHz were found more than 20dB below limit line.



SA n30 / NR 10MHz / QPSK / Sample 2 & Monopole Antenna									
Channel	Frequency ( MHz )	EIRP ( dBm )	Limit ( dBm )	Over Limit ( dB )	SPA Reading (dBm)	S.G. Power ( dBm )	TX Cable loss ( dB )	TX Antenna Gain (dBi)	Polarization (H/V)
Middle	4615.50	-59.00	-40	-19.00	-63.93	-65.25	6.45	12.70	H
	6923.25	-58.48	-40	-18.48	-65.98	-61.88	8.40	11.80	H
	9231.00	-58.62	-40	-18.62	-68.14	-60.97	9.65	12.00	H
	4615.50	-58.82	-40	-18.82	-63.91	-65.07	6.45	12.70	V
	6923.25	-57.31	-40	-17.31	-65.91	-60.71	8.40	11.80	V
	9231.00	-56.68	-40	-16.68	-68.43	-59.03	9.65	12.00	V

Remark: Spurious emissions within 30-1000MHz were found more than 20dB below limit line.