

GUIDING MANUAL

Thank you for your purchasing. Honestly wish you can enjoy the high-quality service from Tabler Systems Inc. Please carefully read the Guiding Manual BEFORE using the device.

- This device is regularly updated according to feedbacks from customers. Therefore, there may be some differences on the screen display and diagrammatize.
- Must restrictively follow the awareness and restrictions.
- For more products of TTV, please go to the official website – <http://cn.ttv.co>.

CATALOG

- (1) Packing List
- (2) Instruction for Installation
- (3) Connecting to A Computer
- (4) FCC Statement

◆ PACKING LIST

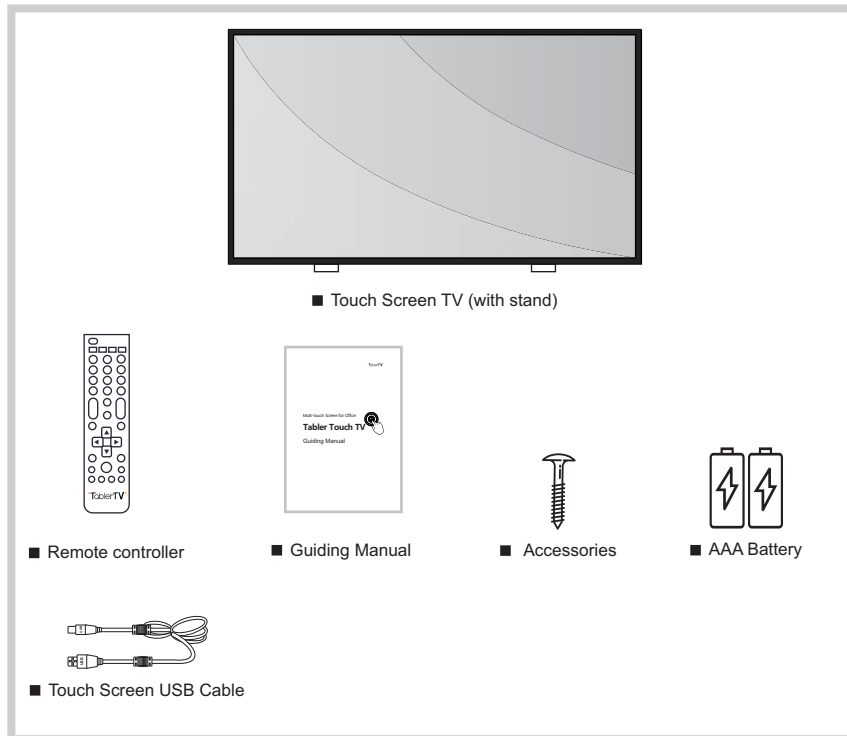

◆ INSTRUCTION FOR INSTALLATION

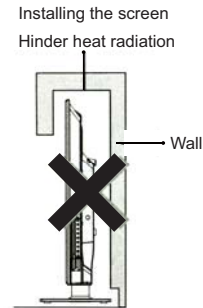

- **Notice:**
- Do not cover or insert anything into the ventilation opening.
 - Keep certain space around the device for heat radiation.
 - The TV should be used more than 20cm from your body
 - Environment temperature: -10°C to 50°C

- **Avoidance for Setting:**
- Please keep this device away from mechanical shake;
 - Please avoid insects into this device;
 - Please keep this device away from setting in front of air condition for preventing screen panel freezing;
 - Please keep this device away from electromagnetic field against interference of electromagnetic wave.

★ Installing on stands

1. Disconnect all the cables with this device;
2. Place your touch screen TV carefully onto a flat stable desk with the backside up;
3. Put the left and right stands upon its bottom side, fasten the screws onto each stand and make sure it's stable.

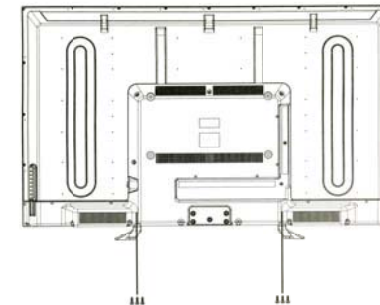

T65MH : 4*23BMH X 3 4*23BMH X 3

INSTRUCTIONAL DIAGRAM

★ Wall Mounting

Please keep certain space for this device as the diagram.

65" – 400*400mm

Note: please use M6*12 screws for mounting on wall.

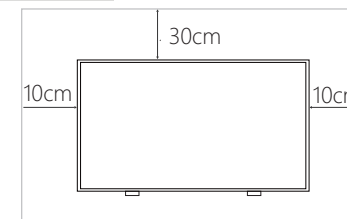

Declaration of Conformity

Hereby Tabler Systems Inc declares that this TTV-65MH (hardware version:TTV65MH-V2.1.0) is in compliance with the essential requirements and other relevant provisions of Directive 1999/5/EC.

CE 2280

Manufacturer
Tabler Systems Inc.
Address:
Room A6646, No.180, South changjiang Road, baoshan District, Shanghai, China

Multi-touch Screen for Office

Tabler Touch TV



Model: TTV-65MH

Guiding Manual



2.4 Tap "Connect" to start casting your laptop screen to your touch screen TV

3. Connecting with an external PC

You can use an external PC with your touch screen TV, just few steps: led in the built-in android system. Except the USB interface and HDMI interface, the other external interfaces of the monitor are unusable.

3.1 Connect USB & HDMI cable with your PC and the touch screen TV

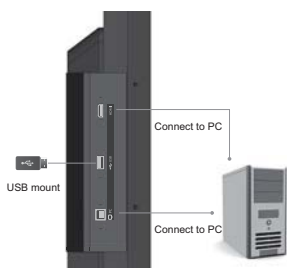

INSTALLATION DIAGRAM OF SIDE PANEL

3.2 Turn to HDMI 3 in your touch screen TV

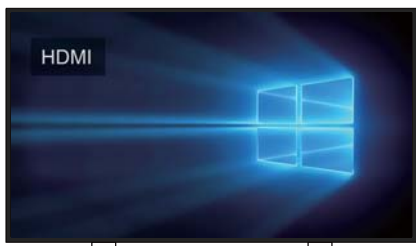

3.2 Turn to HDMI 3 in your touch screen TV

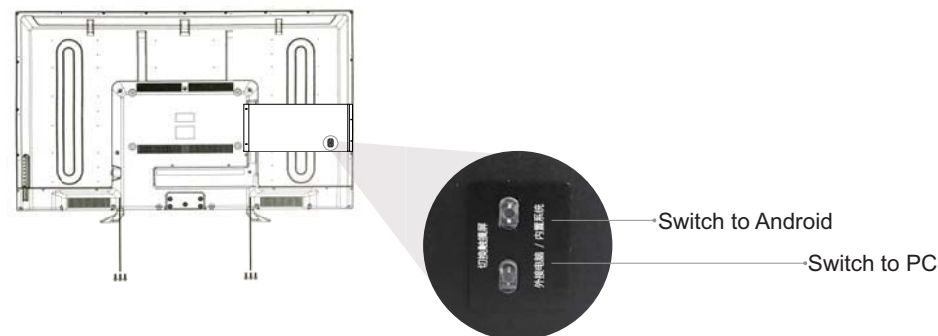

◆ FCC STATEMENT

FCC identification number is not visible when the device is installed inside another device, then the outside of the device into which the device is installed must also display a label referring to the enclosed device. This exterior label can use wording such as the following: "FCC ID: 2AJU-TTV-65MH" This device complies with part 15 of the FCC Rules. Operation is subject to the following two conditions:

- (1) This device may not cause harmful interference, and
- (2) This device must accept any interference received, including interference that may cause undesired operation.

Changes or modifications not expressly approved by the party responsible for compliance could void the user's authority to operate the equipment.

NOTE: This equipment has been tested and found to comply with the limits for a Class B digital device, pursuant to Part 15 of the FCC Rules. These limits are designed to provide reasonable protection against harmful interference in a residential installation. This equipment generates, uses and can radiate radio frequency energy and, if not installed and used in accordance with the instructions, may cause harmful interference to radio communications. However, there is no guarantee that interference will not occur in a particular installation. If this equipment does cause harmful interference to radio or television reception, which can be determined by turning the equipment off and on, the user is encouraged to try to correct the interference by one or more of the following measures:

- Reorient or relocate the receiving antenna.
- Increase the separation between the equipment and receiver.
- Connect the equipment into an outlet on a circuit different from that to which the receiver is connected.
- Consult the dealer or an experienced radio/TV technician for help.

FCC Radiation Exposure Statement

This device complies with FCC RF radiation exposure limits set forth for an uncontrolled environment. This transmitter must not be co-located or operating in conjunction with any other antenna or transmitter. This device must be installed and operated with a minimum distance of 20 cm between the radiator and user body.

◆ USING TOUCH SCREEN TV

1. Using MagicBoard Software (V2.1.0)

MagicBoard is a interactive whiteboard app pre-installed in the built-in android system.

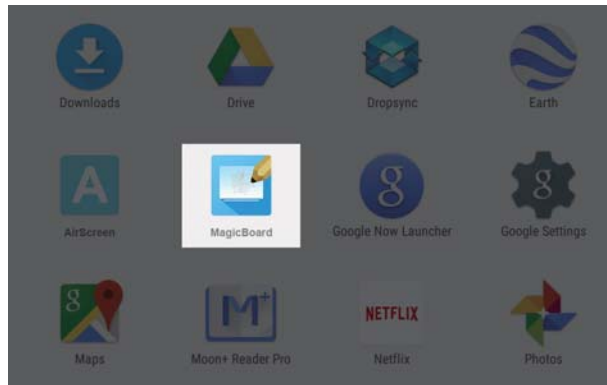

1.1 Tap the MagicBoard icon in the app drawer.



1.2 You can sketch or draw with your finger or a whiteboard pen.



1.3 Switch between 5 different boards in the bottom of the screen.

2. Cast your Laptop Screen to Touch Screen TV Wirelessly

AirScreen casts your laptop screen to the touch screen wirelessly. pre-installed in the built-in android system. The antenna of WIFI is on distance of 5 CMs to the touch screen surface.

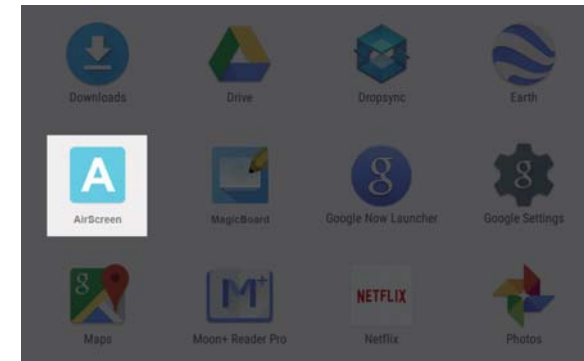

2.1 Tap the AirScreen icon in the app drawer.

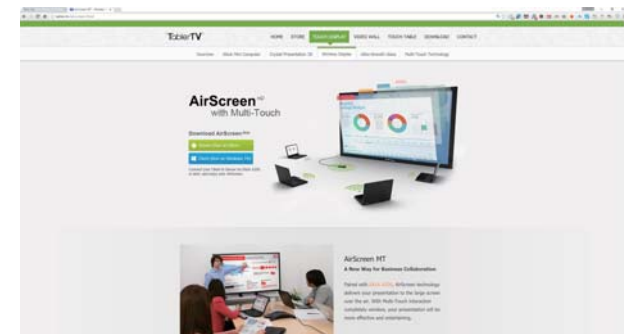

2.2 Download & install AirScreen Client app from



2.3 Make sure your touch screen TV is connect to the same network as your laptop;