

TEST REPORT

Applicant: PO FUNG ELECTRONIC (HK) INTERNATIONAL GROUP
COMPANY LIMITED

Address: Room 1508, 15/F, Office Tower II, Grand Plaza, 625 Nathan Road,
Kowloon, Hong Kong

Product Name: FRS Two Way Radio

FCC ID: 2AJGM-T26

Standard(s): 47 CFR Part 2(2.1093)

Report Number: 2402S45429E-20A

Report Date: 2024/6/18

The above device has been tested and found compliant with the requirement of the relative standards by Bay Area Compliance Laboratories Corp. (Dongguan).

Mark Dong

Brave Lu

Reviewed By: Mark Dong

Approved By: Brave Lu

Title: SAR Engineer

Title: SAR Engineer

Bay Area Compliance Laboratories Corp. (Dongguan)
No.12, Pulong East 1st Road, Tangxia Town, Dongguan, Guangdong, China

Tel: +86-769-86858888

Fax: +86-769-86858891

www.baclcorp.com.cn

Note: The information marked ▲ is provided by the applicant, the laboratory is not responsible for its authenticity and this information can affect the validity of the result in the test report. Unless otherwise stated the results shown in this test report refer only to the sample(s) tested. This report cannot be reproduced except in full, without prior written approval of the Company. This report is valid only with a valid digital signature. The digital signature may be available only under the Adobe software above version 7.0. This report may contain data that are not covered by the accreditation scope and shall be marked with ★. This report must not be used by the client to claim product certification, approval, or endorsement by NVLAP, NIST, or any agency of the U.S. Government.

SAR TEST RESULTS SUMMARY

Mode	Max. SAR Level(s) Reported(W/kg)		Limit
PTT(462.5500-467.7125MHz)	1g Head SAR(Face Up)	0.74	1.6 (W/kg)
	1g Body SAR(Body Back)	1.03	
Applicable Standards	FCC 47 CFR part 2.1093 Radiofrequency radiation exposure evaluation: portable devices		
	IEEE1528:2013 IEEE Recommended Practice for Determining the Peak Spatial-Average Specific Absorption Rate (SAR) in the Human Head from Wireless Communications Devices: Measurement Techniques		
	RF Exposure Procedures: TCB Workshop April 2019		
	KDB procedures KDB 447498 D01 General RF Exposure Guidance v06 KDB 865664 D01 SAR Measurement 100 MHz to 6 GHz v01r04 KDB 865664 D02 RF Exposure Reporting v01r02 KDB 643646 D01 SAR Test for PTT Radios v01r03		
<p>Note: This wireless device has been shown to be capable of compliance for localized specific absorption rate (SAR) for General Population/Uncontrolled Exposure limits specified in FCC 47 CFR part 2.1093 and has been tested in accordance with the measurement procedures specified in IEEE 1528-2013 and RF exposure KDB procedures.</p> <p>The results and statements contained in this report pertain only to the device(s) evaluated.</p>			

TABLE OF CONTENTS

DOCUMENT REVISION HISTORY	4
1.GENERAL INFORMATION.....	5
1.1 PRODUCT DESCRIPTION FOR EQUIPMENT UNDER TEST (EUT)	5
2.REFERENCE, STANDARDS, AND GUIDELINES.....	6
2.1 SAR LIMITS	6
2.2 TEST FACILITY	7
3.DESCRPTION OF TEST SYSTEM	8
4. EQUIPMENT LIST AND CALIBRATION	13
4.1 EQUIPMENTS LIST & CALIBRATION INFORMATION	13
5. SAR MEASUREMENT SYSTEM VERIFICATION	14
5.1 LIQUID VERIFICATION.....	14
5.2 SYSTEM ACCURACY VERIFICATION	15
5.3 SAR SYSTEM VALIDATION DATA	16
6. EUT TEST STRATEGY AND METHODOLOGY	17
6.1 TEST POSITIONS FOR FRONT-OF-FACE CONFIGURATIONS	17
6.2 TEST POSITIONS FOR BODY-WORN AND OTHER CONFIGURATIONS	18
6.3 TEST DISTANCE FOR SAR EVALUATION	18
6.4 SAR EVALUATION PROCEDURE.....	19
7. CONDUCTED OUTPUT POWER MEASUREMENT	20
7.1 TEST PROCEDURE	20
7.2 MAXIMUM TARGET OUTPUT POWER.....	20
7.3 TEST RESULTS:	20
8. SAR MEASUREMENT RESULTS	22
8.1 SAR TEST DATA	22
9. SAR SIMULTANEOUS TRANSMISSION DESCRIPTION	23
9.1 SIMULTANEOUS TRANSMISSION:.....	23
10. MEASUREMENT VARIABILITY	24
11. DUT HOLDER PERTURBATIONS	25
APPENDIX A - MEASUREMENT UNCERTAINTY	26
APPENDIX B - SAR PLOTS	27
APPENDIX C - EUT TEST POSITION PHOTOS.....	31
APPENDIX D - CALIBRATION CERTIFICATES.....	33

DOCUMENT REVISION HISTORY

Revision Number	Report Number	Description of Revision	Date of Revision
1.0	2402S45429E-20A	Original Report	2024/6/18

1.GENERAL INFORMATION

1.1 Product Description for Equipment under Test (EUT)

EUT Name:	FRS Two Way Radio
EUT Model:	T26
Device Type:	Portable
Exposure Category:	General Population/Uncontrolled Exposure
Antenna Type(s):	Integral Antenna
Body-Worn Accessories:	Belt Clip
Face-Head Accessories:	None
Operation Mode:	PTT_FM
Frequency Band:	462MHz(462.5500-462.7250MHz) 467MHz(467.5625-467.7125 MHz)
RF Output Power(ERP):	462MHz(462.5500-462.7250 MHz): 31.12 dBm 467MHz(467.5625-467.7125 MHz): 25.44 dBm
Power Source:	3.7 VDC From Rechargeable Battery
Serial Number:	2KQ9-1
Normal Operation:	Face Up and Body
EUT Received Date:	2024/04/29
Test Date:	2024/05/17
EUT Received Status:	Good

2.REFERENCE, STANDARDS, AND GUIDELINES

FCC:

The Report and Order requires routine SAR evaluation prior to equipment authorization of portable transmitter devices, including portable telephones. For consumer products, the applicable limit is 1.6 mW/g as recommended by the ANSI/IEEE standard C95.1-1992 [6] for an uncontrolled environment (Paragraph 65). According to the Supplement C of OET Bulletin 65 "Evaluating Compliance with FCC Guide-lines for Human Exposure to Radio frequency Electromagnetic Fields", released on Jun 29, 2001 by the FCC, the device should be evaluated at maximum output power (radiated from the antenna) under "worst-case" conditions for normal or intended use, incorporating normal antenna operating positions, device peak performance frequencies and positions for maximum RF energy coupling.

This report describes the methodology and results of experiments performed on wireless data terminal. The objective was to determine if there is RF radiation and if radiation is found, what is the extent of radiation with respect to safety limits. SAR (Specific Absorption Rate) is the measure of RF exposure determined by the amount of RF energy absorbed by human body (or its parts) – to determine how the RF energy couples to the body or head which is a primary health concern for body worn devices. The limit below which the exposure to RF is considered safe by regulatory bodies in North America is 1.6 mW/g average over 1 gram of tissue mass.

2.1 SAR Limits

FCC Limit

EXPOSURE LIMITS	SAR (W/kg)	
	(General Population / Uncontrolled Exposure Environment)	(Occupational / Controlled Exposure Environment)
Spatial Average (averaged over the whole body)	0.08	0.4
Spatial Peak (averaged over any 1 g of tissue)	1.60	8.0
Spatial Peak (hands/wrists/feet/ankles averaged over 10 g)	4.0	20.0

Population/Uncontrolled Environments are defined as locations where there is the exposure of individual who have no knowledge or control of their exposure.

Occupational/Controlled Environments are defined as locations where there is exposure that may be incurred by people who are aware of the potential for exposure (i.e. as a result of employment or occupation).

General Population/Uncontrolled environments Spatial Peak limit 1.6W/kg (FCC) applied to the EUT.

2.2 Test Facility

The Test site used by Bay Area Compliance Laboratories Corp. (Dongguan) to collect test data is located on the No.12, Pulong East 1st Road, Tangxia Town, Dongguan, Guangdong, China.

The lab has been recognized as the FCC accredited lab under the KDB 974614 D01 and is listed in the FCC Public Access Link (PAL) database, FCC Registration No. : 829273, the FCC Designation No. : CN5044.

3.DESCRPTION OF TEST SYSTEM

These measurements were performed with the automated near-field scanning system DASY5 from Schmid & Partner Engineering AG (SPEAG) which is the Fifth generation of the system shown in the figure hereinafter:



DASY5 System Description

The DASY5 system for performing compliance tests consists of the following items:

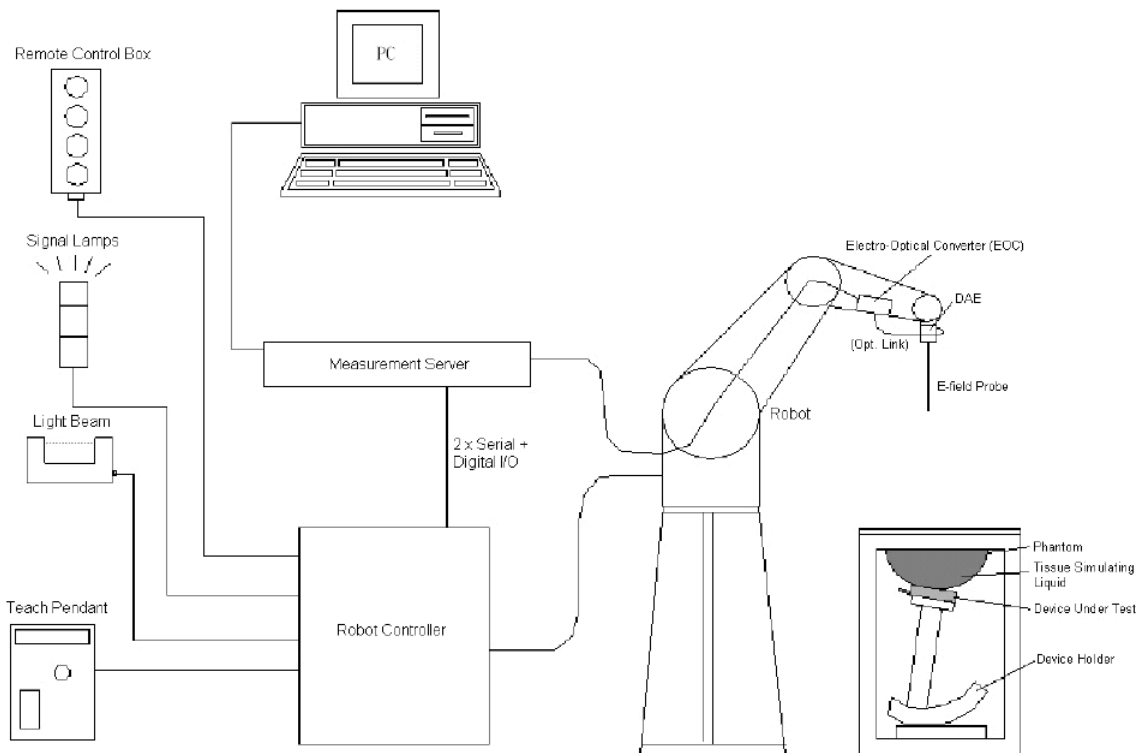

- A standard high precision 6-axis robot with controller, teach pendant and software. An arm extension for accommodating the data acquisition electronics (DAE).
- An isotropic field probe optimized and calibrated for the targeted measurement.
- A data acquisition electronics (DAE) which performs the signal application, signal multiplexing, AD-conversion, offset measurements, mechanical surface detection, collision detection, etc. The unit is battery powered with standard or rechargeable batteries. The signal is optically transmitted to the EOC.
- The Electro-optical converter (EOC) performs the conversion from optical to electrical signals for the digital communication to the DAE. To use optical surface detection, a special version of the EOC is required. The EOC signal is transmitted to the measurement server.
- The function of the measurement server is to perform the time critical tasks such as signal filtering, control of the robot operation and fast movement interrupts.
- The Light Beam used is for probe alignment. This improves the (absolute) accuracy of the probe positioning.
- A computer running Win7 professional operating system and the DASY52 software.
- Remote control and teach pendant as well as additional circuitry for robot safety such as warning lamps, etc.
- The phantom, the device holder and other accessories according to the targeted measurement.

DASY5 Measurement Server

The DASY5 measurement server is based on a PC/104 CPU board with a 400MHz Intel ULV Celeron, 128MB chip-disk and 128MB RAM. The necessary circuits for communication with the DAE4 (or DAE3) electronics box, as well as the 16 bit AD-converter system for optical detection and digital I/O interface are contained on the DASY5 I/O board, which is directly connected to the PC/104 bus of the CPU board.



The measurement server performs all real-time data evaluation of field measurements and surface detection, controls robot movements and handles safety operation. The PC operating system cannot interfere with these time critical processes. All connections are supervised by a watchdog, and disconnection of any of the cables to the measurement server will automatically disarm the robot and disable all program-controlled robot movements. Furthermore, the measurement server is equipped with an expansion port which is reserved for future applications. Please note that this expansion port does not have a standardized point out, and therefore only devices provided by SPEAG can be connected. Devices from any other supplier could seriously damage the measurement server.

Data Acquisition Electronics

The data acquisition electronics (DAE4) consist of a highly sensitive electrometer-grade preamplifier with auto-zeroing, a channel and gain-switching multiplexer, a fast 16 bit AD-converter and a command decoder with a control logic unit. Transmission to the measurement server is accomplished through an optical downlink for data and status information, as well as an optical uplink for commands and the clock.

The mechanical probe mounting device includes two different sensor systems for frontal and sideways probe contacts. They are used for mechanical surface detection and probe collision detection.

The input impedance of both the DAE4 as well as of the DAE3 box is 200M Ω ; the inputs are symmetrical and floating. Common mode rejection is above 80 dB.

ES3DV2 E-Field Probes

Frequency	10 MHz - 4 GHz Linearity: ± 0.2 dB (30 MHz to 4 GHz)
Directivity	± 0.2 dB in TSL (rotation around probe axis) ± 0.3 dB in TSL (rotation normal to probe axis)
Dynamic Range	5 µW/g to > 100 mW/g Linearity: ± 0.2 dB (noise: typically < 1 µW/g)
Dimensions	Overall length: 337 mm (Tip: 20 mm) Tip diameter: 3.9 mm (Body: 12 mm) Typical distance from probe tip to dipole centers: 2.0 mm
Application	General dosimetry up to 4 GHz Dosimetry in strong gradient fields Compliance tests of mobile phones
Compatibility	DASY3, DASY4, DASY52, DASY6, DASY8 SAR, EASY6, EASY4/MRI

ELI Phantom

The ELI phantom is intended for compliance testing of handheld and body-mounted wireless devices in the frequency range of 30MHz to 6 GHz. ELI is fully compatible with the latest draft of the standard IEC62209-2 and the use of all known tissue simulating liquids. ELI has been optimized for performance and can be integrated into a SPEAG standard phantom table. A cover is provided to prevent evaporation of water and changes in liquid parameters. Reference markings on the phantom allow installation of the complete setup, including all predefined phantom positions and measurement grids, by teaching three points.

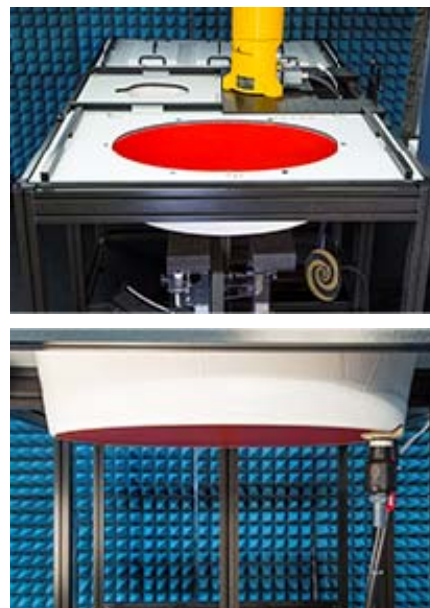

Robots

The DASY5 system uses the high precision industrial robot. The robot offers the same features important for our application:

- High precision (repeatability 0.02mm)
- High reliability (industrial design)
- Low maintenance costs (virtually maintenance free due to direct drive gears; no belt drives)
- Jerk-free straight movements (brushless synchrony motors; no stepper motors)
- Low ELF interference (motor control fields shielded via the closed metallic construction shields)

The above mentioned robots are controlled by the Staubli CS7MB robot controllers. All information regarding the use and maintenance of the robot arm and the robot controller is contained on the CDs delivered along with the robot. Paper manuals are available upon request direct from Staubli.

Area Scans

Area scans are defined prior to the measurement process being executed with a user defined variable spacing between each measurement point (integral) allowing low uncertainty measurements to be conducted. Scans defined for FCC applications utilize a 15mm 2 step integral, with 1.5mm interpolation used to locate the peak SAR area used for zoom scan assessments.

Where the system identifies multiple SAR peaks (which are within 25% of peak value) the system will provide the user with the option of assessing each peak location individually for zoom scan averaging.

Zoom Scan (Cube Scan Averaging)

The averaging zoom scan volume utilized in the DASY5 software is in the shape of a cube and the side dimension of a 1 g or 10 g mass is dependent on the density of the liquid representing the simulated tissue. A density of 1000 kg/m^3 is used to represent the head and body tissue density and not the phantom liquid density, in order to be consistent with the definition of the liquid dielectric properties, i.e. the side length of the 1g cube is 10mm, with the side length of the 10g cube is 21.5mm.

When the cube intersects with the surface of the phantom, it is oriented so that 3 vertices touch the surface of the shell or the center of a face is tangent to the surface. The face of the cube closest to the surface is modified in order to conform to the tangent surface.

The zoom scan integer steps can be user defined so as to reduce uncertainty, but normal practice for typical test applications (including FCC) utilize a physical step of 7 x7 x 7 (5mmx5mmx5mm) providing a volume of 30 mm in the X & Y & Z axis.

Tissue Dielectric Parameters for Head and Body Phantoms

The head tissue dielectric parameters recommended by the IEEE 1528-2013

Recommended Tissue Dielectric Parameters for Head liquid

Table 3—Target dielectric properties of head tissue-equivalent material in the 300 MHz to 6000 MHz frequency range

Frequency (MHz)	Relative permittivity (ϵ')	Conductivity (σ) (S/m)
300	45.3	0.87
450	43.5	0.87
<i>750</i>	<i>41.9</i>	<i>0.89</i>
835	41.5	0.90
900	41.5	0.97
1450	40.5	1.20
<i>1500</i>	<i>40.4</i>	<i>1.23</i>
<i>1640</i>	<i>40.2</i>	<i>1.31</i>
<i>1750</i>	<i>40.1</i>	<i>1.37</i>
1800	40.0	1.40
1900	40.0	1.40
2000	40.0	1.40
<i>2100</i>	<i>39.8</i>	<i>1.49</i>
<i>2300</i>	<i>39.5</i>	<i>1.67</i>
2450	39.2	1.80
<i>2600</i>	<i>39.0</i>	<i>1.96</i>
3000	38.5	2.40
<i>3500</i>	<i>37.9</i>	<i>2.91</i>
<i>4000</i>	<i>37.4</i>	<i>3.43</i>
<i>4500</i>	<i>36.8</i>	<i>3.94</i>
<i>5000</i>	<i>36.2</i>	<i>4.45</i>
<i>5200</i>	<i>36.0</i>	<i>4.66</i>
<i>5400</i>	<i>35.8</i>	<i>4.86</i>
<i>5600</i>	<i>35.5</i>	<i>5.07</i>
5800	35.3	5.27
<i>6000</i>	<i>35.1</i>	<i>5.48</i>

NOTE—For convenience, permittivity and conductivity values at some frequencies that are not part of the original data from Drossos et al. [B60] or the extension to 5800 MHz are provided (i.e., the values shown in italics). These values were linearly interpolated between the values in this table that are immediately above and below these values, except the values at 6000 MHz that were linearly extrapolated from the values at 3000 MHz and 5800 MHz.

4. EQUIPMENT LIST AND CALIBRATION

4.1 Equipments List & Calibration Information

Equipment	Model	S/N	Calibration Date	Calibration Due Date
DASY5 Test Software	DASY52.10	N/A	NCR	NCR
DASY5 Measurement Server	DASY5 4.5.12	1470	NCR	NCR
Data Acquisition Electronics	DAE4	772	2024/1/23	2025/1/22
E-Field Probe	ES3DV2	3019	2024/2/8	2025/2/7
Dipole, 450MHz	D450V3	1096	2022/11/17	2025/11/16
Mounting Device	MD4HHTV5	SD 000 H01 KA	NCR	NCR
Oval Flat Phantom	ELI V8.0	2051	NCR	NCR
Simulated Tissue 450 MHz Head	TS-450H	2309045001	Each Time	/
Network Analyzer	8753C	3033A02857	2023/11/18	2024/11/17
Dielectric assessment kit	1253	SM DAK 040 CA	NCR	NCR
synthesized signal generator	8665B	3438a00584	2023/10/18	2024/10/17
Power Meter	E4419B	MY45103907	2023/10/18	2024/10/17
Power Amplifier	ZHL-5W-202-S+	416402204	NCR	NCR
Directional Coupler	441493	520Z	NCR	NCR
Attenuator	20dB, 100W	LN749	NCR	NCR
Attenuator	6dB, 150W	2754	NCR	NCR
Thermometer	DTM3000	3635	2023/8/11	2024/8/10
Hygrothermograph	HTC-2	EM072	2023/11/6	2024/11/5
Spectrum Analyzer	FSV40	101589	2023/10/11	2024/10/10

5. SAR MEASUREMENT SYSTEM VERIFICATION

5.1 Liquid Verification

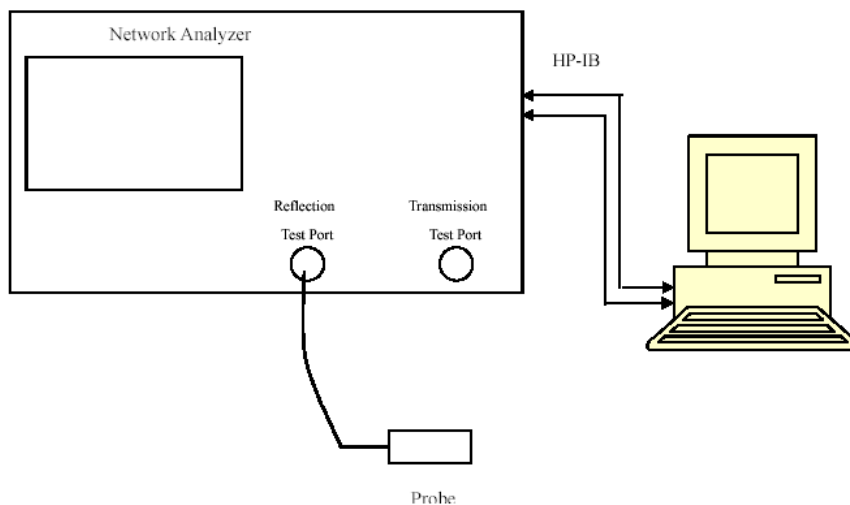

Liquid Verification Setup Block Diagram

Liquid Verification Results

Frequency (MHz)	Liquid Type	Liquid Parameter		Target Value		Delta (%)		Tolerance (%)
		ϵ_r	σ (S/m)	ϵ_r	σ (S/m)	$\Delta\epsilon_r$	$\Delta\sigma$ (S/m)	
450	Simulated Tissue 450 MHz Head	43.524	0.842	43.5	0.87	0.06	-3.22	± 5
462.6375	Simulated Tissue 450 MHz Head	43.322	0.854	43.43	0.87	-0.25	-1.84	± 5
467.6375	Simulated Tissue 450 MHz Head	43.257	0.861	43.41	0.87	-0.35	-1.03	± 5

*Liquid Verification above was performed on 2024/05/17.

5.2 System Accuracy Verification

Prior to the assessment, the system validation kit was used to test whether the system was operating within its specifications of $\pm 10\%$. The validation results are tabulated below. And also the corresponding SAR plot is attached as well in the SAR plots files.

The spacing distances in the **System Verification Setup Block Diagram** is given by the following:

- a) $s = 15 \text{ mm} \pm 0,2 \text{ mm}$ for $300 \text{ MHz} \leq f \leq 1\ 000 \text{ MHz}$;
- b) $s = 10 \text{ mm} \pm 0,2 \text{ mm}$ for $1\ 000 \text{ MHz} < f \leq 3\ 000 \text{ MHz}$;
- c) $s = 10 \text{ mm} \pm 0,2 \text{ mm}$ for $3\ 000 \text{ MHz} < f \leq 6\ 000 \text{ MHz}$.
- d) $s = 0 \text{ mm}$ for $f = 150 \text{ MHz}$ (Loop Antenna).

System Verification Setup Block Diagram

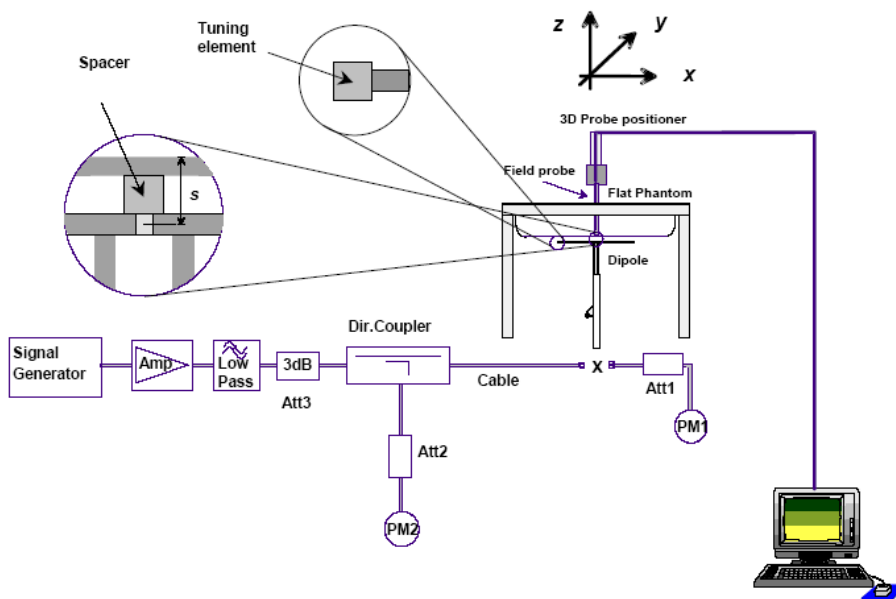

System Accuracy Check Results

Date	Frequency Band	Liquid Type	Input Power (mW)	Measured SAR (W/kg)	Target Value (W/kg)	Delta (%)	Tolerance (%)
2024/05/17	450 MHz	Simulated Tissue 450 MHz Head	1000	1g 4.64	4.56	1.75	± 10

5.3 SAR SYSTEM VALIDATION DATA

System Performance 450 MHz Head

DUT: Dipole 450 MHz; Type: D450V3; Serial: 1096

Communication System: CW; Frequency: 450 MHz; Duty Cycle: 1:1

Medium parameters used: $f = 450 \text{ MHz}$; $\sigma = 0.842 \text{ S/m}$; $\epsilon_r = 43.524$; $\rho = 1000 \text{ kg/m}^3$

Phantom section: Flat Section

DASY5 Configuration:

- Probe: ES3DV2 - SN3019; ConvF(6.76, 6.76, 6.76) @ 450 MHz; Calibrated: 2024/2/8
- Sensor-Surface: 3mm (Mechanical Surface Detection)
- Electronics: DAE4 Sn772; Calibrated: 2024/1/23
- Phantom: ELI v8.0; Type: QDOVA002AA; Serial: TP:2051
- Measurement SW: DASY52, Version 52.10 (2); SEMCAD X Version 14.6.12 (7470)

Area Scan (8x21x1): Measurement grid: $dx=15\text{mm}$, $dy=15\text{mm}$

Maximum value of SAR (measured) = 5.04 W/kg

Zoom Scan (5x5x7)/Cube 0: Measurement grid: $dx=8\text{mm}$, $dy=8\text{mm}$, $dz=5\text{mm}$

Reference Value = 71.04 V/m; Power Drift = 0.14 dB

Peak SAR (extrapolated) = 5.73 W/kg

SAR(1 g) = 4.64 W/kg; SAR(10 g) = 3.21 W/kg

Maximum value of SAR (measured) = 4.98 W/kg

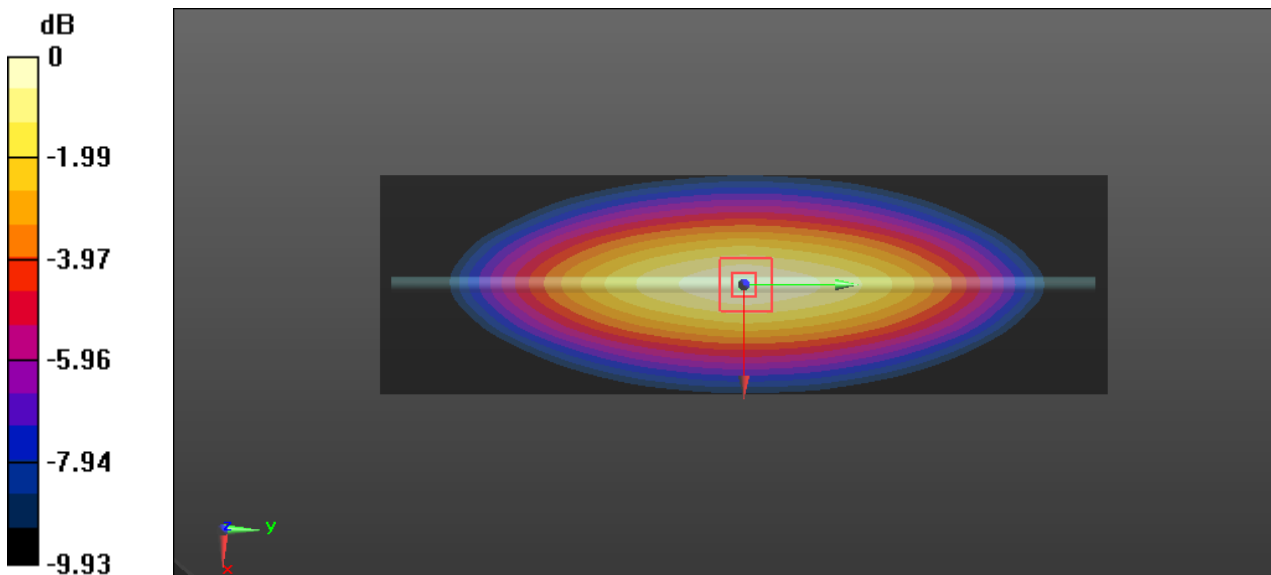

0 dB = 4.98 W/kg = 6.97 dBW/kg

6. EUT TEST STRATEGY AND METHODOLOGY

6.1 Test positions for Front-of-face configurations

Passive body-worn and audio accessories generally do not apply to the head SAR of PTT radios. Head SAR is measured with the front surface of the radio positioned at 2.5 cm parallel to a flat phantom. A phantom shell thickness of 2 mm is required. When the front of the radio has a contour or non-uniform surface with a variation of 1.0 cm or more, the average distance of such variations is used to establish the 2.5 cm test separation from the phantom.

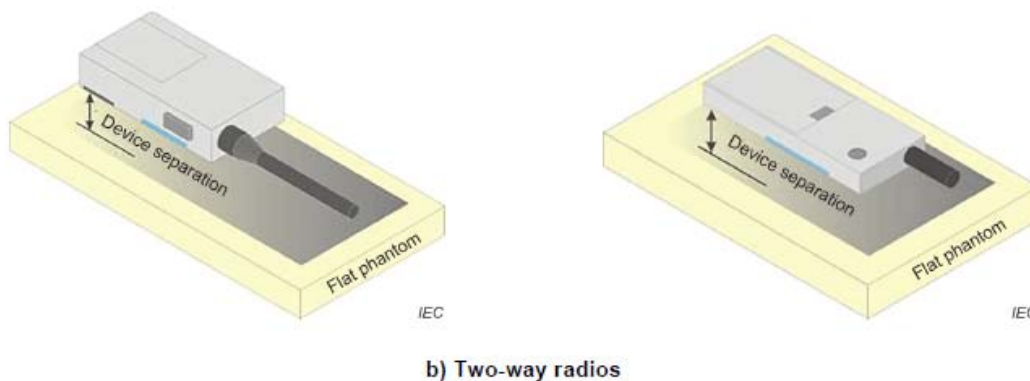

Figure 10 – Test positions for front-of-face devices

6.2 Test positions for body-worn and other configurations

Body-worn operating configurations should be tested with the belt-clips and holsters attached to the device and positioned against a flat phantom in normal use configurations. Devices with a headset output should be tested with a headset connected to the device. When multiple accessories that do not contain metallic components are supplied with the device, the device may be tested with only the accessory that dictates the closest spacing to the body. When multiple accessories that contain metallic components are supplied with the device, the device must be tested with each accessory that contains a unique metallic component. If multiple accessories share an identical metallic component (e.g., the same metallic belt-clip used with different holsters with no other metallic components), only the accessory that dictates the closest spacing to the body must be tested.

Body-worn accessories may not always be supplied or available as options for some devices that are intended to be authorized for body-worn use. A separation distance of 1.5 cm between the back of the device and a flat phantom is recommended for testing body-worn SAR compliance under such circumstances. Other separation distances may be used, but they should not exceed 2.5 cm. In these cases, the device may use body-worn accessories that provide a separation distance greater than that tested for the device provided however that the accessory contains no metallic components.

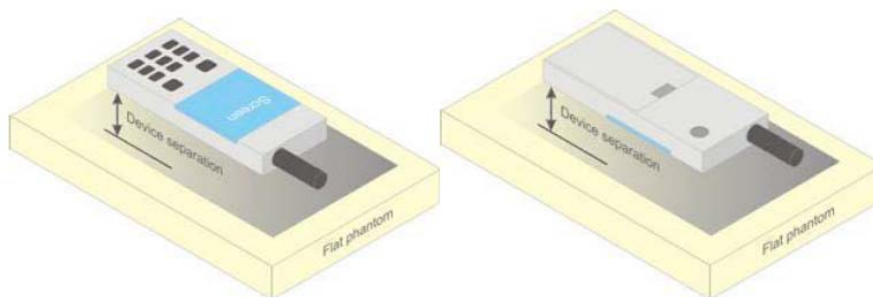

Figure 5 – Test positions for body-worn devices

6.3 Test Distance for SAR Evaluation

In this case the DUT(Device Under Test) is set directly against the phantom, the test distance is 0mm for Body Back mode; for Face Up mode the distance is 25mm.

6.4 SAR Evaluation Procedure

The evaluation was performed with the following procedure:

Step 1: Measurement of the SAR value at a fixed location above the ear point or central position was used as a reference value for assessing the power drop. The SAR at this point is measured at the start of the test and then again at the end of the testing.

Step 2: The SAR distribution at the exposed side of the head was measured at a distance of 4 mm from the inner surface of the shell. The area covered the entire dimension of the head or radiating structures of the EUT, the horizontal grid spacing was 15 mm x 15 mm, and the SAR distribution was determined by integrated grid of 1.5mm x 1.5mm. Based on these data, the area of the maximum absorption was determined by spline interpolation. The first Area Scan covers the entire dimension of the EUT to ensure that the hotspot was correctly identified.

Step 3: Around this point, a volume of 30 mm x 30 mm x 30 mm was assessed by measuring 7x 7 x 7 points. On the basis of this data set, the spatial peak SAR value was evaluated under the following procedure:

- 1) The data at the surface were extrapolated, since the center of the dipoles is 1.2 mm away from the tip of the probe and the distance between the surface and the lowest measuring point is 1.3 mm. The extrapolation was based on a least square algorithm. A polynomial of the fourth order was calculated through the points in z-axes. This polynomial was then used to evaluate the points between the surface and the probe tip.

- 2) The maximum interpolated value was searched with a straightforward algorithm. Around this maximum the SAR values averaged over the spatial volumes (1 g or 10 g) were computed by the 3D-Spline interpolation algorithm. The 3D-Spline is composed of three one dimensional splines with the "Not a knot"-condition (in x, y and z-directions). The volume was integrated with the trapezoidal-algorithm. One thousand points (10 x 10 x 10) were interpolated to calculate the averages.

All neighboring volumes were evaluated until no neighboring volume with a higher average value was found.

Step 4: Re-measurement of the SAR value at the same location as in Step 1. If the value changed by more than 5%, the evaluation was repeated.

7. CONDUCTED OUTPUT POWER MEASUREMENT

7.1 Test Procedure

The RF output of the transmitter was connected to the input of the Spectrum Analyzer through sufficient attenuation.

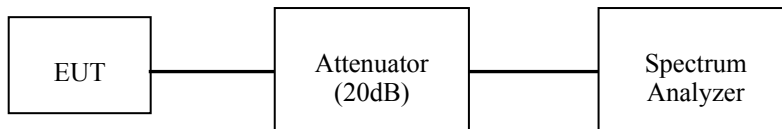

The Signal Analyzer setting:

RBW	VBW
100 kHz	300 kHz

7.2 Maximum Target Output Power

Mode	Max. ERP(with tolerance) for Production Unit (dBm)
462MHz(462.5500-462.7250 MHz)	32
467MHz(467.5625-467.7125 MHz)	26.1

7.3 Test Results:

Mode	Frequency (MHz)	Conducted Output power (dBm)	Antenna Gain(dBd)	ERP (dBm)
462MHz(462.5500-462.7250 MHz)	462.6375	31.77	-0.65	31.12
467MHz(467.5625-467.7125 MHz)	467.6375	26.09	-0.65	25.44

Note:

Per IEEE 1528:2013, the width of the transmit frequency band, $\Delta f = f_{high} - f_{low}$ (where f_{high} is the highest frequency in the band and f_{low} is the lowest) does not exceeds 1% of its center frequency f_c . then only **center frequency** need be tested.

Antennas Location:



8. SAR MEASUREMENT RESULTS

This page summarizes the results of the performed dosimetric evaluation.

8.1 SAR Test Data

Environmental Conditions

Temperature:	22.5-23.3 °C
Relative Humidity:	42 %
ATM Pressure:	100.6 kPa
Test Date:	2024/05/17

Testing was performed by Mark Dong.

Test Result:

Test Mode	Frequency (MHz)	Worn accessories	Max. ERP (dBm)	Max. Rated Power (dBm)	1 g SAR Value(W/kg)				
					Power Scaled Factor	Meas. SAR	PTT 50% Factor	Scaled SAR	Plot
Head Face Up (25 mm)	462.6375	None	31.12	32	1.225	1.21	0.605	0.74	1#
	467.6375	None	25.44	26.1	1.164	0.582	0.291	0.34	2#
Body Back (0 mm)	462.6375	Belt Clip	31.12	32	1.225	1.68	0.84	1.03	3#
	467.6375	Belt Clip	25.44	26.1	1.164	0.995	0.4975	0.58	4#

Note:

1. For a PTT, only simplex communication technology was supported, so the SAR value need to be corrected by Multiplying 50%.
2. Passive body-worn and audio accessories generally do not apply to the head SAR of PTT radios.
3. The whole antenna and radiating structures that may contribute to the measured SAR or influence the SAR distribution has been included in the area scan.
4. The UHF bands in this device operate in a half duplex system. A half duplex system only allows the user to transmit or receive. This device cannot transmit and receive simultaneously. The user must stop transmitting in order to receive a signal or listen for a response, regardless of PTT button or with a VOX(Voice Activated Transmit) capacity. This type of operation, along with the RF safety booklet, which instructs the user to transmit no more than 50% of the time, justifies the use of 50% duty factor for this device.

9. SAR SIMULTANEOUS TRANSMISSION DESCRIPTION

9.1 Simultaneous Transmission:

Note: There is no multiple transmitters for the product, so simultaneous transmission need not to evaluate.

10. MEASUREMENT VARIABILITY

In accordance with published RF Exposure KDB procedure 865664 D01 SAR measurement 100 MHz to 6 GHz v01. These additional measurements are repeated after the completion of all measurements requiring the same head or body tissue-equivalent medium in a frequency band. The test device should be returned to ambient conditions (normal room temperature) with the battery fully charged before it is re-mounted on the device holder for the repeated measurement(s) to minimize any unexpected variations in the repeated results

- 1) Repeated measurement is not required when the original highest measured SAR is < 0.80 W/kg; steps 2) through 4) do not apply.
- 2) When the original highest measured SAR is ≥ 0.80 W/kg, repeat that measurement once.
- 3) Perform a second repeated measurement only if the ratio of largest to smallest SAR for the original and first repeated measurements is > 1.20 or when the original or repeated measurement is ≥ 1.45 W/kg (~ 10% from the 1-g SAR limit).
- 4) Perform a third repeated measurement only if the original, first or second repeated measurement is ≥ 1.5 W/kg and the ratio of largest to smallest SAR for the original, first and second repeated measurements is > 1.20.

Note: The same procedures should be adapted for measurements according to extremity and occupational exposure limits by applying a factor of 2.5 for extremity exposure and a factor of 5 for occupational exposure to the corresponding SAR thresholds.

The Highest Measured SAR Configuration in Each Frequency Band

Head Face Up

SAR probe calibration point	Frequency Band	Freq.(MHz)	EUT Position	Meas. SAR (W/kg)		Largest to Smallest SAR Ratio
				Original	Repeated	
450MHz	FM 12.5kHz	462.6375	Head Face Up	1.21	1.17	1.03

Body Back

SAR probe calibration point	Frequency Band	Freq.(MHz)	EUT Position	Meas. SAR (W/kg)			Largest to Smallest SAR Ratio
				Original	First Repeated	Second Repeated	
450MHz	FM 12.5kHz	462.6375	Body Back	1.68	1.62	1.55	1.08

Note:

1. Second Repeated Measurement is not required since the ratio of the largest to smallest SAR for the original and first repeated measurement is not > 1.20.
2. The measured SAR results **do not** have to be scaled to the maximum tune-up tolerance to determine if repeated measurements are required.
3. SAR measurement variability must be assessed for each frequency band, which is determined by the **SAR probe calibration point and tissue-equivalent medium** used for the device measurements.

11. DUT HOLDER PERTURBATIONS

In accordance with TCB workshop October 2016:

- 1) SAR perturbation due to test device holders, depending on antenna locations, buttons locations on phones or device, form factor (e.g. dongles etc.), the measured SAR could be influenced by the relative positions of the test device and its holder
- 2) SAR measurement standards have included protocols to evaluate this with a flat phantom, with and without the device holder
- 3) When the highest reported SAR of an antenna is > 1.2 W/kg, holder perturbation verification is required for each antenna, using the highest SAR configuration among all applicable frequency bands in the same exact device and holder positions used for head and body SAR measurements; i.e. same device/button locations in the holder

Per IEEE 1528: 2013/Annex E/E.4.1.1: Device holder perturbation tolerance for a specific test device: Type B

When it is unknown if a device holder perturbs the fields of a test device, the SAR uncertainty shall be assessed with a flat phantom (see Clause 5) by comparing the SAR with and without the device holder according to the following tests:

The SAR tolerance for device holder disturbance is computed using Equation (E.21) and entered in the corresponding row of the appropriate uncertainty table with an assumed rectangular probability distribution and $\nu_i = \infty$ degrees of freedom:

$$SAR_{\text{tolerance}} [\%] = 100 \times \left(\frac{SAR_{w/\text{holder}} - SAR_{w/o\text{holder}}}{SAR_{w/o\text{holder}}} \right) \tag{E.21}$$

The Highest Measured SAR Configuration among all applicable Frequency Band

Frequency Band	Freq.(MHz)	EUT Position	Meas. SAR (W/kg)		The Device holder perturbation uncertainty
			With holder	Without holder	
/	/	/	/	/	/

APPENDIX A - MEASUREMENT UNCERTAINTY

The uncertainty budget has been determined for the measurement system and is given in the following Table.

Measurement uncertainty evaluation for IEEE1528-2013 SAR test

Uncertainty component	Tolerance/uncertainty ± %	Probability distribution	Divisor	ci (1 g)	ci (10 g)	Standard uncertainty ± %, (1 g)	Standard uncertainty ± %, (10 g)
Measurement system							
Probe calibration(k=1)	6.55	N	1	1	1	6.6	6.6
Axial isotropy	4.7	R	√3	√0.5	√0.5	1.9	1.9
Hemispherical isotropy	9.6	R	√3	√0.5	√0.5	3.9	3.9
Boundary effect	1.0	R	√3	1	1	0.6	0.6
Linearity	4.7	R	√3	1	1	2.7	2.7
System detection limits	1.0	R	√3	1	1	0.6	0.6
Modulation response	0.0	R	√3	1	1	0.0	0.0
Readout electronics	0.3	N	1	1	1	0.3	0.3
Response time	0.0	R	√3	1	1	0.0	0.0
Integration time	0.0	R	√3	1	1	0.0	0.0
RF ambient conditions-noise	1.0	R	√3	1	1	0.6	0.6
RF ambient conditions-reflections	1.0	R	√3	1	1	0.6	0.6
Probe positioner mech. tolerance	0.8	R	√3	1	1	0.5	0.5
Probe positioning with respect to phantom shell	6.7	R	√3	1	1	3.9	3.9
Extrapolation, interpolation, and integrations algorithms for max. SAR evaluation	2.0	R	√3	1	1	1.2	1.2
Test sample related							
Test sample positioning	3.3	N	1	1	1	3.3	3.3
Device holder uncertainty	4.7	N	1	1	1	4.7	4.7
Output power variation – SAR draft measurement	5.0	R	√3	1	1	2.9	2.9
SAR scaling	2.8	R	√3	1	1	1.6	1.6
Phantom and tissue parameters							
Phantom shell uncertainty – shape, thickness and permittivity	4.0	R	√3	1	1	2.3	2.3
Uncertainty in SAR correction for deviations in permittivity and conductivity	1.9	N	1	1	0.84	1.9	1.6
Liquid conductivity meas.	2.5	N	1	0.78	0.71	2.0	1.8
Liquid permittivity meas.	2.5	N	1	0.23	0.26	0.6	0.7
Liquid conductivity – temperature uncertainty	1.7	R	√3	0.78	0.71	0.8	0.7
Liquid permittivity – temperature uncertainty	0.3	R	√3	0.23	0.26	0.0	0.0
Combined standard uncertainty		RSS				12.1	12.0
Expanded uncertainty (95 % confidence interval)		k=2				24.2	24.0

APPENDIX B - SAR PLOTS

Plot 1#:462.6375MHz_Face Up

DUT: FRS Two Way Radio; Type: T26 ; Serial: 2KQ9-1

Communication System: FM; Frequency: 462.637 MHz;Duty Cycle: 1:1

Medium parameters used: $f = 462.637$ MHz; $\sigma = 0.854$ S/m; $\epsilon_r = 43.322$; $\rho = 1000$ kg/m³

Phantom section: Flat Section

DASY5 Configuration:

- Probe: ES3DV2 - SN3019; ConvF(6.76, 6.76, 6.76) @ 462.637 MHz; Calibrated: 2024/2/8
- Sensor-Surface: 3mm (Mechanical Surface Detection)
- Electronics: DAE4 Sn772; Calibrated: 2024/1/23
- Phantom: ELI v8.0; Type: QDOVA002AA; Serial: TP:2051
- Measurement SW: DASY52, Version 52.10 (2); SEMCAD X Version 14.6.12 (7470)

Area Scan (7x13x1): Measurement grid: dx=15mm, dy=15mm

Maximum value of SAR (measured) = 1.40 W/kg

Zoom Scan (5x5x7)/Cube 0: Measurement grid: dx=8mm, dy=8mm, dz=5mm

Reference Value = 40.23 V/m; Power Drift = -0.11 dB

Peak SAR (extrapolated) = 1.76 W/kg

SAR(1 g) = 1.21 W/kg; SAR(10 g) = 0.854 W/kg

Maximum value of SAR (measured) = 1.38 W/kg

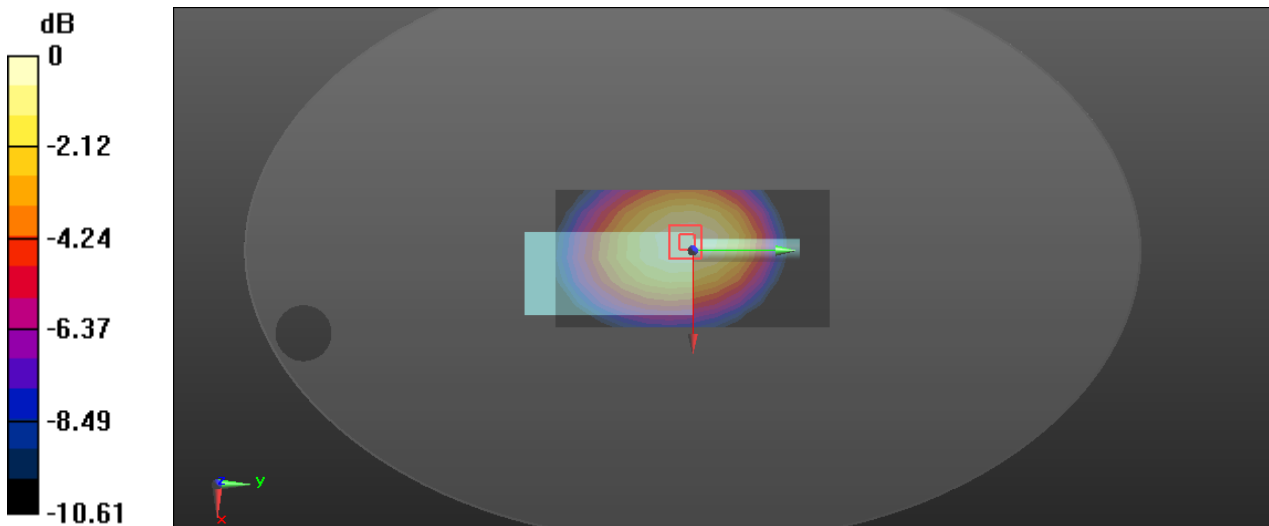

0 dB = 1.38 W/kg = 1.40 dBW/kg

Plot 2#:467.6375MHz_Face Up

DUT: FRS Two Way Radio; Type: T26 ; Serial: 2KQ9-1

Communication System: FM; Frequency: 467.637 MHz;Duty Cycle: 1:1

Medium parameters used: f = 467.637 MHz; $\sigma = 0.861$ S/m; $\epsilon_r = 43.257$; $\rho = 1000$ kg/m³

Phantom section: Flat Section

DASY5 Configuration:

- Probe: ES3DV2 - SN3019; ConvF(6.76, 6.76, 6.76) @ 467.637 MHz; Calibrated: 2024/2/8
- Sensor-Surface: 3mm (Mechanical Surface Detection)
- Electronics: DAE4 Sn772; Calibrated: 2024/1/23
- Phantom: ELI v8.0; Type: QDOVA002AA; Serial: TP:2051
- Measurement SW: DASY52, Version 52.10 (2); SEMCAD X Version 14.6.12 (7470)

Area Scan (7x13x1): Measurement grid: dx=15mm, dy=15mm
 Maximum value of SAR (measured) = 0.651 W/kg

Zoom Scan (5x5x7)/Cube 0: Measurement grid: dx=8mm, dy=8mm, dz=5mm
 Reference Value = 27.07 V/m; Power Drift = -0.13 dB
 Peak SAR (extrapolated) = 0.869 W/kg
SAR(1 g) = 0.582 W/kg; SAR(10 g) = 0.401 W/kg
 Maximum value of SAR (measured) = 0.665 W/kg

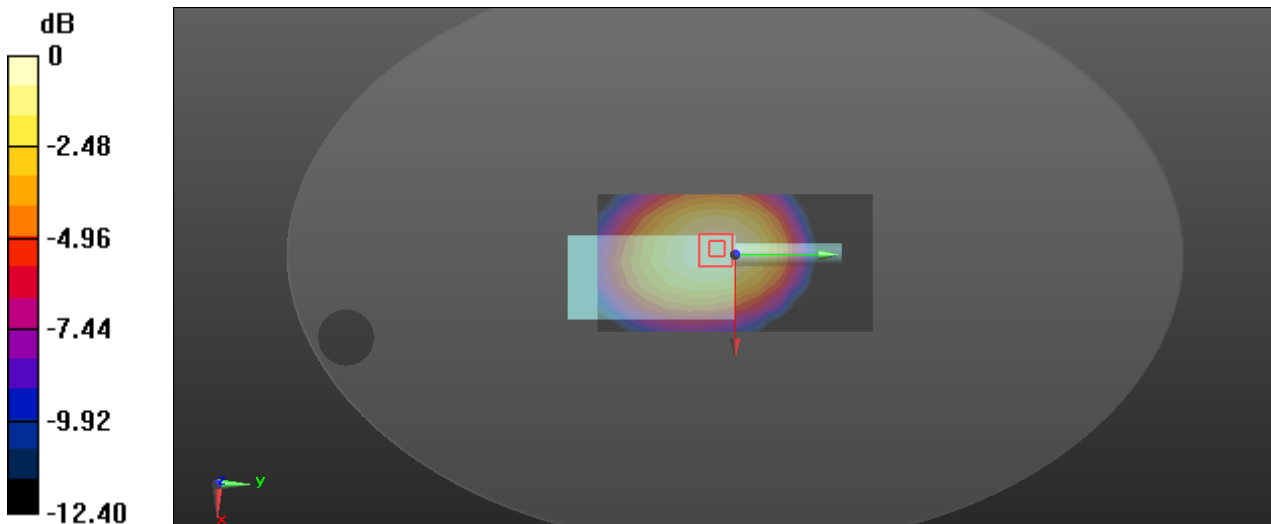

0 dB = 0.665 W/kg = -1.77 dBW/kg

Plot 3#:462.6375MHz_Body Back

DUT: FRS Two Way Radio; Type: T26 ; Serial: 2KQ9-1

Communication System: FM; Frequency: 462.637 MHz;Duty Cycle: 1:1

Medium parameters used: f = 462.637 MHz; $\sigma = 0.854$ S/m; $\epsilon_r = 43.322$; $\rho = 1000$ kg/m³

Phantom section: Flat Section

DASY5 Configuration:

- Probe: ES3DV2 - SN3019; ConvF(6.76, 6.76, 6.76) @ 462.637 MHz; Calibrated: 2024/2/8
- Sensor-Surface: 3mm (Mechanical Surface Detection)
- Electronics: DAE4 Sn772; Calibrated: 2024/1/23
- Phantom: ELI v8.0; Type: QDOVA002AA; Serial: TP:2051
- Measurement SW: DASY52, Version 52.10 (2); SEMCAD X Version 14.6.12 (7470)

Area Scan (7x13x1): Measurement grid: dx=15mm, dy=15mm

Maximum value of SAR (measured) = 1.95 W/kg

Zoom Scan (5x5x7)/Cube 0: Measurement grid: dx=8mm, dy=8mm, dz=5mm

Reference Value = 44.64 V/m; Power Drift = 0.14 dB

Peak SAR (extrapolated) = 2.56 W/kg

SAR(1 g) = 1.68 W/kg; SAR(10 g) = 1.12 W/kg

Maximum value of SAR (measured) = 1.94 W/kg

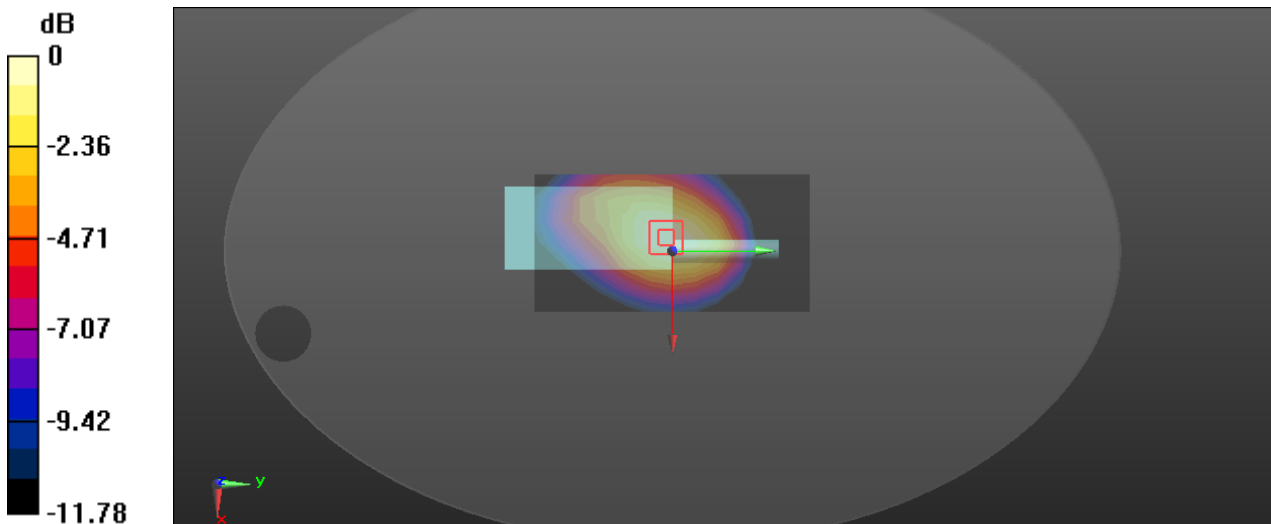

0 dB = 1.94 W/kg = 2.88 dBW/kg

Plot 4#:467.6375MHz_Body Back

DUT: FRS Two Way Radio; Type: T26 ; Serial: 2KQ9-1

Communication System: FM; Frequency: 467.637 MHz;Duty Cycle: 1:1

Medium parameters used: f = 467.637 MHz; $\sigma = 0.861$ S/m; $\epsilon_r = 43.257$; $\rho = 1000$ kg/m³

Phantom section: Flat Section

DASY5 Configuration:

- Probe: ES3DV2 - SN3019; ConvF(6.76, 6.76, 6.76) @ 467.637 MHz; Calibrated: 2024/2/8
- Sensor-Surface: 3mm (Mechanical Surface Detection)
- Electronics: DAE4 Sn772; Calibrated: 2024/1/23
- Phantom: ELI v8.0; Type: QDOVA002AA; Serial: TP:2051
- Measurement SW: DASY52, Version 52.10 (2); SEMCAD X Version 14.6.12 (7470)

Area Scan (7x13x1): Measurement grid: dx=15mm, dy=15mm
 Maximum value of SAR (measured) = 1.15 W/kg

Zoom Scan (5x5x7)/Cube 0: Measurement grid: dx=8mm, dy=8mm, dz=5mm
 Reference Value = 35.42 V/m; Power Drift = -0.10 dB
 Peak SAR (extrapolated) = 1.51 W/kg
SAR(1 g) = 0.995 W/kg; SAR(10 g) = 0.663 W/kg
 Maximum value of SAR (measured) = 1.15 W/kg

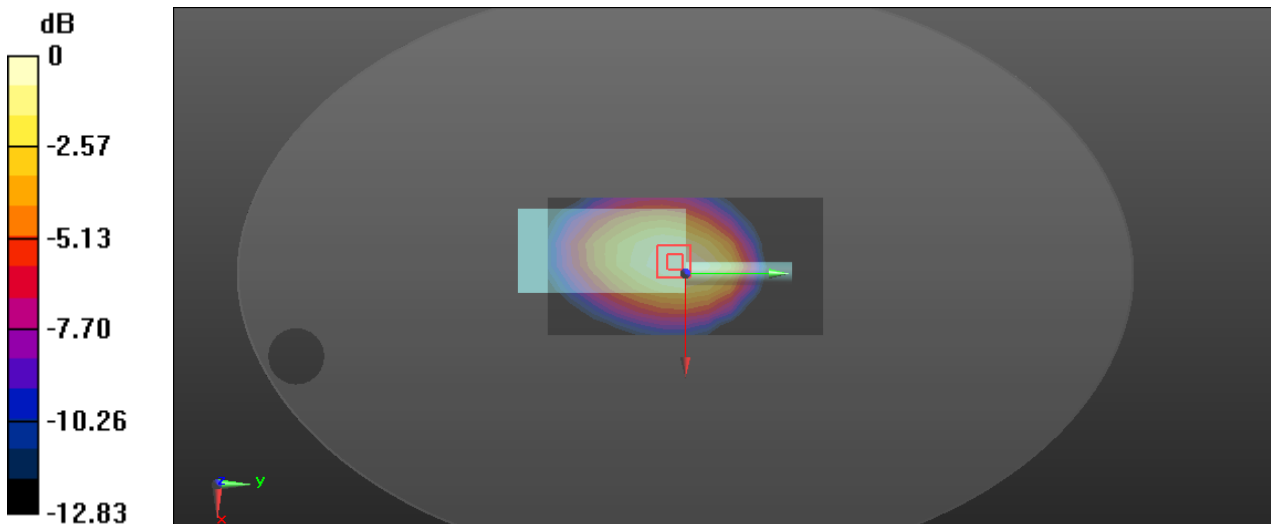

0 dB = 1.15 W/kg = 0.61 dBW/kg

APPENDIX C - EUT TEST POSITION PHOTOS

Liquid depth $\geq 15\text{cm}$

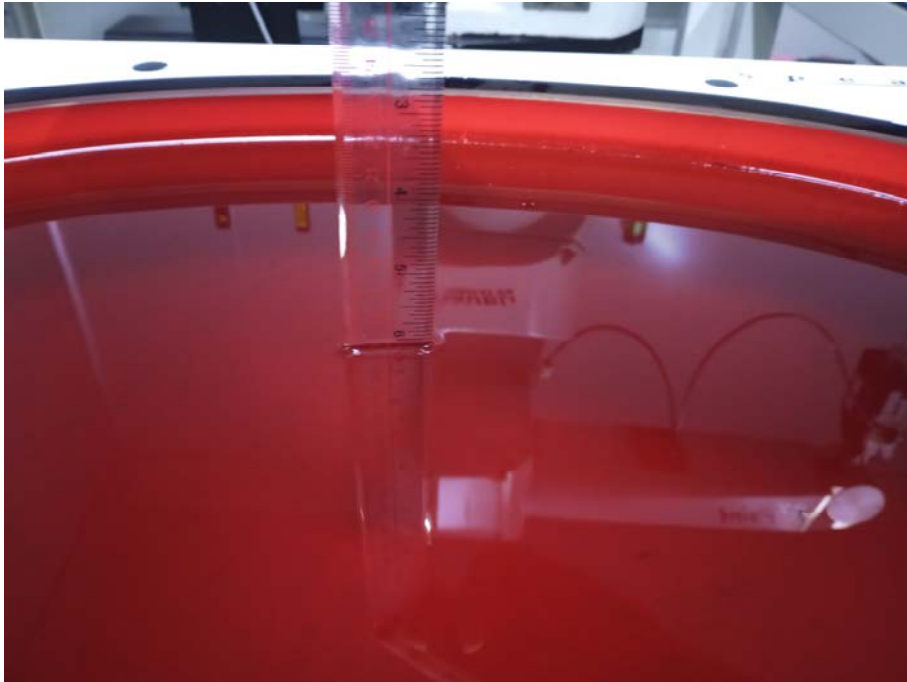

Face Up Setup Photo(25mm)



Body Back Setup Photo (0mm)

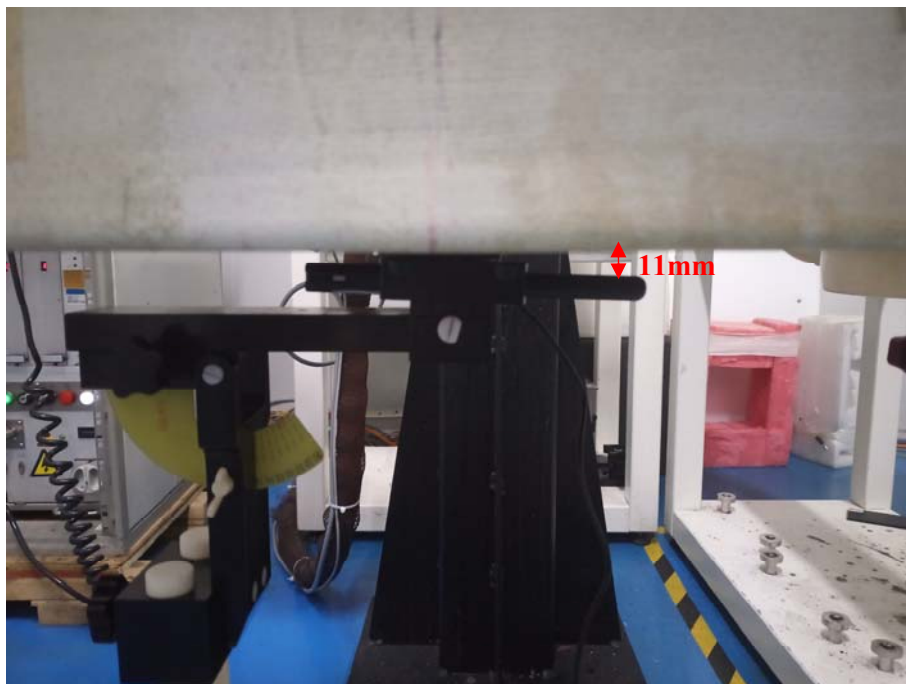

APPENDIX D - CALIBRATION CERTIFICATES

**Calibration Laboratory of
Schmid & Partner
Engineering AG**
Zeughausstrasse 43, 8004 Zurich, Switzerland



S Schweizerischer Kalibrierdienst
C Service suisse d'étalonnage
S Servizio svizzero di taratura
S Swiss Calibration Service

Accredited by the Swiss Accreditation Service (SAS)
The Swiss Accreditation Service is one of the signatories to the EA
Multilateral Agreement for the recognition of calibration certificates

Accreditation No.: **SCS 0108**

Client **BACL**
Shenzhen

Certificate No. **ES-3019_Feb24**

CALIBRATION CERTIFICATE

Object **ES3DV2 - SN:3019**

Calibration procedure(s) **QA CAL-01.v10, QA CAL-12.v10, QA CAL-23.v6, QA CAL-25.v8**
Calibration procedure for dosimetric E-field probes

Calibration date **February 08, 2024**

This calibration certificate documents the traceability to national standards, which realize the physical units of measurements (SI).
The measurements and the uncertainties with confidence probability are given on the following pages and are part of the certificate.
All calibrations have been conducted in the closed laboratory facility: environment temperature (22 ± 3) °C and humidity < 70%.
Calibration Equipment used (M&TE critical for calibration)

Primary Standards	ID	Cal Date (Certificate No.)	Scheduled Calibration
Power meter NRP2	SN: 104778	30-Mar-23 (No. 217-03804/03805)	Mar-24
Power sensor NRP-Z91	SN: 103244	30-Mar-23 (No. 217-03804)	Mar-24
OCP DAK-3.5 (weighied)	SN: 1249	05-Oct-23 (OCP-DAK3.5-1249 Oct23)	Oct-24
OCP DAK-12	SN: 1016	05-Oct-23 (OCP-DAK12-1016 Oct23)	Oct-24
Reference 20 dB Attenuator	SN: CC2552 (20x)	30-Mar-23 (No. 217-03809)	Mar-24
DAE4	SN: 660	16-Mar-23 (No. DAE4-660_Mar23)	Mar-24
Reference Probe EX3DV4	SN: 7349	03-Nov-23 (No. EX3-7349_Nov23)	Nov-24

Secondary Standards	ID	Check Date (in house)	Scheduled Check
Power meter E4419B	SN: GB41293874	06-Apr-16 (in house check Jun-22)	In house check: Jun-24
Power sensor E4412A	SN: MY41498087	06-Apr-16 (in house check Jun-22)	In house check: Jun-24
Power sensor E4412A	SN: 000110210	06-Apr-16 (in house check Jun-22)	In house check: Jun-24
RF generator HP 864BC	SN: US3642U01700	04-Aug-99 (in house check Jun-22)	In house check: Jun-24
Network Analyzer E8358A	SN: US41080477	31-Mar-14 (in house check Oct-22)	In house check: Oct-24

Calibrated by	Name Claudio Leubler	Function Laboratory Technician	Signature
Approved by	Name Sven Köhn	Function Technical Manager	Signature

Issued: February 08, 2024

This calibration certificate shall not be reproduced except in full without written approval of the laboratory.

**Calibration Laboratory of
Schmid & Partner
Engineering AG**
Zeughausstrasse 43, 8004 Zurich, Switzerland



S Schweizerischer Kalibrierdienst
C Service suisse d'étalonnage
S Servizio svizzero di taratura
S Swiss Calibration Service

Accredited by the Swiss Accreditation Service (SAS)
The Swiss Accreditation Service is one of the signatories to the EA
Multilateral Agreement for the recognition of calibration certificates

Accreditation No.: **SCS 0108**

Glossary

TSL	tissue simulating liquid
NORM _{x,y,z}	sensitivity in free space
ConvF	sensitivity in TSL / NORM _{x,y,z}
DCP	diode compression point
CF	crest factor (1/duty_cycle) of the RF signal
A, B, C, D	modulation dependent linearization parameters
Polarization φ	φ rotation around probe axis
Polarization θ	θ rotation around an axis that is in the plane normal to probe axis (at measurement center), i.e., θ = 0 is normal to probe axis
Connector Angle	information used in DASY system to align probe sensor X to the robot coordinate system

Calibration is Performed According to the Following Standards:

- a) IEC/IEEE 62209-1528, "Measurement Procedure For The Assessment Of Specific Absorption Rate Of Human Exposure To Radio Frequency Fields From Hand-Held And Body-Worn Wireless Communication Devices – Part 1528: Human Models, Instrumentation And Procedures (Frequency Range of 4 MHz to 10 GHz)", October 2020.
- b) KDB 865664, "SAR Measurement Requirements for 100 MHz to 6 GHz"

Methods Applied and Interpretation of Parameters:

- **NORM_{x,y,z}**: Assessed for E-field polarization θ = 0 (f ≤ 900MHz in TEM-cell; f > 1800MHz: R22 waveguide). NORM_{x,y,z} are only intermediate values, i.e., the uncertainties of NORM_{x,y,z} does not affect the E²-field uncertainty inside TSL (see below ConvF).
- **NORM(f)_{x,y,z} = NORM_{x,y,z} * frequency_response** (see Frequency Response Chart). This linearization is implemented in DASY4 software versions later than 4.2. The uncertainty of the frequency response is included in the stated uncertainty of ConvF.
- **DCP_{x,y,z}**: DCP are numerical linearization parameters assessed based on the data of power sweep with CW signal. DCP does not depend on frequency nor media.
- **PAR**: PAR is the Peak to Average Ratio that is not calibrated but determined based on the signal characteristics
- **A_{x,y,z}; B_{x,y,z}; C_{x,y,z}; D_{x,y,z}; VR_{x,y,z}**: A, B, C, D are numerical linearization parameters assessed based on the data of power sweep for specific modulation signal. The parameters do not depend on frequency nor media. VR is the maximum calibration range expressed in RMS voltage across the diode.
- **ConvF and Boundary Effect Parameters**: Assessed in flat phantom using E-field (or Temperature Transfer Standard for f ≤ 800MHz) and inside waveguide using analytical field distributions based on power measurements for f > 800MHz. The same setups are used for assessment of the parameters applied for boundary compensation (alpha, depth) of which typical uncertainty values are given. These parameters are used in DASY4 software to improve probe accuracy close to the boundary. The sensitivity in TSL corresponds to NORM_{x,y,z} * ConvF whereby the uncertainty corresponds to that given for ConvF. A frequency dependent ConvF is used in DASY version 4.4 and higher which allows extending the validity from ±50 MHz to ±100 MHz.
- **Spherical Isotropy (3D deviation from isotropy)**: in a field of low gradients realized using a flat phantom exposed by a patch antenna.
- **Sensor Offset**: The sensor offset corresponds to the offset of virtual measurement center from the probe tip (on probe axis). No tolerance required.
- **Connector Angle**: The angle is assessed using the information gained by determining the NORM_x (no uncertainty required).

ES3DV2 - SN:3019

February 08, 2024

Parameters of Probe: ES3DV2 - SN:3019

Basic Calibration Parameters

	Sensor X	Sensor Y	Sensor Z	Unc (k = 2)
Norm ($\mu V/(V/m)^2$) ^A	1.04	1.15	0.97	±10.1%
DCP (mV) ^B	104.2	100.9	106.9	±4.7%

Calibration Results for Modulation Response

UID	Communication System Name		A dB	B dB $\sqrt{\mu V}$	C	D dB	VR mV	Max dev.	Max Unc ^E k = 2
0	CW	X	0.00	0.00	1.00	0.00	118.8	±1.0%	±4.7%
		Y	0.00	0.00	1.00		118.8		
		Z	0.00	0.00	1.00		120.2		

The reported uncertainty of measurement is stated as the standard uncertainty of measurement multiplied by the coverage factor k=2, which for a normal distribution corresponds to a coverage probability of approximately 95%.

^A The uncertainties of Norm X,Y,Z do not affect the E²-field uncertainty inside TSL (see Pages 5 and 6).
^B Linearization parameter uncertainty for maximum specified field strength.
^E Uncertainty is determined using the max. deviation from linear response applying rectangular distribution and is expressed for the square of the field value.

ES3DV2 - SN:3019

February 08, 2024

Parameters of Probe: ES3DV2 - SN:3019

Other Probe Parameters

Sensor Arrangement	Triangular
Connector Angle	-57.7°
Mechanical Surface Detection Mode	enabled
Optical Surface Detection Mode	disabled
Probe Overall Length	337 mm
Probe Body Diameter	10 mm
Tip Length	10 mm
Tip Diameter	4 mm
Probe Tip to Sensor X Calibration Point	2 mm
Probe Tip to Sensor Y Calibration Point	2 mm
Probe Tip to Sensor Z Calibration Point	2 mm
Recommended Measurement Distance from Surface	3 mm

ES3DV2 - SN:3019

February 08, 2024

Parameters of Probe: ES3DV2 - SN:3019

Calibration Parameter Determined in Head Tissue Simulating Media

f (MHz) ^C	Relative Permittivity ^F	Conductivity ^F (S/m)	ConvF X	ConvF Y	ConvF Z	Alpha ^G	Depth ^G (mm)	Unc (k = 2)
150	52.3	0.76	7.38	7.38	7.38	0.00	2.00	±13.3%
450	43.5	0.87	6.76	6.76	6.76	0.16	1.30	±13.3%

^C Frequency validity above 300MHz of ±100 MHz only applies for DASY v4.4 and higher (see Page 2), else it is restricted to ±50MHz. The uncertainty is the RSS of the ConvF uncertainty at calibration frequency and the uncertainty for the indicated frequency band. Frequency validity below 300MHz is ±10, 25, 40, 50 and 70 MHz for ConvF assessments at 30, 64, 128, 150 and 220MHz respectively. Validity of ConvF assessed at 6MHz is 4–9MHz, and ConvF assessed at 13 MHz is 9–19 MHz. Above 5 GHz frequency validity can be extended to ±110MHz.

^F The probes are calibrated using tissue simulating liquids (TSL) that deviate for ϵ and σ by less than ±5% from the target values (typically better than ±3%) and are valid for TSL with deviations of up to ±10% if SAR correction is applied.

^G Alpha/Depth are determined during calibration. SPEAG warrants that the remaining deviation due to the boundary effect after compensation is always less than ±1% for frequencies below 3GHz and below ±2% for frequencies between 3–6GHz at any distance larger than half the probe tip diameter from the boundary.

ES3DV2 - SN:3019

February 08, 2024

Parameters of Probe: ES3DV2 - SN:3019

Calibration Parameter Determined in Body Tissue Simulating Media

f (MHz) ^C	Relative Permittivity ^F	Conductivity ^F (S/m)	ConvF X	ConvF Y	ConvF Z	Alpha ^G	Depth ^G (mm)	Unc (k = 2)
150	61.9	0.80	7.15	7.15	7.15	0.00	1.00	±13.3%

^C Frequency validity above 300MHz of ±100 MHz only applies for DASy v4.4 and higher (see Page 2), else it is restricted to ±50MHz. The uncertainty is the RSS of the ConvF uncertainty at calibration frequency and the uncertainty for the indicated frequency band. Frequency validity below 300MHz is ±10, 25, 40, 50 and 70 MHz for ConvF assessments at 30, 64, 128, 150 and 220MHz respectively. Validity of ConvF assessed at 6MHz is 4–9MHz, and ConvF assessed at 13MHz is 9–19MHz. Above 5 GHz frequency validity can be extended to ±110MHz.

^F The probes are calibrated using tissue simulating liquids (TSL) that deviate for ϵ and σ by less than ±5% from the target values (typically better than ±3%) and are valid for TSL with deviations of up to ±10% if SAR correction is applied.

^G Alpha/Depth are determined during calibration. SPEAG warrants that the remaining deviation due to the boundary effect after compensation is always less than ±1% for frequencies below 3GHz and below ±2% for frequencies between 3–6 GHz at any distance larger than half the probe tip diameter from the boundary.

ES3DV2 - SN:3019

February 08, 2024

Frequency Response of E-Field

(TEM-Cell:ifi110 EXX, Waveguide:R22)

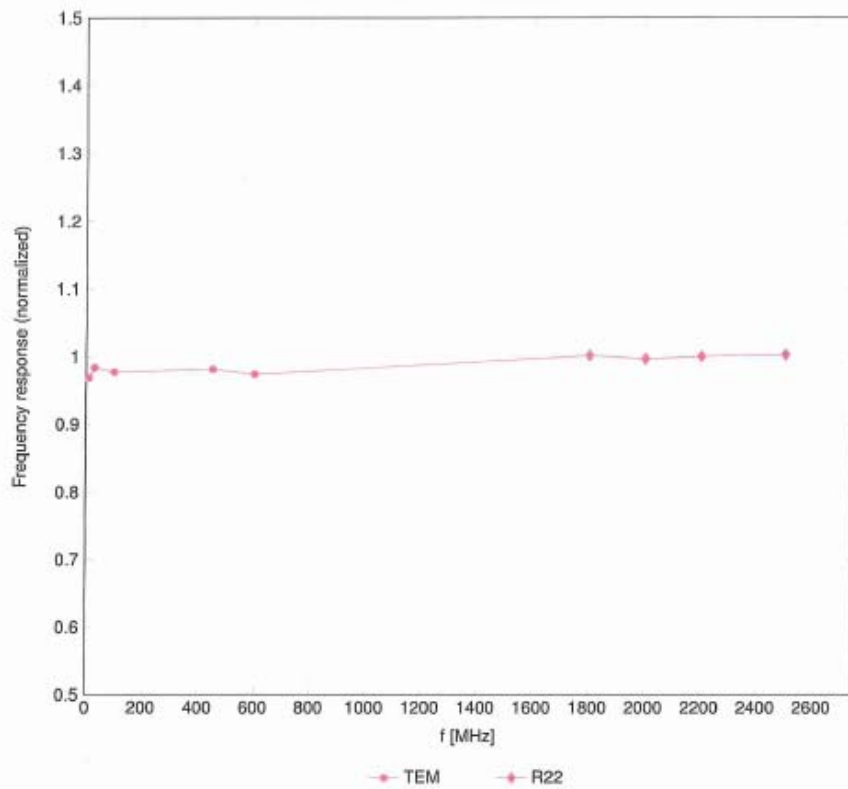

Uncertainty of Frequency Response of E-field: $\pm 6.3\%$ (k=2)

ES3DV2 - SN:3019

February 08, 2024

Receiving Pattern (ϕ), $\theta = 0^\circ$

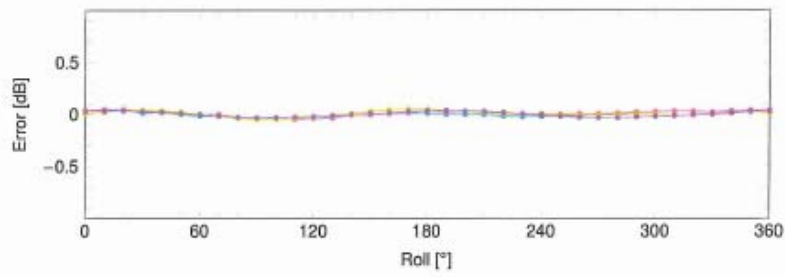
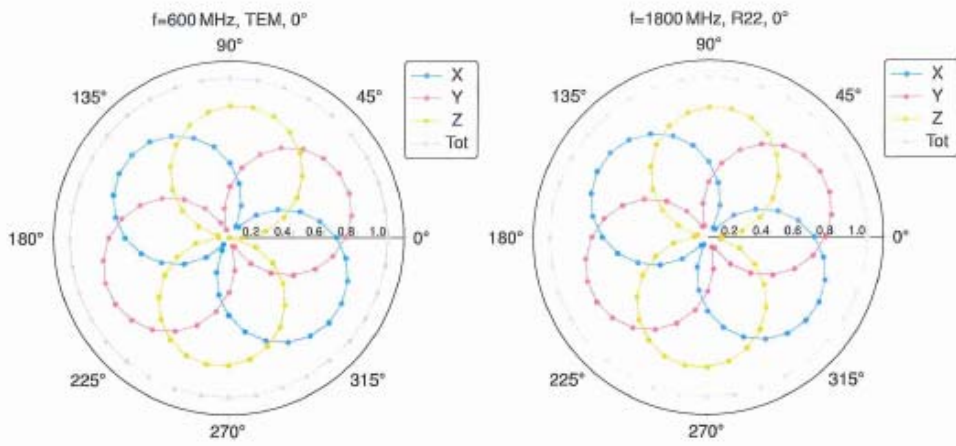

Uncertainty of Axial Isotropy Assessment: $\pm 0.5\%$ ($k=2$)

ES3DV2 - SN:3019

February 08, 2024

Dynamic Range f(SAR_{head})

(TEM cell, $f_{eval} = 1900\text{ MHz}$)

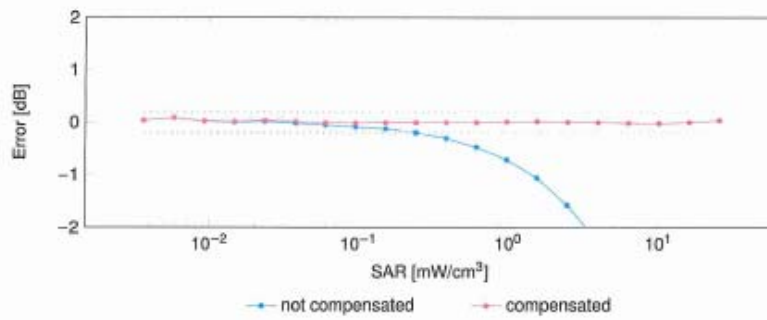
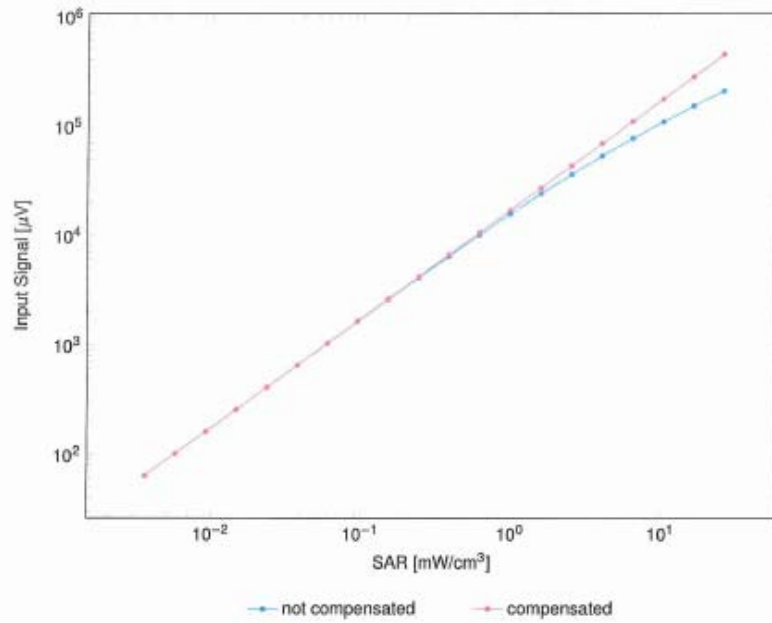

Uncertainty of Linearity Assessment: $\pm 0.6\%$ (k=2)

ES3DV2 - SN:3019

February 08, 2024

Conversion Factor Assessment

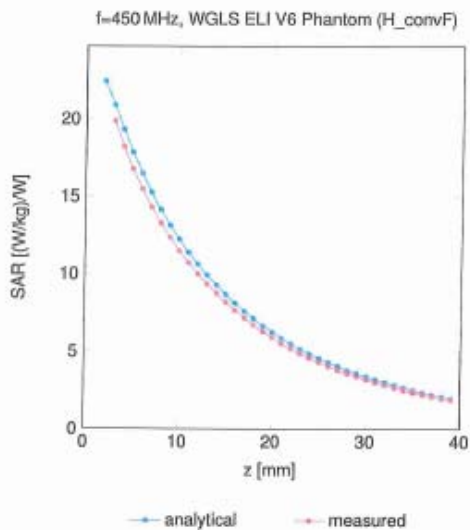

Deviation from Isotropy in Liquid

Error (ϕ, θ), f = 900MHz

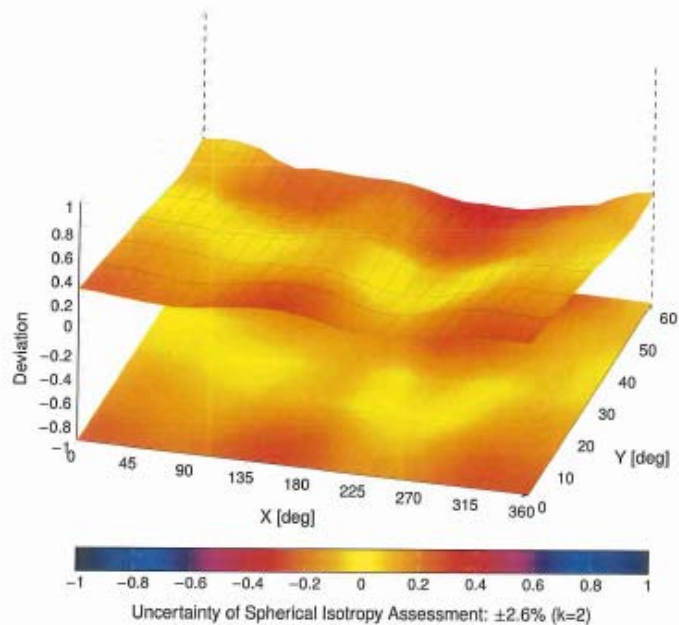

DIPOLE CALIBRATION CERTIFICATES

Calibration Laboratory of
 Schmid & Partner
 Engineering AG
 Zeughausstrasse 43, 8004 Zurich, Switzerland



S Schweizerischer Kalibrierdienst
 C Service suisse d'étalonnage
 S Servizio svizzero di taratura
 S Swiss Calibration Service

Accredited by the Swiss Accreditation Service (SAS)
 The Swiss Accreditation Service is one of the signatories to the EA
 Multilateral Agreement for the recognition of calibration certificates

Accreditation No.: SCS 0108

Client **BACL USA**

Certificate No: **D450V3-1096_Nov22**

CALIBRATION CERTIFICATE			
Object	D450V3 - SN:1096		
Calibration procedure(s)	QA CAL-15.v9 Calibration Procedure for SAR Validation Sources below 700 MHz		
Calibration date:	November 17, 2022		
This calibration certificate documents the traceability to national standards, which realize the physical units of measurements (SI). The measurements and the uncertainties with confidence probability are given on the following pages and are part of the certificate.			
All calibrations have been conducted in the closed laboratory facility: environment temperature (22 ± 3)°C and humidity < 70%.			
Calibration Equipment used (M&TE critical for calibration)			
Primary Standards	ID #	Cal Date (Certificate No.)	Scheduled Calibration
Power meter NRP	SN: 104778	04-Apr-22 (No. 217-03525/03524)	Apr-23
Power sensor NRP-Z91	SN: 103244	04-Apr-22 (No. 217-03524)	Apr-23
Power sensor NRP-Z91	SN: 103245	04-Apr-22 (No. 217-03525)	Apr-23
Reference 20 dB Attenuator	SN: CC2552 (20x)	04-Apr-22 (No. 217-03527)	Apr-23
Type-N mismatch combination	SN: 310982 / 06327	04-Apr-22 (No. 217-03528)	Apr-23
Reference Probe EX3DV4	SN: 3877	31-Dec-21 (No. EX3-3877_Dec21)	Dec-22
DAE4	SN: 654	26-Jan-22 (No. DAE4-654_Jan22)	Jan-23
Secondary Standards	ID #	Check Date (in house)	Scheduled Check
Power meter E4419D	SN: GB41293874	06-Apr-16 (in house check Jun-22)	In house check: Jun-24
Power sensor E4412A	SN: MY41498087	06-Apr-16 (in house check Jun-22)	In house check: Jun-24
Power sensor E4412A	SN: 000110210	06-Apr-16 (in house check Jun-22)	In house check: Jun-24
RF generator HP 8648C	SN: US3642U01700	04-Aug-99 (in house check Jun-22)	In house check: Jun-24
Network Analyzer Agilent E8358A	SN: US41080477	31-Mar-14 (in house check Oct-22)	In house check: Oct-24
Calibrated by:	Name Aldonia Georgiadou	Function Laboratory Technician	Signature
Approved by:	Name Sven Kühn	Technical Manager	
This calibration certificate shall not be reproduced except in full without written approval of the laboratory.			Issued: November 17, 2022

Certificate No: D450V3-1096_Nov22

Page 1 of 8

Calibration Laboratory of
 Schmid & Partner
 Engineering AG
 Zeughausstrasse 43, 8004 Zurich, Switzerland



S Schweizerischer Kalibrierdienst
C Service suisse d'étalonnage
S Servizio svizzero di taratura
S Swiss Calibration Service

Accredited by the Swiss Accreditation Service (SAS)
 The Swiss Accreditation Service is one of the signatories to the EA
 Multilateral Agreement for the recognition of calibration certificates

Accreditation No.: SCS 0108

Glossary:

TSL tissue simulating liquid
 ConvF sensitivity in TSL / NORM x,y,z
 N/A not applicable or not measured

Calibration is Performed According to the Following Standards:

- a) IEC/IEEE 62209-1528, "Measurement Procedure For The Assessment Of Specific Absorption Rate Of Human Exposure To Radio Frequency Fields From Hand-Held And Body-Worn Wireless Communication Devices - Part 1528: Human Models, Instrumentation And Procedures (Frequency Range of 4 MHz to 10 GHz)", October 2020.
- b) KDB 865664, "SAR Measurement Requirements for 100 MHz to 6 GHz"

Additional Documentation:

- c) DASY System Handbook

Methods Applied and Interpretation of Parameters:

- *Measurement Conditions:* Further details are available from the Validation Report at the end of the certificate. All figures stated in the certificate are valid at the frequency indicated.
- *Antenna Parameters with TSL:* The source is mounted in a touch configuration below the center marking of the flat phantom.
- *Return Loss:* This parameter is measured with the source positioned under the liquid filled phantom (as described in the measurement condition clause). The Return Loss ensures low reflected power. No uncertainty required.
- *SAR measured:* SAR measured at the stated antenna input power.
- *SAR normalized:* SAR as measured, normalized to an input power of 1 W at the antenna connector.
- *SAR for nominal TSL parameters:* The measured TSL parameters are used to calculate the nominal SAR result.

The reported uncertainty of measurement is stated as the standard uncertainty of measurement multiplied by the coverage factor k=2, which for a normal distribution corresponds to a coverage probability of approximately 95%.

Measurement Conditions

DASY system configuration, as far as not given on page 1.

DASY Version	DASY52	V52.10.4
Extrapolation	Advanced Extrapolation	
Phantom	ELI4 Flat Phantom	Shell thickness: 2 ± 0.2 mm
Distance Dipole Center - TSL	15 mm	with Spacer
Zoom Scan Resolution	dx, dy, dz = 5 mm	
Frequency	450 MHz ± 1 MHz	

Head TSL parameters

The following parameters and calculations were applied.

	Temperature	Permittivity	Conductivity
Nominal Head TSL parameters	22.0 °C	43.5	0.87 mho/m
Measured Head TSL parameters	(22.0 ± 0.2) °C	43.4 ± 6 %	0.88 mho/m ± 6 %
Head TSL temperature change during test	< 0.5 °C	---	---

SAR result with Head TSL

SAR averaged over 1 cm ³ (1 g) of Head TSL	Condition	
SAR measured	250 mW input power	1.15 W/kg
SAR for nominal Head TSL parameters	normalized to 1W	4.56 W/kg ± 18.1 % (k=2)

SAR averaged over 10 cm ³ (10 g) of Head TSL	condition	
SAR measured	250 mW input power	0.766 W/kg
SAR for nominal Head TSL parameters	normalized to 1W	3.04 W/kg ± 17.6 % (k=2)

Body TSL parameters

The following parameters and calculations were applied.

	Temperature	Permittivity	Conductivity
Nominal Body TSL parameters	22.0 °C	56.7	0.94 mho/m
Measured Body TSL parameters	(22.0 ± 0.2) °C	56.2 ± 6 %	0.93 mho/m ± 6 %
Body TSL temperature change during test	< 0.5 °C	---	---

SAR result with Body TSL

SAR averaged over 1 cm ³ (1 g) of Body TSL	Condition	
SAR measured	250 mW input power	1.14 W/kg
SAR for nominal Body TSL parameters	normalized to 1W	4.59 W/kg ± 18.1 % (k=2)

SAR averaged over 10 cm ³ (10 g) of Body TSL	condition	
SAR measured	250 mW input power	0.768 W/kg
SAR for nominal Body TSL parameters	normalized to 1W	3.09 W/kg ± 17.6 % (k=2)

Appendix (Additional assessments outside the scope of SCS 0108)

Antenna Parameters with Head TSL

Impedance, transformed to feed point	56.1 Ω - 5.9 $j\Omega$
Return Loss	- 22.0 dB

Antenna Parameters with Body TSL

Impedance, transformed to feed point	53.2 Ω - 9.7 $j\Omega$
Return Loss	- 20.1 dB

General Antenna Parameters and Design

Electrical Delay (one direction)	1.347 ns
----------------------------------	----------

After long term use with 100W radiated power, only a slight warming of the dipole near the feedpoint can be measured.

The dipole is made of standard semirigid coaxial cable. The center conductor of the feeding line is directly connected to the second arm of the dipole. The antenna is therefore short-circuited for DC-signals. On some of the dipoles, small end caps are added to the dipole arms in order to improve matching when loaded according to the position as explained in the "Measurement Conditions" paragraph. The SAR data are not affected by this change. The overall dipole length is still according to the Standard.

No excessive force must be applied to the dipole arms, because they might bend or the soldered connections near the feedpoint may be damaged.

Additional EUT Data

Manufactured by	SPEAG
-----------------	-------

DASY5 Validation Report for Head TSL

Date: 17.11.2022

Test Laboratory: SPEAG, Zurich, Switzerland

DUT: Dipole 450 MHz; Type: D450V3; Serial: D450V3 - SN:1096

Communication System: UID 0 - CW; Frequency: 450 MHz
Medium parameters used: $f = 450 \text{ MHz}$; $\sigma = 0.88 \text{ S/m}$; $\epsilon_r = 43.4$; $\rho = 1000 \text{ kg/m}^3$
Phantom section: Flat Section
Measurement Standard: DASY5 (IEEE/IEC/ANSI C63.19-2011)

DASY52 Configuration:

- Probe: EX3DV4 - SN3877; ConvF(10.64, 10.64, 10.64) @ 450 MHz; Calibrated: 31.12.2021
- Sensor-Surface: 1.4mm (Mechanical Surface Detection)
- Electronics: DAE4 Sn654; Calibrated: 26.01.2022
- Phantom: ELI v4.0; Type: QDOVA001BB; Serial: TP:1003
- DASY52 52.10.4(1535); SEMCAD X 14.6.14(7501)

Dipole Calibration for Head Tissue/d=15mm, Pin=250mW/Zoom Scan (7x7x7)/Cube 0:

Measurement grid: $dx=5\text{mm}$, $dy=5\text{mm}$, $dz=5\text{mm}$
Reference Value = 38.88 V/m; Power Drift = 0.00 dB
Peak SAR (extrapolated) = 1.79 W/kg
SAR(1 g) = 1.15 W/kg; SAR(10 g) = 0.766 W/kg
Smallest distance from peaks to all points 3 dB below: Larger than measurement grid ($> 15 \text{ mm}$)
Ratio of SAR at M2 to SAR at M1 = 64.3%
Maximum value of SAR (measured) = 1.56 W/kg



Impedance Measurement Plot for Head TSL

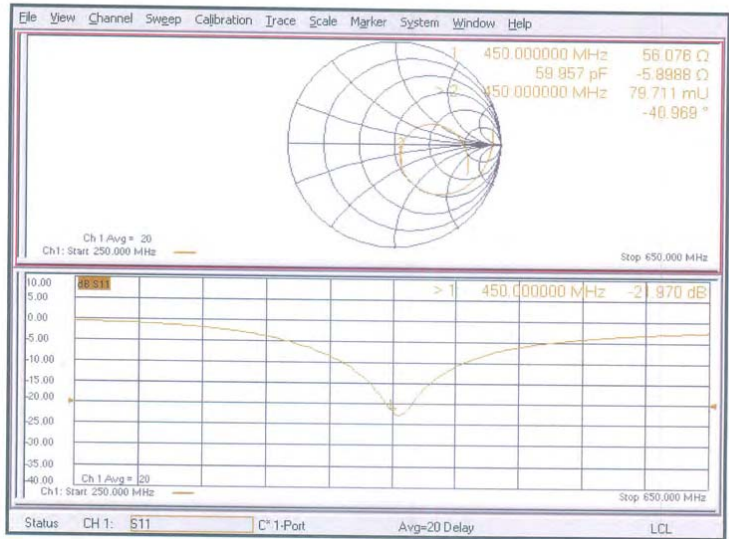

DASY5 Validation Report for Body TSL

Date: 17.11.2022

Test Laboratory: SPEAG, Zurich, Switzerland

DUT: Dipole 450 MHz; Type: D450V3; Serial: D450V3 - SN:1096

Communication System: UID 0 - CW; Frequency: 450 MHz
 Medium parameters used: $f = 450 \text{ MHz}$; $\sigma = 0.93 \text{ S/m}$; $\epsilon_r = 56.2$; $\rho = 1000 \text{ kg/m}^3$
 Phantom section: Flat Section
 Measurement Standard: DASY5 (IEEE/IEC/ANSI C63.19-2011)

DASY52 Configuration:

- Probe: EX3DV4 - SN3877; ConvF(10.64, 10.64, 10.64) @ 450 MHz; Calibrated: 31.12.2021
- Sensor-Surface: 1.4mm (Mechanical Surface Detection)
- Electronics: DAE4 Sn654; Calibrated: 26.01.2022
- Phantom: ELI v4.0; Type: QDOVA001BB; Serial: TP:1003
- DASY52 52.10.4(1535); SEMCAD X 14.6.14(7501)

Dipole Calibration for Body Tissue/d=15mm, Pin=250mW/Zoom Scan (7x7x7)/Cube 0:

Measurement grid: $dx=5\text{mm}$, $dy=5\text{mm}$, $dz=5\text{mm}$
 Reference Value = 42.04 V/m; Power Drift = -0.04 dB
 Peak SAR (extrapolated) = 1.74 W/kg
SAR(1 g) = 1.14 W/kg; SAR(10 g) = 0.768 W/kg
 Smallest distance from peaks to all points 3 dB below: Larger than measurement grid (> 15 mm)
 Ratio of SAR at M2 to SAR at M1 = 65.8%
 Maximum value of SAR (measured) = 1.53 W/kg

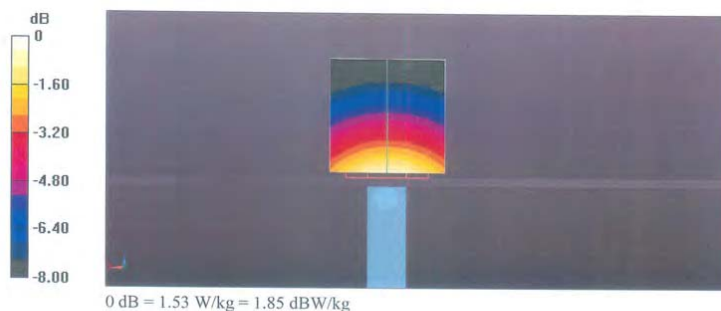

Impedance Measurement Plot for Body TSL

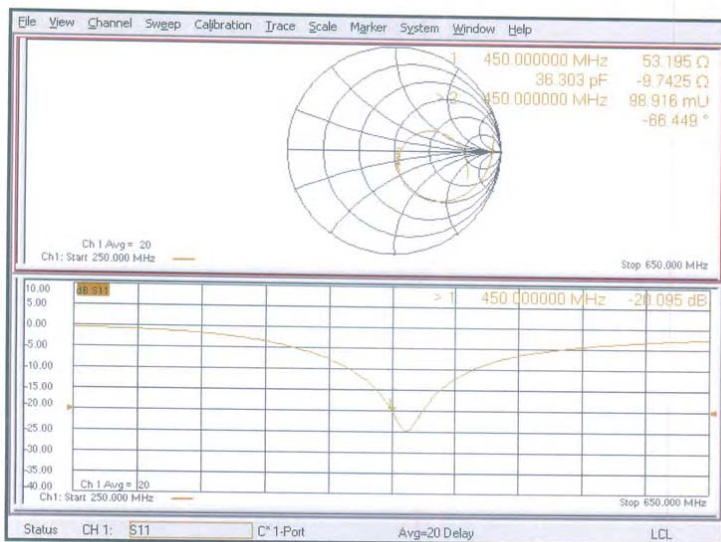

D450V3 - SN:1096 Extended Dipole Calibrations

Referring to KDB 865664 D01, if dipoles are verified in return loss(< -20dB, within 20% of prior calibration), and in impedance(within 5 ohm of prior calibration), the annual calibration is not necessary and the calibration interval can be extended.

Justification of the extended calibration

D450V3 - SN:1096						
450MHz Head						
Date of Measurement	Return-Loss (dB)	Delta (%)	Real Impedance (ohm)	Delta (ohm)	Imaginary Impedance (ohm)	Delta (ohm)
2022/11/17 (Cal. Report)	-21.97	/	56.076	/	-5.8988	/
2023/11/15 (Extended)	-21.435	2.44%	59.227	-3.151	-4.2414	-1.6574

The return loss is <-20dB, within 20% of prior calibration; the impedance is within 5 ohm of prior calibration. Therefore the verification result should support extended calibration.

Dipole Verification Data> D450V3 - SN:1096 (Date of Measurement: 2023/11/15)

450MHz - Head

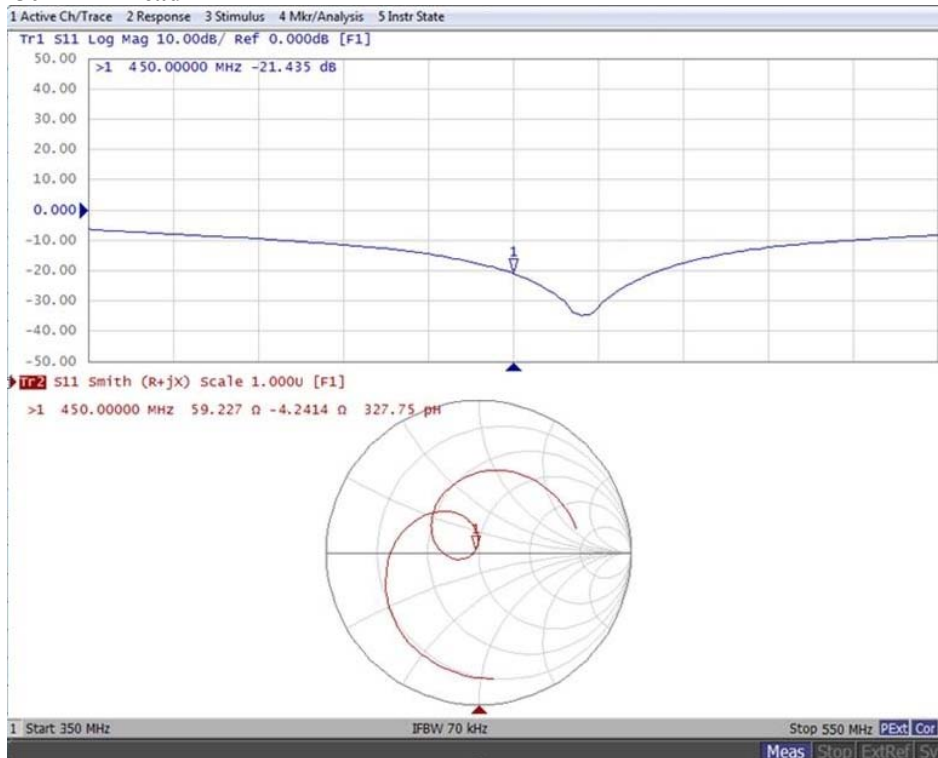

	Name	Title	Signature
Measure By:	Mark Dong	SAR Engineer	<i>Mark Dong</i>

=====**END OF REPORT**=====