

# FCC RADIO TEST REPORT

## FCC 47 CFR PART 15 SUBPART C

<b>Test Standard</b>	<b>FCC Part 15.247</b>
<b>Brand name</b>	<b>WattBox</b>
<b>Product name</b>	<b>WattBox IP Power Strip w/ Wi-Fi   1 Controlled Bank (2 Outlets); WattBox IP Power Strip   1 Controlled Bank (2 Outlets)</b>
<b>Model No.</b>	<b>WB-150-IPW-1B-2; WB-150-IP-1B-2</b>
<b>Test Result</b>	<b>Pass</b>

The test Result was tested by Compliance Certification Services Inc. The test data, data evaluation, test procedures, and equipment configurations shown in this report were given in ANSI C63.10: 2013 and compliance standards.

The test results of this report relate only to the tested sample (EUT) identified in this report.

The test Report of full or partial shall not copy. Without written approval of Compliance Certification Services Inc. (Wugu Laboratory)

Approved by:

Tested by:



---

Kevin Tsai  
Deputy Manager

---

Jerry Chuang  
Engineer

Unless otherwise stated the results shown in this test report refer only to the sample(s) tested and such sample(s) are retained for 90 days only.  
除非另有說明，此報告結果僅對測試之樣品負責，同時此樣品僅保留90天。本報告未經本公司書面許可，不可部分複製。

This document is issued by the Company subject to its General Conditions of Service printed overleaf, available on request or accessible at [www.sgs.com/terms\\_and\\_conditions.htm](http://www.sgs.com/terms_and_conditions.htm) and for electronic format documents, subject to Terms and Conditions for Electronic Documents at [www.sgs.com/terms\\_e-document.htm](http://www.sgs.com/terms_e-document.htm). Attention is drawn to the limitation of liability, indemnification and jurisdiction issues defined therein. Any holder of this document is advised that information contained hereon reflects the Company's findings at the time of its intervention only and within the limits of Client's instructions, if any. The Company's sole responsibility is to its Client and this document does not exonerate parties to a transaction from exercising all their rights and obligations under the transaction documents. This document cannot be reproduced except in full, without prior written approval of the Company. Any unauthorized alteration, forgery or falsification of the content or appearance of this document is unlawful and offenders may be prosecuted to the fullest extent of the law.



Report No.: T181220D08-RP

Page: 2 / 93

Rev.: 01

## Revision History

Rev.	Issue Date	Revisions	Effect Page	Revised By
00	March 5, 2019	Initial Issue	ALL	Allison Chen
01	March 13, 2019	1. Revised Applicant company name.	P.4	Allison Chen

## Table of contents

<b>1.</b>	<b>GENERAL INFORMATION .....</b>	<b>4</b>
<b>1.1</b>	<b>EUT INFORMATION.....</b>	<b>4</b>
<b>1.2</b>	<b>EUT CHANNEL INFORMATION .....</b>	<b>5</b>
<b>1.3</b>	<b>ANTENNA INFORMATION .....</b>	<b>5</b>
<b>1.4</b>	<b>MEASUREMENT UNCERTAINTY .....</b>	<b>6</b>
<b>1.5</b>	<b>FACILITIES AND TEST LOCATION .....</b>	<b>6</b>
<b>1.6</b>	<b>INSTRUMENT CALIBRATION .....</b>	<b>7</b>
<b>1.7</b>	<b>SUPPORT AND EUT ACCESSORIES EQUIPMENT.....</b>	<b>8</b>
<b>1.8</b>	<b>TEST METHODOLOGY AND APPLIED STANDARDS.....</b>	<b>8</b>
<b>2.</b>	<b>TEST SUMMARY .....</b>	<b>9</b>
<b>3.</b>	<b>DESCRIPTION OF TEST MODES .....</b>	<b>10</b>
<b>3.1</b>	<b>THE WORST MODE OF OPERATING CONDITION.....</b>	<b>10</b>
<b>3.2</b>	<b>THE WORST MODE OF MEASUREMENT .....</b>	<b>11</b>
<b>3.3</b>	<b>EUT DUTY CYCLE .....</b>	<b>12</b>
<b>4.</b>	<b>TEST RESULT.....</b>	<b>13</b>
<b>4.1</b>	<b>AC POWER LINE CONDUCTED EMISSION.....</b>	<b>13</b>
<b>4.2</b>	<b>6dB BANDWIDTH AND OCCUPIED BANDWIDTH (99%).....</b>	<b>16</b>
<b>4.3</b>	<b>OUTPUT POWER MEASUREMENT .....</b>	<b>26</b>
<b>4.4</b>	<b>POWER SPECTRAL DENSITY .....</b>	<b>29</b>
<b>4.5</b>	<b>CONDUCTED BANDEDGE AND SPURIOUS EMISSION.....</b>	<b>35</b>
<b>4.6</b>	<b>RADIATION BANDEDGE AND SPURIOUS EMISSION.....</b>	<b>48</b>
<b>APPENDIX I PHOTOGRAPHS OF EUT</b>		

Report No.: T181220D08-RP

# 1. GENERAL INFORMATION

## 1.1 EUT INFORMATION

Applicant	Wirepath Home Systems, LLC, DBA SnapAV 1800 Continental Blvd Suite 200 Charlotte, North Carolina 28273 USA		
Manufacturer	Emplus Technologies, Inc. NO. 42, SEC. 1, MINSHENG NORTH RD, GUISHAN DISTRICT, TAOYUAN CITY 33391, TAIWAN		
Equipment	WattBox IP Power Strip w/ Wi-Fi   1 Controlled Bank (2 Outlets); WattBox IP Power Strip   1 Controlled Bank (2 Outlets)		
Model No.	WB-150-IPW-1B-2; WB-150-IP-1B-2		
Model Discrepancy	Difference of the two model numbers (list on this report) are just for printed model on housing, please see as below:		
	Product name	WattBox IP Power Strip w/ Wi-Fi   1 Controlled Bank (2 Outlets)	WattBox IP Power Strip   1 Controlled Bank (2 Outlets)
	Model No.	WB-150-IPW-1B-2	WB-150-IP-1B-2
Received Date	December 20, 2018		
Date of Test	December 21 ~ 24, 2018		
Output Power(W)	IEEE 802.11b Mode: 0.1371 IEEE 802.11g Mode: 0.2624 IEEE 802.11n HT20 Mode: 0.2649 IEEE 802.11n HT40 Mode: 0.2399		
Power Supply	I/P: 120Vac, 12A, 50/60Hz O/P: 120Vac, 12A, 50/60Hz		

Report No.: T181220D08-RP

## 1.2 EUT CHANNEL INFORMATION

Frequency Range	802.11b/g/n HT 20: 2412MHz ~ 2462MHz 802.11n HT 40: 2422MHz ~ 2452MHz
Modulation Type	1. IEEE 802.11b Mode: DSSS(DBPSK/DQPSK/CCK) 2. IEEE 802.11g Mode: OFDM (BPSK/QPSK/16QAM/64QAM) 3. IEEE 802.11n HT20 Mode : OFDM (BPSK/QPSK/16QAM/64QAM) 4. IEEE 802.11n HT40 Mode : OFDM (BPSK/QPSK/16QAM/64QAM)
Number of channel	1. IEEE 802.11b Mode: 11 Channels 2. IEEE 802.11g Mode: 11 Channels 3. IEEE 802.11n HT20 Mode : 11 Channels 4. IEEE 802.11n HT40 Mode : 7 Channels

**Remark:**

Refer as ANSI C63.10:2013 clause 5.6.1 Table 4 for test channels

Number of frequencies to be tested		
Frequency range in which device operates	Number of frequencies	Location in frequency range of operation
<input type="checkbox"/> 1 MHz or less	1	Middle
<input type="checkbox"/> 1 MHz to 10 MHz	2	1 near top and 1 near bottom
<input checked="" type="checkbox"/> More than 10 MHz	3	1 near top, 1 near middle, and 1 near bottom

## 1.3 ANTENNA INFORMATION

Antenna Type	<input checked="" type="checkbox"/> PIFA <input type="checkbox"/> PCB <input type="checkbox"/> Dipole <input type="checkbox"/> Coils
Antenna Gain	0.5 dBi
Antenna Connector	N/A

## 1.4 MEASUREMENT UNCERTAINTY

PARAMETER	UNCERTAINTY
AC Powerline Conducted Emission	+/- 1.2575
Emission bandwidth, 20dB bandwidth	+/- 0.0014
RF output power, conducted	+/- 1.14
Power density, conducted	+/- 1.40
3M Semi Anechoic Chamber / 30M~200M	+/- 4.12
3M Semi Anechoic Chamber / 200M~1000M	+/- 4.68
3M Semi Anechoic Chamber / 1G~8G	+/- 5.18
3M Semi Anechoic Chamber / 8G~18G	+/- 5.47
3M Semi Anechoic Chamber / 18G~26G	+/- 3.81
3M Semi Anechoic Chamber / 26G~40G	+/- 3.87

**Remark:**

1. This uncertainty represents an expanded uncertainty expressed at approximately the 95% confidence level using a coverage factor of  $k=2$
2. ISO/IEC 17025 requires that an estimate of the measurement uncertainties associated with the emissions test results be included in the report.

## 1.5 FACILITIES AND TEST LOCATION

All measurement facilities used to collect the measurement data are located at

No.11, Wugong 6th Rd., Wugu Dist., New Taipei City 24891, Taiwan. (R.O.C.)

Test site	Test Engineer	Remark
AC Conduction Room	Dally Hong	-
Radiation	Jerry Chuang	-
RF Conducted	Jerry Chuang	-

**Remark:** The sites are constructed in conformance with the requirements of ANSI C63.7, ANSI C63.4 and CISPR Publication 22.

Report No.: T181220D08-RP

## 1.6 INSTRUMENT CALIBRATION

RF Conducted Test Site					
Equipment	Manufacturer	Model	S/N	Cal Date	Cal Due
Power Meter	Anritsu	ML2495A	1149001	02/06/2018	02/05/2019
Power Sensor	Anritsu	MA2491A	030982	02/07/2018	02/06/2019
Signal Analyzer	R&S	FSV 40	101073	09/27/2018	09/26/2019

3M 966 Chamber Test Site					
Equipment	Manufacturer	Model	S/N	Cal Date	Cal Due
Band Reject Filters	MICRO TRONICS	BRM 50702	120	05/14/2018	05/13/2019
Bilog Antenna	Sunol Sciences	JB3	A030105	07/13/2018	07/12/2019
Cable	HUBER SUHNER	SUCOFLEX 104PEA	25157	06/29/2018	06/28/2019
Cable	HUBER SUHNER	SUCOFLEX 104PEA	20995	06/29/2018	06/28/2019
Digital Thermo-Hygro Meter	WISEWIND	1206	D07	02/08/2018	02/07/2019
double Ridged Guide Horn Antenna	ETC	MCTD 1209	DRH13M02003	08/20/2018	08/19/2019
Loop Ant	COM-POWER	AL-130	121051	03/21/2018	03/20/2019
Pre-Amplifier	EMEC	EM330	060609	06/29/2018	06/28/2019
Pre-Amplifier	HP	8449B	3008A00965	06/29/2018	06/28/2019
PSA Series Spectrum Analyzer	Agilent	E4446A	MY46180323	05/31/2018	05/30/2019
Antenna Tower	CCS	CC-A-1F	N/A	N.C.R	N.C.R
Controller	CCS	CC-C-1F	N/A	N.C.R	N.C.R
Turn Table	CCS	CC-T-1F	N/A	N.C.R	N.C.R

AC Conducted Emissions Test Site					
Equipment	Manufacturer	Model	S/N	Cal Date	Cal Due
CABLE	EMCI	CFD300-NL	CERF	06/29/2018	06/28/2019
EMI Test Receiver	R&S	ESCI	100064	07/24/2018	07/23/2019
LISN	SCHWARZBECK	NSLK 8127	8127-541	02/09/2018	02/08/2019
LISN	SCHAFFNER	NNB41	03/10013	02/06/2018	02/05/2019

**Remark:** Each piece of equipment is scheduled for calibration once a year.



Report No.: T181220D08-RP

Page: 8 / 93

Rev.: 01

## 1.7 SUPPORT AND EUT ACCESSORIES EQUIPMENT

EUT Accessories Equipment					
No.	Equipment	Brand	Model	Series No.	FCC ID
	N/A				

Support Equipment					
No.	Equipment	Brand	Model	Series No.	FCC ID
1	NB(L)	Toshiba	PORTEGE R30-A	N/A	PD97260H

## 1.8 TEST METHODOLOGY AND APPLIED STANDARDS

The test methodology, setups and results comply with all requirements in accordance with ANSI C63.10:2013, FCC Part 2, FCC Part 15.247, KDB 558074 D01.



## 2. TEST SUMMARY

FCC Standard Section	Report Section	Test Item	Result
15.203	1.3	Antenna Requirement	Pass
15.207(a)	4.1	AC Conducted Emission	Pass
15.247(a)(2)	4.2	6 dB Bandwidth	Pass
-	4.2	Occupied Bandwidth (99%)	Pass
15.247(b)	4.3	Output Power Measurement	Pass
15.247(e)	4.4	Power Spectral Density	Pass
15.247(d)	4.5	Conducted Band Edge	Pass
15.247(d)	4.5	Conducted Spurious Emission	Pass
15.247(d)	4.6	Radiation Band Edge	Pass
15.247(d)	4.6	Radiation Spurious Emission	Pass

Report No.: T181220D08-RP

### 3. DESCRIPTION OF TEST MODES

#### 3.1 THE WORST MODE OF OPERATING CONDITION

<p>Operation mode</p>	<p>IEEE 802.11b Mode :1Mbps          IEEE 802.11g Mode :6Mbps          IEEE 802.11n HT20 Mode: MCS0          IEEE 802.11n HT40 Mode: MCS0</p>
<p>Test Channel Frequencies</p>	<p><b>IEEE 802.11b Mode:</b>          1. Lowest Channel: 2412MHz          2. Middle Channel: 2437MHz          3. Highest Channel: 2462MHz  <b>IEEE 802.11g Mode:</b>          1. Lowest Channel: 2412MHz          2. Middle Channel: 2437MHz          3. Highest Channel: 2462MHz  <b>IEEE 802.11n HT20 Mode:</b>          1. Lowest Channel: 2412MHz          2. Middle Channel: 2437MHz          3. Highest Channel: 2462MHz  <b>IEEE 802.11n HT40 Mode:</b>          1. Lowest Channel: 2422MHz          2. Middle Channel: 2437MHz          3. Highest Channel: 2452MHz</p>
<p>Operation Transmitter</p>	<p>IEEE 802.11b Mode: 1T1R          IEEE 802.11g Mode: 1T1R          IEEE 802.11n HT20 Mode: 1T1R          IEEE 802.11n HT40 Mode: 1T1R</p>

**Remark:**

1. EUT pre-scanned data rate of output power for each mode, the worst data rate were recorded in this report.

### 3.2 THE WORST MODE OF MEASUREMENT

AC Power Line Conducted Emission	
Test Condition	AC Power line conducted emission for line and neutral
Power supply Mode	Mode 1:EUT power by power cord
Worst Mode	<input checked="" type="checkbox"/> Mode 1 <input type="checkbox"/> Mode 2 <input type="checkbox"/> Mode 3 <input type="checkbox"/> Mode 4

Radiated Emission Measurement Above 1G	
Test Condition	Band edge, Emission for Unwanted and Fundamental
Power supply Mode	Mode 1:EUT power by power cord
Worst Mode	<input checked="" type="checkbox"/> Mode 1 <input type="checkbox"/> Mode 2 <input type="checkbox"/> Mode 3 <input type="checkbox"/> Mode 4
Worst Position	<input type="checkbox"/> Placed in fixed position. <input type="checkbox"/> Placed in fixed position at X-Plane (E2-Plane) <input checked="" type="checkbox"/> Placed in fixed position at Y-Plane (E1-Plane) <input type="checkbox"/> Placed in fixed position at Z-Plane (H-Plane)
Worst Polarity	<input checked="" type="checkbox"/> Horizontal <input type="checkbox"/> Vertical

Radiated Emission Measurement Below 1G	
Test Condition	Radiated Emission Below 1G
Power supply Mode	Mode 1:EUT power by power cord
Worst Mode	<input checked="" type="checkbox"/> Mode 1 <input type="checkbox"/> Mode 2 <input type="checkbox"/> Mode 3 <input type="checkbox"/> Mode 4

*Remark:*

1. The worst mode was record in this test report.
2. EUT pre-scanned in three axis ,X,Y, Z and two polarity, Horizontal and Vertical for radiated measurement. The worst case(Y-Plane and Horizontal) were recorded in this report
3. AC power line conducted emission and for below 1G radiation emission were performed the EUT transmit at the highest output power channel as worse case.

## 3.3 EUT DUTY CYCLE

Duty Cycle			
Configuration	TX ON (ms)	TX ALL (ms)	Duty Cycle (%)
802.11b	8.4400	8.5300	98.94%
802.11g	1.4200	1.4400	98.61%
802.11n HT20	1.3300	1.4300	93.01%
802.11n HT40	0.6800	0.7800	87.18%

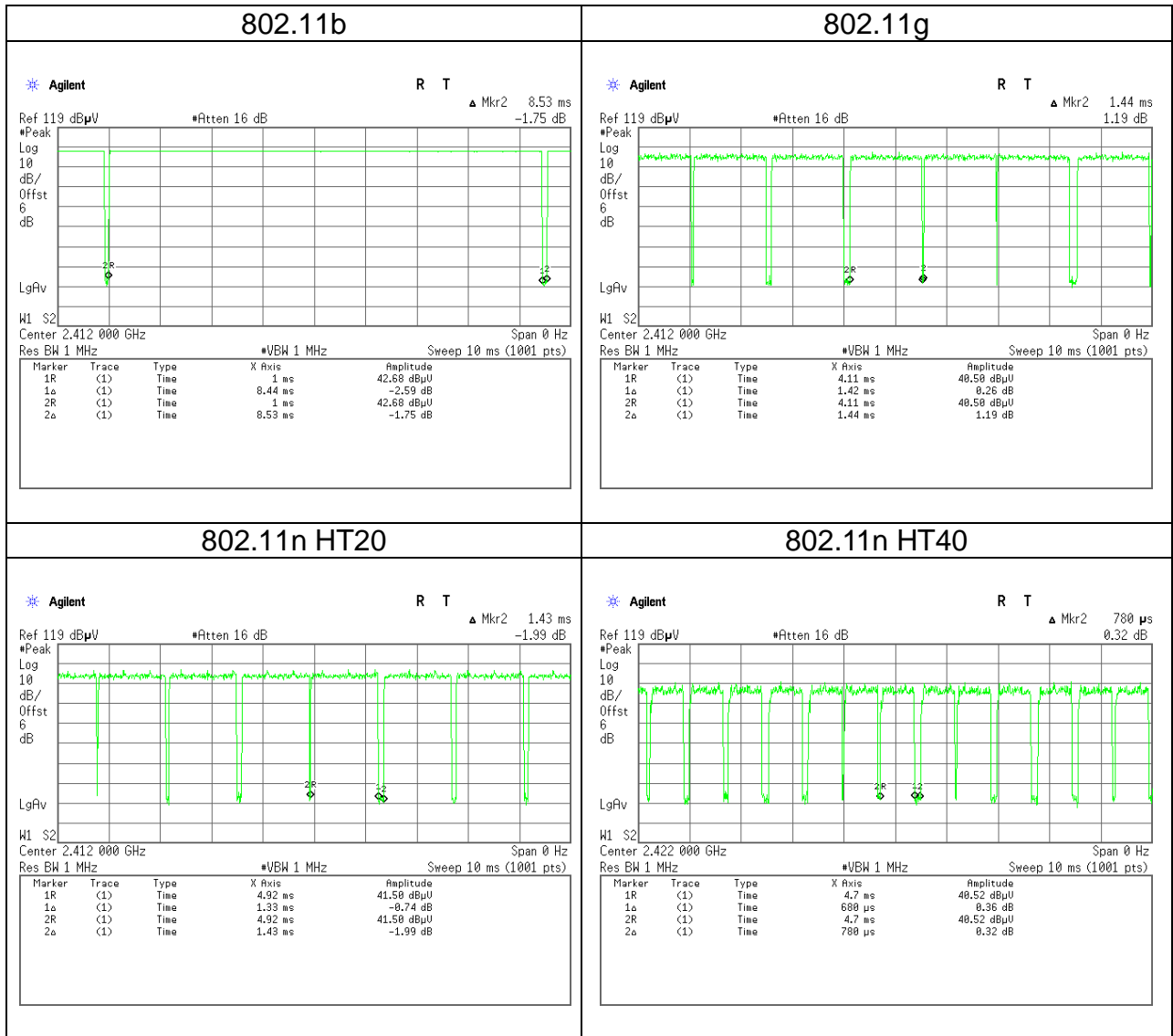

Report No.: T181220D08-RP

## 4. TEST RESULT

### 4.1 AC POWER LINE CONDUCTED EMISSION

#### 4.1.1 Test Limit

According to §15.207(a)(2),

Frequency Range (MHz)	Limits(dBµV)	
	Quasi-peak	Average
0.15 to 0.50	66 to 56*	56 to 46*
0.50 to 5	56	46
5 to 30	60	50

\* Decreases with the logarithm of the frequency.

#### 4.1.2 Test Procedure

Test method Refer as ANSI C63.10:2013 clause 6.2,

1. The EUT was placed on a non-conducted table, which is 0.8m above horizontal ground plane and 0.4m above vertical ground plane.
2. EUT connected to the line impedance stabilization network (LISN)
3. Receiver set RBW of 9kHz and Detector Peak, and note as quasi-peak and average.
4. Maximum procedure was performed on the six highest emissions to ensure EUT compliance.
5. Recorded Line for Neutral and Line.

#### 4.1.3 Test Setup

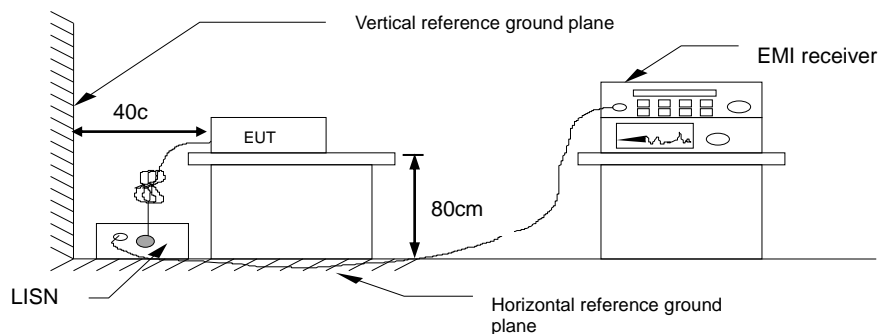

#### 4.1.4 Test Result

**Pass.**

## Test Data

Test Mode:	Mode 1	Temp/Hum	24(°C)/ 50%RH
Test Voltage:	120Vac / 60Hz	Test Date	2018/12/26
Phase:	Line	Test Engineer	Dally Hong

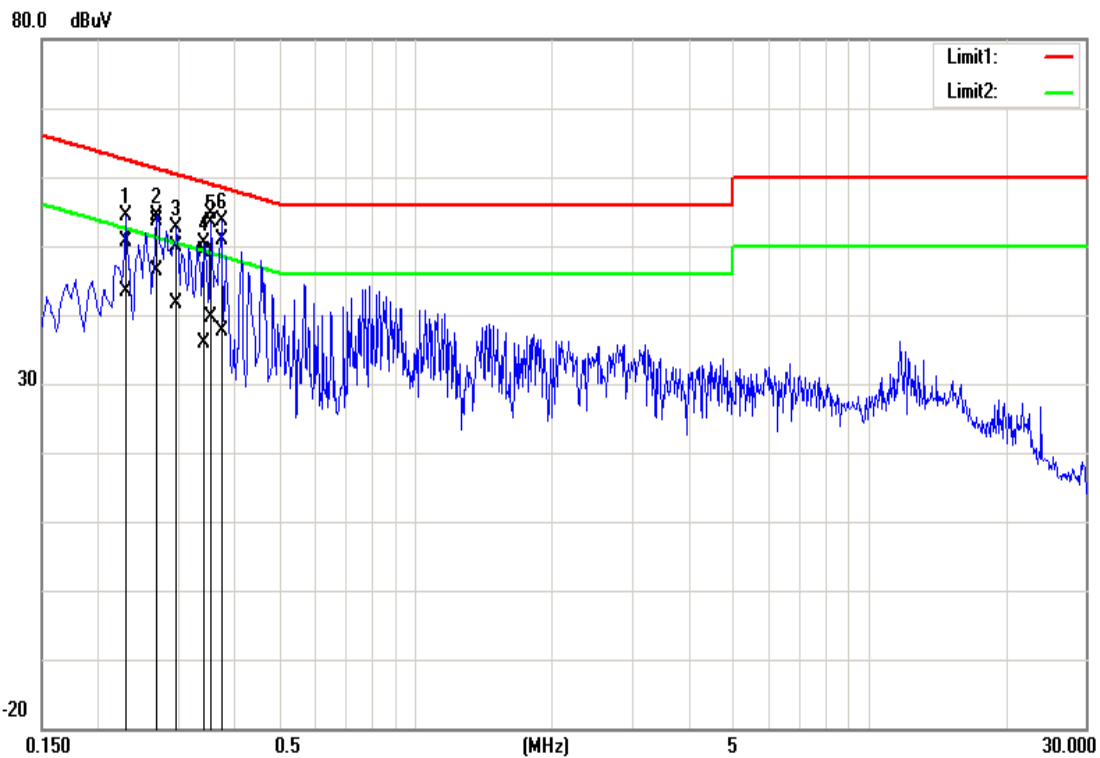

No.	Frequency (MHz)	QuasiPeak reading (dBuV)	Average reading (dBuV)	Correction factor (dB)	QuasiPeak result (dBuV)	Average result (dBuV)	QuasiPeak limit (dBuV)	Average limit (dBuV)	QuasiPeak margin (dB)	Average margin (dB)	Remark
1	0.2300	50.53	43.17	0.16	50.69	43.33	62.45	52.45	-11.76	-9.12	Pass
2	0.2700	53.41	46.19	0.16	53.57	46.35	61.12	51.12	-7.55	-4.77	Pass
3	0.2980	49.76	41.40	0.16	49.92	41.56	60.30	50.30	-10.38	-8.74	Pass
4	0.3420	48.90	35.82	0.18	49.08	36.00	59.15	49.15	-10.07	-13.15	Pass
5*	0.3540	54.33	39.45	0.18	54.51	39.63	58.87	48.87	-4.36	-9.24	Pass
6	0.3740	50.79	37.43	0.18	50.97	37.61	58.41	48.41	-7.44	-10.80	Pass

Report No.: T181220D08-RP

Test Mode:	Mode 1	Temp/Hum	24(°C)/ 50%RH
Test Voltage:	120Vac / 60Hz	Test Date	2018/12/26
Phase:	Neutral	Test Engineer	Dally Hong

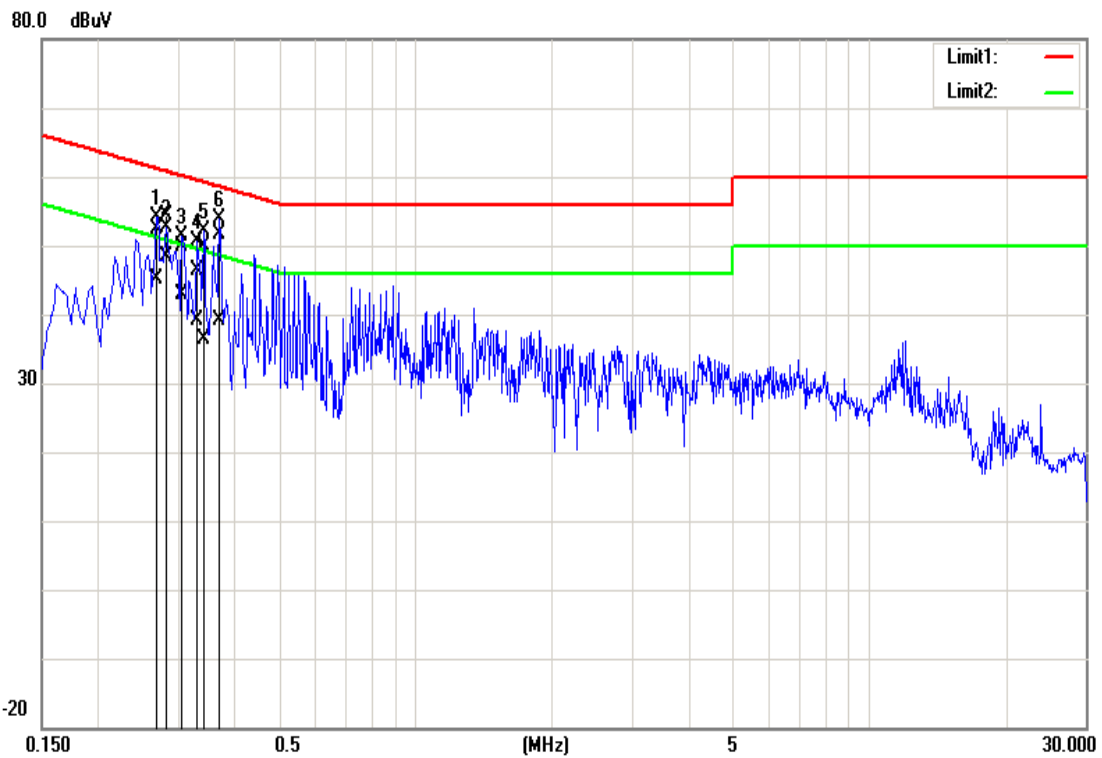

No.	Frequency (MHz)	QuasiPeak reading (dBuV)	Average reading (dBuV)	Correction factor (dB)	QuasiPeak result (dBuV)	Average result (dBuV)	QuasiPeak limit (dBuV)	Average limit (dBuV)	QuasiPeak margin (dB)	Average margin (dB)	Remark
1	0.2700	52.12	44.91	0.18	52.30	45.09	61.12	51.12	-8.82	-6.03	Pass
2*	0.2820	54.32	48.15	0.18	54.50	48.33	60.76	50.76	-6.26	-2.43	Pass
3	0.3060	49.59	42.59	0.19	49.78	42.78	60.08	50.08	-10.30	-7.30	Pass
4	0.3300	46.15	38.86	0.19	46.34	39.05	59.45	49.45	-13.11	-10.40	Pass
5	0.3420	49.68	36.13	0.19	49.87	36.32	59.15	49.15	-9.28	-12.83	Pass
6	0.3700	51.48	38.84	0.19	51.67	39.03	58.50	48.50	-6.83	-9.47	Pass

Report No.: T181220D08-RP

## 4.2 6dB BANDWIDTH AND OCCUPIED BANDWIDTH (99%)

### 4.2.1 Test Limit

According to §15.247(a)(2),

**6 dB Bandwidth** :

Limit	Shall be at least 500kHz
-------	--------------------------

**Occupied Bandwidth(99%)** : For reporting purposes only.

### 4.2.2 Test Procedure

Test method Refer as KDB 558074 D01 and ANSI C63.10: 2013 clause 6.9.2,

1. The EUT RF output connected to the spectrum analyzer by RF cable.
2. Setting maximum power transmit of EUT
3. SA set RBW = 100kHz, VBW = 300kHz and Detector = Peak, to measurement 6 dB Bandwidth.
4. SA set RBW = 1% ~ 5% OBW, VBW = three times the RBW and Detector = Peak, to measurement 99% Bandwidth
5. Measure and record the result of 6 dB Bandwidth and 99% Bandwidth. in the test report.

### 4.2.3 Test Setup

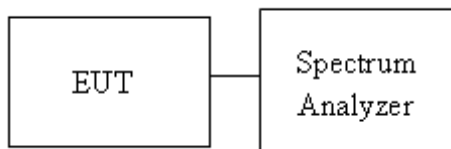



Report No.: T181220D08-RP

#### 4.2.4 Test Result

Test mode: IEEE 802.11b mode / 2412-2462 MHz						
Channel	Frequency (MHz)	Chain 0 OBW (99%) (MHz)	Chain 1 OBW (99%) (MHz)	Chain 0 6dB BW (MHz)	Chain 1 6dB BW (MHz)	6dB limit (kHz)
Low	2412	15.0651	-	9.5652	-	≥500
Mid	2437	14.8914	-	9.5652	-	
High	2462	14.8046	-	10.087	-	

Test mode: IEEE 802.11g mode / 2412-2462 MHz						
Channel	Frequency (MHz)	Chain 0 OBW (99%) (MHz)	Chain 1 OBW (99%) (MHz)	Chain 0 6dB BW (MHz)	Chain 1 6dB BW (MHz)	6dB limit (kHz)
Low	2412	16.7149	-	15.1304	-	≥500
Mid	2437	17.2358	-	15.1304	-	
High	2462	16.6280	-	15.1304	-	

Test mode: IEEE 802.11n HT 20 mode / 2412-2462 MHz						
Channel	Frequency (MHz)	Chain 0 OBW (99%) (MHz)	Chain 1 OBW (99%) (MHz)	Chain 0 6dB BW (MHz)	Chain 1 6dB BW (MHz)	6dB limit (kHz)
Low	2412	17.6266	-	15.1304	-	≥500
Mid	2437	18.0173	-	15.1304	-	
High	2462	17.6266	-	15.1304	-	

Test mode: IEEE 802.11n HT40 Mode / 2422-2452 MHz						
Channel	Frequency (MHz)	Chain 0 OBW (99%) (MHz)	Chain 1 OBW (99%) (MHz)	Chain 0 6dB BW (MHz)	Chain 1 6dB BW (MHz)	6dB limit (kHz)
Low	2422	36.1215	-	35.014	-	>500
Mid	2437	36.9319	-	33.855	-	
High	2452	36.0057	-	35.014	-	

## Test Data (6dB BANDWIDTH)

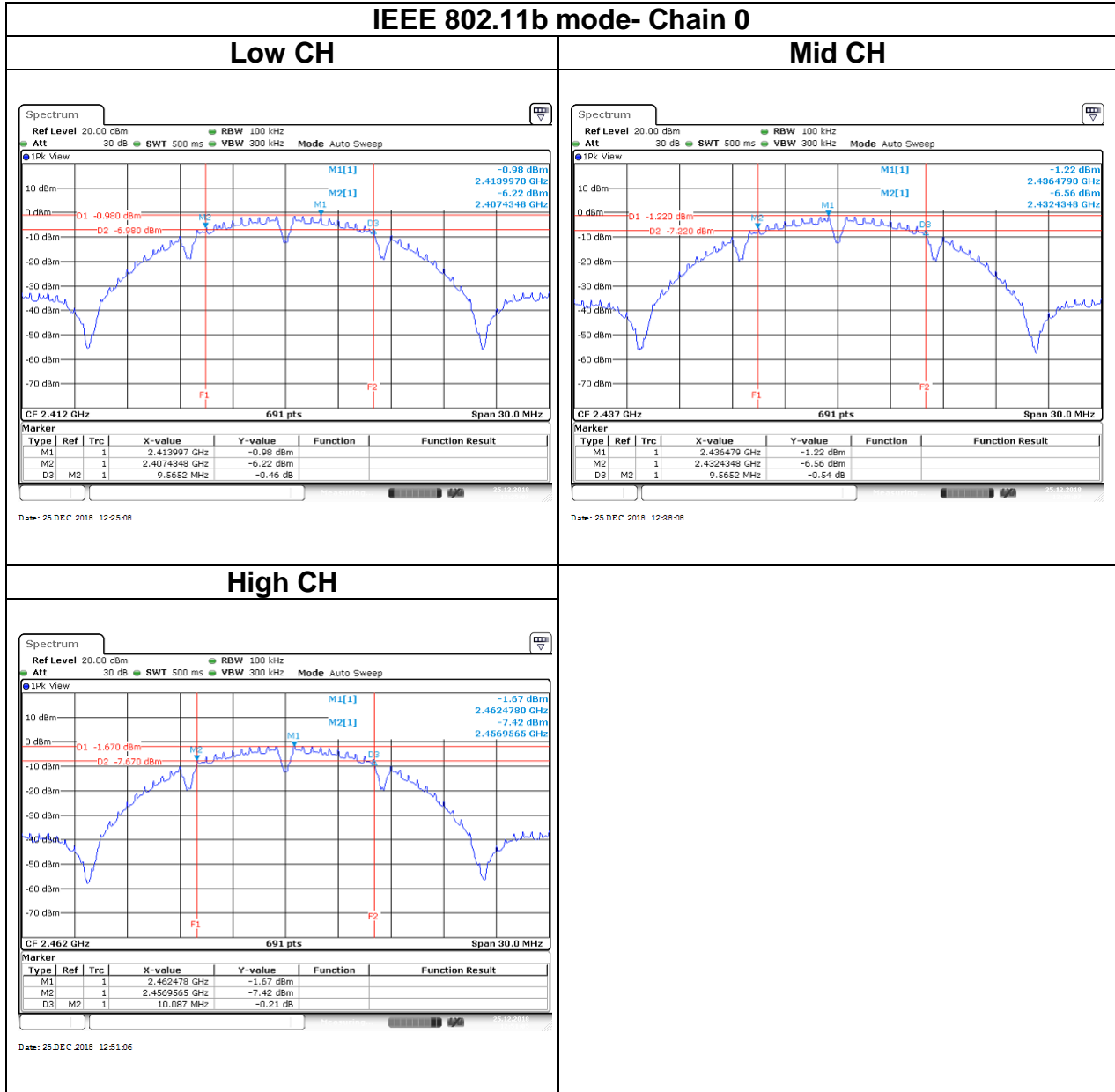

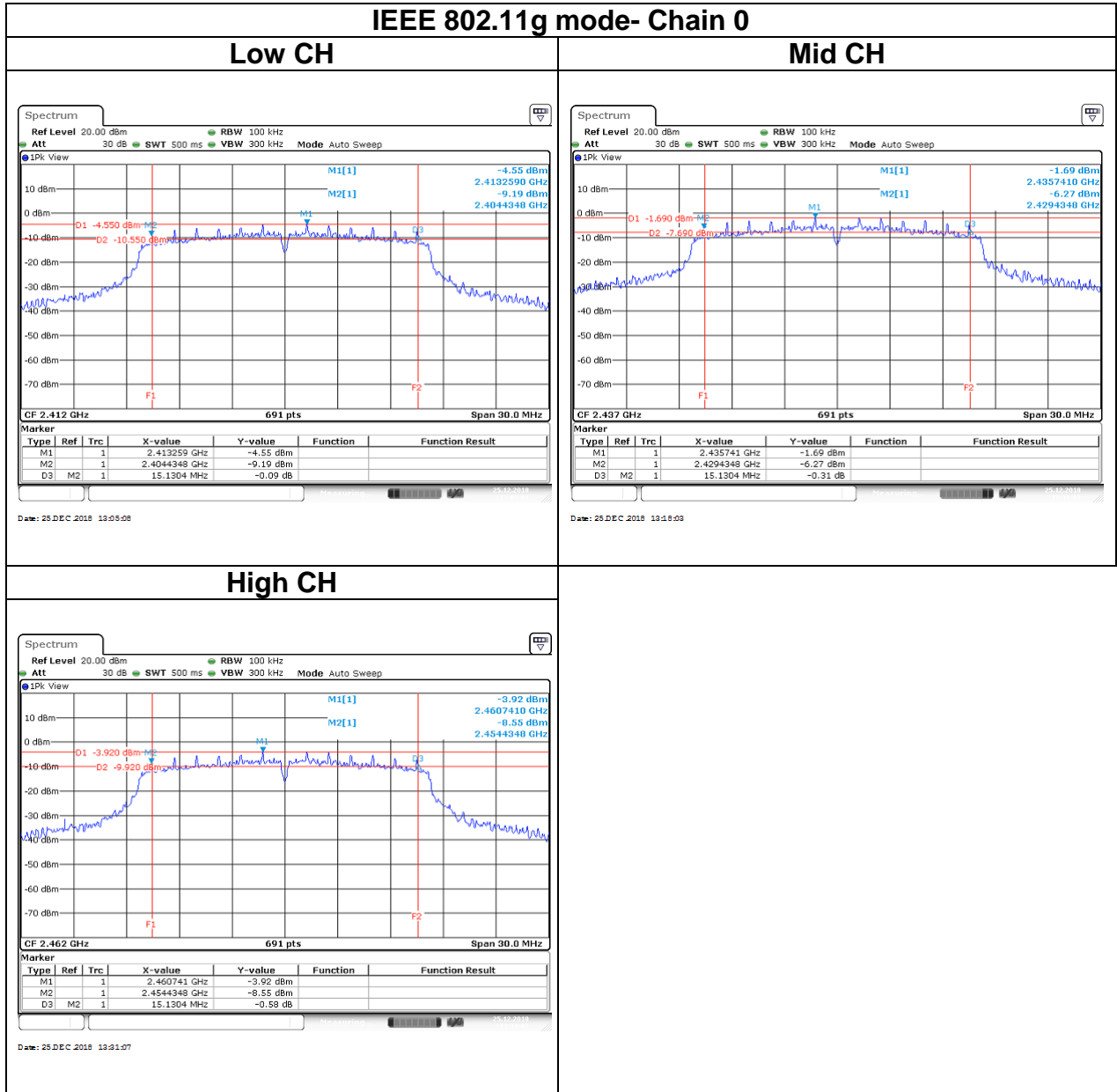

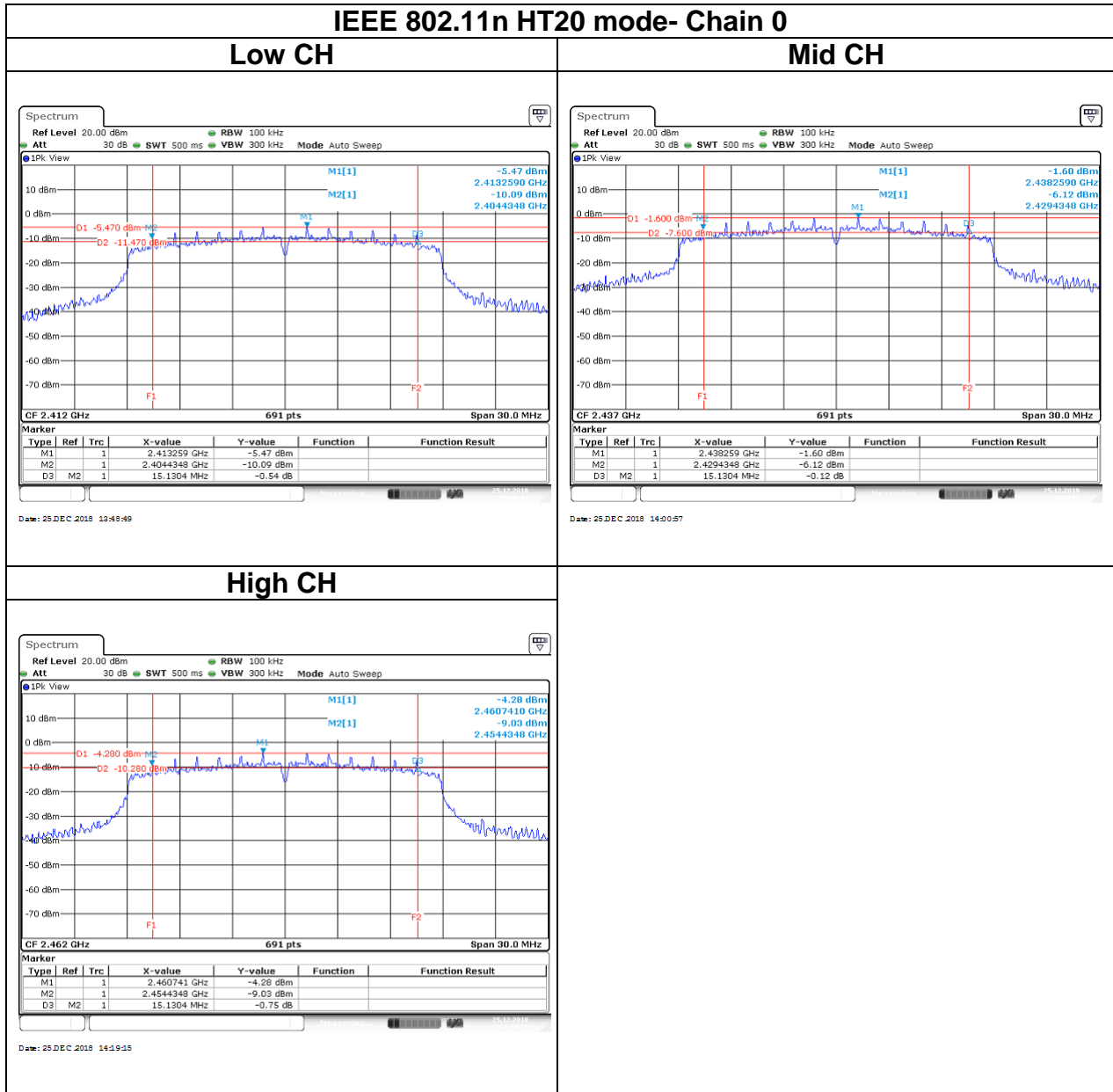

## IEEE 802.11n HT40 mode- Chain 0

### Low CH

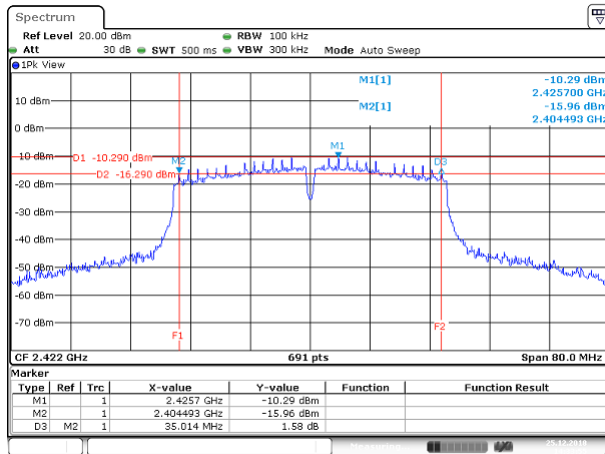

Date: 25 DEC 2018 14:33:55

### Mid CH

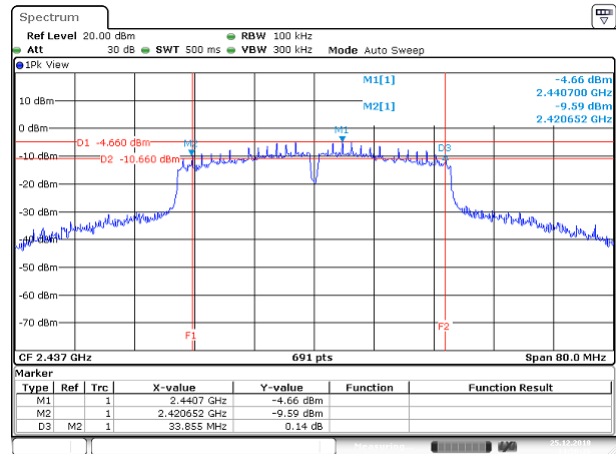

Date: 25 DEC 2018 14:50:06

### High CH

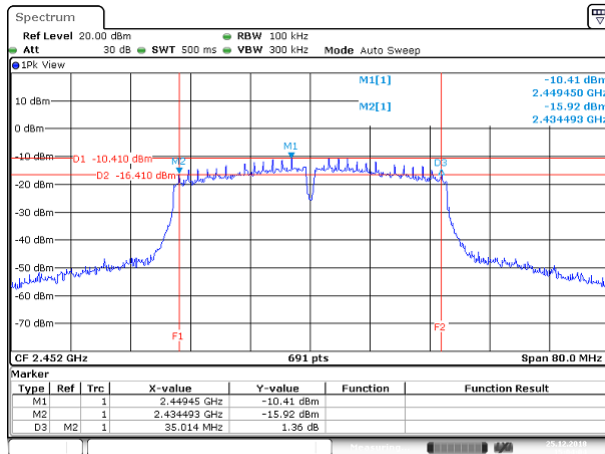

Date: 25 DEC 2018 15:04:04

## Test Data (BANDWIDTH 99%)

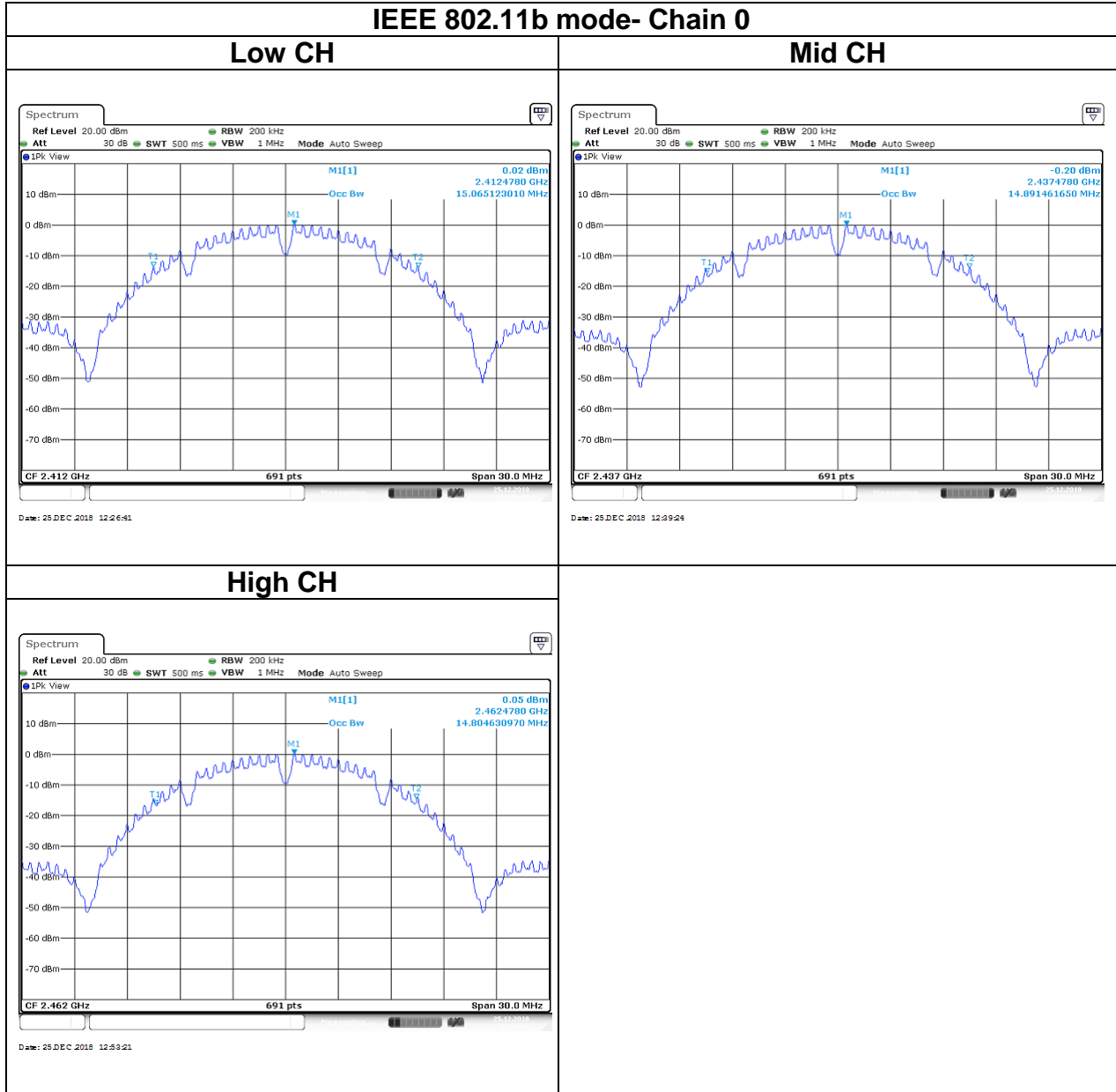

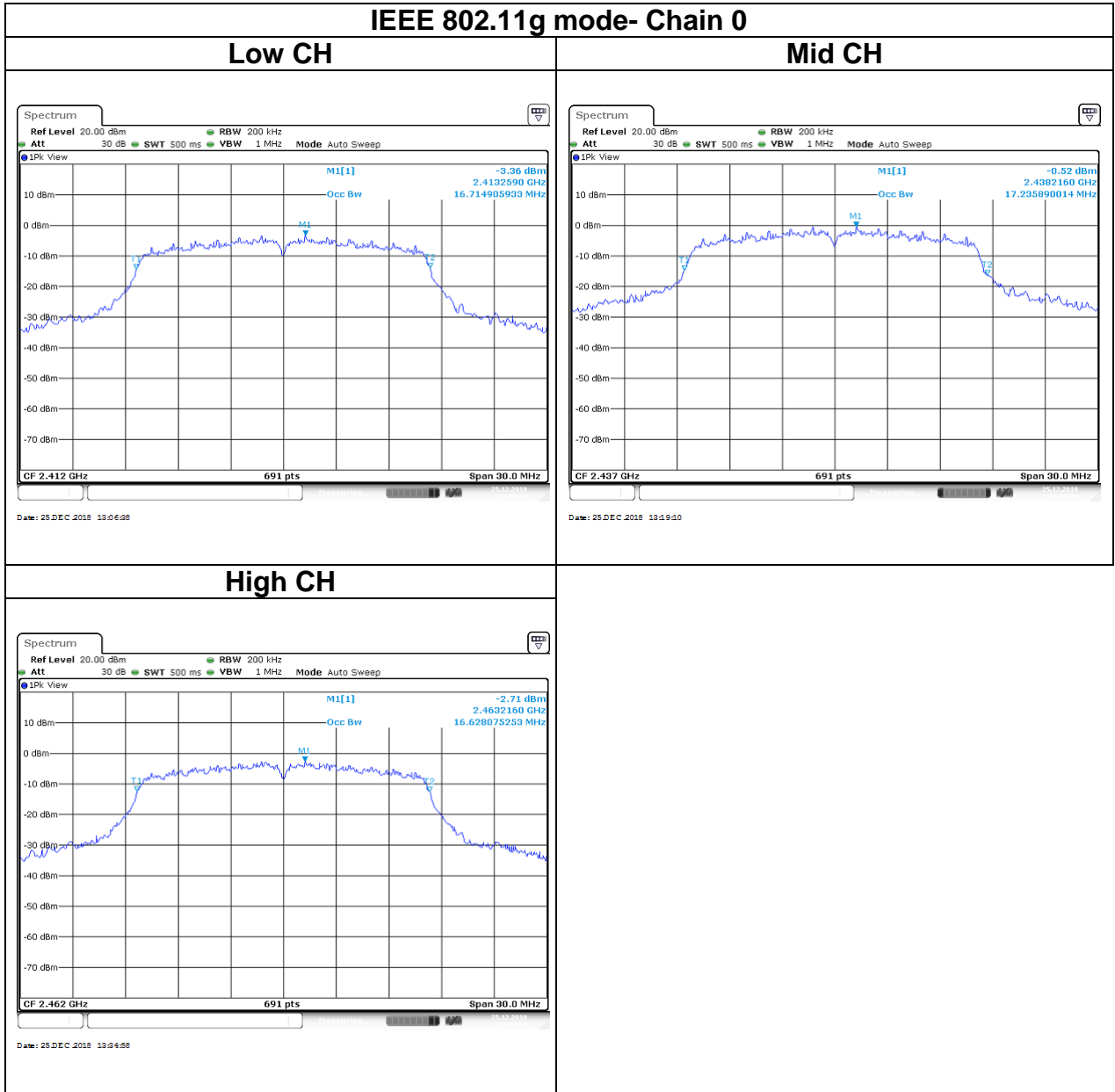

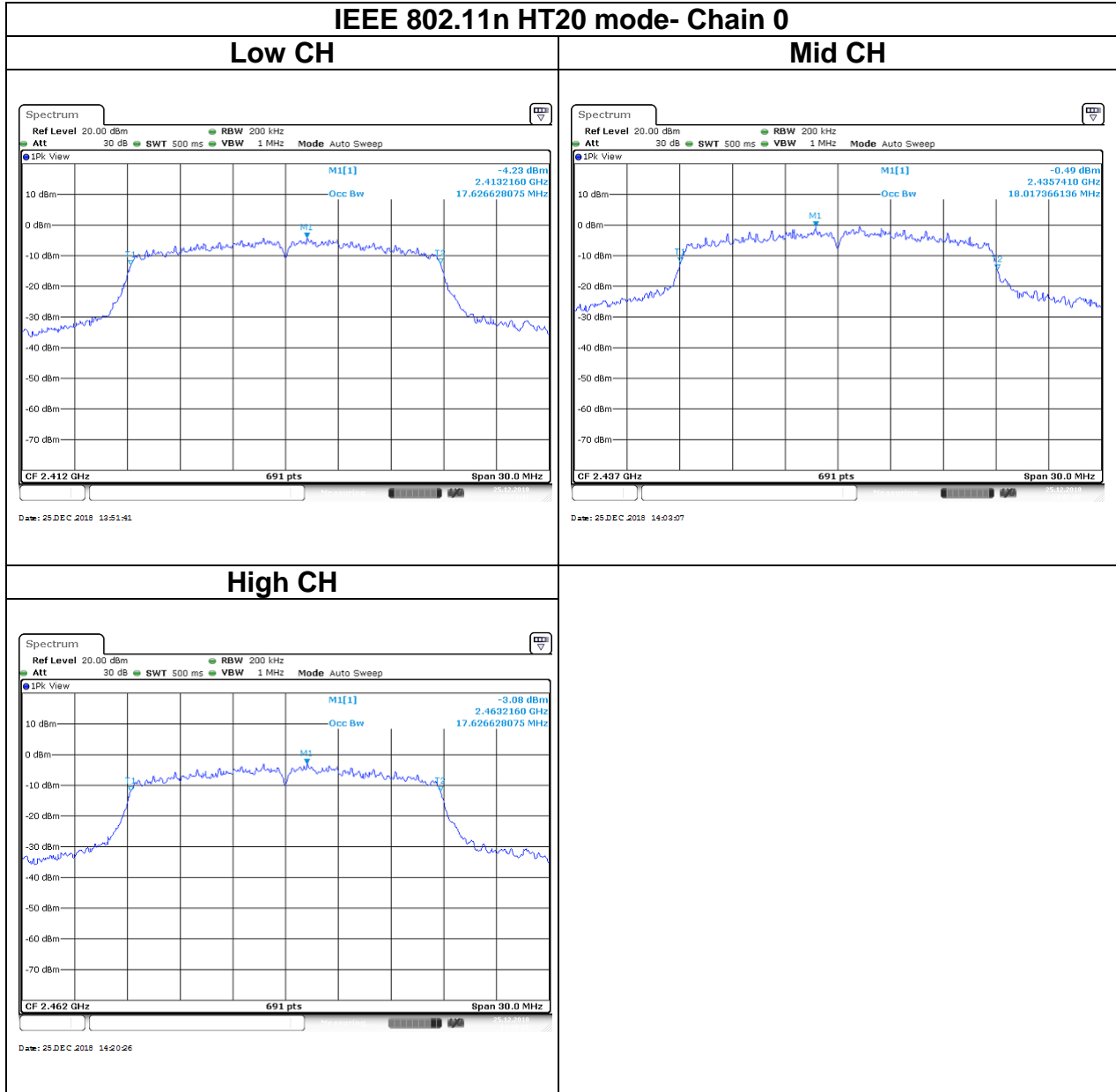



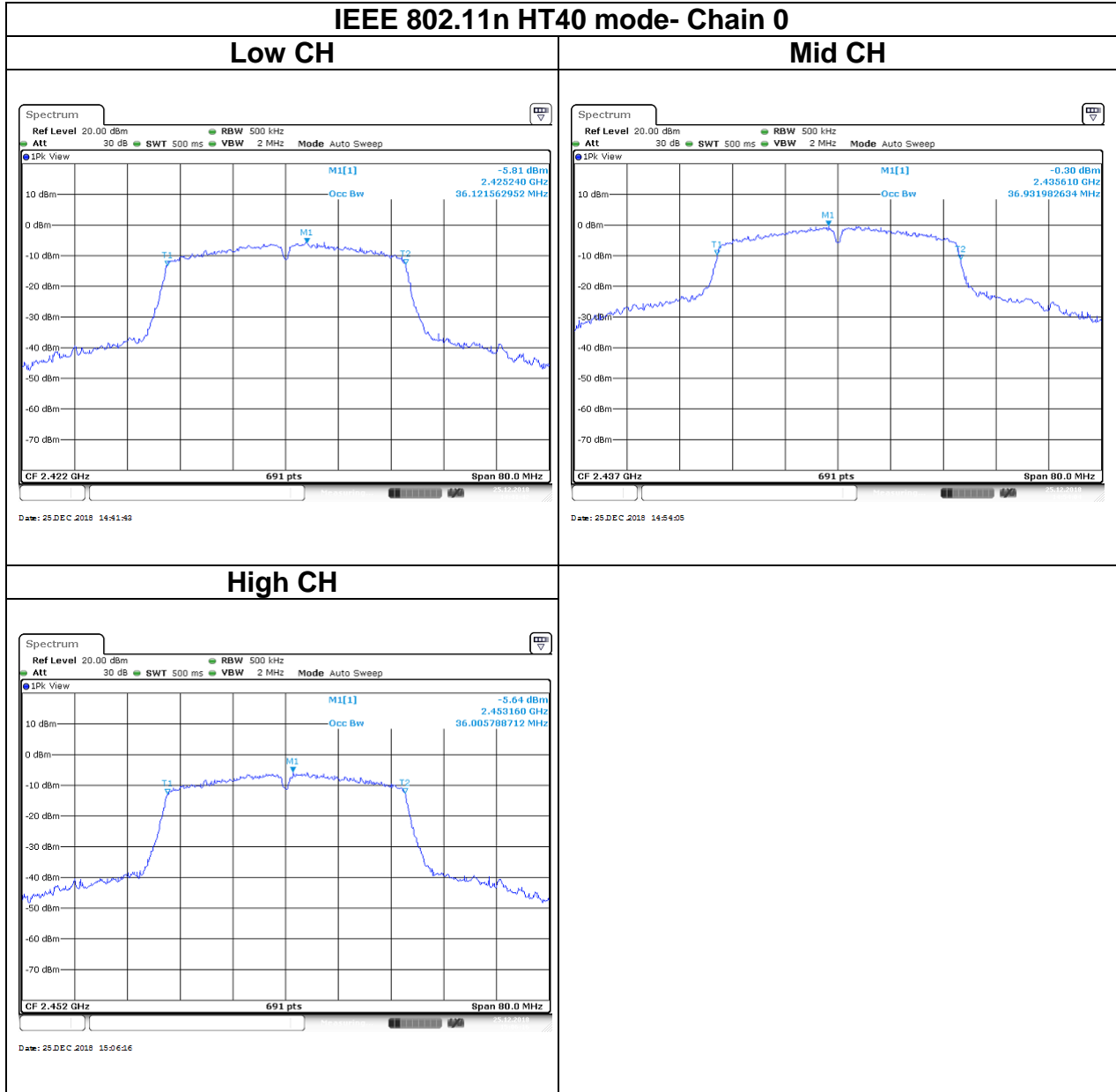

Report No.: T181220D08-RP

## 4.3 OUTPUT POWER MEASUREMENT

### 4.3.1 Test Limit

According to §15.247(b),

#### Peak output power :

For systems using digital modulation in the 2400-2483.5 MHz: 1 Watt (30 dBm), base on the use of antennas with directional gain not exceed 6 dBi If transmitting antennas of directional gain greater than 6dBi are used the peak output power the conducted output power from the intentional radiator shall be reduced by the amount in dB that the directional gain of the antenna exceeds 6 dBi. In case of point-to-point operation, the limit has to be reduced by 1dB for every 3 dB that the directional gain of the antenna exceeds 6 dBi.

Limit	<input checked="" type="checkbox"/> Antenna not exceed 6 dBi : 30dBm <input type="checkbox"/> Antenna with DG greater than 6 dBi : [Limit = 30 – (DG – 6)] <input type="checkbox"/> Point-to-point operation :
-------	---

Average output power : For reporting purposes only.

### 4.3.2 Test Procedure

Test method Refer as KDB 558074 D01.

1. The EUT RF output connected to the power meter by RF cable.
2. Setting maximum power transmit of EUT.
3. The path loss was compensated to the results for each measurement.
4. Measure and record the result of Peak output power and Average output power. in the test report.

### 4.3.3 Test Setup

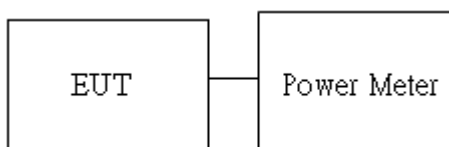

Report No.: T181220D08-RP

### 4.3.4 Test Result

**Peak output power :**

Wifi 2.4G									
Config	CH	Freq. (MHz)	power set		PK Power(dBm)		PK Total Power (dBm)	PK Total Power (W)	Limit (dBm)
			chain0	chain1	chain0	chain1			
IEEE 802.11b Data rate: 1Mbps	Low	2412	23	-	21.34	-	21.34	0.1361	30
	Mid	2437	23	-	21.13	-	21.13	0.1297	
	High	2462	22	-	21.37	-	21.37	0.1371	
IEEE 802.11g Data rate: 6Mbps	Low	2412	1C	-	23.09	-	23.09	0.2037	
	Mid	2437	23	-	24.19	-	24.19	0.2624	
	High	2462	1D	-	23.88	-	23.88	0.2443	
IEEE 802.11n HT20 Data rate: MCS0	Low	2412	1A	-	22.84	-	22.84	0.1923	
	Mid	2437	23	-	24.23	-	24.23	0.2649	
	High	2462	1C	-	23.85	-	23.85	0.2427	
IEEE 802.11n HT40 Data rate: MCS0	Low	2422	17	-	21.34	-	21.34	0.1361	
	Mid	2437	23	-	23.80	-	23.80	0.2399	
	High	2452	18	-	21.53	-	21.53	0.1422	

Report No.: T181220D08-RP

**Average output power :**

Wifi 2.4G					
Config	CH	Freq. (MHz)	AV Power(dBm)		AV Total Power (dBm)
			chain0	chain1	
IEEE 802.11b Data rate: 1Mbps	Low	2412	19.75	-	19.75
	Mid	2437	19.45	-	19.45
	High	2462	19.56	-	19.56
IEEE 802.11g Data rate: 6Mbps	Low	2412	16.30	-	16.30
	Mid	2437	19.07	-	19.07
	High	2462	17.09	-	17.09
IEEE 802.11n HT20 Data rate: MCS 0	Low	2412	15.36	-	15.36
	Mid	2437	18.82	-	18.82
	High	2462	16.45	-	16.45
IEEE 802.11n HT40 Data rate: MCS 0	Low	2422	12.86	-	12.86
	Mid	2437	18.05	-	18.05
	High	2452	12.09	-	12.09

## 4.4 POWER SPECTRAL DENSITY

### 4.4.1 Test Limit

According to §15.247(e),

For digitally modulated systems, the power spectral density conducted from the intentional radiator to the antenna shall not be greater than 8 dBm in any 3 kHz band during any time interval of continuous transmission.

Limit	<input checked="" type="checkbox"/> Antenna not exceed 6 dBi : 8dBm <input type="checkbox"/> Antenna with DG greater than 6 dBi : [ Limit = 8 – (DG – 6) ] <input type="checkbox"/> Point-to-point operation :
-------	---

### 4.4.2 Test Procedure

Test method Refer as KDB 558074 D01.

1. The EUT RF output connected to the spectrum analyzer by RF cable.
2. Setting maximum power transmit of EUT
3. SA set RBW = 3kHz, VBW = 30kHz, Span = 1.5 times DTS Bandwidth (6 dB BW), Detector = Peak, Sweep Time = Auto and Trace = Max hold.
4. The path loss and Duty Factor were compensated to the results for each measurement by SA.
5. Mark the maximum level.
6. Measure and record the result of power spectral density. in the test report.

### 4.4.3 Test Setup

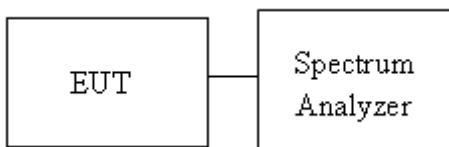

Report No.: T181220D08-RP

#### 4.4.4 Test Result

Test mode: IEEE 802.11b mode / 2412-2462 MHz					
Channel	Frequency (MHz)	Chain 0 PPSD (dBm)	Chain 1 PPSD (dBm)	Total PSSD (dBm)	Limit (dBm)
Low	2412	-5.74	-	-5.74	8
Mid	2437	-6.02	-	-6.02	
High	2462	-6.50	-	-6.50	

Test mode: IEEE 802.11g mode / 2412-2462 MHz					
Channel	Frequency (MHz)	Chain 0 PPSD (dBm)	Chain 1 PPSD (dBm)	Total PSSD (dBm)	Limit (dBm)
Low	2412	-10.26	-	-10.26	8
Mid	2437	-6.82	-	-6.82	
High	2462	-9.85	-	-9.85	

Test mode: IEEE 802.11n HT 20 mode / 2412-2462 MHz					
Channel	Frequency (MHz)	Chain 0 PPSD (dBm)	Chain 1 PPSD (dBm)	Total PSSD (dBm)	Limit (dBm)
Low	2412	-10.52	-	-10.52	8
Mid	2437	-6.80	-	-6.80	
High	2462	-9.40	-	-9.40	

Test mode: IEEE 802.11n HT 40 mode / 2422-2452 MHz					
Channel	Frequency (MHz)	Chain 0 PPSD (dBm)	Chain 1 PPSD (dBm)	Total PSSD (dBm)	Limit (dBm)
Low	2422	-13.78	-	-13.78	8
Mid	2437	-8.85	-	-8.85	
High	2452	-13.92	-	-13.92	

## Test Data

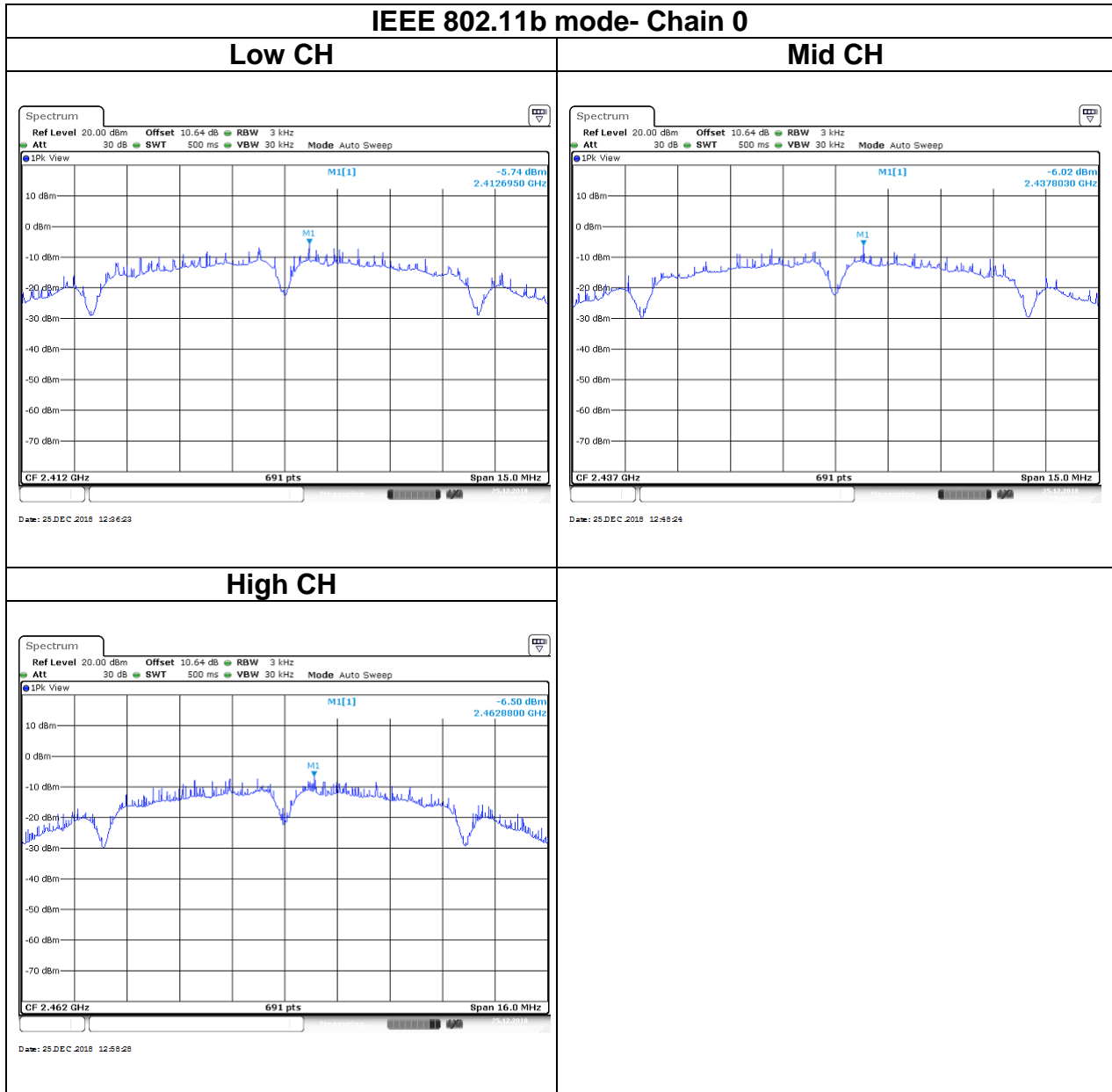

## IEEE 802.11g mode- Chain 0

### Low CH

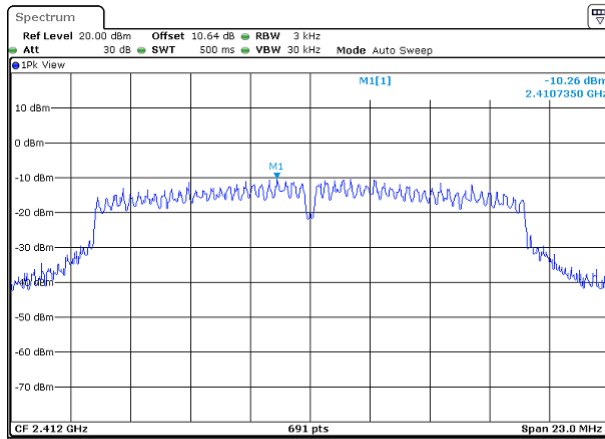

Date: 25 DEC 2018 13:15:20

### Mid CH

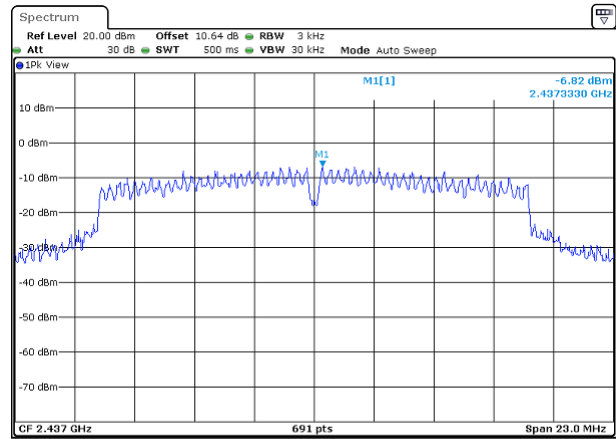

Date: 25 DEC 2018 13:29:33

### High CH

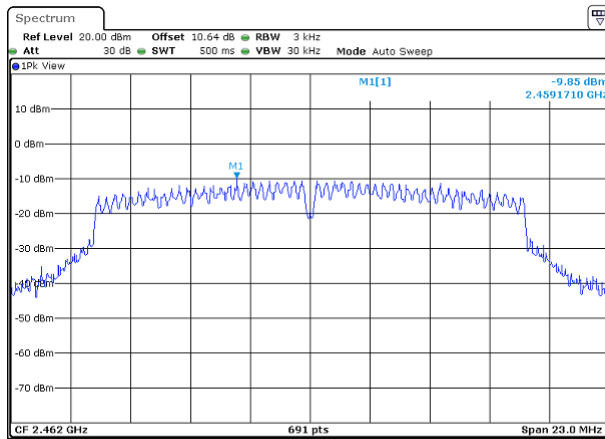

Date: 25 DEC 2018 13:40:49



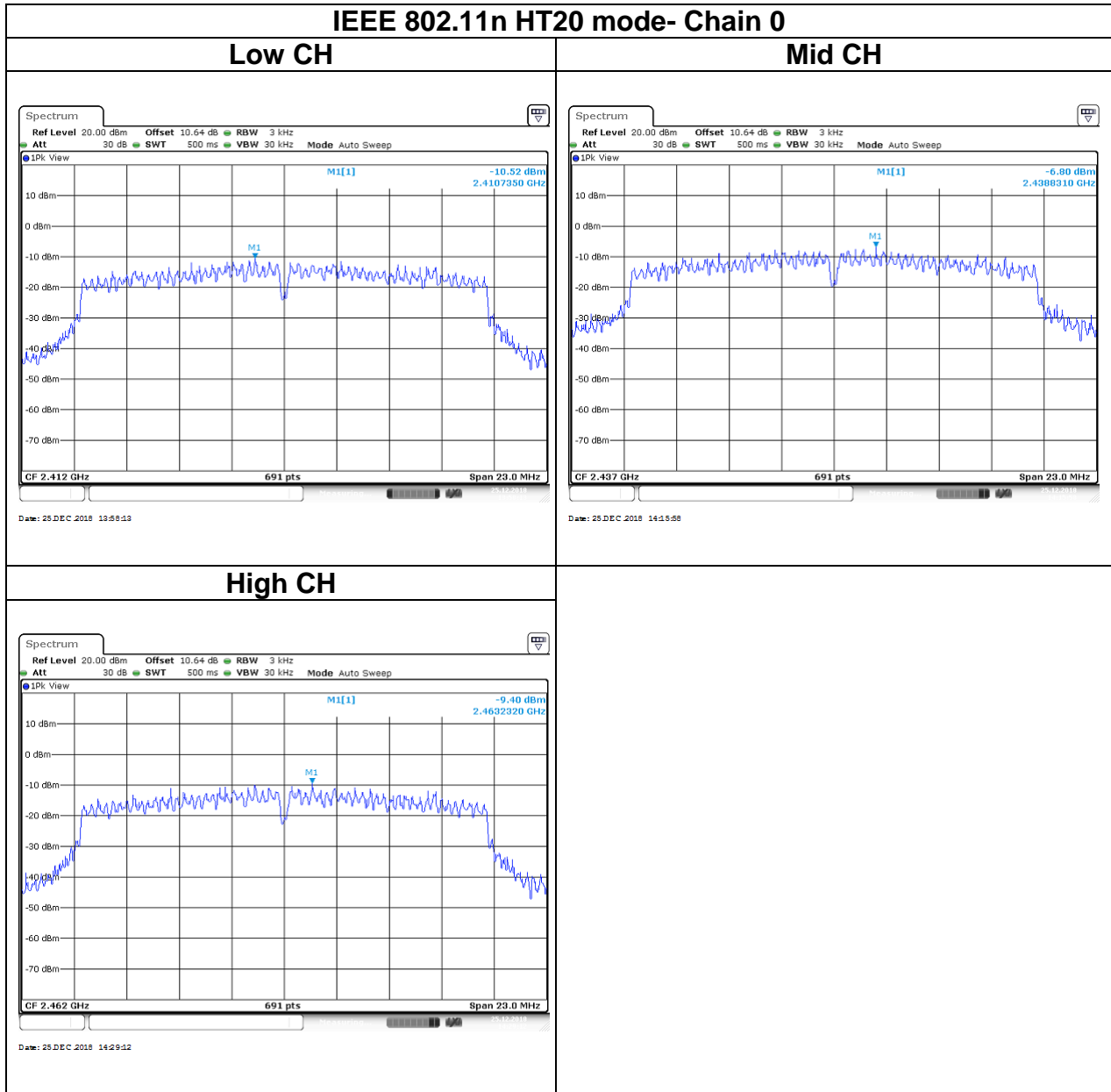

## IEEE 802.11n HT40 mode- Chain 0

### Low CH

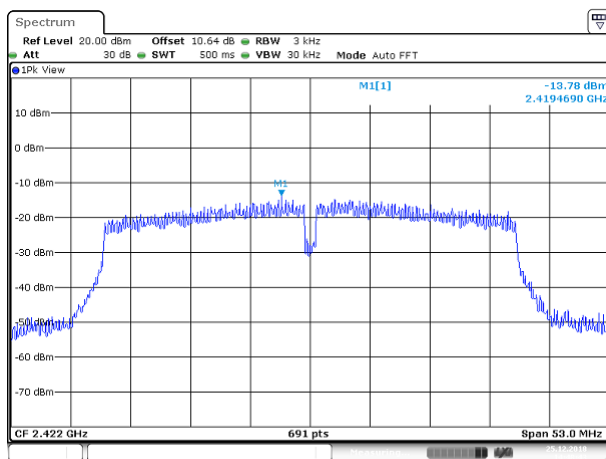

### Mid CH

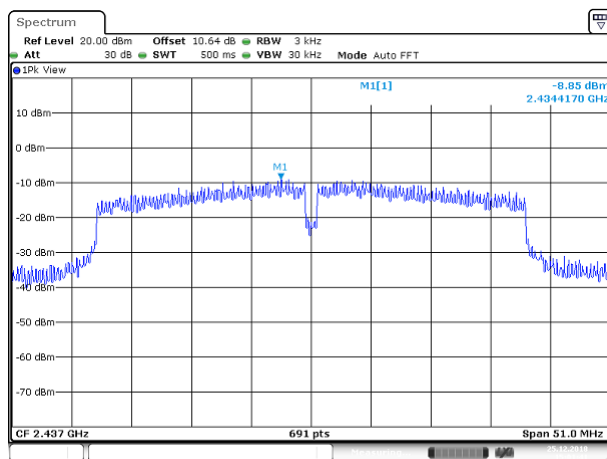

### High CH

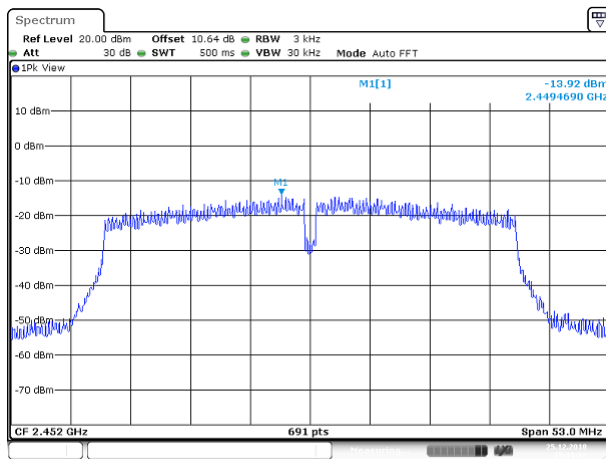

## 4.5 CONDUCTED BANDEDGE AND SPURIOUS EMISSION

### 4.5.1 Test Limit

According to §15.247(d),

**FCC:** In any 100 kHz bandwidth outside the authorized frequency band,

Non-restricted bands shall be attenuated at least 20 dB/30 dB relative to the maximum PSD level in 100 kHz by RF conducted or a radiated measurement which fall in the restricted bands, as defined in §15.205(a), must also comply with the radiated emission limits specified in §15.209(a).

### 4.5.2 Test Procedure

Test method Refer as KDB 558074 D01.

1. EUT RF output port connected to the SA by RF cable, and the path loss was compensated to result.
2. SA setting, RBW=100kHz, VBW=300kHz, Detector=Peak, Trace mode = max hold, SWT = Auto.
3. In any 100 kHz bandwidth outside the authorized frequency band, shall be attenuated at least 20 dB relative to the maximum in-band peak PSD level in 100 kHz when conducted power procedure is used. If the transmitter complies with the conducted power limits based on the use of RMS averaging over a time interval, the attenuation required under this paragraph shall be 30 dB instead of 20 dB.

### 4.5.3 Test Setup

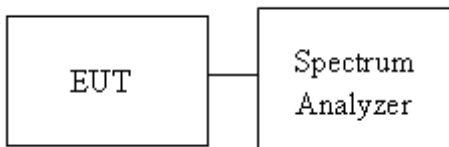

## 4.5.4 Test Result

### Test Data

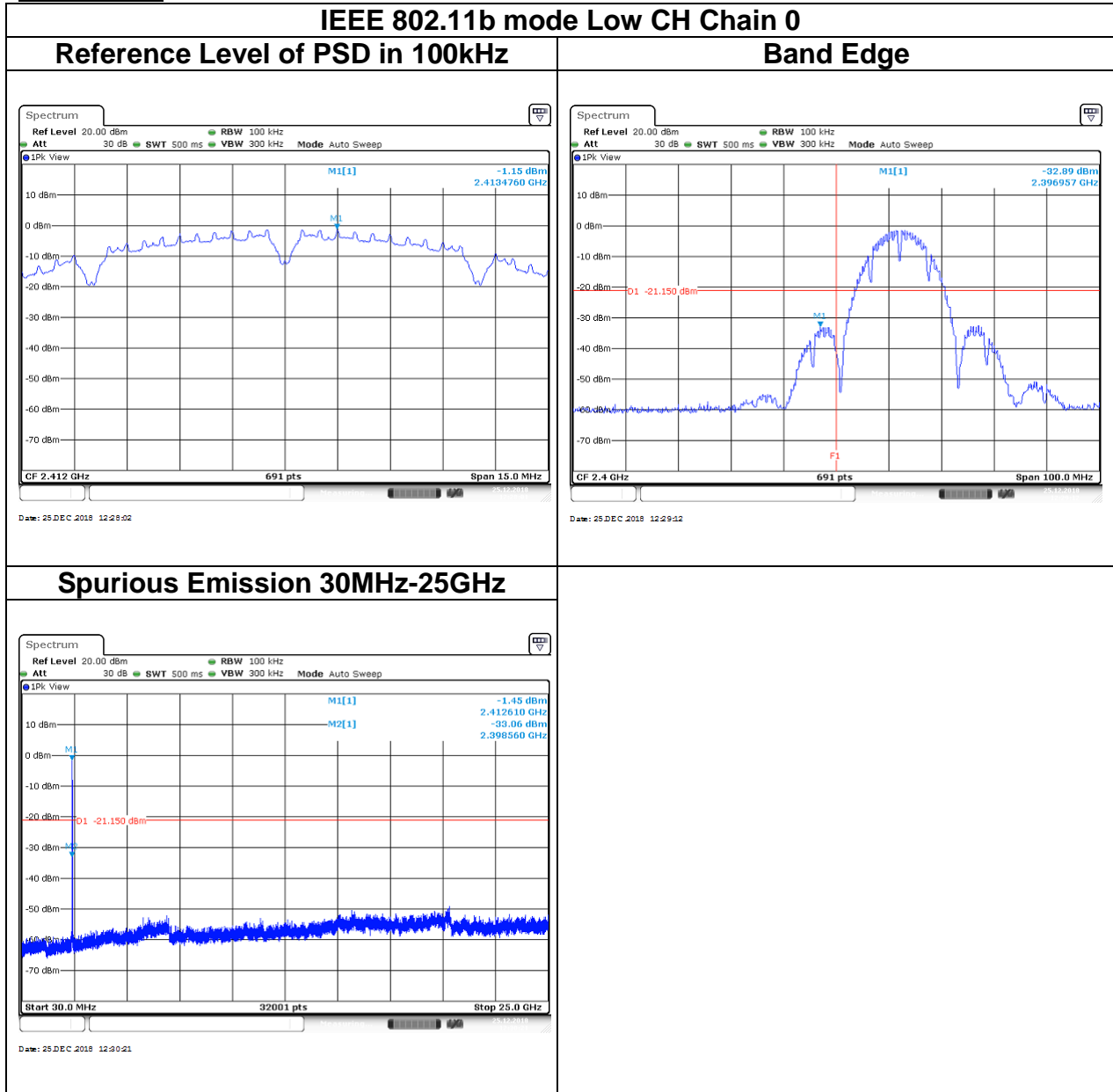

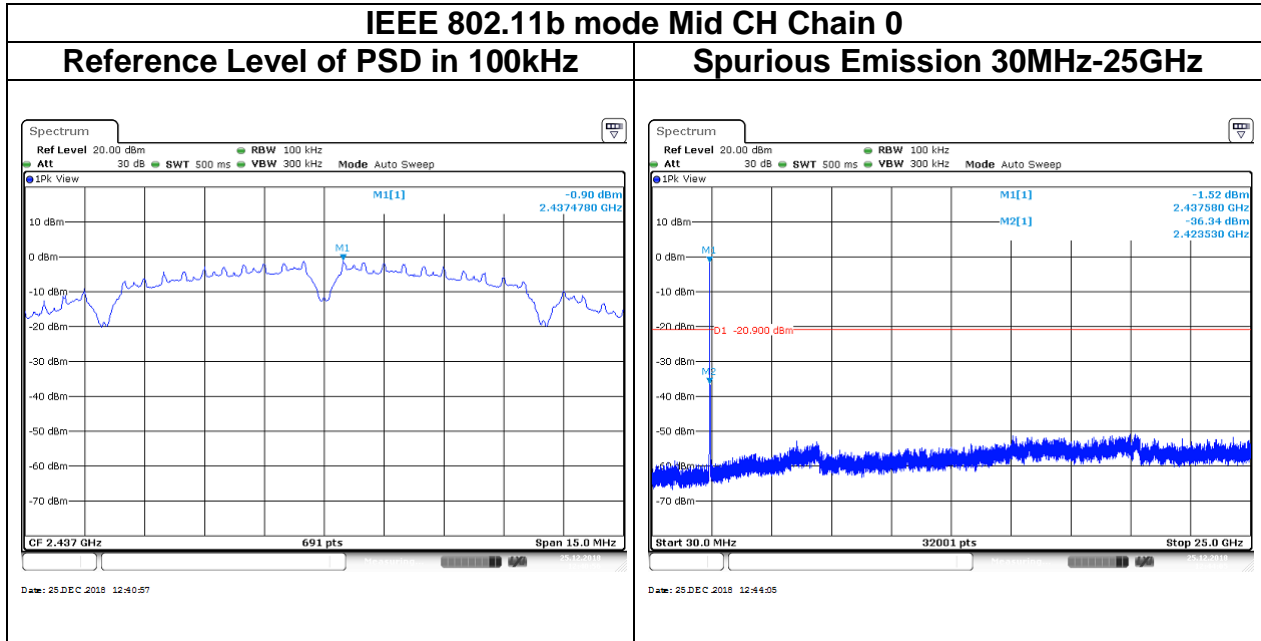

## IEEE 802.11b mode High CH Chain 0

### Reference Level of PSD in 100kHz

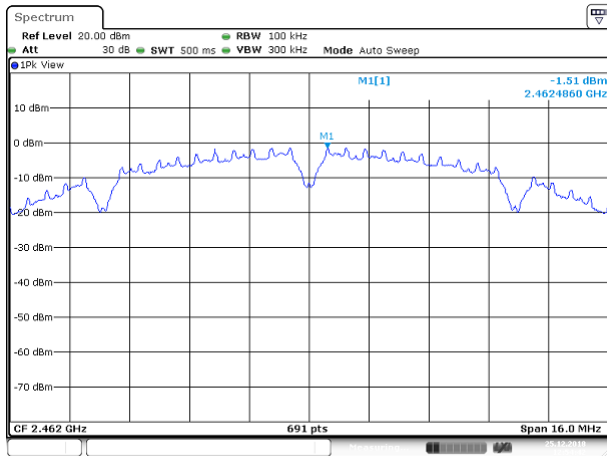

### Band Edge

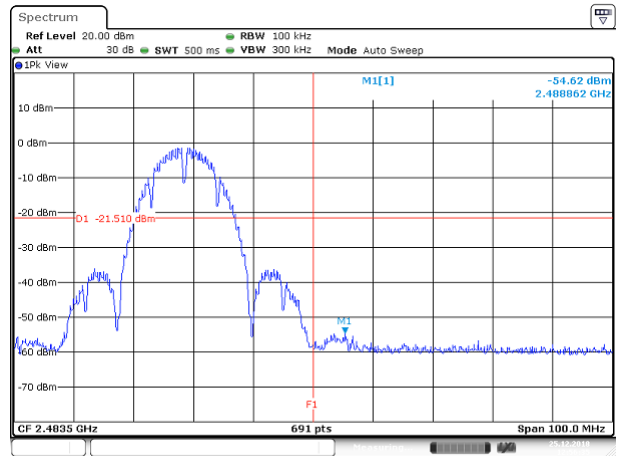

### Spurious Emission 30MHz-25GHz

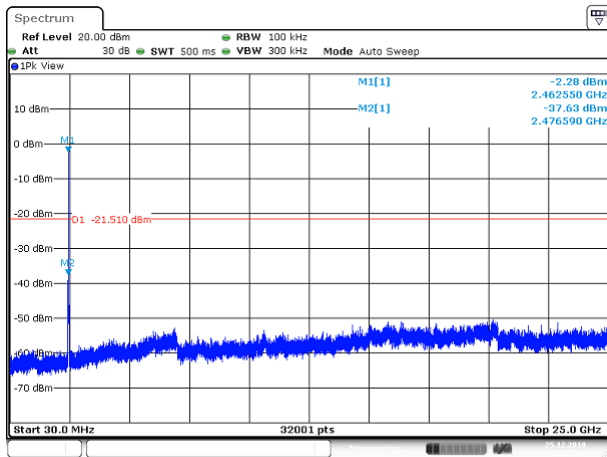

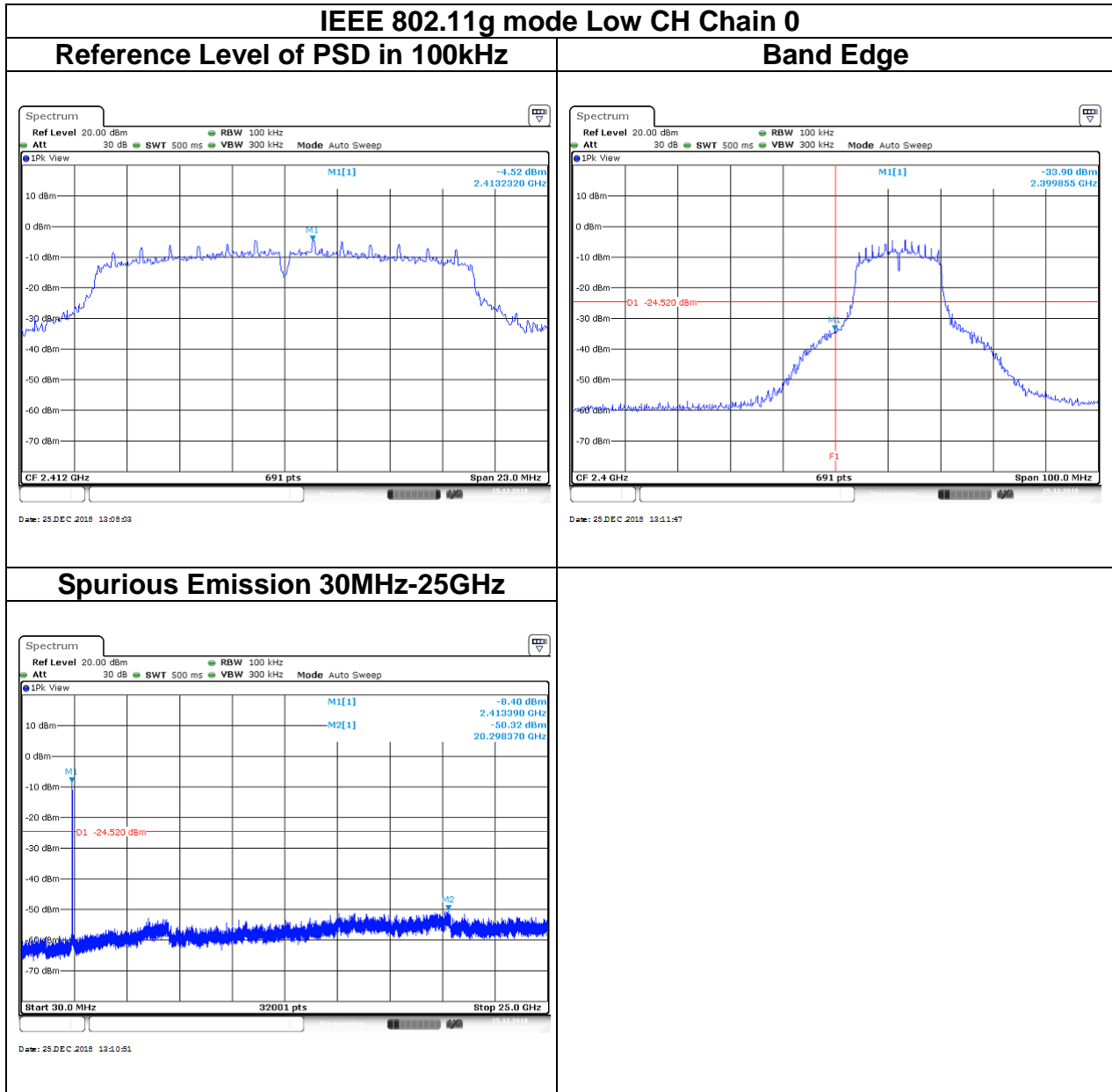

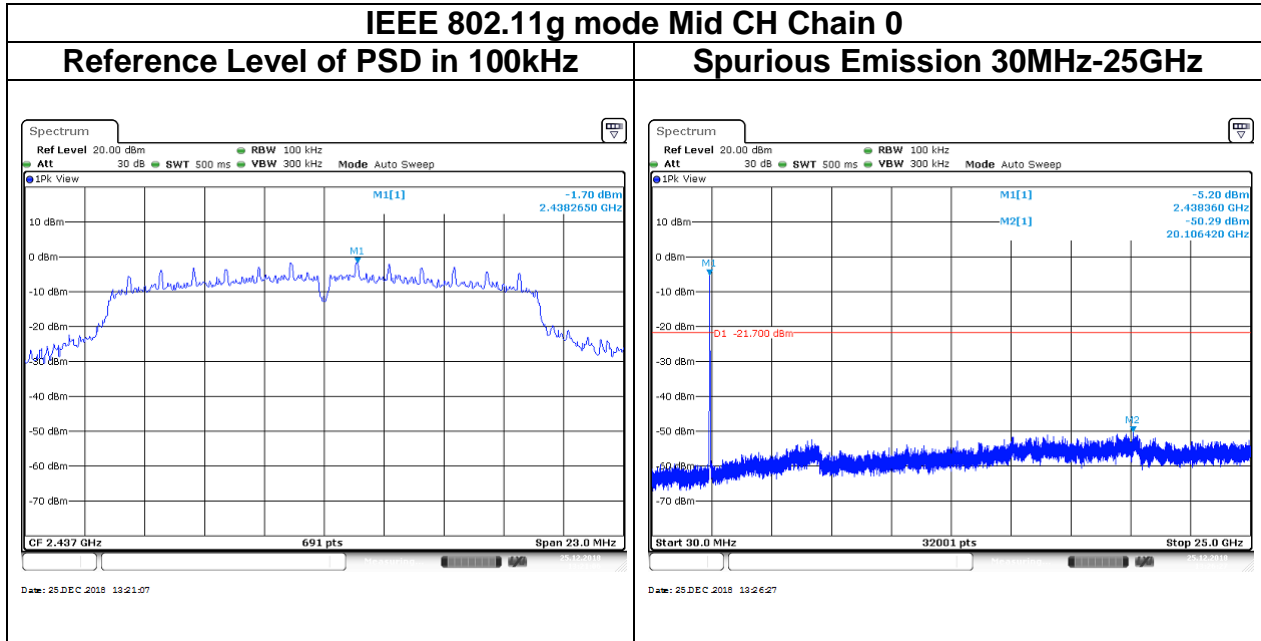



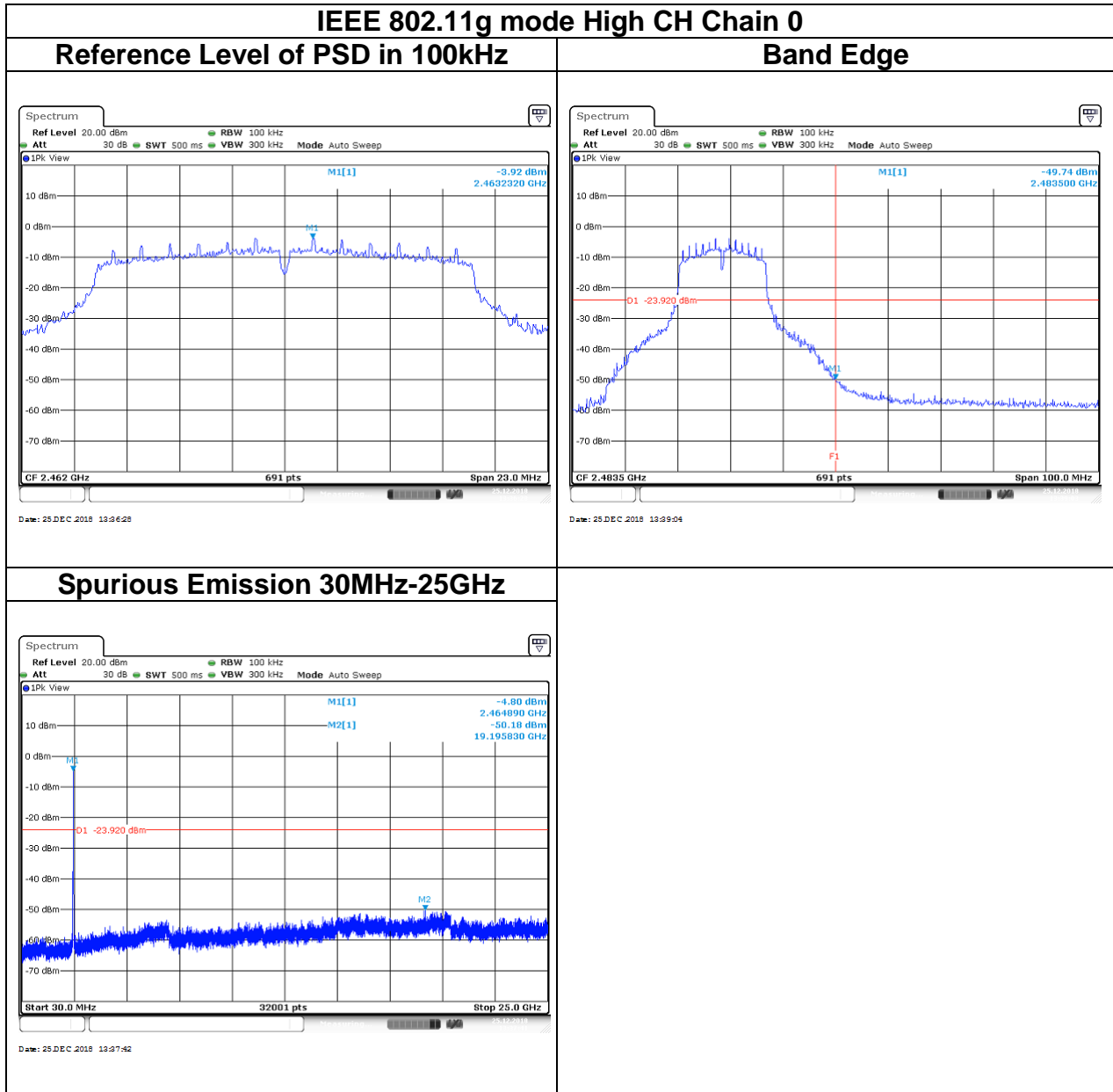

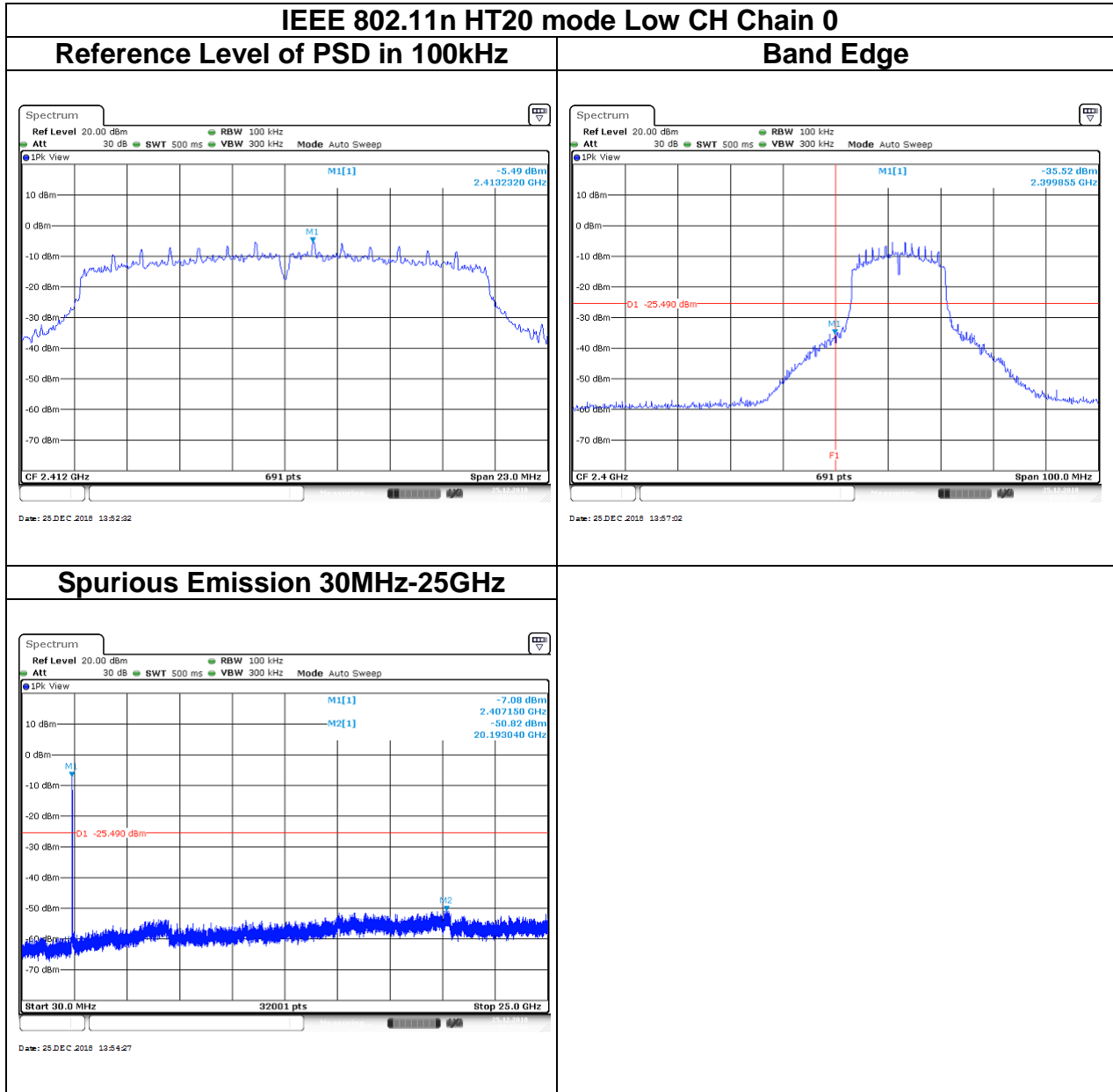

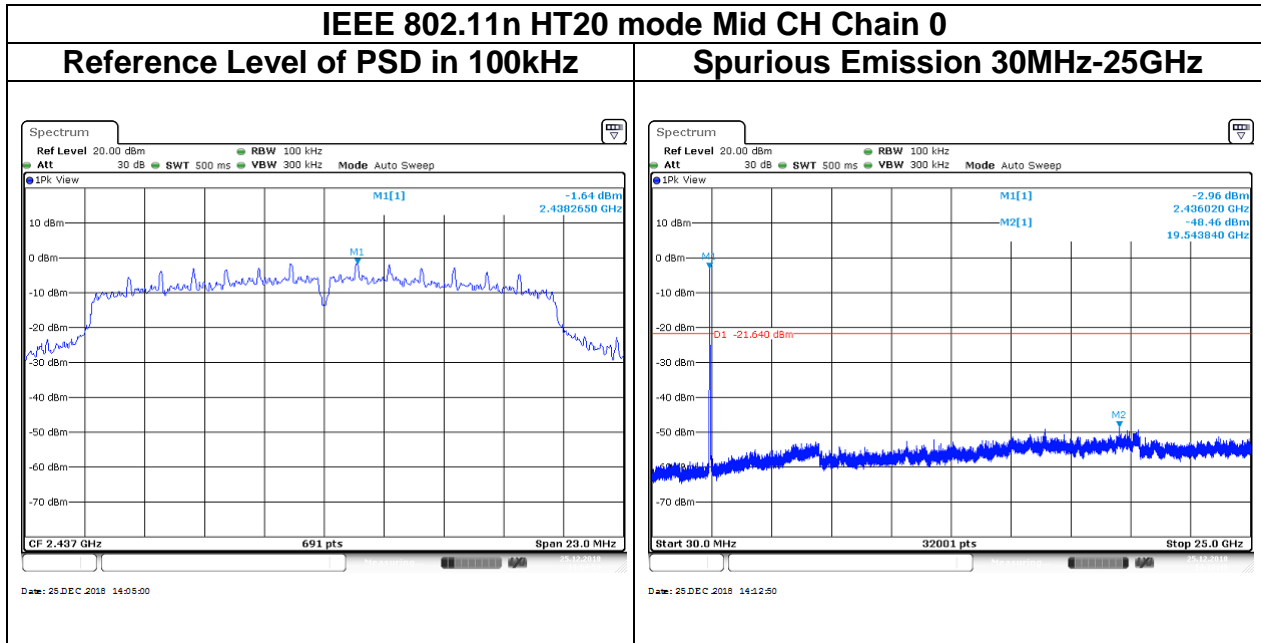

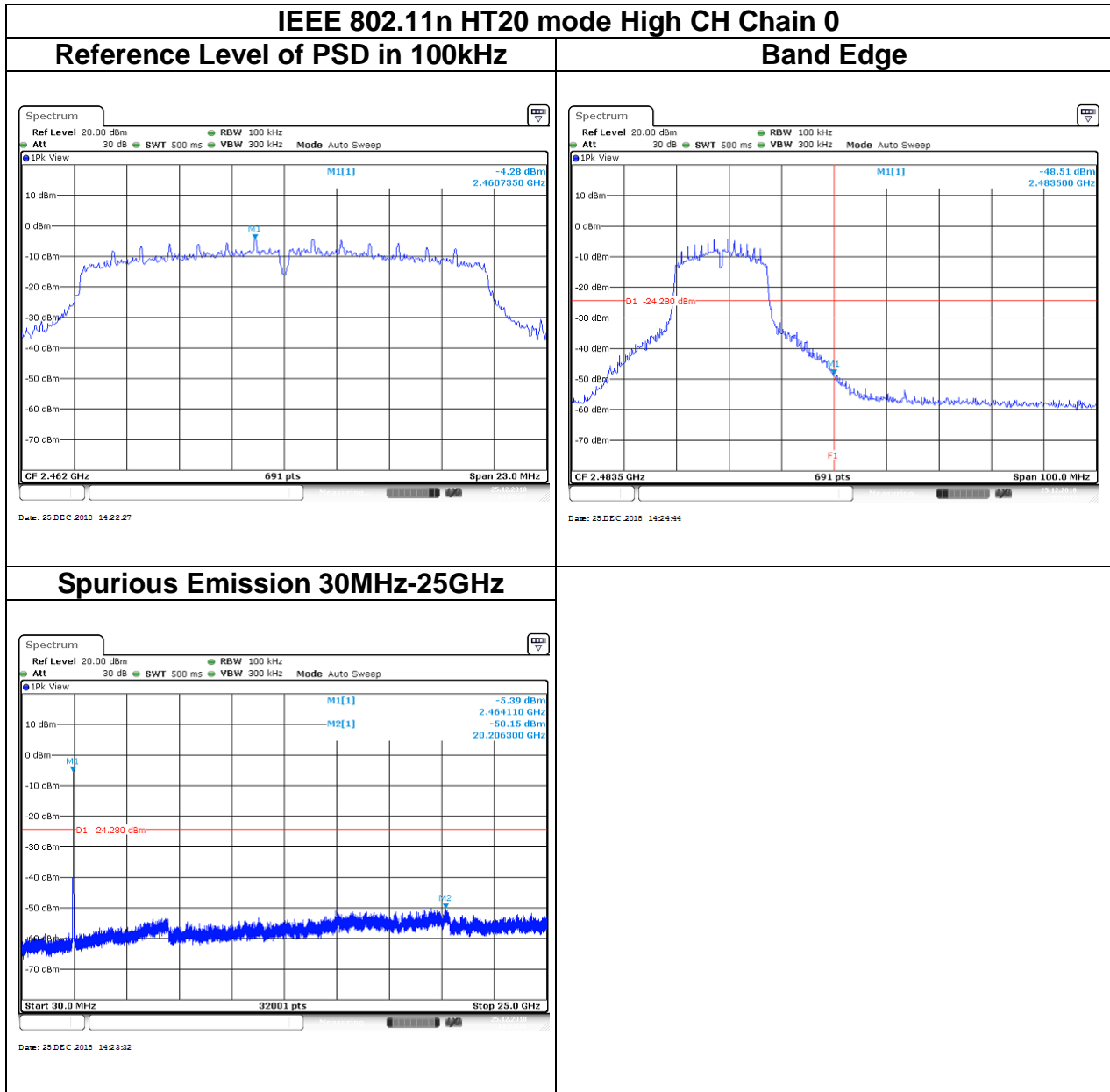

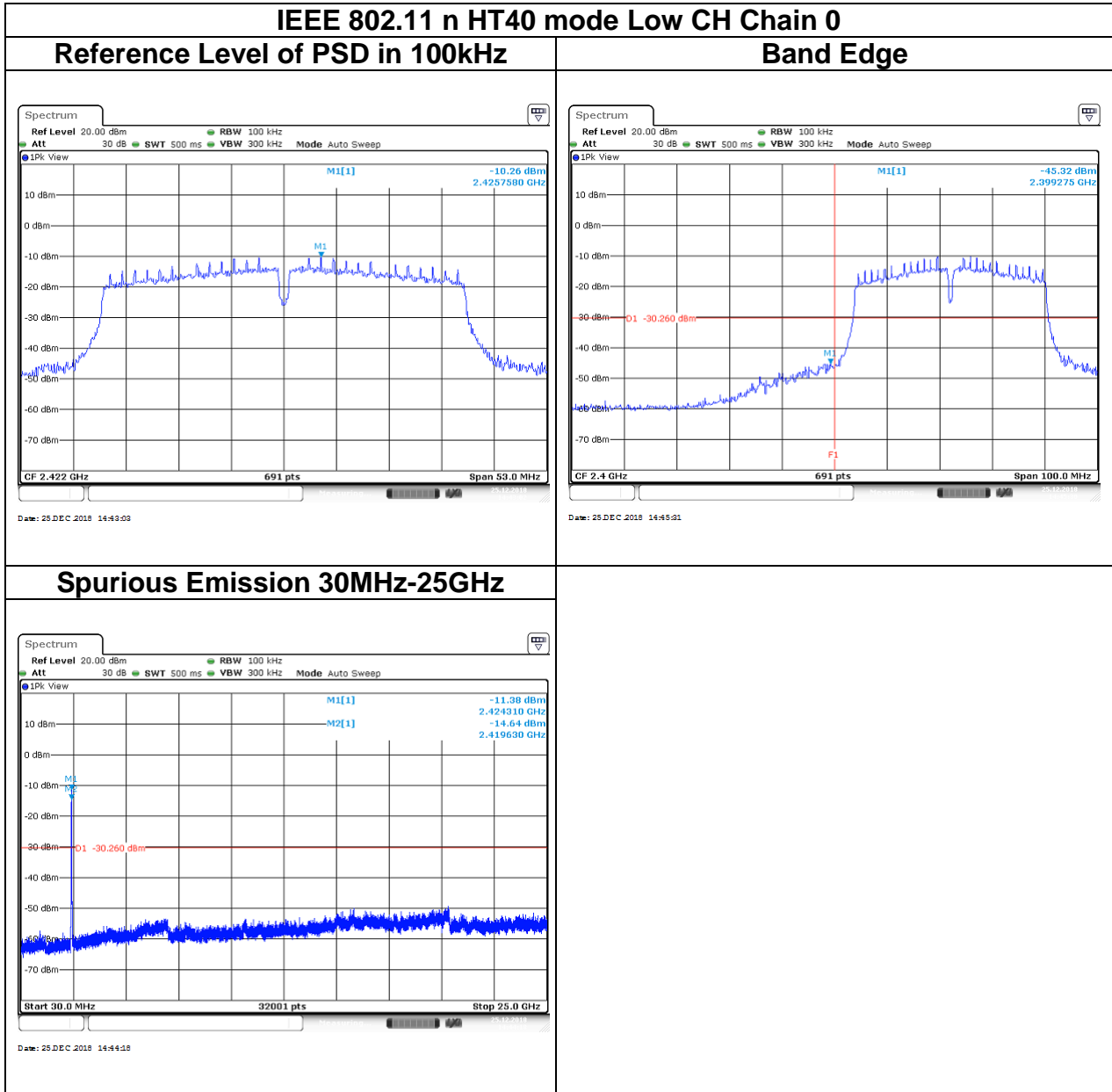

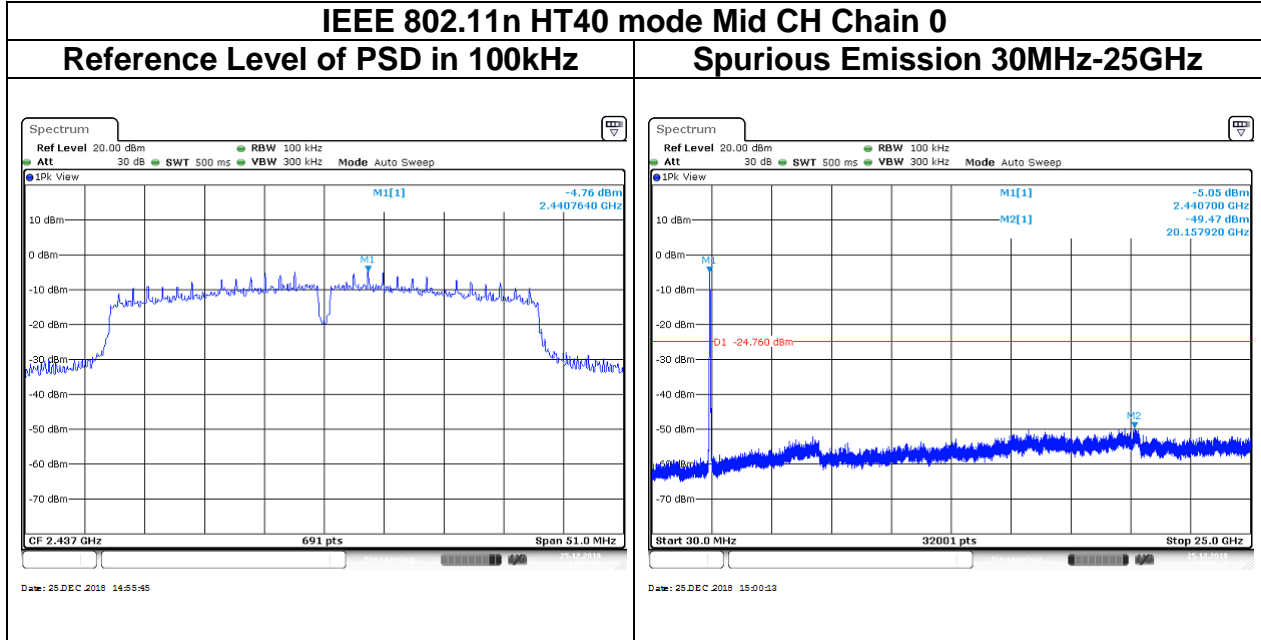

## IEEE 802.11n HT40 mode High CH Chain 0

### Reference Level of PSD in 100kHz

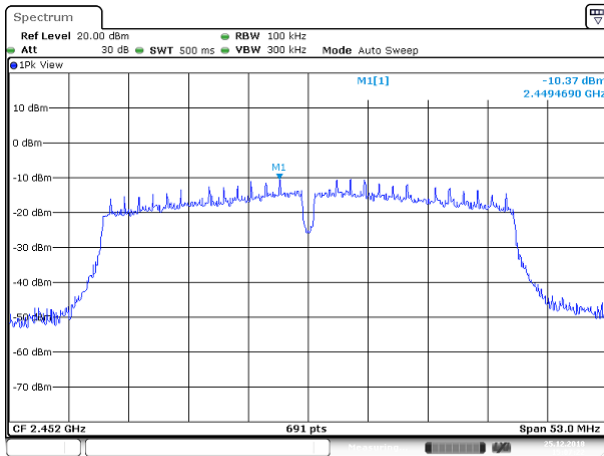

Date: 25 DEC 2018 15:07:22

### Band Edge

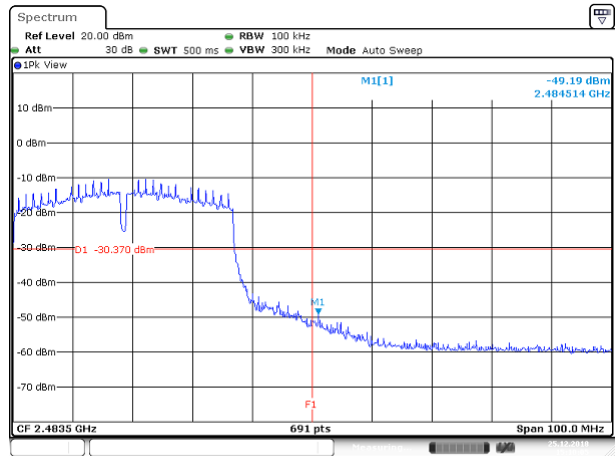

Date: 25 DEC 2018 15:10:05

### Spurious Emission 30MHz-25GHz

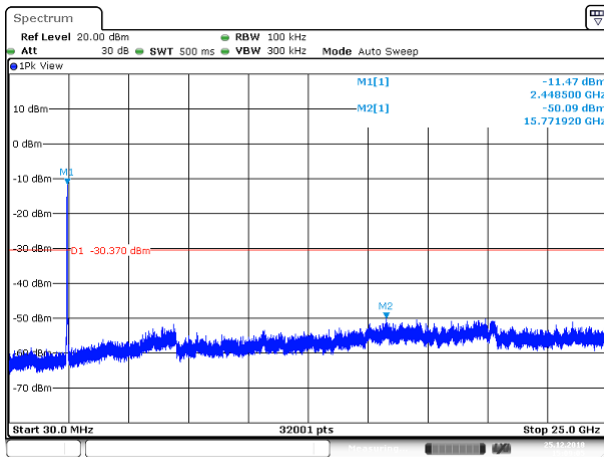

Date: 25 DEC 2018 15:09:06

## 4.6 RADIATION BANDEDGE AND SPURIOUS EMISSION

### 4.6.1 Test Limit

FCC according to §15.247(d), §15.209 and §15.205,

In any 100 kHz bandwidth outside the authorized frequency band, all harmonic and spurious must be least 20 dB below the highest emission level with the authorized frequency band. Radiation emission which fall in the restricted bands must also follow the FCC section 15.209 as below limit in table.

#### Below 30 MHz

Frequency	Field Strength (microvolts/m)	Magnetic H-Field (microamperes/m)	Measurement Distance (metres)
9-490 kHz	2,400/F (F in kHz)	2,400/F (F in kHz)	300
490-1,705 kHz	24,000/F (F in kHz)	24,000/F (F in kHz)	30
1.705-30 MHz	30	N/A	30

#### Above 30 MHz

Frequency	Field Strength (microvolts/m)	Measurement Distance (metres)
30-88	100	3
88-216	150	3
216-960	200	3
Above 960	500	3



Report No.: T181220D08-RP

### 4.6.2 Test Procedure

Test method Refer as KDB 558074 D01.

1. The EUT is placed on a turntable, Above 1 GHz is 1.5m and below 1 GHz is 0.8m above ground plane. The EUT Configured un accordance with ANSI C63.10, and the EUT set in a continuous mode.
2. The turntable shall be rotated for 360 degrees to determine the position of maximum emission level. And EUT is set 3m away from the receiving antenna, which is scanned from 1m to 4m above the ground plane to find out the highest emissions. Measurement are made polarized in both the vertical and the horizontal positions with antenna.
3. Span shall wide enough to full capture the emission measured. The SA from 9kHz to 26.5GHz set to the low, Mid and High channels with the EUT transmit.

Remark:

1. Although these tests were performed other than open area test site, adequate comparison measurements were confirmed against 30 m open are test site. Therefore sufficient tests were made to demonstrate that the alternative site produces results that correlate with the ones of tests made in an open field based on KDB 414788.
2. No emission found between lowest internal used/generated frequency to 30MHz (9kHz~30MHz).
4. The SA setting following :
  - (1) Below 1G : RBW = 100kHz, VBW  $\geq$  3 RBW, Sweep = Auto, Detector = Peak, Trace = Max hold.
  - (2) Above 1G :
    - (2.1) For Peak measurement : RBW = 1MHz, VBW  $\geq$  3 RBW, Sweep = Auto, Detector = Peak, Trace = Max hold.
    - (2.2) For Average measurement : RBW = 1MHz, VBW
      - If Duty Cycle  $\geq$  98%, VBW=10Hz.
      - If Duty Cycle < 98%, VBW=1/T.

Configuration	Duty Cycle (%)	T(ms)	1/T (kHz)	VBW Setting
802.11b	98.94%	8.4400	-	10Hz
802.11g	98.61%	1.4200	-	10Hz
802.11n HT20	93.01%	1.3300	0.752	820Hz
802.11n HT40	87.18%	0.6800	1.471	1.5kHz

## 4.6.3 Test Setup

### 9kHz ~ 30MHz

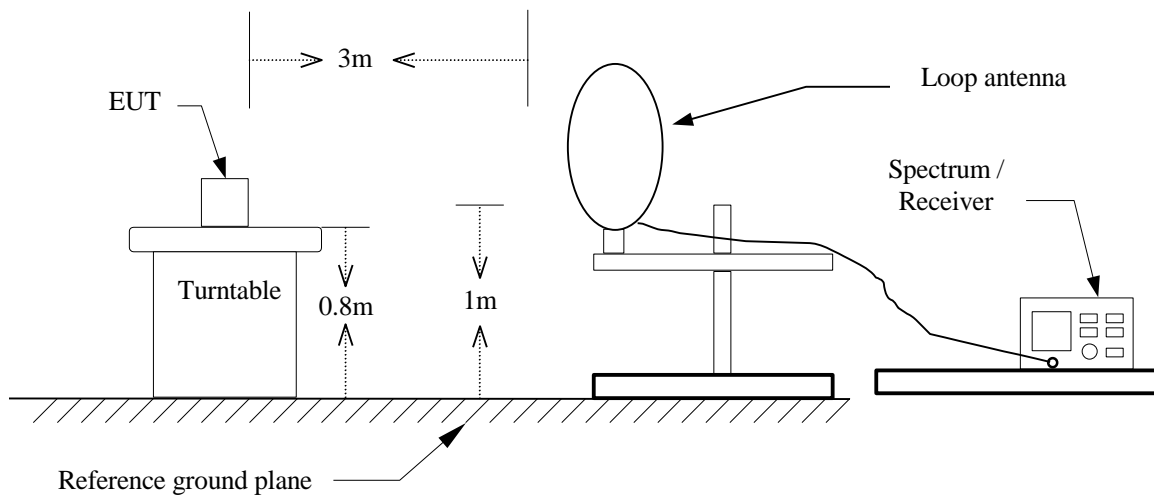

### 30MHz ~ 1GHz

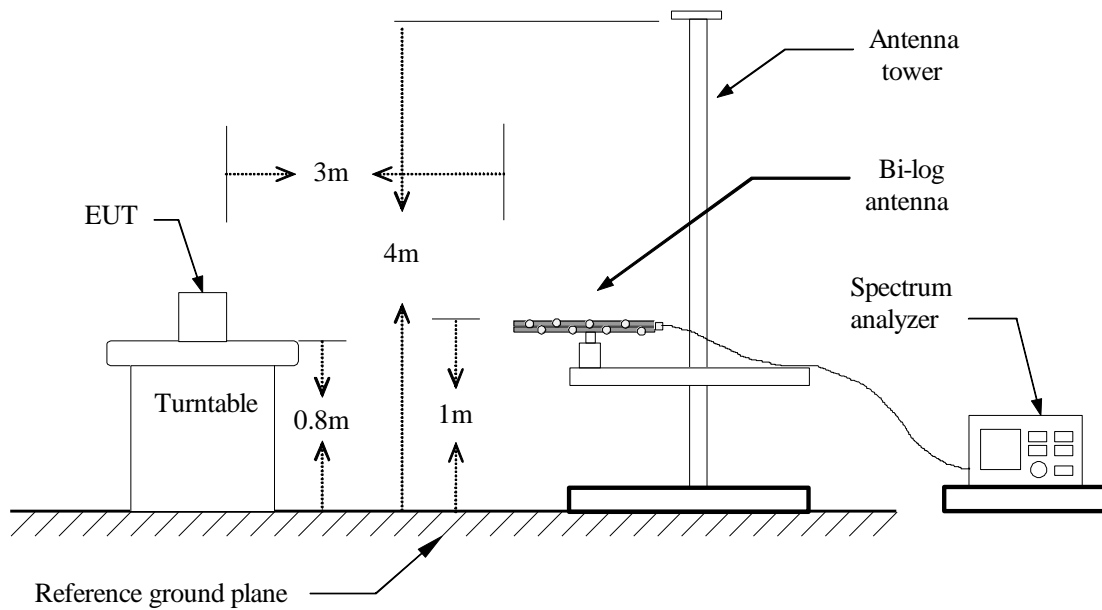

## Above 1 GHz

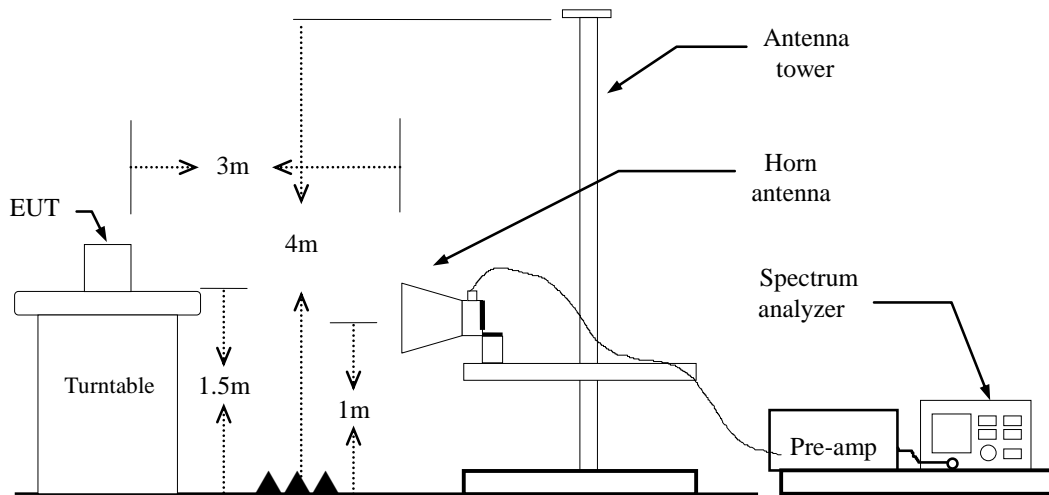

Report No.: T181220D08-RP

### 4.6.4 Test Result

#### Band Edge Test Data

Test Mode	IEEE 802.11b Low CH	Temp/Hum	22.1(°C)/ 50%RH
Test Item	Band Edge	Test Date	December 24, 2018
Polarize	Horizontal	Test Engineer	Jerry Chuang
Detector	Peak		

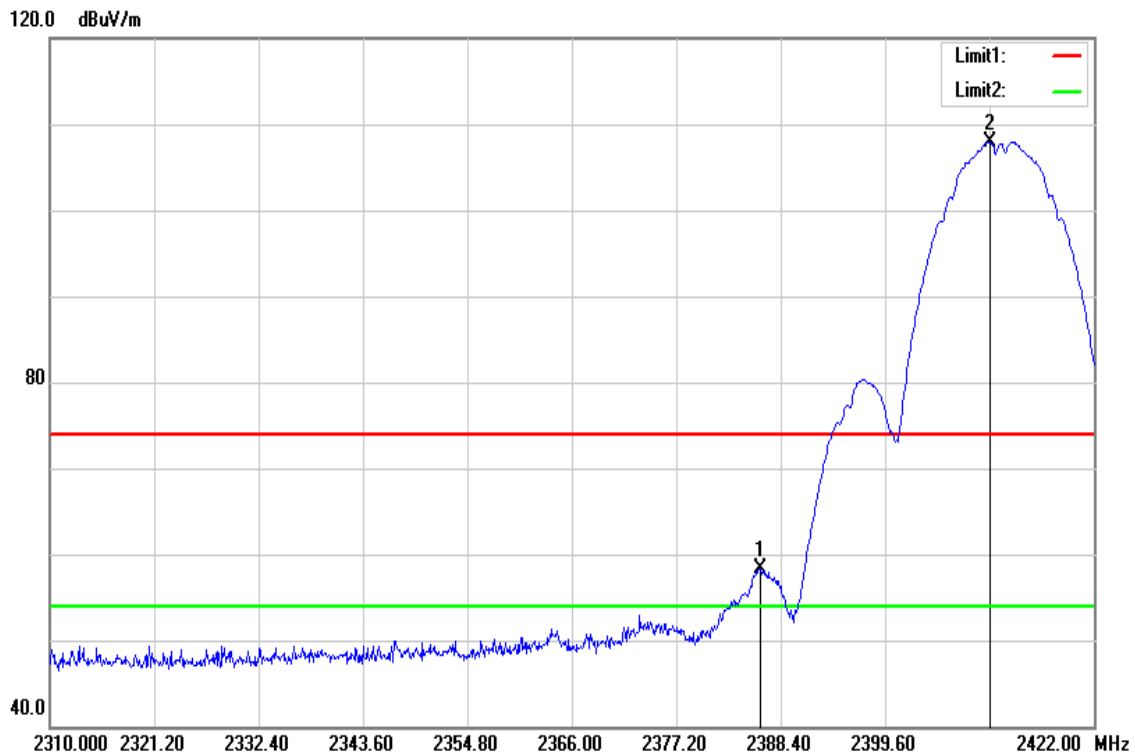

Frequency (MHz)	Reading (dBuV)	Correct Factor (dB/m)	Result (dBuV/m)	Limit (dBuV/m)	Margin (dB)	Remark
2386.272	61.35	-3.12	58.23	74.00	-15.77	peak
2410.912	111.01	-3.08	107.93	-	-	peak

Report No.: T181220D08-RP

Test Mode	IEEE 802.11b Low CH	Temperature:	22.1(°C)/ 50%RH
Test Item	Band Edge	Test Date	December 24, 2018
Polarize	Horizontal	Test Engineer	Jerry Chuang
Detector	Average		

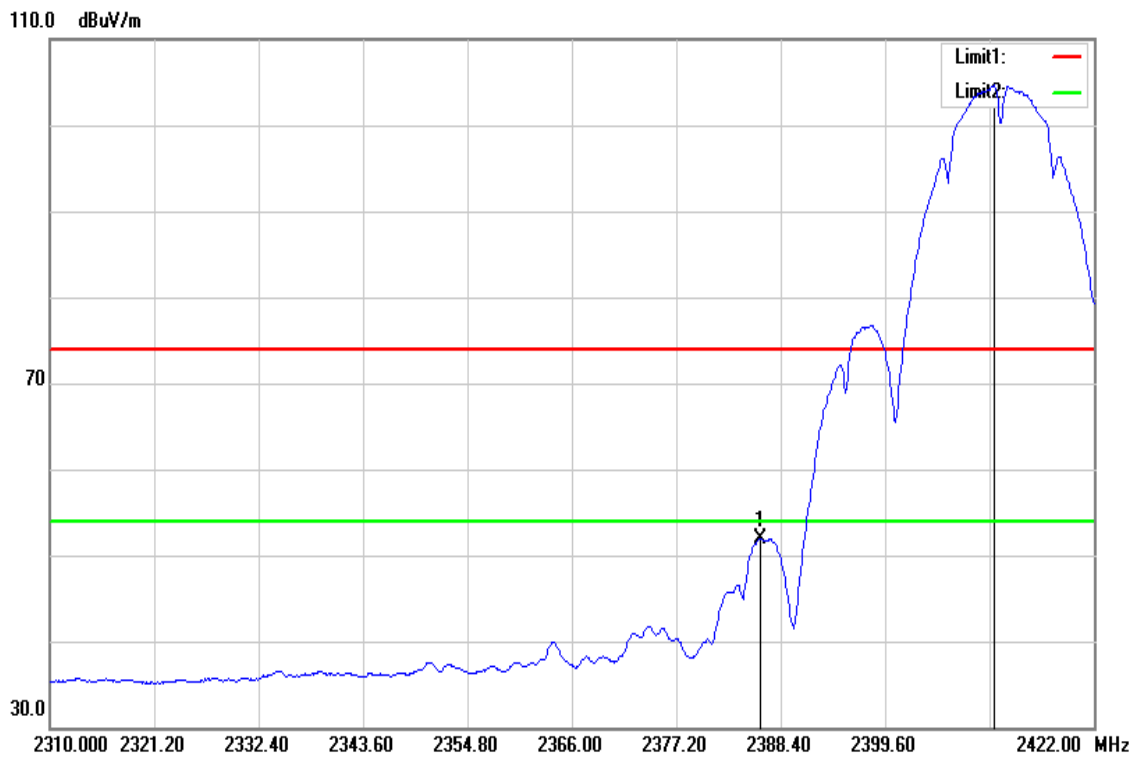

Frequency (MHz)	Reading (dBuV)	Correct Factor (dB/m)	Result (dBuV/m)	Limit (dBuV/m)	Margin (dB)	Remark
2386.272	55.10	-3.12	51.98	54.00	-2.02	AVG
2411.248	107.71	-3.08	104.63	-	-	AVG

Test Mode	IEEE 802.11b High CH	Temp/Hum	22.1(°C)/ 50%RH
Test Item	Band Edge	Test Date	December 24, 2018
Polarize	Horizontal	Test Engineer	Jerry Chuang
Detector	Peak		

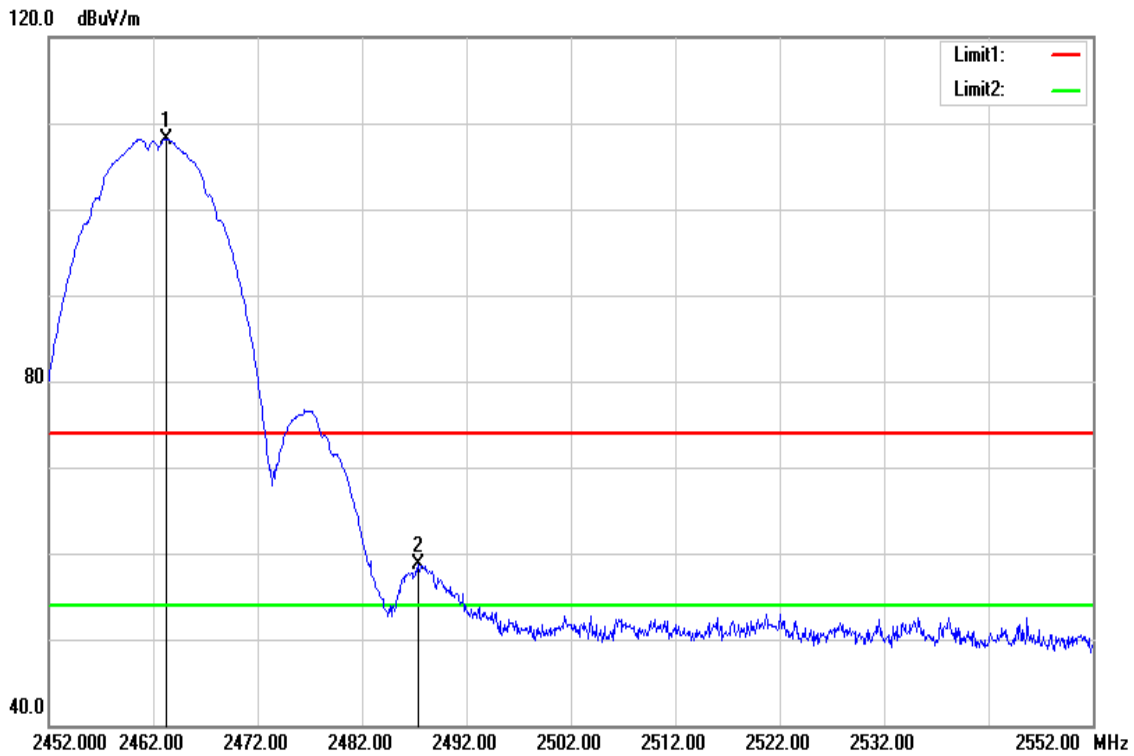

Frequency (MHz)	Reading (dBuV)	Correct Factor (dB/m)	Result (dBuV/m)	Limit (dBuV/m)	Margin (dB)	Remark
2463.200	110.99	-2.82	108.17	-	-	peak
2487.400	61.36	-2.69	58.67	74.00	-15.33	peak

Report No.: T181220D08-RP

Test Mode	IEEE 802.11b High CH	Temperature:	22.1(°C)/ 50%RH
Test Item	Band Edge	Test Date	December 24, 2018
Polarize	Horizontal	Test Engineer	Jerry Chuang
Detector	Average		

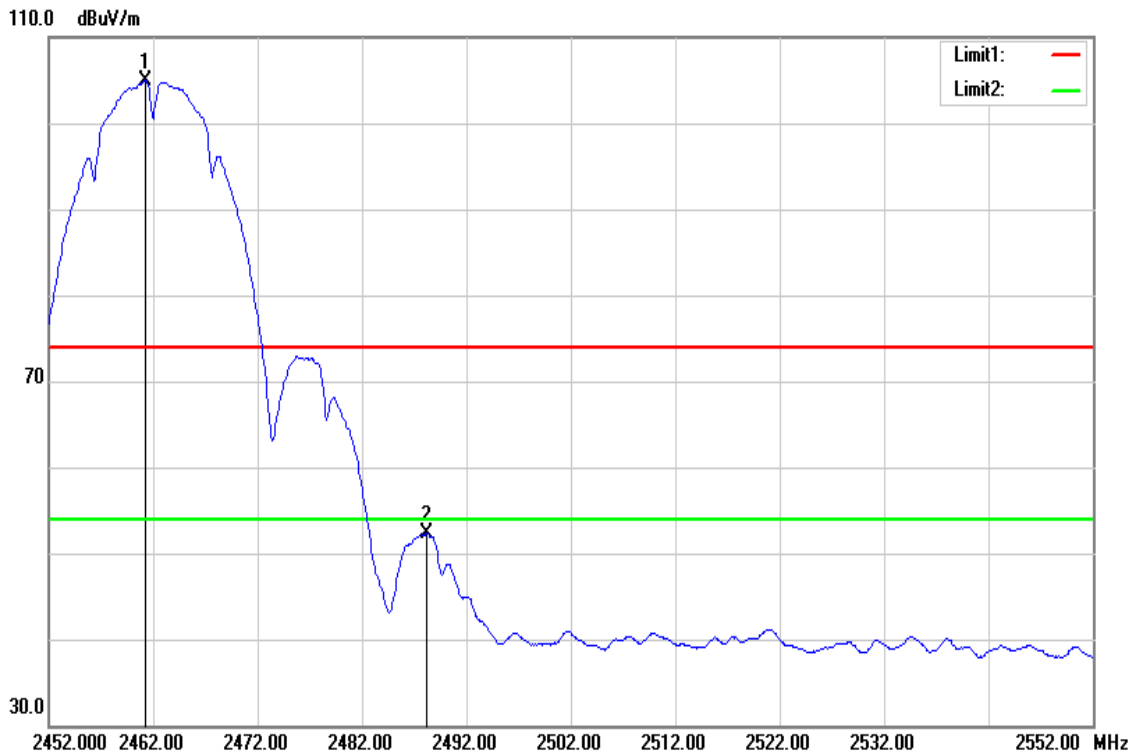

Frequency (MHz)	Reading (dBuV)	Correct Factor (dB/m)	Result (dBuV/m)	Limit (dBuV/m)	Margin (dB)	Remark
2459.700	103.78	-2.84	100.94	-	-	AVG
2483.500	43.34	-2.71	40.63	54.00	-13.37	AVG

Test Mode	IEEE 802.11g Low CH	Temp/Hum	22.1(°C)/ 50%RH
Test Item	Band Edge	Test Date	December 24, 2018
Polarize	Horizontal	Test Engineer	Jerry Chuang
Detector	Peak		

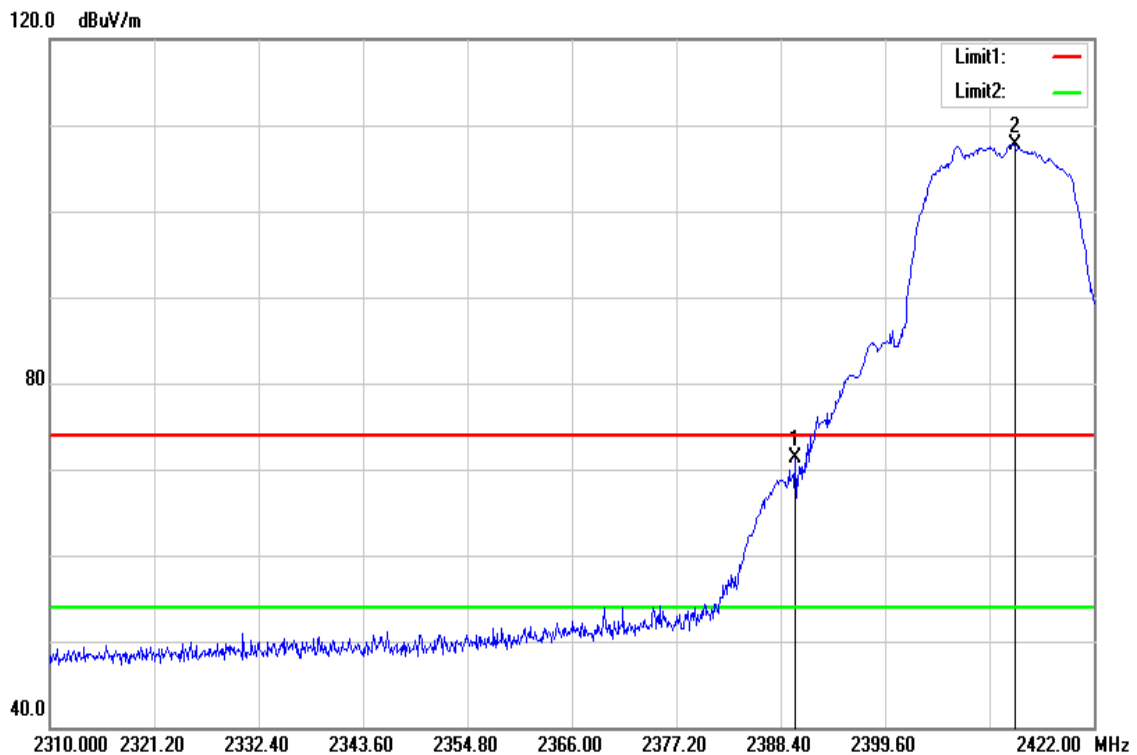

Frequency (MHz)	Reading (dBuV)	Correct Factor (dB/m)	Result (dBuV/m)	Limit (dBuV/m)	Margin (dB)	Remark
2389.968	74.34	-3.13	71.21	74.00	-2.79	peak
2413.488	110.81	-3.06	107.75	-	-	peak



Test Mode	IEEE 802.11g Low CH	Temperature:	22.1(°C)/ 50%RH
Test Item	Band Edge	Test Date	December 24, 2018
Polarize	Horizontal	Test Engineer	Jerry Chuang
Detector	Average		

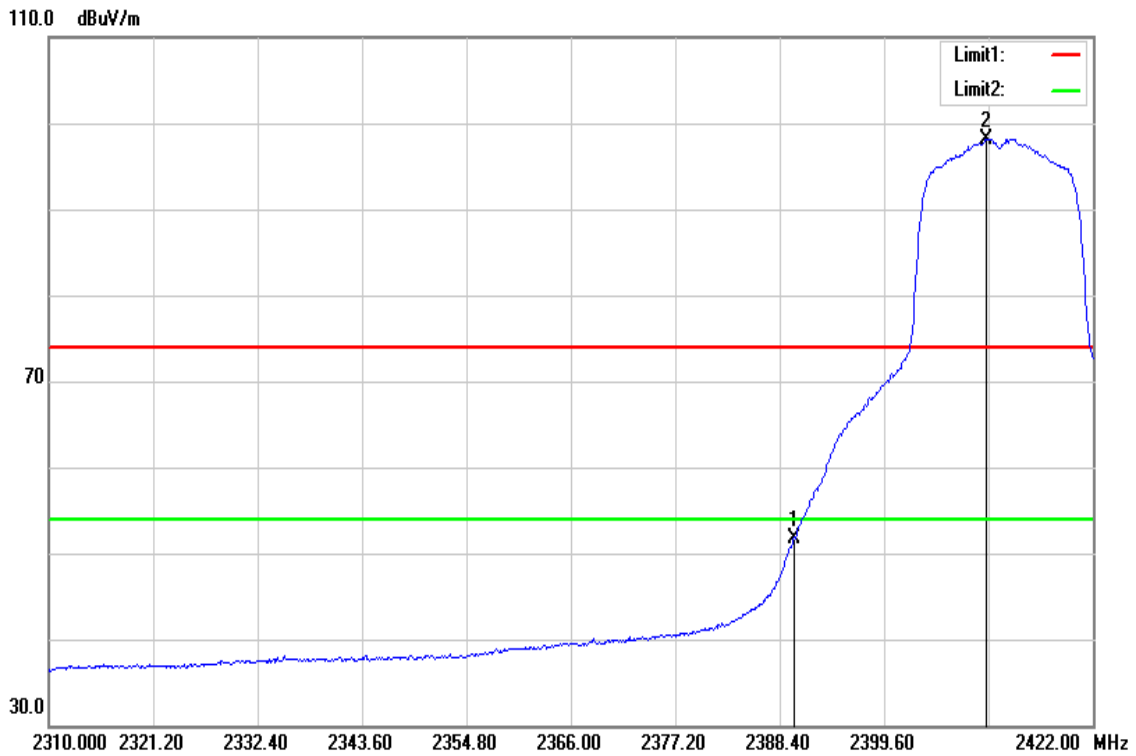

Frequency (MHz)	Reading (dBuV)	Correct Factor (dB/m)	Result (dBuV/m)	Limit (dBuV/m)	Margin (dB)	Remark
2390.000	54.87	-3.13	51.74	54.00	-2.26	AVG
2410.576	101.25	-3.08	98.17	-	-	AVG

Test Mode	IEEE 802.11g High CH	Temp/Hum	22.1(°C)/ 50%RH
Test Item	Band Edge	Test Date	December 24, 2018
Polarize	Horizontal	Test Engineer	Jerry Chuang
Detector	Peak		

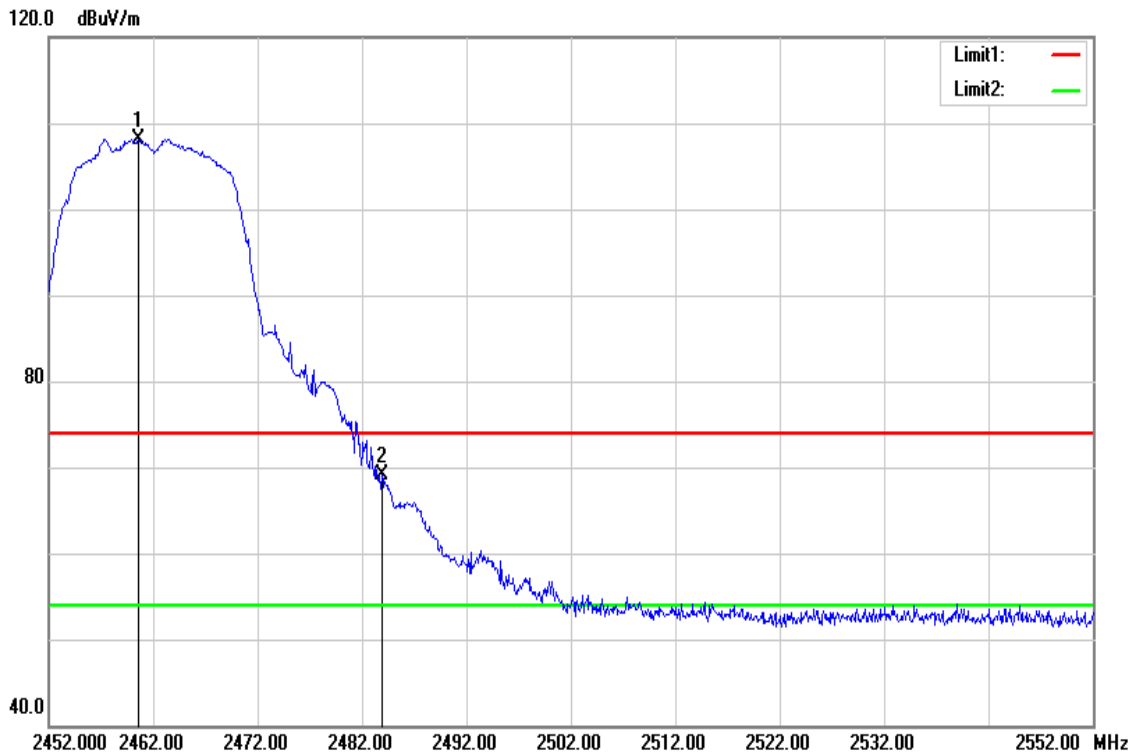

Frequency (MHz)	Reading (dBuV)	Correct Factor (dB/m)	Result (dBuV/m)	Limit (dBuV/m)	Margin (dB)	Remark
2460.600	111.03	-2.84	108.19	-	-	peak
2483.900	71.77	-2.71	69.06	74.00	-4.94	peak

Report No.: T181220D08-RP

Test Mode	IEEE 802.11g High CH	Temperature:	22.1(°C)/ 50%RH
Test Item	Band Edge	Test Date	December 24, 2018
Polarize	Horizontal	Test Engineer	Jerry Chuang
Detector	Average		

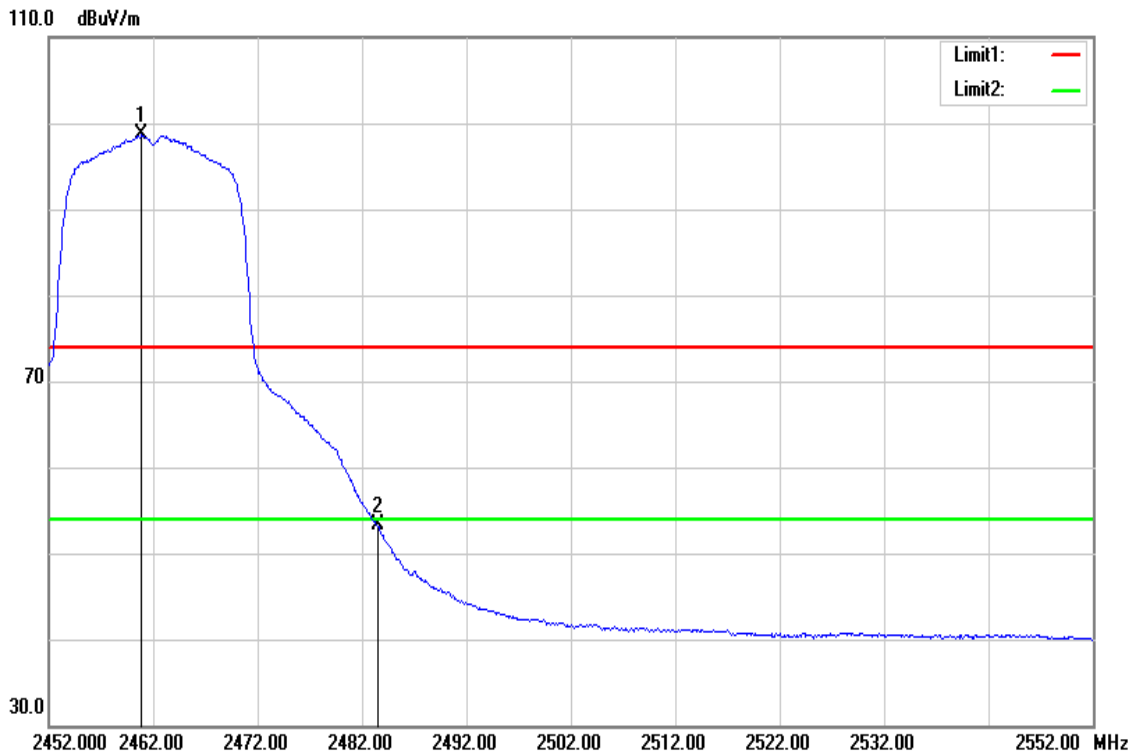

Frequency (MHz)	Reading (dBuV)	Correct Factor (dB/m)	Result (dBuV/m)	Limit (dBuV/m)	Margin (dB)	Remark
2460.900	101.50	-2.84	98.66	-	-	AVG
2483.500	55.91	-2.71	53.20	54.00	-0.80	AVG

Test Mode	IEEE 802.11n HT20 Low CH	Temp/Hum	22.1(°C)/ 50%RH
Test Item	Band Edge	Test Date	December 24, 2018
Polarize	Horizontal	Test Engineer	Jerry Chuang
Detector	Peak		

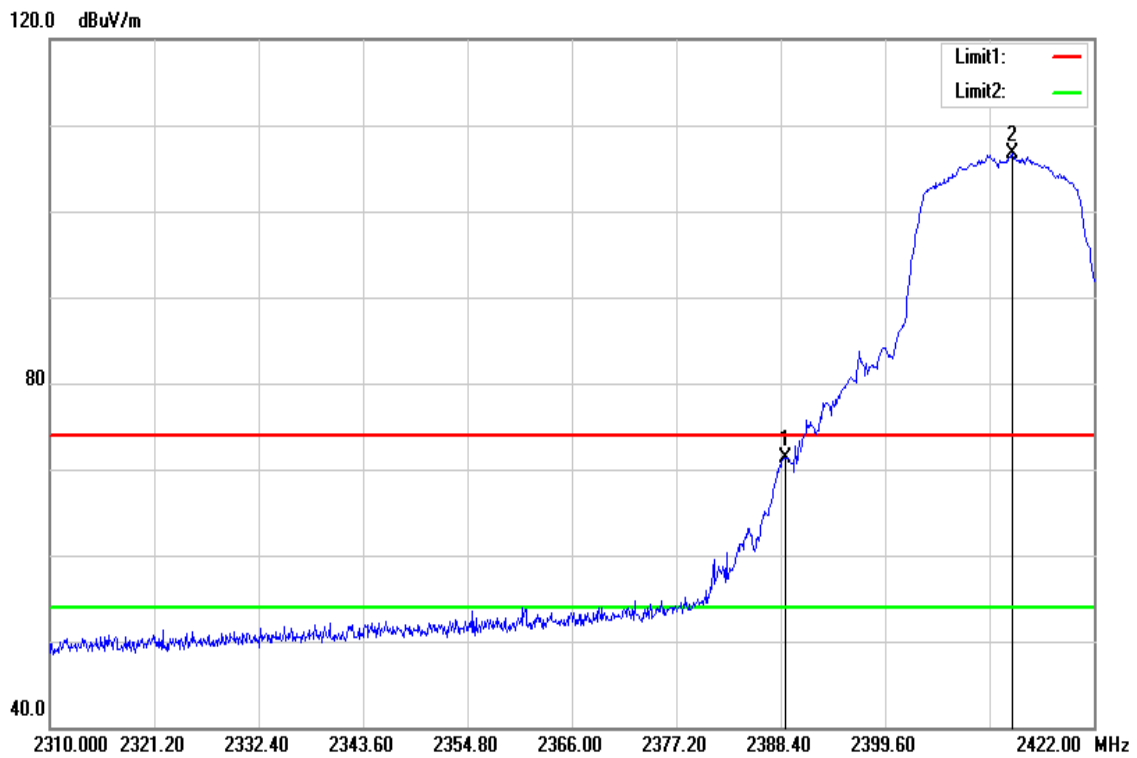

Frequency (MHz)	Reading (dBuV)	Correct Factor (dB/m)	Result (dBuV/m)	Limit (dBuV/m)	Margin (dB)	Remark
2388.960	74.52	-3.13	71.39	74.00	-2.61	peak
2413.264	109.71	-3.06	106.65	-	-	peak

Test Mode	IEEE 802.11n HT20 Low CH	Temperature:	22.1(°C)/ 50%RH
Test Item	Band Edge	Test Date	December 24, 2018
Polarize	Horizontal	Test Engineer	Jerry Chuang
Detector	Average		

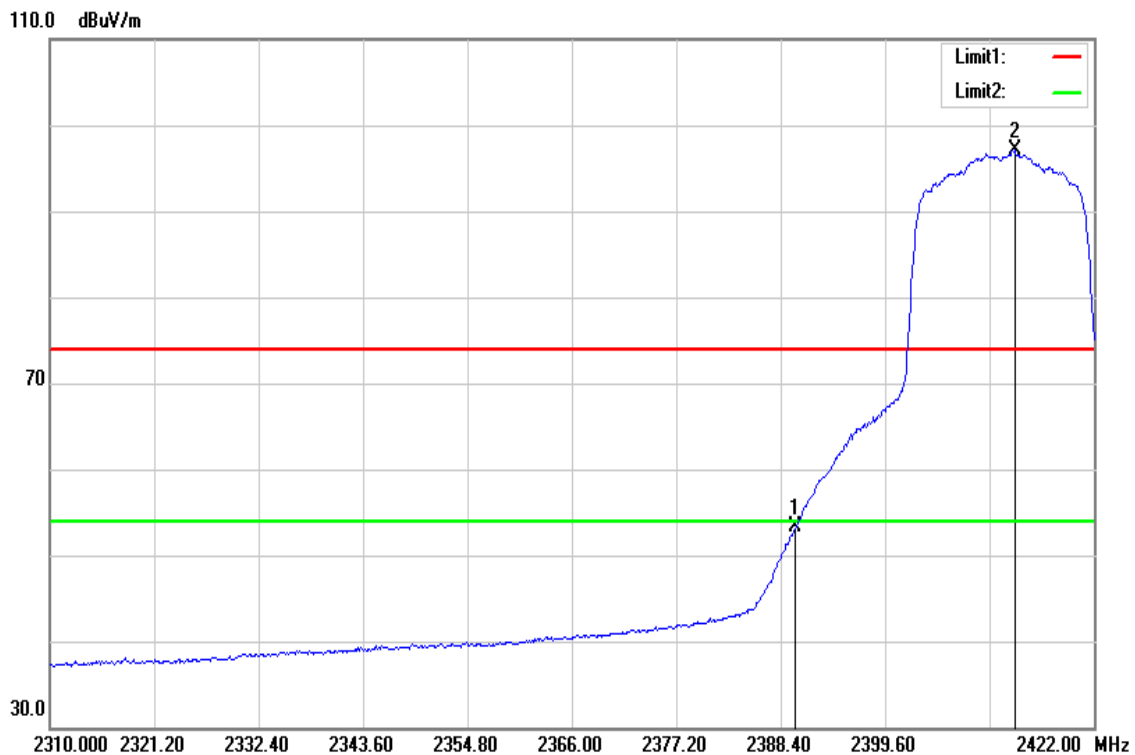

Frequency (MHz)	Reading (dBuV)	Correct Factor (dB/m)	Result (dBuV/m)	Limit (dBuV/m)	Margin (dB)	Remark
2390.000	56.51	-3.13	53.38	54.00	-0.62	AVG
2413.488	100.07	-3.06	97.01	-	-	AVG

Test Mode	IEEE 802.11n HT20 High CH	Temp/Hum	22.1(°C)/ 50%RH
Test Item	Band Edge	Test Date	December 24, 2018
Polarize	Horizontal	Test Engineer	Jerry Chuang
Detector	Peak		

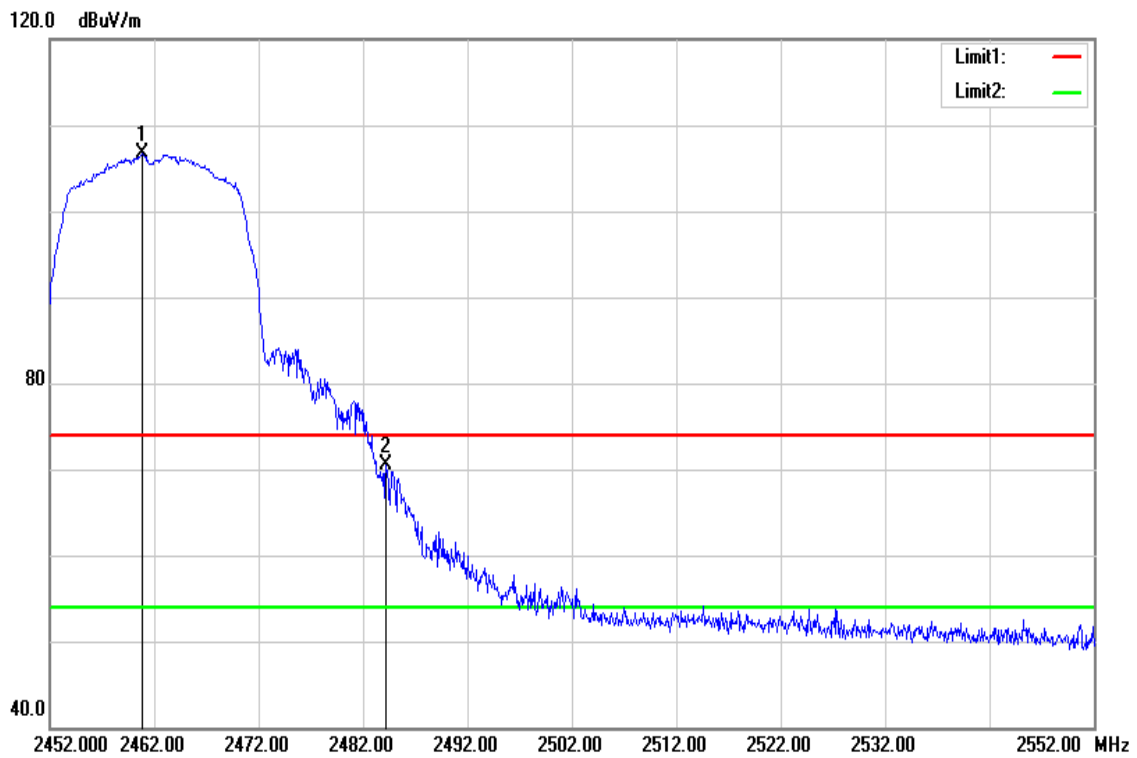

Frequency (MHz)	Reading (dBuV)	Correct Factor (dB/m)	Result (dBuV/m)	Limit (dBuV/m)	Margin (dB)	Remark
2460.800	109.51	-2.84	106.67	-	-	peak
2484.200	73.14	-2.71	70.43	74.00	-3.57	peak

Test Mode	IEEE 802.11n HT20 High CH	Temperature:	22.1(°C)/ 50%RH
Test Item	Band Edge	Test Date	December 24, 2018
Polarize	Horizontal	Test Engineer	Jerry Chuang
Detector	Average		

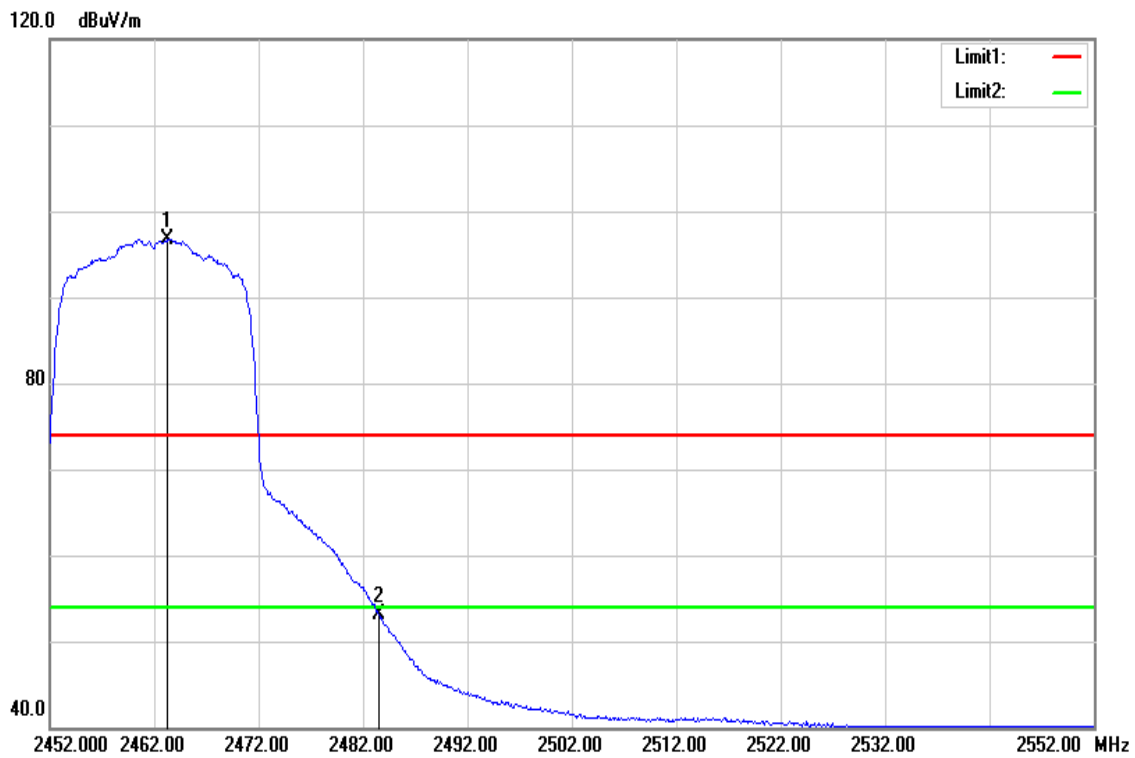

Frequency (MHz)	Reading (dBuV)	Correct Factor (dB/m)	Result (dBuV/m)	Limit (dBuV/m)	Margin (dB)	Remark
2463.300	99.61	-2.82	96.79	-	-	AVG
2483.500	55.90	-2.71	53.19	54.00	-0.81	AVG

Test Mode	IEEE 802.11n HT40 Low CH	Temp/Hum	22.1(°C)/ 50%RH
Test Item	Band Edge	Test Date	December 24, 2018
Polarize	Horizontal	Test Engineer	Jerry Chuang
Detector	Peak		

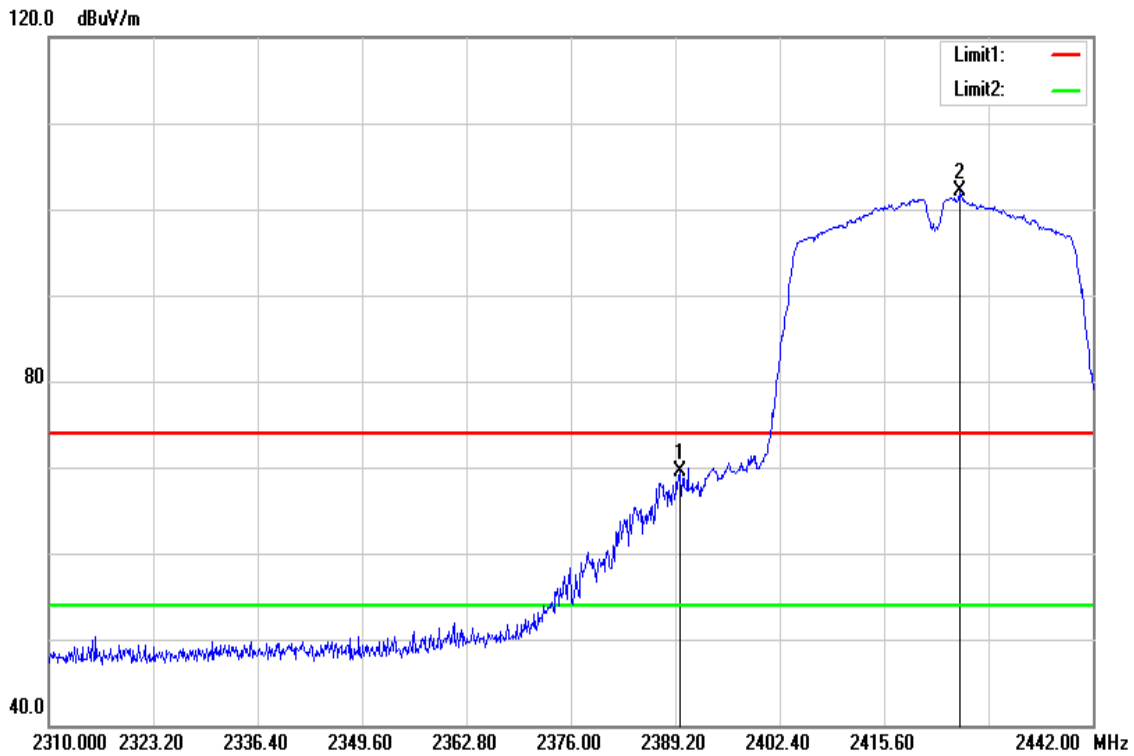

Frequency (MHz)	Reading (dBuV)	Correct Factor (dB/m)	Result (dBuV/m)	Limit (dBuV/m)	Margin (dB)	Remark
2389.860	72.67	-3.13	69.54	74.00	-4.46	peak
2425.104	105.07	-3.01	102.06	-	-	peak



Test Mode	IEEE 802.11n HT40 Low CH	Temperature:	22.1(°C)/ 50%RH
Test Item	Band Edge	Test Date	December 24, 2018
Polarize	Horizontal	Test Engineer	Jerry Chuang
Detector	Average		

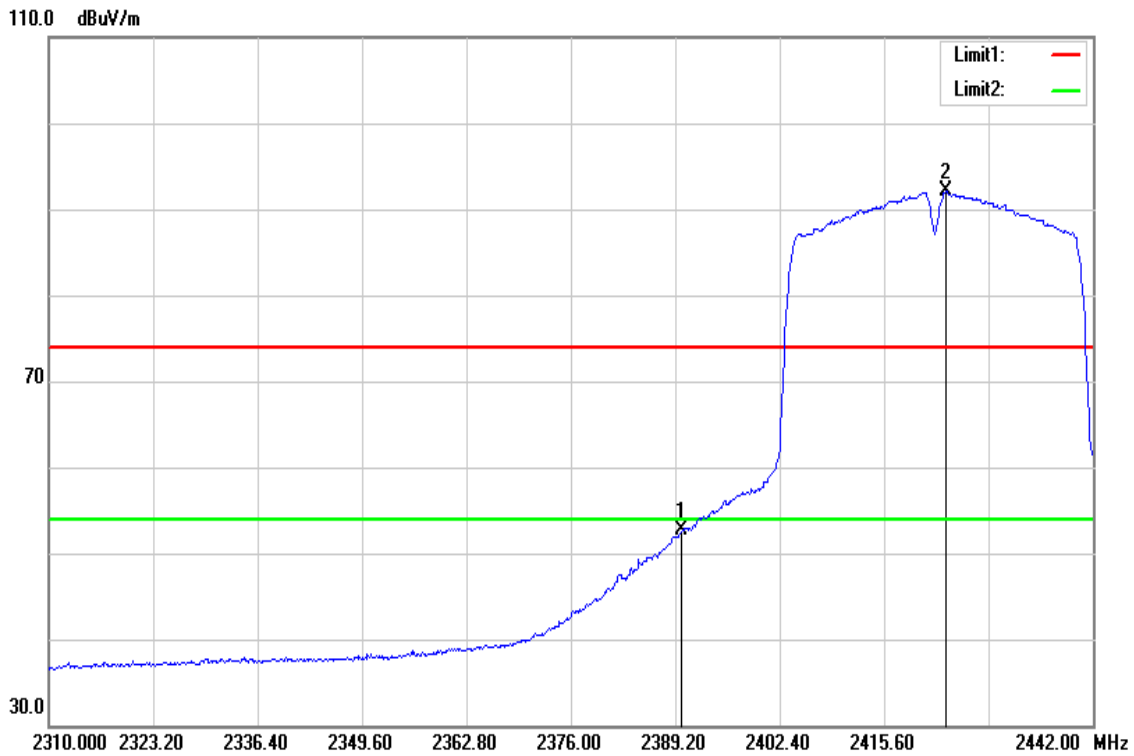

Frequency (MHz)	Reading (dBuV)	Correct Factor (dB/m)	Result (dBuV/m)	Limit (dBuV/m)	Margin (dB)	Remark
2390.000	55.77	-3.13	52.64	54.00	-1.36	AVG
2423.388	95.09	-3.02	92.07	-	-	AVG

Test Mode	IEEE 802.11n HT40 High CH	Temp/Hum	22.1(°C)/ 50%RH
Test Item	Band Edge	Test Date	December 24, 2018
Polarize	Horizontal	Test Engineer	Jerry Chuang
Detector	Peak		

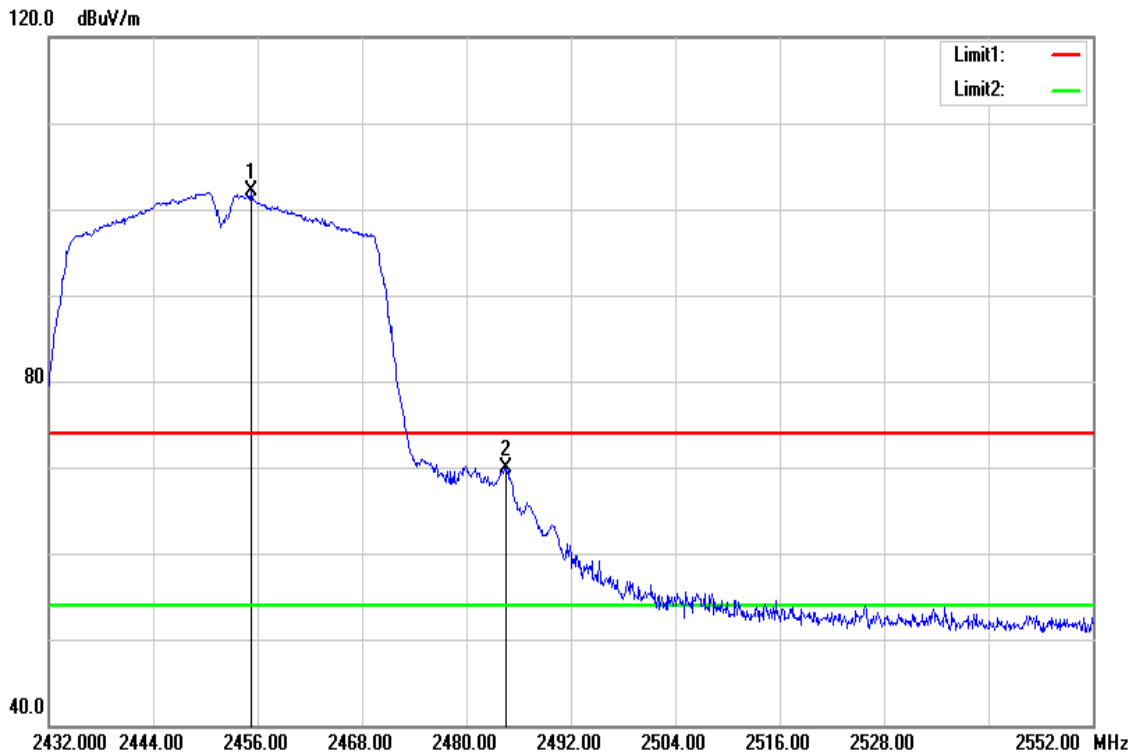

Frequency (MHz)	Reading (dBuV)	Correct Factor (dB/m)	Result (dBuV/m)	Limit (dBuV/m)	Margin (dB)	Remark
2455.280	104.96	-2.86	102.10	-	-	peak
2484.560	72.67	-2.70	69.97	74.00	-4.03	peak

Test Mode	IEEE 802.11n HT40 High CH	Temperature:	22.1(°C)/ 50%RH
Test Item	Band Edge	Test Date	December 24, 2018
Polarize	Horizontal	Test Engineer	Jerry Chuang
Detector	Average		

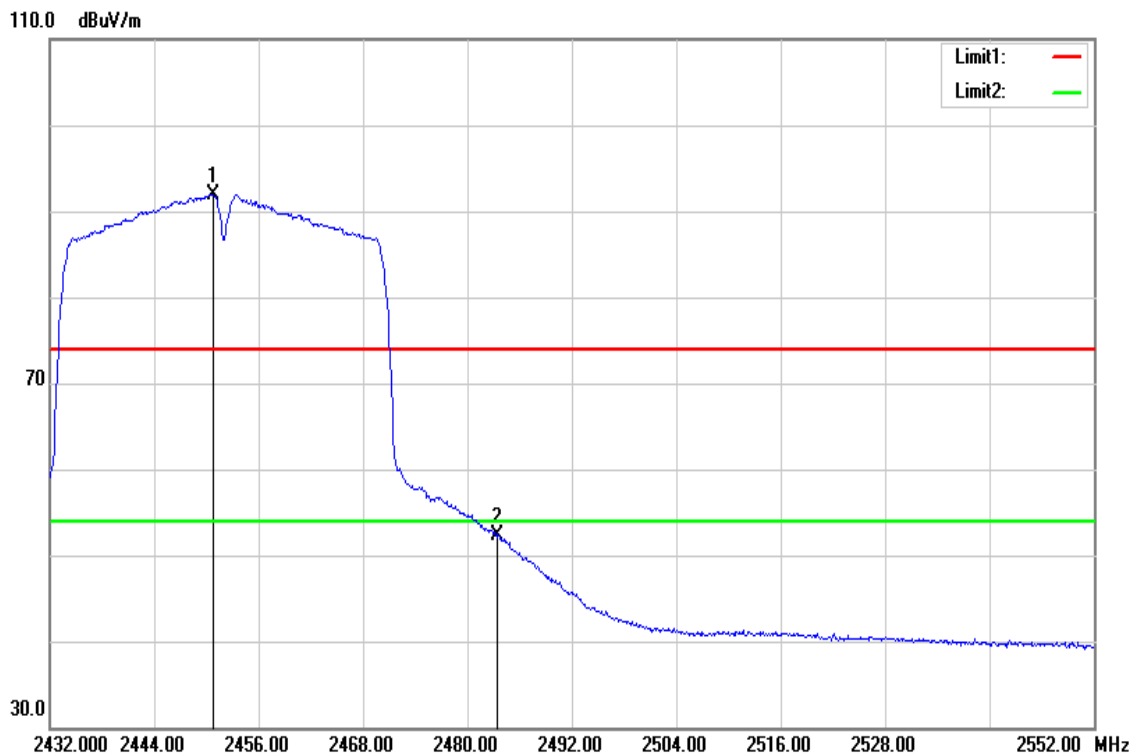

Frequency (MHz)	Reading (dBuV)	Correct Factor (dB/m)	Result (dBuV/m)	Limit (dBuV/m)	Margin (dB)	Remark
2450.840	94.84	-2.88	91.96	-	-	AVG
2483.500	55.07	-2.71	52.36	54.00	-1.64	AVG

Report No.: T181220D08-RP

**Below 1G Test Data**

Test Mode	Mode 1	Temp/Hum	22.1(°C)/ 50%RH
Test Item	30MHz-1GHz	Test Date	December 21, 2018
Polarize	Vertical	Test Engineer	Jerry Chuang
Detector	Peak and Quasi-peak		

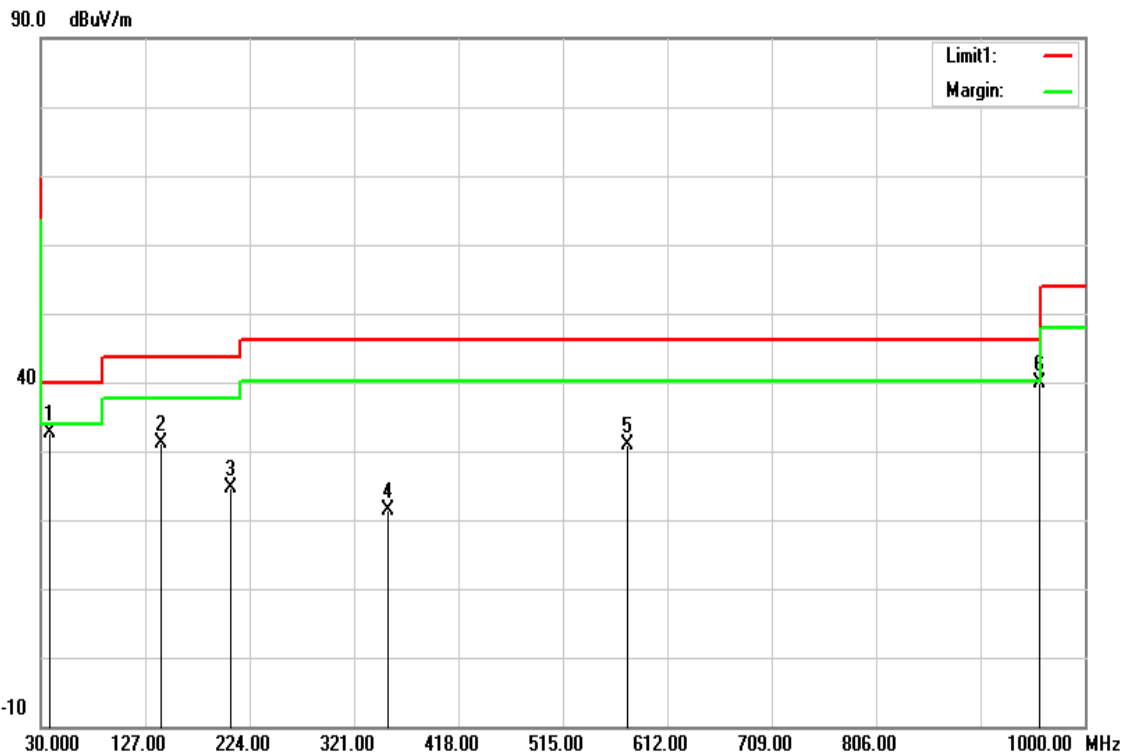

Frequency (MHz)	Reading (dBuV)	Correct Factor (dB/m)	Result (dBuV/m)	Limit (dBuV/m)	Margin (dB)	Remark
38.7300	40.61	-8.05	32.56	40.00	-7.44	QP
141.5500	40.28	-9.13	31.15	43.52	-12.37	peak
206.5400	34.07	-9.39	24.68	43.52	-18.84	peak
352.0400	27.59	-6.13	21.46	46.02	-24.56	peak
575.1400	31.75	-0.97	30.78	46.02	-15.24	peak
958.2900	34.67	5.33	40.00	46.02	-6.02	QP

Test Mode	Mode 1	Temp/Hum	22.1(°C)/ 50%RH
Test Item	30MHz-1GHz	Test Date	December 21, 2018
Polarize	Horizontal	Test Engineer	Jerry Chuang
Detector	Peak and Quasi-peak		

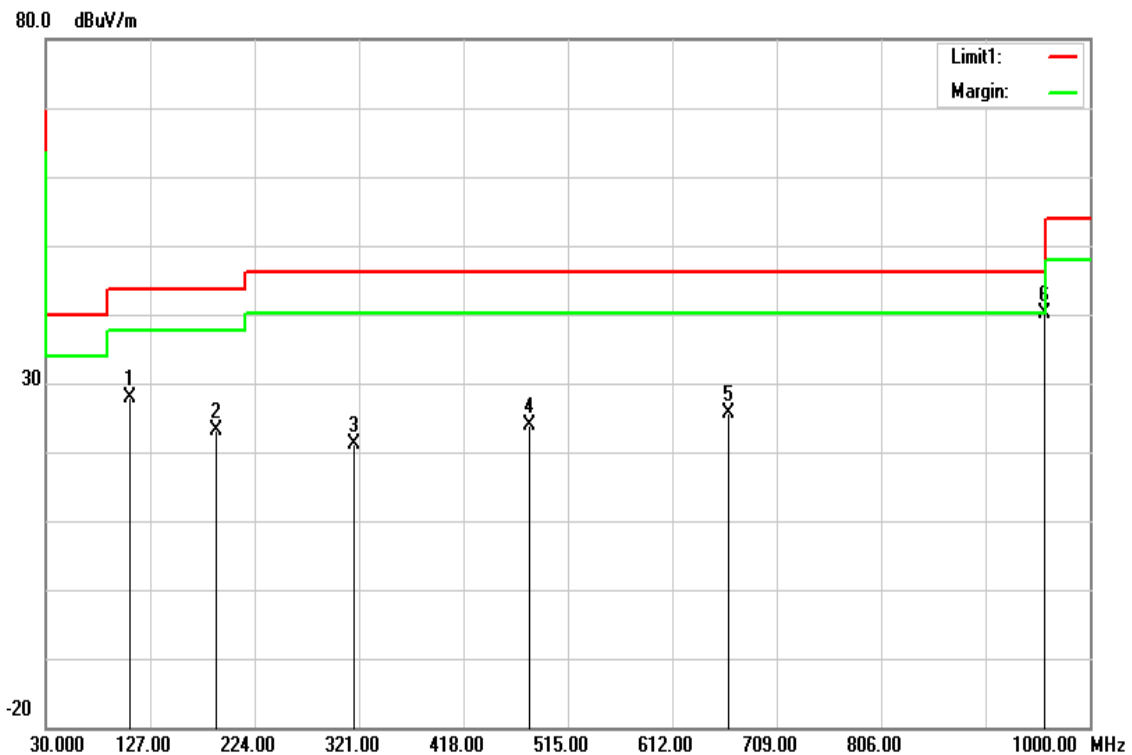

Frequency (MHz)	Reading (dBuV)	Correct Factor (dB/m)	Result (dBuV/m)	Limit (dBuV/m)	Margin (dB)	Remark
108.5700	38.30	-10.50	27.80	43.52	-15.72	peak
188.1100	32.99	-9.79	23.20	43.52	-20.32	peak
316.1500	28.26	-7.01	21.25	46.02	-24.77	peak
479.1100	26.17	-2.29	23.88	46.02	-22.14	peak
664.3800	25.11	0.64	25.75	46.02	-20.27	peak
958.2900	34.74	5.33	40.07	46.02	-5.95	QP

Report No.: T181220D08-RP

**Above 1G Test Data**

Test Mode	IEEE 802.11b Low CH	Temp/Hum	22.1(°C)/ 50%RH
Test Item	Harmonic	Test Date	December 24, 2018
Polarize	Vertical	Test Engineer	Jerry Chuang
Detector	Peak		

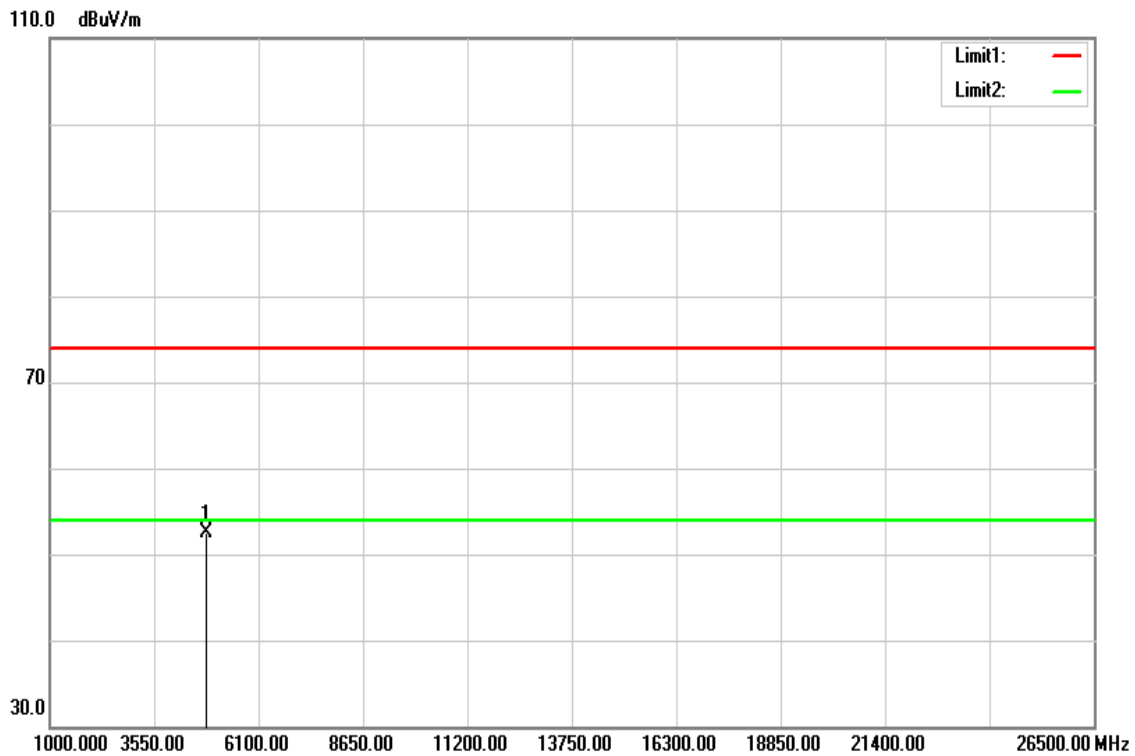

Frequency (MHz)	Reading (dBuV)	Correct Factor (dB/m)	Result (dBuV/m)	Limit (dBuV/m)	Margin (dB)	Remark
4827.000	49.24	3.25	52.49	74.00	-21.51	peak
N/A						

**Remark:**

1. Measuring frequencies from 1 GHz to the 10th harmonic of highest fundamental frequency.
2. For above 1GHz, the EUT peak value was under average limit, therefore the Average value compliance with the average limit

Test Mode	IEEE 802.11b Low CH	Temp/Hum	22.1(°C)/ 50%RH
Test Item	Harmonic	Test Date	December 24, 2018
Polarize	Horizontal	Test Engineer	Jerry Chuang
Detector	Peak		

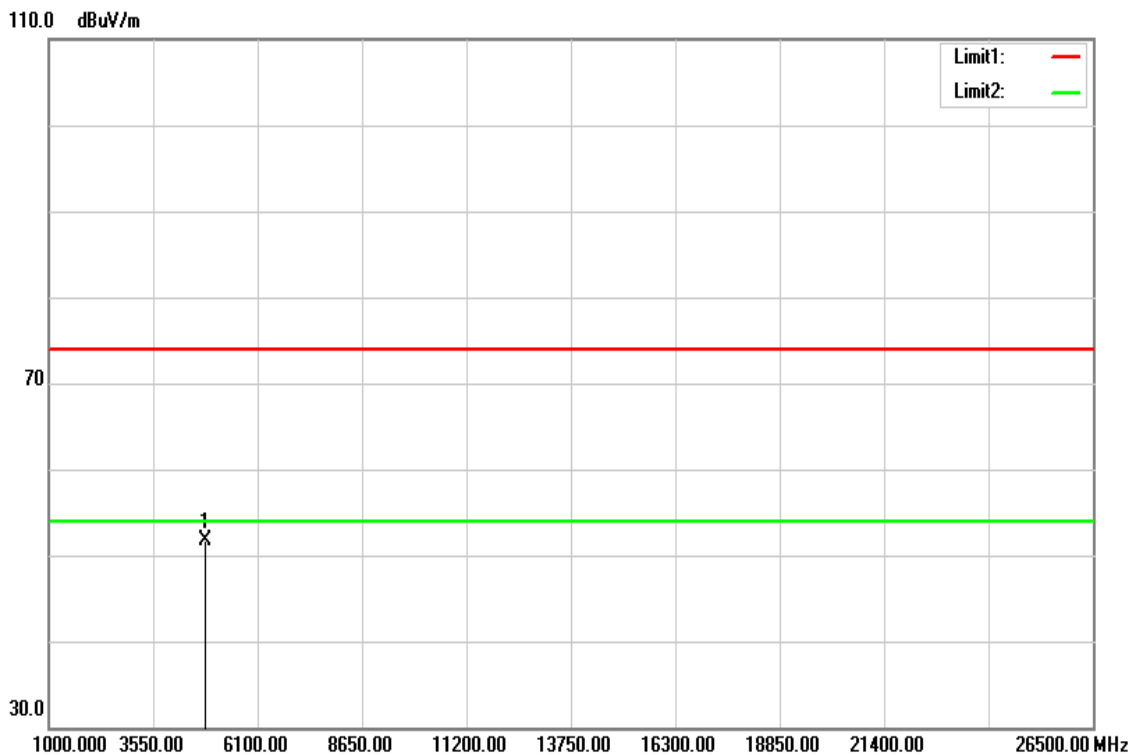

Frequency (MHz)	Reading (dBuV)	Correct Factor (dB/m)	Result (dBuV/m)	Limit (dBuV/m)	Margin (dB)	Remark
4827.000	48.38	3.25	51.63	74.00	-22.37	peak
N/A						

**Remark:**

1. Measuring frequencies from 1 GHz to the 10th harmonic of highest fundamental frequency.
2. For above 1GHz, the EUT peak value was under average limit, therefore the Average value compliance with the average limit

Test Mode	IEEE 802.11b Mid CH	Temp/Hum	22.1(°C)/ 50%RH
Test Item	Harmonic	Test Date	December 24, 2018
Polarize	Vertical	Test Engineer	Jerry Chuang
Detector	Peak		

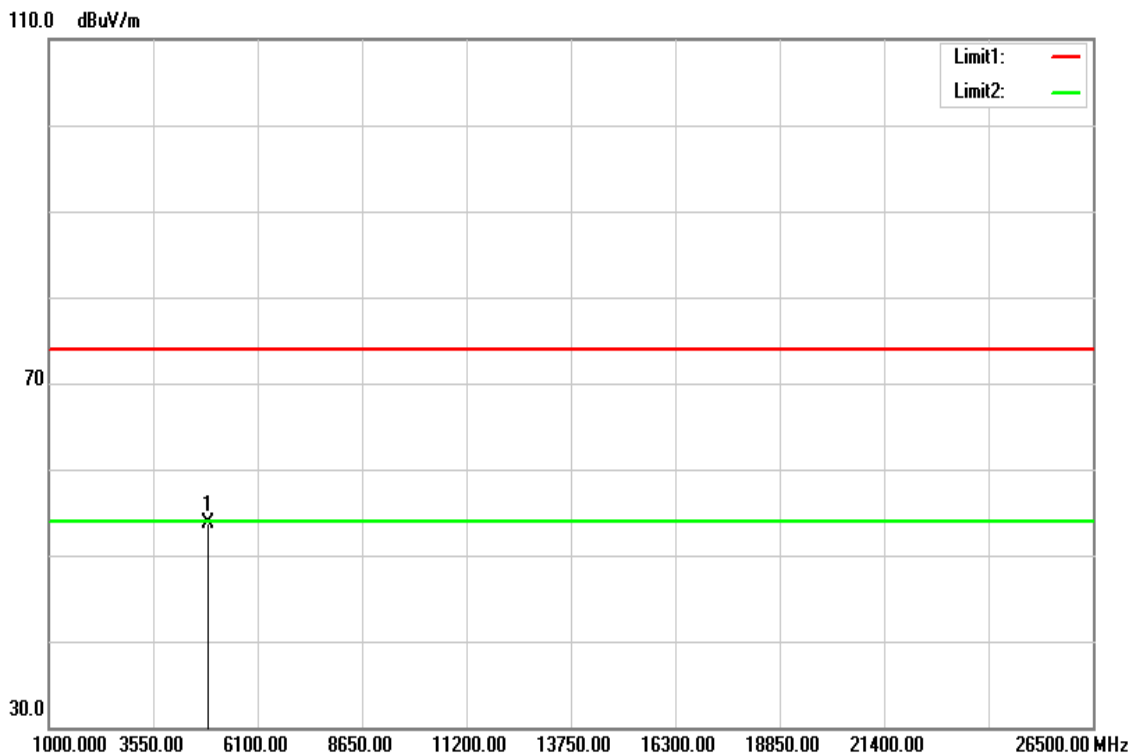

Frequency (MHz)	Reading (dBu )	Correct Factor (dB/m)	Result (dBuV/m)	Limit (dBuV/m)	Margin (dB)	Remark
4876.000	50.13	3.57	53.70	74.00	-20.30	peak
N/A						

**Remark:**

1. Measuring frequencies from 1 GHz to the 10th harmonic of highest fundamental frequency.
2. For above 1GHz, the EUT peak value was under average limit, therefore the Average value compliance with the average limit



Test Mode	IEEE 802.11b Mid CH	Temp/Hum	22.1(°C)/ 50%RH
Test Item	Harmonic	Test Date	December 24, 2018
Polarize	Horizontal	Test Engineer	Jerry Chuang
Detector	Peak		

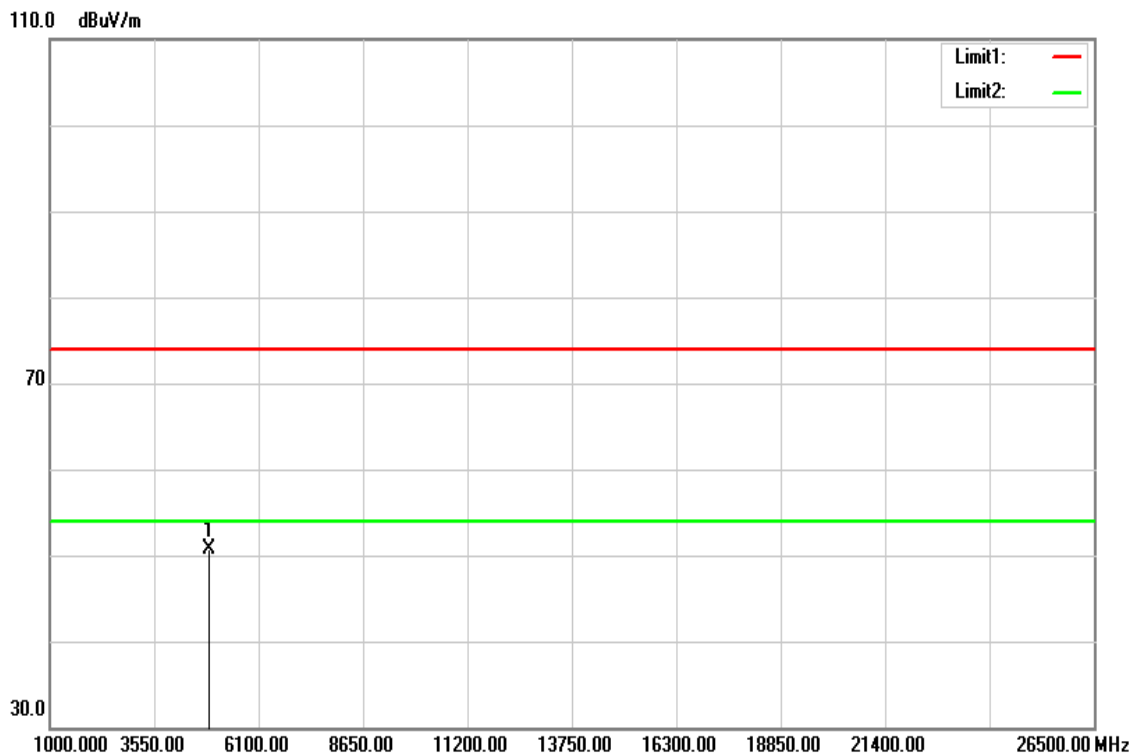

Frequency (MHz)	Reading (dBuV)	Correct Factor (dB/m)	Result (dBuV/m)	Limit (dBuV/m)	Margin (dB)	Remark
4876.000	47.06	3.57	50.63	74.00	-23.37	peak
N/A						

**Remark:**

1. Measuring frequencies from 1 GHz to the 10th harmonic of highest fundamental frequency.
2. For above 1GHz, the EUT peak value was under average limit, therefore the Average value compliance with the average limit

Report No.: T181220D08-RP

Test Mode	IEEE 802.11b High CH	Temp/Hum	22.1(°C)/ 50%RH
Test Item	Harmonic	Test Date	December 24, 2018
Polarize	Vertical	Test Engineer	Jerry Chuang
Detector	Peak and Average		



Frequency (MHz)	Reading (dBuV)	Correct Factor (dB/m)	Result (dBuV/m)	Limit (dBuV/m)	Margin (dB)	Remark
4925.000	50.40	3.90	54.30	74.00	-19.70	peak
4925.000	49.20	3.90	53.10	54.00	-0.90	AVG
N/A						

**Remark:**

1. Measuring frequencies from 1 GHz to the 10th harmonic of highest fundamental frequency.

Test Mode	IEEE 802.11b High CH	Temp/Hum	22.1(°C)/ 50%RH
Test Item	Harmonic	Test Date	December 24, 2018
Polarize	Horizontal	Test Engineer	Jerry Chuang
Detector	Peak and Average		

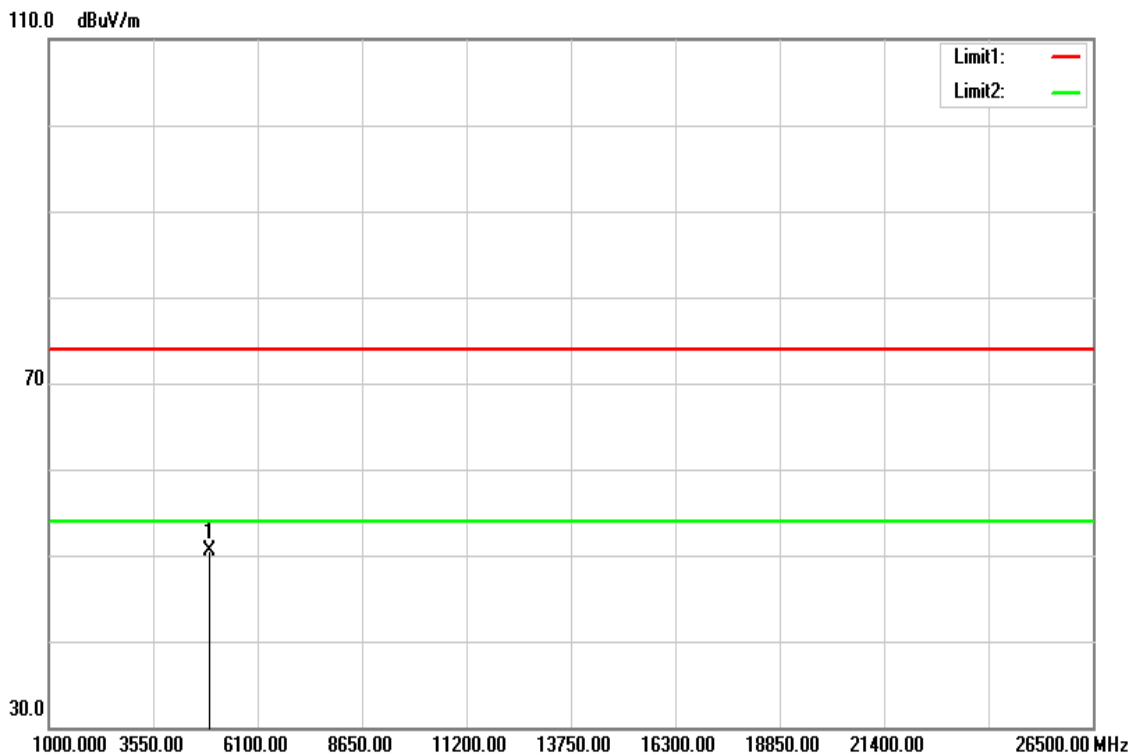

Frequency (MHz)	Reading (dBuV)	Correct Factor (dB/m)	Result (dBuV/m)	Limit (dBuV/m)	Margin (dB)	Remark
4925.000	46.62	3.90	50.52	74.00	-23.48	peak
N/A						

**Remark:**

1. Measuring frequencies from 1 GHz to the 10th harmonic of highest fundamental frequency.
2. For above 1GHz, the EUT peak value was under average limit, therefore the Average value compliance with the average limit

Test Mode	IEEE 802.11g Low CH	Temp/Hum	22.1(°C)/ 50%RH
Test Item	Harmonic	Test Date	December 24, 2018
Polarize	Vertical	Test Engineer	Jerry Chuang
Detector	Peak		

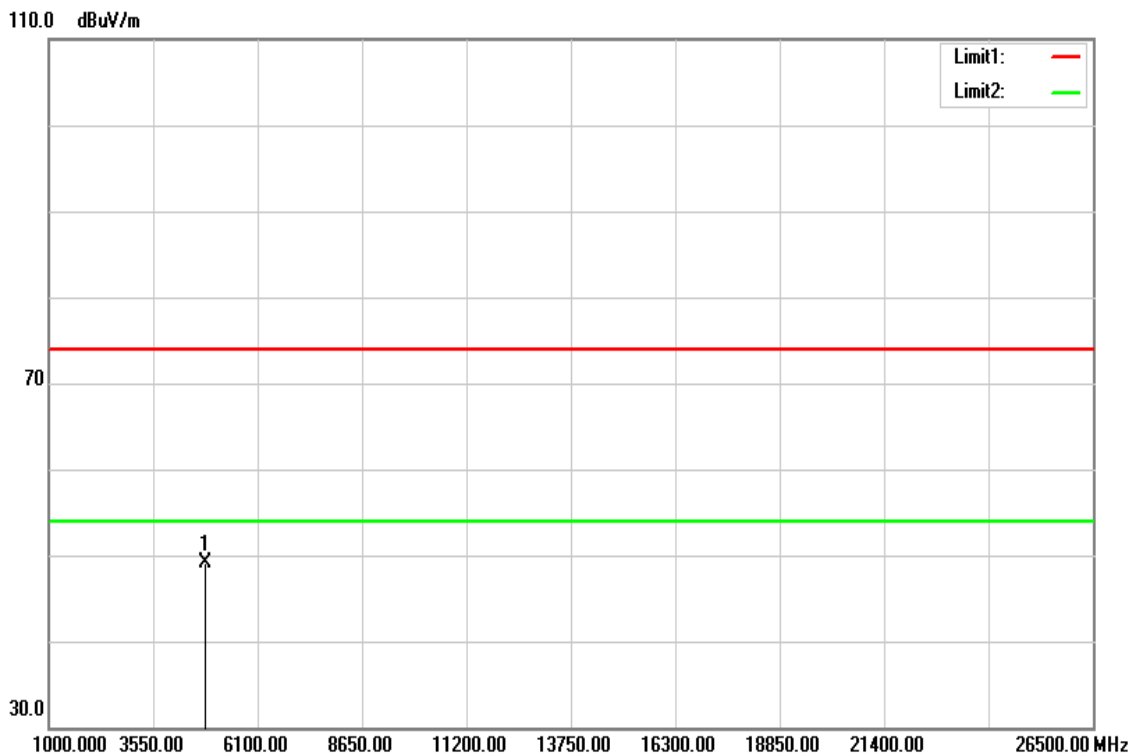

Frequency (MHz)	Reading (dBuV)	Correct Factor (dB/m)	Result (dBuV/m)	Limit (dBuV/m)	Margin (dB)	Remark
4827.000	45.86	3.25	49.11	74.00	-24.89	peak
N/A						

**Remark:**

1. Measuring frequencies from 1 GHz to the 10th harmonic of highest fundamental frequency.
2. For above 1GHz, the EUT peak value was under average limit, therefore the Average value compliance with the average limit

Test Mode	IEEE 802.11g Low CH	Temp/Hum	22.1(°C)/ 50%RH
Test Item	Harmonic	Test Date	December 24, 2018
Polarize	Horizontal	Test Engineer	Jerry Chuang
Detector	Peak		

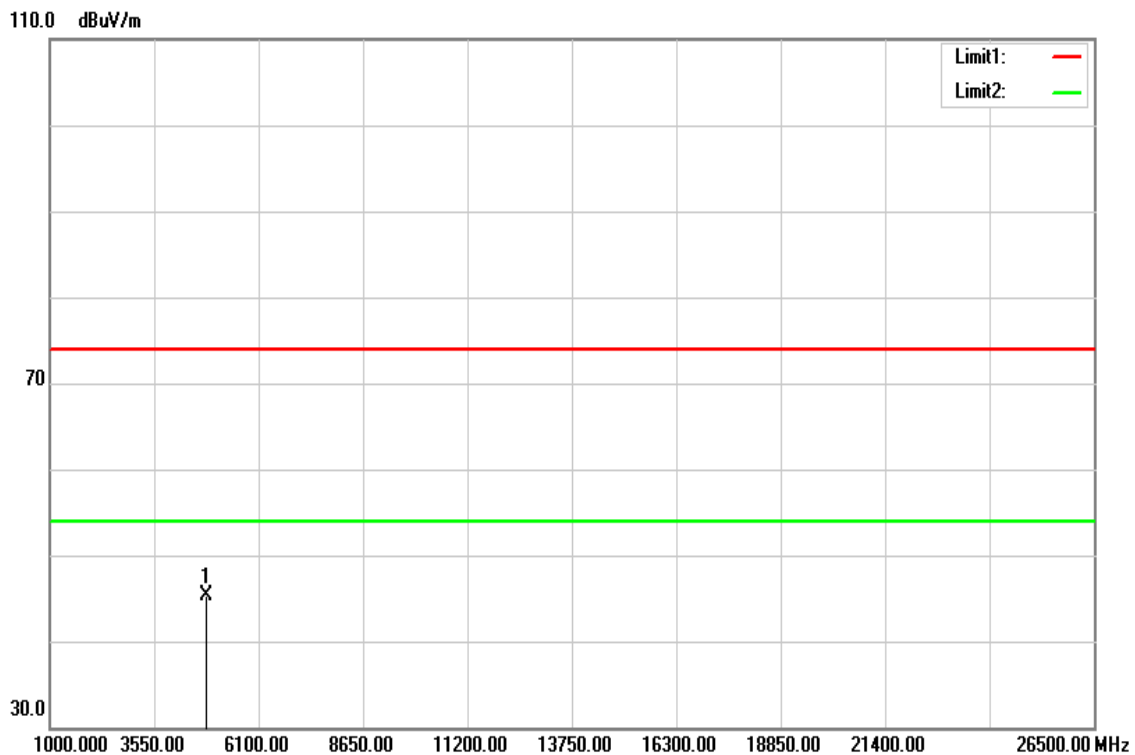

Frequency (MHz)	Reading (dBuV)	Correct Factor (dB/m)	Result (dBuV/m)	Limit (dBuV/m)	Margin (dB)	Remark
4820.000	42.05	3.20	45.25	74.00	-28.75	peak
N/A						

**Remark:**

1. Measuring frequencies from 1 GHz to the 10th harmonic of highest fundamental frequency.
2. For above 1GHz, the EUT peak value was under average limit, therefore the Average value compliance with the average limit

Test Mode	IEEE 802.11g Mid CH	Temp/Hum	22.1(°C)/ 50%RH
Test Item	Harmonic	Test Date	December 24, 2018
Polarize	Vertical	Test Engineer	Jerry Chuang
Detector	Peak		

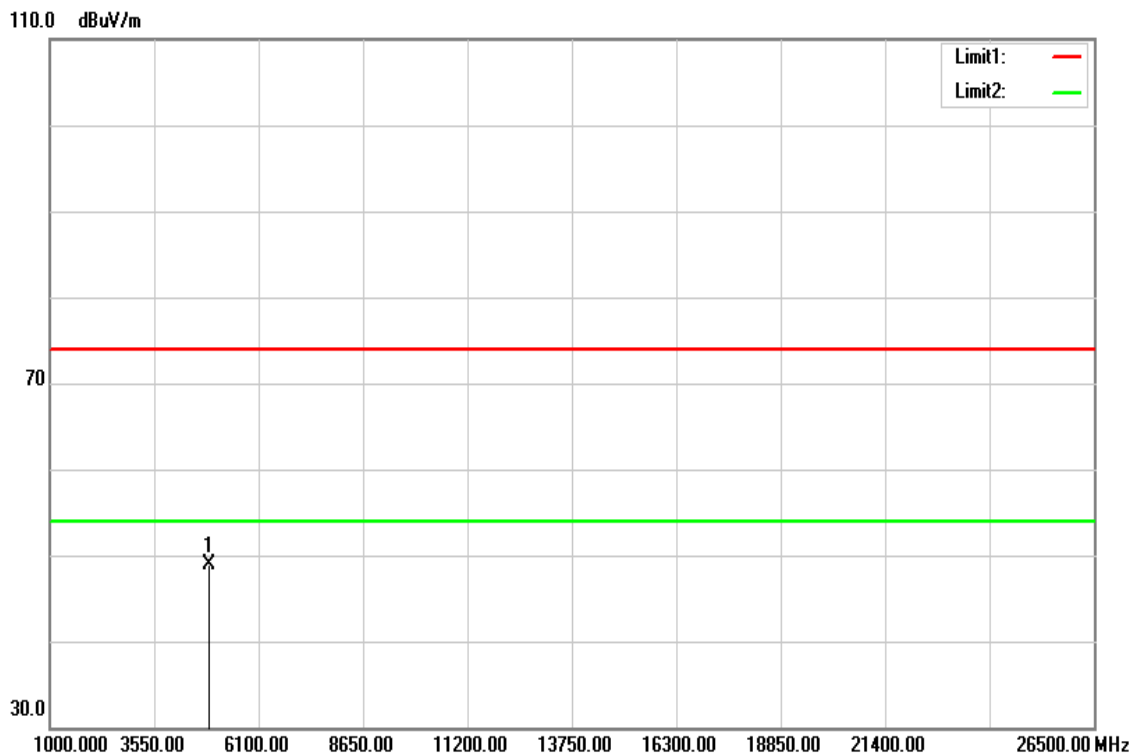

Frequency (MHz)	Reading (dBuV)	Correct Factor (dB/m)	Result (dBuV/m)	Limit (dBuV/m)	Margin (dB)	Remark
4876.000	45.37	3.57	48.94	74.00	-25.06	peak
N/A						

**Remark:**

1. Measuring frequencies from 1 GHz to the 10th harmonic of highest fundamental frequency.
2. For above 1GHz, the EUT peak value was under average limit, therefore the Average value compliance with the average limit

Test Mode	IEEE 802.11g Mid CH	Temp/Hum	22.1(°C)/ 50%RH
Test Item	Harmonic	Test Date	December 24, 2018
Polarize	Horizontal	Test Engineer	Jerry Chuang
Detector	Peak		

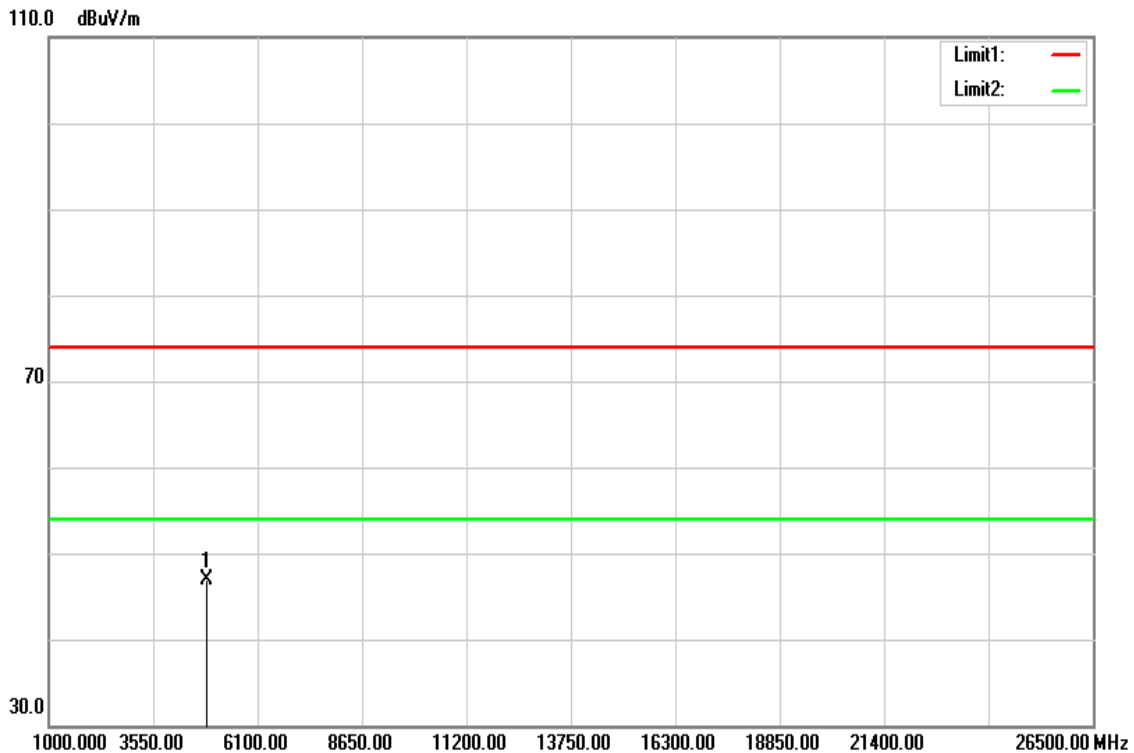

Frequency (MHz)	Reading (dBuV)	Correct Factor (dB/m)	Result (dBuV/m)	Limit (dBuV/m)	Margin (dB)	Remark
4869.000	43.29	3.53	46.82	74.00	-27.18	peak
N/A						

**Remark:**

1. Measuring frequencies from 1 GHz to the 10th harmonic of highest fundamental frequency.
2. For above 1GHz, the EUT peak value was under average limit, therefore the Average value compliance with the average limit

Test Mode	IEEE 802.11g High CH	Temp/Hum	22.1(°C)/ 50%RH
Test Item	Harmonic	Test Date	December 24, 2018
Polarize	Vertical	Test Engineer	Jerry Chuang
Detector	Peak		

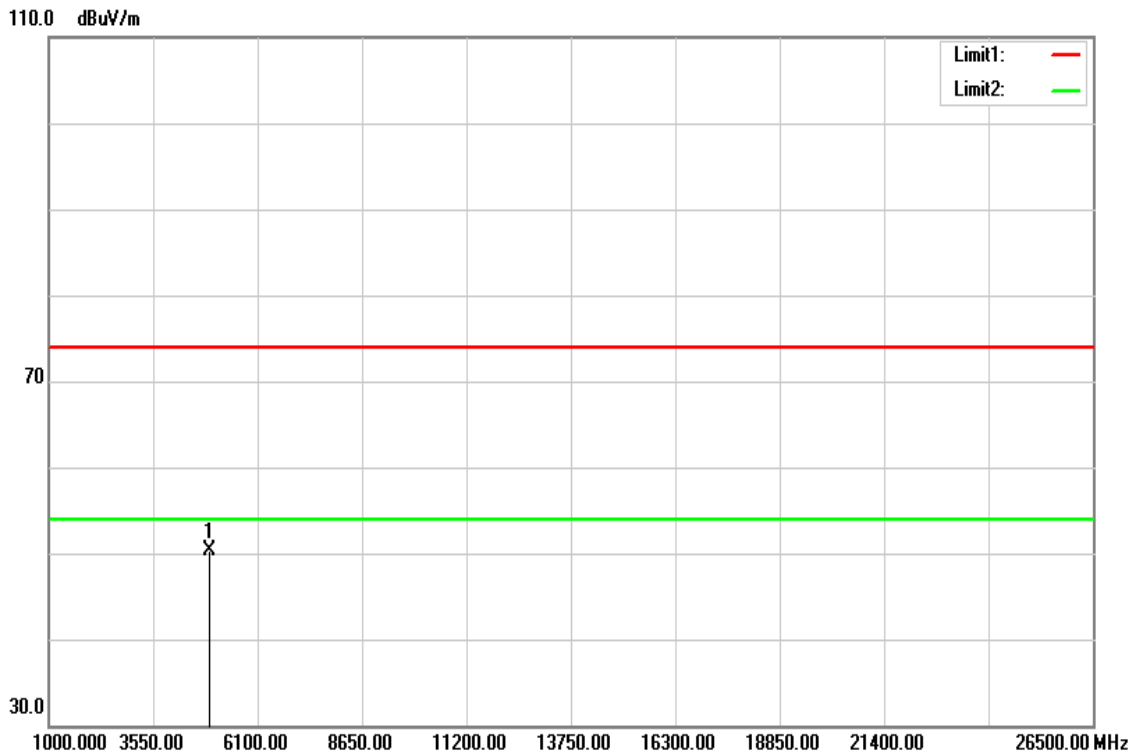

Frequency (MHz)	Reading (dBuV)	Correct Factor (dB/m)	Result (dBuV/m)	Limit (dBuV/m)	Margin (dB)	Remark
4925.000	46.36	3.90	50.26	74.00	-23.74	peak
N/A						

**Remark:**

1. Measuring frequencies from 1 GHz to the 10th harmonic of highest fundamental frequency.
2. For above 1GHz, the EUT peak value was under average limit, therefore the Average value compliance with the average limit



Test Mode	IEEE 802.11g High CH	Temp/Hum	22.1(°C)/ 50%RH
Test Item	Harmonic	Test Date	December 24, 2018
Polarize	Horizontal	Test Engineer	Jerry Chuang
Detector	Peak		

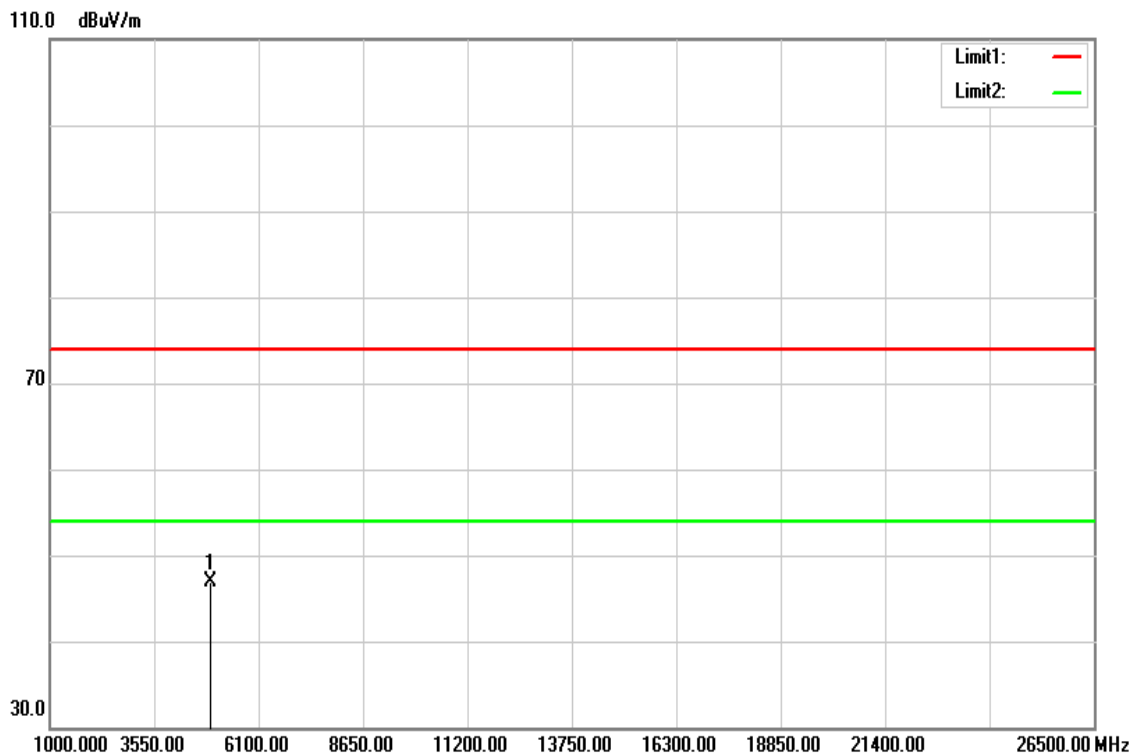

Frequency (MHz)	Reading (dBuV)	Correct Factor (dB/m)	Result (dBuV/m)	Limit (dBuV/m)	Margin (dB)	Remark
4925.000	42.97	3.90	46.87	74.00	-27.13	peak
N/A						

**Remark:**

1. Measuring frequencies from 1 GHz to the 10th harmonic of highest fundamental frequency.
2. For above 1GHz, the EUT peak value was under average limit, therefore the Average value compliance with the average limit

Test Mode	IEEE 802.11n HT20 Low CH	Temp/Hum	22.1(°C)/ 50%RH
Test Item	Harmonic	Test Date	December 24, 2018
Polarize	Vertical	Test Engineer	Jerry Chuang
Detector	Peak		

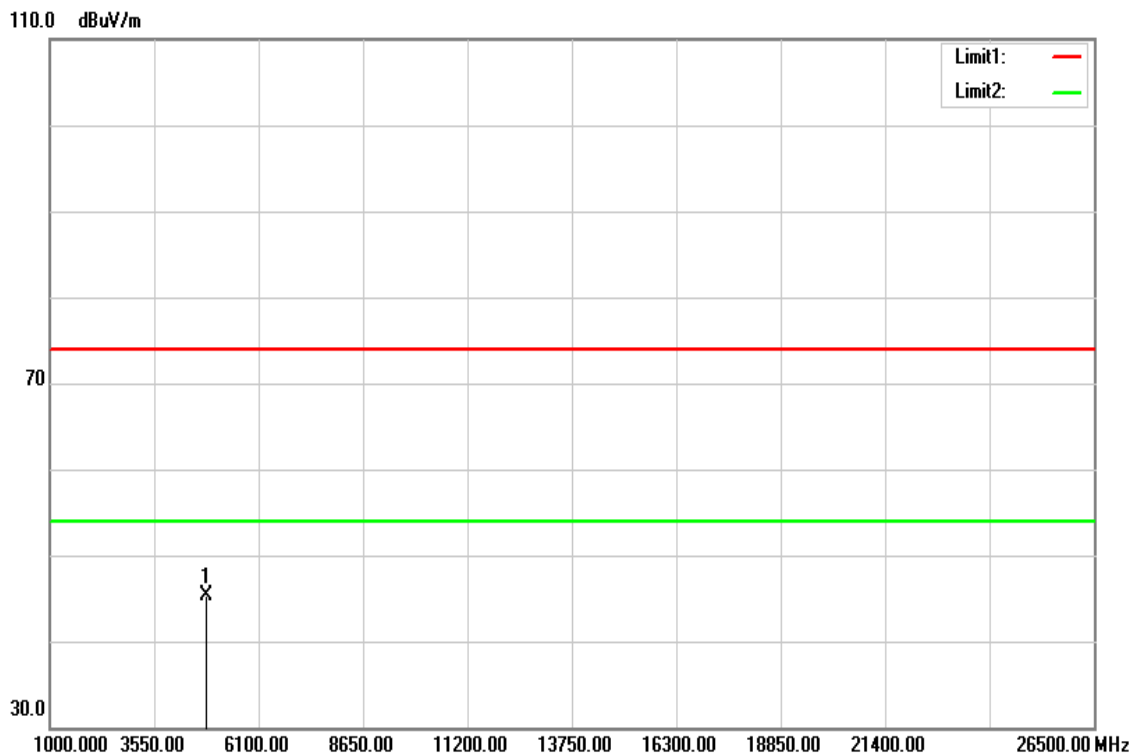

Frequency (MHz)	Reading (dBuV)	Correct Factor (dB/m)	Result (dBuV/m)	Limit (dBuV/m)	Margin (dB)	Remark
4813.000	42.07	3.15	45.22	74.00	-28.78	peak
N/A						

**Remark:**

1. Measuring frequencies from 1 GHz to the 10th harmonic of highest fundamental frequency.
2. For above 1GHz, the EUT peak value was under average limit, therefore the Average value compliance with the average limit

Test Mode	IEEE 802.11n HT20 Low CH	Temp/Hum	22.1(°C)/ 50%RH
Test Item	Harmonic	Test Date	December 24, 2018
Polarize	Horizontal	Test Engineer	Jerry Chuang
Detector	Peak		

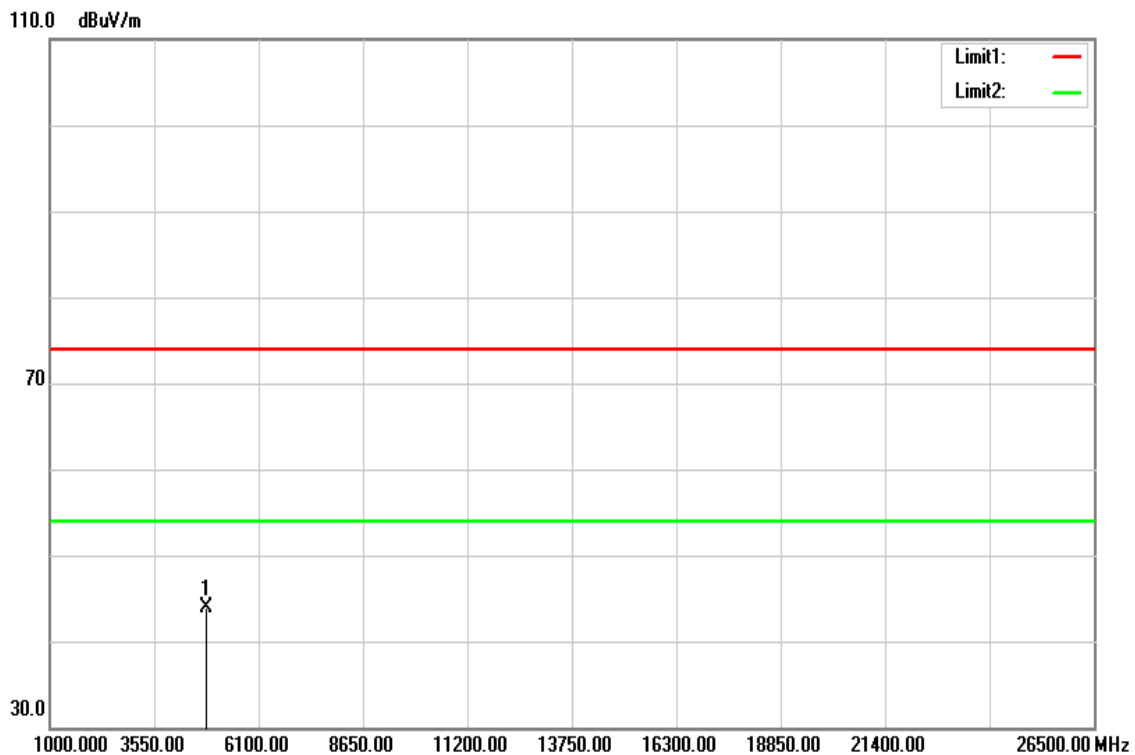

Frequency (MHz)	Reading (dBuV)	Correct Factor (dB/m)	Result (dBuV/m)	Limit (dBuV/m)	Margin (dB)	Remark
4827.000	40.65	3.25	43.90	74.00	-30.10	peak
N/A						

**Remark:**

1. Measuring frequencies from 1 GHz to the 10th harmonic of highest fundamental frequency.
2. For above 1GHz, the EUT peak value was under average limit, therefore the Average value compliance with the average limit

Test Mode	IEEE 802.11n HT20 Mid CH	Temp/Hum	22.1(°C)/ 50%RH
Test Item	Harmonic	Test Date	December 24, 2018
Polarize	Vertical	Test Engineer	Jerry Chuang
Detector	Peak		

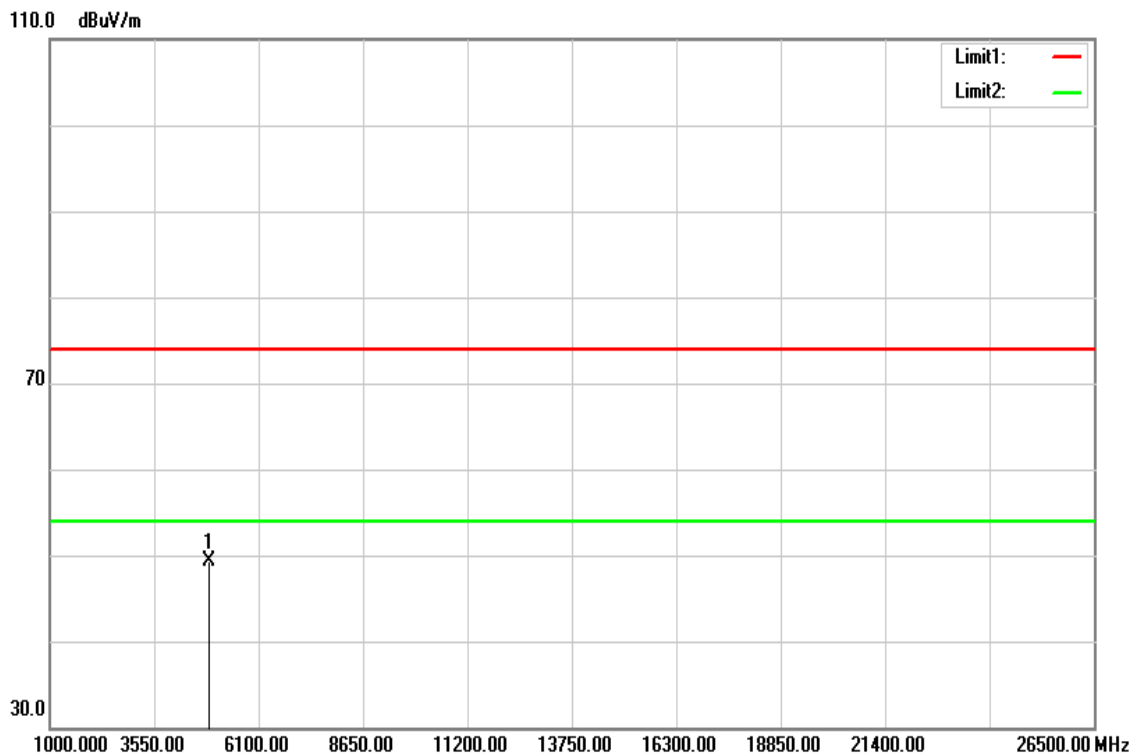

Frequency (MHz)	Reading (dBuV)	Correct Factor (dB/m)	Result (dBuV/m)	Limit (dBuV/m)	Margin (dB)	Remark
4876.000	45.83	3.57	49.40	74.00	-24.60	peak
N/A						

**Remark:**

1. Measuring frequencies from 1 GHz to the 10th harmonic of highest fundamental frequency.
2. For above 1GHz, the EUT peak value was under average limit, therefore the Average value compliance with the average limit

Test Mode	IEEE 802.11n HT20 Mid CH	Temp/Hum	22.1(°C)/ 50%RH
Test Item	Harmonic	Test Date	December 24, 2018
Polarize	Horizontal	Test Engineer	Jerry Chuang
Detector	Peak		

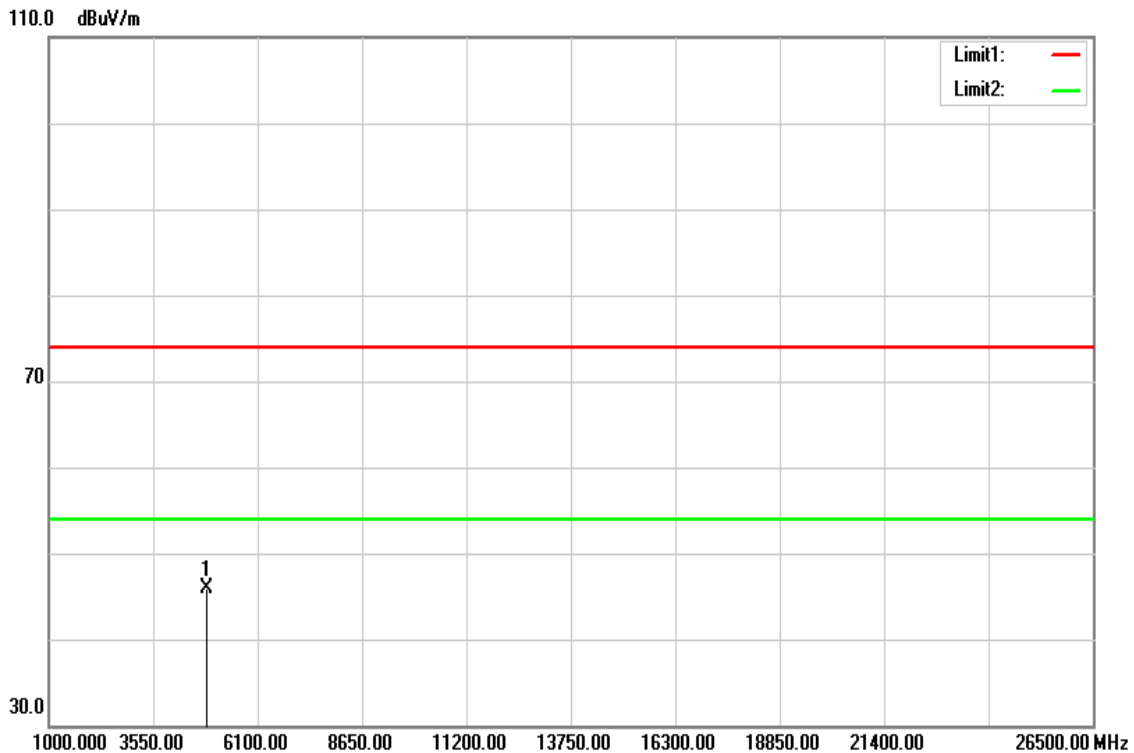

Frequency (MHz)	Reading (dBuV)	Correct Factor (dB/m)	Result (dBuV/m)	Limit (dBuV/m)	Margin (dB)	Remark
4869.000	42.38	3.53	45.91	74.00	-28.09	peak
N/A						

**Remark:**

1. Measuring frequencies from 1 GHz to the 10th harmonic of highest fundamental frequency.
2. For above 1GHz, the EUT peak value was under average limit, therefore the Average value compliance with the average limit

Test Mode	IEEE 802.11n HT20 High CH	Temp/Hum	22.1(°C)/ 50%RH
Test Item	Harmonic	Test Date	December 24, 2018
Polarize	Vertical	Test Engineer	Jerry Chuang
Detector	Peak		

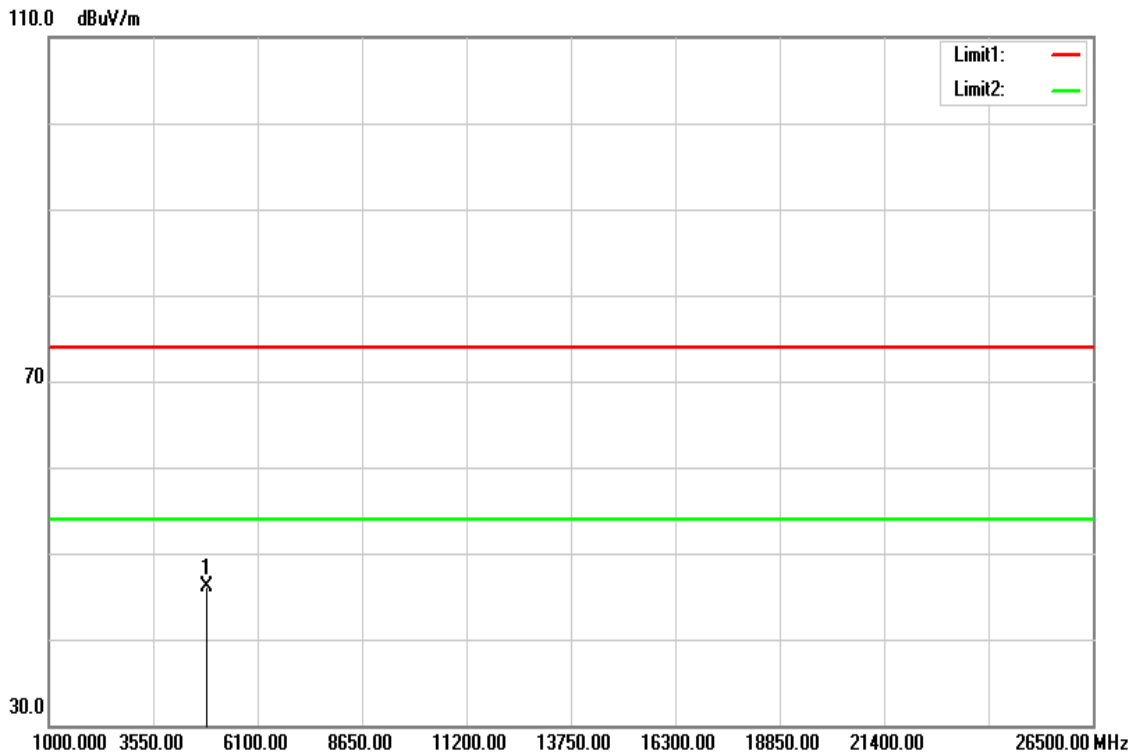

Frequency (MHz)	Reading (dBuV)	Correct Factor (dB/m)	Result (dBuV/m)	Limit (dBuV/m)	Margin (dB)	Remark
4869.000	42.64	3.53	46.17	74.00	-27.83	peak
N/A						

**Remark:**

1. Measuring frequencies from 1 GHz to the 10th harmonic of highest fundamental frequency.
2. For above 1GHz, the EUT peak value was under average limit, therefore the Average value compliance with the average limit

Test Mode	IEEE 802.11n HT20 High CH	Temp/Hum	22.1(°C)/ 50%RH
Test Item	Harmonic	Test Date	December 24, 2018
Polarize	Horizontal	Test Engineer	Jerry Chuang
Detector	Peak		

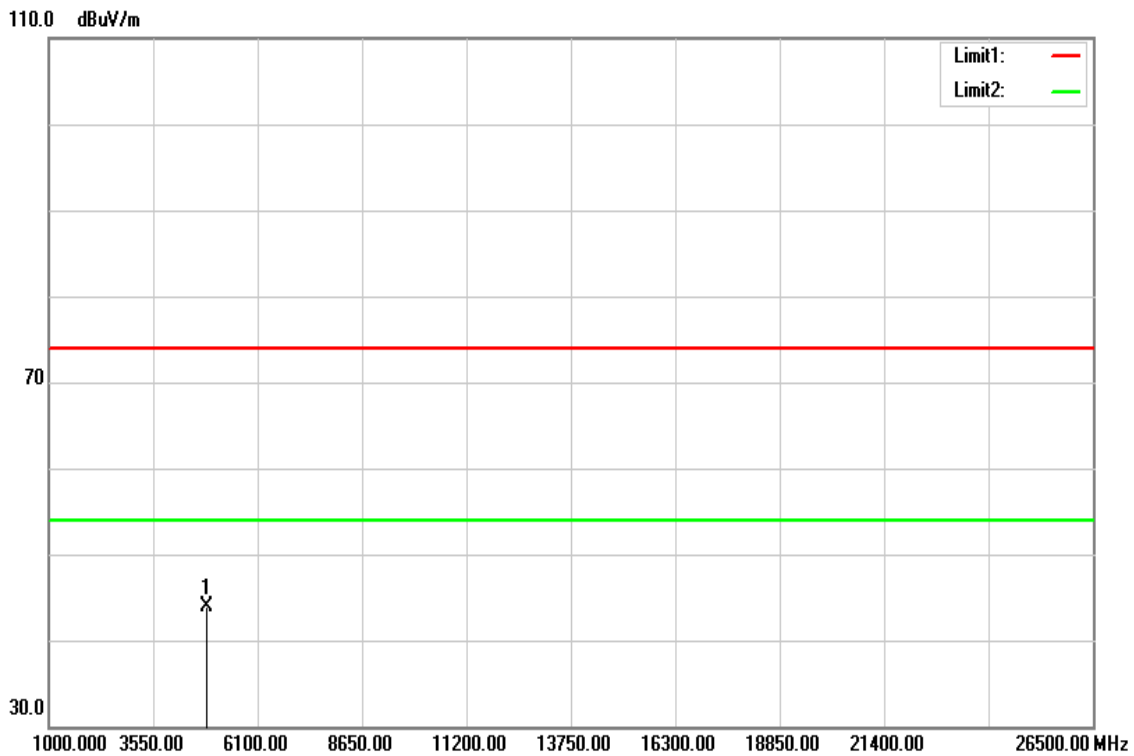

Frequency (MHz)	Reading (dBuV)	Correct Factor (dB/m)	Result (dBuV/m)	Limit (dBuV/m)	Margin (dB)	Remark
4869.000	40.45	3.53	43.98	74.00	-30.02	peak
N/A						

**Remark:**

1. Measuring frequencies from 1 GHz to the 10th harmonic of highest fundamental frequency.
2. For above 1GHz, the EUT peak value was under average limit, therefore the Average value compliance with the average limit

Test Mode	IEEE 802.11n HT40 Low CH	Temp/Hum	22.1(°C)/ 50%RH
Test Item	Harmonic	Test Date	December 24, 2018
Polarize	Vertical	Test Engineer	Jerry Chuang
Detector	Peak		

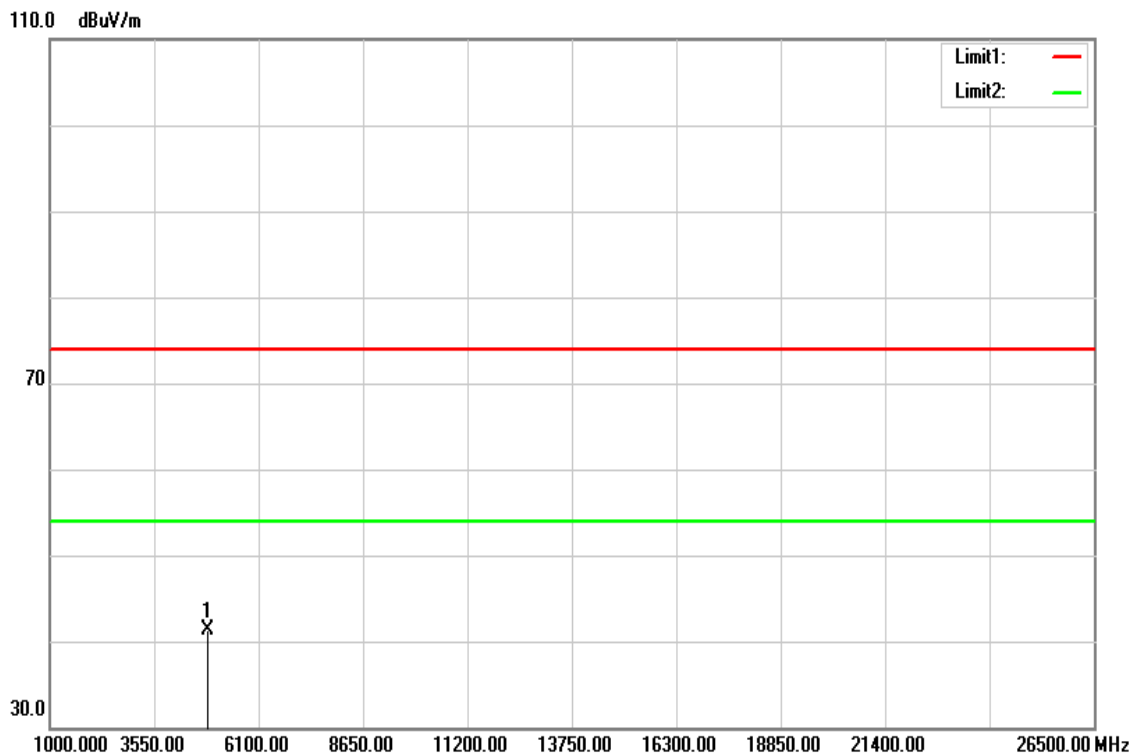

Frequency (MHz)	Reading (dBuV)	Correct Factor (dB/m)	Result (dBuV/m)	Limit (dBuV/m)	Margin (dB)	Remark
4844.000	37.99	3.36	41.35	74.00	-32.65	peak
N/A						

**Remark:**

1. Measuring frequencies from 1 GHz to the 10th harmonic of highest fundamental frequency.
2. For above 1GHz, the EUT peak value was under average limit, therefore the Average value compliance with the average limit



Test Mode	IEEE 802.11n HT40 Low CH	Temp/Hum	22.1(°C)/ 50%RH
Test Item	Harmonic	Test Date	December 24, 2018
Polarize	Horizontal	Test Engineer	Jerry Chuang
Detector	Peak		

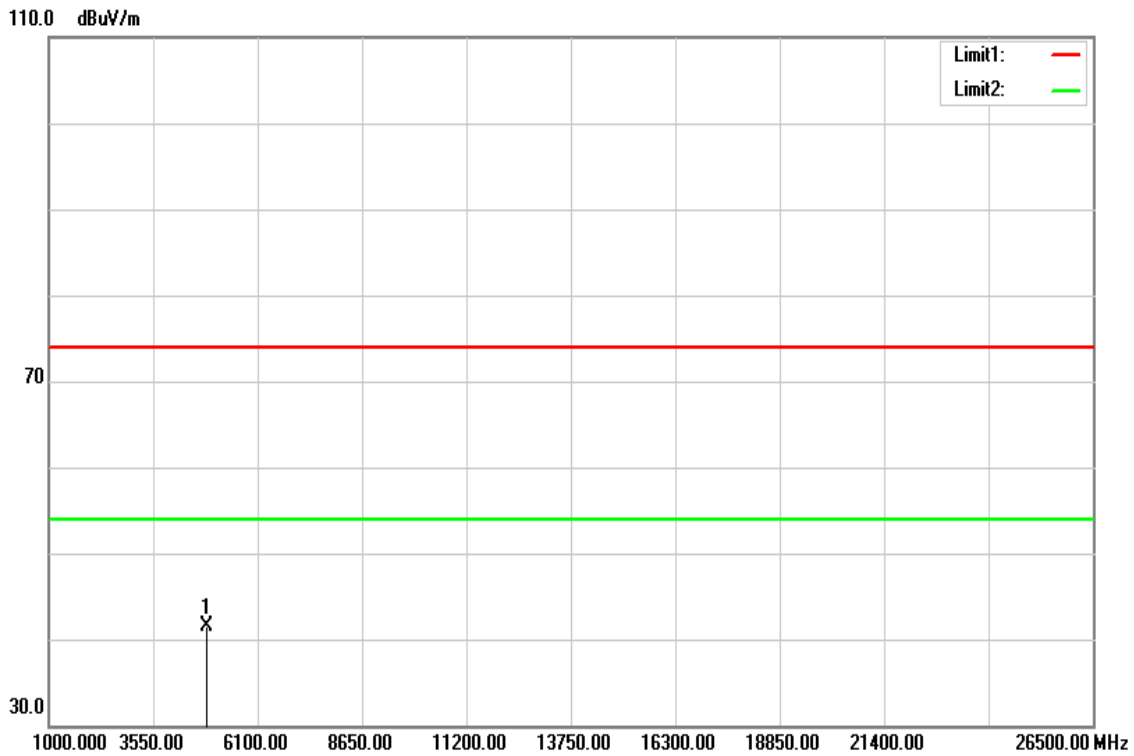

Frequency (MHz)	Reading (dBuV)	Correct Factor (dB/m)	Result (dBuV/m)	Limit (dBuV/m)	Margin (dB)	Remark
4844.000	38.20	3.36	41.56	74.00	-32.44	peak
N/A						

**Remark:**

1. Measuring frequencies from 1 GHz to the 10th harmonic of highest fundamental frequency.
2. For above 1GHz, the EUT peak value was under average limit, therefore the Average value compliance with the average limit

Test Mode	IEEE 802.11n HT40 Mid CH	Temp/Hum	22.1(°C)/ 50%RH
Test Item	Harmonic	Test Date	December 24, 2018
Polarize	Vertical	Test Engineer	Jerry Chuang
Detector	Peak		

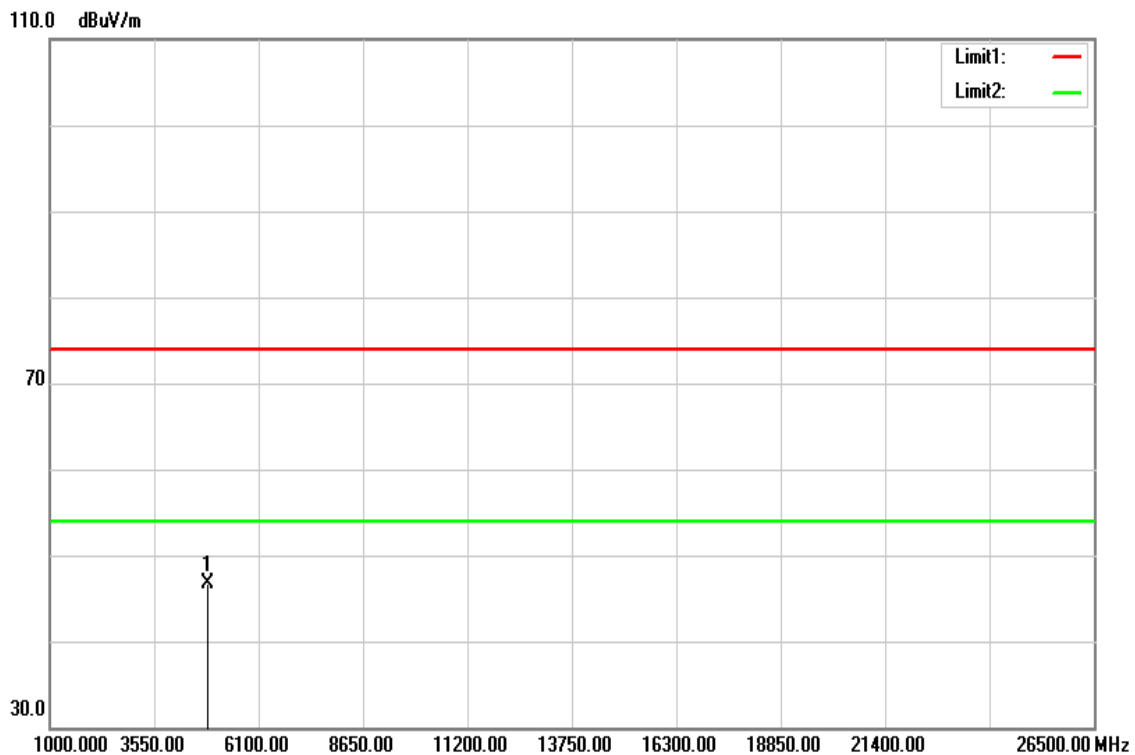

Frequency (MHz)	Reading (dBuV)	Correct Factor (dB/m)	Result (dBuV/m)	Limit (dBuV/m)	Margin (dB)	Remark
4869.000	43.18	3.53	46.71	74.00	-27.29	peak
N/A						

**Remark:**

1. Measuring frequencies from 1 GHz to the 10th harmonic of highest fundamental frequency.
2. For above 1GHz, the EUT peak value was under average limit, therefore the Average value compliance with the average limit

Test Mode	IEEE 802.11n HT40 Mid CH	Temp/Hum	22.1(°C)/ 50%RH
Test Item	Harmonic	Test Date	December 24, 2018
Polarize	Horizontal	Test Engineer	Jerry Chuang
Detector	Peak		

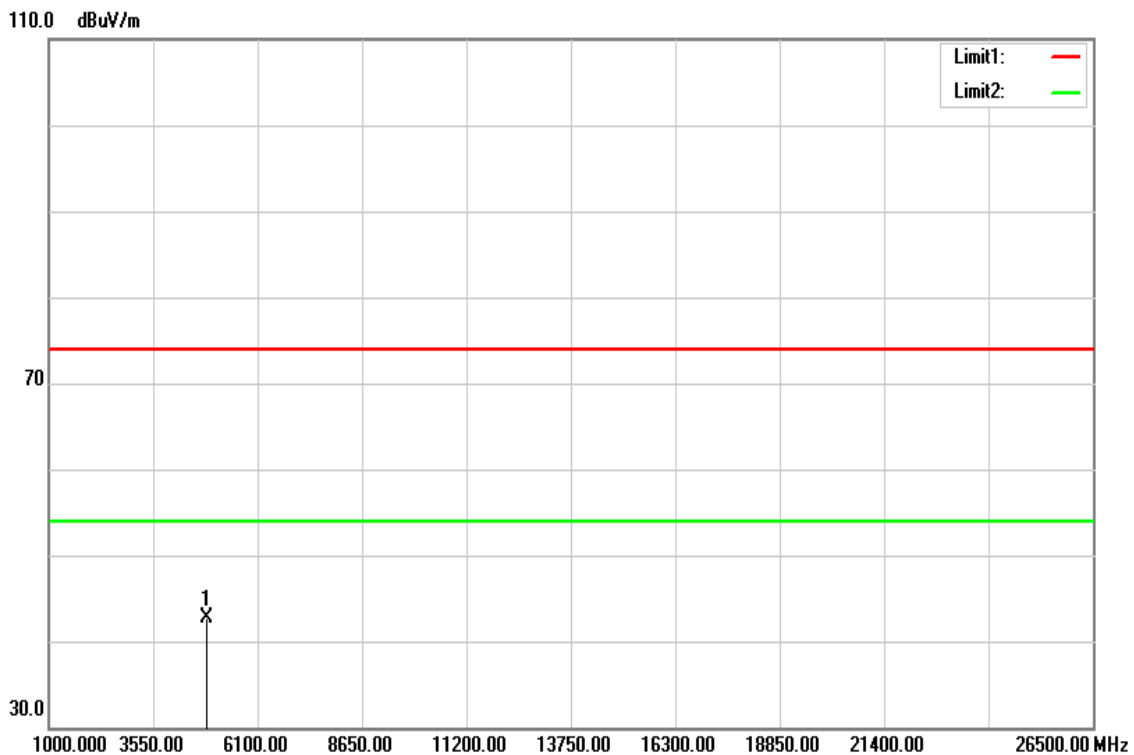

Frequency (MHz)	Reading (dBuV)	Correct Factor (dB/m)	Result (dBuV/m)	Limit (dBuV/m)	Margin (dB)	Remark
4874.000	39.06	3.56	42.62	74.00	-31.38	peak
N/A						

**Remark:**

1. Measuring frequencies from 1 GHz to the 10th harmonic of highest fundamental frequency.
2. For above 1GHz, the EUT peak value was under average limit, therefore the Average value compliance with the average limit

Test Mode	IEEE 802.11n HT40 High CH	Temp/Hum	22.1(°C)/ 50%RH
Test Item	Harmonic	Test Date	December 24, 2018
Polarize	Vertical	Test Engineer	Jerry Chuang
Detector	Peak		

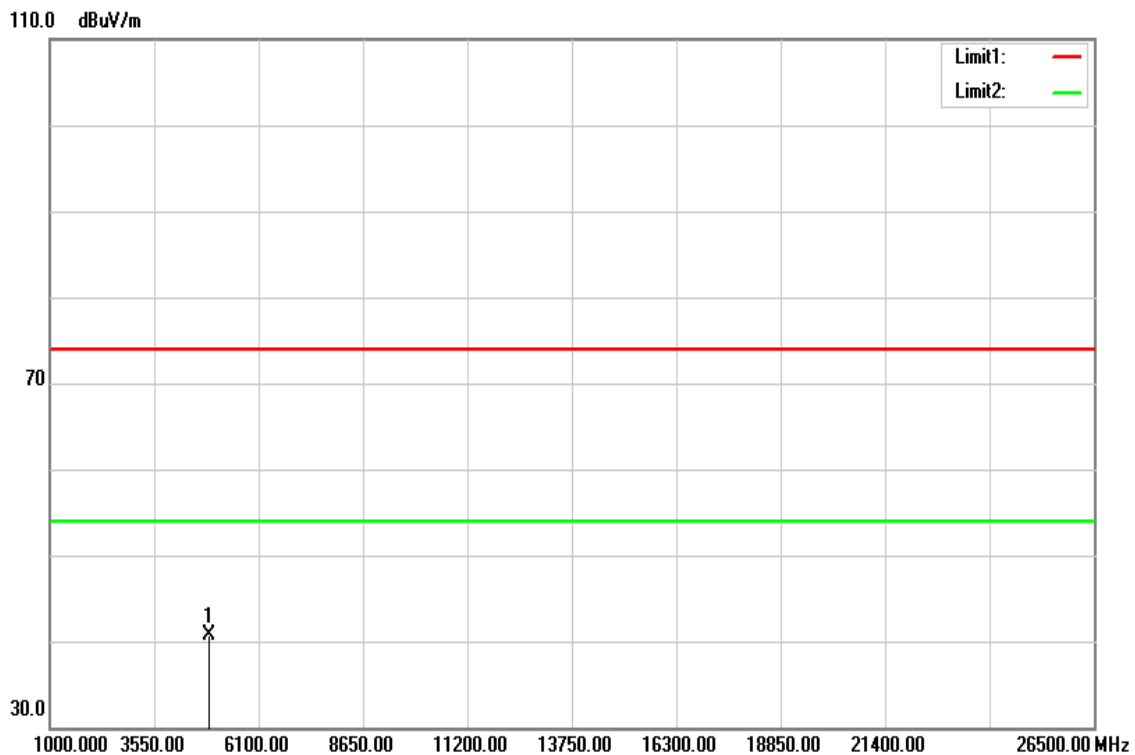

Frequency (MHz)	Reading (dBuV)	Correct Factor (dB/m)	Result (dBuV/m)	Limit (dBuV/m)	Margin (dB)	Remark
4904.000	36.88	3.75	40.63	74.00	-33.37	peak
N/A						

**Remark:**

1. Measuring frequencies from 1 GHz to the 10th harmonic of highest fundamental frequency.
2. For above 1GHz, the EUT peak value was under average limit, therefore the Average value compliance with the average limit

Test Mode	IEEE 802.11n HT40 High CH	Temp/Hum	22.1(°C)/ 50%RH
Test Item	Harmonic	Test Date	December 24, 2018
Polarize	Horizontal	Test Engineer	Jerry Chuang
Detector	Peak		

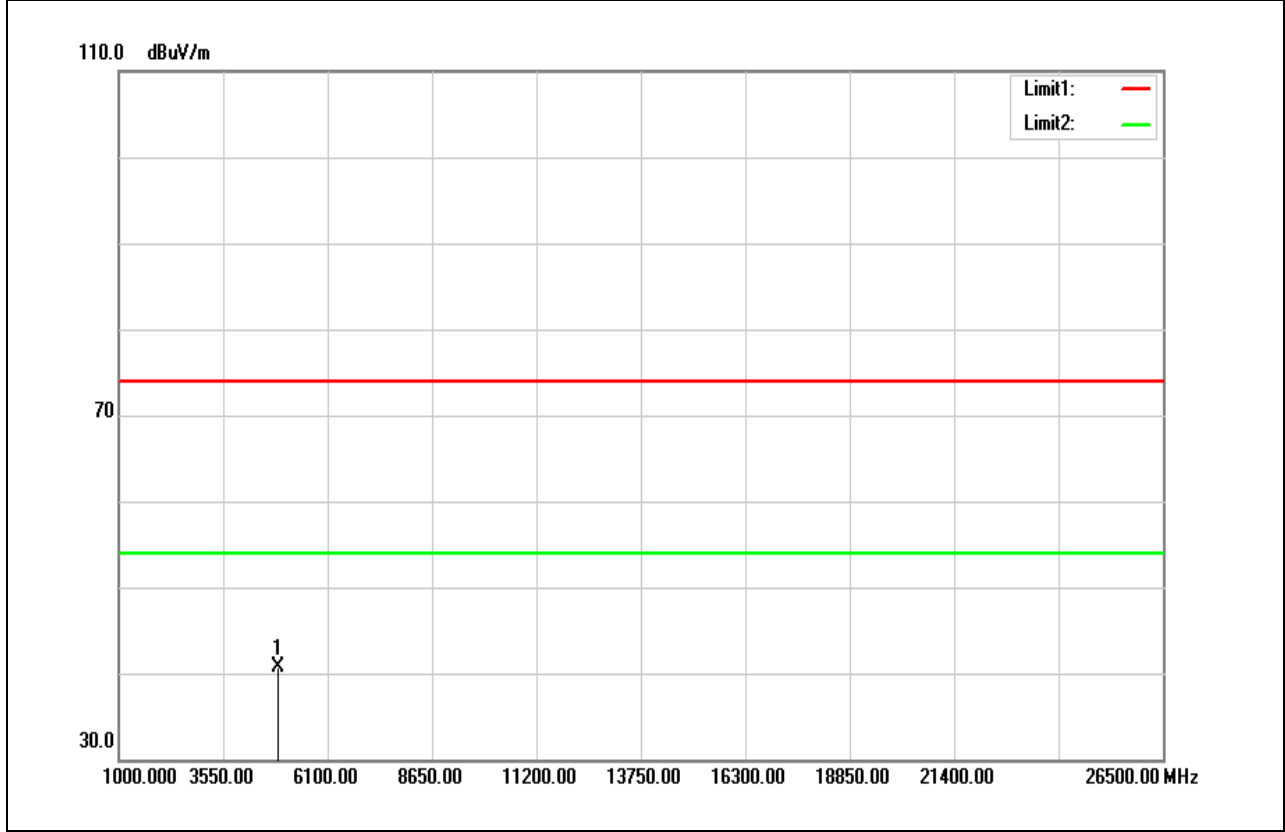

Frequency (MHz)	Reading (dBuV)	Correct Factor (dB/m)	Result (dBuV/m)	Limit (dBuV/m)	Margin (dB)	Remark
4904.000	36.90	3.75	40.65	74.00	-33.35	peak
N/A						

**Remark:**

1. Measuring frequencies from 1 GHz to the 10th harmonic of highest fundamental frequency.
2. For above 1GHz, the EUT peak value was under average limit, therefore the Average value compliance with the average limit

**--End of Report--**