

PATENT PENDING

2nd floor, Building 12, Xicheng Industrial Area, Xixiang Town,
Baoan District, Shenzhen Guangdong China. 518101

E-mail: nancy@xviveaudio.com

www.xviveaudio.com



MADE IN CHINA

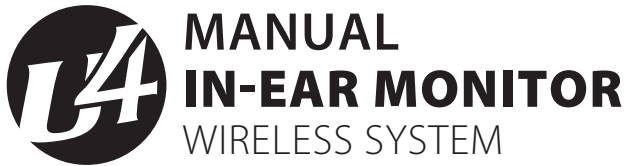



CAUTION
RISK OF ELECTRIC SHOCK
DO NOT OPEN



WARNING : TO REDUCE THE RISK OF FIRE OR ELECTRIC SHOCK: DO NOT REMOVE SCREWS.
NO USER-SERVICEABLE PARTS INSIDE.
REFER SERVICING TO QUALIFIED SERVICE PERSONNEL.

WARNING : TO REDUCE THE RISK OF FIRE OR ELECTRIC SHOCK, DO NOT EXPOSE THE APPLIANCE TO RAIN OR MOISTURE.

CERTIFICATION



Radio Approvals: FCC Part 15.249, FCC Part 15 B, RSS-210 (Canada), EN 300 440 (Europe), EN 301.489 (Europe), MIC Notice No.88 Appendix No.43(Japan)

This Class B digital apparatus complies with Canadian ICES-003.

IC Caution:

This device contains licence-exempt transmitter(s)/receiver(s) that comply with Innovation, Science and Economic Development Canada's licence-exempt RSS(s). Operation is subject to the following two conditions:

1. This device may not cause interference.
2. This device must accept any interference, including interference that may cause undesired operation of the device.

L'émetteur/récepteur exempt de licence contenu dans le présent appareil est conforme aux CNR d'Innovation, Sciences et Développement économique Canada applicables aux appareils radio exempts de licence. L'exploitation est autorisée aux deux conditions suivantes :

1. L'appareil ne doit pas produire de brouillage;
2. L'appareil doit accepter tout brouillage radioélectrique subi, même si le brouillage est susceptible d'en compromettre le fonctionnement.

FCC CERTIFICATION

THIS DEVICE COMPLIES WITH PART 15 OF THE FCC RULES. OPERATION IS SUBJECT TO THE FOLLOWING TWO CONDITIONS: (1) THIS DEVICE MAY NOT CAUSE HARMFUL INTERFERENCE, AND (2) THIS DEVICE MUST ACCEPT ANY INTERFERENCE RECEIVED, INCLUDING INTERFERENCE THAT MAY CAUSE UNDESIRE OPERATION.

WARNING:

Changes or modifications not expressly approved in writing by Xvive may void the users authority to operate this equipment.

RF EXPOSURE STATEMENT:

This transmitter must not be co-located or operated in conjunction with any other antenna or transmitter.

NOTE:

This equipment has been tested and found to comply with the limits for a Class B digital device, pursuant to part 15 of the FCC Rules. These limits are designed to provide

reasonable protection against harmful interference in a residential installation. This equipment generates, uses and can radiate radio frequency energy and, if not installed and used in accordance with the instructions, may cause harmful interference to radio communications. There is no guarantee that interference will not occur in a particular installation. If this equipment does cause harmful interference to radio or television reception, which can be determined by turning the equipment off and on, the user is encouraged to try to correct the interference by one or more of the following

MEASURES:

- Reorient or relocate the receiving antenna.
- Increase the separation between the equipment and receiver.
- Connect the equipment into an outlet on a circuit different from that to which the receiver is connected.
- Consult the dealer or an experienced radio/TV technician for help.

IMPORTANT SAFETY INSTRUCTIONS
PLEASE READ THESE INSTRUCTIONS IN A SAFE PLACE



**WARNING: BEFORE USING YOUR XVIVE U4 MICROPHONE WIRELESS SYSTEM,
CAREFULLY READ THE OPERATING INSTRUCTIONS.**

1. Observe all instructions carefully in the U4 set manual.
2. Do not to perform service operations beyond those described in the U4 set manual. Services required when the apparatus has been damaged in any way, such as:
 - Liquid has been spilled or objects have fallen into the apparatus
 - The unit has been exposed to rain or moisture
 - The unit does not operate normally or changes in performance in a significant way
 - The unit is dropped or the enclosure is damaged
3. Do not place near heat sources, such as radiators, heat registers, or appliances which produce heat.
4. Guard against objects or liquids entering the device. Do not use or place unit near water.
5. Clean only with a dry cloth.
6. Only use attachments/accessories specified by the manufacturer.
7. Prolonged listening at high volume levels may cause irreparable hearing loss and/or damage. Always be sure to practice "safe listening."



WARNING

LISTENING TO AUDIO AT EXCESSIVE VOLUMES CAN CAUSE PERMANENT HEARING DAMAGE. USE AS LOW A VOLUME AS POSSIBLE.

Over exposure to excessive sound levels can damage your ears resulting in permanent noise-induced hearing loss. Do not use earphones for a long time and set the volume below 70% or lower.

PACKAGE DETAILS

U4 Transmitter	1PCS
U4 Receiver	1PCS
USB Cable	1PCS
XLR Male to 1/4" TS Male Adapter	1PCS
Manual	1PCS
Bag	1PCS

U4 SET PRODUCT INTRODUCTION

U4 person wireless monitoring system provides better sound feedback for stage performers and performance quality. As a portable wireless system, you don't need to set up. Just plug-and-play to quickly build your monitoring system.

FEATURES:

- 2.4Ghz wireless In-ear monitor system
- Create your personal or team's monitor system
- Send audio wirelessly to performers onstage
- 90 feet range
- Support XLR or TS input
- Provides clear, detailed audio at any volume
- Plug and Play, focus on the performance
- All-metal Receiver
- Slim, lightweight bodypack attaches easily to a belt or guitar strap
- Less than 5ms Latency, Simultaneous broadcasts on 6 channels.
- 5 Hours of battery life (rechargeable battery for both Transmitter & Receiver)

BASIC OPERATION

U4 TRANSMITTER

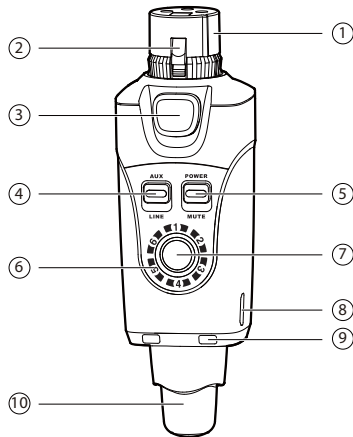

- ① Input: XLR balanced input jack
- ② Spring: Circumferential ground spring providing an accurate connection to the mating shell
- ③ Lock: secures transmitter
- ④ Aux/Line mode: Connect to Aux or line out
- ⑤ Power switch: switches unit on/off
- ⑥ Channel status LED: indicates selected channel
- ⑦ Channel switch: selects Channels 1-6
- ⑧ USB charging port
- ⑨ Power status LED: indicates power status:
 - Led off = 100% ~ 30%
 - Solid red = 29% ~ 11%
 - Flickering red = less than 10%
- ⑩ Antenna.

BASIC OPERATION

U4 RECEIVER

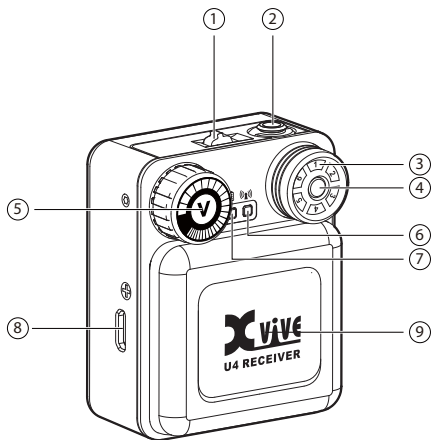

- ① Power switch: switches unit on/off
- ② Headphone Output: 3.5mm output
Connect to earphones or headphones
- ③ Channel status LED: indicates selected channel
- ④ Channel switch: selects Channels 1-6
- ⑤ Volume control: Adjust the volume of headphone output
- ⑥ RF Status LED:
ON = Transmitter is on and link is established
Flashing = Signal connection interference
OFF = Transmitter off or unlinked
- ⑦ Power status LED: indicates power status:
Led off = 100% ~ 30%
Solid red = 29% ~ 11%
Flickering red = less than 10%
- ⑧ USB charging port
- ⑨ Antenna.

QUICK START

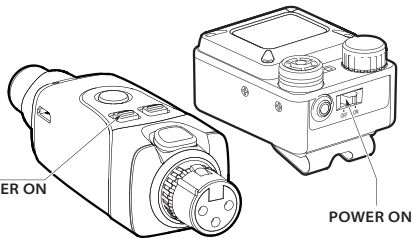

POWER ON

POWER ON

POWER ON

Start the power switch, the channel indicator will light up.

BATTERIES AND CHARGING

U4 provides USB charging cable, you can connect to USB Charger Adapter or other USB charging devices

Note: Turn off the power switch while charging. Please do not use U4 when charging, which may reduce battery life.

Connect to the socket



- * Always store U4 at room temperature
- * When storing the unit, please check the battery state regularly and charge if necessary.

CHARGING TIMES	BATTERY LIFE
0:15	30 min
0:30	1 hours
1:00	2 hours
2:30	5 hours

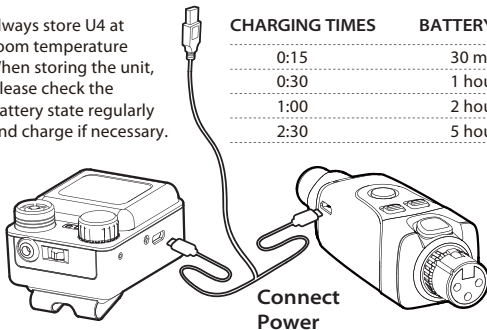

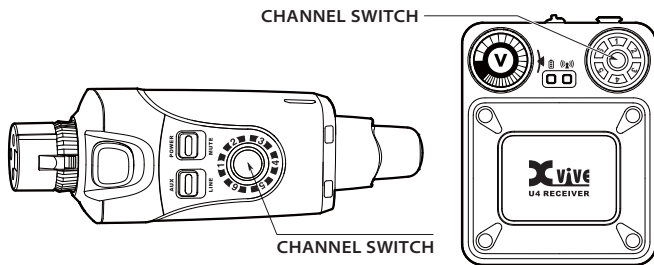

PAIR TRANSMITTER AND RECEIVER

U4 has six channels. Use the channel switch button to switch the channel. Set the Receiver channel same with Transmitter. The blue Led signal on the receiver will always be on when the connection is successful.

SINGLE TRANSMITTER AND MULTIPLE RECEIVERS

If you want to add more receiver, just set the receivers to the same channel as the transmitter.

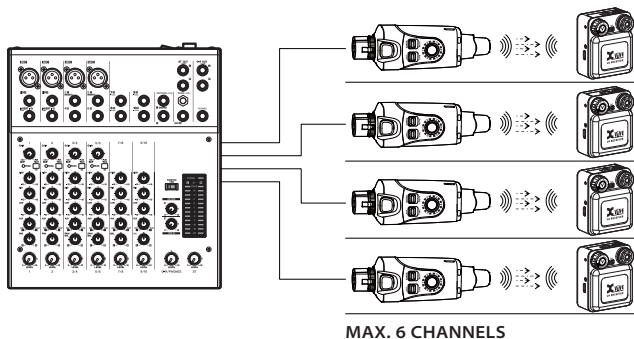

QUICK START

VOLUME ADJUSTING

LISTENING TO AUDIO AT EXCESSIVE VOLUMES CAN CAUSE PERMANENT HEARING DAMAGE. USE AS LOW A VOLUME AS POSSIBLE.

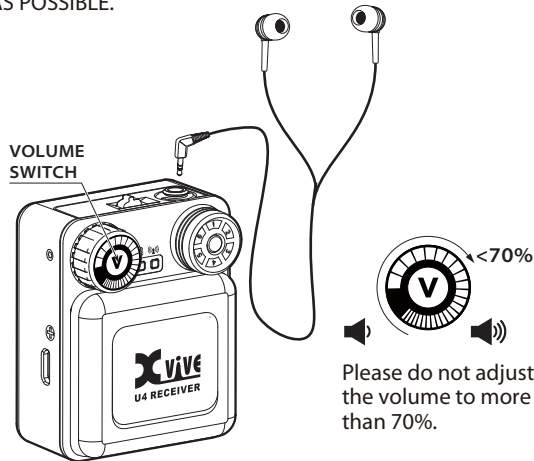

ADJUST TRANSMITTER LEVELS

Adjusting Gain and Listening Volume
For the best audio quality, start by adjusting the levels from the mixer or audio source and maximizes the signal-to-noise ratio.

Line (+4 dBu)	Use with mixers or other professional audio devices that send line-level signals.
Aux (-10 dBV)	Use when connecting consumer audio devices such as portable audio players or computers.

OPERATION

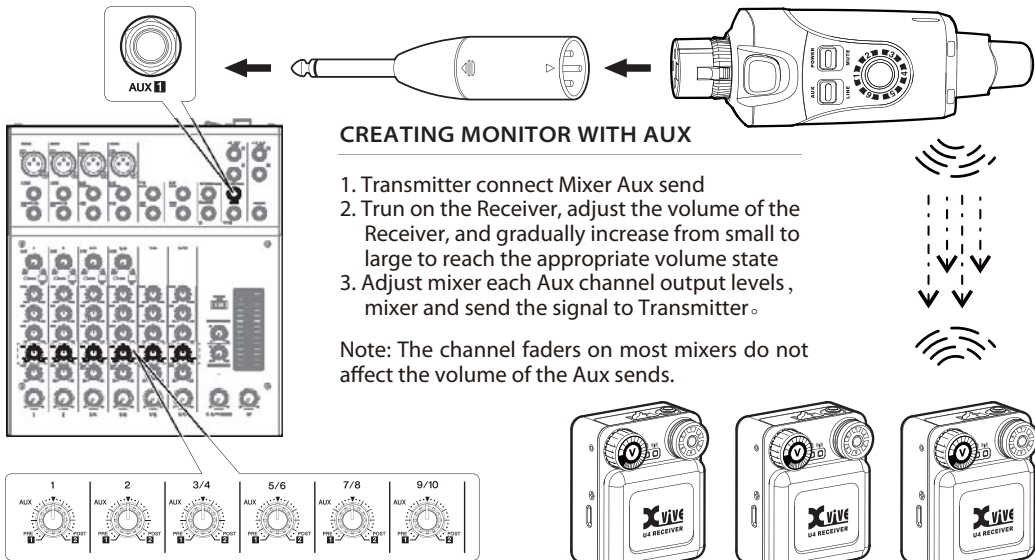

OPERATION

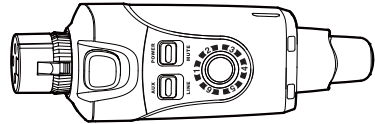
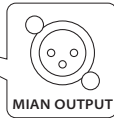
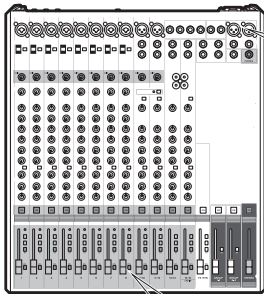

CREATING MONITOR WITH XLR

1. Transmitter connect Mixer output or other XLR output
2. Trun on the Receiver, adjust the volume of the Receiver, and gradually increase from small to large to reach the appropriate volume state
- 3 Adjust mixer each channel faders output levels, mixer and send the signal to Transmitter.

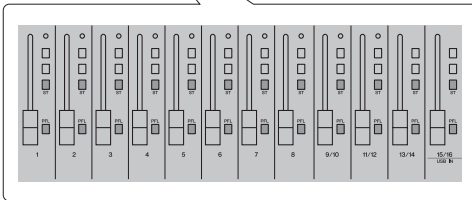
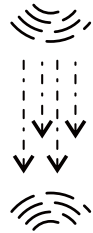

OPERATION

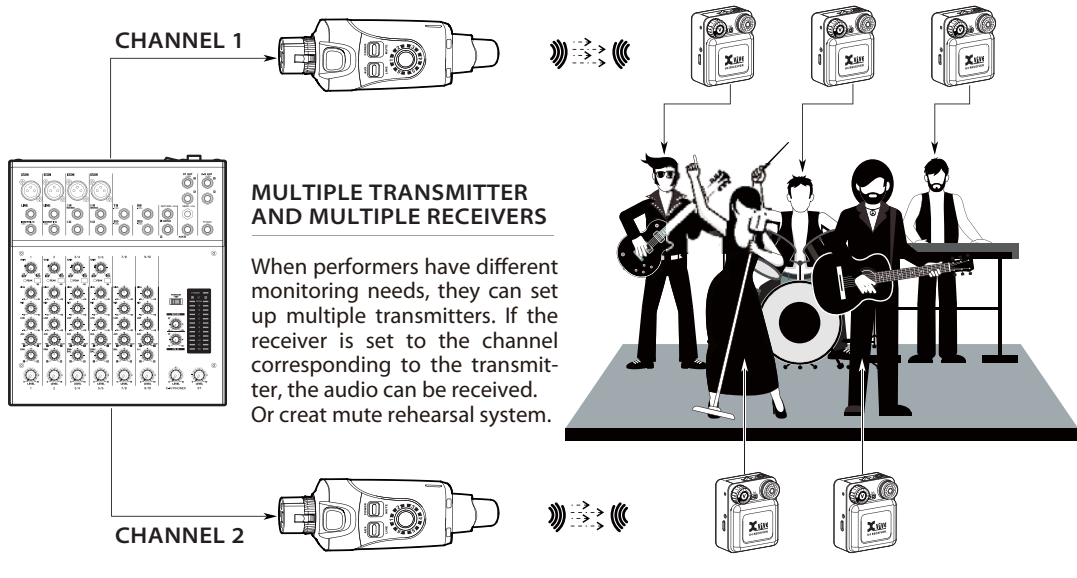

2.4 GHz SPECTRUM OVERVIEW AND INTERFERENCE

U4 operates within the 2.4GHz ISM band which is utilized by Wi-Fi, Bluetooth, and other wireless devices. 2.4GHz is an open band and, as such, does not require a license to be used worldwide.

Tips and Methods to Improve Wireless System Performance

- 1) Keep more than 3 meters distance between Receiver unit and other WiFi transmitters such as routers.
- 2) Change channels to avoid interference with other WiFi products.
- 3) In case of environmental interference from other WiFi systems, shorten the distance between the receiver and transmitter units.

2.4Ghz Frequency Tables

CHANNEL 1	2402MHz, 2480MHz, 2482MHz
CHANNEL 2	2408MHz, 2472MHz, 2474MHz
CHANNEL 3	2416MHz, 2464MHz, 2466MHz
CHANNEL 4	2434MHz, 2440MHz, 2442MHz
CHANNEL 5	2427MHz, 2448MHz, 2450MHz
CHANNEL 6	2422MHz, 2456MHz, 2458MHz

* U2 1~4 channels are the same as U3/U3C/U4 1~4 channels, U2, U3/U3C and U4 use in sametime max is 6 sets.

TROUBLESHOOTING

ISSUE	SOLUTION
No Sound	<ul style="list-style-type: none">• Check that the U4 Receiver's RF LED is lit.• Check whether the device has a signal sent to the transmitter• Check that the power switch is turned on for both the Transmitter and the Receiver.• Ensure that the U4 Transmitter and Receiver are on the same channel.• The Receiver can be paired with one Transmitter at a time
Distorted Audio	<ul style="list-style-type: none">• Check the Line/Aux setting at the transmitter and verify that the meter is not reaching the overload• Check Levels going in and out of the mixer. Verify that no distortion occurs in each audio signal.
Low audio output at the receiver	<ul style="list-style-type: none">• Check receiver headphone output Volume level• Check Transmitter mode Line/Aux.• Check whether the device has enough signals level to the transmitter.
Signal instability: RF LED flickering	<ul style="list-style-type: none">• See, "Tips and methods to improve wireless system performance page 13
Unable to switch the channel	<ul style="list-style-type: none">• The channel switch locks after 15 seconds. Double-click the channel button to unlock and reset.
Multiple connect	<ul style="list-style-type: none">• Use one transmitter can connect with more than 2 receivers.

SPECIFICATIONS

U4 WIRELESS IN-EAR MONITOR SYSTEM

Tuning Bandwidth	2400 – 2483.5MHz
Working Range	Up to 90ft Actual Range Depends On Rf Signal Absorption, Reflection And Interference.
Audio Frequency Response	20Hz – 20KHz(-3dB).
Dynamic Range	107dB
Battery Life	5 Hours of battery life
RF Sensitivity	-88dBm
Total Harmonic distortion	0.2%
RF Output Power	10 mW E.I.R.P. max
Operating Temperature Range	-18°C to 57°C. Battery Characteristics May Limit This Range.
Channel Count	Up To 6 Channels
Latency	Less than 5ms Latency

	U4 TRANSMITTER	U4 RECEIVER
Dimensions	30 X 28 X 100 mm	47 X 41 X 60 mm
Weight	90g	118g
Housing	Molded plastic and cast metal	Molded plastic and cast metal
Battery	3.7V Rechargeable Li-ion, 860mAh	3.7V Rechargeable Li-ion, 1200mAh
Impedance	Input 47k Ω (1KHz)	6-600 Ω
Audio input Connector	Balanced XLR Male input	
Audio output Connector		3.5mm stereo output
Mode	Aux mode: -10dBV Max. +12.2dBu Line mode: +4dBu Max. +22dBu	
Battery life	Up to 5 Hours	Up to 5 Hours
Antennal Impedance	50 Ω	50 Ω
ANTENNA Type	1/4 Wave Sleeve Dipole, Non-removable	1/4 Wave Sleeve Dipole, Non-removable
Number Of Antenna	1	2

U4 SERIES

U4 SET

1 Transmitter + 1 Receiver

U4 standard set to create personal Monitoring system

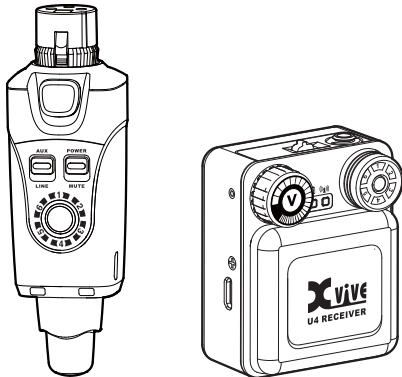

U4R2

1 Transmitter + 2 Receiver

U4R2 set to create small monitoring system
Or backup receiver

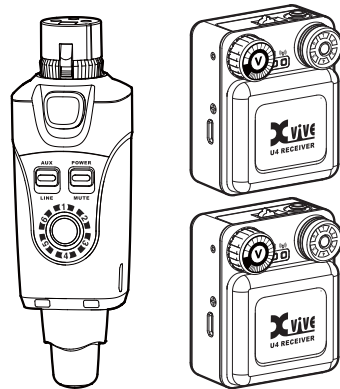

WIRELESS IN-EAR MONITOR SYSTEM

U4R4

1 Transmitter + 4 Receiver

U4R4 set to create performance monitoring system
Or mute rehearsal system

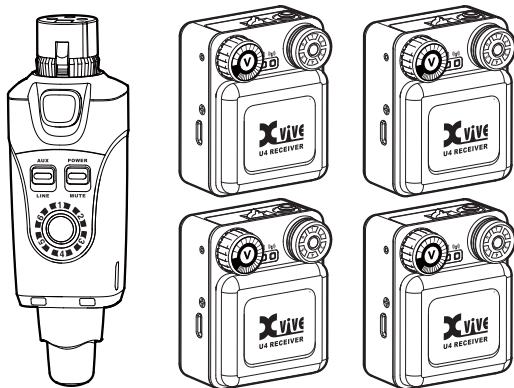

U4T

1 Transmitter

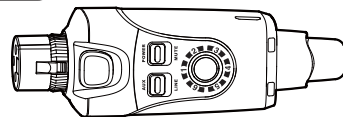

Transmitter only, you need to purchase
Additional receivers for use

U4R

1 RECEIVER

Receiver only, you need
To purchase additional
Transmitter for use

