



# FCC Test Report

**Test report  
On Behalf of  
SZ PGST CO., LTD  
For  
Alarm Host  
Model No.: PG-109**

**FCC ID: 2AIT9-PG-109**

**Prepared For :** **SZ PGST CO., LTD**  
**No.9 Building, Huafu Industrial Park, Huachang Road, Longhua District,  
Shenzhen, Guangdong, China**

**Prepared By :** **Shenzhen HUAK Testing Technology Co., Ltd.**  
**1-2/F., Building B2, Junfeng Zhongcheng Zhizao Innovation Park, Heping,  
Fuhai Street, Bao'an District, Shenzhen, Guangdong, China**

**Date of Test:** **Jun. 27, 2024 ~ Jul. 15, 2024**

**Date of Report:** **Jul. 15, 2024**

**Report Number:** **HK2406273462-1E**



### Test Result Certification

**Applicant's name** .....: SZ PGST CO., LTD  
**Address** .....: No.9 Building, Huafu Industrial Park, Huachang Road, Longhua District, Shenzhen, Guangdong, China

**Manufacturer's Name** .....: SZ PGST CO., LTD  
**Address** .....: No.9 Building, Huafu Industrial Park, Huachang Road, Longhua District, Shenzhen, Guangdong, China

#### Product description

**Trade Mark:** N/A  
**Product name**.....: Alarm Host  
**Model and/or type reference** : PG-109

**Standards** .....: FCC Rules and Regulations Part 15 Subpart C Section 15.247  
 ANSI C63.10: 2013

This publication may be reproduced in whole or in part for non-commercial purposes as long as the Shenzhen HUAK Testing Technology Co., Ltd. is acknowledged as copyright owner and source of the material. Shenzhen HUAK Testing Technology Co., Ltd. takes no responsibility for and will not assume liability for damages resulting from the reader's interpretation of the reproduced material due to its placement and context.

**Date of Test** .....:   
**Date (s) of performance of tests** .....: **Jun. 27, 2024 ~ Jul. 15, 2024**  
**Date of Issue**.....: **Jul. 15, 2024**  
**Test Result**.....: **Pass**

Testing Engineer : Len Liao  
 (Len Liao)

Technical Manager : Sliver Wan  
 (Sliver Wan)

Authorized Signatory : Jason Zhou  
 (Jason Zhou)

The results shown in this test report refer only to the sample(s) tested unless otherwise stated and the sample(s) are retained for 30 days only. The document is issued by HUAK, this document cannot be reproduced except in full with our prior written permission. The more details and the authenticity of the report will be confirmed at <http://www.cer-mark.com>.



## Table of Contents

- 1. Test Result Summary ..... 5**
  - 1.1. Test Procedures and Results ..... 5
  - 1.2. Information of the Test Laboratory ..... 5
  - 1.3. Measurement Uncertainty ..... 6
- 2. EUT Description ..... 7**
  - 2.1. General Description of EUT ..... 7
  - 2.2. Carrier Frequency of Channels ..... 8
  - 2.3. Operation of EUT During Testing ..... 8
  - 2.4. Description of Test Setup ..... 9
  - 2.5. Description of Support Units ..... 10
- 3. Genera Information ..... 11**
  - 3.1. Test Environment and Mode ..... 11
- 4. Test Results and Measurement Data ..... 14**
  - 4.1. Conducted Emission ..... 14
  - 4.2. Test Result ..... 16
  - 4.3. Maximum Conducted Output Power ..... 18
  - 4.4. Emission Bandwidth ..... 20
  - 4.5. Power Spectral Density ..... 26
  - 4.6. Conducted Band Edge and Spurious Emission Measurement ..... 33
  - 4.7. Radiated Spurious Emission Measurement ..... 43
  - 4.8. Antenna Requirement ..... 69
- 5. Photograph of Test ..... 70**
- 6. Photos of the EUT ..... 72**



**\*\* Modified History \*\***

<b>Revision</b>	<b>Description</b>	<b>Issued Data</b>	<b>Remark</b>
Revision 1.0	Initial Test Report Release	Jul. 15, 2024	Jason Zhou

The results shown in this test report refer only to the sample(s) tested unless otherwise stated and the sample(s) are retained for 30 days only. The document is issued by HUAK, this document cannot be reproduced except in full with our prior written permission. The more details and the authenticity of the report will be confirmed at <http://www.cer-mark.com>.

TEL : +86-755 2302 9901 FAX : +86-755 2302 9901 E-mail : [service@cer-mark.com](mailto:service@cer-mark.com)

Address: 1-2F., Building B2, Junfeng Zhongcheng Zhizao Innovation Park, Heping Community, Fuhai Street, Bao'an District, Shenzhen, Guangdong, China



# 1. Test Result Summary

## 1.1. Test Procedures and Results

Requirement	CFR 47 Section	Result
Antenna requirement	§15.203/§15.247(b)(4)	PASS
AC Power Line Conducted Emission	§15.207	PASS
Conducted Peak Output Power	§15.247(b)(3)	PASS
6dB Emission Bandwidth	§15.247(a)(2)	PASS
Power Spectral Density	§15.247(e)	PASS
Band Edge	§15.247(d)	PASS
Spurious Emission	§15.205/§15.209	PASS

**Note:**

1. PASS: Test item meets the requirement.
2. Fail: Test item does not meet the requirement.
3. N/A: Test case does not apply to the test object.
4. The test result judgment is decided by the limit of test standard.

## 1.2. Information of the Test Laboratory

Shenzhen HUAK Testing Technology Co., Ltd.  
 Add.: 1-2/F., Building B2, Junfeng Zhongcheng Zhizao Innovation Park, Heping, Fuhai Street, Bao'an District, Shenzhen, Guangdong, China

Testing Laboratory Authorization :

A2LA Accreditation Code is 4781.01.  
 FCC Designation Number is CN1229.  
 Canada IC CAB identifier is CN0045.  
 CNAS Registration Number is L9589.



### 1.3. Measurement Uncertainty

The reported uncertainty of measurement  $y \pm U$ , where expanded uncertainty  $U$  is based on a standard uncertainty multiplied by a coverage factor of  $k=2$ , providing a level of confidence of approximately 95 %.

No.	Item	MU
1	Conducted Emission	$\pm 2.71\text{dB}$
2	RF power, conducted	$\pm 0.37\text{dB}$
3	Spurious emissions, conducted	$\pm 0.11\text{dB}$
4	All emissions, radiated(<1G)	$\pm 3.90\text{dB}$
5	All emissions, radiated(>1G)	$\pm 4.28\text{dB}$
6	Temperature	$\pm 0.1^\circ\text{C}$
7	Humidity	$\pm 1.0\%$



## 2. EUT Description

### 2.1. General Description of EUT

Equipment:	Alarm Host
Model Name:	PG-109
Series Model:	N/A
Model Difference:	N/A
FCC ID:	2AIT9-PG-109
Antenna Type:	PCB Antenna
Antenna Gain:	1.37dBi
Operation frequency:	802.11b/g/n (HT20):2412~2462 MHz 802.11n (HT40): 2422~2452MHz
Number of Channels:	802.11b/g/n(HT20): 11CH 802.11n (HT40): 7CH
Modulation Type:	DSSS, OFDM
Power Source:	DC 5V From Adapter or DC 3.7V From Battery
Power Rating:	DC 5V From Adapter or DC 3.7V From Battery

**Note:**

1. For a more detailed features description, please refer to the manufacturer's specifications or the User's Manual.
2. Antenna gain Refer to the antenna specifications.
3. The cable loss data is obtained from the supplier.
4. The test results in the report only apply to the tested sample.



### 2.2. Carrier Frequency of Channels

Channel List For 802.11b/802.11g/802.11n (HT20)							
Channel	Frequency (MHz)	Channel	Frequency (MHz)	Channel	Frequency (MHz)	Channel	Frequency (MHz)
01	2412	04	2427	07	2442	10	2457
02	2417	05	2432	08	2447	11	2462
03	2422	06	2437	09	2452	--	--

Channel List For 802.11n (HT40)							
Channel	Frequency (MHz)	Channel	Frequency (MHz)	Channel	Frequency (MHz)	Channel	Frequency (MHz)
--	--	04	2427	07	2442	--	--
--	--	05	2432	08	2447	--	--
03	2422	06	2437	09	2452	--	--

**Note:**

In section 15.31(m), regards to the operating frequency range over 10 MHz, the Lowest frequency, the middle frequency, and the highest frequency of channel were selected to perform the test, and the selected channel see below:

### 2.3. Operation of EUT During Testing

**Operating Mode**

The mode is used: **Transmitting mode for 802.11b/802.11g/802.11n (HT20)**

- Low Channel: 2412MHz
- Middle Channel: 2437MHz
- High Channel: 2462MHz

The mode is used: **Transmitting mode for 802.11n (HT40)**

- Low Channel: 2422MHz
- Middle Channel: 2437MHz
- High Channel: 2452MHz





## 2.4. Description of Test Setup

Operation of EUT during conducted testing and below 1GHz radiation testing:

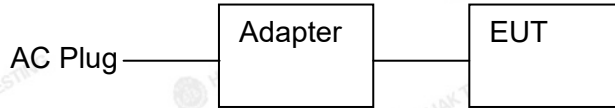

Operation of EUT during above 1GHz radiation testing:



The sample was placed (0.8m below 1GHz, 1.5m above 1GHz) above the ground plane of 3m chamber. Measurements in both horizontal and vertical polarities were performed. During the test, each emission was maximized by: having the EUT continuously working, investigated all operating modes, rotated about all 3 axis (X, Y & Z) and considered typical configuration to obtain worst position, manipulating interconnecting cables, rotating the turntable, varying antenna height from 1m to 4m in both horizontal and vertical polarizations. The emissions worst-case are shown in Test Results of the following pages. The worst case is X position.



## 2.5. Description of Support Units

The EUT has been tested as an independent unit together with other necessary accessories or support units. The following support units or accessories were used to form a representative test configuration during the tests.

Item	Equipment	Trade Mark	Model/Type No.	Specification	Remark
1	Alarm Host	N/A	PG-109	N/A	EUT
2	USB Cable	N/A	N/A	Length:1.01m	Accessory
3	Adapter	N/A	JK050200-S86USU	Input: AC 100-240V, 50/60Hz, 0.5A Output: 5V, 2A 10W	Accessory

**Note:**

1. All the equipment/cables were placed in the worst-case configuration to maximize the emission during the test.
2. Grounding was established in accordance with the manufacturer's requirements and conditions for the intended use.
3. For conducted measurements (Output Power, 6dB Emission Bandwidth, Power Spectral Density, Spurious Emissions), the antenna of EUT is connected to the test equipment via temporary antenna connector, the antenna connector is soldered on the antenna port of EUT, and the temporary antenna connector is listed in the Test Instruments.



### 3. Genera Information

#### 3.1. Test Environment and Mode

Operating Environment:	
Temperature:	25.0 °C
Humidity:	56 % RH
Atmospheric Pressure:	1010 mbar
Test Mode:	
Engineering mode:	Keep the EUT in continuous transmitting by select channel and modulations
<p>The sample was placed (0.8m below 1GHz, 1.5m above 1GHz) above the ground plane of 3m chamber. Measurements in both horizontal and vertical polarities were performed. During the test, each emission was maximized by: having the EUT continuously working, investigated all operating modes, rotated about all 3 axis (X, Y &amp; Z) and considered typical configuration to obtain worst position, manipulating interconnecting cables, rotating the turntable, varying antenna height from 1m to 4m in both horizontal and vertical polarizations. The emissions worst-case are shown in Test Results of the following pages. For the full battery state and The output power to the maximum state.</p>	





We have verified the construction and function in typical operation. All the test modes were carried out with the EUT in transmitting operation, which was shown in this test report and defined as follows:

**Per-scan all kind of data rate in lowest channel, and found the follow list which it was worst case.**

Mode	Data rate
802.11b	1Mbps
802.11g	6Mbps
802.11n(HT20)	6.5Mbps
802.11n(HT40)	13.5Mbps

**Final Test Mode:**

Operation mode:	Keep the EUT in continuous transmitting with modulation
-----------------	---

1. For WIFI function, the engineering test program was provided and enabled to make EUT continuous transmit/receive.

2. According to ANSI C63.10 standards, the test results are both the “worst case” and “worst setup” 1Mbps for 802.11b, 6Mbps for 802.11g, 6.5Mbps for 802.11n(HT20), 13.5Mbps for 802.11n(HT40).

**3. Mode Test Duty Cycle**

Mode	Duty Cycle	Duty Cycle Factor (dB)
802.11b	0.99	-0.04
802.11g	0.99	-0.04
802.11n(HT20)	0.99	-0.04
802.11n(HT40)	0.97	-0.13

Test plots as follows:

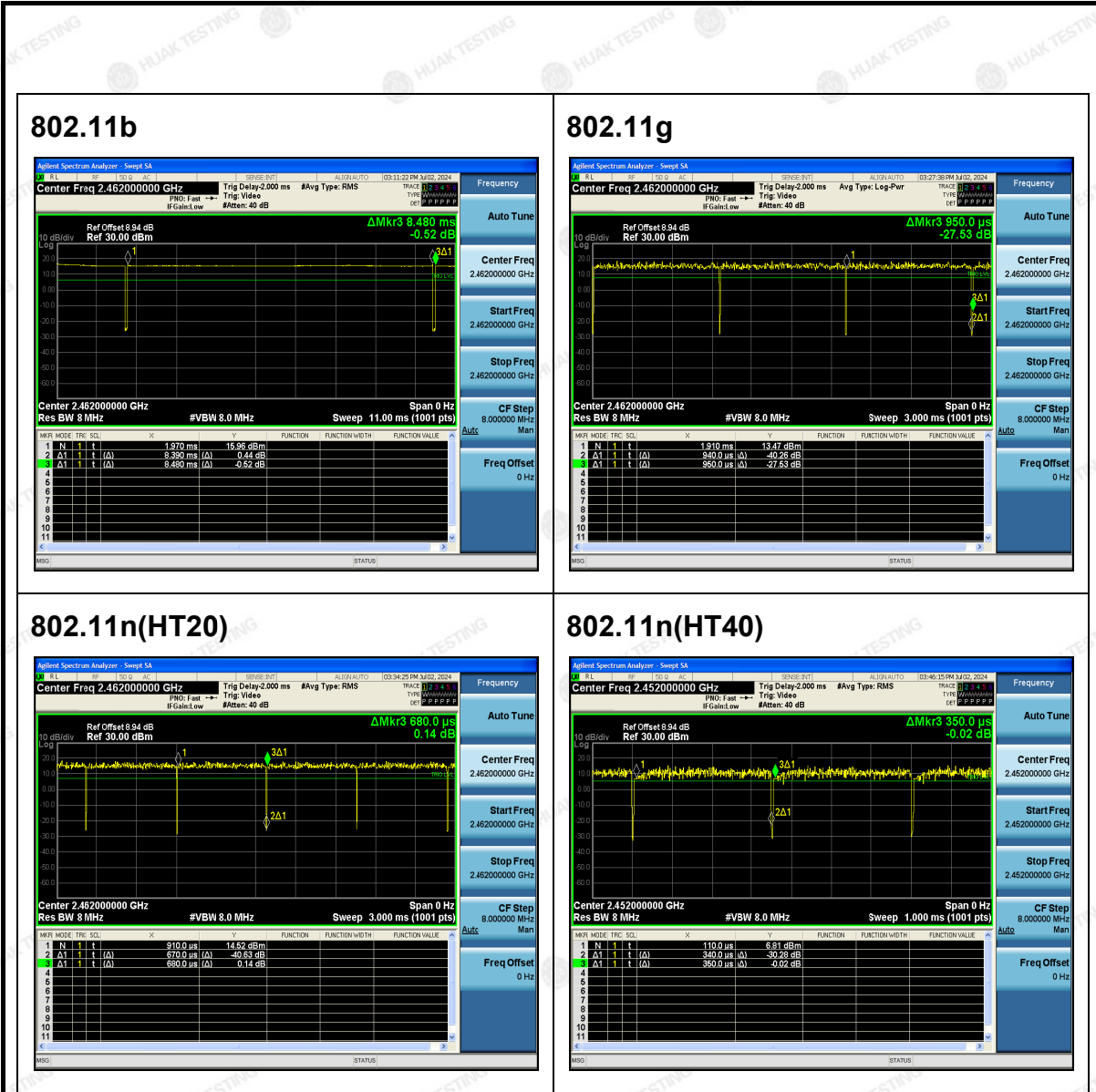

The results shown in this test report refer only to the sample(s) tested unless otherwise stated and the sample(s) are retained for 30 days only. The document is issued by HUAJ, this document cannot be reproduced except in full with our prior written permission. The more details and the authenticity of the report will be confirmed at <http://www.cer-mark.com>.

TEL : +86-755 2302 9901 FAX : +86-755 2302 9901 E-mail : service@cer-mark.com

Add: 1-2F., Building B2, Junfeng Zhongcheng Zhizao Innovation Park, Heping Community, Fuhai Street, Bao'an District, Shenzhen, Guangdong, China



### 4. Test Results and Measurement Data

#### 4.1. Conducted Emission

##### Test Specification

<b>Test Requirement:</b>	FCC Part15 C Section 15.207														
<b>Test Method:</b>	ANSI C63.10:2013														
<b>Frequency Range:</b>	150 kHz to 30 MHz														
<b>Receiver setup:</b>	RBW=9 kHz, VBW=30 kHz, Sweep time=auto														
<b>Limits:</b>	<table border="1"> <thead> <tr> <th rowspan="2">Frequency range (MHz)</th> <th colspan="2">Limit (dBuV)</th> </tr> <tr> <th>Quasi-peak</th> <th>Average</th> </tr> </thead> <tbody> <tr> <td>0.15-0.5</td> <td>66 to 56*</td> <td>56 to 46*</td> </tr> <tr> <td>0.5-5</td> <td>56</td> <td>46</td> </tr> <tr> <td>5-30</td> <td>60</td> <td>50</td> </tr> </tbody> </table>	Frequency range (MHz)	Limit (dBuV)		Quasi-peak	Average	0.15-0.5	66 to 56*	56 to 46*	0.5-5	56	46	5-30	60	50
Frequency range (MHz)	Limit (dBuV)														
	Quasi-peak	Average													
0.15-0.5	66 to 56*	56 to 46*													
0.5-5	56	46													
5-30	60	50													
<b>Test Setup:</b>	<p>Remark:  E.U.T: Equipment Under Test  LISN: Line Impedance Stabilization Network  Test table height=0.8m</p>														
<b>Test Mode:</b>	transmitting with modulation														
<b>Test Procedure:</b>	<ol style="list-style-type: none"> <li>The E.U.T is connected to the main power through a line impedance stabilization network (L.I.S.N.). This provides a 50ohm/50uH coupling impedance for the measuring equipment.</li> <li>The peripheral devices are also connected to the main power through a LISN that provides a 50ohm/50uH coupling impedance with 50ohm termination. (Please refer to the block diagram of the test setup and photographs).</li> <li>Both sides of A.C. line are checked for maximum conducted interference. In order to find the maximum emission, the relative positions of equipment and all of the interface cables must be changed according to ANSI C63.10: 2013 on conducted measurement.</li> </ol>														
<b>Test Result:</b>	PASS														

The results shown in this test report refer only to the sample(s) tested unless otherwise stated and the sample(s) are retained for 30 days only. The document is issued by HUAKE, this document cannot be reproduced except in full with our prior written permission. The more details and the authenticity of the report will be confirmed at <http://www.cer-mark.com>.



Test Instruments

Conducted Emission Shielding Room Test Site (843)					
Equipment	Manufacturer	Model	Serial Number	Calibration Date	Calibration Due
Receiver	R&S	ESR	HKE-005	Feb. 20, 2024	Feb. 19, 2025
LISN	R&S	ENV216	HKE-002	Feb. 20, 2024	Feb. 19, 2025
LISN	R&S	ENV216	HKE-059	Feb. 20, 2024	Feb. 19, 2025
Coax cable (9KHz-30MHz)	Times	381806-002	N/A	Feb. 20, 2024	Feb. 19, 2025
EMI Test Software	Tonscend	JS32-CE 2.5.0.6	HKE-081	N/A	N/A
10dB Attenuator	Schwarzbeck	VTSD9561F	HKE-153	Feb. 20, 2024	Feb. 19, 2025

**Note:** The calibration interval of the above test instruments is 12 months and the calibrations are traceable to international system unit (SI).



### 4.2. Test Result

Remark: All the test modes completed for test. only the worst result

Of was reported as below:

Conducted Emission on Line Terminal of the power line (150 kHz to 30MHz)

Test Specification: Line

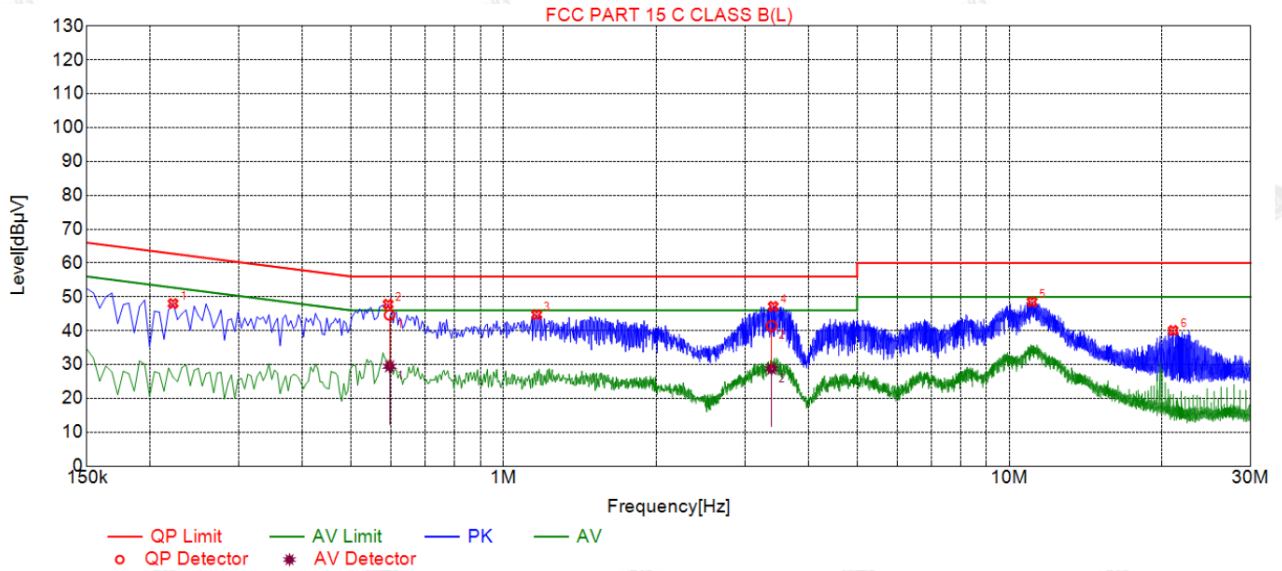

### Suspected List

NO.	Freq. [MHz]	Level [dBµV]	Factor [dB]	Limit [dBµV]	Margin [dB]	Reading [dBµV]	Detector	Type
1	0.2220	48.03	19.84	62.74	14.71	28.19	PK	L
2	0.5910	47.83	19.86	56.00	8.17	27.97	PK	L
3	1.1625	44.73	19.90	56.00	11.27	24.83	PK	L
4	3.4125	47.18	20.08	56.00	8.82	27.10	PK	L
5	11.0895	48.52	19.90	60.00	11.48	28.62	PK	L
6	21.0750	40.07	19.95	60.00	19.93	20.12	PK	L

### Final Data List

NO.	Freq. [MHz]	Correction factor [dB]	QP Value [dBµV]	QP Limit [dBµV]	QP Margin [dB]	QP Reading [dBµV]	AV Value [dBµV]	AV Limit [dBµV]	AV Margin [dB]	AV Reading [dBµV]	Type
1	0.5949	19.86	44.63	56.00	11.37	24.77	29.50	46.00	16.50	9.64	L
2	3.3872	20.07	41.44	56.00	14.56	21.37	28.76	46.00	17.24	8.69	L

Remark: Margin = Limit – Level

Correction factor = Cable lose + LISN insertion loss

Level=Test receiver reading + correction factor





Test Specification: Neutral

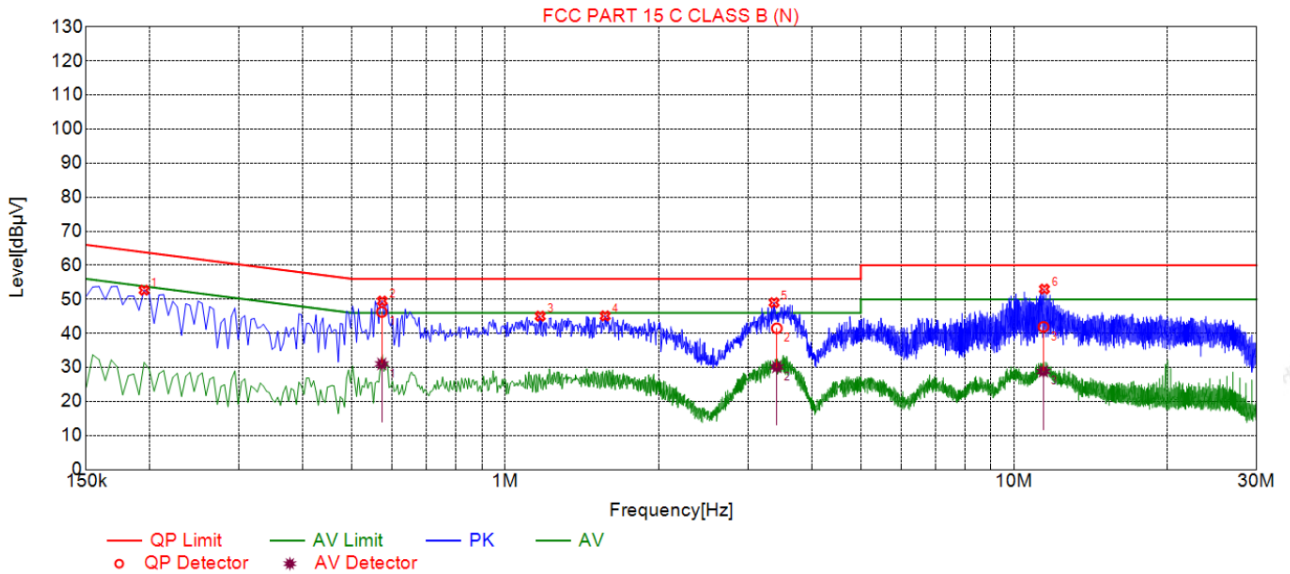

### Suspected List

NO.	Freq. [MHz]	Level [dBµV]	Factor [dB]	Limit [dBµV]	Margin [dB]	Reading [dBµV]	Detector	Type
1	0.1950	52.70	19.73	63.82	11.12	32.97	PK	N
2	0.5730	49.49	19.74	56.00	6.51	29.75	PK	N
3	1.1715	45.06	19.77	56.00	10.94	25.29	PK	N
4	1.5720	45.13	19.80	56.00	10.87	25.33	PK	N
5	3.3765	49.02	19.96	56.00	6.98	29.06	PK	N
6	11.4765	53.02	19.82	60.00	6.98	33.20	PK	N

### Final Data List

NO.	Freq. [MHz]	Correction factor [dB]	QP Value [dBµV]	QP Limit [dBµV]	QP Margin [dB]	QP Reading [dBµV]	AV Value [dBµV]	AV Limit [dBµV]	AV Margin [dB]	AV Reading [dBµV]	Type
1	0.5718	19.74	46.31	56.00	9.69	26.57	31.04	46.00	14.96	11.30	N
2	3.4176	19.95	41.48	56.00	14.52	21.53	30.14	46.00	15.86	10.19	N
3	11.4280	19.82	41.92	60.00	18.08	22.10	28.85	50.00	21.15	9.03	N

Remark: Margin = Limit – Level  
 Correction factor = Cable lose + LISN insertion loss  
 Level=Test receiver reading + correction factor



### 4.3. Maximum Conducted Output Power

#### Test Specification

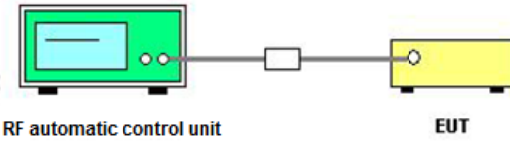
<b>Test Requirement:</b>	FCC Part15 C Section 15.247 (b)(3)
<b>Test Method:</b>	KDB 558074 D01 15.247 Meas Guidance v05r02
<b>Limit:</b>	30dBm
<b>Test Setup:</b>	 <p>RF automatic control unit                      EUT</p>
<b>Test Mode:</b>	Transmitting mode with modulation
<b>Test Procedure:</b>	<ol style="list-style-type: none"> <li>1. The testing follows the Measurement Procedure of FCC KDB 558074 D01 15.247 Meas Guidance v05r02.</li> <li>2. The RF output of EUT was connected to the RF automatic control unit by RF cable and attenuator. The path loss was compensated to the results for each measurement.</li> <li>3. Set to the maximum power setting and enable the EUT transmit continuously.</li> <li>4. Measure the Peak output power and record the results in the test report.</li> </ol>
<b>Test Result:</b>	PASS

#### Test Instruments

RF Test Room					
Equipment	Manufacturer	Model	Serial Number	Calibration Date	Calibration Due
Spectrum analyzer	Agilent	N9020A	HKE-025	Feb. 20, 2024	Feb. 19, 2025
Power meter	Agilent	E4419B	HKE-085	Feb. 20, 2024	Feb. 19, 2025
Power Sensor	Agilent	E9300A	HKE-086	Feb. 20, 2024	Feb. 19, 2025
RF cable	Times	1-40G	HKE-034	Feb. 20, 2024	Feb. 19, 2025
RF automatic control unit	Tonscend	JS0806-2	HKE-060	Feb. 20, 2024	Feb. 19, 2025
RF Test Software	Tonscend	JS1120-3 Version 3.3.23	HKE-083	N/A	N/A

**Note:** The calibration interval of the above test instruments is 12 months and the calibrations are traceable to international system unit (SI).



Test Data

Mode	Test Channel	Frequency	Maximum Peak Conducted Output Power	LIMIT
		(MHz)	(dBm)	dBm
802.11b	CH01	2412	12.69	30
802.11b	CH06	2437	12.84	30
802.11b	CH11	2462	13.01	30
802.11g	CH01	2412	12.85	30
802.11g	CH06	2437	12.92	30
802.11g	CH11	2462	12.77	30
802.11n(HT20)	CH01	2412	12.70	30
802.11n(HT20)	CH06	2437	12.74	30
802.11n(HT20)	CH11	2462	12.63	30
802.11n(HT40)	CH03	2422	12.85	30
802.11n(HT40)	CH06	2437	12.67	30
802.11n(HT40)	CH09	2452	12.52	30

Note: 1.The test results including the cable lose.



### 4.4. Emission Bandwidth

#### Test Specification

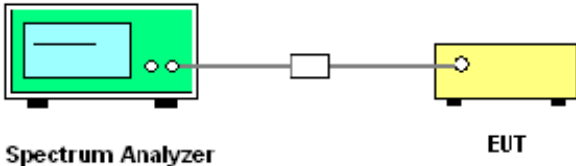
<b>Test Requirement:</b>	FCC Part15 C Section 15.247 (a)(2)
<b>Test Method:</b>	KDB 558074 D01 15.247 Meas Guidance v05r02
<b>Limit:</b>	>500kHz
<b>Test Setup:</b>	 <p style="text-align: center;">Spectrum Analyzer                          EUT</p>
<b>Test Mode:</b>	Transmitting mode with modulation
<b>Test Procedure:</b>	<ol style="list-style-type: none"> <li>1. The testing follows FCC KDB Publication 558074 D01 15.247 Meas Guidance v05r02.</li> <li>2. Set to the maximum power setting and enable the EUT transmit continuously.</li> <li>3. Make the measurement with the spectrum analyzer's resolution bandwidth (RBW) = 100 kHz. Set the Video bandwidth (VBW) = 300 kHz. In order to make an accurate measurement. The 6dB bandwidth must be greater than 500 kHz.</li> <li>4. Measure and record the results in the test report.</li> </ol>
<b>Test Result:</b>	PASS

#### Test Instruments

RF Test Room					
Equipment	Manufacturer	Model	Serial Number	Calibration Date	Calibration Due
Spectrum analyzer	Agilent	N9020A	HKE-025	Feb. 20, 2024	Feb. 19, 2025
RF cable	Times	1-40G	HKE-034	Feb. 20, 2024	Feb. 19, 2025
RF automatic control unit	Tonscend	JS0806-2	HKE-060	Feb. 20, 2024	Feb. 19, 2025
RF Test Software	Tonscend	JS1120-3 Version 3.3.23	HKE-083	N/A	N/A

**Note:** The calibration interval of the above test instruments is 12 months and the calibrations are traceable to international system unit (SI).



Test data

Test channel	6dB Emission Bandwidth (MHz)			
	802.11b	802.11g	802.11n(HT20)	802.11n(HT40)
Lowest	11.08	16.68	17.68	35.04
Middle	11.56	16.80	16.80	35.20
Highest	11.08	17.08	17.64	35.20
Limit:	>500kHz			
Test Result:	PASS			

Test plots as follows:



802.11b Modulation

Lowest channel



Middle channel



Highest channel



The results shown in this test report refer only to the sample(s) tested unless otherwise stated and the sample(s) are retained for 30 days only. The document is issued by HUAKE, this document cannot be reproduced except in full with our prior written permission. The more details and the authenticity of the report will be confirmed at <http://www.cer-mark.com>.

TEL : +86-755 2302 9901 FAX : +86-755 2302 9901 E-mail : service@cer-mark.com

Add: 1-2F., Building B2, Junfeng Zhongcheng Zhizao Innovation Park, Heping Community, Fuhai Street, Bao'an District, Shenzhen, Guangdong, China



802.11g Modulation

Lowest channel

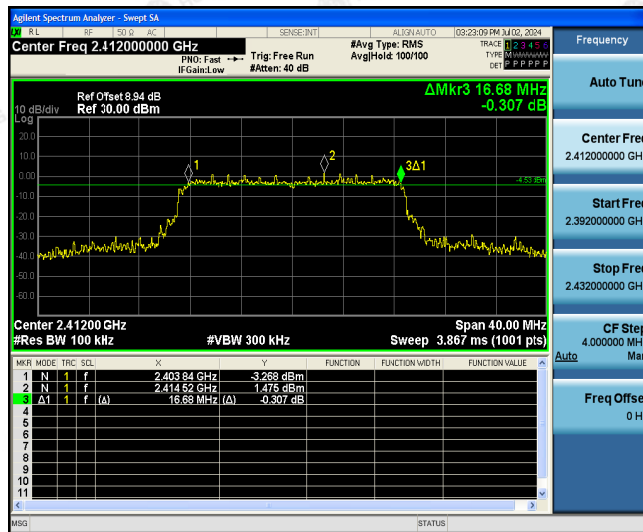

Middle channel

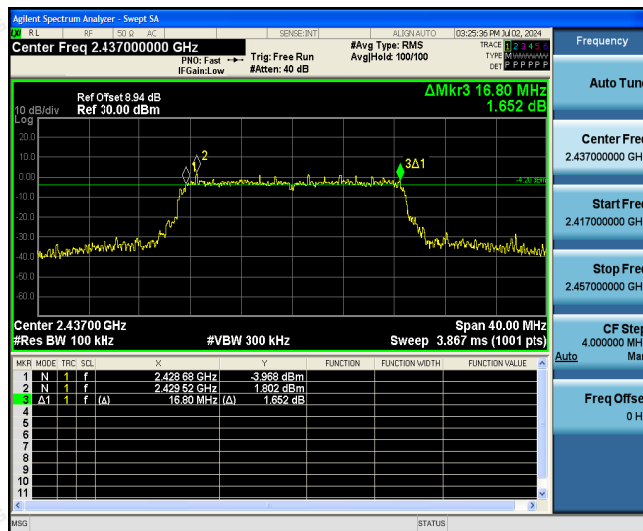

Highest channel

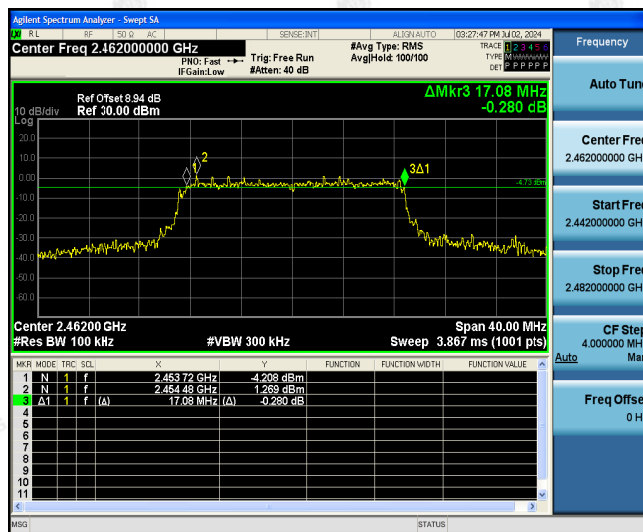

The results shown in this test report refer only to the sample(s) tested unless otherwise stated and the sample(s) are retained for 30 days only. The document is issued by HUAJ, this document cannot be reproduced except in full with our prior written permission. The more details and the authenticity of the report will be confirmed at <http://www.cer-mark.com>.

TEL : +86-755 2302 9901 FAX : +86-755 2302 9901 E-mail : service@cer-mark.com

Add: 1-2F., Building B2, Junfeng Zhongcheng Zhizao Innovation Park, Heping Community, Fuhai Street, Bao'an District, Shenzhen, Guangdong, China



802.11n (HT20) Modulation

Lowest channel

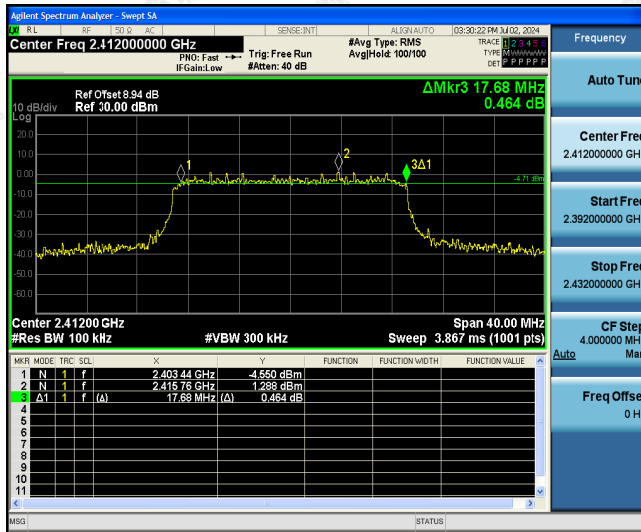

Middle channel

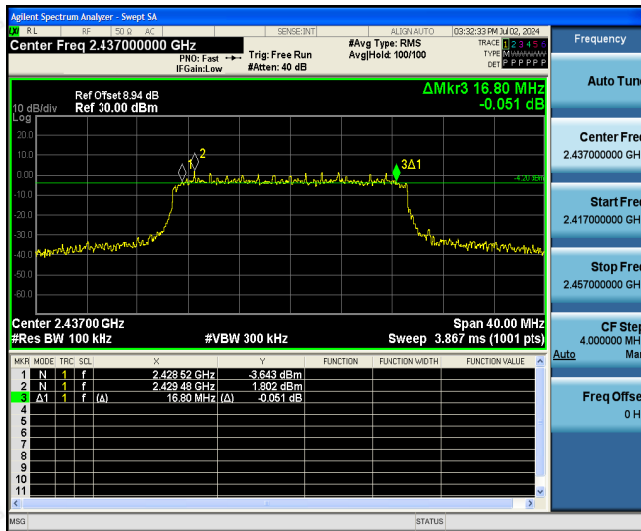

Highest channel

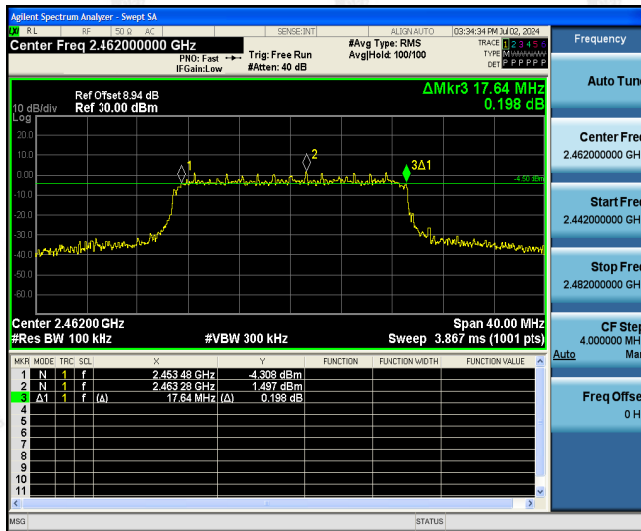

The results shown in this test report refer only to the sample(s) tested unless otherwise stated and the sample(s) are retained for 30 days only. The document is issued by HUAJ, this document cannot be reproduced except in full with our prior written permission. The more details and the authenticity of the report will be confirmed at <http://www.cer-mark.com>.

TEL : +86-755 2302 9901 FAX : +86-755 2302 9901 E-mail : service@cer-mark.com

Add: 1-2F., Building B2, Junfeng Zhongcheng Zhizao Innovation Park, Heping Community, Fuhai Street, Bao'an District, Shenzhen, Guangdong, China





802.11n (HT40) Modulation

Lowest channel

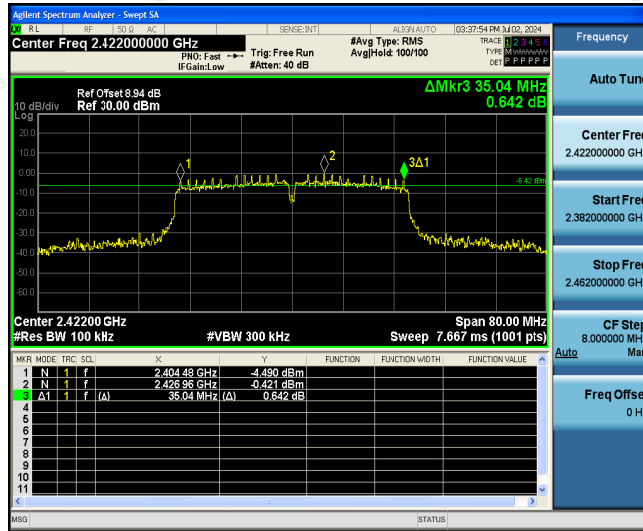

Middle channel

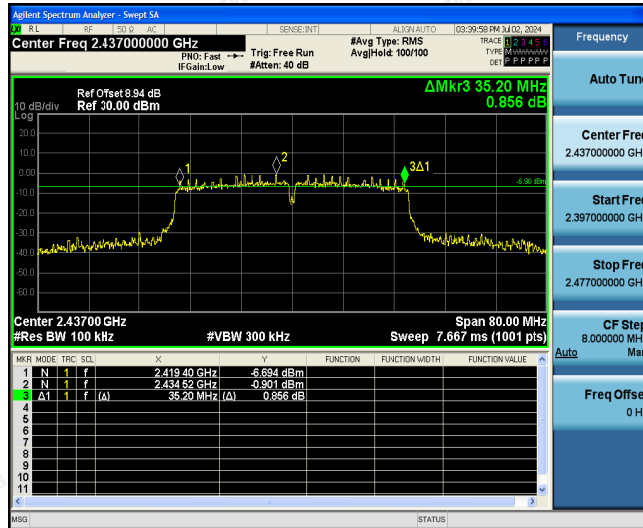

Highest channel

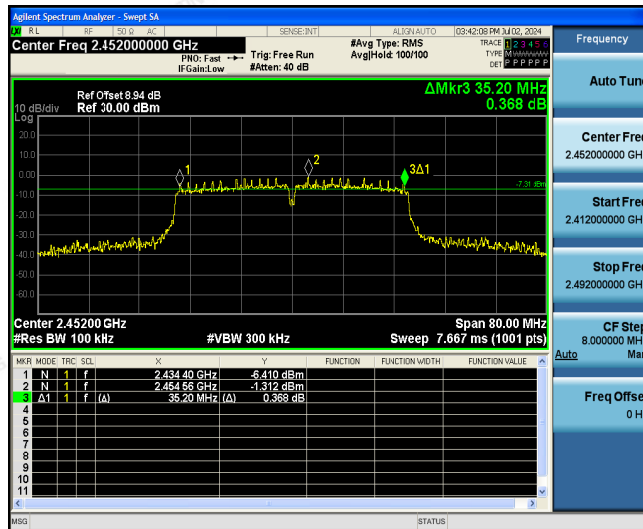

The results shown in this test report refer only to the sample(s) tested unless otherwise stated and the sample(s) are retained for 30 days only. The document is issued by HUAJ, this document cannot be reproduced except in full with our prior written permission. The more details and the authenticity of the report will be confirmed at <http://www.cer-mark.com>.

TEL : +86-755 2302 9901 FAX : +86-755 2302 9901 E-mail : service@cer-mark.com

Add: 1-2F., Building B2, Junfeng Zhongcheng Zhizao Innovation Park, Heping Community, Fuhai Street, Bao'an District, Shenzhen, Guangdong, China

### 4.5. Power Spectral Density

#### Test Specification

<b>Test Requirement:</b>	FCC Part15 C Section 15.247 (e)
<b>Test Method:</b>	KDB 558074 D01 15.247 Meas Guidance v05r02
<b>Limit:</b>	The average power spectral density shall not be greater than 8dBm in any 3kHz band at any time interval of continuous transmission.
<b>Test Setup:</b>	 <p style="text-align: center;">Spectrum Analyzer                      EUT</p>
<b>Test Mode:</b>	Transmitting mode with modulation
<b>Test Procedure:</b>	<ol style="list-style-type: none"> <li>1. The testing follows Measurement procedure 10.2 method PKPSD of FCC KDB Publication 558074 D01 15.247 Meas Guidance v05r02.</li> <li>2. The RF output of EUT was connected to the spectrum analyzer by RF cable and attenuator. The path loss was compensated to the results for each measurement.</li> <li>3. Set to the maximum power setting and enable the EUT transmit continuously.</li> <li>4. Make the measurement with the spectrum analyzer's resolution bandwidth (RBW): <math>3\text{ kHz} \leq \text{RBW} \leq 100\text{ kHz}</math>. Video bandwidth <math>\text{VBW} \geq 3 \times \text{RBW}</math>. Set the span to at least 1.5 times the OBW.</li> <li>5. Detector = Peak, Sweep time = auto couple.</li> <li>6. Employ trace averaging (Peak) mode over a minimum of 100 traces. Use the peak marker function to determine the maximum power level.</li> <li>7. Measure and record the results in the test report.</li> </ol>
<b>Test Result:</b>	PASS



Test Instruments

RF Test Room					
Equipment	Manufacturer	Model	Serial Number	Calibration Date	Calibration Due
Spectrum analyzer	Agilent	N9020A	HKE-025	Feb. 20, 2024	Feb. 19, 2025
RF cable	Times	1-40G	HKE-034	Feb. 20, 2024	Feb. 19, 2025
RF automatic control unit	Tonscend	JS0806-2	HKE-060	Feb. 20, 2024	Feb. 19, 2025
RF Test Software	Tonscend	JS1120-3 Version 3.3.23	HKE-083	N/A	N/A

**Note:** The calibration interval of the above test instruments is 12 months and the calibrations are traceable to international system unit (SI).



Test data

EUT Set Mode	Channel	Test Result (dBm/30kHz)	Result (dBm/3kHz)
802.11b	Lowest	-1.75	-11.75
	Middle	-1.70	-11.70
	Highest	-1.44	-11.44
802.11g	Lowest	-1.70	-11.70
	Middle	-2.17	-12.17
	Highest	-2.86	-12.86
802.11n(H20)	Lowest	-2.30	-12.30
	Middle	-2.57	-12.57
	Highest	-2.15	-12.15
802.11n(H40)	Lowest	-3.51	-13.51
	Middle	-3.65	-13.65
	Highest	-3.98	-13.98
PSD test result (dBm/3kHz)= PSD test result (dBm/30kHz)-10			
Limit: 8dBm/3kHz			
Test Result:	PASS		

Test plots as follows:



802.11b Modulation

Lowest channel



Middle channel

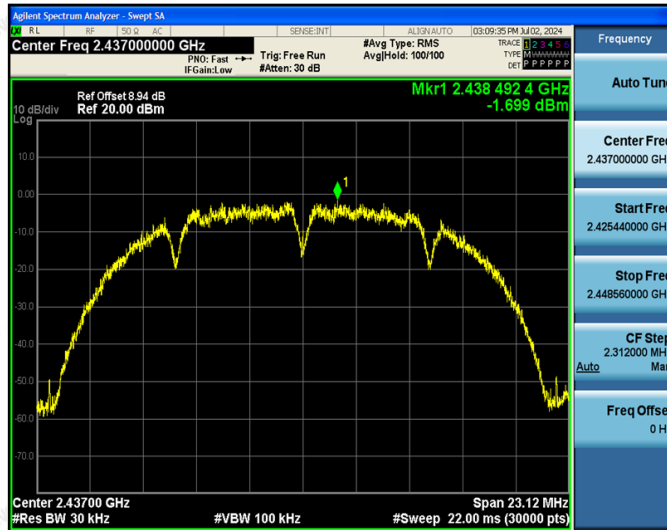

Highest channel

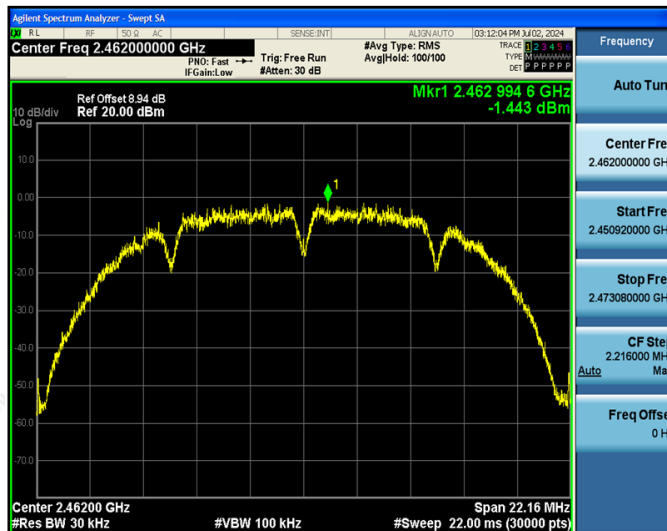

The results shown in this test report refer only to the sample(s) tested unless otherwise stated and the sample(s) are retained for 30 days only. The document is issued by HUAKE, this document cannot be reproduced except in full with our prior written permission. The more details and the authenticity of the report will be confirmed at <http://www.cer-mark.com>.

TEL : +86-755 2302 9901 FAX : +86-755 2302 9901 E-mail : service@cer-mark.com

Add: 1-2F., Building B2, Junfeng Zhongcheng Zhizao Innovation Park, Heping Community, Fuhai Street, Bao'an District, Shenzhen, Guangdong, China



802.11g Modulation

Lowest channel

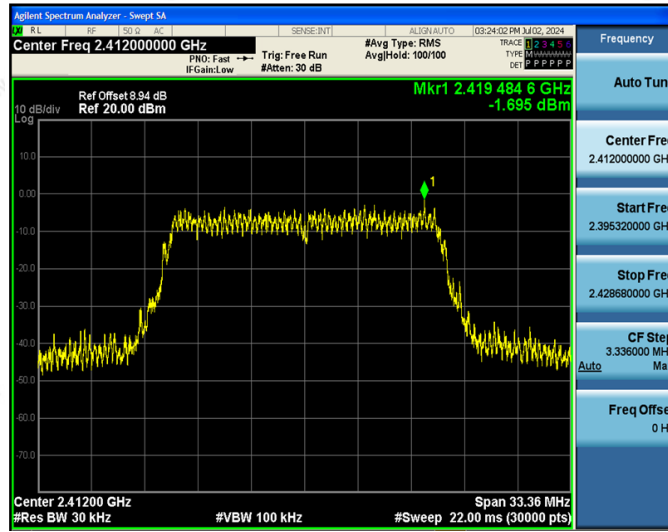

Middle channel

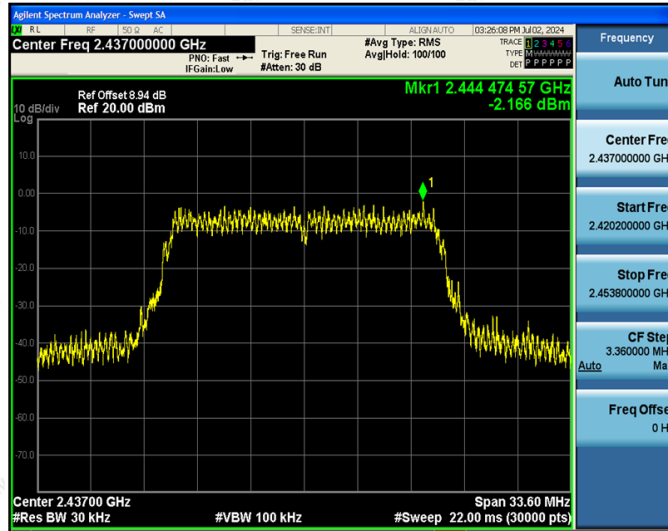

Highest channel

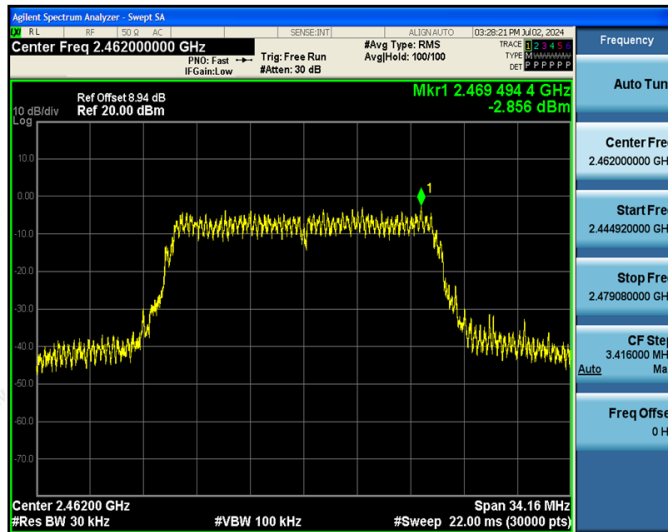

The results shown in this test report refer only to the sample(s) tested unless otherwise stated and the sample(s) are retained for 30 days only. The document is issued by HUAJ, this document cannot be reproduced except in full with our prior written permission. The more details and the authenticity of the report will be confirmed at <http://www.cer-mark.com>.

TEL : +86-755 2302 9901 FAX : +86-755 2302 9901 E-mail : service@cer-mark.com

Add: 1-2F., Building B2, Junfeng Zhongcheng Zhizao Innovation Park, Heping Community, Fuhai Street, Bao'an District, Shenzhen, Guangdong, China



802.11n (HT20) Modulation

Lowest channel

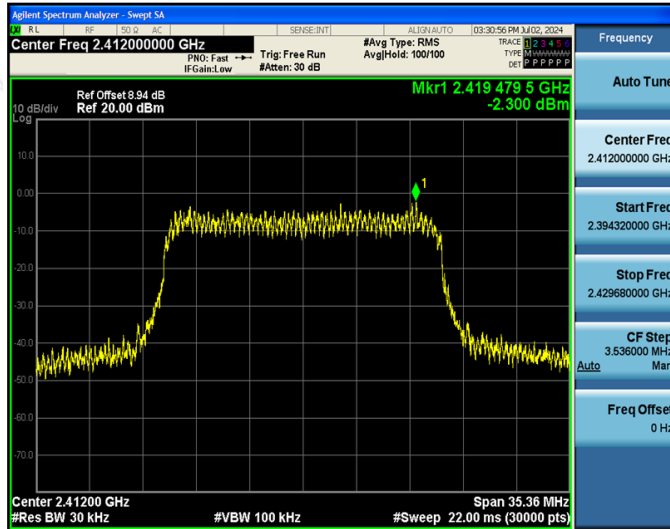

Middle channel

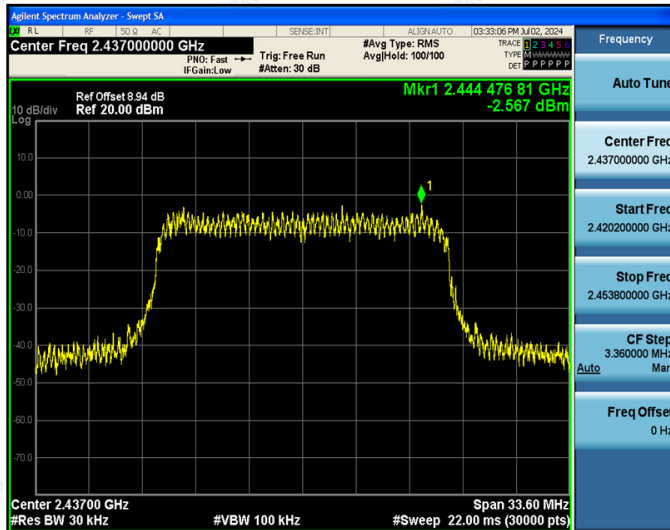

Highest channel

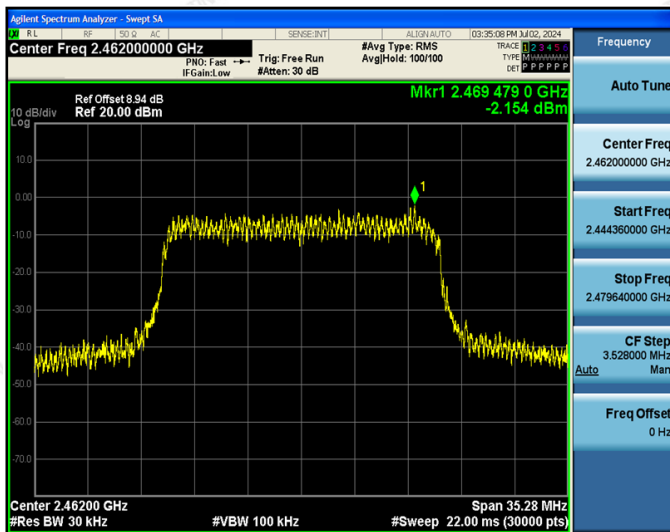

The results shown in this test report refer only to the sample(s) tested unless otherwise stated and the sample(s) are retained for 30 days only. The document is issued by HUAKE, this document cannot be reproduced except in full with our prior written permission. The more details and the authenticity of the report will be confirmed at <http://www.cer-mark.com>.

TEL : +86-755 2302 9901 FAX : +86-755 2302 9901 E-mail : service@cer-mark.com

Add: 1-2F., Building B2, Junfeng Zhongcheng Zhizao Innovation Park, Heping Community, Fuhai Street, Bao'an District, Shenzhen, Guangdong, China



802.11n (HT40) Modulation

Lowest channel

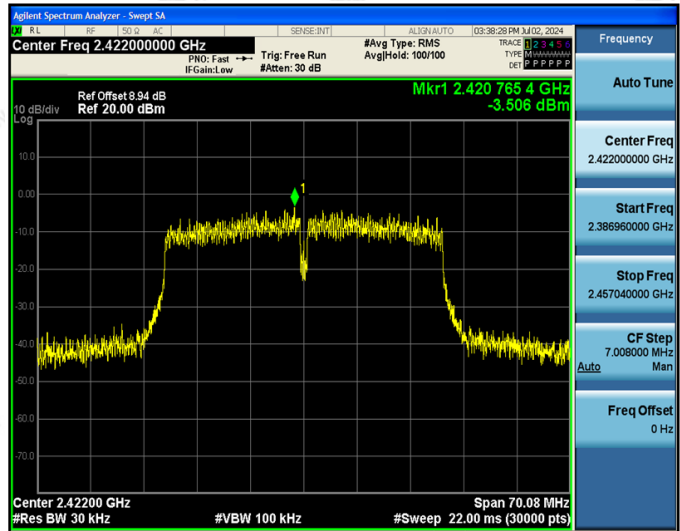

Middle channel

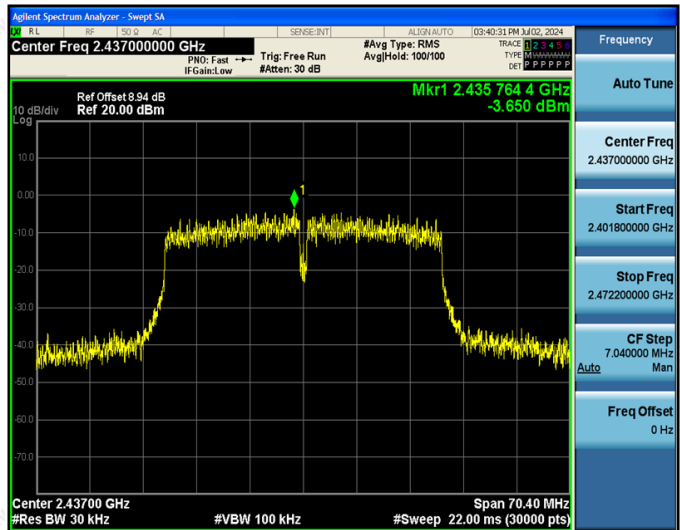

Highest channel

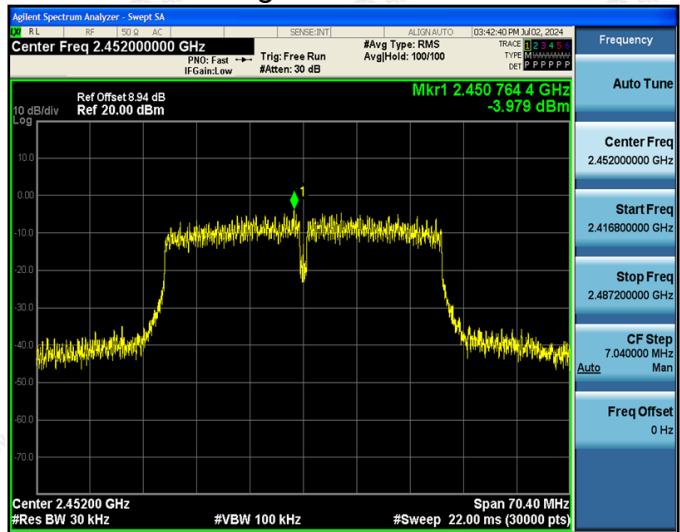

The results shown in this test report refer only to the sample(s) tested unless otherwise stated and the sample(s) are retained for 30 days only. The document is issued by HUAJ, this document cannot be reproduced except in full with our prior written permission. The more details and the authenticity of the report will be confirmed at <http://www.cer-mark.com>.

TEL : +86-755 2302 9901 FAX : +86-755 2302 9901 E-mail : [service@cer-mark.com](mailto:service@cer-mark.com)

Add: 1-2F., Building B2, Junfeng Zhongcheng Zhizao Innovation Park, Heping Community, Fuhai Street, Bao'an District, Shenzhen, Guangdong, China