



# **FCC RADIO TEST REPORT**

## **FCC ID: 2AILN255A8046922**

**Product :** Gadgetree Lighted Geode Speaker

**Trade Name :** Gadgetree,RCA

**Model Name:** 8046922

**Serial Model :** BT201616

**Report No. :** POCE- 2016052821R1

### **Prepared for**

Voxx Consumer Electronics Hong Kong Limited  
Unit 1001-1008, 10/F, Tower 1, Millennium City 1, No. 388 Kwun Tong Road,  
Kwun Tong, Kowloon, Hong Kong

### **Prepared by**

Shenzhen POCE Technology Co.,Ltd.  
Room 502, Bldg. 1, Xinghua Garden, Baoan Road Xixiang,  
Baoan District,Shenzhen, China

## TEST RESULT CERTIFICATION

**Applicant's name** ..... : Voxx Consumer Electronics Hong Kong Limited  
**Address** ..... : Unit 1001-1008, 10/F, Tower 1, Millennium City 1, No. 388 Kwun Tong Road, Kwun Tong, Kowloon, Hong Kong  
**Manufacturer's Name** ..... : Voxx Consumer Electronics Hong Kong Limited  
**Address** ..... : Unit 1001-1008, 10/F, Tower 1, Millennium City 1, No. 388 Kwun Tong Road, Kwun Tong, Kowloon, Hong Kong

### Product description

**Product name** ..... : Gadgetree Lighted Geode Speaker  
**Model and/or type reference** : 8046922  
**Trade Name** : Gadgetree,RCA  
**Serial Model** ..... : BT201616

**Standards** ..... : FCC Part15.247

**Test procedure** ..... ANSI C63.10: 2013

This device described above has been tested by POCE, and the test results show that the equipment under test (EUT) is in compliance with the FCC requirements. And it is applicable only to the tested sample identified in the report.

This report shall not be reproduced except in full, without the written approval of POCE, this document may be altered or revised by POCE, personal only, and shall be noted in the revision of the document.

**Date of Test** ..... :

**Date (s) of performance of tests** ..... : 10 May. 2016 ~20 May. 2016

**Date of Issue** ..... : 20 May. 2016

**Test Result** ..... : **Pass**

Testing Engineer : \_\_\_\_\_



(Ken Li)

Technical Manager : \_\_\_\_\_



(Jimmy Yao)

Authorized Signatory : \_\_\_\_\_



(Terry Yang)

**Table of Contents**

	<b>Page</b>
<b>1 . SUMMARY OF TEST RESULTS</b>	<b>5</b>
1.1 TEST FACILITY	6
1.2 MEASUREMENT UNCERTAINTY	6
<b>2 . GENERAL INFORMATION</b>	<b>7</b>
2.1 GENERAL DESCRIPTION OF EUT	7
2.2 DESCRIPTION OF TEST MODES	9
2.3 TABLE OF PARAMETERS OF TEXT SOFTWARE SETTING	9
2.4 BLOCK DIGRAM SHOWING THE CONFIGURATION OF SYSTEM TESTED	10
2.5 DESCRIPTION OF SUPPORT UNITS(CONDUCTED MODE)	11
2.6 EQUIPMENTS LIST FOR ALL TEST ITEMS	12
<b>3 . EMC EMISSION TEST</b>	<b>13</b>
3.1 CONDUCTED EMISSION MEASUREMENT	13
3.1.1 POWER LINE CONDUCTED EMISSION LIMITS	13
3.1.2 TEST PROCEDURE	14
3.1.3 DEVIATION FROM TEST STANDARD	14
3.1.4 TEST SETUP	14
3.1.5 EUT OPERATING CONDITIONS	14
3.1.6 TEST RESULTS	15
3.2 RADIATED EMISSION MEASUREMENT	17
3.2.1 RADIATED EMISSION LIMITS	17
3.2.2 TEST PROCEDURE	17
3.2.3 DEVIATION FROM TEST STANDARD	18
3.2.4 TEST SETUP	19
3.2.5 EUT OPERATING CONDITIONS	20
3.2.6 TEST RESULTS (BELOW 30 MHZ)	21
3.2.7 TEST RESULTS (BETWEEN 30M – 1000 MHZ)	22
3.2.8 TEST RESULTS (ABOVE 1000 MHZ)	24
3.2.9 TEST RESULTS (RESTRICTED BANDS REQUIREMENTS)	25
<b>4 . NUMBER OF HOPPING CHANNEL</b>	<b>27</b>
4.1 APPLIED PROCEDURES / LIMIT	27
4.1.1 TEST PROCEDURE	27
4.1.2 DEVIATION FROM STANDARD	27
4.1.3 TEST SETUP	27
4.1.4 EUT OPERATION CONDITIONS	27
4.1.5 TEST RESULTS	28
<b>5 . AVERAGE TIME OF OCCUPANCY</b>	<b>29</b>

**Table of Contents**

	<b>Page</b>
<b>5.1 APPLIED PROCEDURES / LIMIT</b>	<b>29</b>
5.1.1 TEST PROCEDURE	29
5.1.2 DEVIATION FROM STANDARD	29
5.1.3 TEST SETUP	30
5.1.4 EUT OPERATION CONDITIONS	30
5.1.5 TEST RESULTS	31
<b>6 . HOPPING CHANNEL SEPARATION MEASUREMENT</b>	<b>37</b>
6.1 APPLIED PROCEDURES / LIMIT	37
6.1.1 TEST PROCEDURE	37
6.1.2 DEVIATION FROM STANDARD	37
6.1.3 TEST SETUP	37
6.1.4 EUT OPERATION CONDITIONS	37
6.1.5 TEST RESULTS	38
<b>7 . BANDWIDTH TEST</b>	<b>44</b>
7.1 APPLIED PROCEDURES / LIMIT	44
7.1.1 TEST PROCEDURE	44
7.1.2 DEVIATION FROM STANDARD	44
7.1.3 TEST SETUP	44
7.1.4 EUT OPERATION CONDITIONS	44
7.1.5 TEST RESULTS	45
<b>8 . PEAK OUTPUT POWER TEST</b>	<b>51</b>
8.1 APPLIED PROCEDURES / LIMIT	51
8.1.1 TEST PROCEDURE	51
8.1.2 DEVIATION FROM STANDARD	51
8.1.3 TEST SETUP	51
8.1.4 EUT OPERATION CONDITIONS	51
8.1.5 TEST RESULTS	52
<b>9.CONDUCTED SPURIOUS EMISSIONS</b>	<b>58</b>

## 1. SUMMARY OF TEST RESULTS

Test procedures according to the technical standards:

<b>FCC Part15 (15.247) , Subpart C</b>			
Standard Section	Test Item	Judgment	Remark
15.207	Conducted Emission	PASS	
15.247(a)(1)	Hopping Channel Separation	PASS	
15.247(b)(1) 15.31(e)	Peak Output Power	PASS	
15.247(c) 15.205	Radiated Spurious Emission	PASS	
15.247(d)	Conducted spurious Emission	PASS	
15.247(a)(iii)	Number of Hopping Frequency	PASS	
15.247(a)(iii)	Dwell Time	PASS	
15.247(a)(1)	Bandwidth	PASS	
15.247(d) 15.205	Band Edge Emission	PASS	
15.203	Antenna Requirement	PASS	

**NOTE:**

(1) "N/A" denotes test is not applicable in this Test Report

## 1.1 TEST FACILITY

Shenzhen POCE Technology Co.,Ltd.

Add.: Room 502, Bldg. 1, Xinghua Garden, Baoan Road Xixiang, Baoan District, Shenzhen, China

FCC-Registration No.: 222278

## 1.2 MEASUREMENT UNCERTAINTY

The reported uncertainty of measurement  $y \pm U$ , where expanded uncertainty  $U$  is based on a standard uncertainty multiplied by a coverage factor of  $k=2$ , providing a level of confidence of approximately **95 %**.

No.	Item	Uncertainty
1	Conducted Emission Test	$\pm 1.38\text{dB}$
2	RF power,conducted	$\pm 0.16\text{dB}$
3	Spurious emissions,conducted	$\pm 0.21\text{dB}$
4	All emissions,radiated(<1G)	$\pm 4.68\text{dB}$
5	All emissions,radiated(>1G)	$\pm 4.89\text{dB}$
6	Temperature	$\pm 0.5^{\circ}\text{C}$
7	Humidity	$\pm 2\%$

## 2. GENERAL INFORMATION

### 2.1 GENERAL DESCRIPTION OF EUT

Equipment	Gadgetree Lighted Geode Speaker	
Trade Name	Gadgetree,RCA	
Model Name	8046922	
Serial Model	BT201616	
Model Difference	All the same,only model name is different.	
Bluetooth version	BT 2.1+EDR	
Product Description	The EUT is a Gadgetree Lighted Geode Speaker	
	Operation Frequency:	2402~2480 MHz
	Modulation Type:	BT(1Mbps): GFSK BT EDR(2Mbps):π/4-DQPSK BT EDR(3Mbps): 8-DPSK
	Bit Rate of Transmitter	1Mbps/2Mbps/3Mbps
	Number Of Channel	79 CH
	Antenna Designation:	Please see Note 3.
	Output Power(Conducted):	BT(1Mbps): 0.435dBm BT EDR(2Mbps): -0.135dBm BT EDR(3Mbps): -0.363dBm
	Based on the application, features, or specification exhibited in User's Manual, the EUT is considered as an ITE/Computing Device. More details of EUT technical specification, please refer to the User's Manual.	
Channel List	Please refer to the Note 2.	
Adapter	N/A	
Battery	DC 3.7V	
Connecting I/O Port(s)	Please refer to the User's Manual	

Note:

1. For a more detailed features description, please refer to the manufacturer's specifications or the User's Manual.

2.

Channel List					
Channel	Frequency (MHz)	Channel	Frequency (MHz)	Channel	Frequency (MHz)
00	2402	27	2429	54	2456
01	2403	28	2430	55	2457
02	2404	29	2431	56	2458
03	2405	30	2432	57	2459
04	2406	31	2433	58	2460
05	2407	32	2434	59	2461
06	2408	33	2435	60	2462
07	2409	34	2436	61	2463
08	2410	35	2437	62	2464
09	2411	36	2438	63	2465
10	2412	37	2439	64	2466
11	2413	38	2440	65	2467
12	2414	39	2441	66	2468
13	2415	40	2442	67	2469
14	2416	41	2443	68	2470
15	2417	42	2444	69	2471
16	2418	43	2445	70	2472
17	2419	44	2446	71	2473
18	2420	45	2447	72	2474
19	2421	46	2448	73	2475
20	2422	47	2449	74	2476
21	2423	48	2450	75	2477
22	2424	49	2451	76	2478
23	2425	50	2452	77	2479
24	2426	51	2453	78	2480
25	2427	52	2454		
26	2428	53	2455		

3.

Table for Filed Antenna

Ant	Brand	Model Name	Antenna Type	Connector	Gain (dBi)	NOTE
1	N/A	N/A	PCB Antenna	NA	0.8	BT Antenna



## 2.2 DESCRIPTION OF TEST MODES

To investigate the maximum EMI emission characteristics generates from EUT, the test system was pre-scanning tested base on the consideration of following EUT operation mode or test configuration mode which possible have effect on EMI emission level. Each of these EUT operation mode(s) or test configuration mode(s) mentioned above was evaluated respectively.

Pretest Mode	Description
Mode 1	CH00
Mode 2	CH39
Mode 3	CH78
Mode 4	BT Link Mode

For Conducted Emission	
Final Test Mode	Description
Mode 4	BT Link Mode

For Radiated Emission	
Final Test Mode	Description
Mode 1	CH00
Mode 2	CH39
Mode 3	CH78

Note:

(1) The measurements are performed at the highest, middle, lowest available channels.

(2)The data rate was set in 1Mbps for radiated emission due to the highest RF output power.

## 2.3 TABLE OF PARAMETERS OF TEXT SOFTWARE SETTING

During testing channel & power controlling software provided by the customer was used to control the operating channel as well as the output power level. The RF output power selection is for the setting of RF output power expected by the customer and is going to be fixed on the firmware of the final end product power parameters of FHSS

Test software Version	Test program: CW6686		
Frequency	2402 MHz	2441 MHz	2480 MHz
Parameters(1Mbps)	DEF	DEF	DEF
Parameters(2Mbps)	DEF	DEF	DEF
Parameters(3Mbps)	DEF	DEF	DEF

## 2.4 BLOCK DIGRAM SHOWING THE CONFIGURATION OF SYSTEM TESTED

CONDUCTED EMISSION:

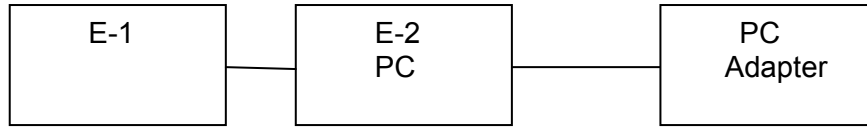

RADIATED EMISSION:

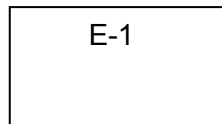

**2.5 DESCRIPTION OF SUPPORT UNITS(CONDUCTED MODE)**

The EUT has been tested as an independent unit together with other necessary accessories or support units. The following support units or accessories were used to form a representative test configuration during the tests.

Item	Equipment	Mfr/Brand	Model/Type No.	Series No.	Note
E-1	Gadgetree Lighted Geode Speaker	Gadgetree,RCA	8046922	N/A	EUT
E2	PC	IBM	2366	N/A	Auxiliary equipment
E3	Adapter(PC)	IBM	08K8202	N/A	

Item	Shielded Type	Ferrite Core	Length	Note
C-1	NO	NO	0.7m	

Note:

- (1) The support equipment was authorized by Declaration of Confirmation.
- (2) For detachable type I/O cable should be specified the length in cm in 『Length』 column.
- (3) “YES” is means “shielded” “with core”; “NO” is means “unshielded” “without core”.

## 2.6 EQUIPMENTS LIST FOR ALL TEST ITEMS

### Radiation Test equipment

Item	Kind of Equipment	Manufacturer	Type No.	Serial No.	Last calibration	Calibrated until	Calibration period
1	Spectrum Analyzer	Agilent	E4407B	MY45108040	2015.07.06	2016.07.05	1 year
2	Test Receiver	R&S	ESPI	101318	2015.06.07	2016.06.06	1 year
3	Bilog Antenna	TESEQ	CBL6111D	31216	2015.07.06	2016.07.05	1 year
4	50Ω Coaxial Switch	Anritsu	MP59B	6200264416	2015.06.07	2016.06.06	1 year
5	Spectrum Analyzer	ADVANTEST	R3132	150900201	2015.06.07	2016.06.06	1 year
6	Horn Antenna	EM	EM-AH-10180	2011071402	2015.07.06	2016.07.05	1 year
7	Horn Ant	Schwarzbeck	BBHA 9170	9170-181	2015.07.06	2016.07.05	1 year
8	Amplifier	EM	EM-30180	060538	2015.12.22	2016.12.21	1 year
9	Loop Antenna	ARA	PLA-1030/B	1029	2015.06.08	2016.06.07	1 year
10	Power Meter	R&S	NRVS	100696	2015.07.06	2016.07.05	1 year
11	Power Sensor	R&S	URV5-Z4	0395.1619.05	2015.07.06	2016.07.05	1 year
12	Signal Analyzer	Agilent	N9020A	MY49100060	2015.07.06	2016.07.05	1 year

### Conduction Test equipment

Item	Kind of Equipment	Manufacturer	Type No.	Serial No.	Last calibration	Calibrated until	Calibration period
1	Test Receiver	R&S	ESCI	101160	2015.06.06	2016.06.05	1 year
2	LISN	R&S	ENV216	101313	2015.08.24	2016.08.23	1 year
3	LISN	EMCO	3816/2	00042990	2015.08.24	2016.08.23	1 year
4	50Ω Coaxial Switch	Anritsu	MP59B	6200264417	2015.06.07	2016.06.06	1 year
5	Passive Voltage Probe	R&S	ESH2-Z3	100196	2015.06.07	2016.06.06	1 year
6	Absorbing clamp	R&S	MOS-21	100423	2015.06.08	2016.06.07	1 year

### 3. EMC EMISSION TEST

#### 3.1 CONDUCTED EMISSION MEASUREMENT

##### 3.1.1 POWER LINE CONDUCTED EMISSION Limits (Frequency Range 150KHz-30MHz)

FREQUENCY (MHz)	Class A (dBuV)		Class B (dBuV)		Standard
	Quasi-peak	Average	Quasi-peak	Average	
0.15 -0.5	79.00	66.00	66 - 56 *	56 - 46 *	CISPR
0.50 -5.0	73.00	60.00	56.00	46.00	CISPR
5.0 -30.0	73.00	60.00	60.00	50.00	CISPR

0.15 -0.5	79.00	66.00	66 - 56 *	56 - 46 *	FCC
0.50 -5.0	73.00	60.00	56.00	46.00	FCC
5.0 -30.0	73.00	60.00	60.00	50.00	FCC

Note:

- (1) The tighter limit applies at the band edges.
- (2) The limit of " \* " marked band means the limitation decreases linearly with the logarithm of the frequency in the range.

The following table is the setting of the receiver

Receiver Parameters	Setting
Attenuation	10 dB
Start Frequency	0.15 MHz
Stop Frequency	30 MHz
IF Bandwidth	9 kHz

### 3.1.2 TEST PROCEDURE

- a. The EUT was placed 0.4 meters from the horizontal ground plane with EUT being connected to the power mains through a line impedance stabilization network (LISN). All other support equipments powered from additional LISN(s). The LISN provide 50 Ohm/ 50uH of coupling impedance for the measuring instrument.
- b. Interconnecting cables that hang closer than 40 cm to the ground plane shall be folded back and forth in the center forming a bundle 30 to 40 cm long.
- c. I/O cables that are not connected to a peripheral shall be bundled in the center. The end of the cable may be terminated, if required, using the correct terminating impedance. The overall length shall not exceed 1 m.
- d. LISN at least 80 cm from nearest part of EUT chassis.
- e. For the actual test configuration, please refer to the related Item –EUT Test Photos.

### 3.1.3 DEVIATION FROM TEST STANDARD

No deviation

### 3.1.4 TEST SETUP

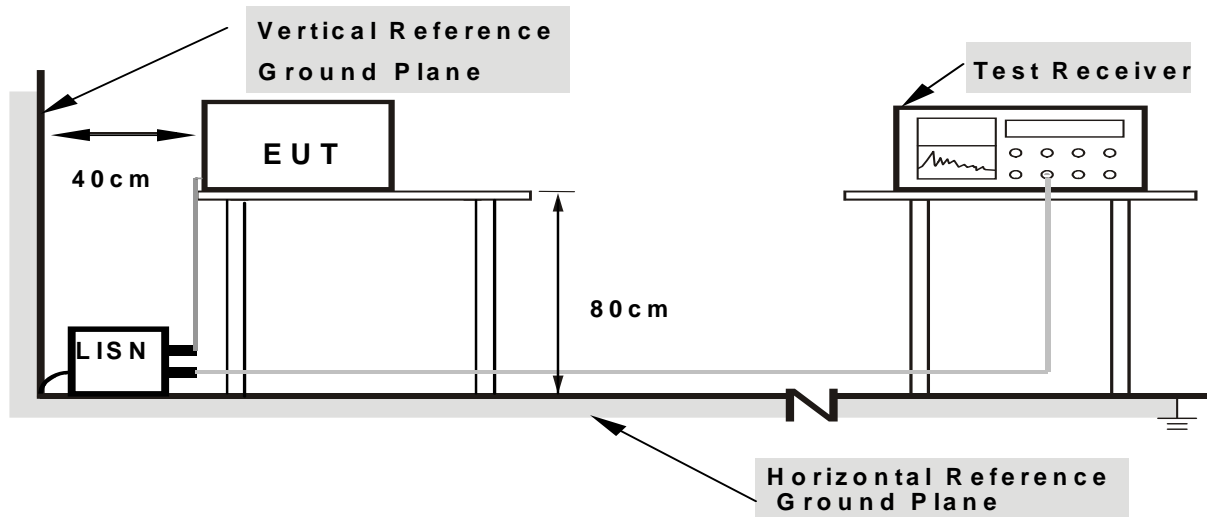

**Note: 1. Support units were connected to second LISN.**

**2. Both of LISNs (AMN) are 80 cm from EUT and at least 80 cm from other units and other metal planes**

### 3.1.5 EUT OPERATING CONDITIONS

The EUT was configured for testing in a typical fashion (as a customer would normally use it). The EUT has been programmed to continuously transmit during test. This operating condition was tested and used to collect the included data.

### 3.1.6 TEST RESULTS

EUT :	Gadgetree Lighted Geode Speaker	Model Name. :	8046922
Temperature :	26 °C	Relative Humidity :	54%
Pressure :	1010hPa	Phase :	L
Test Voltage :	AC120V/60Hz	Test Mode :	Mode 4

Frequency (MHz)	Meter Reading (dBμV)	Factor (dB)	Emission Level (dBμV)	Limits (dBμV)	Margin (dB)	Detector Type
0.2540	47.25	10.02	57.27	61.62	-4.35	QP
0.2540	32.92	10.02	42.94	51.62	-8.68	AVG
0.5060	43.53	10.02	53.55	56.00	-2.45	QP
0.5060	32.85	10.02	42.87	46.00	-3.13	AVG
1.5020	37.70	10.06	47.76	56.00	-8.24	QP
1.5020	26.34	10.06	36.40	46.00	-9.60	AVG
1.9858	38.95	10.06	49.01	56.00	-6.99	QP
1.9858	26.91	10.06	36.97	46.00	-9.03	AVG

**Remark:**

1. All readings are Quasi-Peak and Average values.
2. Factor = Insertion Loss + Cable Loss.

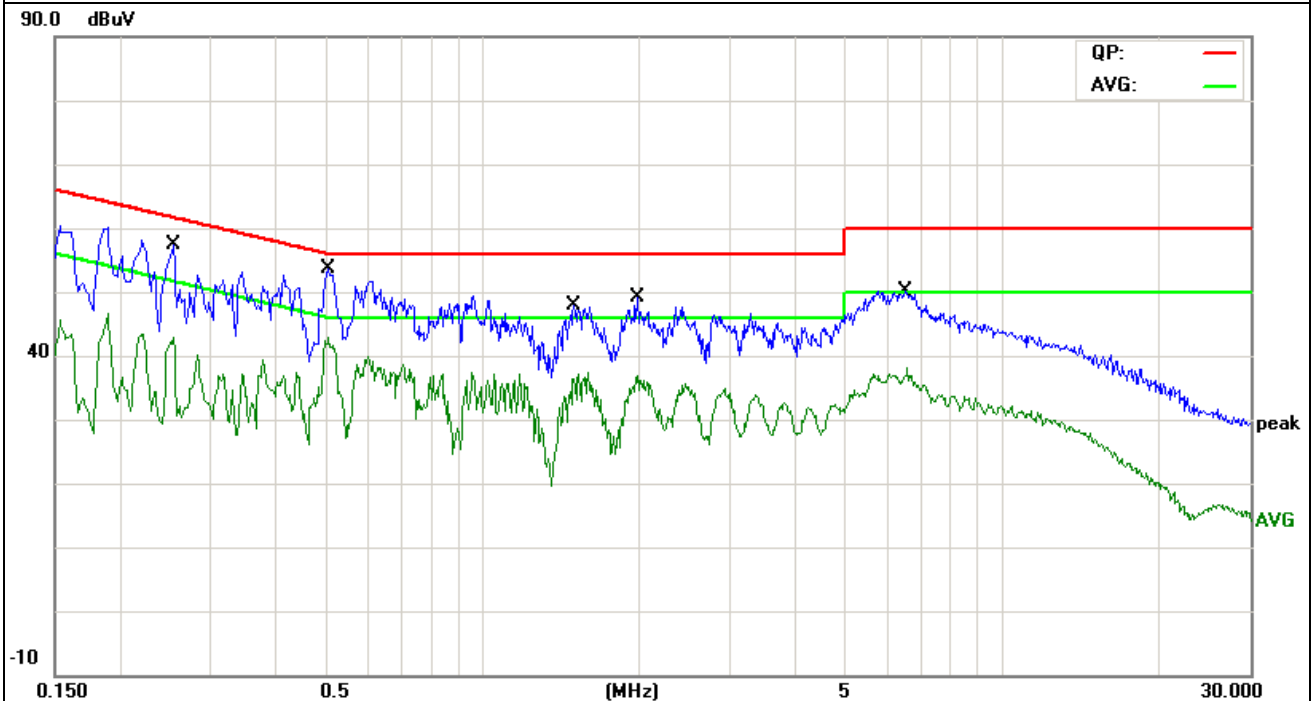

EUT :	Gadgetree Lighted Geode Speaker	Model Name. :	8046922
Temperature :	26 °C	Relative Humidity :	54%
Pressure :	1010hPa	Phase :	N
Test Voltage :	AC120V/60Hz	Test Mode :	Mode 4

Frequency (MHz)	Meter Reading (dBµV)	Factor (dB)	Emission Level (dBµV)	Limits (dBµV)	Margin (dB)	Detector Type
0.1539	47.23	10.12	57.35	65.78	-8.43	QP
0.1539	34.58	10.12	44.70	55.78	-11.08	AVG
0.2140	45.40	10.12	55.52	63.04	-7.52	QP
0.2140	34.28	10.12	44.40	53.04	-8.64	AVG
0.2819	45.05	10.09	55.14	60.76	-5.62	QP
0.2819	31.36	10.09	41.45	50.76	-9.31	AVG
0.4700	40.17	10.03	50.20	56.51	-6.31	QP
0.4700	25.08	10.03	35.11	46.51	-11.40	AVG

Remark:

1. All readings are Quasi-Peak and Average values.
2. Factor = Insertion Loss + Cable Loss.

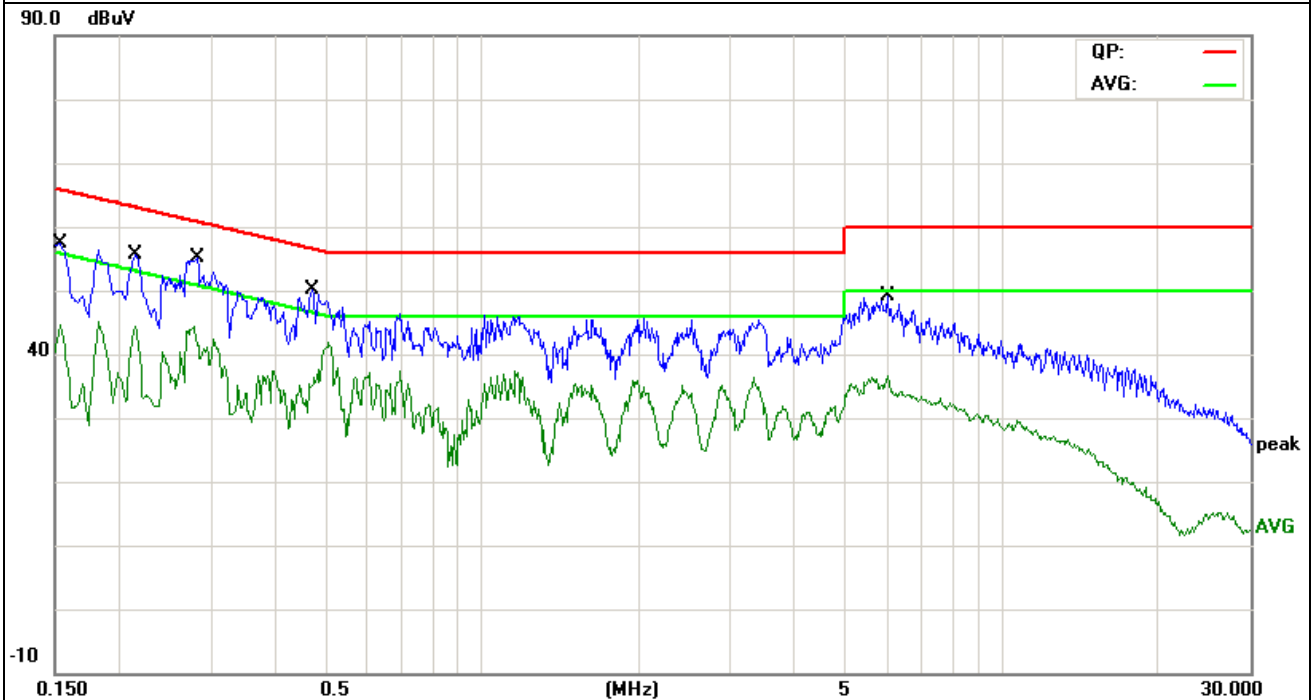



### 3.2 RADIATED EMISSION MEASUREMENT

#### 3.2.1 RADIATED EMISSION LIMITS

20dBc in any 100 kHz bandwidth outside the operating frequency band. In case the emission fall within the restricted band specified on 15.205(a), then the 15.209(a) limit in the table below has to be followed.

Frequencies (MHz)	Field Strength (micorvolts/meter)	Measurement Distance (meters)
0.009~0.490	2400/F(KHz)	300
0.490~1.705	24000/F(KHz)	30
1.705~30.0	30	30
30~88	100	3
88~216	150	3
216~960	200	3
Above 960	500	3

Spectrum Parameter	Setting
Attenuation	Auto
Start Frequency	1000 MHz
Stop Frequency	10th carrier harmonic
RB / VB (emission in restricted band)	1 MHz / 1 MHz for Peak, 1 MHz / 10Hz for Average

Receiver Parameter	Setting
Attenuation	Auto
Start ~ Stop Frequency	9kHz~150kHz / RB 200Hz for QP
Start ~ Stop Frequency	150kHz~30MHz / RB 9kHz for QP
Start ~ Stop Frequency	30MHz~1000MHz / RB 120kHz for QP

#### 3.2.2 TEST PROCEDURE

- a. The measuring distance of at 3 m shall be used for measurements at frequency up to 1GHz. For frequencies above 1GHz, any suitable measuring distance may be used.
- b. The EUT was placed on the top of a rotating table 0.8 meters above the ground at a 3 meter open area test site. The table was rotated 360 degrees to determine the position of the highest radiation.
- c. The height of the equipment or of the substitution antenna shall be 0.8 m; the height of the test antenna shall vary between 1 m to 4 m. Both horizontal and vertical polarizations of the antenna are set to make the measurement.
- d. The initial step in collecting conducted emission data is a spectrum analyzer peak detector mode pre-scanning the measurement frequency range. Significant peaks are then marked and then Quasi Peak detector mode re-measured.
- e. If the Peak Mode measured value compliance with and lower than Quasi Peak Mode Limit, the EUT shall be deemed to meet QP Limits and then no additional QP Mode measurement performed.
- f. For the actual test configuration, please refer to the related Item –EUT Test Photos.

Note:

Both horizontal and vertical antenna polarities were tested and performed pretest to three orthogonal axis. The worst case emissions were reported

**3.2.3 DEVIATION FROM TEST STANDARD**

No deviation

### 3.2.4 TEST SETUP

#### (A) Radiated Emission Test-Up Frequency Below 30MHz

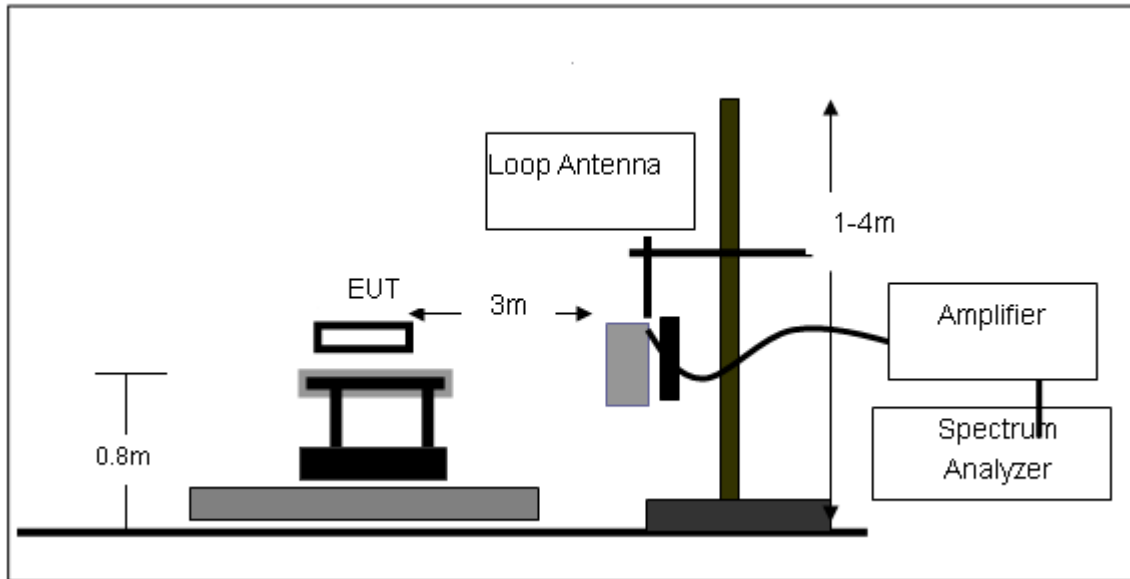

#### (B) Radiated Emission Test-Up Frequency 30MHz~1GHz

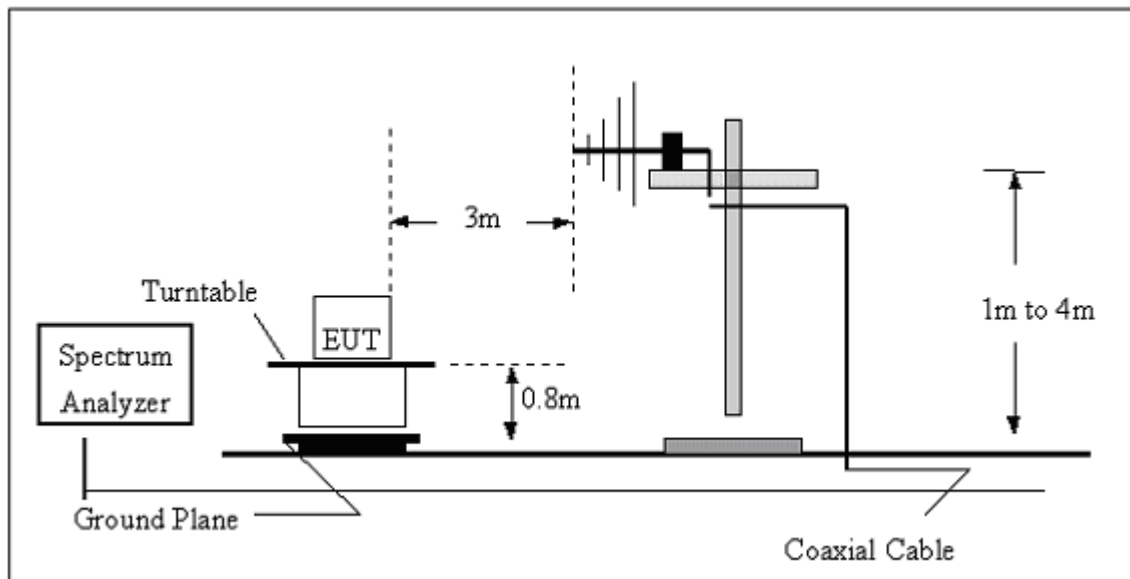

(C) Radiated Emission Test-Up Frequency Above 1GHz

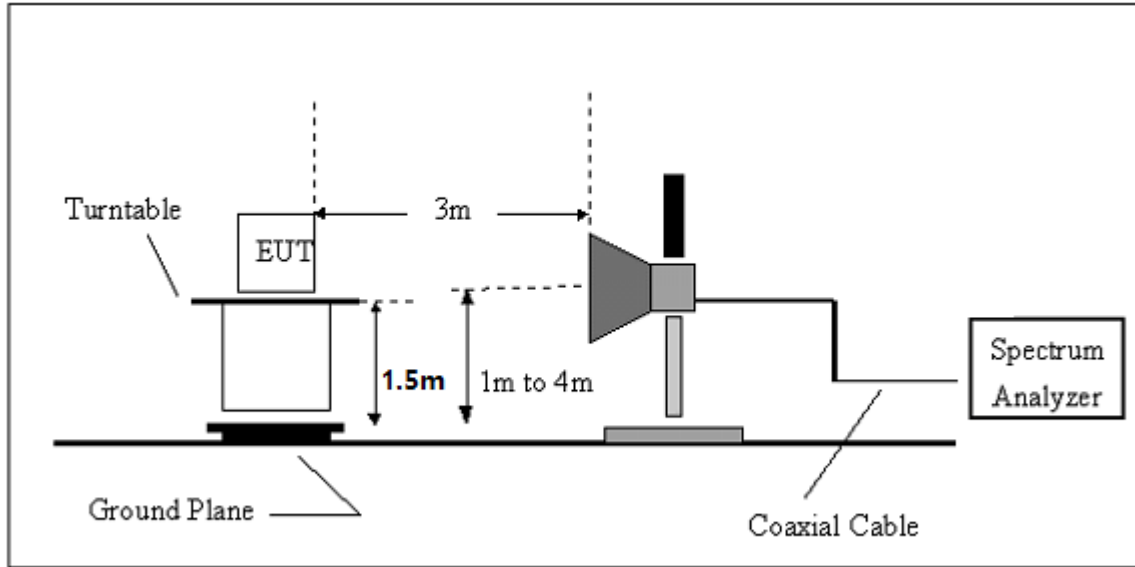

**3.2.5 EUT OPERATING CONDITIONS**

The EUT tested system was configured as the statements of 2.4 Unless otherwise a special operating condition is specified in the follows during the testing.

**3.2.6 TEST RESULTS (BELOW 30 MHZ)**

EUT :	Gadgetree Lighted Geode Speaker	Model Name :	8046922
Temperature :	20 °C	Relative Humidity :	48%
Pressure :	1010 hPa	Polarization :	---
Test Voltage :	DC 3.7V		
Test Mode :	Mode 4		

Freq.	Reading	Limit	Margin	State
(MHz)	(dBuV/m)	(dBuV/m)	(dB)	P/F
--	--	--	--	PASS
--	--	--	--	PASS

**NOTE:**

The amplitude of spurious emissions which are attenuated by more than 20dB below the permissible value has no need to be reported.

Distance extrapolation factor =  $40 \log(\text{specific distance}/\text{test distance})(\text{dB})$ ;

Limit line = specific limits(dBuv) + distance extrapolation factor.

### 3.2.7 TEST RESULTS (BETWEEN 30M – 1000 MHZ)

EUT :	Gadgetree Lighted Geode Speaker	Model Name :	8046922
Temperature :	20 °C	Relative Humidity :	48%
Pressure :	1010 hPa	Polarization :	Horizontal
Test Voltage :	DC 3.7V		
Test Mode :	Mode 4		

Frequency (MHz)	Meter Reading (dBµV)	Factor (dB)	Emission Level (dBµV/m)	Limits (dBµV/m)	Margin (dB)	Detector Type
83.8156	45.61	-18.13	27.48	40.00	-12.52	QP
119.8556	48.05	-14.72	33.33	43.50	-10.17	QP
239.9874	49.18	-14.49	34.69	46.00	-11.31	QP
300.3672	46.29	-12.57	33.72	46.00	-12.28	QP
801.7863	42.11	-2.49	39.62	46.00	-6.38	QP
962.1623	42.49	-0.42	42.07	54.00	-11.93	QP

Remark:  
 Factor = Antenna Factor + Cable Loss – Pre-amplifier.  
 All interfaces was connected, and BT TX mode was link.

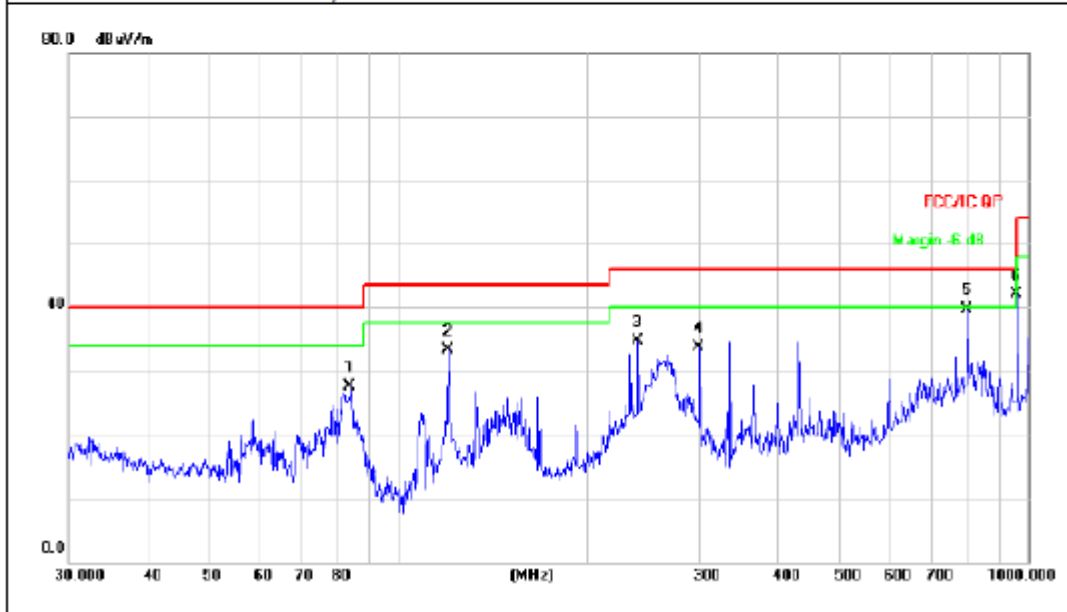

EUT :	Gadgetree Lighted Geode Speaker	Model Name :	8046922
Temperature :	20 °C	Relative Humidity :	48%
Pressure :	1010 hPa	Polarization :	Vertical
Test Voltage :	DC 3.7V		
Test Mode :	Model 4		

Frequency (MHz)	Meter Reading (dBµV)	Factor (dB)	Emission Level (dBµV/m)	Limits (dBµV/m)	Margin (dB)	Detector Type
33.0950	45.64	-8.39	37.25	40.00	-2.75	QP
42.8998	44.31	-9.21	35.10	40.00	-4.90	QP
82.9385	54.08	-18.12	35.96	40.00	-4.04	QP
119.8556	50.80	-14.72	36.08	43.50	-7.42	QP
336.0352	47.52	-11.66	35.86	46.00	-10.14	QP
601.4265	43.66	-5.66	38.00	46.00	-8.00	QP

Remark:  
 Factor = Antenna Factor + Cable Loss – Pre-amplifier.  
 All interfaces was connected, and BT TX mode was link.

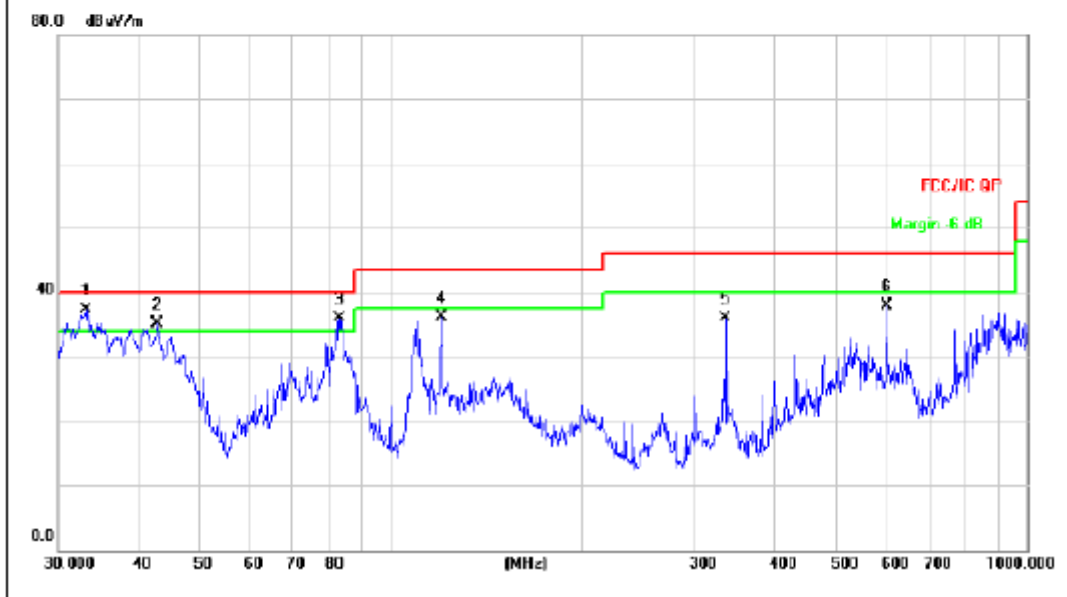

### 3.2.8 TEST RESULTS (ABOVE 1000 MHZ)

EUT :	Gadgetree Lighted Geode Speaker	Model Name :	8046922
Temperature :	20 °C	Relative Humidity :	48%
Pressure :	1010 hPa	Test Voltage :	DC 3.7V

Mode: GFSK (Wost case)

#### Low channel(2402MHz)

Frequency (MHz)	Meter Reading (dBµV)	Factor (dB)	Emission Level (dBµV/m)	Limits (dBµV/m)	Margin (dB)	Detector Type	Polarity (H/V)
4804.256	63.01	-3.64	59.37	74	-14.63	peak	H
4804.256	48.59	-3.64	44.95	54	-9.05	AVG	H
4804.132	65.91	-3.64	62.27	74	-11.73	peak	V
4804.132	51.97	-3.64	48.33	54	-5.67	AVG	V

#### Middel channel(2441MHz)

Frequency (MHz)	Meter Reading (dBµV)	Factor (dB)	Emission Level (dBµV/m)	Limits (dBµV/m)	Margin (dB)	Detector Type	Polarity (H/V)
4882.625	69.47	-3.67	65.8	74	-8.2	peak	H
4882.625	49.74	-3.67	46.07	54	-7.93	AVG	H
4882.223	60.7	-3.67	57.03	74	-16.97	peak	V
4882.223	49.55	-3.67	45.88	54	-8.12	AVG	V

#### High channel (2480MHz)

Frequency (MHz)	Meter Reading (dBµV)	Factor (dB)	Emission Level (dBµV/m)	Limits (dBµV/m)	Margin (dB)	Detector Type	Polarity (H/V)
4960.41	59.53	-3.59	55.94	74	-18.06	peak	H
4960.41	49.35	-3.59	45.76	54	-8.24	AVG	H
4960.237	63.53	-3.59	59.94	74	-14.06	peak	V
4960.237	50.98	-3.59	47.39	54	-6.61	AVG	V

Note:

1. The testing has been conformed to  $10 \times 2480 \text{MHz} = 24800 \text{MHz}$ .
2. All other emission more than 30dB below the limit.



### 3.2.9 TEST RESULTS (RESTRICTED BANDS REQUIREMENTS)

Hopping OFF

Frequency (MHz)	Meter Reading (dBμV)	Factor (dB)	Emission Level (dBμV/m)	Limits (dBμV/m)	Margin (dB)	Detector Type	Comment
GFSK							
2399.9	66.97	-12.99	53.98	74	-20.02	PK	Vertical
2399.9	52.76	-12.99	39.77	54	-14.23	AV	Vertical
2399.9	68.29	-12.99	55.30	74	-18.70	PK	Horizontal
2399.9	51.76	-12.99	38.77	54	-15.23	AV	Horizontal
2483.6	68.75	-12.78	55.97	74	-18.03	PK	Vertical
2483.6	51.96	-12.78	39.18	54	-14.82	AV	Vertical
2483.6	68.63	-12.78	55.85	74	-18.15	PK	Horizontal
2483.6	52.02	-12.78	39.24	54	-14.76	AV	Horizontal
π/4-DQPSK							
2399.9	69.27	-12.99	56.28	74	-17.72	PK	Vertical
2399.9	52.37	-12.99	39.38	54	-14.62	AV	Vertical
2399.9	68.25	-12.99	55.26	74	-18.74	PK	Horizontal
2399.9	53.11	-12.99	40.12	54	-13.88	AV	Horizontal
2483.6	68.80	-12.78	56.02	74	-17.98	PK	Vertical
2483.6	54.14	-12.78	41.36	54	-12.64	AV	Vertical
2483.6	69.09	-12.78	56.31	74	-17.69	PK	Horizontal
2483.6	52.25	-12.78	39.47	54	-14.53	AV	Horizontal
8DPSK							
2399.9	69.18	-12.99	56.19	74	-17.81	PK	Vertical
2399.9	52.85	-12.99	39.86	54	-14.14	AV	Vertical
2399.9	67.90	-12.99	54.91	74	-19.09	PK	Horizontal
2399.9	53.49	-12.99	40.50	54	-13.50	AV	Horizontal
2483.6	69.11	-12.78	56.33	74	-17.67	PK	Vertical
2483.6	52.55	-12.78	39.77	54	-14.23	AV	Vertical
2483.6	69.31	-12.78	56.53	74	-17.47	PK	Horizontal
2483.6	52.56	-12.78	39.78	54	-14.22	AV	Horizontal

Low measurement frequencies is range from 2310 to 2400 MHz, high measurement frequencies is range from 2483.5 to 2500 MHz. Only show the worst point data of the emissions in the frequency 2310-2400 MHz and 2483.5-2500 MHz.

Hopping on

Frequency (MHz)	Meter Reading (dBμV)	Factor (dB)	Emission Level (dBμV/m)	Limits (dBμV/m)	Margin (dB)	Detector Type	Comment
GFSK							
2390.0	66.71	-12.99	53.72	74	-20.28	PK	Vertical
2390.0	54.32	-12.99	41.33	54	-12.67	AV	Vertical
2390.0	65.60	-12.99	52.61	74	-21.39	PK	Horizontal
2390.0	51.52	-12.99	38.53	54	-15.47	AV	Horizontal
2483.5	65.85	-12.78	53.07	74	-20.93	PK	Vertical
2483.5	51.89	-12.78	39.11	54	-14.89	AV	Vertical
2483.5	66.54	-12.78	53.76	74	-20.24	PK	Horizontal
2483.5	53.03	-12.78	40.25	54	-13.75	AV	Horizontal
π/4-DQPSK							
2390.0	66.88	-12.99	53.89	74	-20.11	PK	Vertical
2390.0	54.10	-12.99	41.11	54	-12.89	AV	Vertical
2390.0	66.08	-12.99	53.09	74	-20.91	PK	Horizontal
2390.0	51.51	-12.99	38.52	54	-15.48	AV	Horizontal
2483.5	66.04	-12.78	53.26	74	-20.74	PK	Vertical
2483.5	52.04	-12.78	39.26	54	-14.74	AV	Vertical
2483.5	66.62	-12.78	53.84	74	-20.16	PK	Horizontal
2483.5	52.76	-12.78	39.98	54	-14.02	AV	Horizontal
8DPSK							
2390.0	66.36	-12.99	53.37	74	-20.63	PK	Vertical
2390.0	54.13	-12.99	41.14	54	-12.86	AV	Vertical
2390.0	65.58	-12.99	52.59	74	-21.41	PK	Horizontal
2390.0	51.35	-12.99	38.36	54	-15.64	AV	Horizontal
2483.5	65.97	-12.78	53.19	74	-20.81	PK	Vertical
2483.5	51.96	-12.78	39.18	54	-14.82	AV	Vertical
2483.5	67.12	-12.78	54.34	74	-19.66	PK	Horizontal
2483.5	52.75	-12.78	39.97	54	-14.03	AV	Horizontal

Low measurement frequencies is range from 2310 to 2400 MHz, high measurement frequencies is range from 2483.5 to 2500 MHz. Only show the worst point data of the emissions in the frequency 2310-2400 MHz and 2483.5-2500 MHz.

#### 4. NUMBER OF HOPPING CHANNEL

##### 4.1 APPLIED PROCEDURES / LIMIT

FCC Part15 (15.247) , Subpart C				
Section	Test Item	Limit	Frequency Range (MHz)	Result
15.247 (a)(1)(iii)	Number of Hopping Channel	≥15	2400-2483.5	PASS

Spectrum Parameters	Setting
Attenuation	Auto
Span Frequency	> Operating Frequency Range
RB	100 kHz
VB	100 kHz
Detector	Peak
Trace	Max Hold
Sweep Time	Auto

##### 4.1.1 TEST PROCEDURE

- a. The EUT was directly connected to the spectrum analyzer and antenna output port as show in the block diagram below,
- b. Spectrum Setting : RBW= 100KHz, VBW=100KHz, Sweep time = Auto.

##### 4.1.2 DEVIATION FROM STANDARD

No deviation.

##### 4.1.3 TEST SETUP



##### 4.1.4 EUT OPERATION CONDITIONS

The EUT tested system was configured as the statements of 2.4 Unless otherwise a special operating condition is specified in the follows during the testing.

### 4.1.5 TEST RESULTS

EUT :	Gadgetree Lighted Geode Speaker	Model Name :	8046922
Temperature :	25 °C	Relative Humidity :	60%
Pressure :	1015 hPa	Test Voltage :	DC 3.7V
Test Mode :	Hopping Mode		

Number of Hopping Channel	79
---------------------------	----

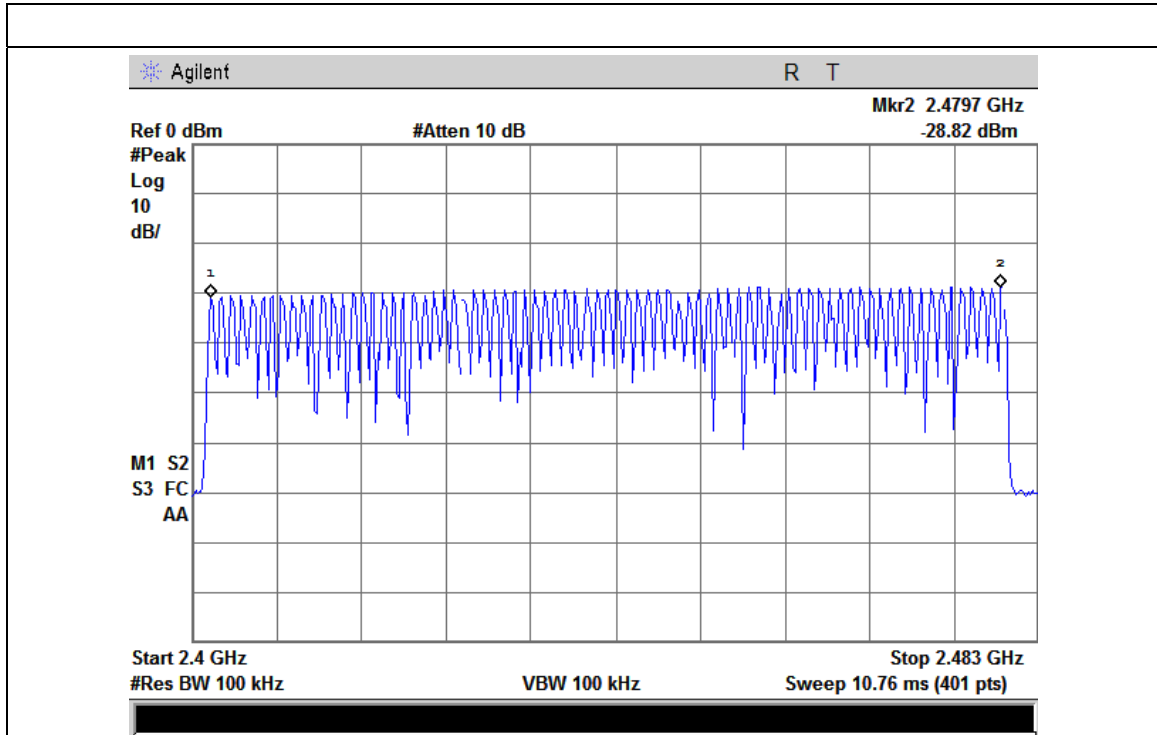

## 5. AVERAGE TIME OF OCCUPANCY

### 5.1 APPLIED PROCEDURES / LIMIT

FCC Part15 (15.247) , Subpart C				
Section	Test Item	Limit	Frequency Range (MHz)	Result
15.247 (a)(1)(iii)	Average Time of Occupancy	0.4sec	2400-2483.5	PASS

#### 5.1.1 TEST PROCEDURE

- a. The transmitter output (antenna port) was connected to the spectrum analyzer
- b. Set RBW of spectrum analyzer to 1MHz and VBW to 1MHz.
- c. Use a video trigger with the trigger level set to enable triggering only on full pulses.
- d. Sweep Time is more than once pulse time.
- e. Set the center frequency on any frequency would be measure and set the frequency span to zero span.
- f. Measure the maximum time duration of one single pulse.
- g. Set the EUT for DH5, DH3 and DH1 packet transmitting.
- h. Measure the maximum time duration of one single pulse.
- i. A Period Time = (channel number)\*0.4  
 DH1 Time Slot: Reading \* (1600/2)\*31.6/(channel number)  
 DH3 Time Slot: Reading \* (1600/4)\*31.6/(channel number)  
 DH5 Time Slot: Reading \* (1600/6)\*31.6/(channel number)

#### 5.1.2 DEVIATION FROM STANDARD

No deviation.

### 5.1.3 TEST SETUP



### 5.1.4 EUT OPERATION CONDITIONS

The EUT tested system was configured as the statements of 2.4 Unless otherwise a special operating condition is specified in the follows during the testing.

### 5.1.5 TEST RESULTS

EUT :	Gadgetree Lighted Geode Speaker	Model Name :	8046922
Temperature :	25 °C	Relative Humidity :	60%
Pressure :	1012 hPa	Test Voltage :	DC 3.7V
Test Mode :	CH39-DH5 ,2DH5,3DH5		

Data Packet	Frequency	Pulse Duration (ms)	Dwell Time (s)	Limits (s)
DH5	2441 MHz	2.95	0.31	0.4
2DH5	2441 MHz	3.10	0.33	0.4
3DH5	2441 MHz	3.15	0.34	0.4

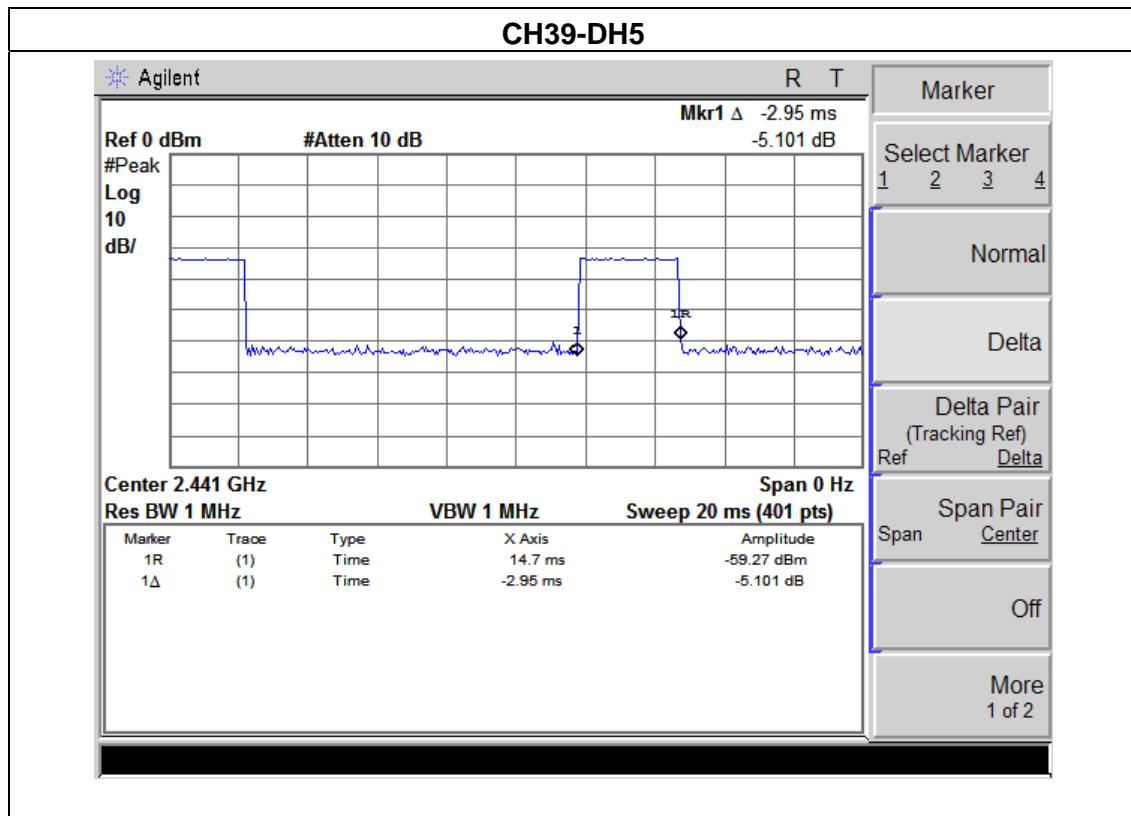

### CH39-2DH5

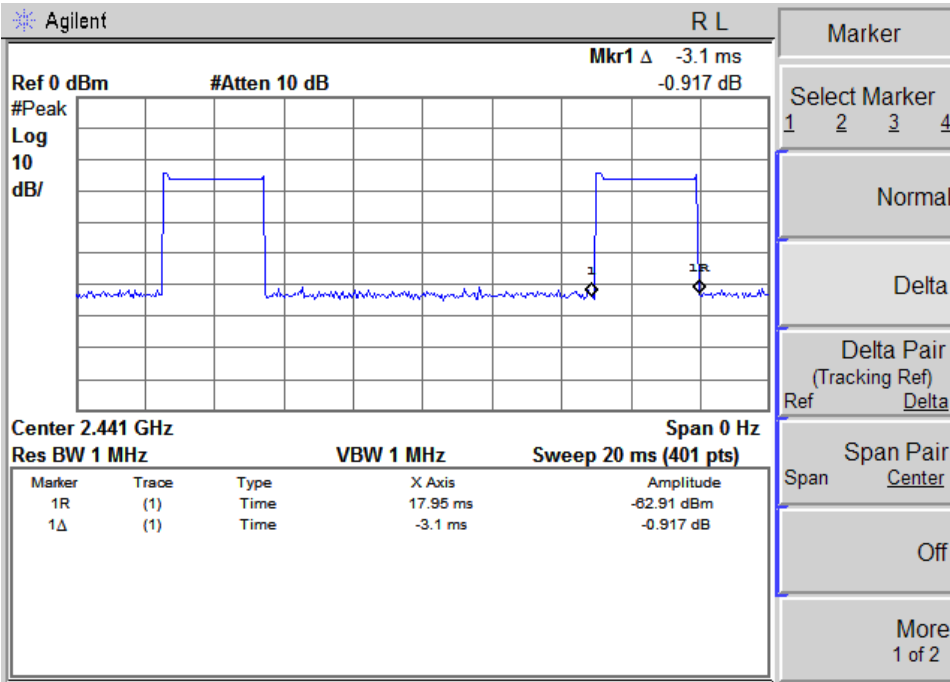

### CH39-3DH5

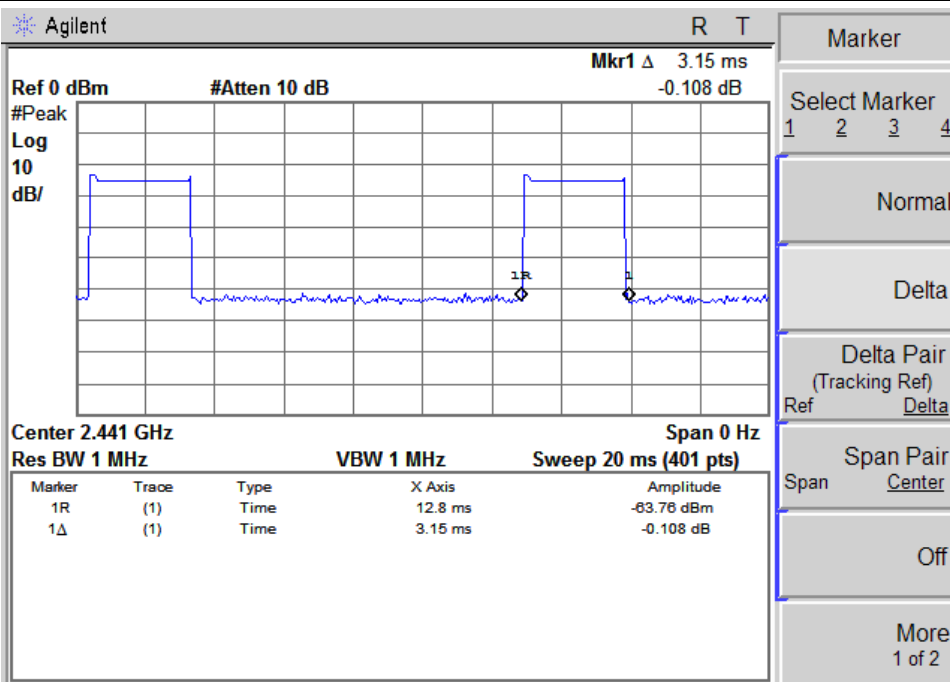



EUT :	Gadgetree Lighted Geode Speaker	Model Name :	8046922
Temperature :	25 °C	Relative Humidity :	60%
Pressure :	1012 hPa	Test Voltage :	DC 3.7V
Test Mode :	CH39-DH3,2DH3,3DH3		

Data Packet	Frequency	Pulse Duration (ms)	Dwell Time (s)	Limits (s)
DH3	2441 MHz	1.75	0.19	0.4
2DH3	2441 MHz	1.80	0.19	0.4
3DH3	2441 MHz	1.80	0.19	0.4

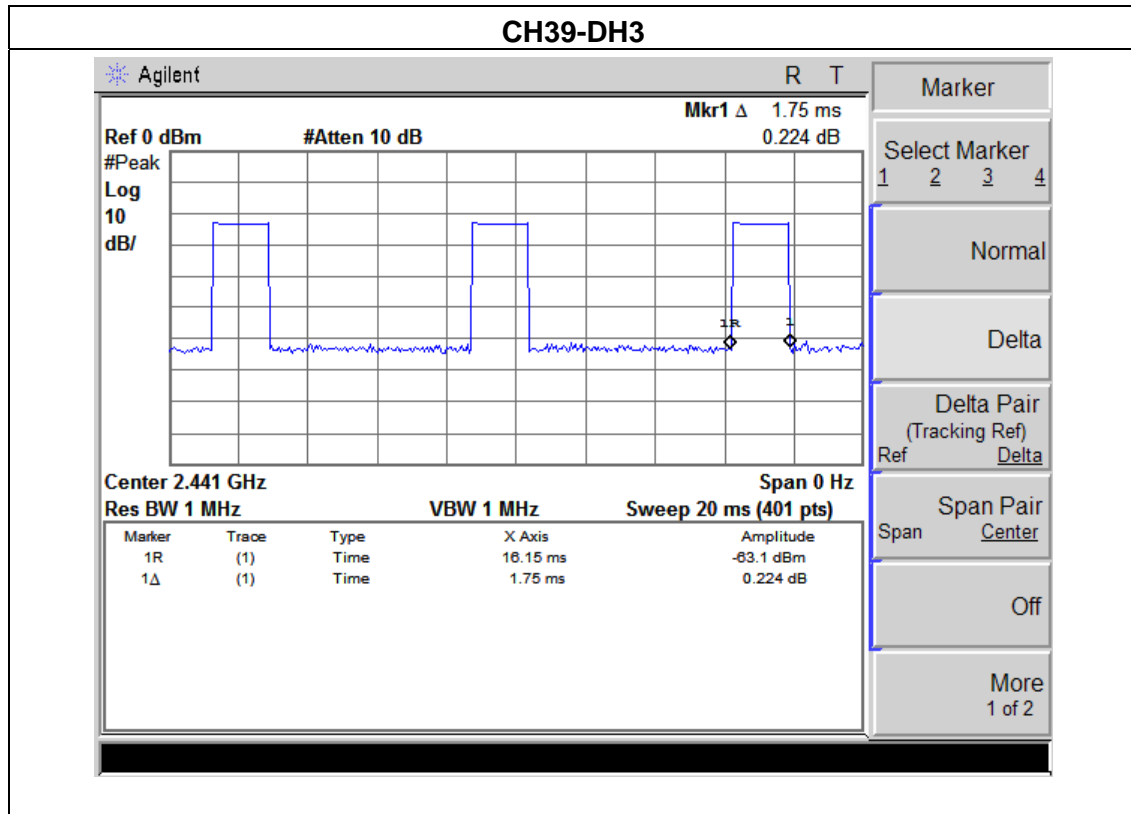

### CH39-2DH3

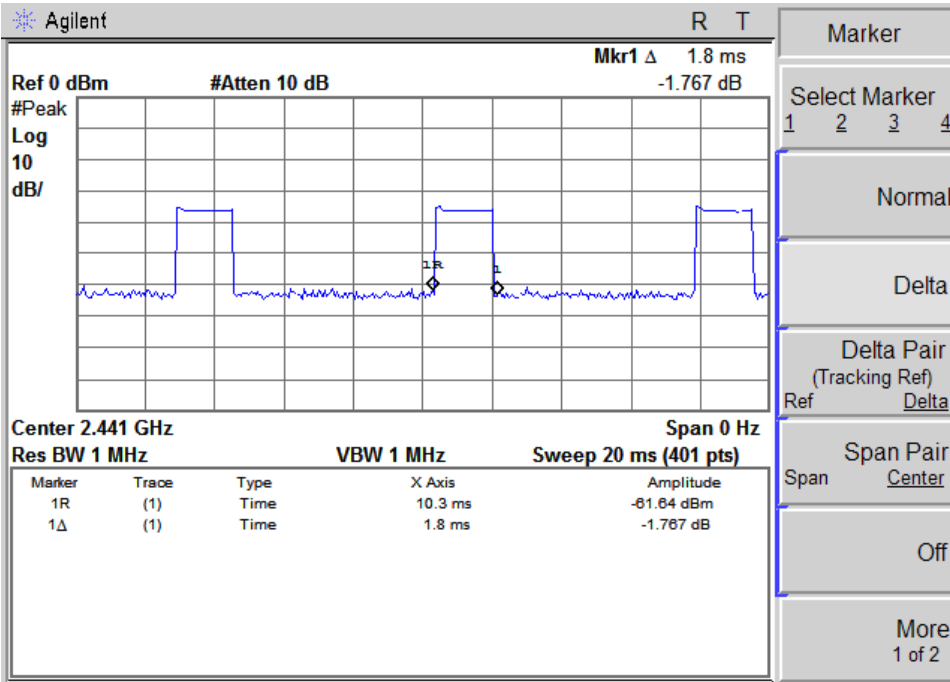

### CH39-3DH3

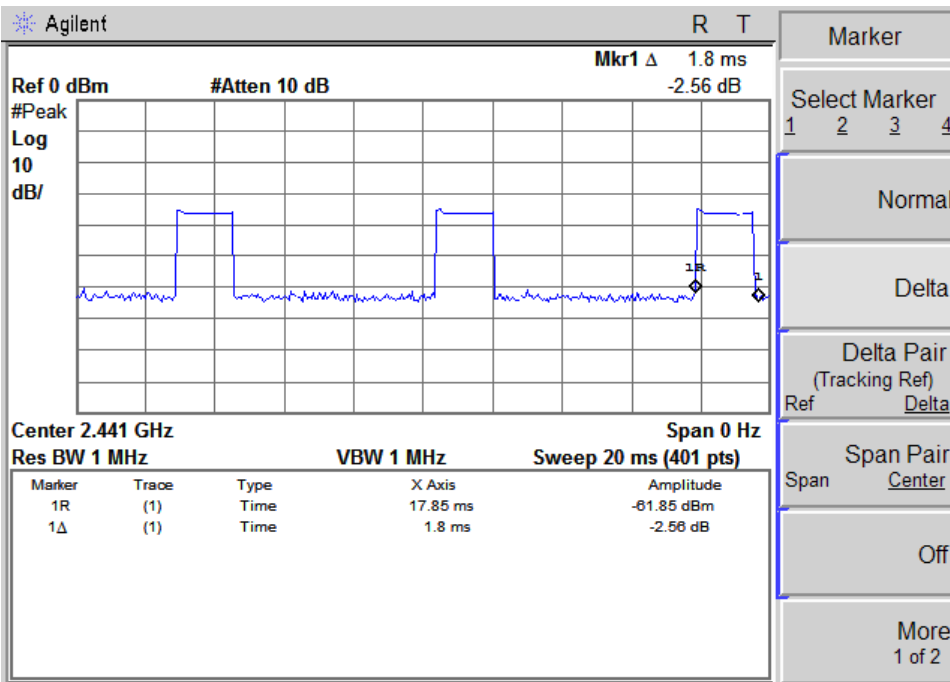

EUT :	Gadgetree Lighted Geode Speaker	Model Name :	8046922
Temperature :	25 °C	Relative Humidity :	60%
Pressure :	1012 hPa	Test Voltage :	DC 3.7V
Test Mode :	CH39-DH1,2DH1,3DH1		

Data Packet	Frequency	Pulse Duration (ms)	Dwell Time (s)	Limits (s)
DH1	2441 MHz	0.46	0.05	0.4
2DH1	2441 MHz	0.45	0.05	0.4
3DH1	2441 MHz	0.45	0.05	0.4

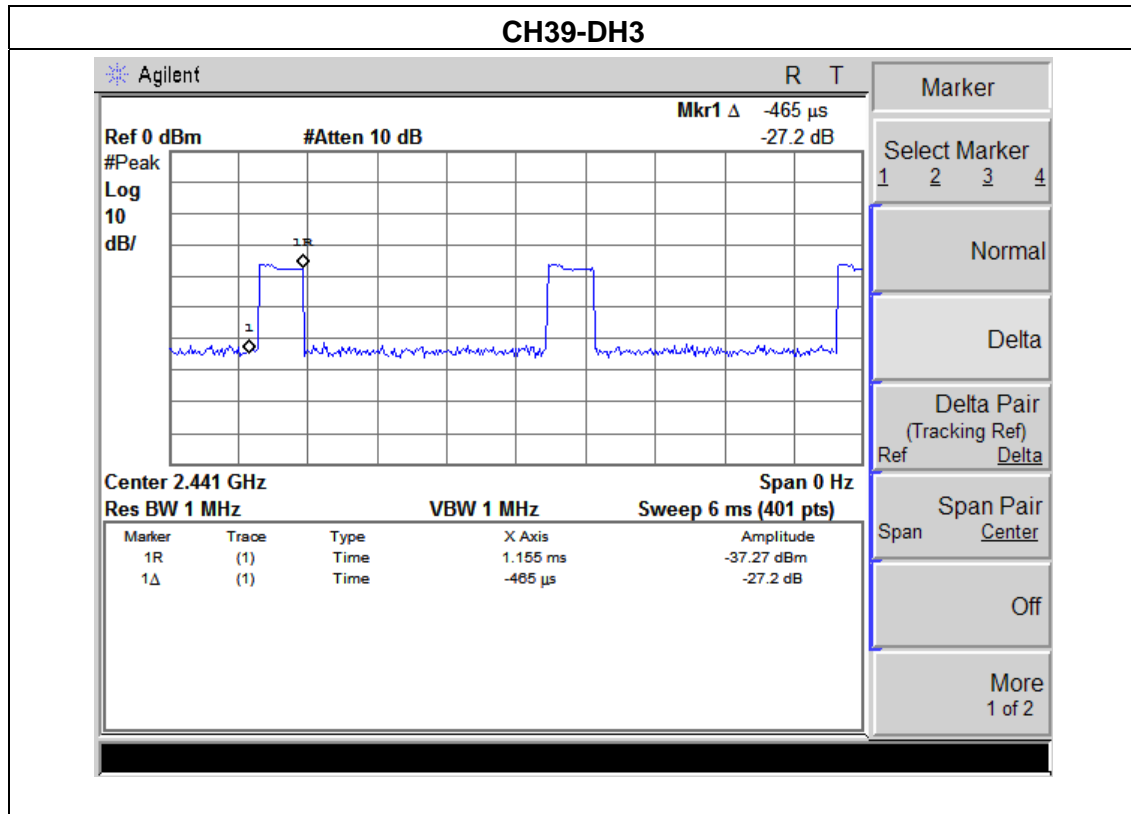

### CH39-2DH3

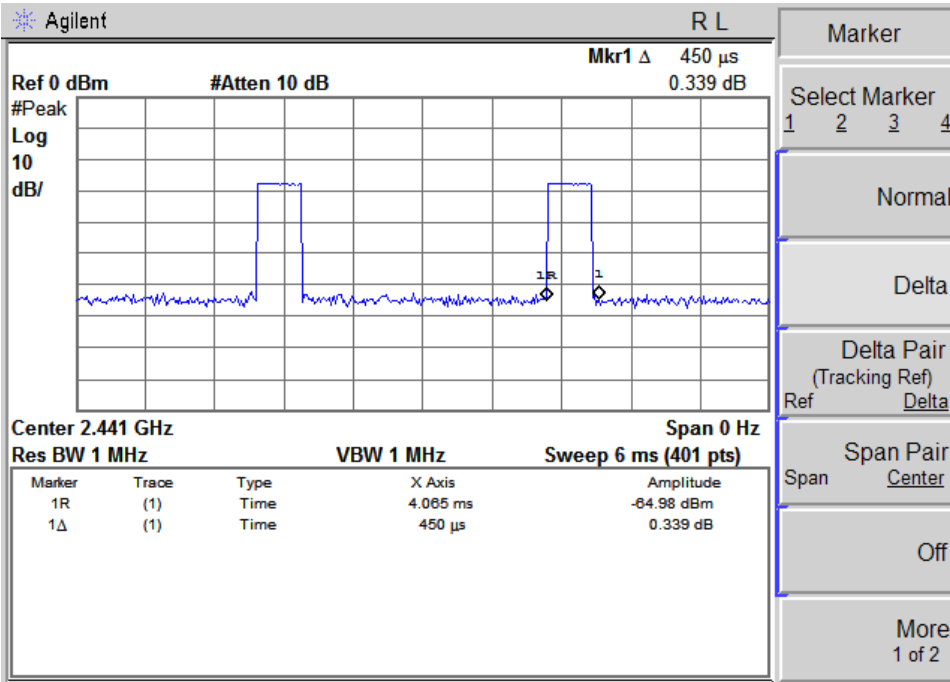

### CH39-3DH3

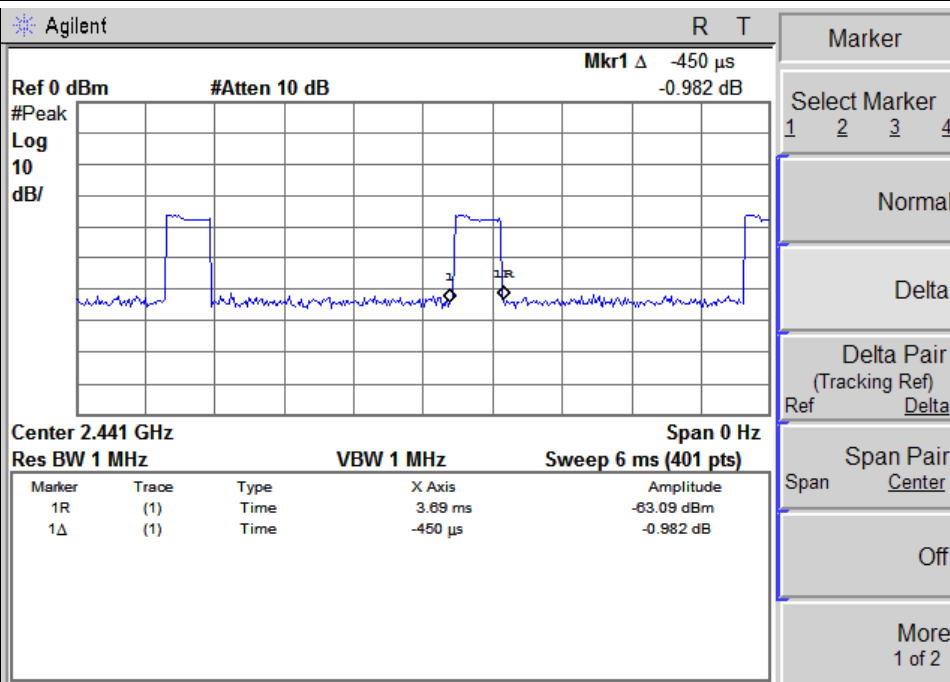

## 6. HOPPING CHANNEL SEPARATION MEASUREMENT

### 6.1 APPLIED PROCEDURES / LIMIT

Frequency hopping systems operating in the 2400-2483.5 MHz band may have hopping channel carrier frequencies that are separated by 25 kHz or two-thirds of the 20 dB bandwidth of the hopping channel, whichever is greater.

Spectrum Parameter	Setting
Attenuation	Auto
Span Frequency	> Measurement Bandwidth or Channel Separation
RB	100 kHz (Channel Separation)
VB	300 kHz (Channel Separation)
Detector	Peak
Trace	Max Hold
Sweep Time	Auto

#### 6.1.1 TEST PROCEDURE

- a. The transmitter output (antenna port) was connected to the spectrum analyser in peak hold mode.
- b. The resolution bandwidth of 100 kHz and the video bandwidth of 300 kHz were utilised for channel separation measurement.

#### 6.1.2 DEVIATION FROM STANDARD

No deviation.

#### 6.1.3 TEST SETUP

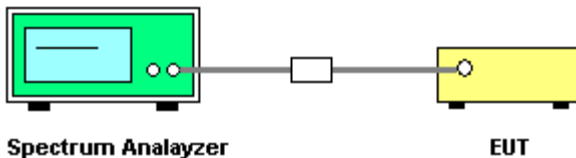

#### 6.1.4 EUT OPERATION CONDITIONS

The EUT was programmed to be in continuously transmitting mode.

### 6.1.5 TEST RESULTS

EUT :	Gadgetree Lighted Geode Speaker	Model Name :	8046922
Temperature :	25 °C	Relative Humidity :	60%
Pressure :	1012 hPa	Test Voltage :	DC 3.7V
Test Mode :	CH00 / CH39 /CH78 (1Mbps Mode)		

Frequency	Ch. Separation (MHz)	Result
2402 MHz	1.020	Complies
2441 MHz	1.010	Complies
2480 MHz	1.020	Complies

Ch. Separation Limits: >20dB bandwidth or >2/3 of 20dB bandwidth

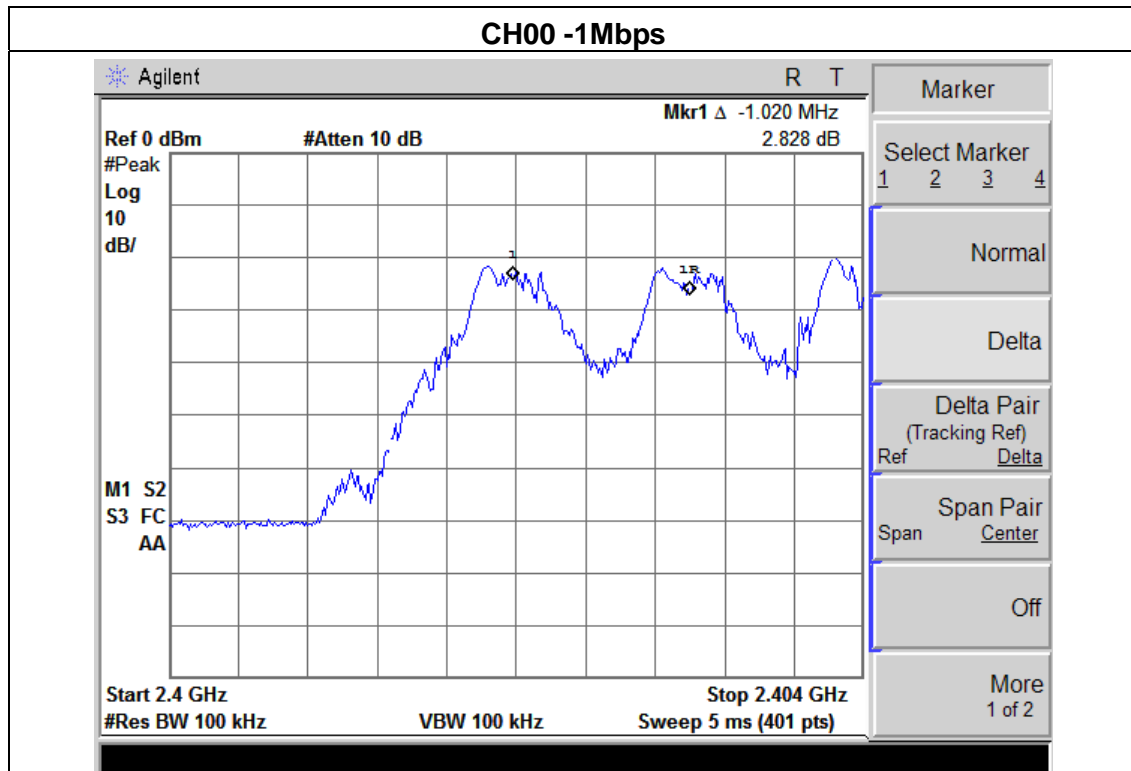

### CH39 -1Mbps

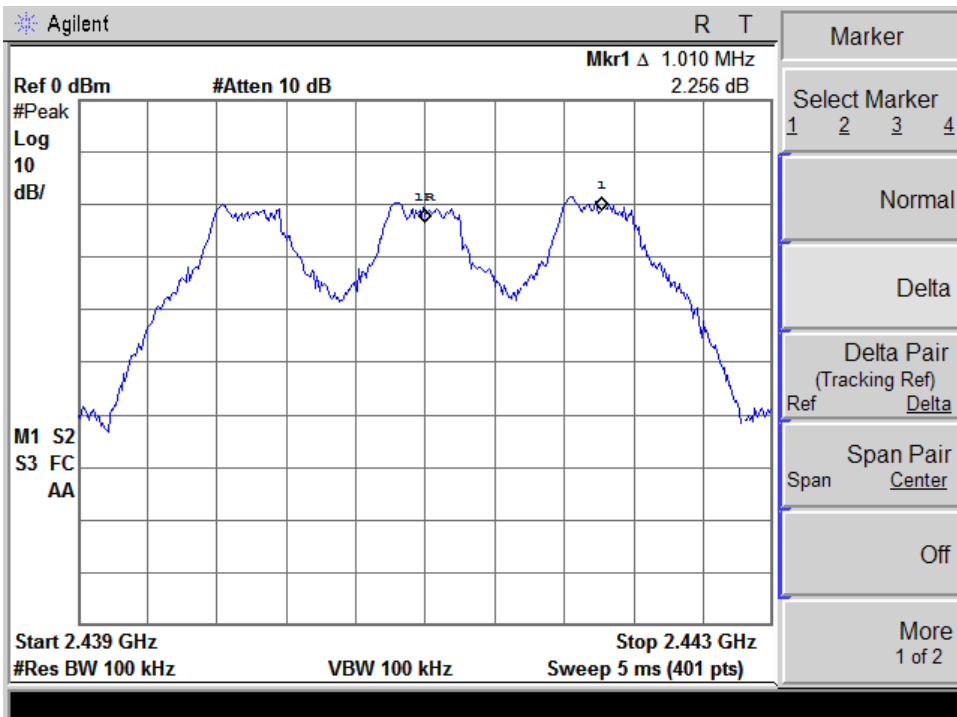

### CH78 -1Mbps

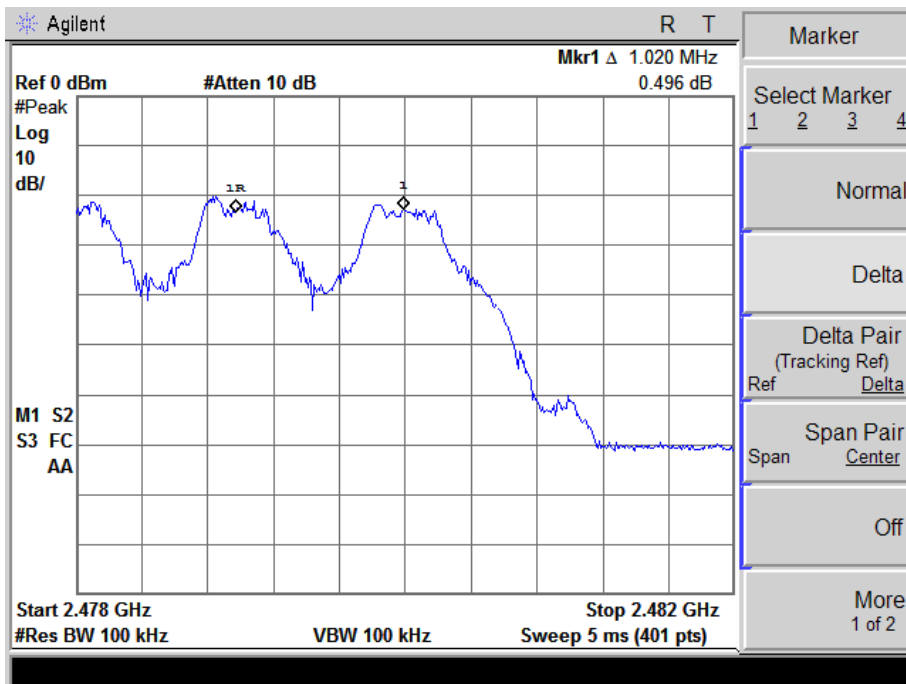

EUT :	Gadgetree Lighted Geode Speaker	Model Name :	8046922
Temperature :	25 °C	Relative Humidity :	60%
Pressure :	1012 hPa	Test Voltage :	DC 3.7V
Test Mode :	CH00 / CH39 /CH78 (2Mbps Mode)		

Frequency	Ch. Separation (MHz)	Result
2402 MHz	1.010	Complies
2441 MHz	1.050	Complies
2480 MHz	1.010	Complies

Ch. Separation Limits: >20dB bandwidth or >2/3 of 20dB bandwidth

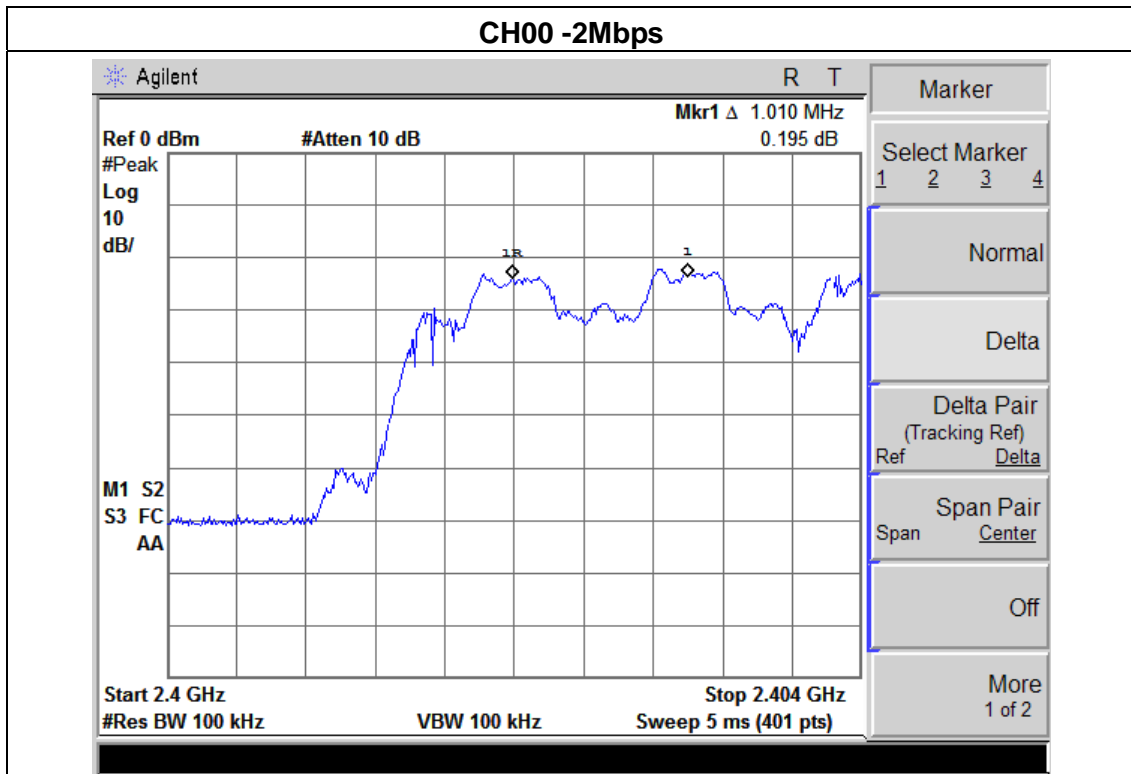



### CH39 -2Mbps

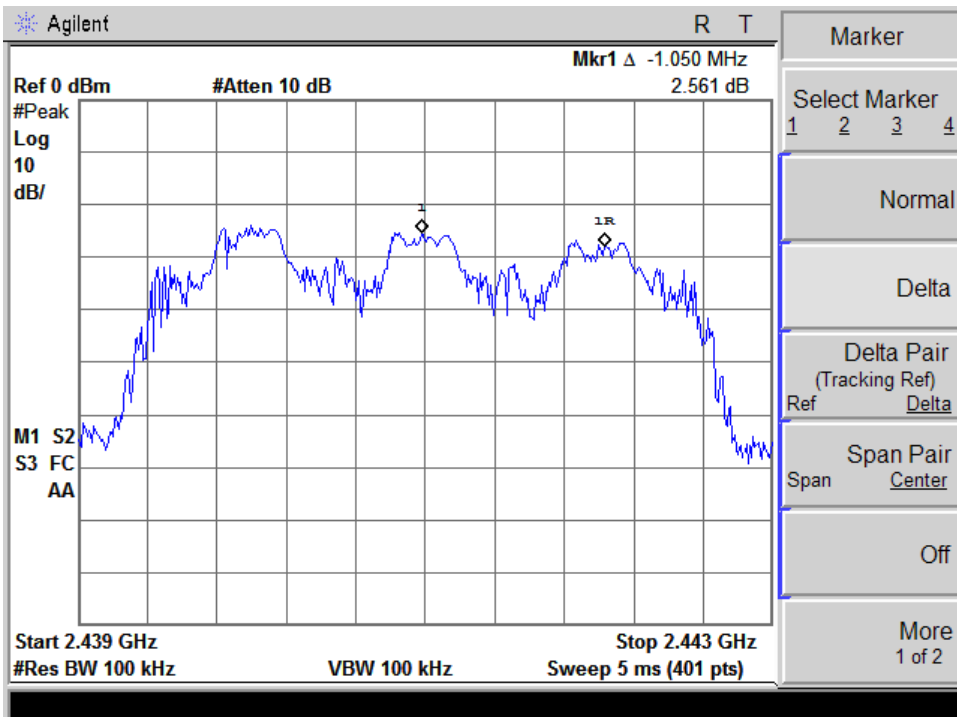

### CH78 -2Mbps

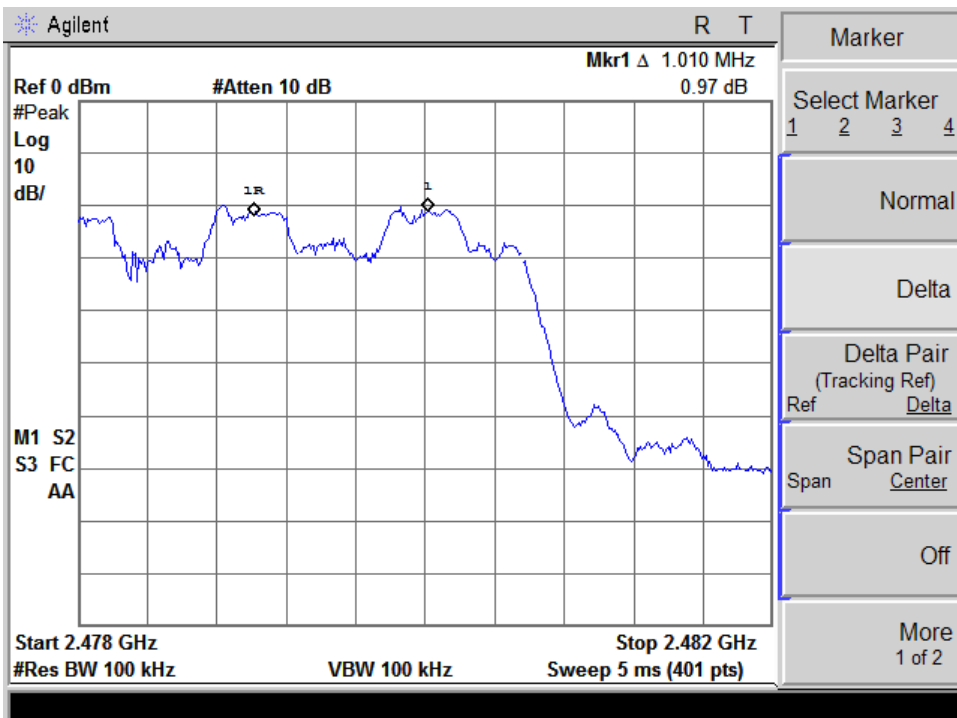

EUT :	Gadgetree Lighted Geode Speaker	Model Name :	8046922
Temperature :	25 °C	Relative Humidity :	60%
Pressure :	1012 hPa	Test Voltage :	DC 3.7V
Test Mode :	CH00 / CH39 /CH78 (3Mbps Mode)		

Frequency	Ch. Separation (MHz)	Result
2402 MHz	1.030	<b>Complies</b>
2441 MHz	1.010	<b>Complies</b>
2480 MHz	1.000	<b>Complies</b>

**Ch. Separation Limits: >20dB bandwidth or >2/3 of 20dB bandwidth**

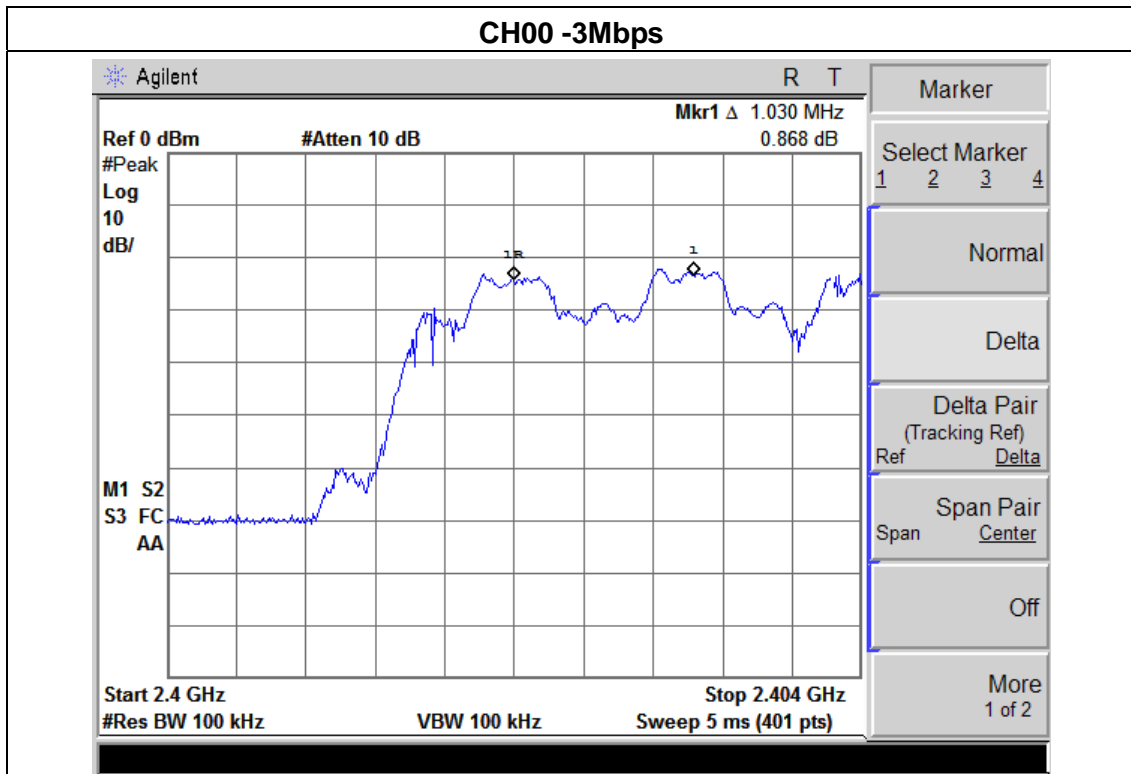

### CH39 -3Mbps

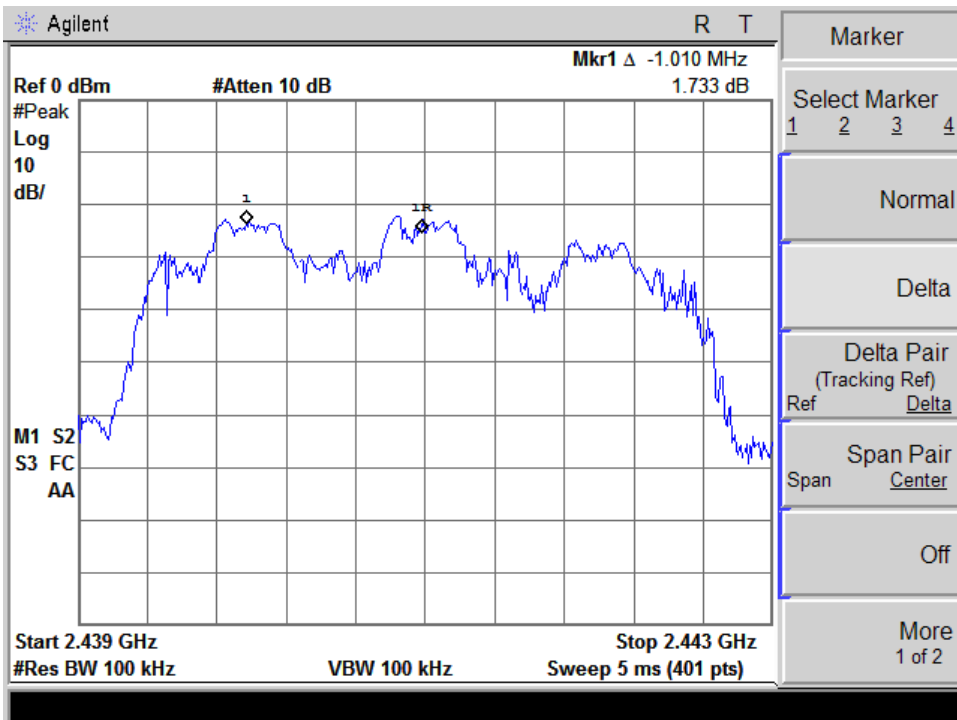

### CH78 -3Mbps

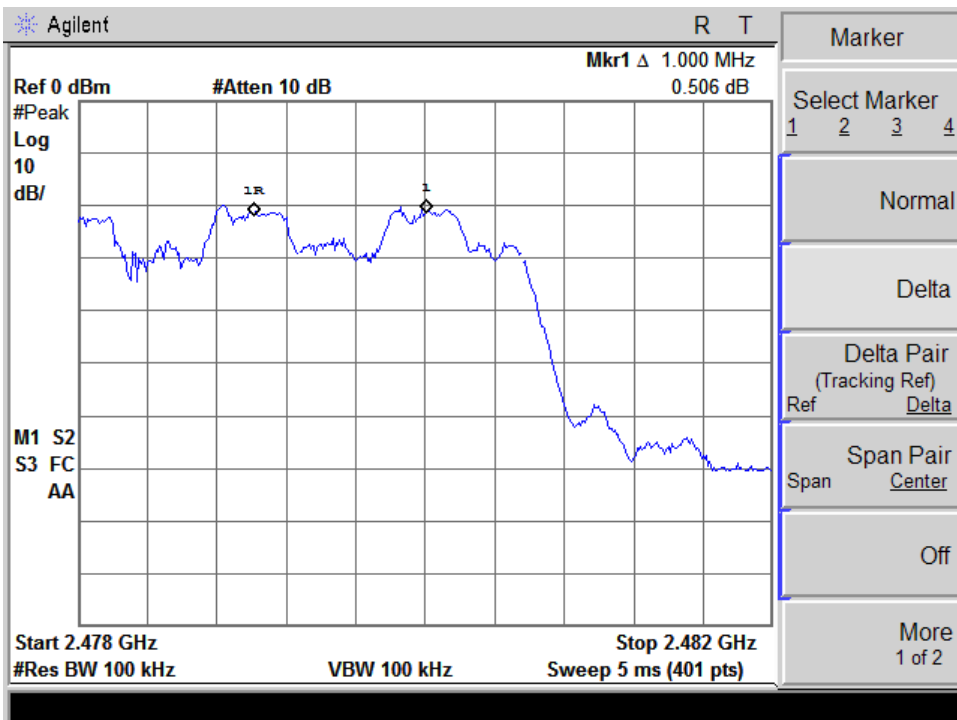

## 7. BANDWIDTH TEST

### 7.1 APPLIED PROCEDURES / LIMIT

FCC Part15 (15.247) , Subpart C				
Section	Test Item	Limit	Frequency Range (MHz)	Result
15.247 (a)(1)	Bandwidth	(20dB bandwidth)	2400-2483.5	PASS

Spectrum Parameter	Setting
Attenuation	Auto
Span Frequency	> Measurement Bandwidth or Channel Separation
RB	30 kHz
VB	100 kHz
Detector	Peak
Trace	Max Hold
Sweep Time	Auto

#### 7.1.1 TEST PROCEDURE

- a. The EUT was directly connected to the spectrum analyzer and antenna output port as show in the block diagram below,
- b. Spectrum Setting : RBW= 100KHz, VBW=100KHz, Sweep time = Auto.

#### 7.1.2 DEVIATION FROM STANDARD

No deviation.

#### 7.1.3 TEST SETUP

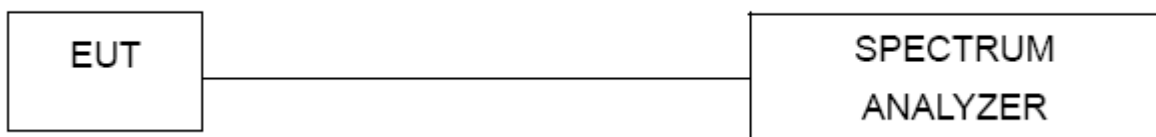

#### 7.1.4 EUT OPERATION CONDITIONS

The EUT tested system was configured as the statements of 2.4 Unless otherwise a special operating condition is specified in the follows during the testing.

### 7.1.5 TEST RESULTS

EUT :	Gadgetree Lighted Geode Speaker	Model Name :	8046922
Temperature :	25 °C	Relative Humidity :	60%
Pressure :	1012 hPa	Test Voltage :	DC 3.7V
Test Mode :	CH00 / CH39 /C78(1Mbps)		

Frequency	20dB Bandwidth (kHz)	Result
2402 MHz	811.21	<b>PASS</b>
2441 MHz	765.78	<b>PASS</b>
2480 MHz	828.75	<b>PASS</b>

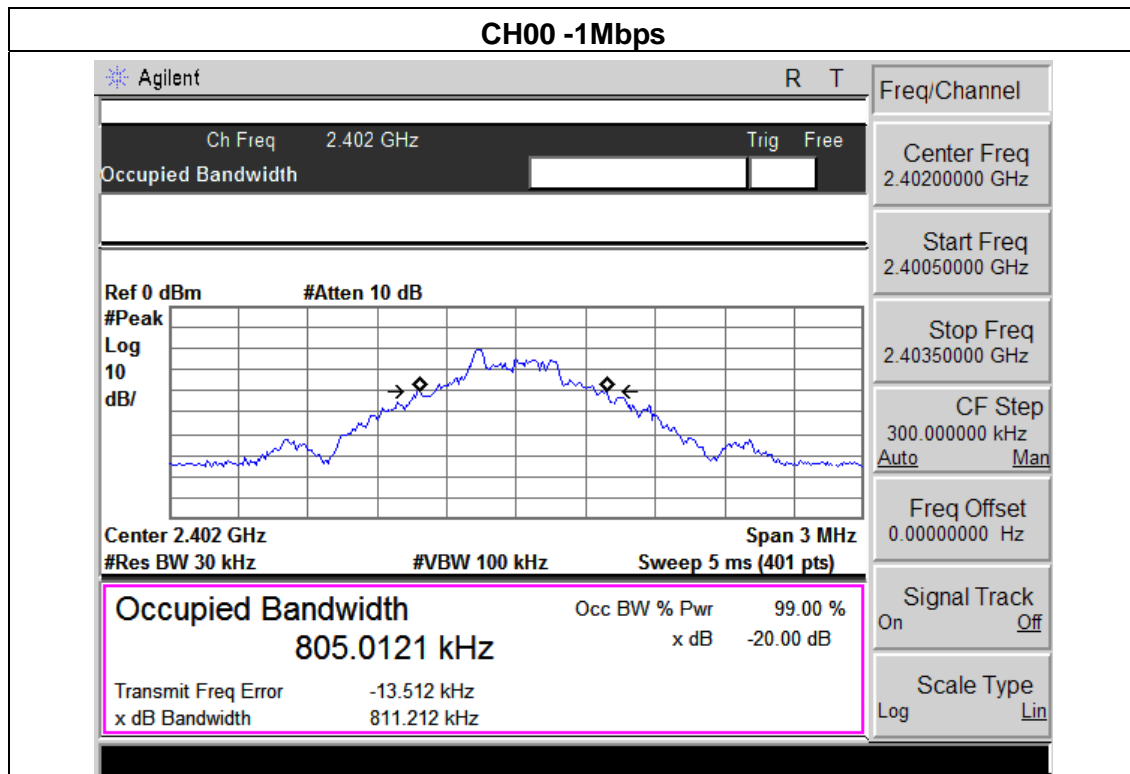

### CH39 -1Mbps

Agilent		R	T	Freq/Channel	
Ch Freq 2.441 GHz		Trig Free		Center Freq 2.44100000 GHz	
Occupied Bandwidth				Start Freq 2.43950000 GHz	
Ref 0 dBm #Atten 10 dB				Stop Freq 2.44250000 GHz	
				CF Step 300.000000 kHz Auto Man	
Center 2.441 GHz		Span 3 MHz		Freq Offset 0.00000000 Hz	
#Res BW 30 kHz		#VBW 100 kHz		Sweep 5 ms (401 pts)	
<b>Occupied Bandwidth</b> <b>821.6074 kHz</b>		Occ BW % Pwr 99.00 %		Signal Track On Off	
Transmit Freq Error 4.350 kHz		x dB -20.00 dB		Scale Type Log Lin	
x dB Bandwidth 765.782 kHz					

### CH78 -1Mbps

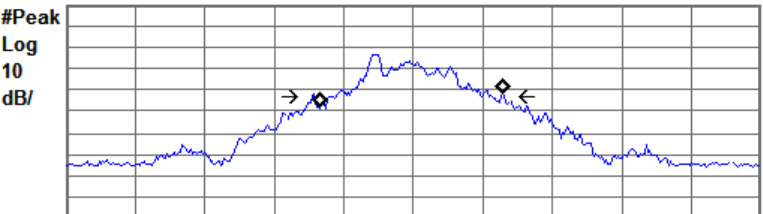
Agilent		R	T	Meas Setup	
Ch Freq 2.48 GHz		Trig Free		Avg Number 10	
Occupied Bandwidth				On Off	
Ref 0 dBm #Atten 10 dB				Avg Mode Exp Repeat	
				Max Hold On Off	
Center 2.48 GHz		Span 3 MHz		Occ BW % Pwr 99.00 %	
#Res BW 30 kHz		#VBW 100 kHz		OBW Spar 3.00000000 MHz	
Sweep 5 ms (401 pts)				x dB -20.00 dB	
<b>Occupied Bandwidth</b> <b>790.1117 kHz</b>		Occ BW % Pwr 99.00 %		Optimize Ref Level	
Transmit Freq Error -9.875 kHz		x dB -20.00 dB			
x dB Bandwidth 828.745 kHz					

EUT :	Gadgetree Lighted Geode Speaker	Model Name :	8046922
Temperature :	25 °C	Relative Humidity :	60%
Pressure :	1012 hPa	Test Voltage :	DC 3.7V
Test Mode :	CH00 / CH39 /C78(2Mbps)		

Frequency	20dB Bandwidth (MHz)	Result
2402 MHz	1.126	<b>PASS</b>
2441 MHz	1.124	<b>PASS</b>
2480 MHz	1.129	<b>PASS</b>

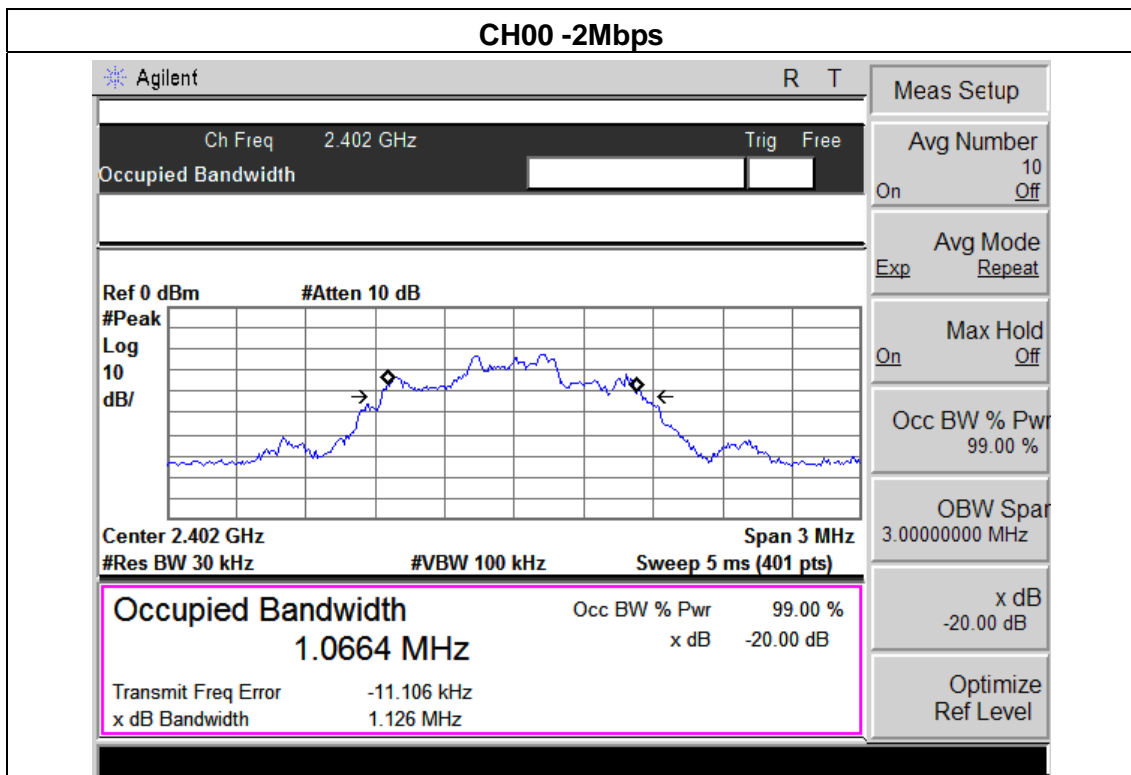

### CH39 -2Mbps

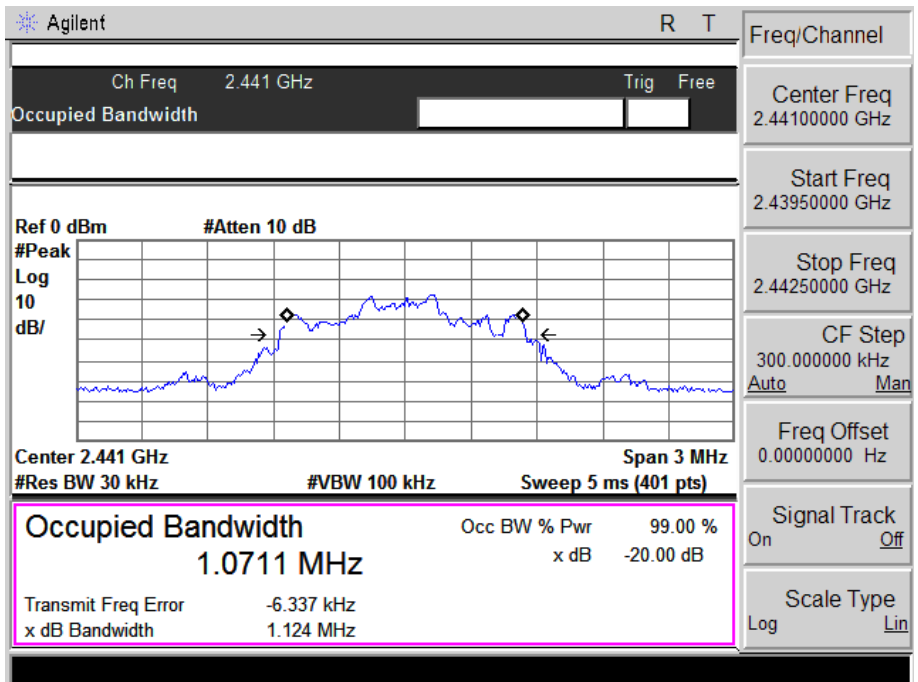

### CH78 -2Mbps

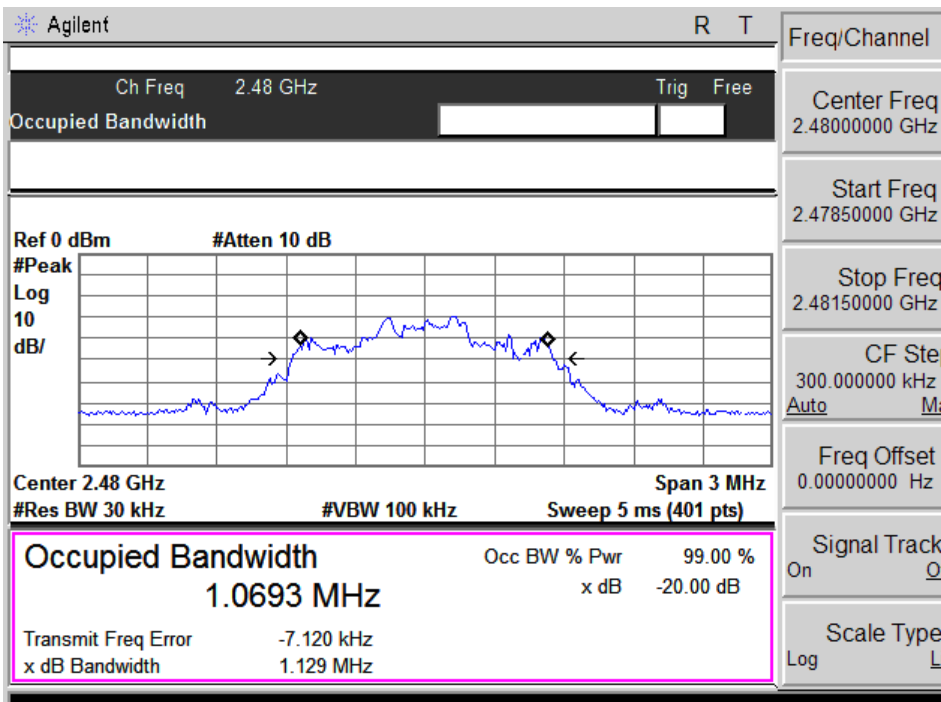



EUT :	Gadgetree Lighted Geode Speaker	Model Name :	8046922
Temperature :	25 °C	Relative Humidity :	60%
Pressure :	1012 hPa	Test Voltage :	DC 3.7V
Test Mode :	CH00 / CH39 /C78(3Mbps)		

Frequency	20dB Bandwidth (MHz)	Result
2402 MHz	1.137	<b>PASS</b>
2441 MHz	1.115	<b>PASS</b>
2480 MHz	1.107	<b>PASS</b>

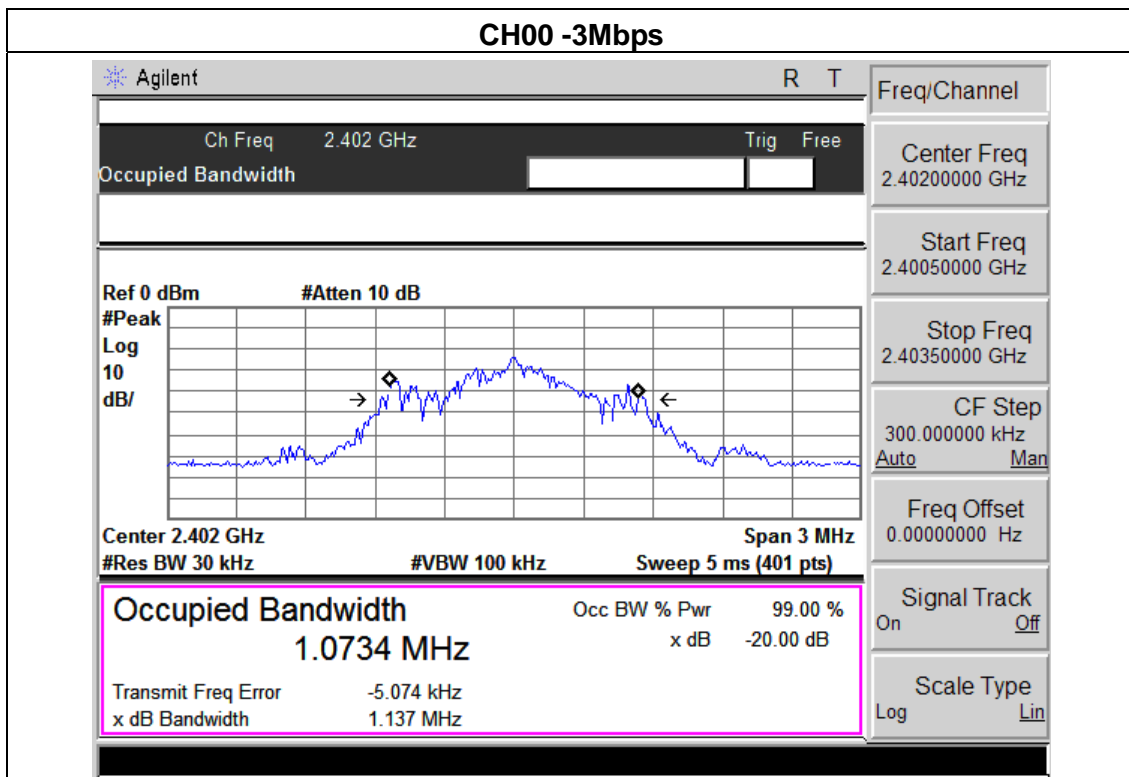

### CH39 -3Mbps

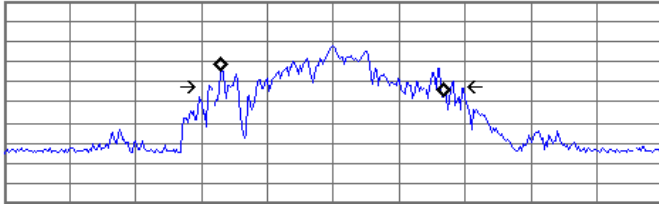
Agilent		R	T	Freq/Channel	
Ch Freq 2.441 GHz		Trig Free		Center Freq 2.44100000 GHz	
Occupied Bandwidth				Start Freq 2.43950000 GHz	
Ref 0 dBm #Atten 10 dB				Stop Freq 2.44250000 GHz	
				CF Step 300.000000 kHz Auto Man	
Center 2.441 GHz		Span 3 MHz		Freq Offset 0.00000000 Hz	
#Res BW 30 kHz		#VBW 100 kHz		Sweep 5 ms (401 pts)	
<b>Occupied Bandwidth</b> <b>1.0109 MHz</b>		Occ BW % Pwr 99.00 %		Signal Track On Off	
Transmit Freq Error -3.721 kHz		x dB -20.00 dB		Scale Type Log Lin	
x dB Bandwidth 1.115 MHz					

### CH78 -3Mbps

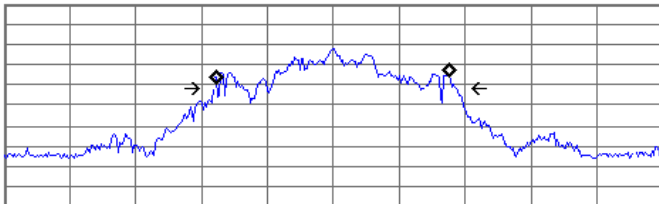
Agilent		R	T	Meas Setup	
Ch Freq 2.48 GHz		Trig Free		Avg Number 10 On Off	
Occupied Bandwidth				Avg Mode Exp Repeat	
Ref 0 dBm #Atten 10 dB				Max Hold On Off	
				Occ BW % Pwr 99.00 %	
Center 2.48 GHz		Span 3 MHz		OBW Spar 3.00000000 MHz	
#Res BW 30 kHz		#VBW 100 kHz		x dB -20.00 dB	
Sweep 5 ms (401 pts)				Optimize Ref Level	
<b>Occupied Bandwidth</b> <b>1.0575 MHz</b>		Occ BW % Pwr 99.00 %			
Transmit Freq Error -1.345 kHz		x dB -20.00 dB			
x dB Bandwidth 1.107 MHz					

**8. PEAK OUTPUT POWER TEST**

**8.1 APPLIED PROCEDURES / LIMIT**

FCC Part15 (15.247) , Subpart C				
Section	Test Item	Limit	Frequency Range (MHz)	Result
15.247 (b)(i)	Peak Output Power	0.125 w or 20.96dBm	2400-2483.5	PASS

**8.1.1 TEST PROCEDURE**

- a. The EUT was directly connected to the spectrum analyzer and antenna output port as show in the block diagram below,
- b. Spectrum Setting : RBW > the 20 dB bandwidth of the emission being measured
  - Span = approximately 5 times the 20 dB bandwidth, centered on a hopping channel
  - VBW ≥ RBW
  - Sweep = auto
  - Detector function = peak
  - Trace = max hold

**8.1.2 DEVIATION FROM STANDARD**

No deviation.

**8.1.3 TEST SETUP**

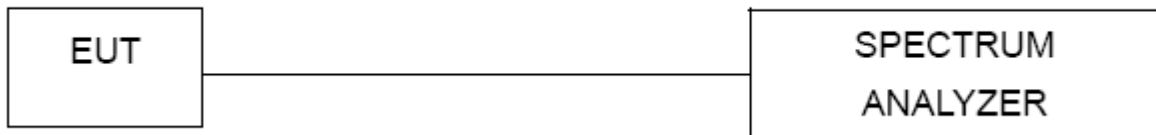

**8.1.4 EUT OPERATION CONDITIONS**

The EUT tested system was configured as the statements of 2.4 Unless otherwise a special operating condition is specified in the follows during the testing.

### 8.1.5 TEST RESULTS

EUT :	Gadgetree Lighted Geode Speaker	Model Name :	8046922
Temperature :	25 °C	Relative Humidity :	60%
Pressure :	1012 hPa	Test Voltage :	DC 3.7V
Test Mode :	CH00/ CH39 /CH78 (1M/2M/3Mbps Mode)		

1Mbps			
Test Channel	Frequency (MHz)	Peak Output Power (dBm)	LIMIT (dBm)
CH00	2402	0.254	20.96
CH39	2441	0.435	20.96
CH78	2480	0.285	20.96
2Mbps			
CH00	2402	-0.393	20.96
CH39	2441	-0.135	20.96
CH78	2480	-0.736	20.96
3Mbps			
CH00	2402	-0.415	20.96
CH39	2441	-0.363	20.96
CH78	2480	-0.591	20.96

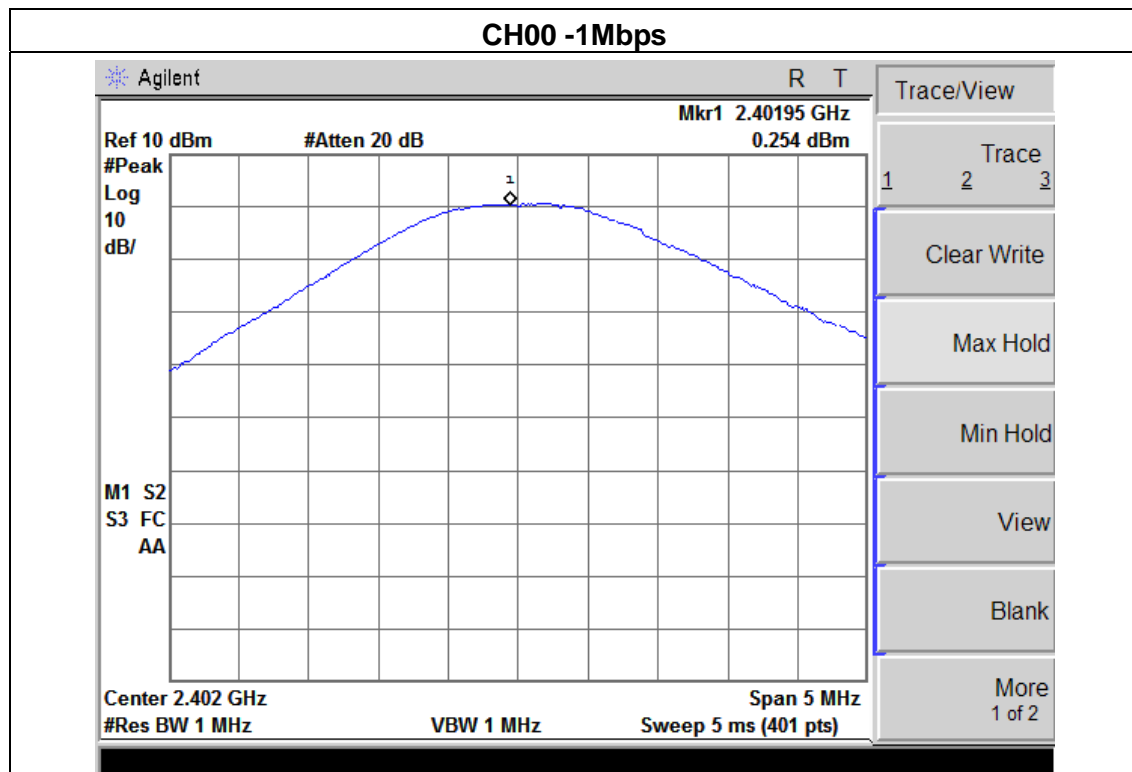

### CH39 -1Mbps

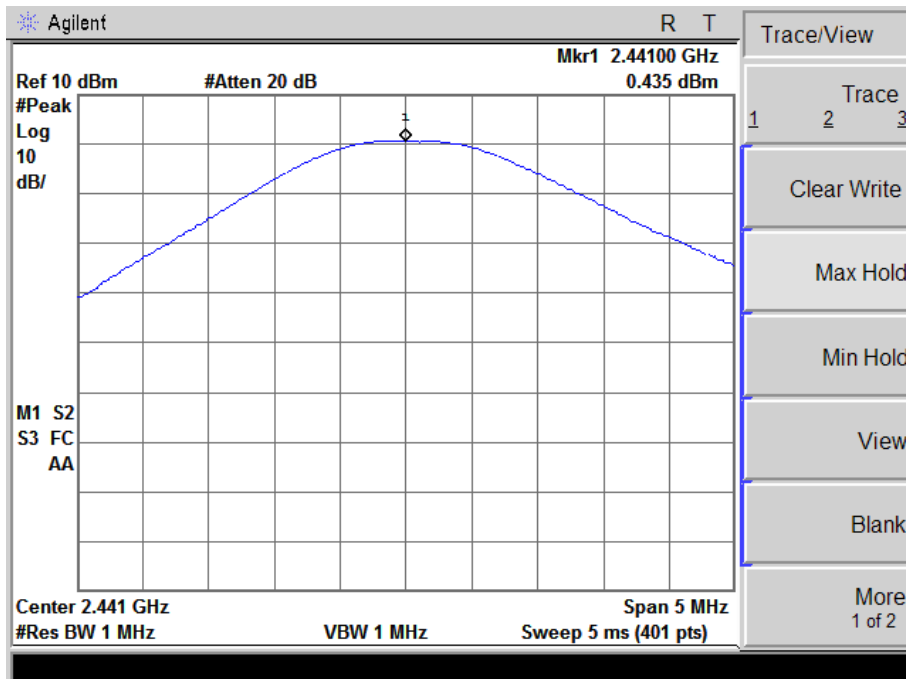

### CH78 -1Mbps

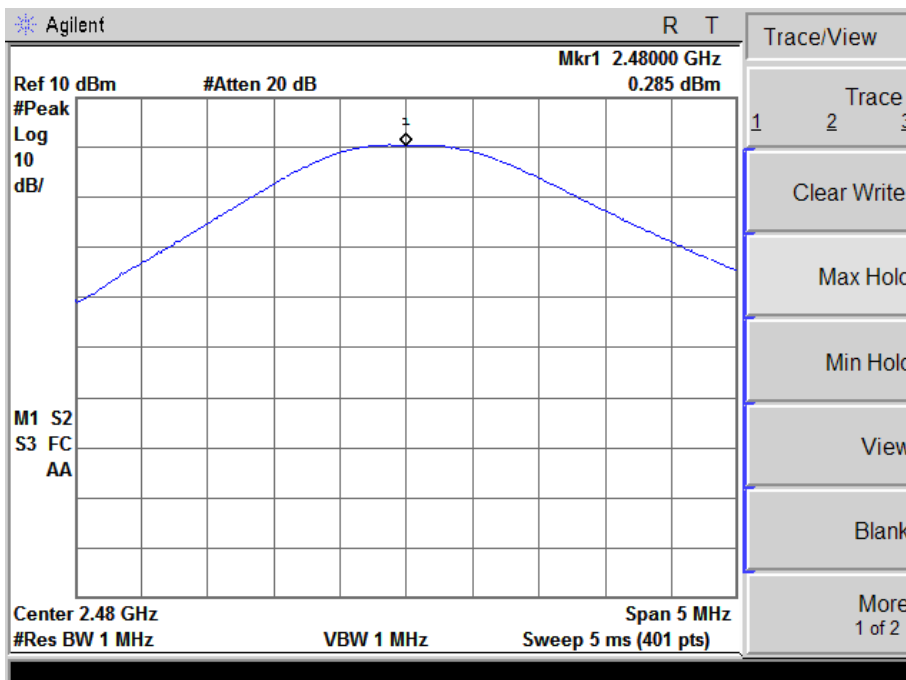

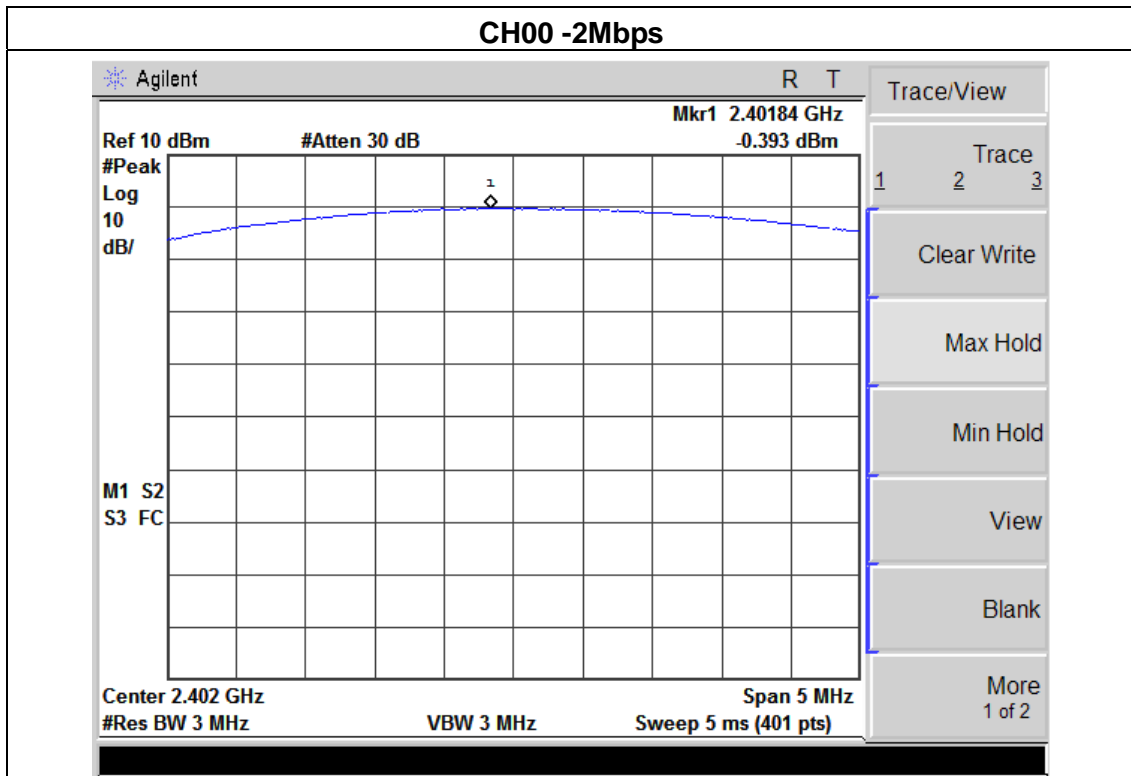

### CH39 -2Mbps

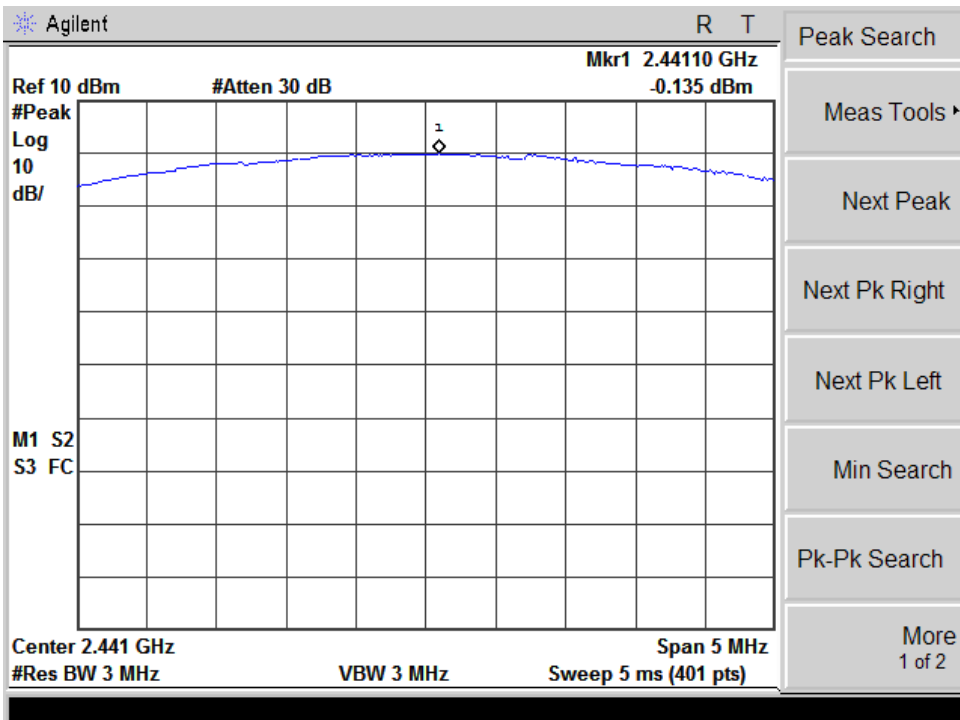

### CH78 -2Mbps

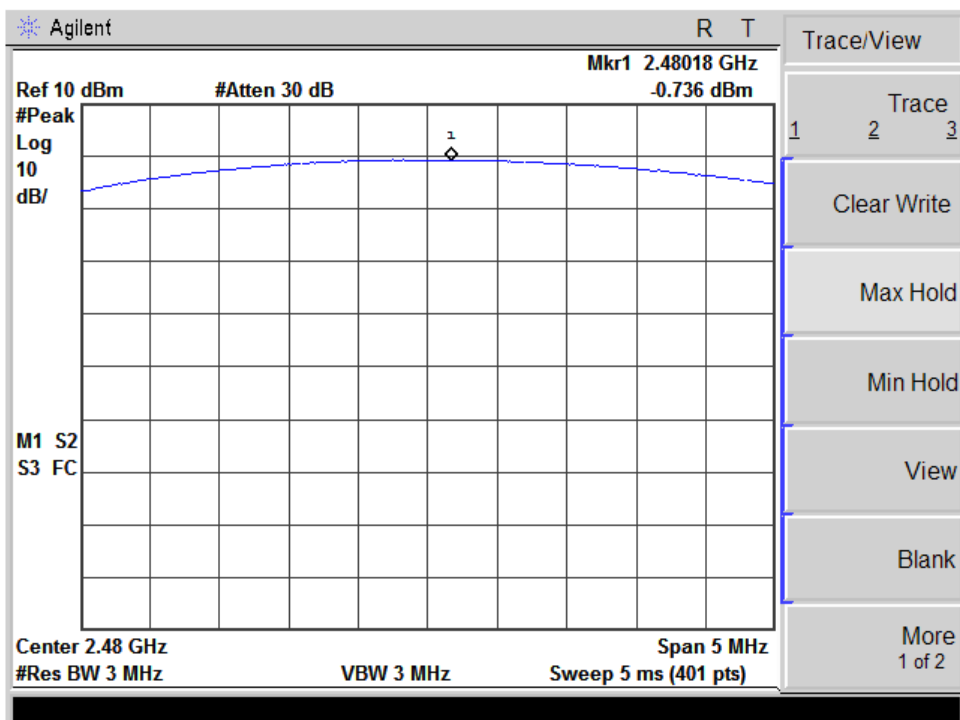

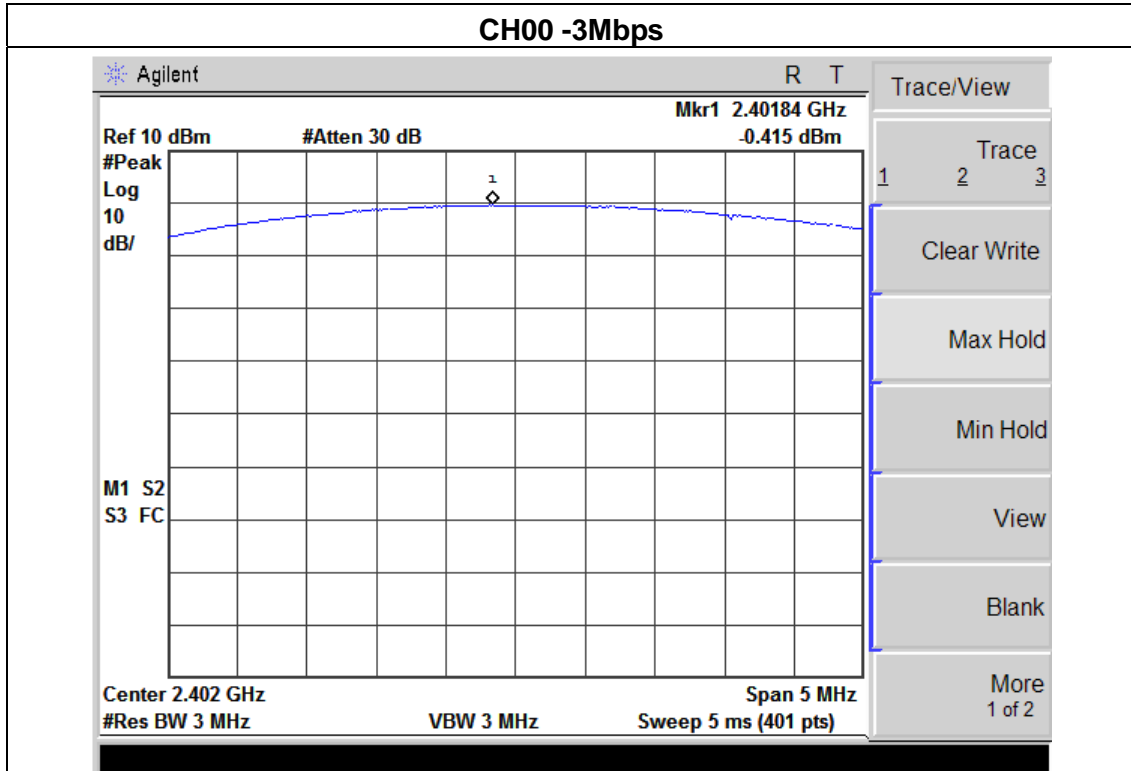



### CH39 -3Mbps

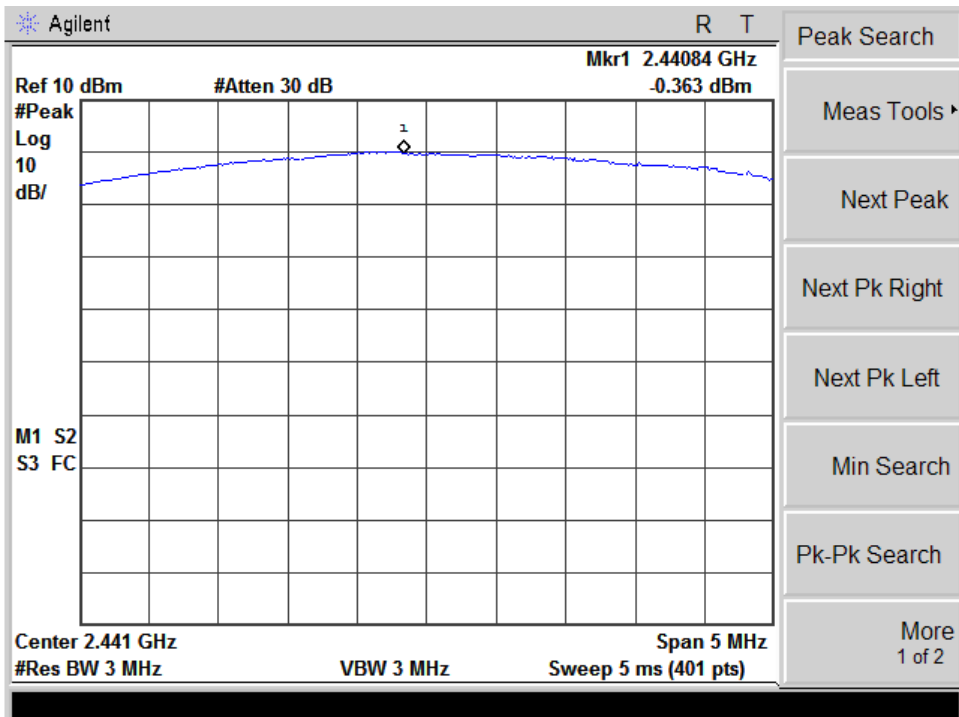

### CH78 -3Mbps

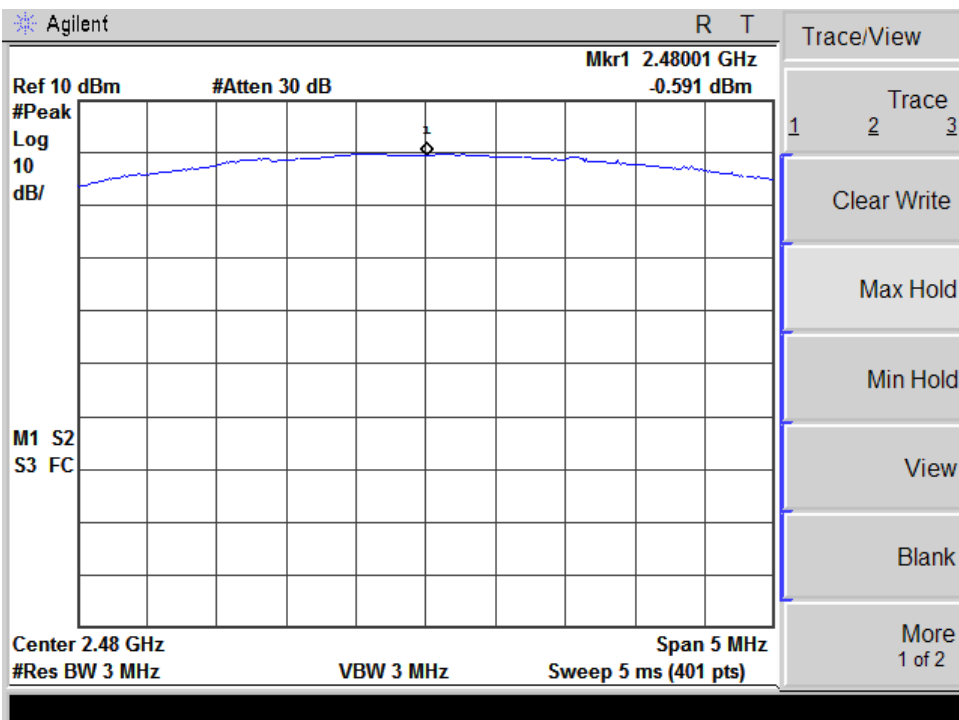

## 9.CONDUCTED SPURIOUS EMISSIONS

### 9.1 REQUIREMENT

According to FCC section 15.247(d), in any 100kHz bandwidth outside the frequency band in which the spread spectrum or digitally modulated intentional radiator is operating, the radio frequency power that is produced by the intentional radiator shall be at least 20dB below that in the 100kHz bandwidth within the band that contains the highest level of the desired power, based on either an RF conducted or a radiated measurement.

### 9.2 TEST PROCEDURE

According to FCC section 15.247(d), in any 100kHz bandwidth outside the frequency band in which the spread spectrum or digitally modulated intentional radiator is operating, the radio frequency power that is produced by the intentional radiator shall be at least 20dB below that in the 100kHz bandwidth within the band that contains the highest level of the desired power, based on either an RF conducted or a radiated measurement.

### 9.3 TEST SETUP

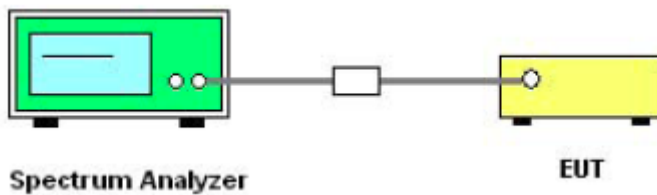

The EUT which is powered by the Battery, is coupled to the Spectrum Analyzer; the RF load attached to the EUT antenna terminal is 50Ohm; the path loss as the factor is calibrated to correct the reading. Make the measurement with the spectrum analyzer's resolution bandwidth(RBW) = 100 kHz. In order to make an accurate measurement, set the span greater than RBW.

### 9.4 EUT OPERATION CONDITIONS

The EUT tested system was configured as the statements of 2.3 Unless otherwise a special operating condition is specified in the follows during the testing.

### 9.5 TEST RESULTS

1Mbps:

CH0



CH 39





For Band Edge:

CH0

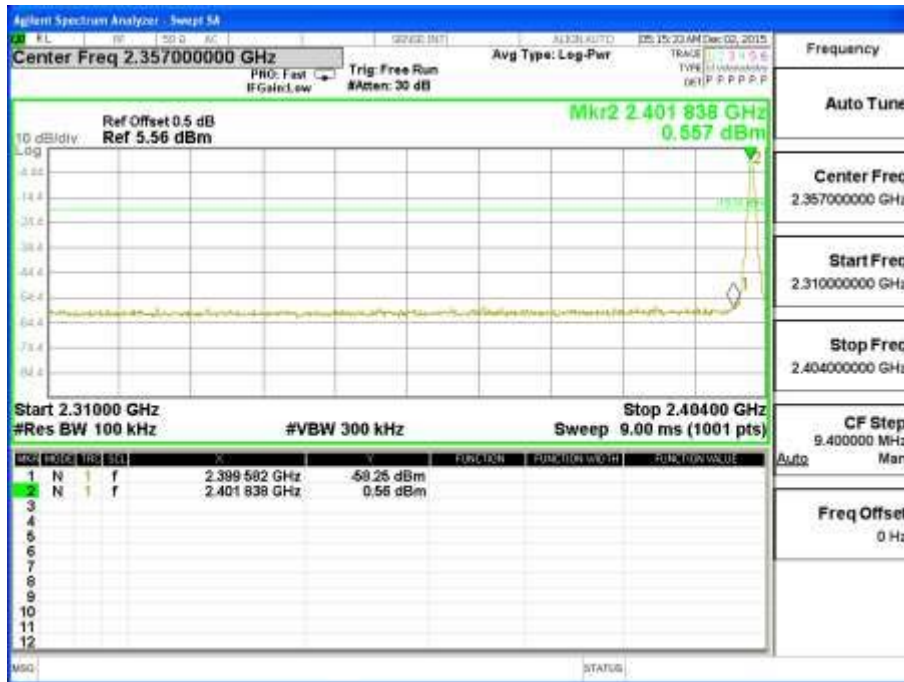

CH78

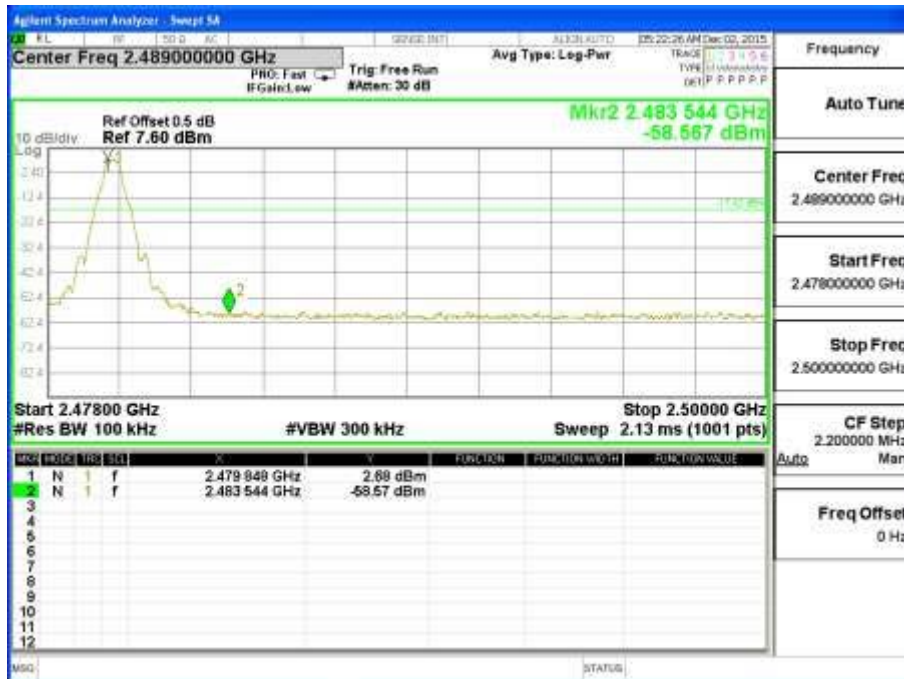

For hopping Band edge

CH0

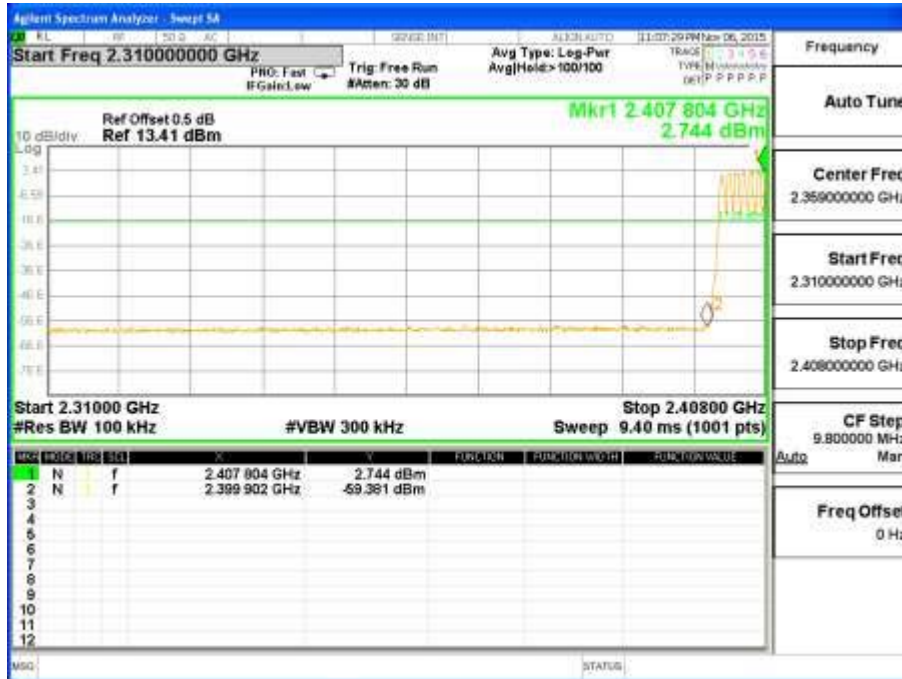

CH78

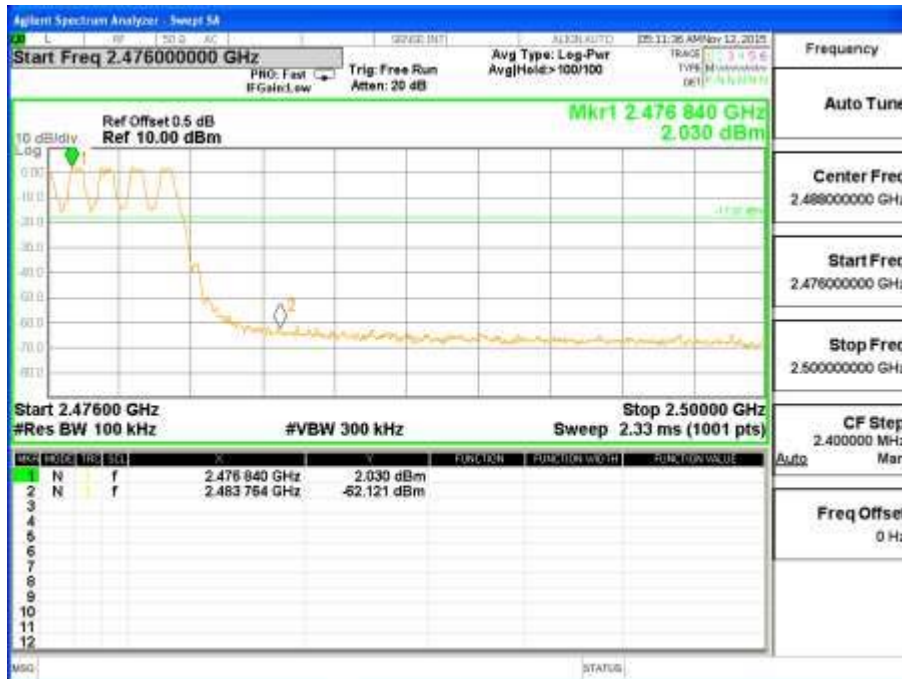



2Mbps:

CHO



Ch39



Ch78





For Band Edge:

CH0

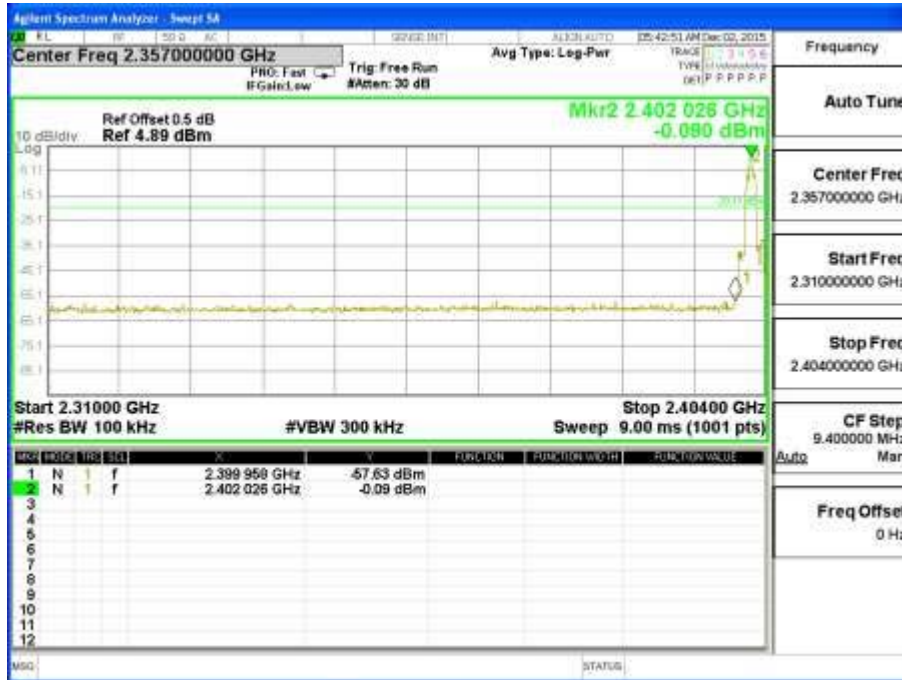

CH78

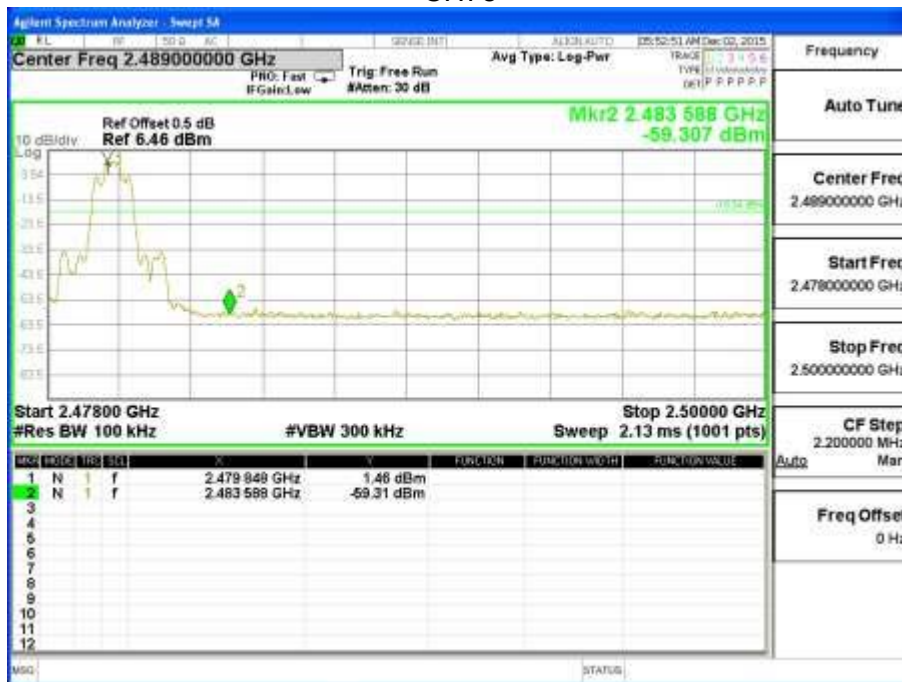



3Mbps:

CH0



CH39

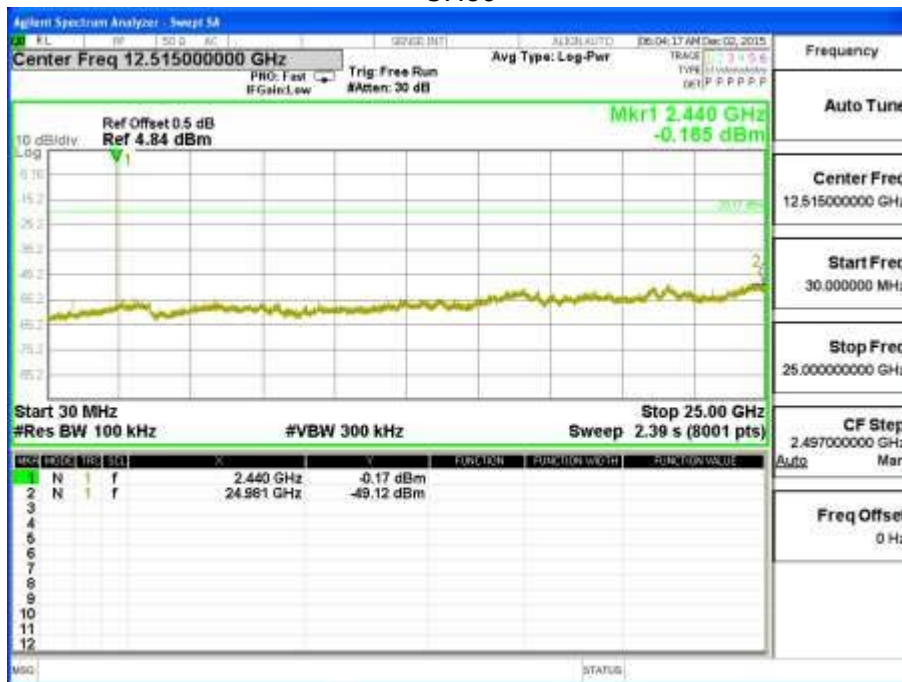

CH78



For Band Edge

CH0

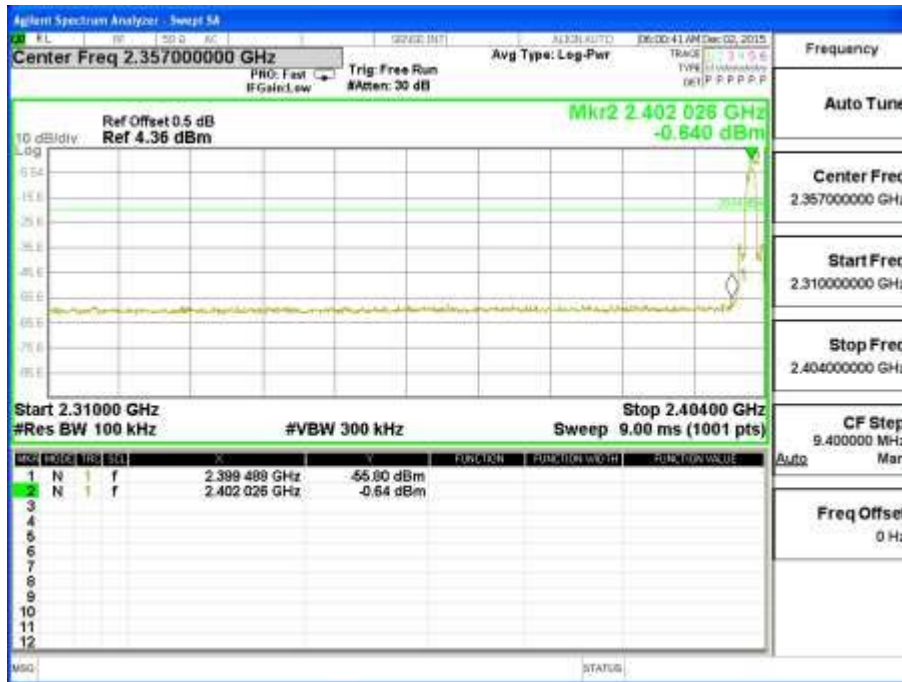

CH78

