

**CFR 47 FCC PART 15 SUBPART C
ISED RSS-247 ISSUE 2**

TEST REPORT

For

ZHIYUN MOLUS G200 Video Light

MODEL NUMBER: PL109

REPORT NUMBER: 4790854804-RF-1

ISSUE DATE: June 9, 2023

FCC ID: 2AIHFZYPL109

IC: 29921-ZYPL109

Prepared for

**Guilin Zhishen Information Technology Co., Ltd.
09 Huangtong Road, Tieshan Industrial Zone, Qixing District, Guilin,
Guangxi, 541004 China.**

Prepared by

UL Verification Services (Guangzhou) Co., Ltd, Song Shan Lake Branch

Building 10, Innovation Technology Park, No. 1, Li Bin Road, Song Shan Lake Hi-Tech Development Zone Dongguan, 523808, People's Republic of China

Tel: +86 769 22038881

Fax: +86 769 33244054

Website: www.ul.com

Revision History

Rev.	Issue Date	Revisions	Revised By
V0	June 9, 2023	Initial Issue	

Summary of Test Results

Test Item	Clause	Limit/Requirement	Result
Antenna Requirement	/	FCC Part 15.203/15.247 (c) RSS-GEN Clause 6.8	Pass
AC Power Line Conducted Emission	ANSI C63.10-2013, Clause 6.2	FCC Part 15.207 RSS-GEN Clause 8.8	Pass
Conducted Output Power	ANSI C63.10-2013, Clause 11.9.1.3	FCC Part 15.247 (b)(3) RSS-247 Clause 5.4 (d)	Pass
6dB Bandwidth and 99% Occupied Bandwidth	ANSI C63.10-2013, Clause 11.8.1	FCC Part 15.247 (a)(2) RSS-247 Clause 5.2 (a) RSS-Gen Clause 6.7	Pass
Power Spectral Density	ANSI C63.10-2013, Clause 11.10.2	FCC Part 15.247 (e) RSS-247 Clause 5.2 (b)	Pass
Conducted Band edge and spurious emission	ANSI C63.10-2013, Clause 11.11	FCC Part 15.247(d) RSS-247 Clause 5.5	Pass
Radiated Band edge and Spurious Emission	ANSI C63.10-2013, Clause 11.12 & Clause 11.13	FCC Part 15.247 (d) FCC Part 15.205/15.209 RSS-247 Clause 5.5 RSS-GEN Clause 8.9	Pass
Duty Cycle	ANSI C63.10-2013, Clause 11.6	None; for reporting purposes only.	Pass

*This test report is only published to and used by the applicant, and it is not for evidence purpose in China.

*The measurement result for the sample received is <Pass> according to <CFR 47 FCC PART 15 SUBPART C and ISED RSS-247 ISSUE 2> when <Accuracy Method> decision rule is applied.

CONTENTS

1. ATTESTATION OF TEST RESULTS	6
2. TEST METHODOLOGY	7
3. FACILITIES AND ACCREDITATION	7
4. CALIBRATION AND UNCERTAINTY	8
4.1. <i>MEASURING INSTRUMENT CALIBRATION</i>	8
4.2. <i>MEASUREMENT UNCERTAINTY</i>	8
5. EQUIPMENT UNDER TEST	9
5.1. <i>DESCRIPTION OF EUT</i>	9
5.2. <i>CHANNEL LIST</i>	9
5.3. <i>MAXIMUM EIRP</i>	9
5.4. <i>TEST CHANNEL CONFIGURATION</i>	10
5.5. <i>THE WORSE CASE POWER SETTING PARAMETER</i>	10
5.6. <i>DESCRIPTION OF AVAILABLE ANTENNAS</i>	10
5.7. <i>DESCRIPTION OF TEST SETUP</i>	11
6. MEASURING EQUIPMENT AND SOFTWARE USED	12
7. ANTENNA PORT TEST RESULTS	14
7.1. <i>CONDUCTED OUTPUT POWER</i>	14
7.2. <i>6DB BANDWIDTH AND 99% OCCUPIED BANDWIDTH</i>	15
7.3. <i>POWER SPECTRAL DENSITY</i>	17
7.4. <i>CONDUCTED BAND EDGE AND SPURIOUS EMISSION</i>	18
7.5. <i>DUTY CYCLE</i>	20
8. RADIATED TEST RESULTS	21
8.1. <i>RESTRICTED BANDEDGE</i>	30
8.2. <i>SPURIOUS EMISSIONS (1 GHZ ~ 3 GHZ)</i>	34
8.3. <i>SPURIOUS EMISSIONS (3 GHZ ~ 18 GHZ)</i>	40
8.4. <i>SPURIOUS EMISSIONS (9 KHZ ~ 30 MHZ)</i>	52
8.5. <i>SPURIOUS EMISSIONS (18 GHZ ~ 26 GHZ)</i>	55
8.6. <i>SPURIOUS EMISSIONS (30 MHZ ~ 1 GHZ)</i>	57
9. AC POWER LINE CONDUCTED EMISSION	59
10. ANTENNA REQUIREMENT	62
11. TEST DATA	63

11.1.	<i>APPENDIX A: DTS BANDWIDTH</i>	63
11.1.1.	Test Result	63
11.1.2.	Test Graphs	64
11.2.	<i>APPENDIX B: OCCUPIED CHANNEL BANDWIDTH</i>	66
11.2.1.	Test Result	66
11.2.2.	Test Graphs	67
11.3.	<i>APPENDIX C: MAXIMUM PEAK CONDUCTED OUTPUT POWER</i>	69
11.3.1.	Test Result	69
11.4.	<i>APPENDIX D: MAXIMUM POWER SPECTRAL DENSITY</i>	70
11.4.1.	Test Result	70
11.4.2.	Test Graphs	71
11.5.	<i>APPENDIX E: BAND EDGE MEASUREMENTS</i>	73
11.5.1.	Test Result	73
11.5.2.	Test Graphs	74
11.6.	<i>APPENDIX F: CONDUCTED SPURIOUS EMISSION</i>	76
11.6.1.	Test Result	76
11.6.2.	Test Graphs	77
11.7.	<i>APPENDIX G: DUTY CYCLE</i>	83
11.7.1.	Test Result	83
11.7.2.	Test Graphs	84

1. ATTESTATION OF TEST RESULTS

Applicant Information

Company Name: Guilin Zhishen Information Technology Co., Ltd.
Address: 09 Huangtong Road, Tieshan Industrial Zone, Qixing District, Guilin, Guangxi, 541004 China.

Manufacturer Information

Company Name: Guilin Zhishen Information Technology Co., Ltd.
Address: 09 Huangtong Road, Tieshan Industrial Zone, Qixing District, Guilin, Guangxi, 541004 China.

EUT Information

EUT Name: ZHIYUN MOLUS G200 Video Light
Model: PL109
Brand: ZHIYUN
Sample Received Date: May 25, 2023
Sample Status: Normal
Sample ID: 6116231
Date of Tested: May 29, 2023 to June 9, 2023

APPLICABLE STANDARDS	
STANDARD	TEST RESULTS
CFR 47 FCC PART 15 SUBPART C ISED RSS-247 ISSUE 2	Pass

Prepared By:

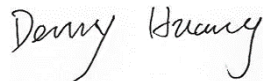

Denny Huang
Senior Project Engineer

Checked By:



Kebo Zhang
Senior Project Engineer

Approved By:



Stephen Guo
Operations Manager

2. TEST METHODOLOGY

All tests were performed in accordance with the standard CFR 47 FCC PART 15 SUBPART C ISED RSS-247 ISSUE 2, KDB 558074 D01 15.247 Meas Guidance v05r02, 414788 D01 Radiated Test Site v01r01, CFR 47 FCC Part 2, ANSI C63.10-2013 and ISED RSS-GEN Issue 5.

3. FACILITIES AND ACCREDITATION

Accreditation Certificate	<p>A2LA (Certificate No.: 4102.01) UL Verification Services (Guangzhou) Co., Ltd. Song Shan Lake Branch. has been assessed and proved to be in compliance with A2LA.</p> <p>FCC (FCC Designation No.: CN1187) UL Verification Services (Guangzhou) Co., Ltd. Song Shan Lake Branch. Has been recognized to perform compliance testing on equipment subject to the Commission's Declaration of Conformity (DoC) and Certification rules</p> <p>ISED (Company No.: 21320) UL Verification Services (Guangzhou) Co., Ltd. Song Shan Lake Branch. has been registered and fully described in a report filed with ISED. The Company Number is 21320 and the test lab Conformity Assessment Body Identifier (CABID) is CN0046.</p> <p>VCCI (Registration No.: G-20019, R-20004, C-20012 and T-20011) UL Verification Services (Guangzhou) Co., Ltd. Song Shan Lake Branch. has been assessed and proved to be in compliance with VCCI, the Membership No. is 3793. Facility Name: Chamber D, the VCCI registration No. is G-20019 and R-20004 Shielding Room B , the VCCI registration No. is C-20012 and T-20011</p>
---------------------------	--

Note 1:

All tests measurement facilities use to collect the measurement data are located at Building 10, Innovation Technology Park, No. 1, Li Bin Road, Song Shan Lake Hi-Tech Development Zone Dongguan, 523808, People's Republic of China.

Note 2:

The test anechoic chamber in UL Verification Services (Guangzhou) Co., Ltd. Song Shan Lake Branch had been calibrated and compared to the open field sites and the test anechoic chamber is shown to be equivalent to or worst case from the open field site.

Note 3:

For below 30 MHz, lab had performed measurements at test anechoic chamber and comparing to measurements obtained on an open field site. And these measurements below 30 MHz had been correlated to measurements performed on an OFS.

4. CALIBRATION AND UNCERTAINTY

4.1. MEASURING INSTRUMENT CALIBRATION

The measuring equipment utilized to perform the tests documented in this report has been calibrated in accordance with the manufacturer's recommendations and is traceable to recognized national standards.

4.2. MEASUREMENT UNCERTAINTY

Where relevant, the following measurement uncertainty levels have been estimated for tests performed on the apparatus:

Test Item	Uncertainty
Conduction emission	3.62 dB
Radiated Emission (Included Fundamental Emission) (9 kHz ~ 30 MHz)	2.2 dB
Radiated Emission (Included Fundamental Emission) (30 MHz ~ 1 GHz)	4.00 dB
Radiated Emission (Included Fundamental Emission) (1 GHz to 26 GHz)	5.78 dB (1 GHz ~ 18 GHz)
	5.23 dB (18 GHz ~ 26 GHz)
Duty Cycle	±0.028%
DTS and 99% Occupied Bandwidth	±0.0196%
Maximum Conducted Output Power	±0.686 dB
Maximum Power Spectral Density Level	±0.743 dB
Conducted Band-edge Compliance	±1.328 dB
Conducted Unwanted Emissions In Non-restricted Frequency Bands	±0.746 dB (9 kHz ~ 1 GHz)
	±1.328dB (1 GHz ~ 26 GHz)
Note: This uncertainty represents an expanded uncertainty expressed at approximately the 95% confidence level using a coverage factor of k=2.	

5. EQUIPMENT UNDER TEST

5.1. DESCRIPTION OF EUT

EUT Name	ZHIYUN MOLUS G200 Video Light	
Model	PL109	
Technology	Bluetooth - Low Energy	
Transmit Frequency Range	2402 MHz ~ 2480 MHz	
Modulation	GFSK	
Data Rate	BLE 1M	1 Mbps
Data Rate	BLE 2M	2 Mbps
Ratings	AC 120, 60 Hz	

5.2. CHANNEL LIST

Channel	Frequency (MHz)	Channel	Frequency (MHz)	Channel	Frequency (MHz)	Channel	Frequency (MHz)
0	2402	11	2424	22	2446	33	2468
1	2404	12	2426	23	2448	34	2470
2	2406	13	2428	24	2450	35	2472
3	2408	14	2430	25	2452	36	2474
4	2410	15	2432	26	2454	37	2476
5	2412	16	2434	27	2456	38	2478
6	2414	17	2436	28	2458	39	2480
7	2416	18	2438	29	2460	/	/
8	2418	19	2440	30	2462	/	/
9	2420	20	2442	31	2464	/	/
10	2422	21	2444	32	2468	/	/

5.3. MAXIMUM EIRP

Test Mode	Frequency (MHz)	Channel Number	Maximum Peak Output Power (dBm)
BLE 1M	2402 ~ 2480	0-39[40]	-0.47
BLE 2M	2402 ~ 2480	0-39[40]	0.45

5.4. TEST CHANNEL CONFIGURATION

Test Mode	Test Channel	Frequency
BLE 1M	CH 0(Low Channel), CH 19(MID Channel), CH 39(High Channel)	2402 MHz, 2440 MHz, 2480 MHz
BLE 2M	CH 0(Low Channel), CH 19(MID Channel), CH 39(High Channel)	2402 MHz, 2440 MHz, 2480 MHz

5.5. THE WORSE CASE POWER SETTING PARAMETER

The Worst Case Power Setting Parameter under 2400 ~ 2483.5MHz Band				
Test Software Version		sscom42		
Modulation Type	Transmit Antenna Number	Test Software setting value		
		CH 0	CH 19	CH 39
BLE 1M	1	3	3	2
BLE 2M	1	3	3	3

5.6. DESCRIPTION OF AVAILABLE ANTENNAS

Antenna	Frequency (MHz)	Antenna Type	Maximum Antenna Gain (dBi)
1	2402-2480	Ceramic	2.09

Test Mode	Transmit and Receive Mode	Description
BLE 1M	<input checked="" type="checkbox"/> 1TX, 1RX	Antenna 1 can be used as transmitting/receiving antenna.
BLE 2M	<input checked="" type="checkbox"/> 1TX, 1RX	Antenna 1 can be used as transmitting/receiving antenna.

Note: The value of the antenna gain was declared by customer.

5.7. DESCRIPTION OF TEST SETUP

SUPPORT EQUIPMENT

Item	Equipment	Brand Name	Model Name	Remarks
1	Laptop	Lenovo	XIAOXIN 5000	/
2	UART	/	/	/

I/O CABLES

Cable No	Port	Connector Type	Cable Type	Cable Length(m)	Remarks
1	AC	/	/	1	/

ACCESSORIES

Item	Accessory	Brand Name	Model Name	Description
1	/	/	/	/

TEST SETUP

The EUT can work in engineering mode with a software through a Laptop.

SETUP DIAGRAM FOR TESTS

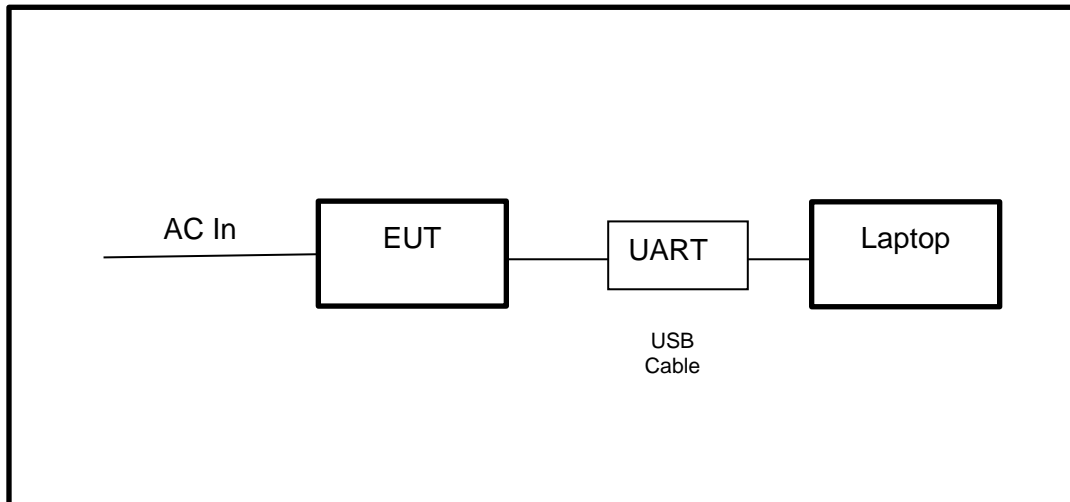

6. MEASURING EQUIPMENT AND SOFTWARE USED

R&S TS 8997 Test System					
Equipment	Manufacturer	Model No.	Serial No.	Last Cal.	Due. Date
Power sensor, Power Meter	R&S	OSP120	100921	Mar.31,2023	Mar.30,2024
Vector Signal Generator	R&S	SMBV100A	261637	Oct.17, 2022	Oct.16, 2023
Signal Generator	R&S	SMB100A	178553	Oct.17, 2022	Oct.16, 2023
Signal Analyzer	R&S	FSV40	101118	Oct.17, 2022	Oct.16, 2023
Software					
Description	Manufacturer	Name		Version	
For R&S TS 8997 Test System	Rohde & Schwarz	EMC 32		10.60.10	
Tonsend RF Test System					
Equipment	Manufacturer	Model No.	Serial No.	Last Cal.	Due. Date
Wideband Radio Communication Tester	R&S	CMW500	155523	Oct.17, 2022	Oct.16, 2023
Wireless Connectivity Tester	R&S	CMW270	1201.0002N75-102	Sep.28, 2022	Sep.27, 2023
PXA Signal Analyzer	Keysight	N9030A	MY55410512	Oct.17, 2022	Oct.16, 2023
MXG Vector Signal Generator	Keysight	N5182B	MY56200284	Oct.17, 2022	Oct.16, 2023
MXG Vector Signal Generator	Keysight	N5172B	MY56200301	Oct.17, 2022	Oct.16, 2023
DC power supply	Keysight	E3642A	MY55159130	Oct.17, 2022	Oct.16, 2023
Temperature & Humidity Chamber	SANMOOD	SG-80-CC-2	2088	Oct.17, 2022	Oct.16, 2023
Attenuator	Aglient	8495B	2814a12853	Oct.18, 2022	Oct.17, 2023
RF Control Unit	Tonscend	JS0806-2	23B80620666	April 18,2023	April 17,2024
Software					
Description	Manufacturer	Name		Version	
Tonsend SRD Test System	Tonsend	JS1120-3 RF Test System		V3.2.22	

Conducted Emissions					
Equipment	Manufacturer	Model No.	Serial No.	Last Cal.	Due Date
EMI Test Receiver	R&S	ESR3	101961	Oct.17, 2022	Oct.16, 2023
Two-Line V-Network	R&S	ENV216	101983	Oct.17, 2022	Oct.16, 2023
Software					
Description			Manufacturer	Name	Version
Test Software for Conducted Emissions			Farad	EZ-EMC	Ver. UL-3A1

Radiated Emissions					
Equipment	Manufacturer	Model No.	Serial No.	Last Cal.	Due Date
MXE EMI Receiver	KESIGHT	N9038A	MY56400036	Oct.17, 2022	Oct.16, 2023
Hybrid Log Periodic Antenna	TDK	HLP-3003C	130959	Aug.02, 2021	Aug.01, 2024
Preamplifier	HP	8447D	2944A09099	Oct.17, 2022	Oct.16, 2023
EMI Measurement Receiver	R&S	ESR26	101377	Oct.17, 2022	Oct.16, 2023
Horn Antenna	TDK	HRN-0118	130940	July 20, 2021	July 19, 2024
Preamplifier	TDK	PA-02-0118	TRS-305-00067	Oct.17, 2022	Oct.16, 2023
Horn Antenna	Schwarzbeck	BBHA9170	697	July 20, 2021	July 19, 2024
Preamplifier	TDK	PA-02-2	TRS-307-00003	Oct.17, 2022	Oct.16, 2023
Preamplifier	TDK	PA-02-3	TRS-308-00002	Oct.17, 2022	Oct.16, 2023
Loop antenna	Schwarzbeck	1519B	00008	Dec.14, 2021	Dec.13, 2024
Preamplifier	TDK	PA-02-001-3000	TRS-302-00050	Oct.17, 2022	Oct.16, 2023
Preamplifier	Mini-Circuits	ZX60-83LN-S+	SUP01202035	Oct.17, 2022	Oct.16, 2023
High Pass Filter	Wi	WHKX10-2700-3000-18000-40SS	23	Oct.17, 2022	Oct.16, 2023
Band Reject Filter	Wainwright	WRCJV8-2350-2400-2483.5-2533.5-40SS	4	Oct.17, 2022	Oct.16, 2023
Software					
Description			Manufacturer	Name	Version
Test Software for Radiated Emissions			Farad	EZ-EMC	Ver. UL-3A1

7. ANTENNA PORT TEST RESULTS

7.1. CONDUCTED OUTPUT POWER

LIMITS

CFR 47 FCC Part15 (15.247) Subpart C ISED RSS-247 ISSUE 2			
Section	Test Item	Limit	Frequency Range (MHz)
CFR 47 FCC 15.247(b)(3) ISED RSS-247 5.4 (d)	Peak Conduct Output Power	1 watt or 30 dBm	2400-2483.5

TEST PROCEDURE

Connect the EUT to a low loss RF cable from the antenna port to the power sensor (video bandwidth is greater than the occupied bandwidth).

Measure peak emission level, the indicated level is the peak output power, after any corrections for external attenuators and cables.

TEST SETUP

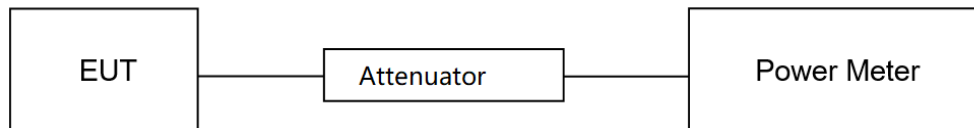

TEST ENVIRONMENT

Temperature	25 °C	Relative Humidity	61%
Atmosphere Pressure	101 kPa	Test Voltage	AC 120, 60 Hz

TEST RESULTS

Please refer to section "Test Data" - Appendix C

7.2. 6DB BANDWIDTH AND 99% OCCUPIED BANDWIDTH

LIMITS

CFR 47 FCC Part15 (15.247) Subpart C ISED RSS-247 ISSUE 2			
Section	Test Item	Limit	Frequency Range (MHz)
CFR 47 FCC 15.247(a)(2) ISED RSS-247 5.2 (a)	6 dB Bandwidth	≥ 500 kHz	2400-2483.5
ISED RSS-Gen Clause 6.7	99 % Occupied Bandwidth	For reporting purposes only.	2400-2483.5

TEST PROCEDURE

Refer to ANSI C63.10-2013 clause 11.8 for DTS bandwidth and clause 6.9 for Occupied Bandwidth.

Connect the EUT to the spectrum analyzer and use the following settings:

Center Frequency	The center frequency of the channel under test
Frequency Span	For 6 dB Bandwidth: Enough to capture all products of the modulation carrier emission For 99 % Occupied Bandwidth: Between 1.5 times and 5.0 times the OBW
Detector	Peak
RBW	For 6 dB Bandwidth: 100 kHz For 99 % Occupied Bandwidth: 1 % to 5 % of the occupied bandwidth
VBW	For 6 dB Bandwidth: ≥3 × RBW For 99 % Occupied Bandwidth: ≥3 × RBW
Trace	Max hold
Sweep	Auto couple

a) Use the 99 % power bandwidth function of the instrument, allow the trace to stabilize and report the measured bandwidth.

b) Allow the trace to stabilize and measure the maximum width of the emission that is constrained by the frequencies associated with the two outermost amplitude points (upper and lower frequencies) that are attenuated by 6 dB relative to the maximum level measured in the fundamental emission.

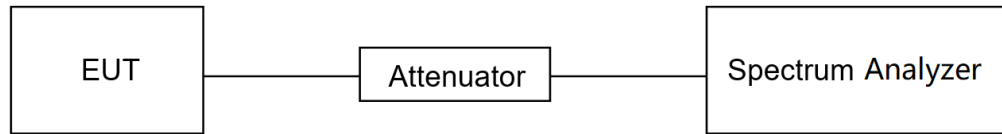
TEST SETUP**TEST ENVIRONMENT**

Temperature	25 °C	Relative Humidity	61%
Atmosphere Pressure	101 kPa	Test Voltage	AC 120, 60 Hz

TEST RESULTS

Please refer to section "Test Data" - Appendix A&B

7.3. POWER SPECTRAL DENSITY

LIMITS

CFR 47 FCC Part15 (15.247) Subpart C ISED RSS-247 ISSUE 2			
Section	Test Item	Limit	Frequency Range (MHz)
CFR 47 FCC §15.247 (e) ISED RSS-247 5.2 (b)	Power Spectral Density	8 dBm in any 3 kHz band	2400-2483.5

TEST PROCEDURE

Refer to ANSI C63.10-2013 clause 11.10.

Connect the EUT to the spectrum analyzer and use the following settings:

Center Frequency	The center frequency of the channel under test
Detector	PEAK
RBW	$3 \text{ kHz} \leq \text{RBW} \leq 100 \text{ kHz}$
VBW	$\geq 3 \times \text{RBW}$
Span	1.5 x DTS bandwidth
Trace	Max hold
Sweep time	Auto couple

Allow trace to fully stabilize and use the peak marker function to determine the maximum amplitude level within the RBW.

If measured value exceeds limit, reduce RBW (no less than 3 kHz) and repeat.

TEST SETUP

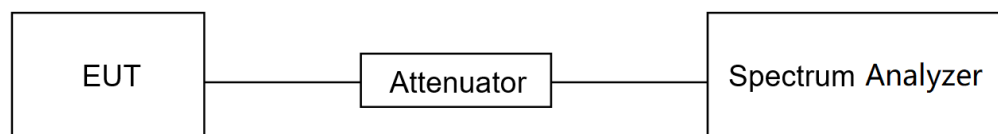

TEST ENVIRONMENT

Temperature	25 °C	Relative Humidity	61%
Atmosphere Pressure	101 kPa	Test Voltage	AC 120, 60 Hz

TEST RESULTS

Please refer to section "Test Data" - Appendix D

7.4. CONDUCTED BAND EDGE AND SPURIOUS EMISSION

LIMITS

CFR 47 FCC Part15 (15.247) Subpart C ISED RSS-247 ISSUE 2		
Section	Test Item	Limit
CFR 47 FCC §15.247 (d) ISED RSS-247 5.5	Conducted Bandedge and Spurious Emissions	at least 20 dB below that in the 100 kHz bandwidth within the band that contains the highest level of the desired power

TEST PROCEDURE

Refer to ANSI C63.10-2013 clause 11.11 and 11.13.

Connect the EUT to the spectrum analyzer and use the following settings for reference level measurement:

Center Frequency	The center frequency of the channel under test
Detector	Peak
RBW	100 kHz
VBW	$\geq 3 \times \text{RBW}$
Span	1.5 x DTS bandwidth
Trace	Max hold
Sweep time	Auto couple.

Allow trace to fully stabilize and use the peak marker function to determine the maximum PSD level.

Change the settings for emission level measurement:

Span	Set the center frequency and span to encompass frequency range to be measured
Detector	Peak
RBW	100 kHz
VBW	$\geq 3 \times \text{RBW}$
measurement points	$\geq \text{span}/\text{RBW}$
Trace	Max hold
Sweep time	Auto couple.

Allow trace to fully stabilize and use the peak marker function to determine the maximum PSD level. Ensure that the amplitude of all unwanted emissions outside of the authorized frequency band (excluding restricted frequency bands) is attenuated by at least the minimum requirements specified in 11.11.

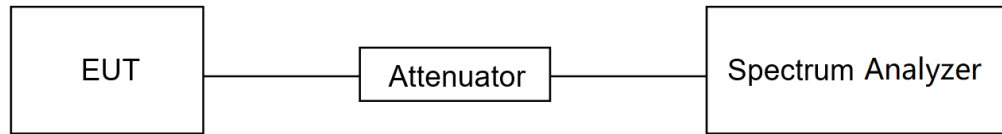
TEST SETUP**TEST ENVIRONMENT**

Temperature	25 °C	Relative Humidity	61%
Atmosphere Pressure	101 kPa	Test Voltage	AC 120, 60 Hz

TEST RESULTS

Please refer to section "Test Data" - Appendix E&F

7.5. DUTY CYCLE

LIMITS

None; for reporting purposes only.

TEST PROCEDURE

Refer to ANSI C63.10-2013 clause 11.6 Zero – Span Spectrum Analyzer method.

TEST SETUP

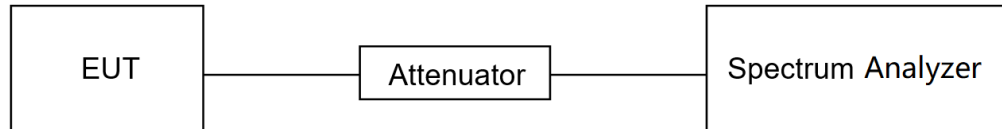

TEST ENVIRONMENT

Temperature	25 °C	Relative Humidity	61%
Atmosphere Pressure	101 kPa	Test Voltage	AC 120, 60 Hz

TEST RESULTS

Please refer to section "Test Data" - Appendix G

8. RADIATED TEST RESULTS

LIMITS

Please refer to CFR 47 FCC §15.205 and §15.209.

Please refer to ISED RSS-GEN Clause 8.9 and Clause 8.10.

Radiation Disturbance Test Limit for FCC (Class B) (9 kHz ~ 1 GHz)

Emissions radiated outside of the specified frequency bands above 30 MHz			
Frequency Range (MHz)	Field Strength Limit (uV/m) at 3 m	Field Strength Limit (dBuV/m) at 3 m	
		Quasi-Peak	
30 - 88	100	40	
88 - 216	150	43.5	
216 - 960	200	46	
Above 960	500	54	
Above 1000	500	Peak	Average
		74	54

FCC Emissions radiated outside of the specified frequency bands below 30 MHz		
Frequency (MHz)	Field strength (microvolts/meter)	Measurement distance (meters)
0.009-0.490	2400/F(kHz)	300
0.490-1.705	24000/F(kHz)	30
1.705-30.0	30	30

ISED General field strength limits at frequencies below 30 MHz

Table 6 – General field strength limits at frequencies below 30 MHz		
Frequency	Magnetic field strength (H-Field) (uA/m)	Measurement distance (m)
9 - 490 kHz ^{Note 1}	6.37/F (F in kHz)	300
490 - 1705 kHz	63.7/F (F in kHz)	30
1.705 - 30 MHz	0.08	30

Note 1: The emission limits for the ranges 9-90 kHz and 110-490 kHz are based on measurements employing a linear average detector.

ISED Restricted bands please refer to ISED RSS-GEN Clause 8.10

Table 7 – Restricted frequency bands ^{Note 1}		
MHz	MHz	GHz
0.090 - 0.110	149.9 - 150.05	9.0 - 9.2
0.495 - 0.505	156.52475 - 156.52525	9.3 - 9.5
2.1735 - 2.1905	156.7 - 156.9	10.6 - 12.7
3.020 - 3.026	162.0125 - 167.17	13.25 - 13.4
4.125 - 4.128	167.72 - 173.2	14.47 - 14.5
4.17725 - 4.17775	240 - 285	15.35 - 16.2
4.20725 - 4.20775	322 - 335.4	17.7 - 21.4
5.677 - 5.683	399.9 - 410	22.01 - 23.12
6.215 - 6.218	608 - 614	23.6 - 24.0
6.26775 - 6.26825	960 - 1427	31.2 - 31.8
6.31175 - 6.31225	1435 - 1626.5	36.43 - 36.5
8.291 - 8.294	1645.5 - 1646.5	Above 38.6
8.362 - 8.366	1660 - 1710	
8.37625 - 8.38675	1718.8 - 1722.2	
8.41425 - 8.41475	2200 - 2300	
12.29 - 12.293	2310 - 2390	
12.51975 - 12.52025	2483.5 - 2500	
12.57675 - 12.57725	2655 - 2900	
13.36 - 13.41	3260 - 3267	
16.42 - 16.423	3332 - 3339	
16.80475 - 16.80525	3345.8 - 3358	
16.80425 - 16.80475	3500 - 4400	
25.5 - 25.67	4500 - 5150	
37.5 - 38.25	5350 - 5460	
73 - 74.6	7250 - 7750	
74.8 - 75.2	8025 - 8500	
108 - 138		

Note 1: Certain frequency bands listed in table 7 and in bands above 38.6 GHz are designated for licence-exempt applications. These frequency bands and the requirements that apply to related devices are set out in the 200 and 300 series of RSSs.

FCC Restricted bands of operation refer to FCC §15.205 (a):

MHz	MHz	MHz	GHz
0.090-0.110	16.42-16.423	399.9-410	4.5-5.15
¹ 0.495-0.505	16.69475-16.69525	608-614	5.35-5.46
2.1735-2.1905	16.80425-16.80475	960-1240	7.25-7.75
4.125-4.128	25.5-25.67	1300-1427	8.025-8.5
4.17725-4.17775	37.5-38.25	1435-1626.5	9.0-9.2
4.20725-4.20775	73-74.6	1645.5-1646.5	9.3-9.5
6.215-6.218	74.8-75.2	1660-1710	10.6-12.7
6.26775-6.26825	108-121.94	1718.8-1722.2	13.25-13.4
6.31175-6.31225	123-138	2200-2300	14.47-14.5
8.291-8.294	149.9-150.05	2310-2390	15.35-16.2
8.362-8.366	156.52475-156.52525	2483.5-2500	17.7-21.4
8.37625-8.38675	156.7-156.9	2690-2900	22.01-23.12
8.41425-8.41475	162.0125-167.17	3260-3267	23.6-24.0
12.29-12.293	167.72-173.2	3332-3339	31.2-31.8
12.51975-12.52025	240-285	3345.8-3358	36.43-36.5
12.57675-12.57725	322-335.4	3600-4400	(²)
13.36-13.41			

Note: ¹Until February 1, 1999, this restricted band shall be 0.490-0.510 MHz.
²Above 38.6c

TEST PROCEDURE

Below 30 MHz

The setting of the spectrum analyzer

RBW	200 Hz (From 9 kHz to 0.15 MHz)/ 9 kHz (From 0.15 MHz to 30 MHz)
VBW	200 Hz (From 9 kHz to 0.15 MHz)/ 9 kHz (From 0.15 MHz to 30 MHz)
Sweep	Auto

1. The testing follows the guidelines in ANSI C63.10-2013 clause 6.4.
2. The EUT was arranged to its worst case and then turntable (from 0 degree to 360 degrees) to find the maximum reading. A pre-amp and a high pass filter are used for the test in order to get better signal level. Both Horizontal, Face-on and Face-off polarizations of the antenna are set to make the measurement.
3. The EUT was placed on a turntable with 80 cm above ground.
4. The EUT was set 3 meters from the interference receiving antenna, which was mounted on the top of a 1 m height antenna tower.
5. The radiated emission limits are based on measurements employing a CISPR quasi-peak detector except for the frequency bands 9-90 kHz, 110-490 kHz and above 1000 MHz Radiated emission limits in these three bands are based on measurements employing an average detector.
6. For measurement below 1 GHz, the initial step in collecting conducted emission data is a spectrum analyzer peak detector mode pre-scanning the measurement frequency range. Significant peaks are then marked and then Quasi Peak and average detector mode re-measured. If the emission level of the EUT measured by the peak detector is 3 dB lower than the applicable limit, the peak emission level will be reported. Otherwise, the emission measurement will be repeated using the quasi-peak and average detector and reported.
7. Although these tests were performed other than open field site, adequate comparison measurements were confirmed against 30m open field site. Therefore sufficient tests were made to demonstrate that the alternative site produces results that correlate with the ones of tests made in an open field site based on KDB 414788.
8. The limits in CFR 47, Part 15, Subpart C, paragraph 15.209 (a), are identical to those in RSS-GEN Section 8.9, Table 6, since the measurements are performed in terms of magnetic field strength and converted to electric field strength levels (as reported in the table) using the free space impedance of 377Ω . For example, the measurement frequency X KHz resulted in a level of Y dBuV/m, which is equivalent to $Y-51.5 = Z$ dBuA/m, which has the same margin, W dB, to the corresponding RSS-GEN Table 6 limit as it has to be 15.209(a) limit.

Below 1 GHz and above 30 MHz

The setting of the spectrum analyzer

RBW	120 kHz
VBW	300 kHz
Sweep	Auto
Detector	Peak/QP
Trace	Max hold

1. The testing follows the guidelines in ANSI C63.10-2013 clause 6.5.
2. The EUT was arranged to its worst case and then tune the antenna tower (from 1 m to 4 m) and turntable (from 0 degree to 360 degrees) to find the maximum reading. A pre-amp and a high pass filter are used for the test in order to get better signal level. Both horizontal and vertical polarizations of the antenna are set to make the measurement.
3. The EUT was placed on a turntable with 80 cm above ground.
4. The EUT was set 3 meters from the interference receiving antenna, which was mounted on the top of a variable height antenna tower.
5. For measurement below 1 GHz, the initial step in collecting conducted emission data is a spectrum analyzer peak detector mode pre-scanning the measurement frequency range. Significant peaks are then marked and then Quasi Peak detector mode re-measured. If the emission level of the EUT measured by the peak detector is 3 dB lower than the applicable limit, the peak emission level will be reported. Otherwise, the emission measurement will be repeated using the quasi-peak detector and reported.

Above 1 GHz

The setting of the spectrum analyzer

RBW	1 MHz
VBW	PEAK: 3 MHz AVG: see note 6
Sweep	Auto
Detector	Peak
Trace	Max hold

1. The testing follows the guidelines in ANSI C63.10-2013 clause 6.6.
2. The EUT was arranged to its worst case and then tune the antenna tower (from 1 m to 4 m) and turntable (from 0 degree to 360 degrees) to find the maximum reading. A pre-amp and a high pass filter are used for the test in order to get better signal level. Both horizontal and vertical polarizations of the antenna are set to make the measurement.
3. The EUT was placed on a turntable with 1.5 m above ground.
4. The EUT was set 3 meters from the interference receiving antenna, which was mounted on the top of a variable height antenna tower.
5. For measurement above 1 GHz, the emission measurement will be measured by the peak detector. This peak level, once corrected, must comply with the limit specified in Section 15.209.
6. For measurements above 1 GHz the resolution bandwidth is set to 1 MHz, then the video bandwidth is set to 3 MHz for peak measurements and 1 MHz resolution bandwidth with 1/T video bandwidth with peak detector for average measurements. For the Duty Cycle please refer to clause 7.5.ON TIME AND DUTY CYCLE.

Note: The EUT was fully exercised with external accessories during the test. In the case of multiple accessory external ports, an external accessory shall be connected to one of each type of port.

For Restricted Bandedge:

Note:

1. Measurement = Reading Level + Correct Factor.
2. If the peak values are less than the average limit of 54 dBuV/m, the average result is deemed to comply with average limit.
3. Peak: Peak detector.
4. AVG: $VBW=1/Ton$, where: Ton is the transmitting duration.
5. For the transmitting duration, please refer to clause 7.5.
6. Only the worst data was recorded, if it complies with the limit, the other emissions deemed to comply with the limit.
7. Both horizontal and vertical have been tested, only the worst data was recorded in the report.
8. All modes, channels and antennas have been tested, only the worst data was recorded in the report.

For Radiate Spurious emission (9 kHz ~ 30 MHz):

Note:

1. Measurement = Reading Level + Correct Factor.
2. If the peak values are less than the QP limit, the QP result is deemed to comply with QP limit.
3. All 3 polarizations (Horizontal, Face-on and Face-off) of the loop antenna had been tested, but only the worst data recorded in the report.
4. All modes, channels and antennas have been tested, only the worst data was recorded in the report.

For Radiate Spurious Emission (30 MHz ~ 1 GHz):

Note:

1. Result Level = Read Level + Correct Factor.
2. If the peak values are less than the QP limit, the QP result is deemed to comply with QP limit.
3. All modes, channels and antennas have been tested, only the worst data was recorded in the report.

For Radiate Spurious Emission (1 GHz ~ 3 GHz):

1. Measurement = Reading Level + Correct Factor.
2. If the peak values are less than the average limit of 54 dBuV/m, the average result is deemed to comply with average limit.
3. Peak: Peak detector.
4. AVG: $VBW=1/T_{on}$, where: T_{on} is the transmitting duration.
5. For the transmitting duration, please refer to clause 7.5.
6. Filter losses were only considered in the spurious frequency bands and the authorized band was not corrected for Band reject filter losses.
7. Proper operation of the transmitter prior to adding the filter to the measurement chain.
8. All modes, channels and antennas have been tested, only the worst data was recorded in the report.

For Radiate Spurious Emission (3 GHz ~ 18 GHz):

Note:

1. Peak Result = Reading Level + Correct Factor.
2. If the peak values are less than the average limit of 54 dBuV/m, the average result is deemed to comply with average limit.
3. Peak: Peak detector.
4. AVG: $VBW=1/T_{on}$, where: T_{on} is the transmitting duration.
5. For the transmitting duration, please refer to clause 7.5.
6. Filter losses were only considered in the spurious frequency bands and the authorized band was not corrected for High Pass Filter losses.
7. Proper operation of the transmitter prior to adding the filter to the measurement chain.
8. All modes, channels and antennas have been tested, only the worst data was recorded in the report.

For Radiate Spurious emission (18 GHz ~ 26 GHz):

Note:

1. Measurement = Reading Level + Correct Factor.
2. If the peak values are less than the average limit of 54 dBuV/m, the average result is deemed to comply with average limit.
3. Peak: Peak detector.
4. All modes, channels and antennas have been tested, only the worst data was recorded in the report.

TEST SETUP

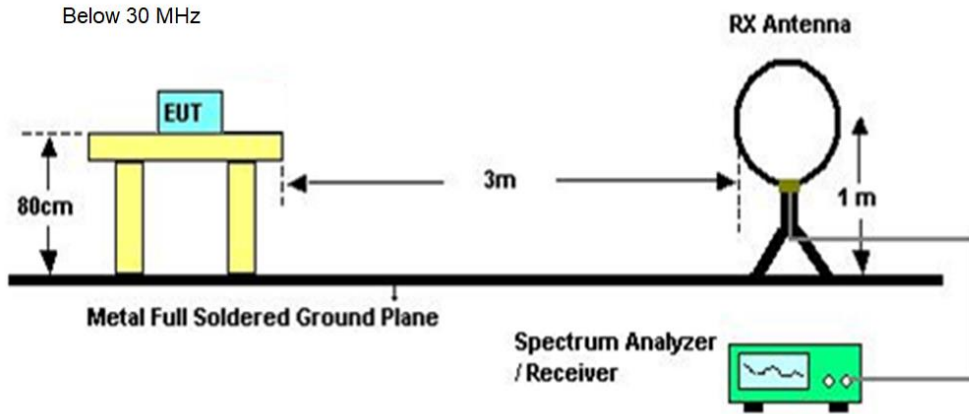

Below 1 GHz and above 30 MHz

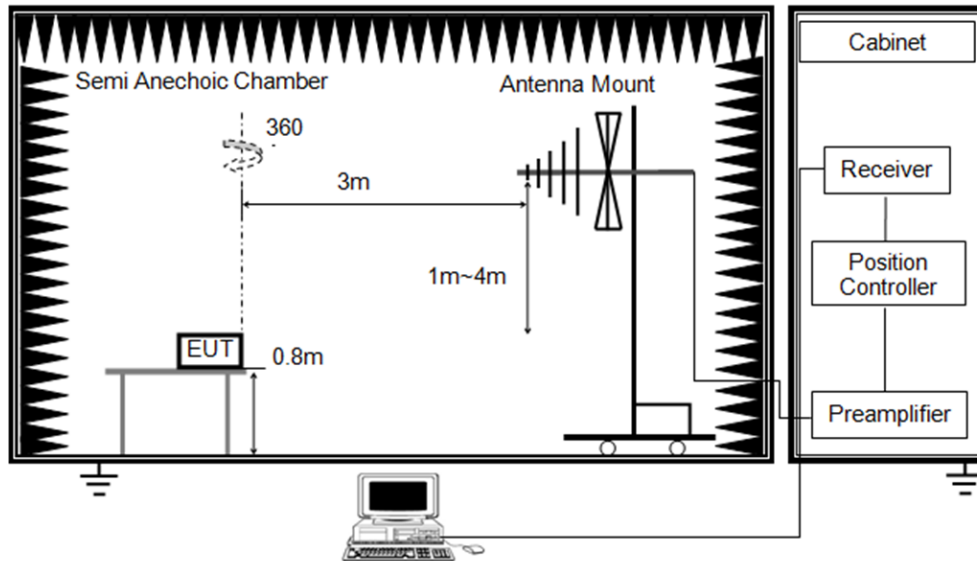

Above 1 GHz

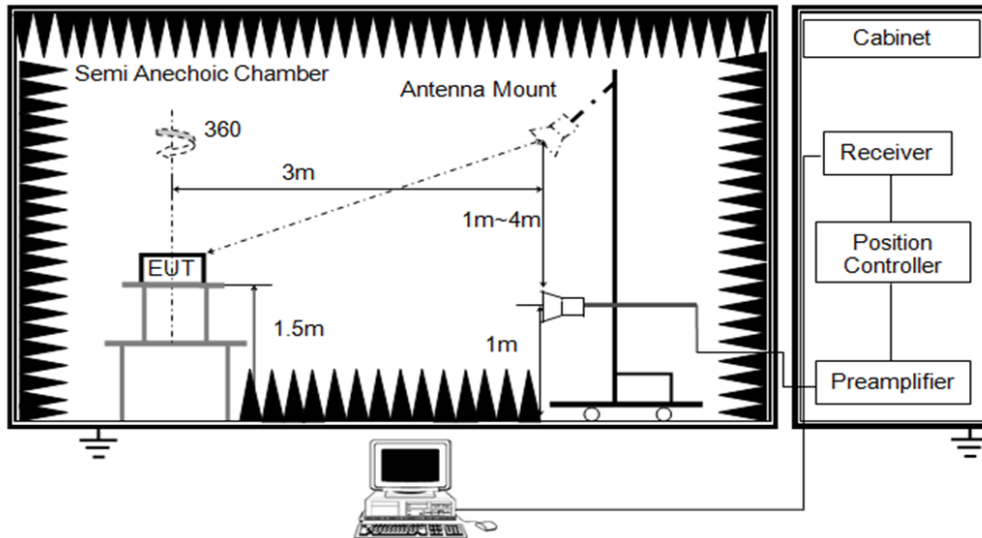

TEST ENVIRONMENT

Temperature	25.1 °C	Relative Humidity	63%
Atmosphere Pressure	101 kPa	Test Voltage	AC 120, 60 Hz

TEST RESULTS

8.1. RESTRICTED BANDEDGE

Test Mode:	BLE 1M Peak	Channel:	2402 MHz
Polarity:	Vertical	Test Voltage:	AC 120 V, 60 Hz

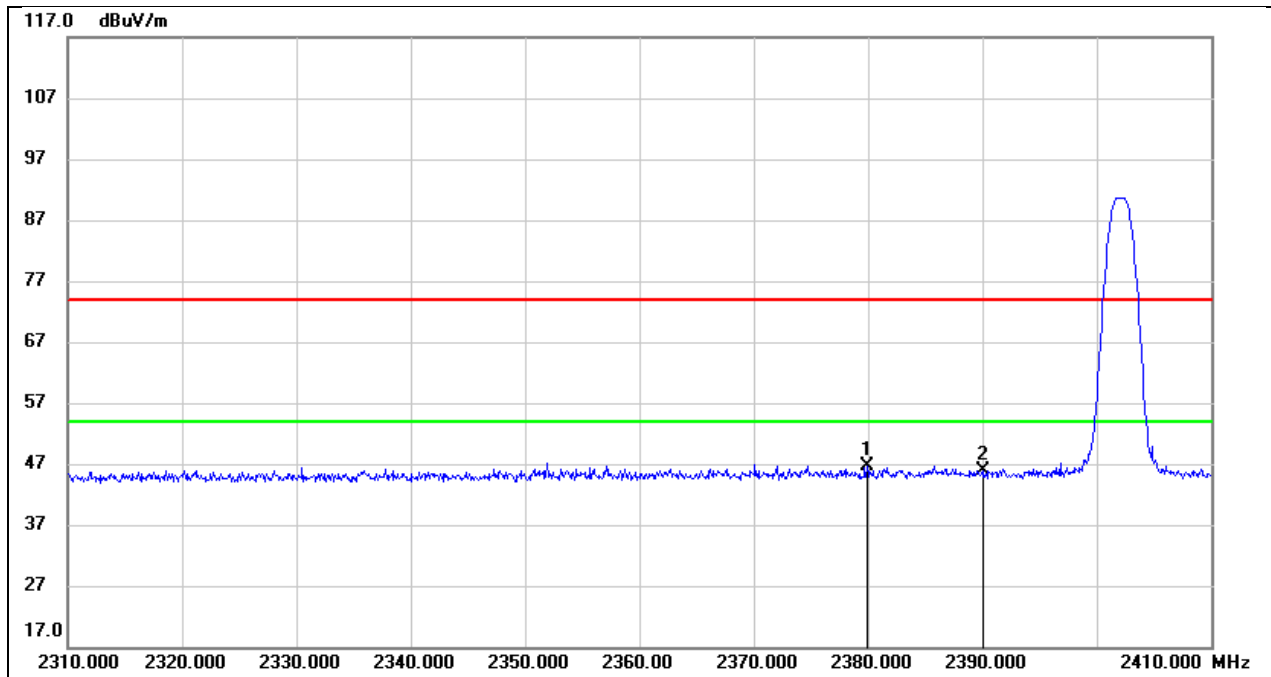

No.	Frequency (MHz)	Reading (dBuV)	Correct (dB/m)	Result (dBuV/m)	Limit (dBuV/m)	Margin (dB)	Remark
1	2379.900	14.48	32.13	46.61	74.00	-27.39	peak
2	2390.000	13.83	32.16	45.99	74.00	-28.01	peak

Test Mode:	BLE 1M Peak	Channel:	2480 MHz
Polarity:	Vertical	Test Voltage:	AC 120 V, 60 Hz

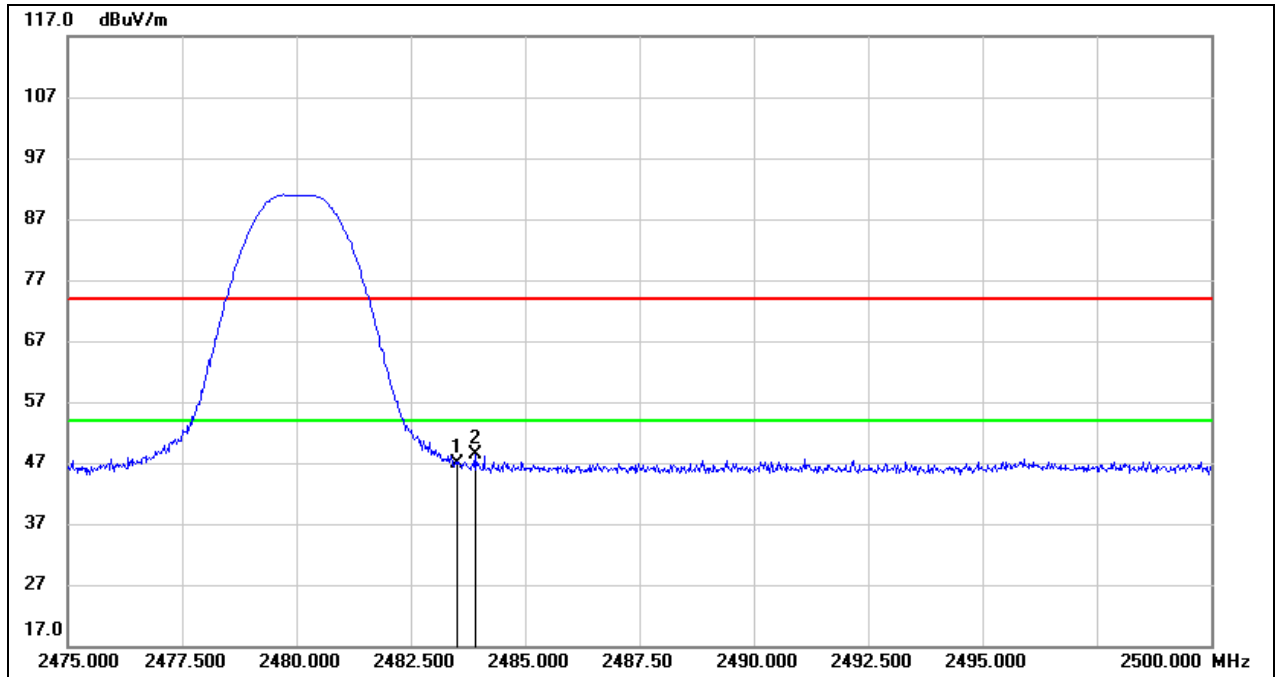

No.	Frequency (MHz)	Reading (dBuV)	Correct (dB/m)	Result (dBuV/m)	Limit (dBuV/m)	Margin (dB)	Remark
1	2483.500	14.50	32.44	46.94	74.00	-27.06	peak
2	2483.900	15.99	32.44	48.43	74.00	-25.57	peak

Test Mode:	BLE 2M Peak	Channel:	2402 MHz
Polarity:	Vertical	Test Voltage:	AC 120 V, 60 Hz

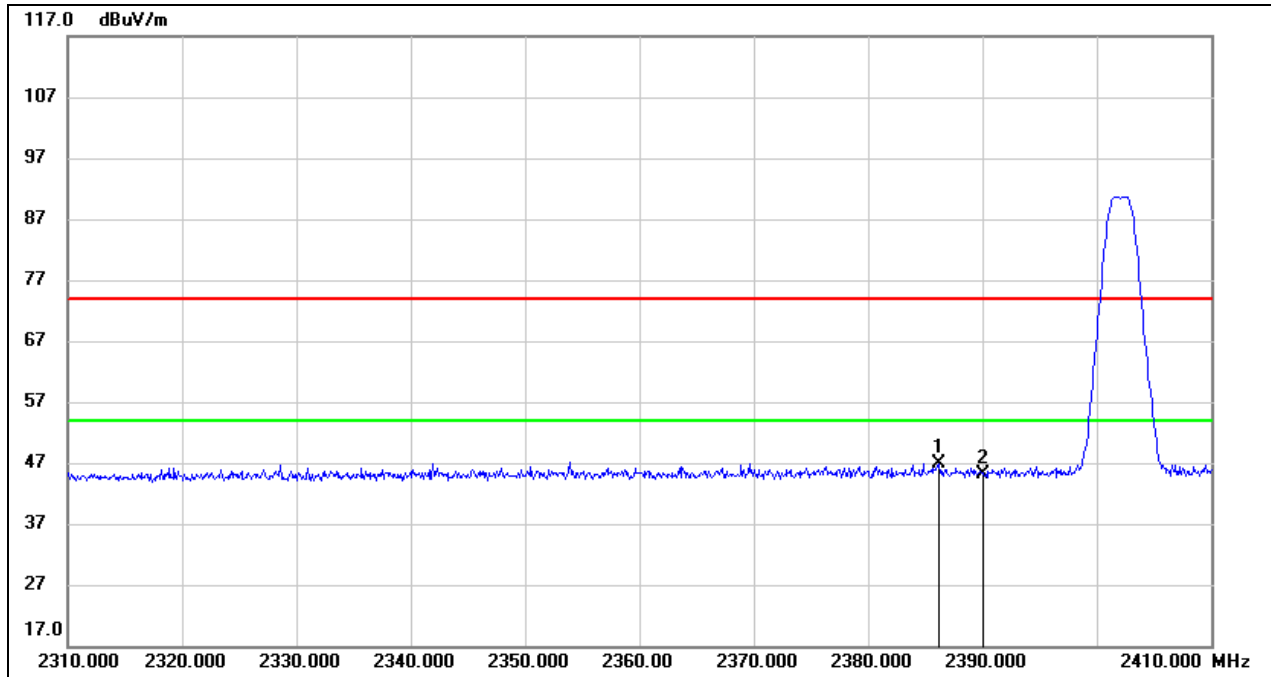

No.	Frequency (MHz)	Reading (dBuV)	Correct (dB/m)	Result (dBuV/m)	Limit (dBuV/m)	Margin (dB)	Remark
1	2386.200	14.81	32.14	46.95	74.00	-27.05	peak
2	2390.000	12.97	32.16	45.13	74.00	-28.87	peak

Test Mode:	BLE 2M Peak	Channel:	2480 MHz
Polarity:	Vertical	Test Voltage:	AC 120 V, 60 Hz

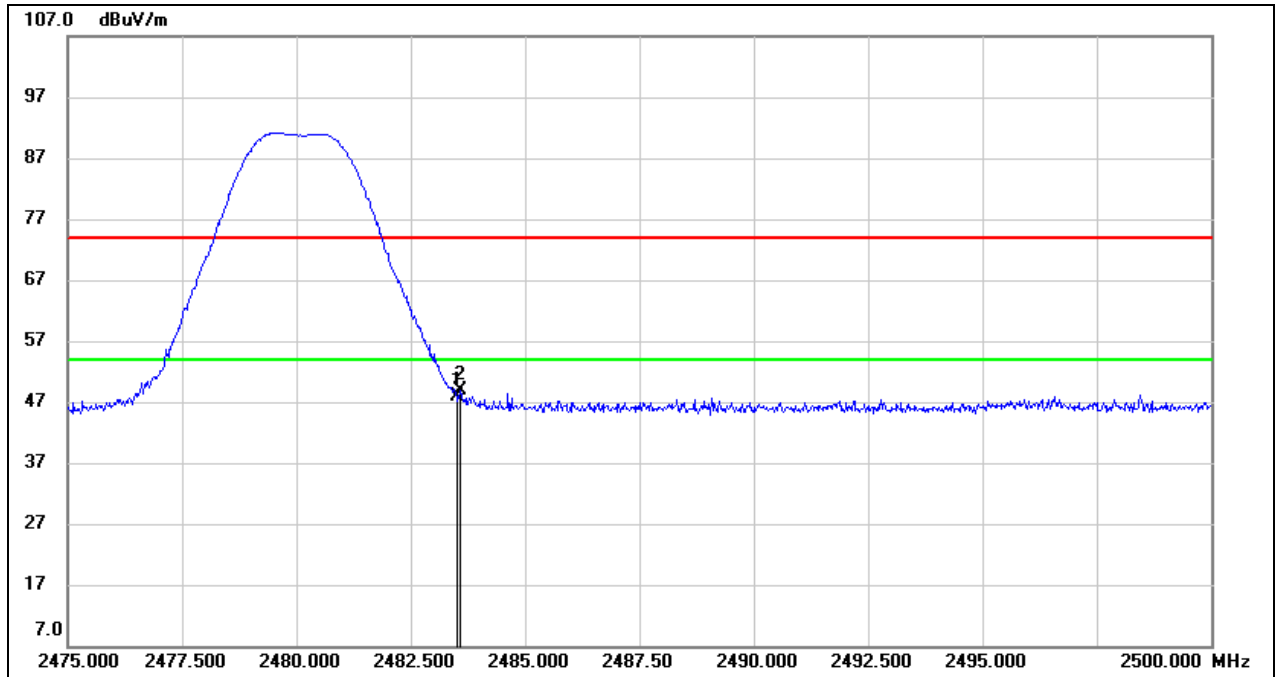

No.	Frequency (MHz)	Reading (dBuV)	Correct (dB/m)	Result (dBuV/m)	Limit (dBuV/m)	Margin (dB)	Remark
1	2483.500	15.43	32.44	47.87	74.00	-26.13	peak
2	2483.575	16.54	32.44	48.98	74.00	-25.02	peak

8.2. SPURIOUS EMISSIONS (1 GHZ ~ 3 GHZ)

Test Mode:	BLE 1M	Channel:	2402 MHz
Polarity:	Horizontal	Test Voltage:	AC 120 V, 60 Hz

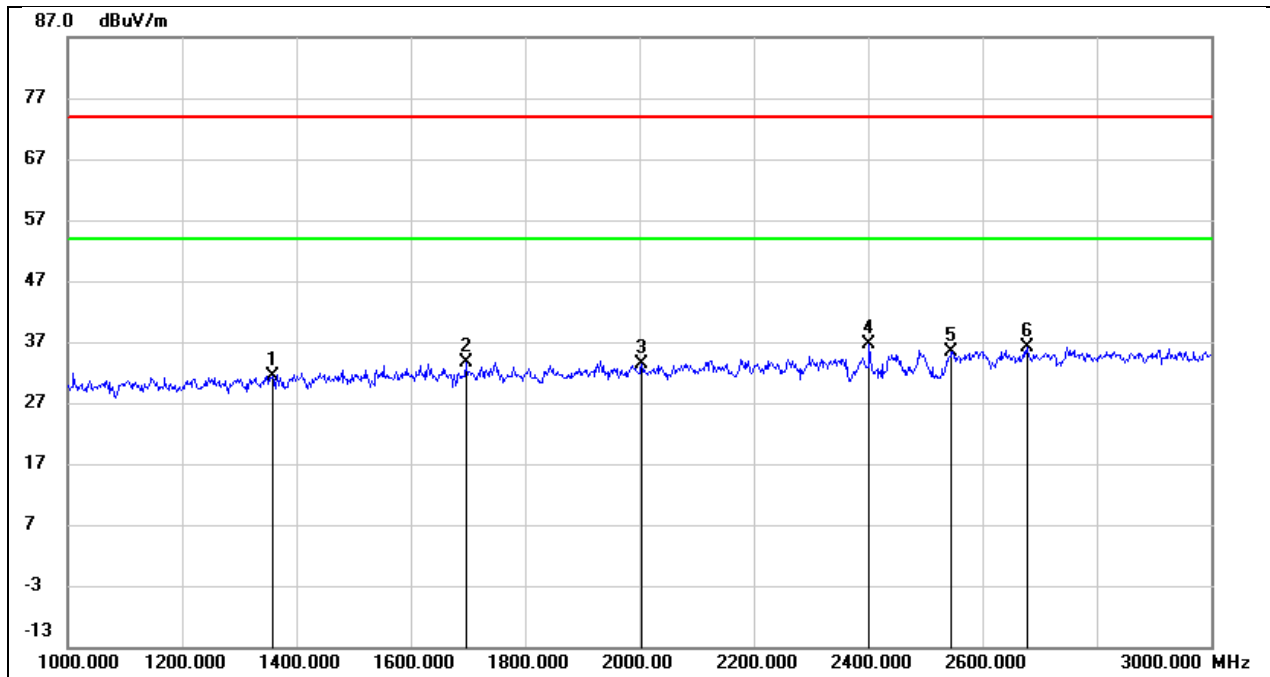

No.	Frequency (MHz)	Reading (dBuV)	Correct (dB/m)	Result (dBuV/m)	Limit (dBuV/m)	Margin (dB)	Remark
1	1358.000	44.78	-13.37	31.41	74.00	-42.59	peak
2	1696.000	45.63	-12.06	33.57	74.00	-40.43	peak
3	2004.000	44.41	-11.04	33.37	74.00	-40.63	peak
4	2402.000	45.59	-8.99	36.60	/	/	Fundamental
5	2546.000	43.73	-8.36	35.37	74.00	-38.63	peak
6	2678.000	43.97	-7.96	36.01	74.00	-37.99	peak

Test Mode:	BLE 1M	Channel:	2402 MHz
Polarity:	Vertical	Test Voltage:	AC 120 V, 60 Hz

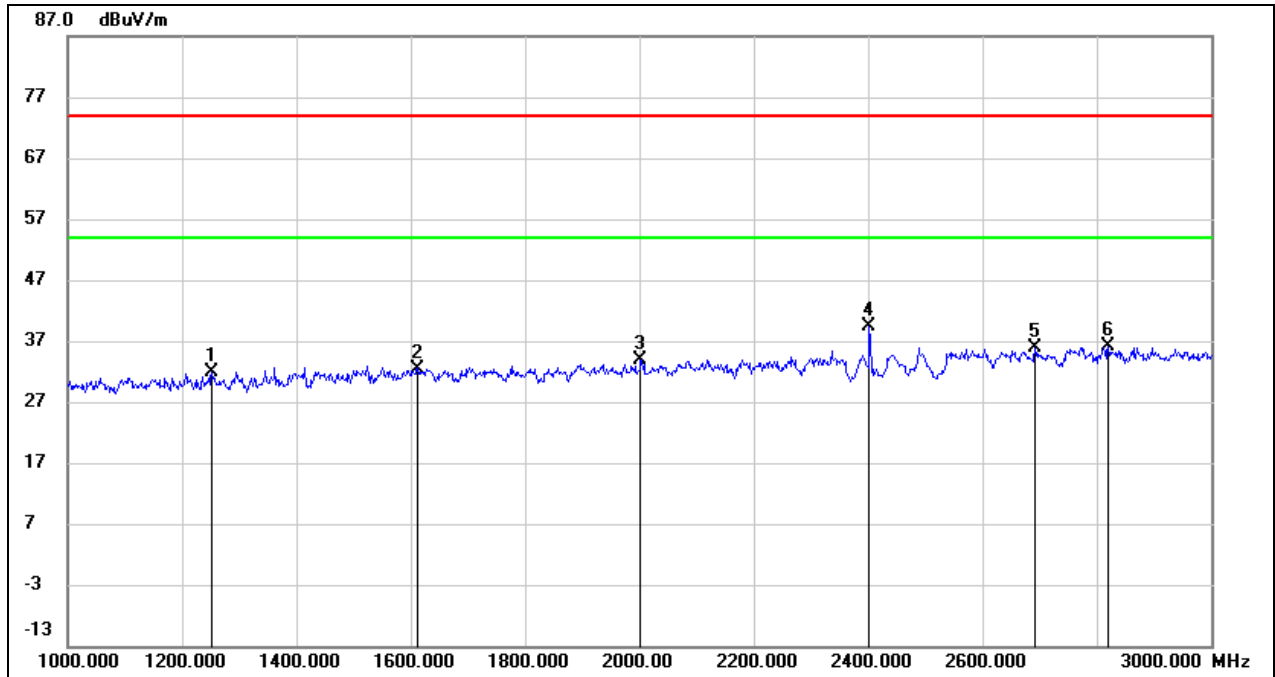

No.	Frequency (MHz)	Reading (dBuV)	Correct (dB/m)	Result (dBuV/m)	Limit (dBuV/m)	Margin (dB)	Remark
1	1252.000	45.73	-13.86	31.87	74.00	-42.13	peak
2	1612.000	44.84	-12.34	32.50	74.00	-41.50	peak
3	2002.000	44.92	-11.05	33.87	74.00	-40.13	peak
4	2402.000	48.44	-8.99	39.45	/	/	Fundamental
5	2692.000	43.71	-7.91	35.80	74.00	-38.20	peak
6	2820.000	43.68	-7.52	36.16	74.00	-37.84	peak

Test Mode:	BLE 1M	Channel:	2440 MHz
Polarity:	Horizontal	Test Voltage:	AC 120 V, 60 Hz

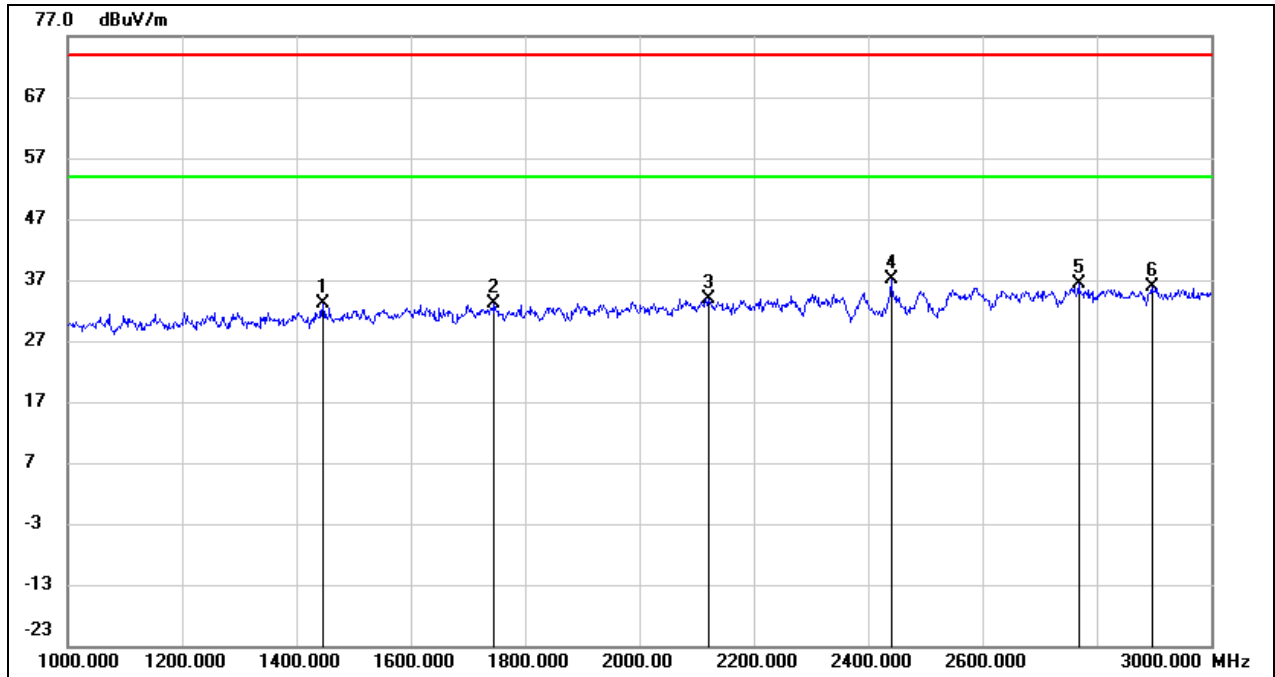

No.	Frequency (MHz)	Reading (dBuV)	Correct (dB/m)	Result (dBuV/m)	Limit (dBuV/m)	Margin (dB)	Remark
1	1446.000	46.06	-12.96	33.10	74.00	-40.90	peak
2	1746.000	44.91	-11.90	33.01	74.00	-40.99	peak
3	2120.000	44.44	-10.45	33.99	74.00	-40.01	peak
4	2440.000	45.83	-8.80	37.03	/	/	Fundamental
5	2768.000	44.00	-7.68	36.32	74.00	-37.68	peak
6	2896.000	43.08	-7.29	35.79	74.00	-38.21	peak

Test Mode:	BLE 1M	Channel:	2440 MHz
Polarity:	Vertical	Test Voltage:	AC 120 V, 60 Hz

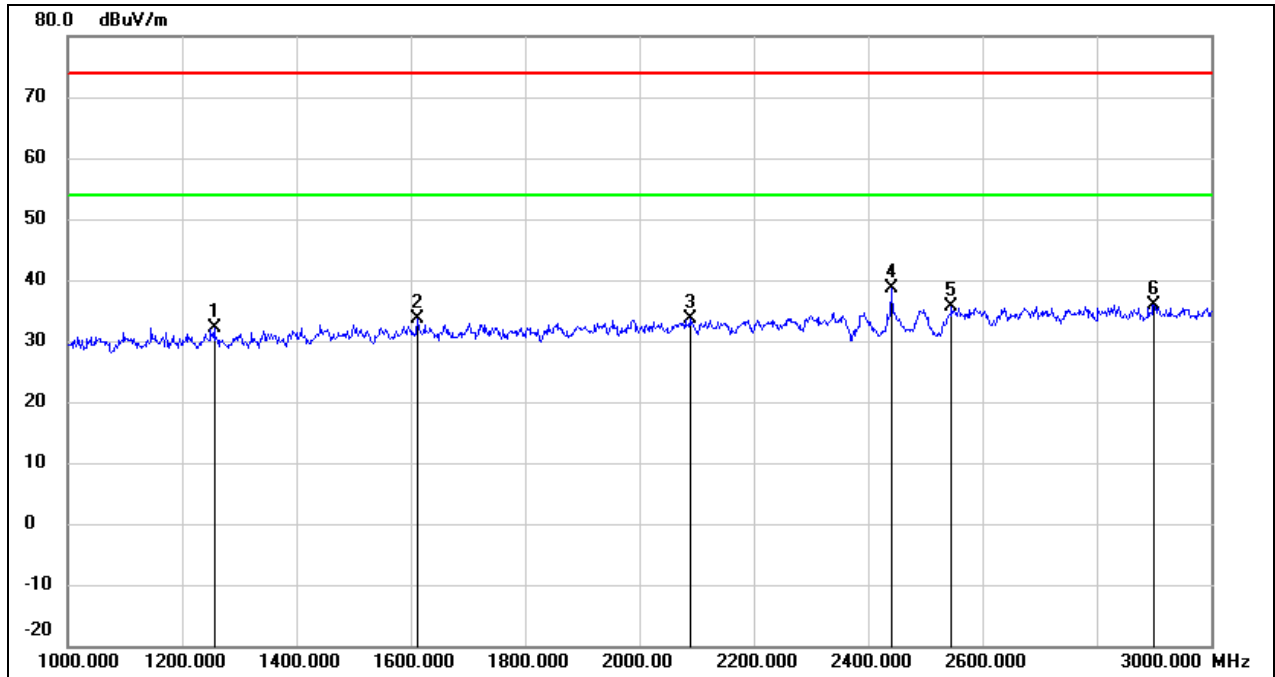

No.	Frequency (MHz)	Reading (dBuV)	Correct (dB/m)	Result (dBuV/m)	Limit (dBuV/m)	Margin (dB)	Remark
1	1256.000	45.88	-13.84	32.04	74.00	-41.96	peak
2	1612.000	45.87	-12.34	33.53	74.00	-40.47	peak
3	2088.000	44.15	-10.61	33.54	74.00	-40.46	peak
4	2440.000	47.50	-8.80	38.70	/	/	Fundamental
5	2546.000	44.11	-8.36	35.75	74.00	-38.25	peak
6	2900.000	43.23	-7.28	35.95	74.00	-38.05	peak

Test Mode:	BLE 1M	Channel:	2480 MHz
Polarity:	Horizontal	Test Voltage:	AC 120 V, 60 Hz

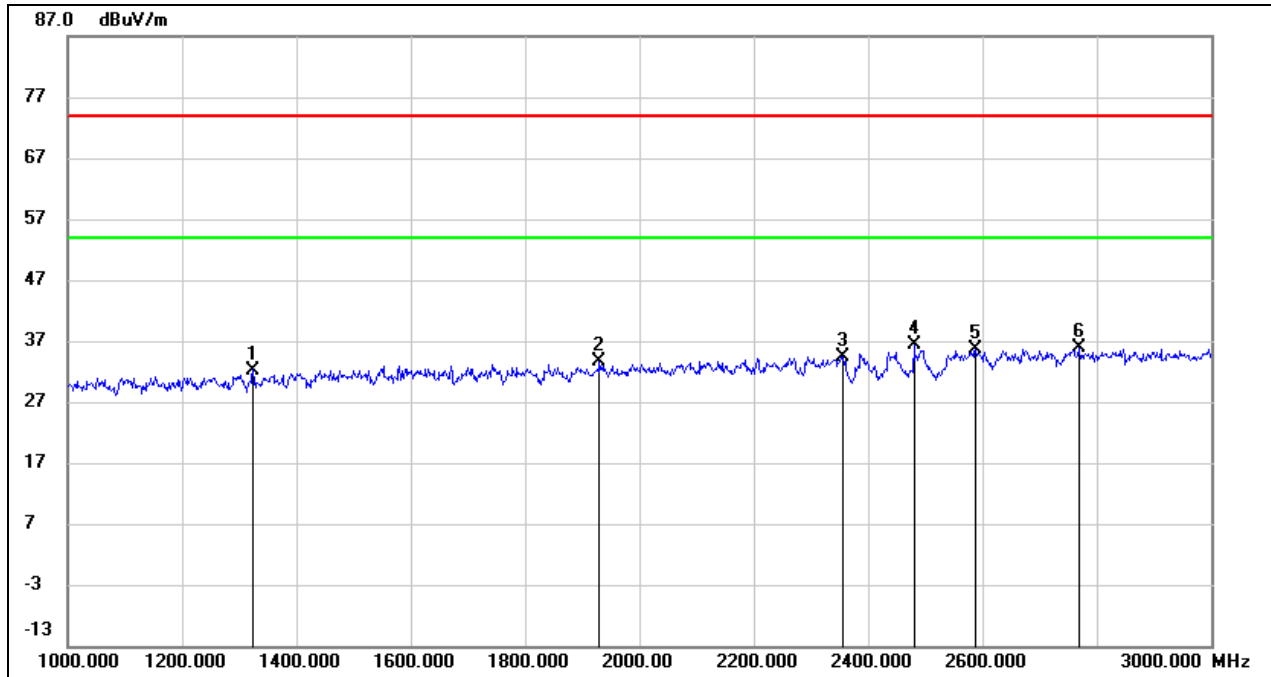

No.	Frequency (MHz)	Reading (dBuV)	Correct (dB/m)	Result (dBuV/m)	Limit (dBuV/m)	Margin (dB)	Remark
1	1324.000	45.78	-13.53	32.25	74.00	-41.75	peak
2	1930.000	44.88	-11.29	33.59	74.00	-40.41	peak
3	2356.000	43.69	-9.22	34.47	74.00	-39.53	peak
4	2480.000	44.95	-8.59	36.36	/	/	Fundamental
5	2588.000	43.80	-8.22	35.58	74.00	-38.42	peak
6	2768.000	43.60	-7.68	35.92	74.00	-38.08	peak

Test Mode:	BLE 1M	Channel:	2480 MHz
Polarity:	Vertical	Test Voltage:	AC 120 V, 60 Hz

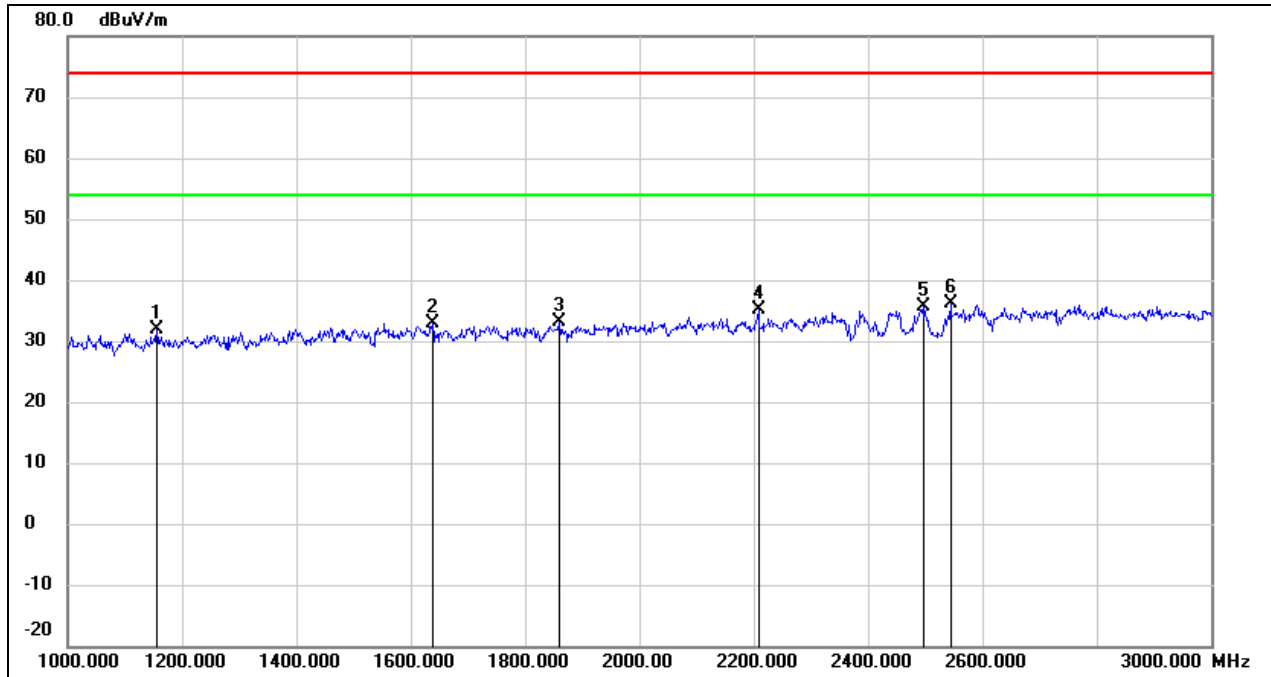

No.	Frequency (MHz)	Reading (dBuV)	Correct (dB/m)	Result (dBuV/m)	Limit (dBuV/m)	Margin (dB)	Remark
1	1156.000	46.14	-14.31	31.83	74.00	-42.17	peak
2	1638.000	45.15	-12.26	32.89	74.00	-41.11	peak
3	1860.000	44.59	-11.53	33.06	74.00	-40.94	peak
4	2208.000	45.01	-9.99	35.02	74.00	-38.98	peak
5	2498.000	44.03	-8.50	35.53	74.00	-38.47	peak
6	2544.000	44.51	-8.36	36.15	74.00	-37.85	peak

8.3. SPURIOUS EMISSIONS (3 GHZ ~ 18 GHZ)

Test Mode:	BLE 1M	Channel:	2402 MHz
Polarity:	Horizontal	Test Voltage:	AC 120 V, 60 Hz

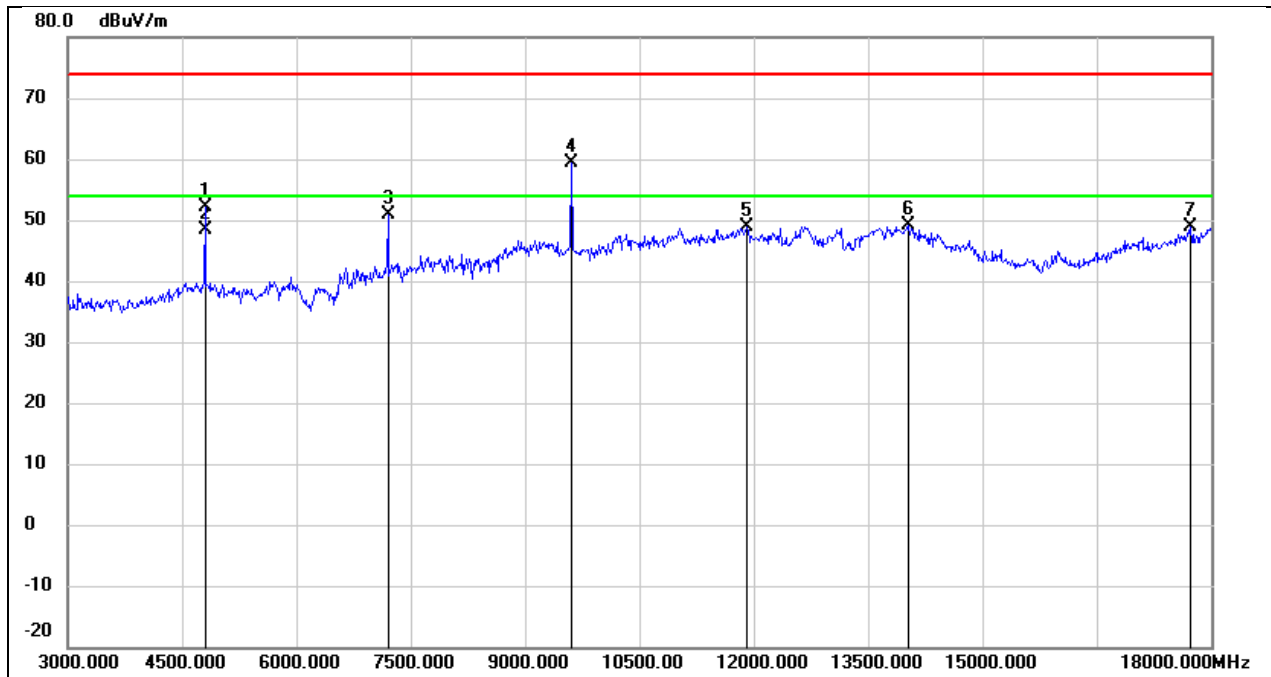

No.	Frequency (MHz)	Reading (dBuV)	Correct (dB/m)	Result (dBuV/m)	Limit (dBuV/m)	Margin (dB)	Remark
1	4800.000	52.46	-0.31	52.15	74.00	-21.85	peak
2	4800.000	48.67	-0.31	48.36	54.00	-5.64	AVG
3	7200.000	44.28	6.55	50.83	74.00	-23.17	peak
4*	9600.000	48.50	10.95	59.45	74.00	-14.55	peak
5	11910.000	31.19	17.72	48.91	74.00	-25.09	peak
6	14025.000	27.27	21.86	49.13	74.00	-24.87	peak
7	17730.000	24.71	24.09	48.80	74.00	-25.20	peak

* The test frequency is out of restricted bands, no limit for radiated spurious emission.

Test Mode:	BLE 1M	Channel:	2402 MHz
Polarity:	Vertical	Test Voltage:	AC 120 V, 60 Hz

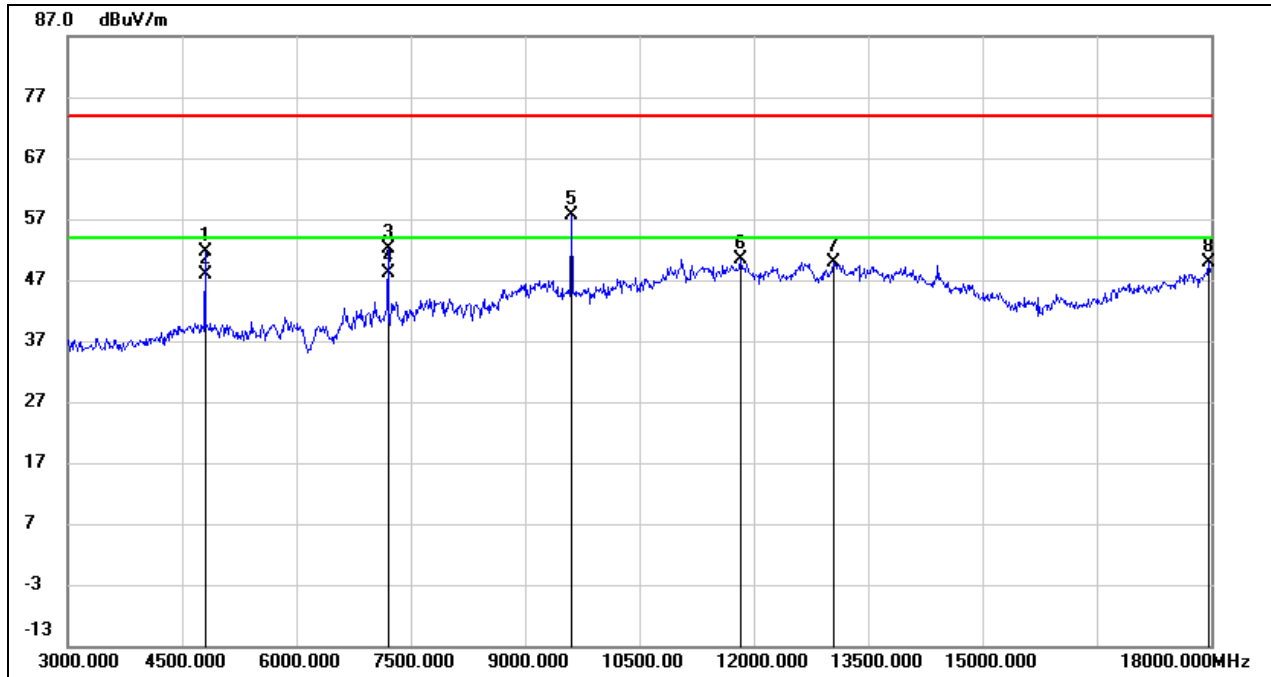

No.	Frequency (MHz)	Reading (dBuV)	Correct (dB/m)	Result (dBuV/m)	Limit (dBuV/m)	Margin (dB)	Remark
1	4800.000	51.94	-0.31	51.63	74.00	-22.37	peak
2	4800.000	48.13	-0.31	47.82	54.00	-6.18	AVG
3	7200.000	45.46	6.55	52.01	74.00	-21.99	peak
4	7200.000	41.60	6.55	48.15	54.00	-5.85	AVG
5*	9600.000	46.67	10.95	57.62	74.00	-16.38	peak
6	11835.000	32.99	17.51	50.50	74.00	-23.50	peak
7	13050.000	31.03	18.93	49.96	74.00	-24.04	peak
8	17970.000	24.48	25.51	49.99	74.00	-24.01	peak

* The test frequency is out of restricted bands, no limit for radiated spurious emission.

Test Mode:	BLE 1M	Channel:	2440 MHz
Polarity:	Horizontal	Test Voltage:	AC 120 V, 60 Hz

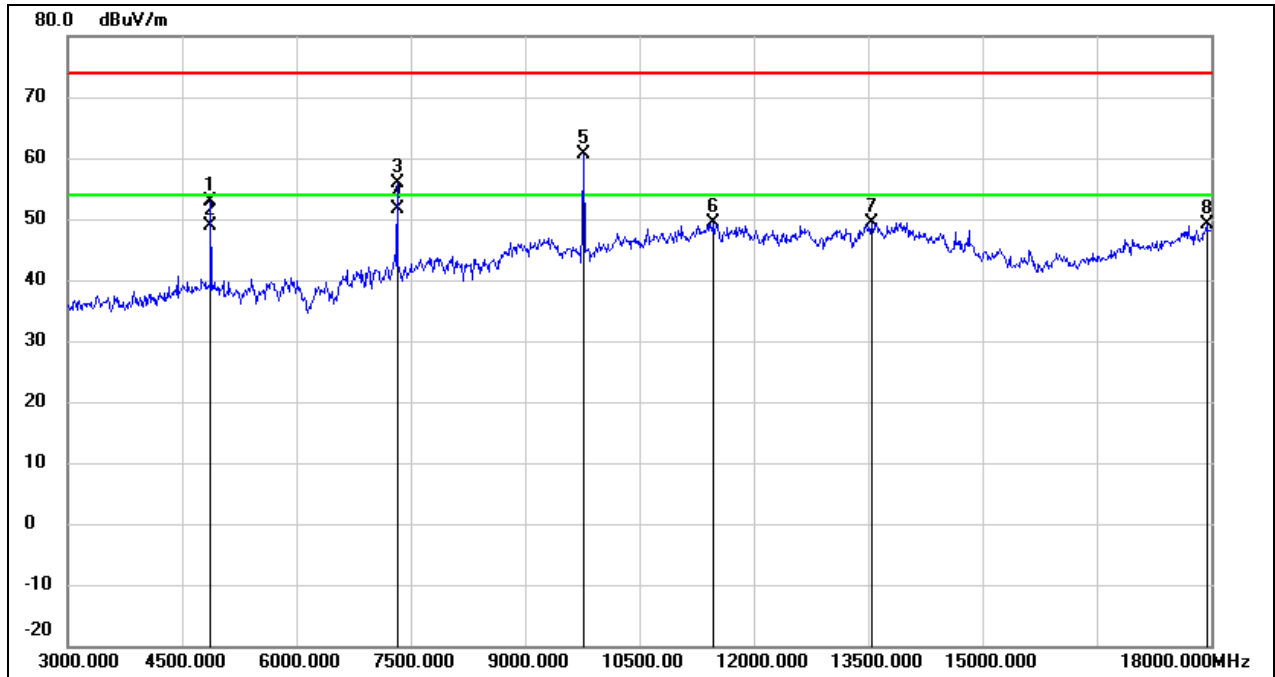

No.	Frequency (MHz)	Reading (dBuV)	Correct (dB/m)	Result (dBuV/m)	Limit (dBuV/m)	Margin (dB)	Remark
1	4875.000	52.91	-0.03	52.88	74.00	-21.12	peak
2	4875.000	48.82	-0.03	48.79	54.00	-5.21	AVG
3	7320.000	49.46	6.46	55.92	74.00	-18.08	peak
4	7320.000	45.17	6.46	51.63	54.00	-2.37	AVG
5*	9765.000	49.25	11.40	60.65	74.00	-13.35	peak
6	11460.000	32.94	16.46	49.40	74.00	-24.60	peak
7	13545.000	28.48	20.99	49.47	74.00	-24.53	peak
8	17940.000	23.75	25.34	49.09	74.00	-24.91	peak

* The test frequency is out of restricted bands, no limit for radiated spurious emission.

Test Mode:	BLE 1M	Channel:	2440 MHz
Polarity:	Vertical	Test Voltage:	AC 120 V, 60 Hz

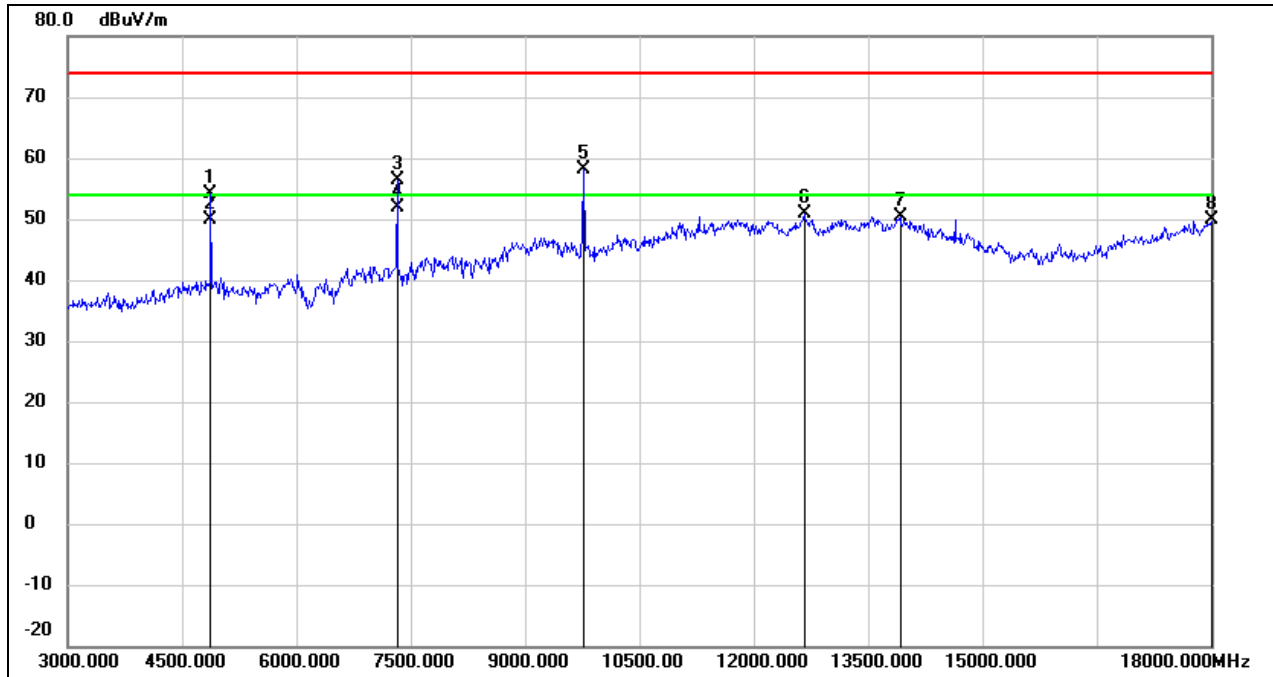

No.	Frequency (MHz)	Reading (dBuV)	Correct (dB/m)	Result (dBuV/m)	Limit (dBuV/m)	Margin (dB)	Remark
1	4875.000	54.22	-0.03	54.19	74.00	-19.81	peak
2	4875.000	49.85	-0.03	49.82	54.00	-4.18	AVG
3	7320.000	49.87	6.46	56.33	74.00	-17.67	peak
4	7320.000	45.47	6.46	51.93	54.00	-2.07	AVG
5*	9765.000	46.77	11.40	58.17	74.00	-15.83	peak
6	12660.000	32.91	17.95	50.86	74.00	-23.14	peak
7	13920.000	28.65	21.79	50.44	74.00	-23.56	peak
8	18000.000	24.15	25.69	49.84	74.00	-24.16	peak

* The test frequency is out of restricted bands, no limit for radiated spurious emission.

Test Mode:	BLE 1M	Channel:	2480 MHz
Polarity:	Horizontal	Test Voltage:	AC 120 V, 60 Hz

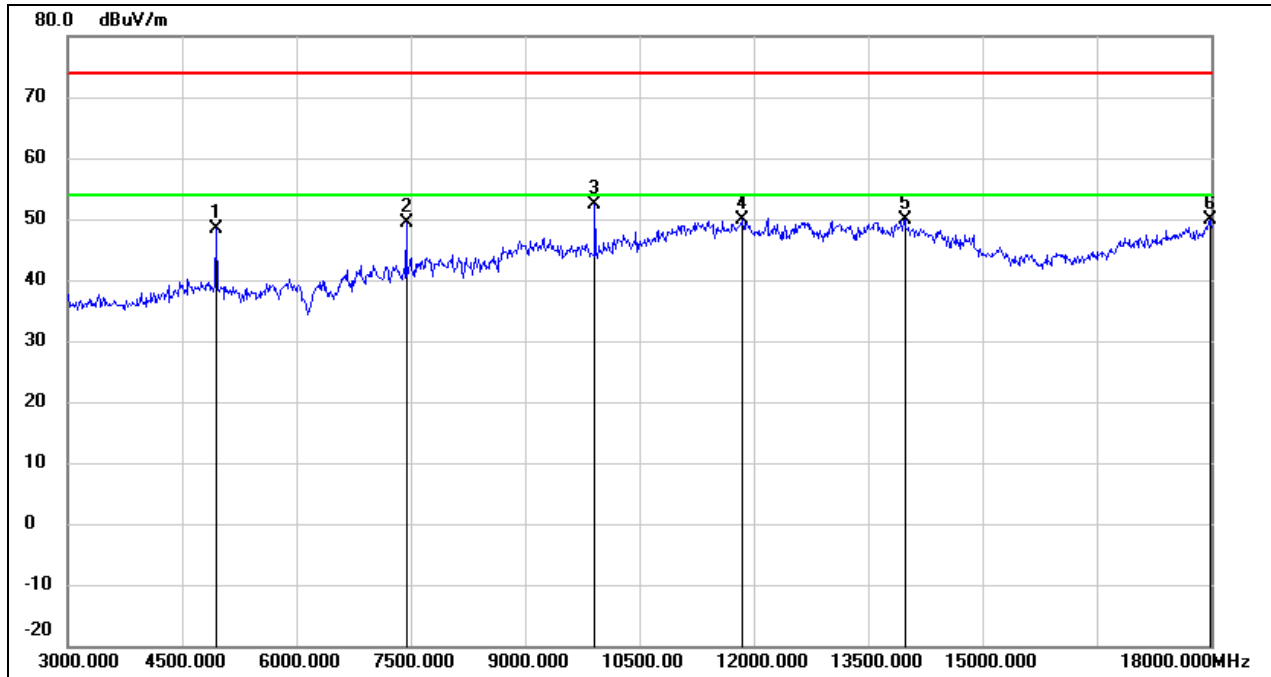

No.	Frequency (MHz)	Reading (dBuV)	Correct (dB/m)	Result (dBuV/m)	Limit (dBuV/m)	Margin (dB)	Remark
1	4950.000	48.15	0.26	48.41	74.00	-25.59	peak
2	7440.000	42.91	6.38	49.29	74.00	-24.71	peak
3	9915.000	40.58	11.80	52.38	74.00	-21.62	peak
4	11850.000	32.23	17.56	49.79	74.00	-24.21	peak
5	13980.000	28.03	21.92	49.95	74.00	-24.05	peak
6	17985.000	24.16	25.60	49.76	74.00	-24.24	peak

Test Mode:	BLE 1M	Channel:	2480 MHz
Polarity:	Vertical	Test Voltage:	AC 120 V, 60 Hz

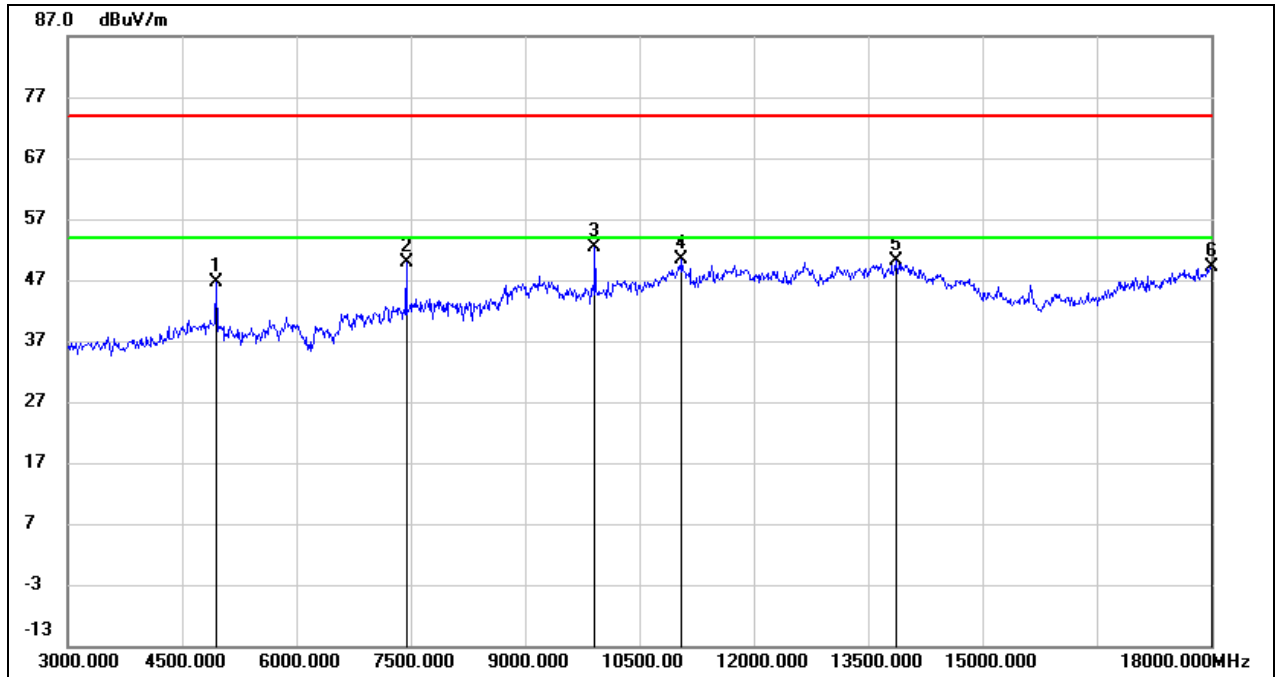

No.	Frequency (MHz)	Reading (dBuV)	Correct (dB/m)	Result (dBuV/m)	Limit (dBuV/m)	Margin (dB)	Remark
1	4950.000	46.36	0.26	46.62	74.00	-27.38	peak
2	7440.000	43.48	6.38	49.86	74.00	-24.14	peak
3	9915.000	40.62	11.80	52.42	74.00	-21.58	peak
4	11055.000	35.38	14.96	50.34	74.00	-23.66	peak
5	13875.000	28.44	21.70	50.14	74.00	-23.86	peak
6	18000.000	23.53	25.69	49.22	74.00	-24.78	peak

Test Mode:	BLE 2M PK	Channel:	2402 MHz
Polarity:	Horizontal	Test Voltage:	AC 120 V, 60 Hz

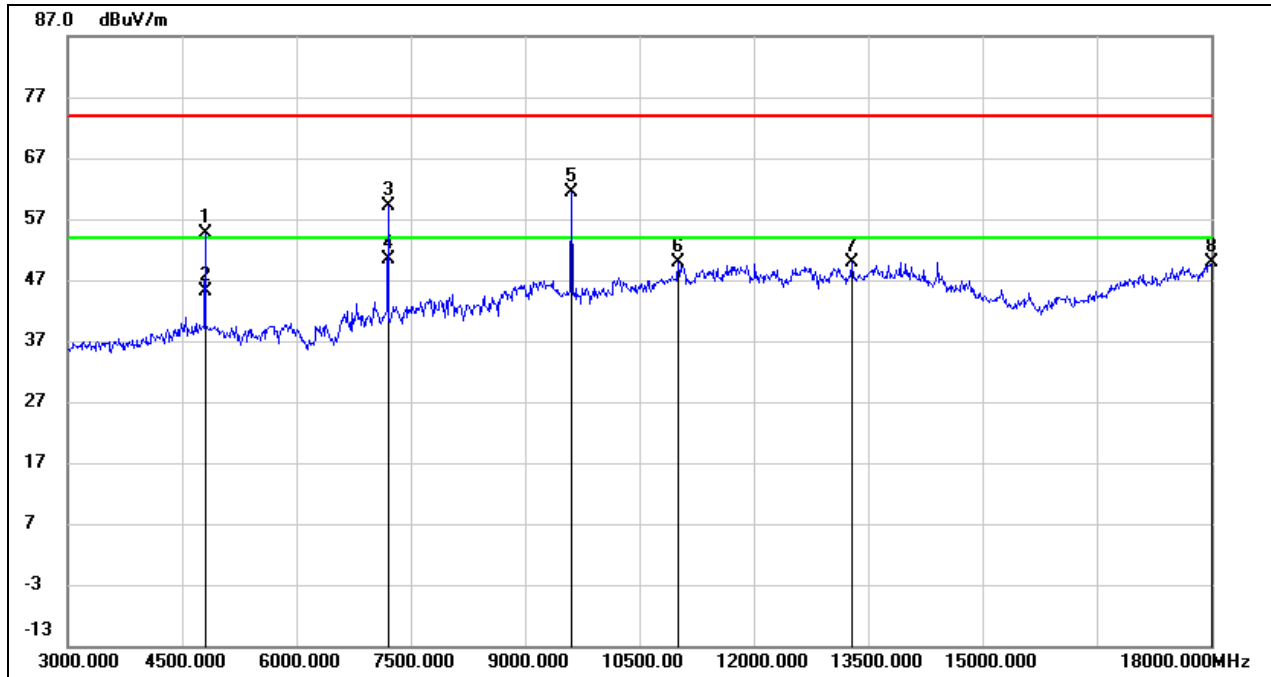

No.	Frequency (MHz)	Reading (dBuV)	Correct (dB/m)	Result (dBuV/m)	Limit (dBuV/m)	Margin (dB)	Remark
1	4800.000	54.84	-0.31	54.53	74.00	-19.47	peak
2	4800.000	45.43	-0.31	45.12	54.00	-8.88	AVG
3	7200.000	52.58	6.55	59.13	74.00	-14.87	peak
4	7200.000	43.81	6.55	50.36	54.00	-3.64	AVG
5*	9600.000	50.48	10.95	61.43	74.00	-12.57	peak
6	11010.000	35.18	14.81	49.99	74.00	-24.01	peak
7	13290.000	29.83	19.99	49.82	74.00	-24.18	peak
8	18000.000	24.22	25.69	49.91	74.00	-24.09	peak

* The test frequency is out of restricted bands, no limit for radiated spurious emission.

Test Mode:	BLE 2M PK	Channel:	2402 MHz
Polarity:	Vertical	Test Voltage:	AC 120 V, 60 Hz

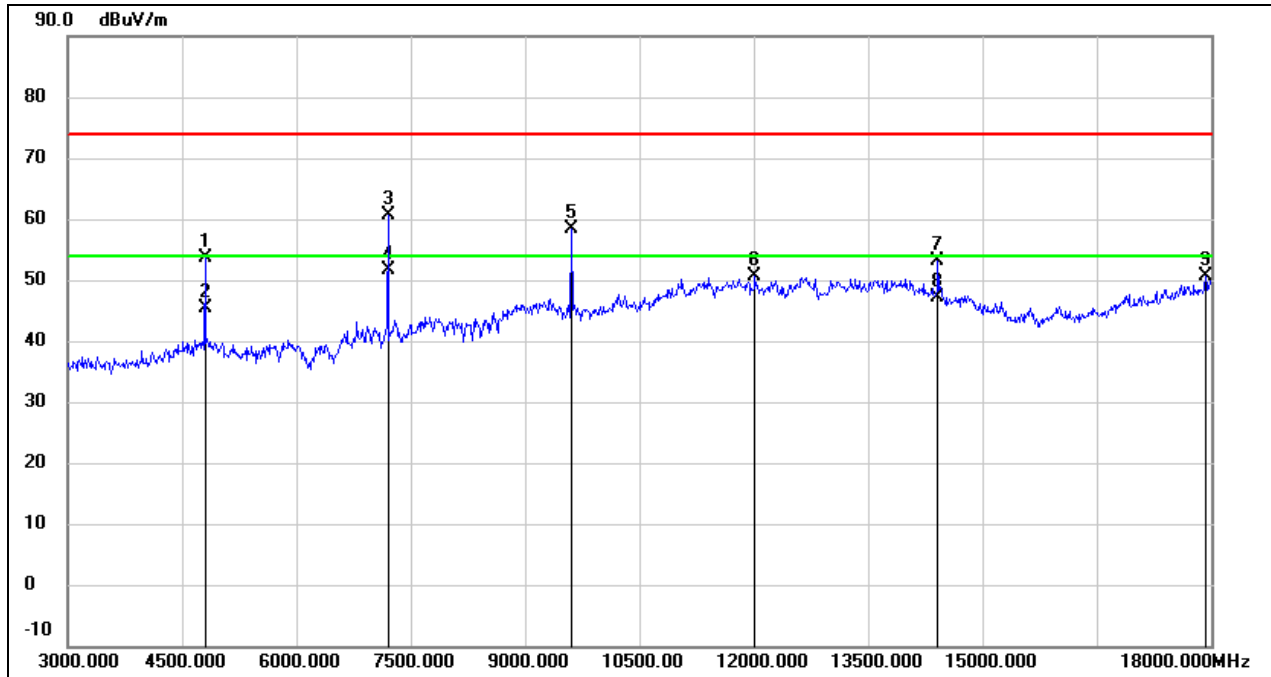

No.	Frequency (MHz)	Reading (dBuV)	Correct (dB/m)	Result (dBuV/m)	Limit (dBuV/m)	Margin (dB)	Remark
1	4800.000	54.00	-0.31	53.69	74.00	-20.31	peak
2	4800.000	45.67	-0.31	45.36	54.00	-8.64	AVG
3	7200.000	54.08	6.55	60.63	74.00	-13.37	peak
4	7200.000	45.10	6.55	51.65	54.00	-2.35	AVG
5*	9600.000	47.42	10.95	58.37	74.00	-15.63	peak
6	12015.000	32.56	17.95	50.51	74.00	-23.49	peak
7	14415.000	32.93	20.26	53.19	74.00	-20.81	peak
8	14415.000	26.79	20.26	47.05	54.00	-6.95	AVG
9	17925.000	25.32	25.25	50.57	74.00	-23.43	peak

* The test frequency is out of restricted bands, no limit for radiated spurious emission.

Test Mode:	BLE 2M PK	Channel:	2440 MHz
Polarity:	Horizontal	Test Voltage:	AC 120 V, 60 Hz

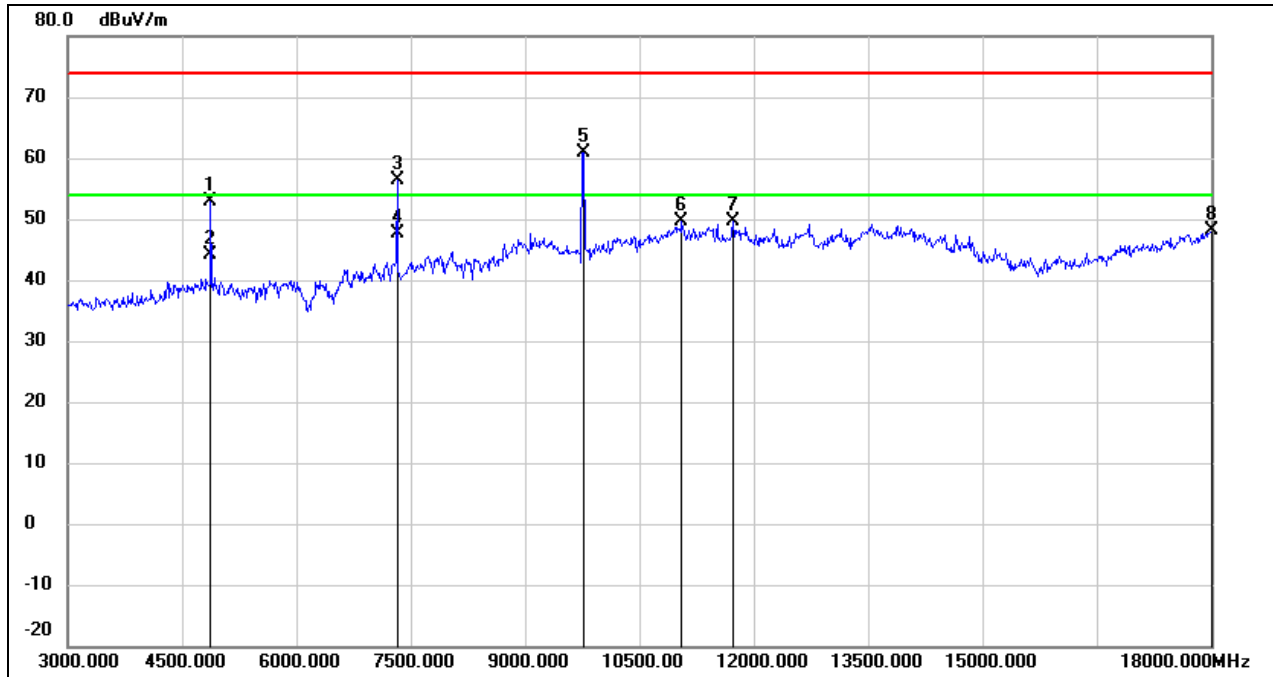

No.	Frequency (MHz)	Reading (dBuV)	Correct (dB/m)	Result (dBuV/m)	Limit (dBuV/m)	Margin (dB)	Remark
1	4875.000	52.92	-0.03	52.89	74.00	-21.11	peak
2	4875.000	44.23	-0.03	44.20	54.00	-9.80	AVG
3	7320.000	49.85	6.46	56.31	74.00	-17.69	peak
4	7320.000	41.23	6.46	47.69	54.00	-6.31	AVG
5*	9765.000	49.60	11.40	61.00	74.00	-13.00	peak
6	11055.000	34.59	14.96	49.55	74.00	-24.45	peak
7	11730.000	32.37	17.22	49.59	74.00	-24.41	peak
8	18000.000	22.45	25.69	48.14	74.00	-25.86	peak

* The test frequency is out of restricted bands, no limit for radiated spurious emission.

Test Mode:	BLE 2M PK	Channel:	2440 MHz
Polarity:	Vertical	Test Voltage:	AC 120 V, 60 Hz

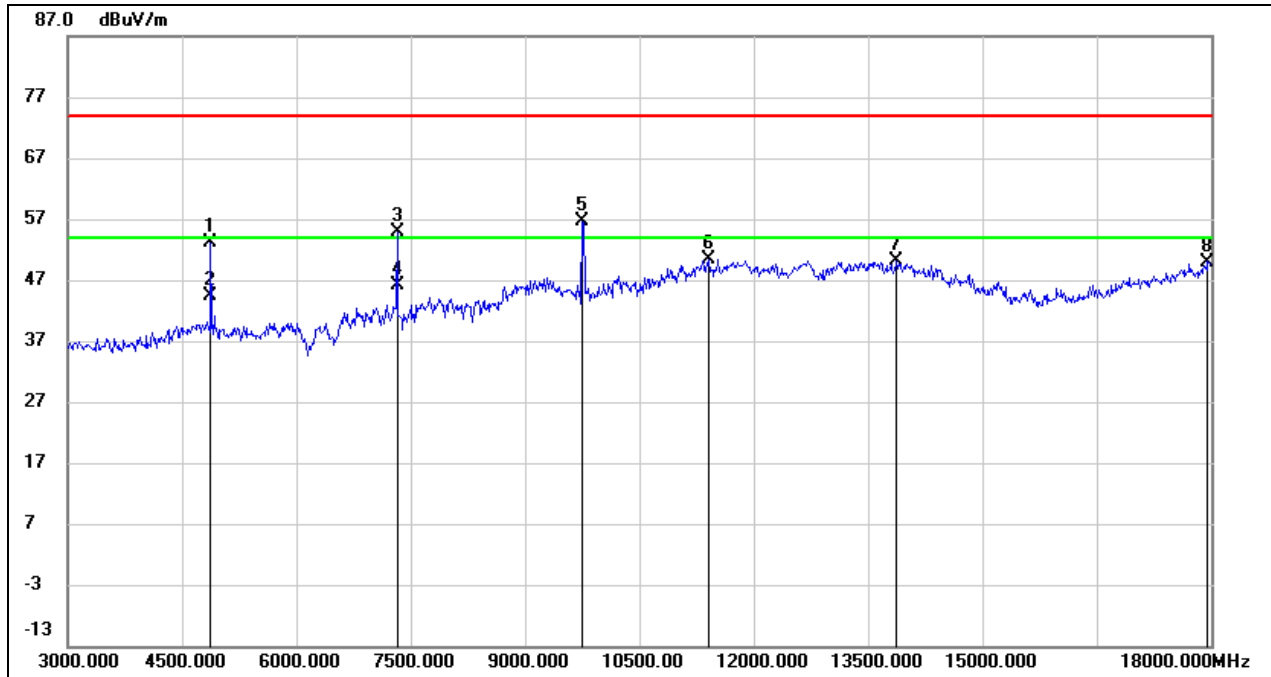

No.	Frequency (MHz)	Reading (dBuV)	Correct (dB/m)	Result (dBuV/m)	Limit (dBuV/m)	Margin (dB)	Remark
1	4875.000	53.14	-0.03	53.11	74.00	-20.89	peak
2	4875.000	44.35	-0.03	44.32	54.00	-9.68	AVG
3	7320.000	48.54	6.46	55.00	74.00	-19.00	peak
4	7320.000	39.75	6.46	46.21	54.00	-7.79	AVG
5*	9750.000	45.34	11.35	56.69	74.00	-17.31	peak
6	11415.000	34.18	16.29	50.47	74.00	-23.53	peak
7	13875.000	28.44	21.70	50.14	74.00	-23.86	peak
8	17955.000	24.58	25.42	50.00	74.00	-24.00	peak

* The test frequency is out of restricted bands, no limit for radiated spurious emission.

Test Mode:	BLE 2M PK	Channel:	2480 MHz
Polarity:	Horizontal	Test Voltage:	AC 120 V, 60 Hz

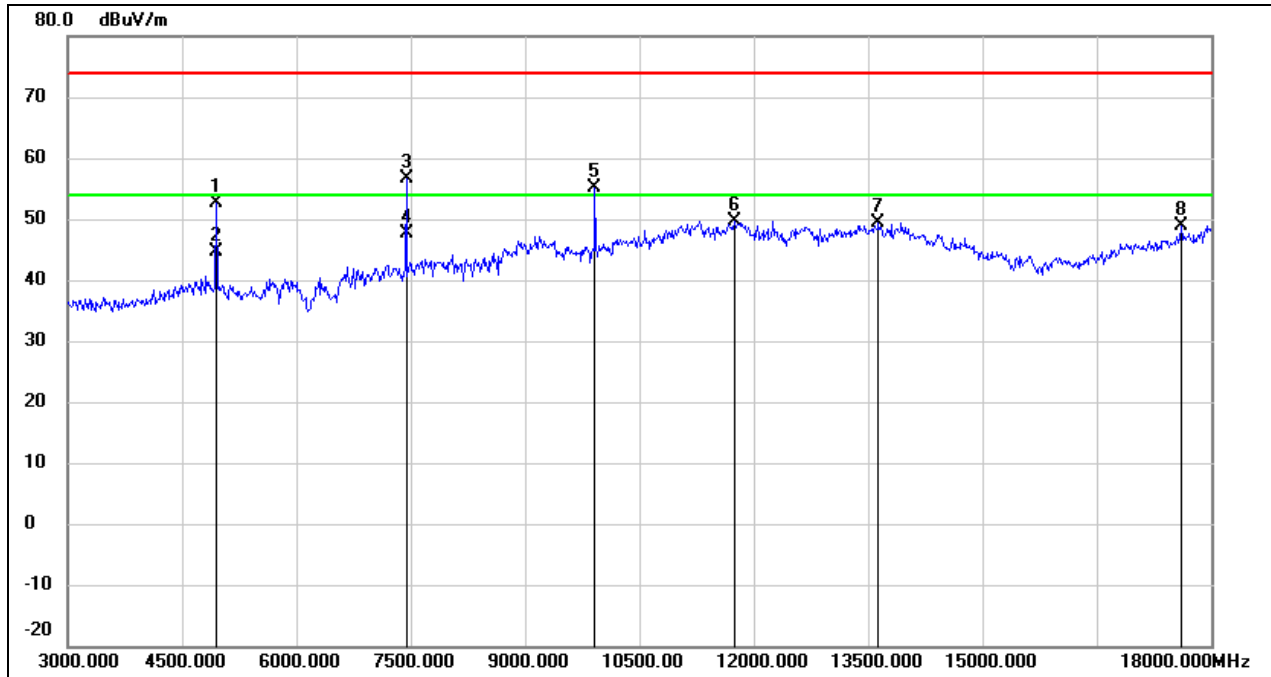

No.	Frequency (MHz)	Reading (dBuV)	Correct (dB/m)	Result (dBuV/m)	Limit (dBuV/m)	Margin (dB)	Remark
1	4950.000	52.27	0.26	52.53	74.00	-21.47	peak
2	4950.000	44.25	0.26	44.51	54.00	-9.49	AVG
3	7440.000	50.37	6.38	56.75	74.00	-17.25	peak
4	7440.000	41.30	6.38	47.68	54.00	-6.32	AVG
5*	9915.000	43.24	11.80	55.04	74.00	-18.96	peak
6	11745.000	32.45	17.27	49.72	74.00	-24.28	peak
7	13635.000	28.23	21.19	49.42	74.00	-24.58	peak
8	17610.000	25.38	23.38	48.76	74.00	-25.24	peak

* The test frequency is out of restricted bands, no limit for radiated spurious emission.

Test Mode:	BLE 2M PK	Channel:	2480 MHz
Polarity:	Vertical	Test Voltage:	AC 120 V, 60 Hz

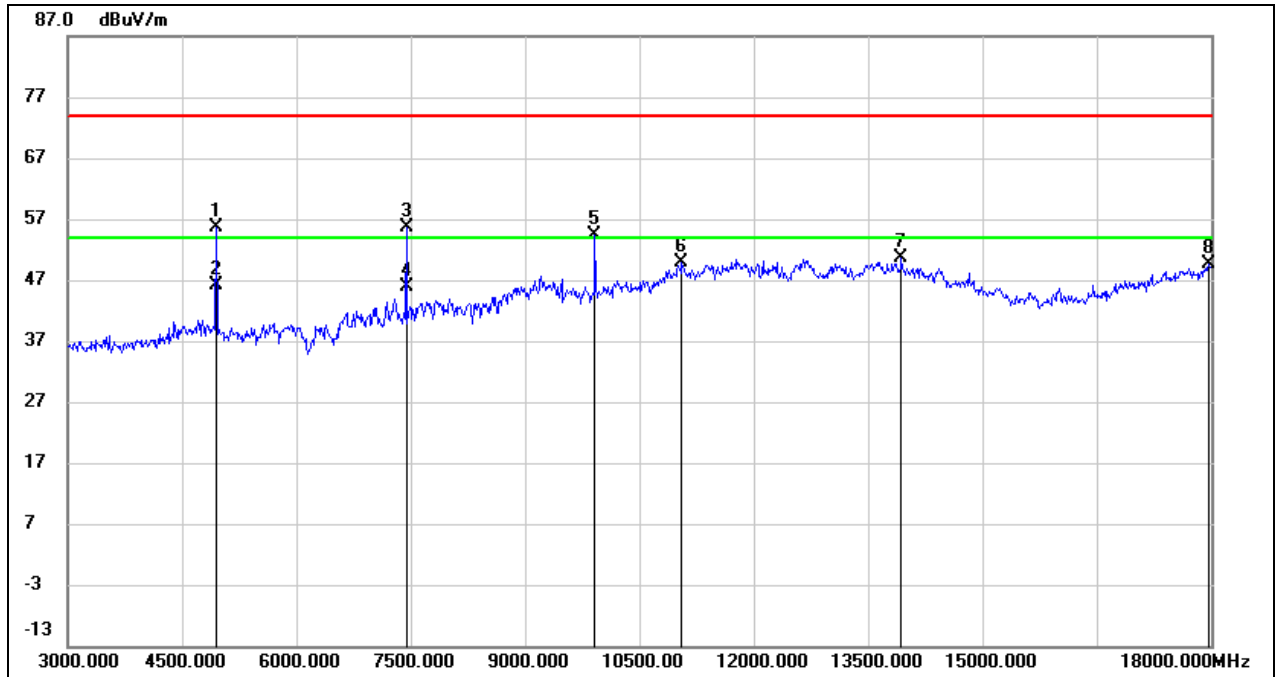

No.	Frequency (MHz)	Reading (dBuV)	Correct (dB/m)	Result (dBuV/m)	Limit (dBuV/m)	Margin (dB)	Remark
1	4950.000	55.41	0.26	55.67	74.00	-18.33	peak
2	4950.000	45.97	0.26	46.23	54.00	-7.77	AVG
3	7440.000	49.16	6.38	55.54	74.00	-18.46	peak
4	7440.000	39.49	6.38	45.87	54.00	-8.13	AVG
5*	9915.000	42.66	11.80	54.46	74.00	-19.54	peak
6	11055.000	34.95	14.96	49.91	74.00	-24.09	peak
7	13935.000	28.84	21.82	50.66	74.00	-23.34	peak
8	17970.000	24.17	25.51	49.68	74.00	-24.32	peak

* The test frequency is out of restricted bands, no limit for radiated spurious emission.

8.4. SPURIOUS EMISSIONS (9 KHZ ~ 30 MHZ)

Test Mode:	BLE 2M	Channel:	2402 MHz
Polarity:	Loop Antenna Face On To The EUT	Test Voltage	AC 120 V, 60 Hz

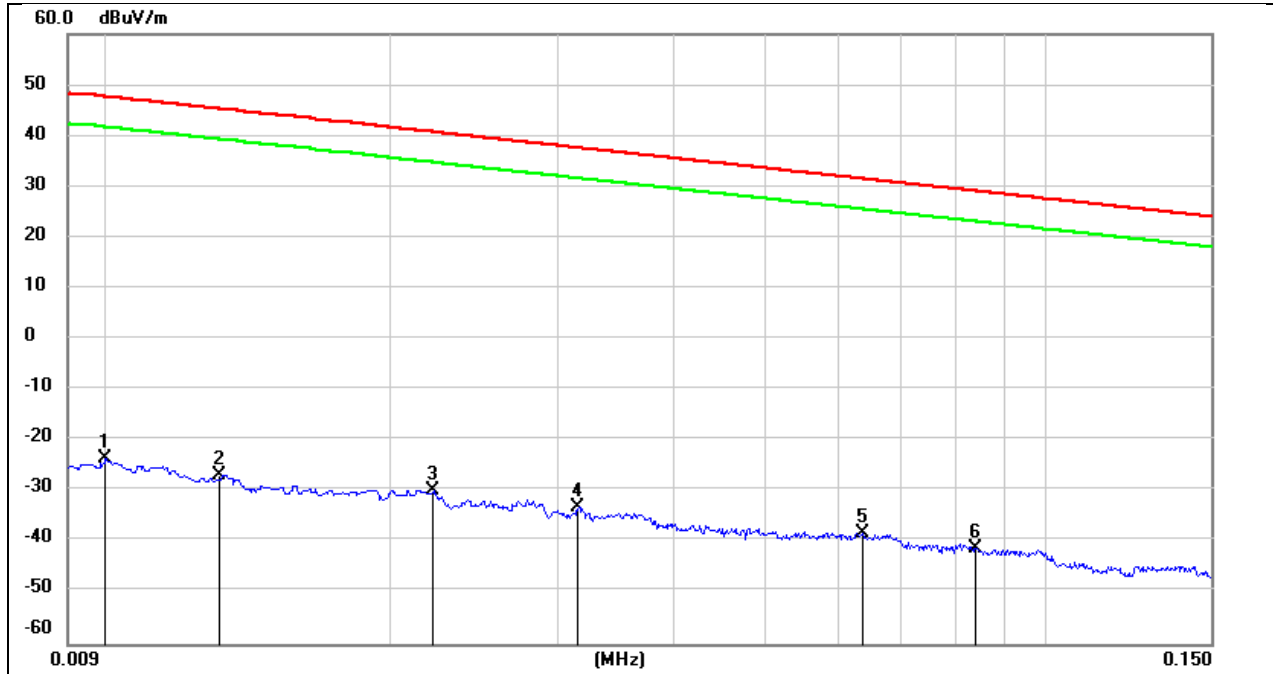

No.	Frequency (MHz)	Reading (dBuV)	Correct (dB/m)	Result (dBuV/m)	Result (dBuA/m)	Limit (dBuV/m)	Limit (dBuA/m)	Margin (dB)	Remark
1	0.01	77.72	-101.4	-23.68	-75.18	47.6	-3.9	-71.28	peak
2	0.0131	74.47	-101.38	-26.91	-78.41	45.25	-6.25	-72.16	peak
3	0.0221	71.63	-101.35	-29.72	-81.22	40.71	-10.79	-70.43	peak
4	0.0316	68.24	-101.4	-33.16	-84.66	37.61	-13.89	-70.77	peak
5	0.0636	63.31	-101.54	-38.23	-89.73	31.53	-19.97	-69.76	peak
6	0.084	60.51	-101.67	-41.16	-92.66	29.12	-22.38	-70.28	peak

Test Mode:	BLE 2M	Channel:	2402 MHz
Polarity:	Loop Antenna Face On To The EUT	Test Voltage	AC 120 V, 60 Hz

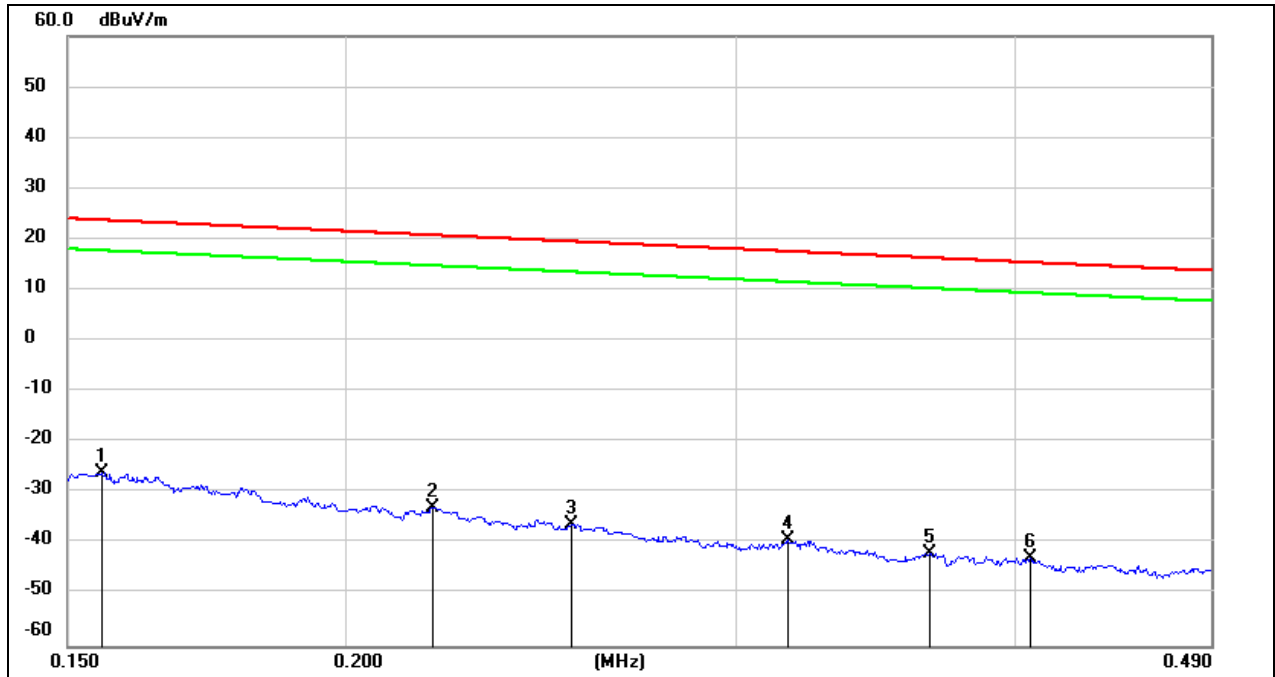

No.	Frequency (MHz)	Reading (dBuV)	Correct (dB/m)	Result (dBuV/m)	Result (dBuA/m)	Limit (dBuV/m)	Limit (dBuA/m)	Margin (dB)	Remark
1	0.1554	75.77	-101.65	-25.88	-77.38	23.77	-27.73	-49.65	peak
2	0.219	68.77	-101.75	-32.98	-84.48	20.79	-30.71	-53.77	peak
3	0.253	65.64	-101.8	-36.16	-87.66	19.54	-31.96	-55.70	peak
4	0.3163	62.7	-101.87	-39.17	-90.67	17.6	-33.9	-56.77	peak
5	0.3662	60.08	-101.93	-41.85	-93.35	16.33	-35.17	-58.18	peak
6	0.4062	59.14	-101.96	-42.82	-94.32	15.43	-36.07	-58.25	peak

Test Mode:	BLE 2M	Channel:	2402 MHz
Polarity:	Loop Antenna Face On To The EUT	Test Voltage	AC 120 V, 60 Hz

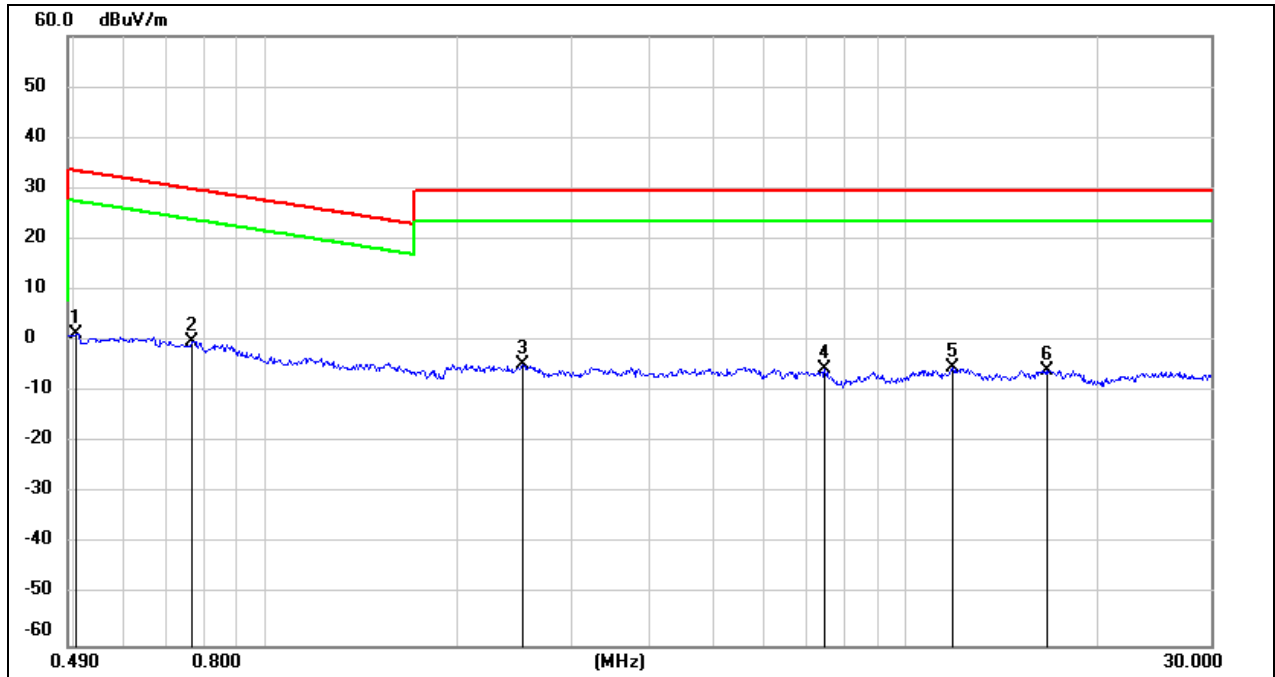

No.	Frequency (MHz)	Reading (dBuV)	Correct (dB/m)	Result (dBuV/m)	Result (dBuA/m)	Limit (dBuV/m)	Limit (dBuA/m)	Margin (dB)	Remark
1	0.5039	63.43	-62.07	1.36	-50.14	33.56	-17.94	-32.20	peak
2	0.7671	61.91	-62.12	-0.21	-51.71	29.9	-21.6	-30.11	peak
3	2.5261	56.91	-61.69	-4.78	-56.28	29.54	-21.96	-34.32	peak
4	7.4839	55.47	-61.15	-5.68	-57.18	29.54	-21.96	-35.22	peak
5	11.8513	55.56	-60.88	-5.32	-56.82	29.54	-21.96	-34.86	peak
6	16.6021	55.02	-60.96	-5.94	-57.44	29.54	-21.96	-35.48	peak

8.5. SPURIOUS EMISSIONS (18 GHZ ~ 26 GHZ)

Test Mode:	BLE 2M	Channel:	2402 MHz
Polarity:	Horizontal	Test Voltage:	AC 120 V, 60 Hz

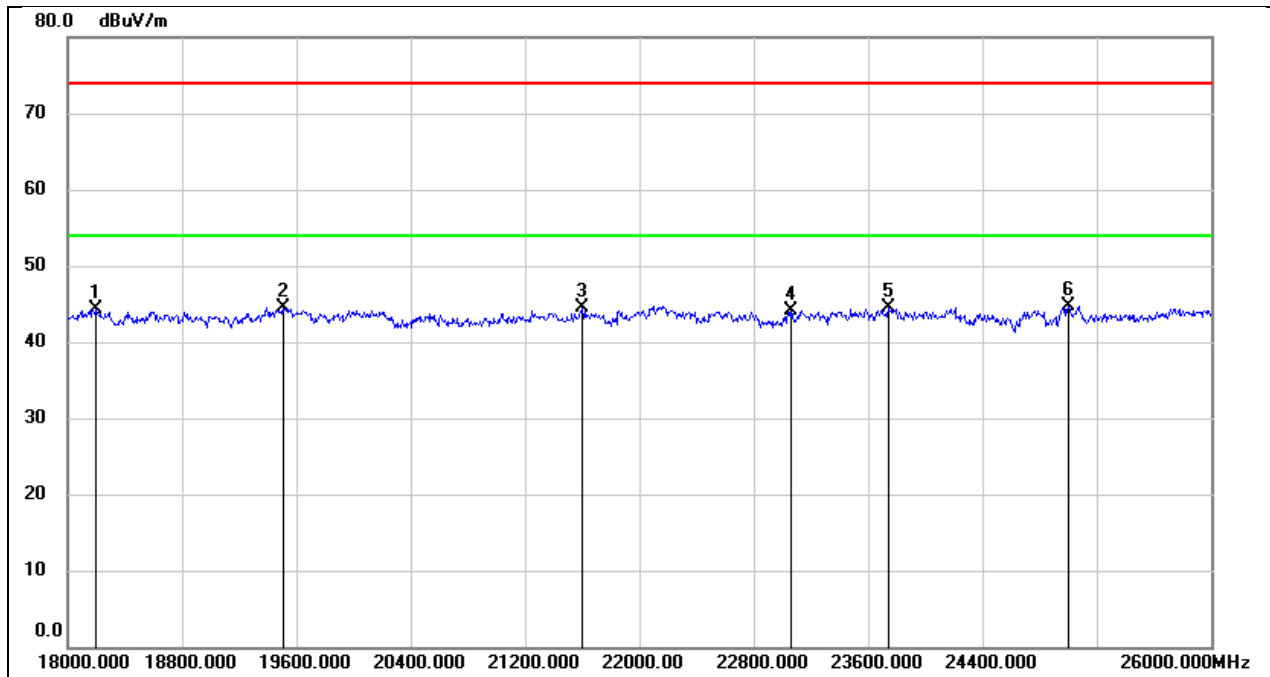

No.	Frequency (MHz)	Reading (dBuV)	Correct (dB/m)	Result (dBuV/m)	Limit (dBuV/m)	Margin (dB)	Remark
1	18200.000	49.79	-5.52	44.27	74.00	-29.73	peak
2	19504.000	49.97	-5.54	44.43	74.00	-29.57	peak
3	21600.000	49.02	-4.54	44.48	74.00	-29.52	peak
4	23064.000	47.49	-3.42	44.07	74.00	-29.93	peak
5	23744.000	47.65	-3.20	44.45	74.00	-29.55	peak
6	25000.000	46.86	-2.10	44.76	74.00	-29.24	peak

Test Mode:	BLE 2M	Channel:	2402 MHz
Polarity:	Vertical	Test Voltage:	AC 120 V, 60 Hz

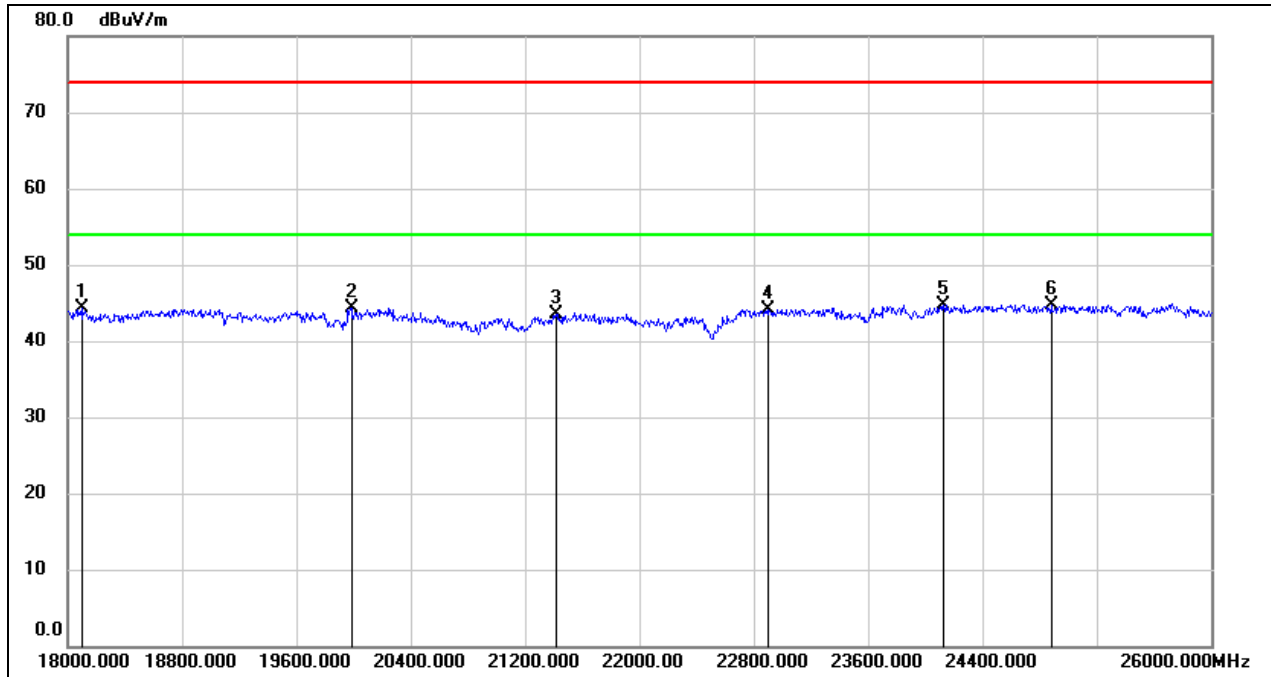

No.	Frequency (MHz)	Reading (dBuV)	Correct (dB/m)	Result (dBuV/m)	Limit (dBuV/m)	Margin (dB)	Remark
1	18104.000	49.73	-5.46	44.27	74.00	-29.73	peak
2	19984.000	49.71	-5.44	44.27	74.00	-29.73	peak
3	21416.000	48.23	-4.72	43.51	74.00	-30.49	peak
4	22904.000	47.63	-3.54	44.09	74.00	-29.91	peak
5	24128.000	47.48	-2.79	44.69	74.00	-29.31	peak
6	24880.000	46.90	-2.20	44.70	74.00	-29.30	peak

8.6. SPURIOUS EMISSIONS (30 MHz ~ 1 GHz)

Test Mode:	BLE 2M	Channel:	2402 MHz
Polarity:	Horizontal	Test Voltage:	AC 120 V, 60 Hz

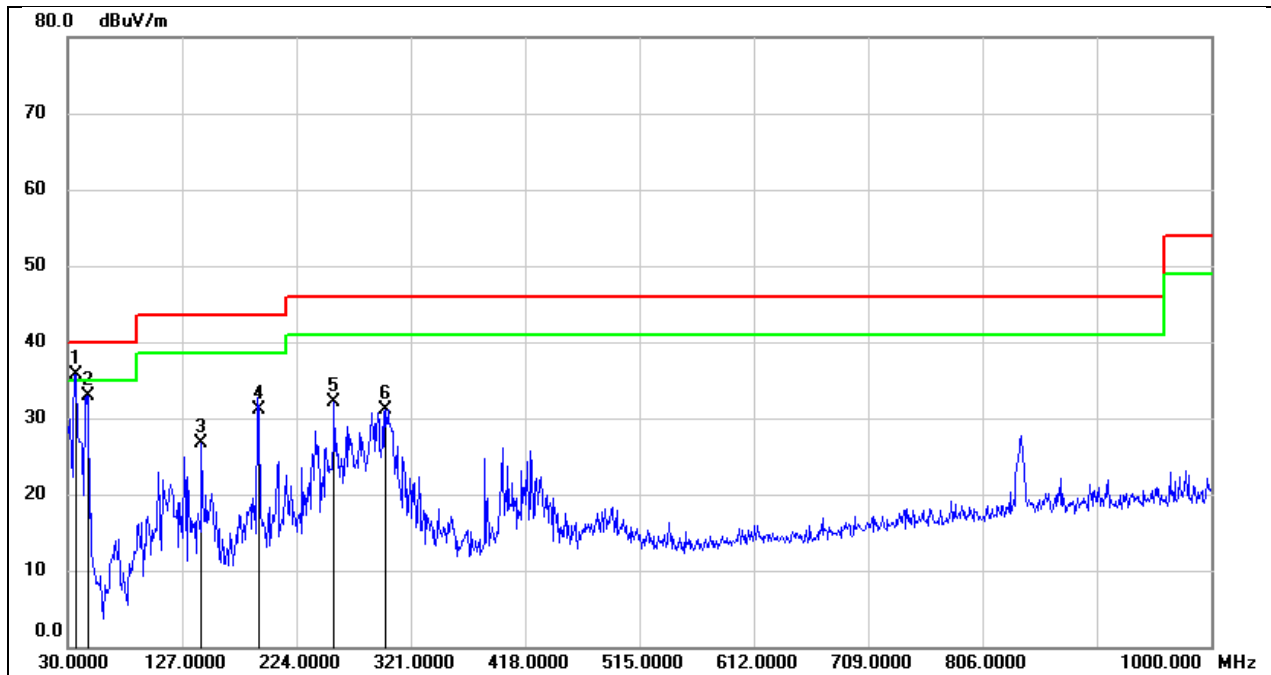

No.	Frequency (MHz)	Reading (dBuV)	Correct (dB/m)	Result (dBuV/m)	Limit (dBuV/m)	Margin (dB)	Remark
1	36.7900	55.05	-19.30	35.75	40.00	-4.25	QP
2	47.4600	53.26	-20.38	32.88	40.00	-7.12	QP
3	143.4900	45.35	-18.69	26.66	43.50	-16.84	QP
4	191.9900	47.78	-16.68	31.10	43.50	-12.40	QP
5	256.0100	50.54	-18.49	32.05	46.00	-13.95	QP
6	299.6600	46.40	-15.31	31.09	46.00	-14.91	QP

Test Mode:	BLE 2M	Channel:	2402 MHz
Polarity:	Vertical	Test Voltage:	AC 120 V, 60 Hz

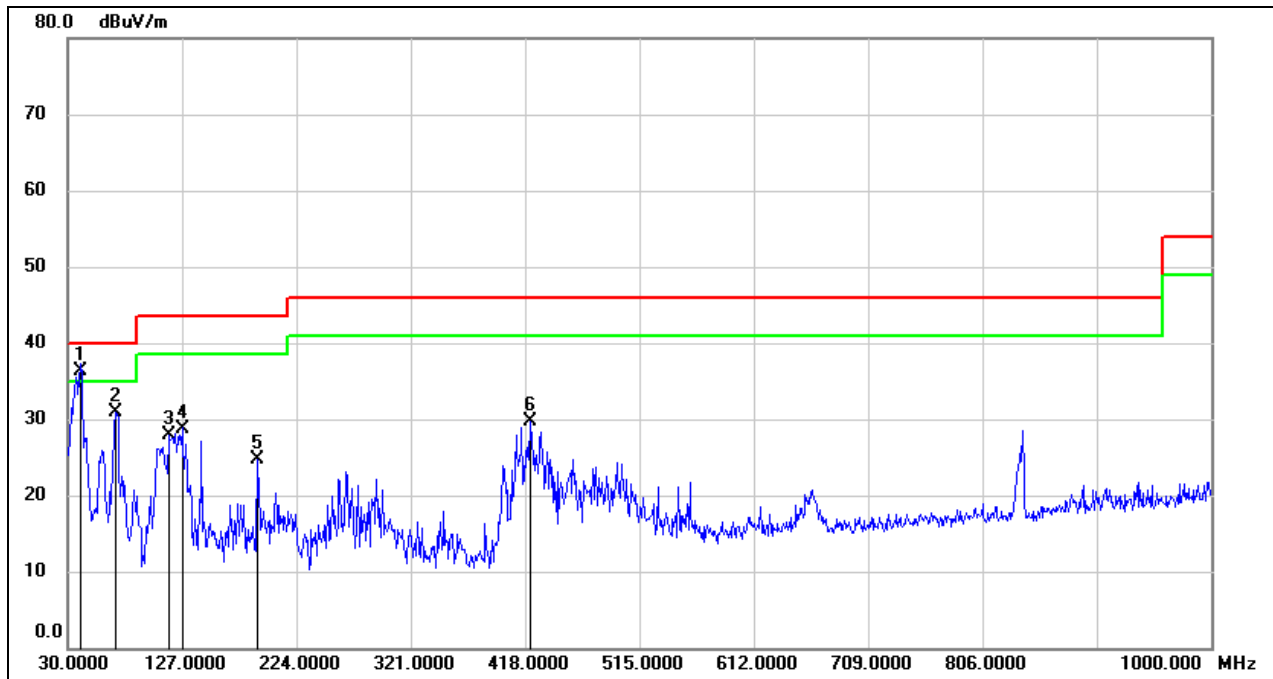

No.	Frequency (MHz)	Reading (dBuV)	Correct (dB/m)	Result (dBuV/m)	Limit (dBuV/m)	Margin (dB)	Remark
1	40.6699	56.25	-19.94	36.31	40.00	-3.69	QP
2	70.7400	51.68	-20.83	30.85	40.00	-9.15	QP
3	115.3600	48.03	-20.08	27.95	43.50	-15.55	QP
4	127.0000	48.28	-19.48	28.80	43.50	-14.70	QP
5	191.0200	41.41	-16.69	24.72	43.50	-18.78	QP
6	421.8800	42.05	-12.43	29.62	46.00	-16.38	QP

9. AC POWER LINE CONDUCTED EMISSION

LIMITS

Please refer to CFR 47 FCC §15.207 (a) and ISED RSS-Gen Clause 8.8

FREQUENCY (MHz)	Quasi-peak	Average
0.15 -0.5	66 - 56 *	56 - 46 *
0.50 -5.0	56.00	46.00
5.0 -30.0	60.00	50.00

TEST PROCEDURE

The EUT is put on a table of non-conducting material that is 80 cm high. The vertical conducting wall of shielding is located 40 cm to the rear of the EUT. The power line of the EUT is connected to the AC mains through a Artificial Mains Network (A.M.N.). A EMI Measurement Receiver (R&S Test Receiver ESR3) is used to test the emissions from both sides of AC line. According to the requirements in Section 6.2 of ANSI C63.10-2013. Conducted emissions from the EUT measured in the frequency range between 0.15 MHz and 30 MHz using CISPR Quasi-Peak and average detector mode. The bandwidth of EMI test receiver is set at 9 kHz.

The arrangement of the equipment is installed to meet the standards and operating in a manner, which tends to maximize its emission characteristics in a normal application.

TEST SETUP

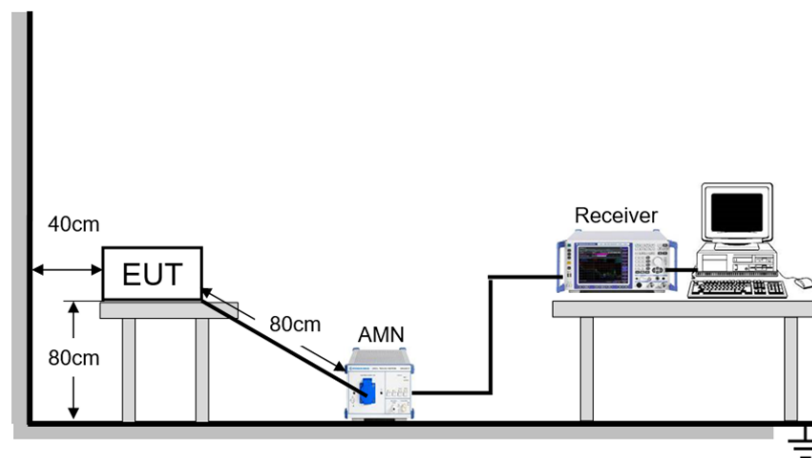

TEST ENVIRONMENT

Temperature	26.2 °C	Relative Humidity	54%
Atmosphere Pressure	101 kPa	Test Voltage	AC 120, 60 Hz

TEST RESULTS

Test Mode:	BLE 2M	Channel:	2402 MHz
Line:	Line		

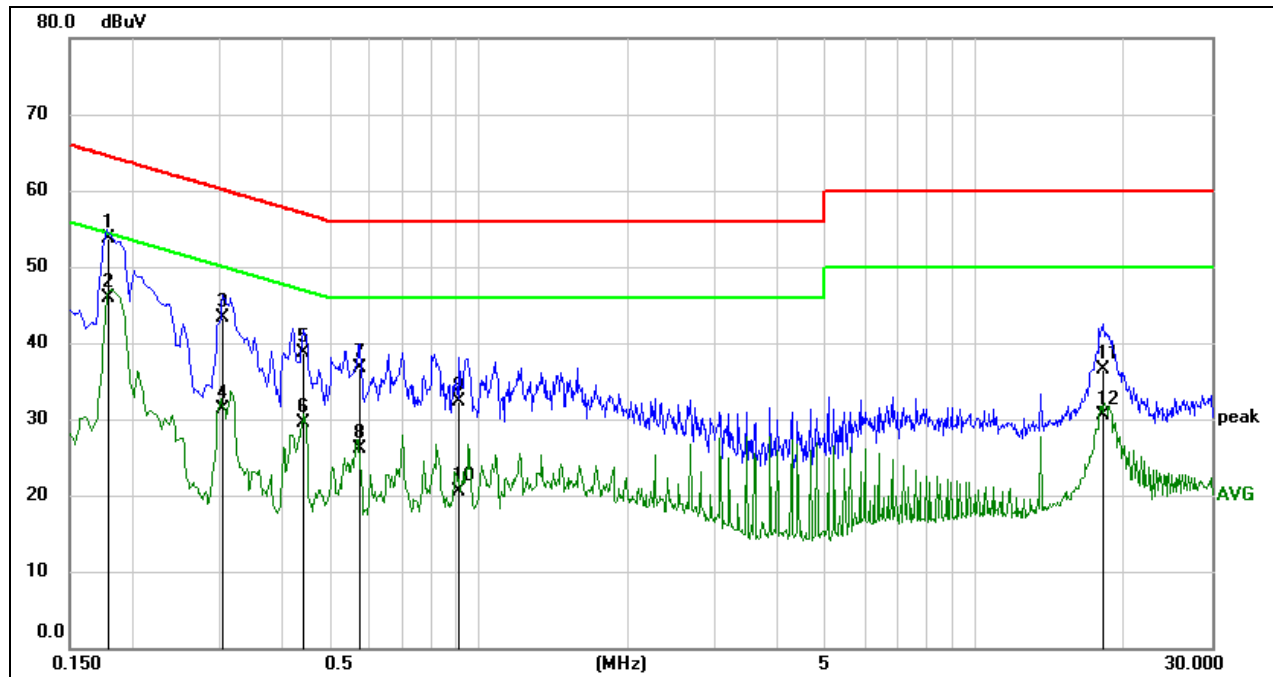

No.	Frequency (MHz)	Reading (dBuV)	Correct (dB)	Result (dBuV)	Limit (dBuV)	Margin (dB)	Remark
1	0.1796	44.21	9.59	53.80	64.50	-10.70	QP
2	0.1796	36.29	9.59	45.88	54.50	-8.62	AVG
3	0.3056	33.65	9.59	43.24	60.09	-16.85	QP
4	0.3056	21.72	9.59	31.31	50.09	-18.78	AVG
5	0.4456	29.14	9.60	38.74	56.96	-18.22	QP
6	0.4456	19.82	9.60	29.42	46.96	-17.54	AVG
7	0.5765	27.08	9.60	36.68	56.00	-19.32	QP
8	0.5765	16.56	9.60	26.16	46.00	-19.84	AVG
9	0.9178	22.77	9.61	32.38	56.00	-23.62	QP
10	0.9178	10.81	9.61	20.42	46.00	-25.58	AVG
11	18.2237	26.70	9.81	36.51	60.00	-23.49	QP
12	18.2237	20.64	9.81	30.45	50.00	-19.55	AVG

Note:

1. Result = Reading + Correct Factor.
2. If QP Result complies with AV limit, AV Result is deemed to comply with AV limit.
3. Test setup: RBW: 200 Hz (9 kHz ~ 150 kHz), 9 kHz (150 kHz ~ 30 MHz).
4. Step size: 80 Hz (0.009 MHz ~ 0.15 MHz), 4 kHz (0.15 MHz ~ 30 MHz), Scan time: auto.

Test Mode:	BLE 2M	Channel:	2402 MHz
Line:	Neutral		

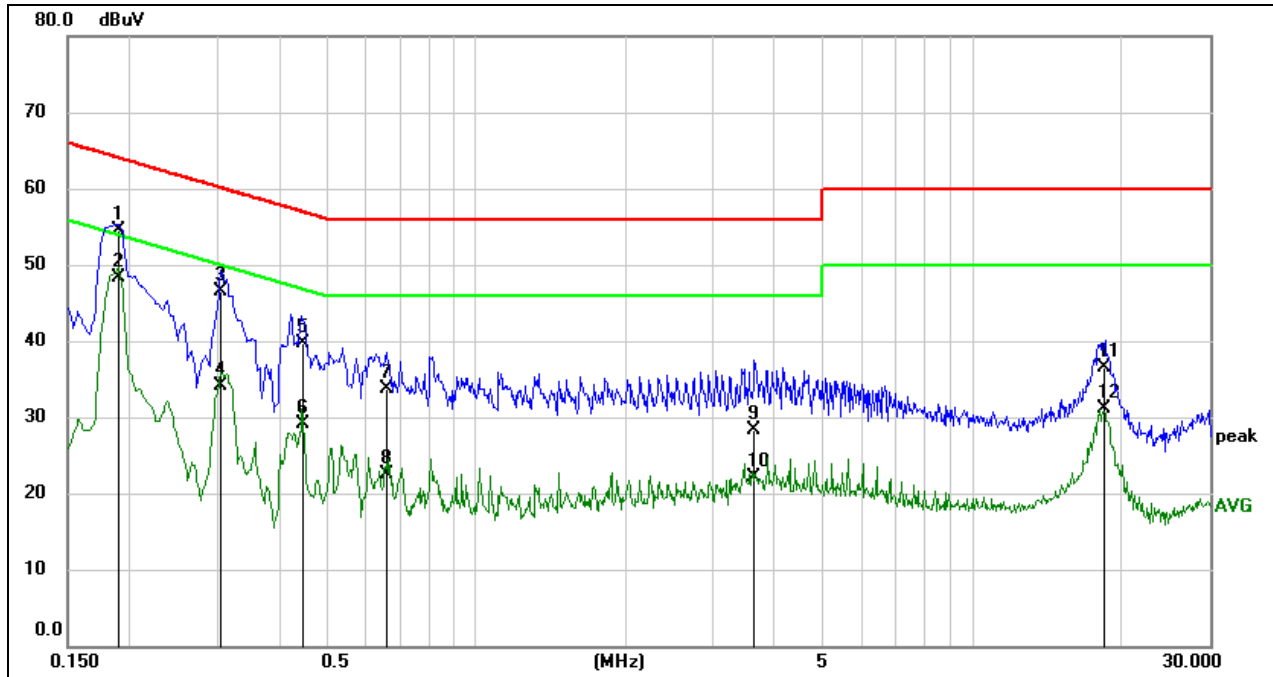

No.	Frequency (MHz)	Reading (dBuV)	Correct (dB)	Result (dBuV)	Limit (dBuV)	Margin (dB)	Remark
1	0.1909	44.94	9.59	54.53	64.00	-9.47	QP
2	0.1909	38.81	9.59	48.40	54.00	-5.60	AVG
3	0.3061	36.88	9.59	46.47	60.08	-13.61	QP
4	0.3061	24.51	9.59	34.10	50.08	-15.98	AVG
5	0.4468	30.02	9.60	39.62	56.93	-17.31	QP
6	0.4468	19.45	9.60	29.05	46.93	-17.88	AVG
7	0.6591	24.17	9.60	33.77	56.00	-22.23	QP
8	0.6591	12.93	9.60	22.53	46.00	-23.47	AVG
9	3.6058	18.66	9.69	28.35	56.00	-27.65	QP
10	3.6058	12.49	9.69	22.18	46.00	-23.82	AVG
11	18.4164	26.67	9.81	36.48	60.00	-23.52	QP
12	18.4164	21.31	9.81	31.12	50.00	-18.88	AVG

Note:

1. Result = Reading + Correct Factor.
2. If QP Result complies with AV limit, AV Result is deemed to comply with AV limit.
3. Test setup: RBW: 200 Hz (9 kHz ~ 150 kHz), 9 kHz (150 kHz ~ 30 MHz).
4. Step size: 80 Hz (0.009 MHz ~ 0.15 MHz), 4 kHz (0.15 MHz ~ 30 MHz), Scan time: auto.

Note: All the modes have been tested, only the worst data was recorded in the report.

10. ANTENNA REQUIREMENT

REQUIREMENT

Please refer to FCC part 15.203

An intentional radiator shall be designed to ensure that no antenna other than that furnished by the responsible party shall be used with the device. The use of a permanently attached antenna or of an antenna that uses a unique coupling to the intentional radiator shall be considered sufficient to comply with the provisions of this section. The manufacturer may design the unit so that a broken antenna can be replaced by the user, but the use of a standard antenna jack or electrical connector is prohibited.

Please refer to FCC part 15.247(b)(4)

The conducted output power limit specified in paragraph (b) of this section is based on the use of antennas with directional gains that do not exceed 6 dBi. Except as shown in paragraph (c) of this section, if transmitting antennas of directional gain greater than 6 dBi are used, the conducted output power from the intentional radiator shall be reduced below the stated values in paragraphs (b)(1), (b)(2), and (b)(3) of this section, as appropriate, by the amount in dB that the directional gain of the antenna exceeds 6 dBi.

DESCRIPTION

Pass

11. TEST DATA

11.1. APPENDIX A: DTS BANDWIDTH

11.1.1. Test Result

Test Mode	Antenna	Channel	DTS BW [MHz]	FL[MHz]	FH[MHz]	Limit[MHz]	Verdict
BLE_1M	Ant1	2402	0.70	2401.67	2402.38	≥ 0.5	PASS
		2440	0.71	2439.67	2440.38	≥ 0.5	PASS
		2480	0.72	2479.67	2480.39	≥ 0.5	PASS
BLE_2M	Ant1	2402	1.08	2401.48	2402.55	≥ 0.5	PASS
		2440	1.11	2439.45	2440.56	≥ 0.5	PASS
		2480	1.12	2479.45	2480.57	≥ 0.5	PASS

11.1.2. Test Graphs

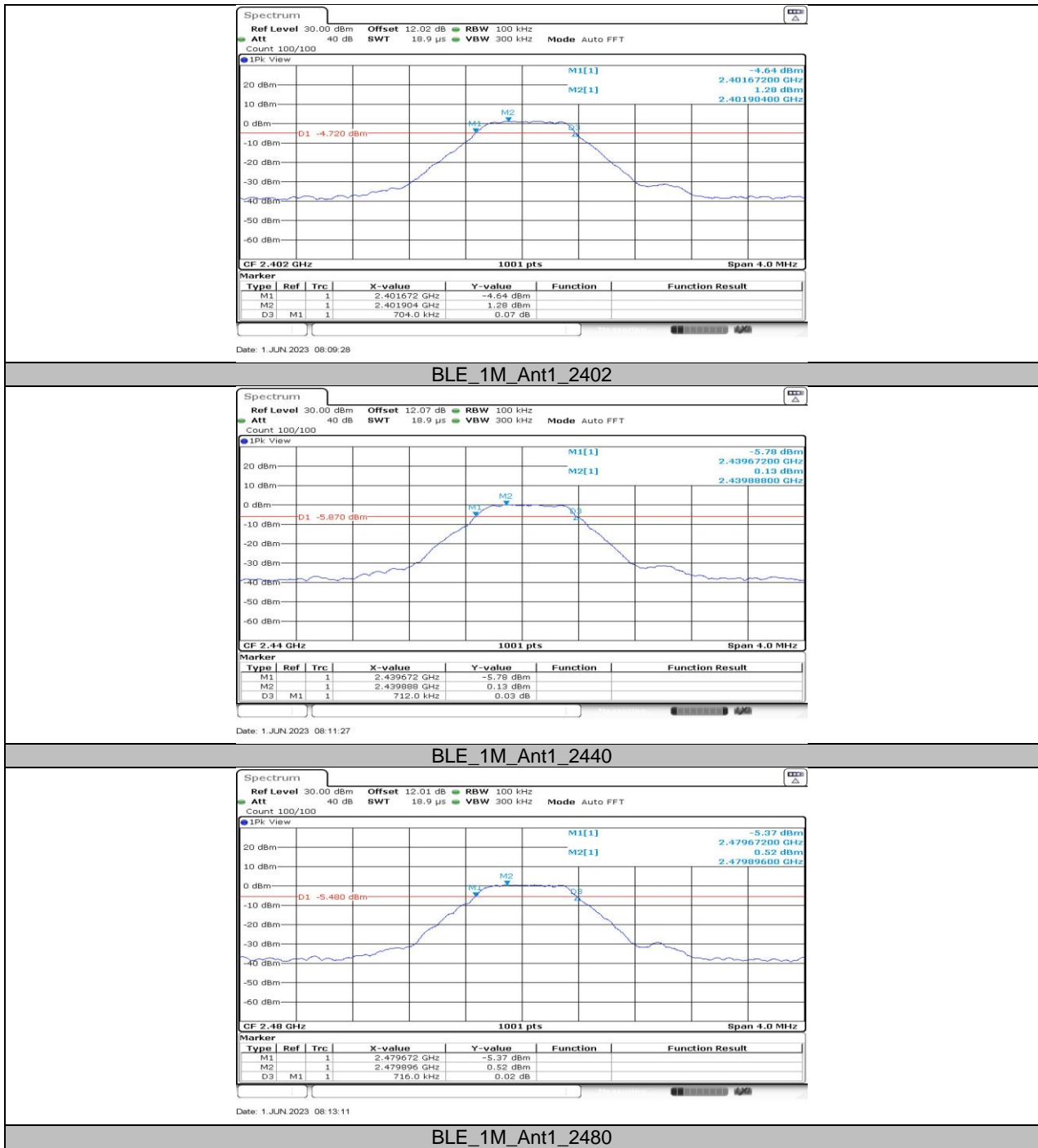

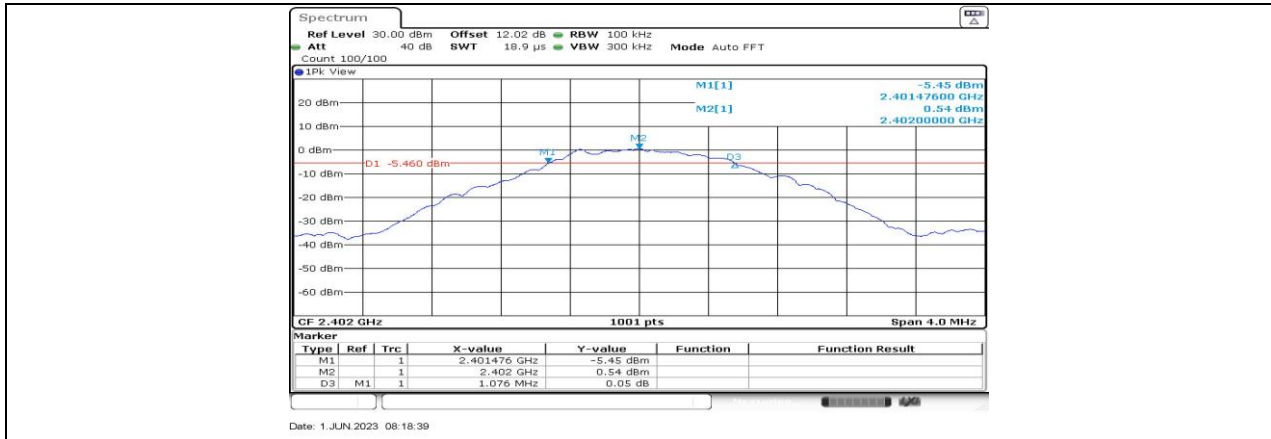

BLE_2M_Ant1_2402

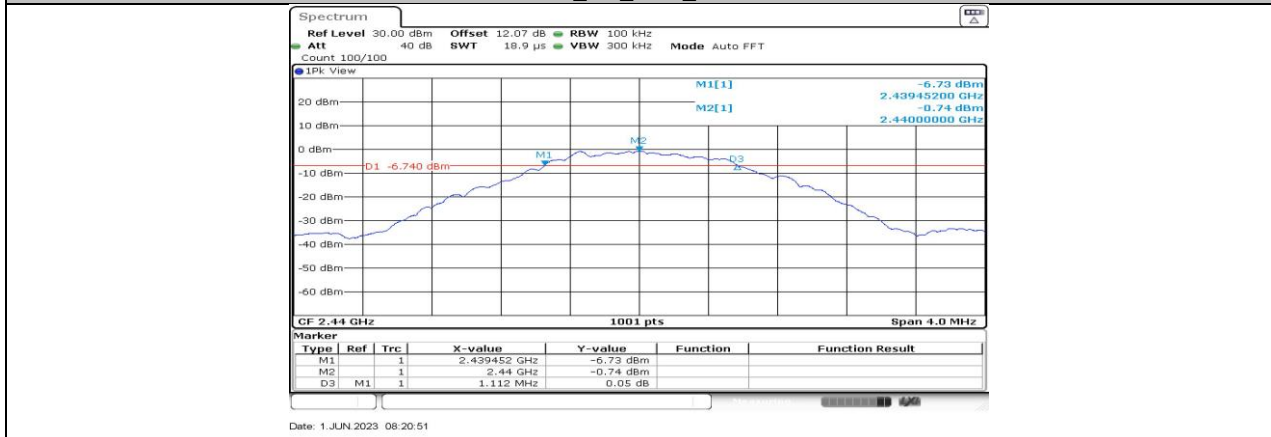

BLE_2M_Ant1_2440

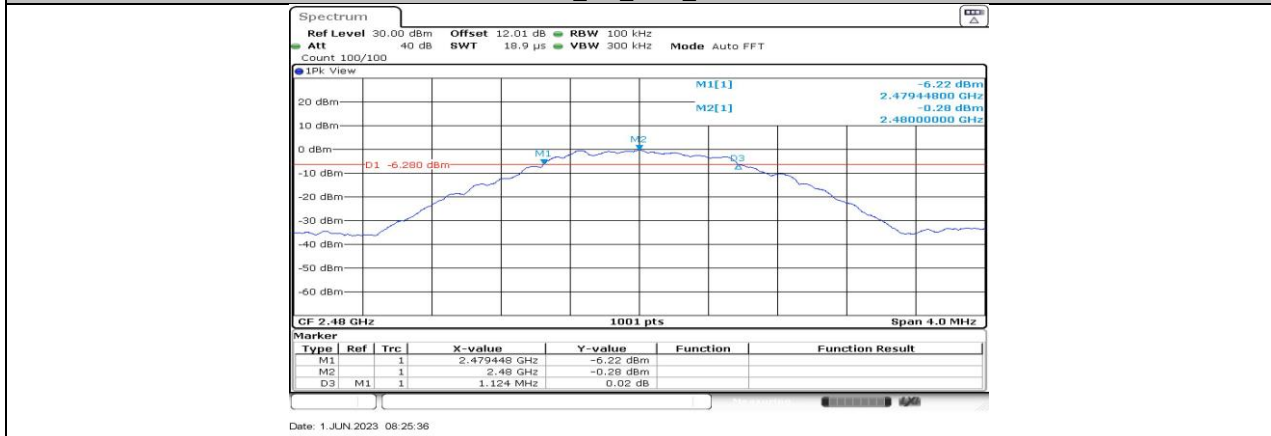

BLE_2M_Ant1_2480

11.2. APPENDIX B: OCCUPIED CHANNEL BANDWIDTH

11.2.1. Test Result

Test Mode	Antenna	Channel	OCB [MHz]	FL[MHz]	FH[MHz]	Verdict
BLE_1M	Ant1	2402	0.975	2401.5365	2402.5115	PASS
		2440	0.987	2439.5285	2440.5155	PASS
		2480	0.999	2479.5245	2480.5235	PASS
BLE_2M	Ant1	2402	1.89	2401.0769	2402.9670	PASS
		2440	1.914	2439.0649	2440.9790	PASS
		2480	1.926	2479.0609	2480.9870	PASS

11.2.2. Test Graphs

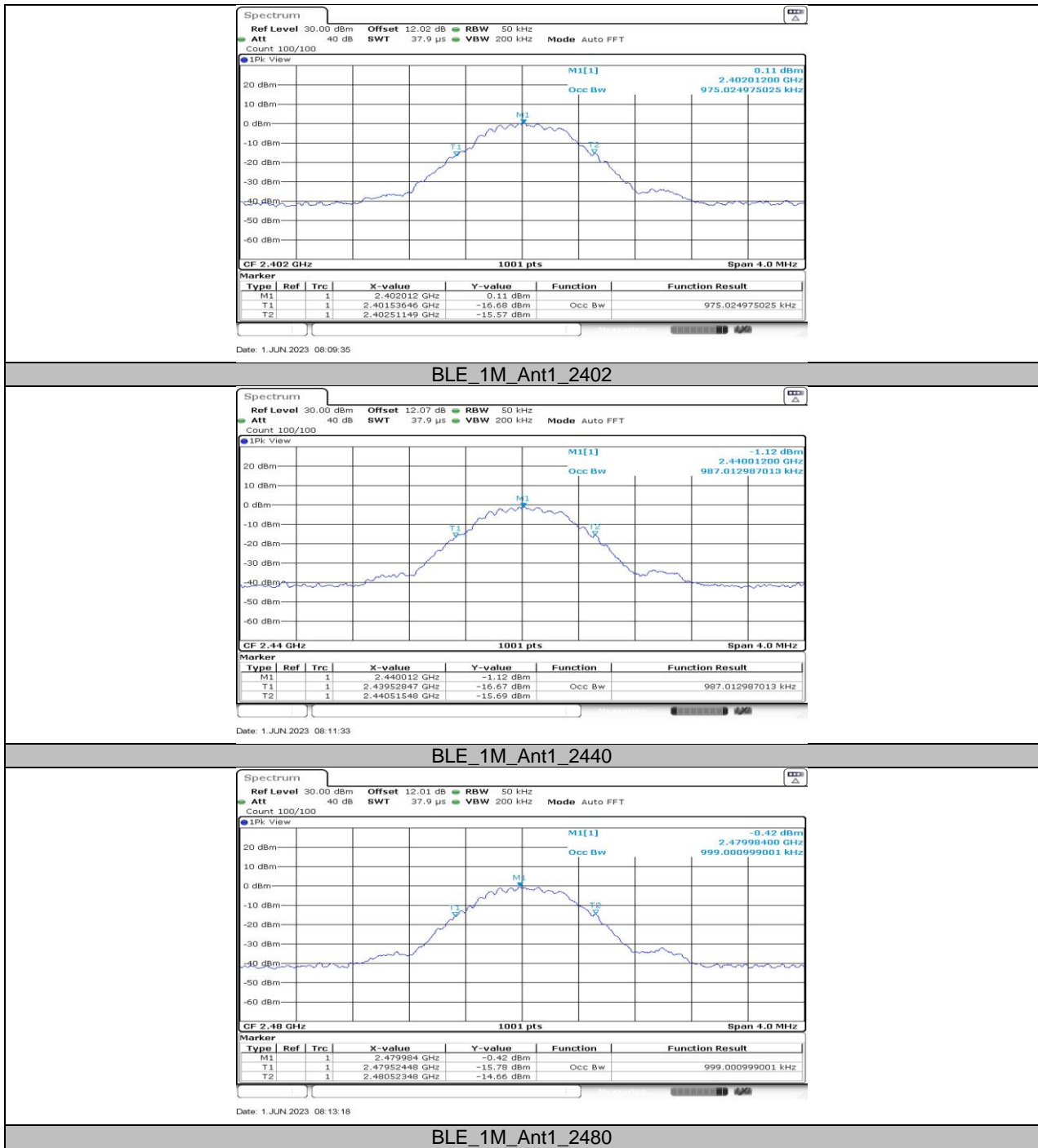

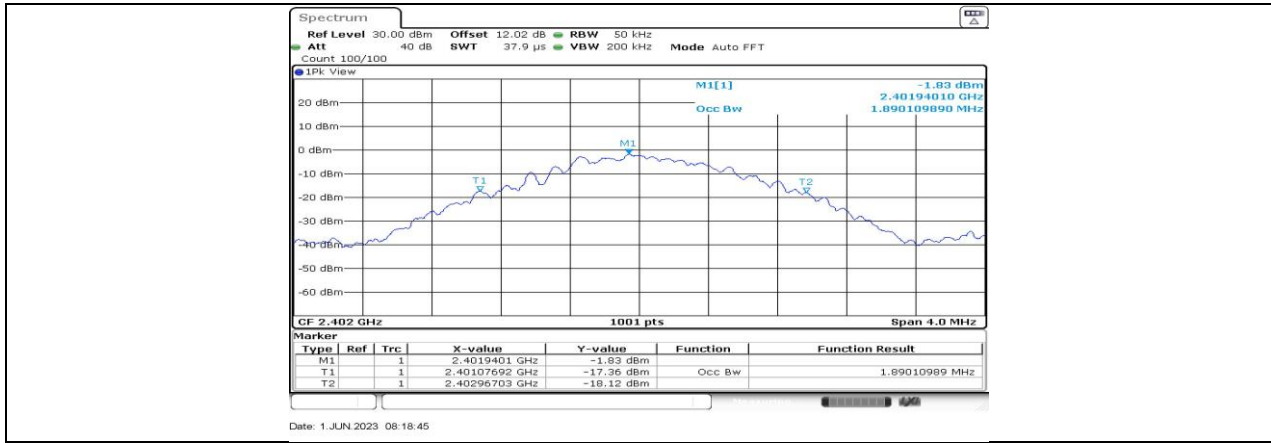

BLE_2M_Ant1_2402

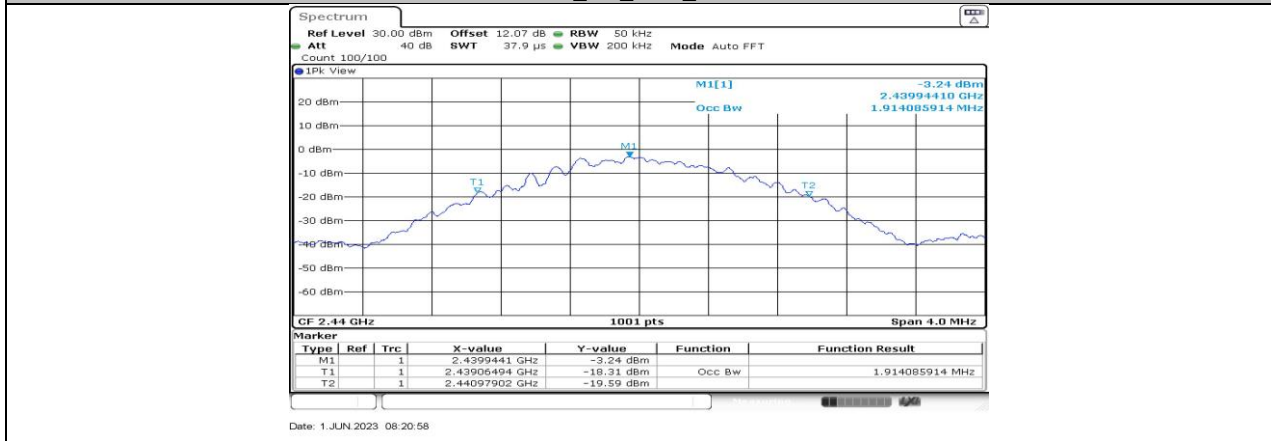

BLE_2M_Ant1_2440

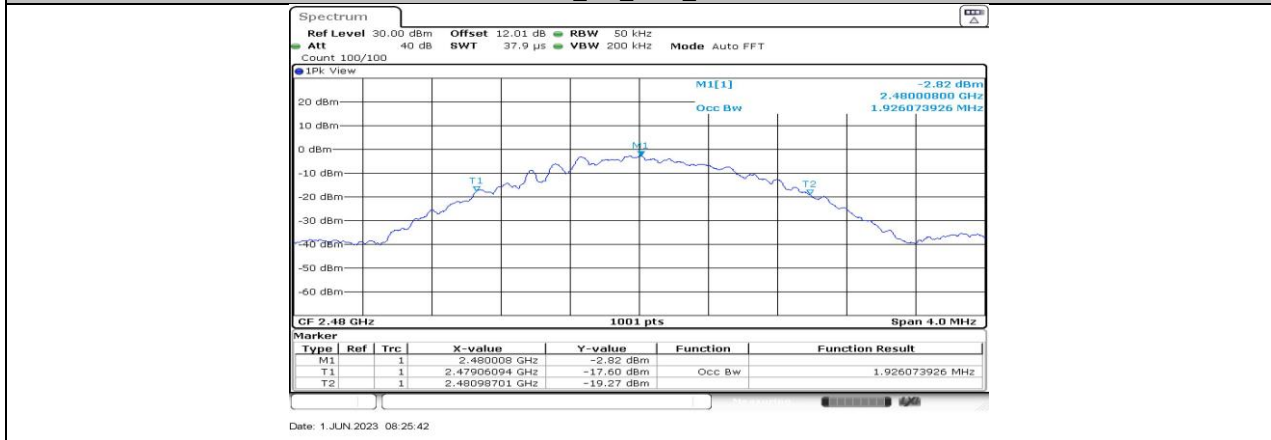

BLE_2M_Ant1_2480

11.3. APPENDIX C: MAXIMUM PEAK CONDUCTED OUTPUT POWER

11.3.1. Test Result

Test Mode	Antenna	Channel	Result[dBm]	Limit[dBm]	Verdict
BLE_1M	Ant1	2402	-0.47	≤30	PASS
		2440	-1.21	≤30	PASS
		2480	-0.87	≤30	PASS
BLE_2M	Ant1	2402	0.45	≤30	PASS
		2440	-0.18	≤30	PASS
		2480	0.13	≤30	PASS

11.4. APPENDIX D: MAXIMUM POWER SPECTRAL DENSITY

11.4.1. Test Result

Test Mode	Antenna	Channel	Result[dBm/3kHz]	Limit[dBm/3kHz]	Verdict
BLE_1M	Ant1	2402	-15.29	≤8.00	PASS
		2440	-16.54	≤8.00	PASS
		2480	-16.29	≤8.00	PASS
BLE_2M	Ant1	2402	-16.51	≤8.00	PASS
		2440	-17.73	≤8.00	PASS
		2480	-17.72	≤8.00	PASS

11.4.2. Test Graphs

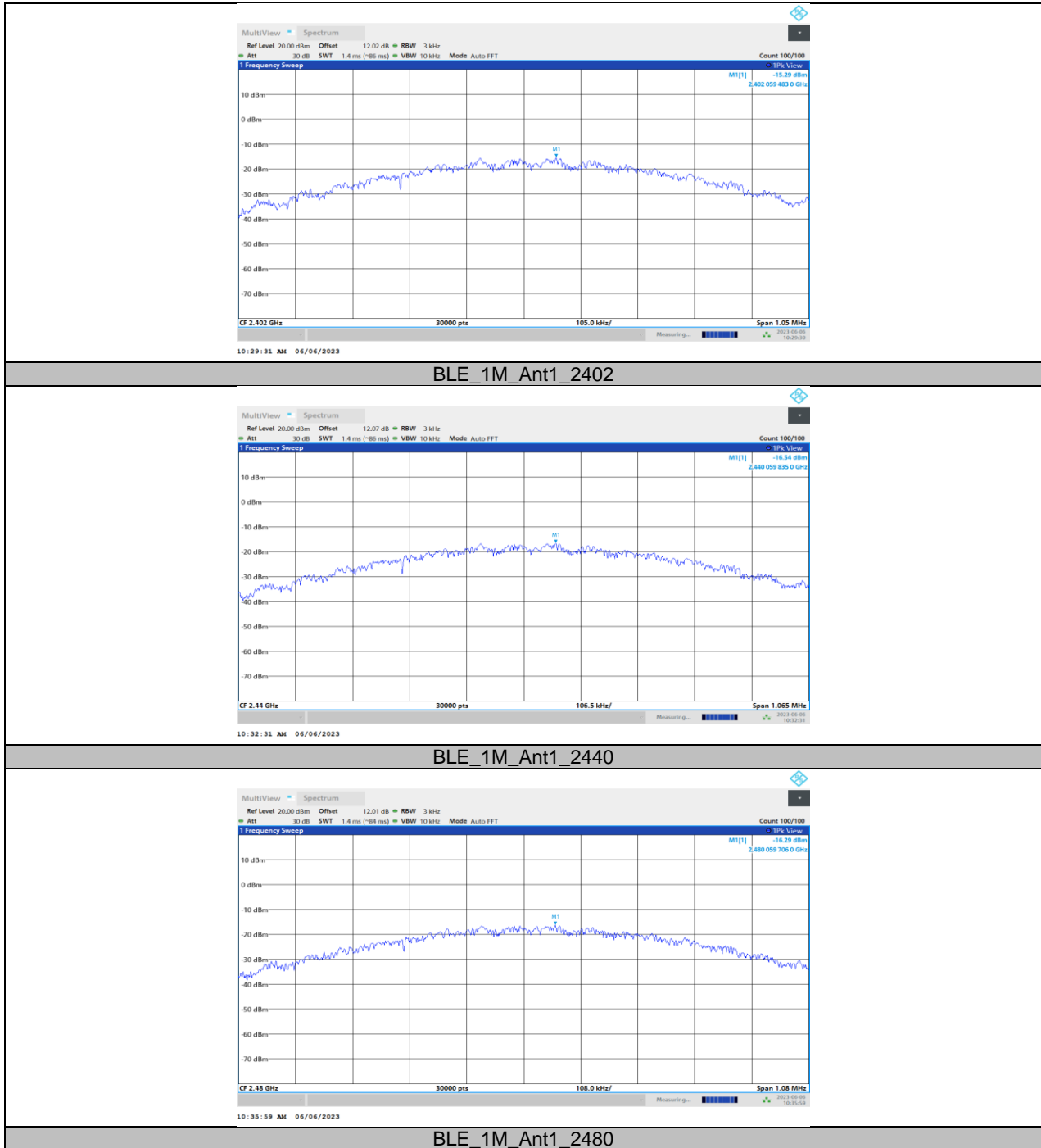

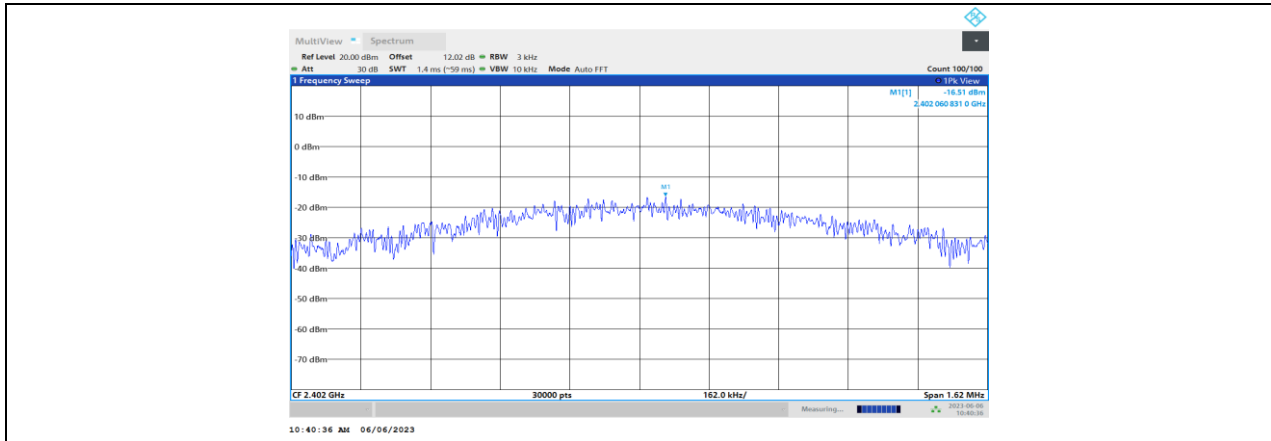

BLE_2M_Ant1_2402

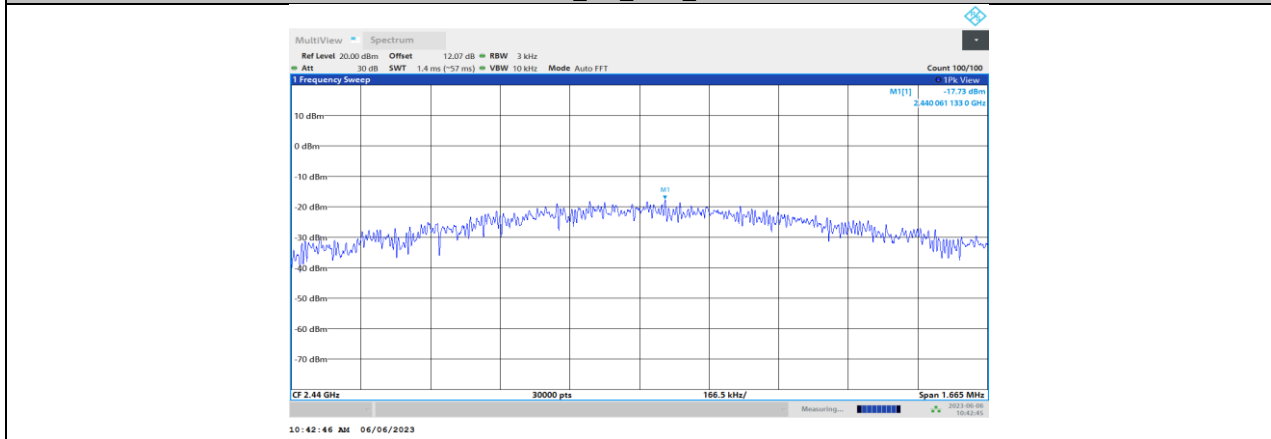

BLE_2M_Ant1_2440

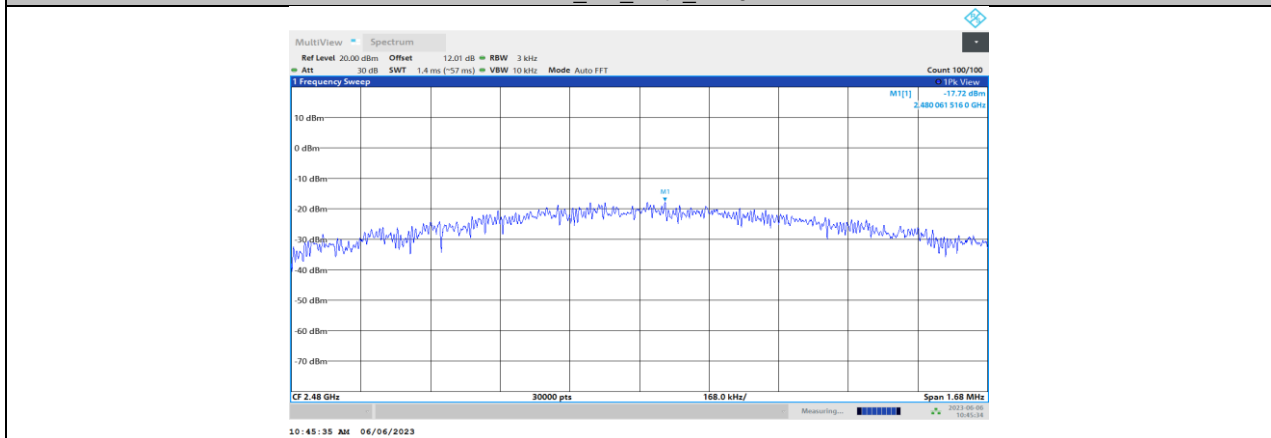

BLE_2M_Ant1_2480

11.5. APPENDIX E: BAND EDGE MEASUREMENTS

11.5.1. Test Result

Test Mode	Antenna	ChName	Channel	RefLevel[dBm]	Result[dBm]	Limit[dBm]	Verdict
BLE_1M	Ant1	Low	2402	-1.57	-47.56	≤ -21.57	PASS
		High	2480	-2.21	-48.22	≤ -22.21	PASS
BLE_2M	Ant1	Low	2402	-1.38	-40.78	≤ -21.38	PASS
		High	2480	-2.01	-48.81	≤ -22.01	PASS

11.5.2. Test Graphs

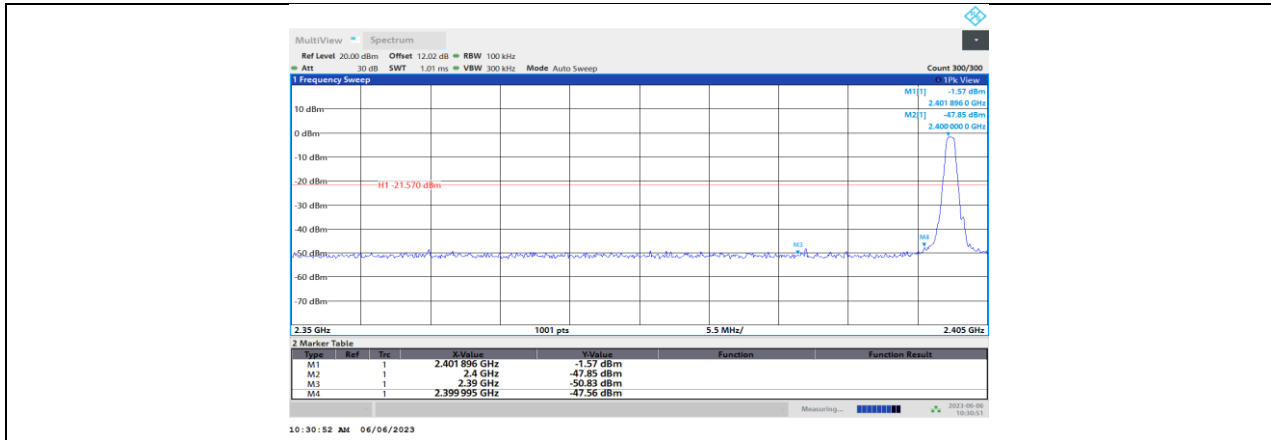

BLE_1M_Ant1_Low_2402

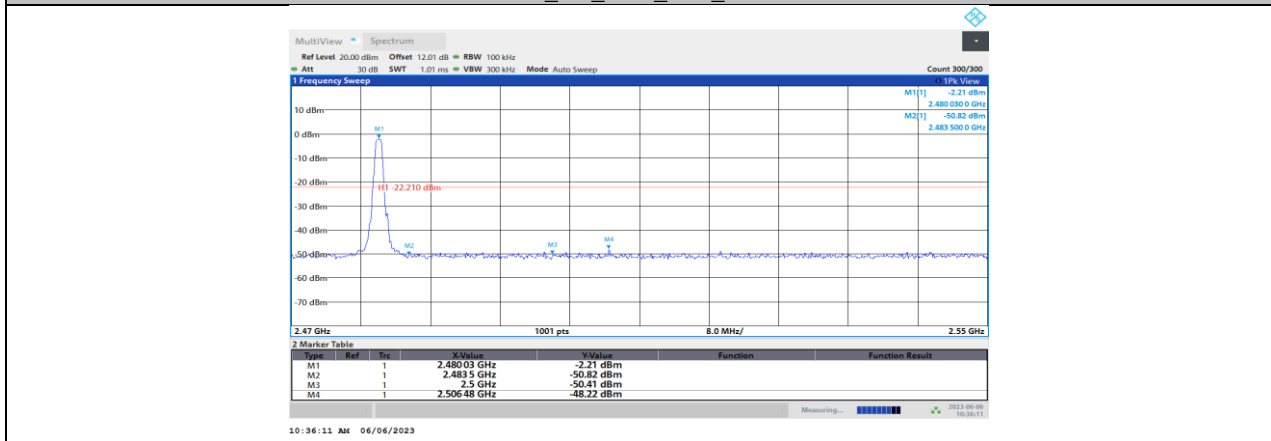

BLE_1M_Ant1_High_2480

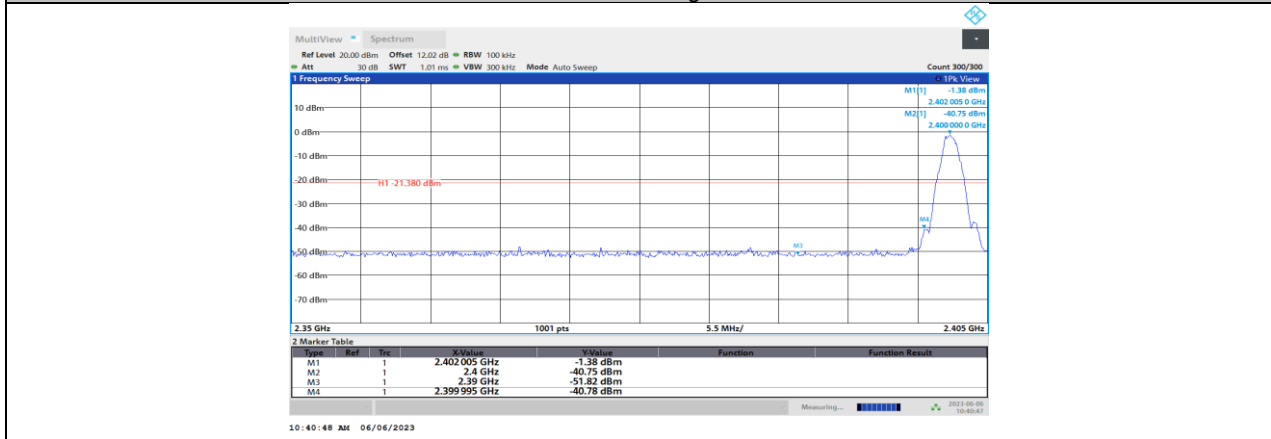

BLE_2M_Ant1_Low_2402

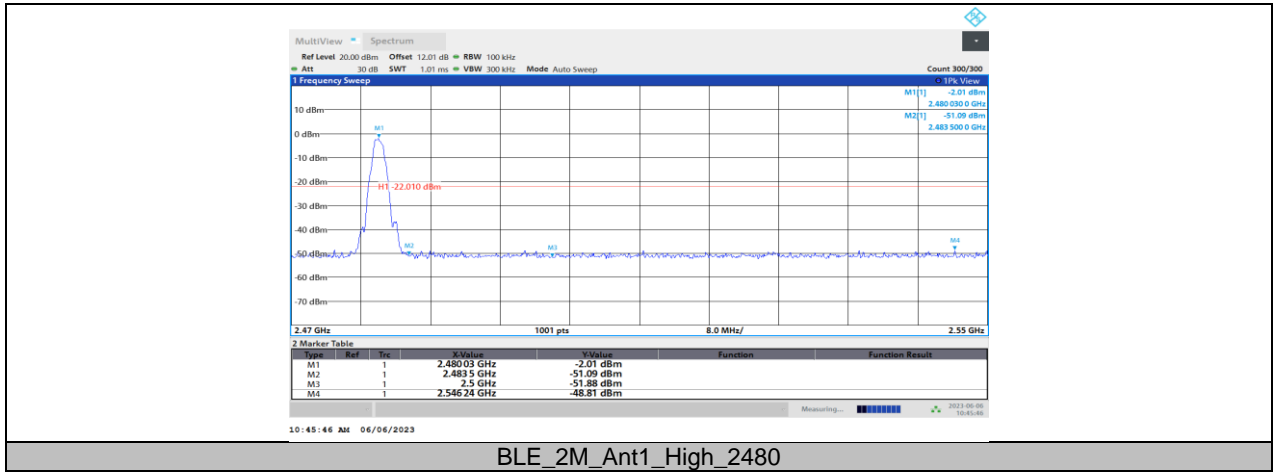

11.6. APPENDIX F: CONDUCTED SPURIOUS EMISSION

11.6.1. Test Result

Test Mode	Antenna	Channel	FreqRange [MHz]	Result[dBm]	Limit[dBm]	Verdict
BLE_1M	Ant1	2402	Reference	-1.41	---	PASS
			30~1000	-57.26	≤-21.41	PASS
			1000~26500	-40.89	≤-21.41	PASS
		2440	Reference	-2.22	---	PASS
			30~1000	-57.35	≤-22.22	PASS
			1000~26500	-41.29	≤-22.22	PASS
		2480	Reference	-2.03	---	PASS
			30~1000	-57.49	≤-22.03	PASS
			1000~26500	-41.36	≤-22.03	PASS
BLE_2M	Ant1	2402	Reference	-1.29	---	PASS
			30~1000	-57.91	≤-21.29	PASS
			1000~26500	-41.73	≤-21.29	PASS
		2440	Reference	-2.12	---	PASS
			30~1000	-57.17	≤-22.12	PASS
			1000~26500	-42.11	≤-22.12	PASS
		2480	Reference	-1.90	---	PASS
			30~1000	-56.52	≤-21.9	PASS
			1000~26500	-42.22	≤-21.9	PASS

11.6.2. Test Graphs

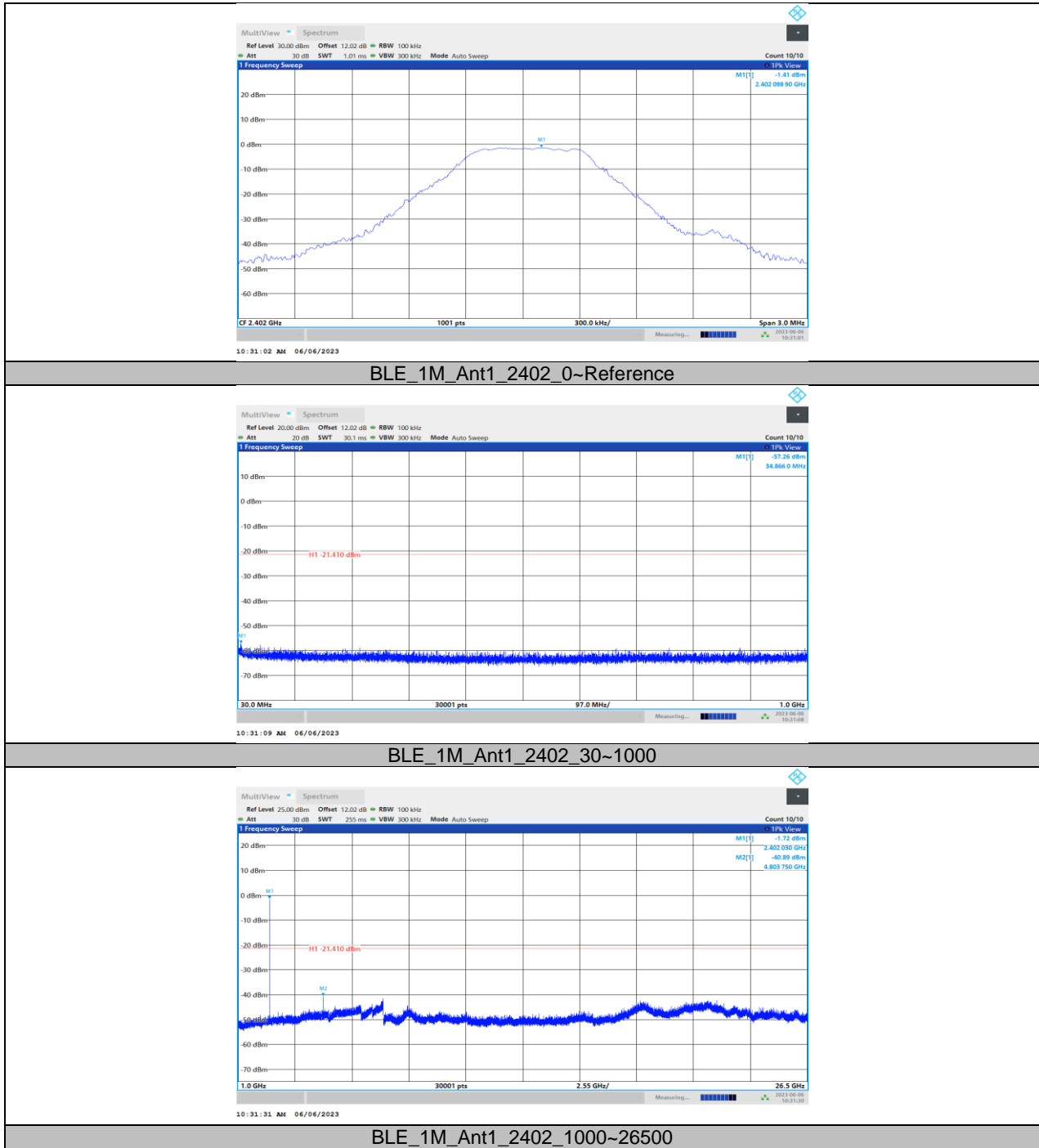

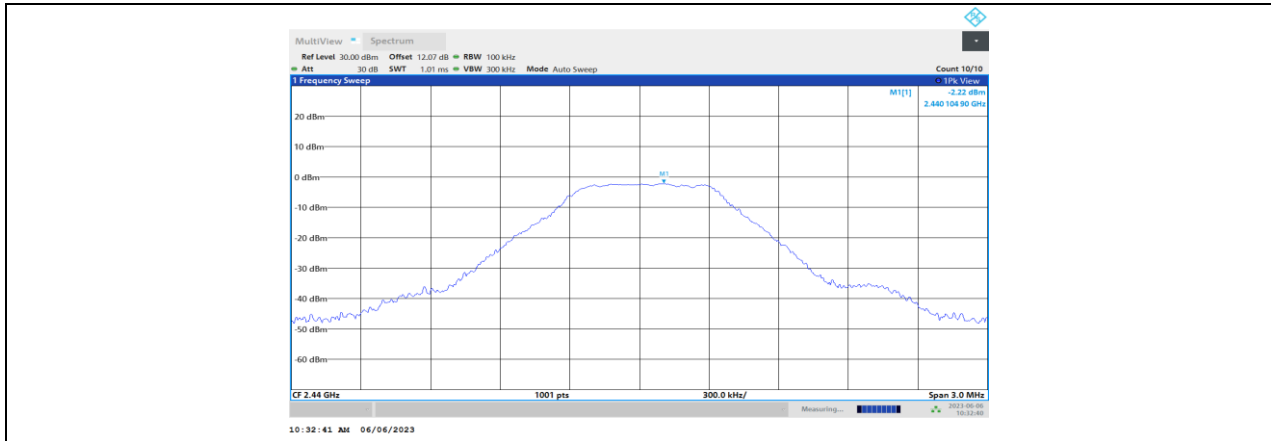

BLE_1M_Ant1_2440_0~Reference

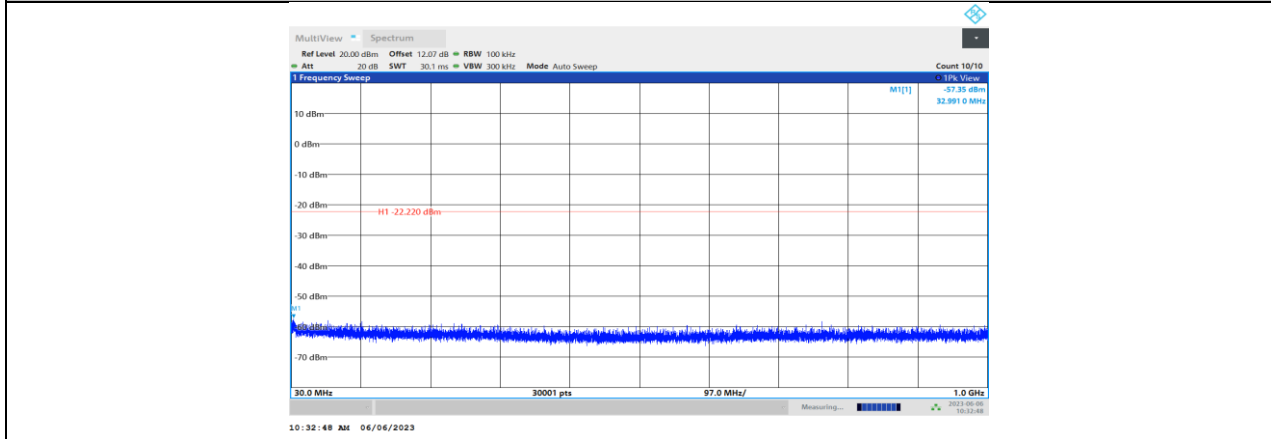

BLE_1M_Ant1_2440_30~1000

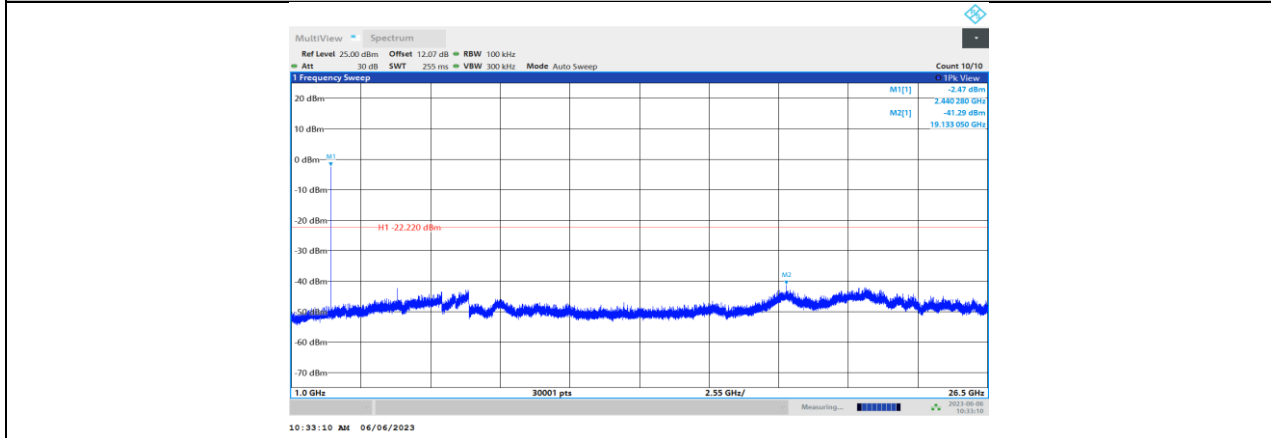

BLE_1M_Ant1_2440_1000~26500

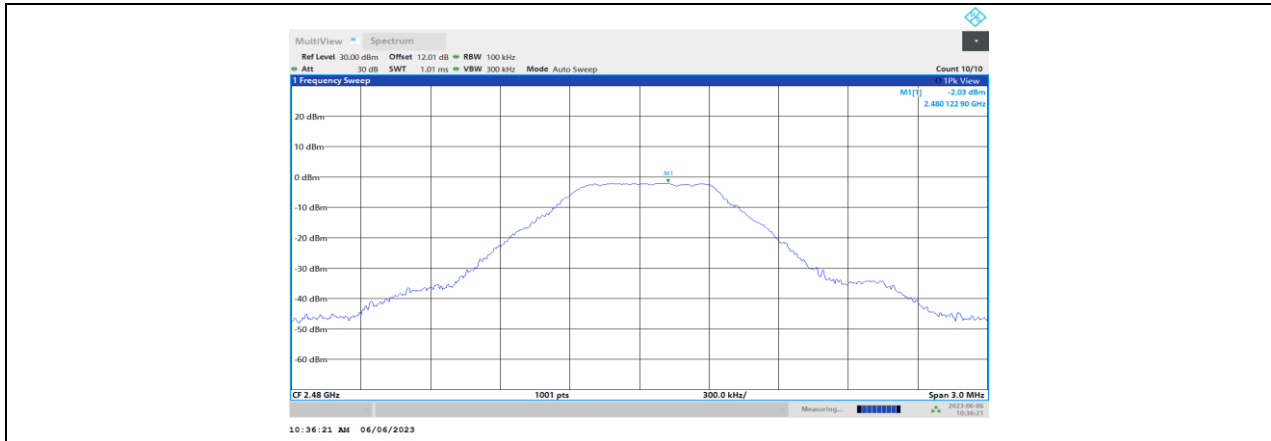

BLE_1M_Ant1_2480_0~Reference

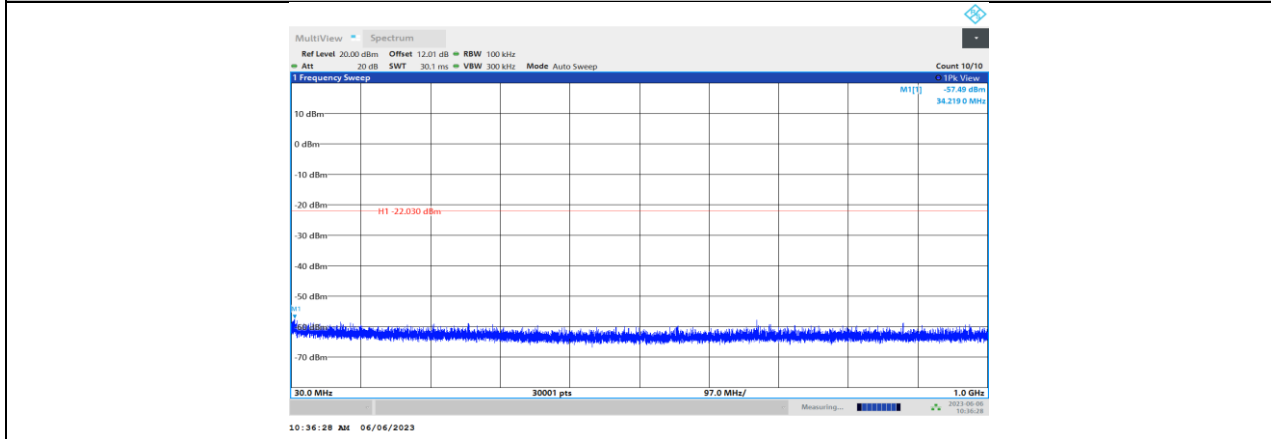

BLE_1M_Ant1_2480_30~1000

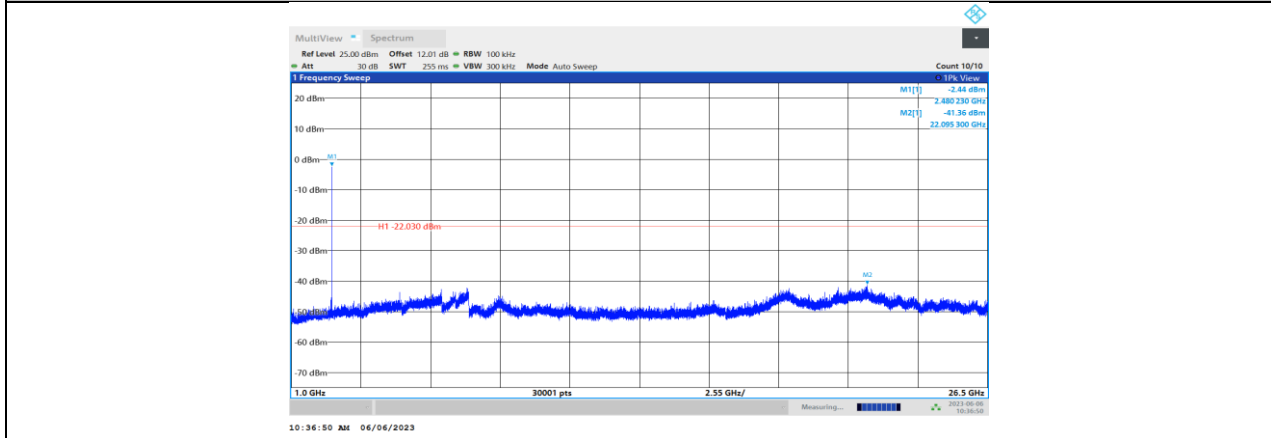

BLE_1M_Ant1_2480_1000~26500

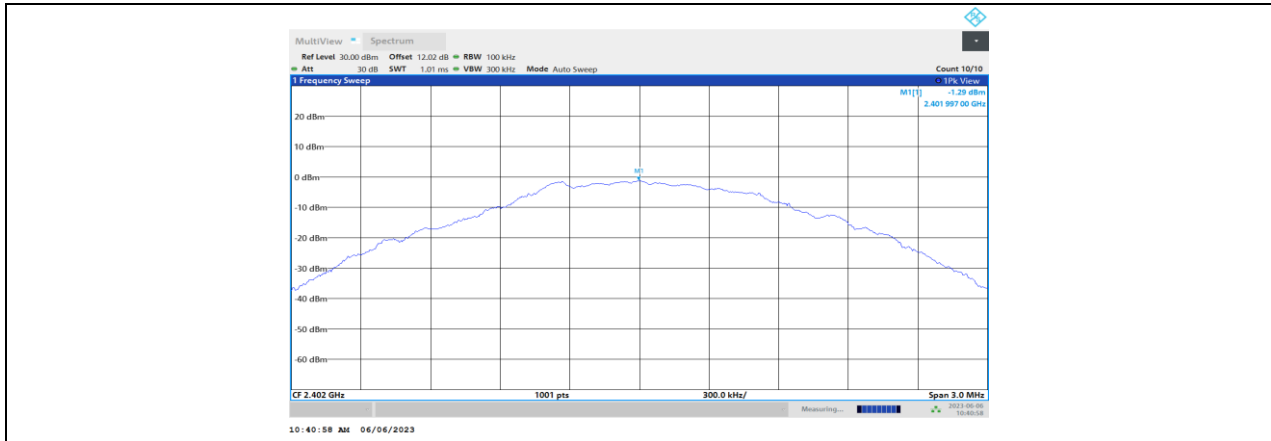

BLE_2M_Ant1_2402_0~Reference

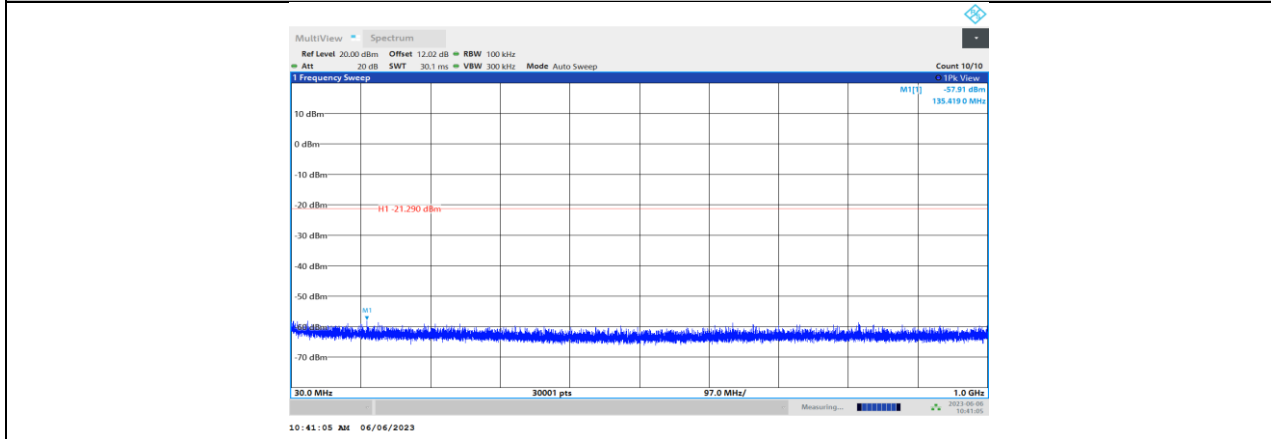

BLE_2M_Ant1_2402_30~1000

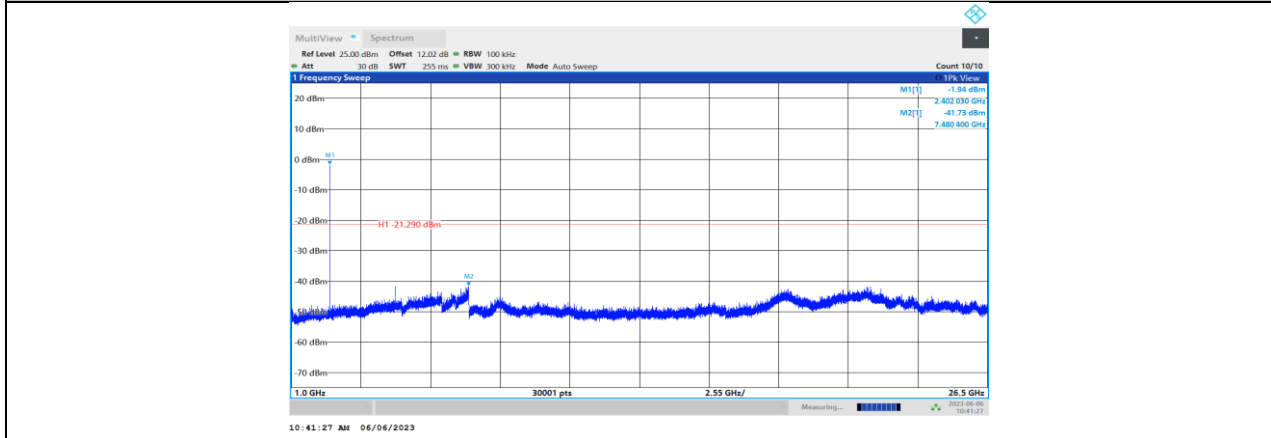

BLE_2M_Ant1_2402_1000~26500

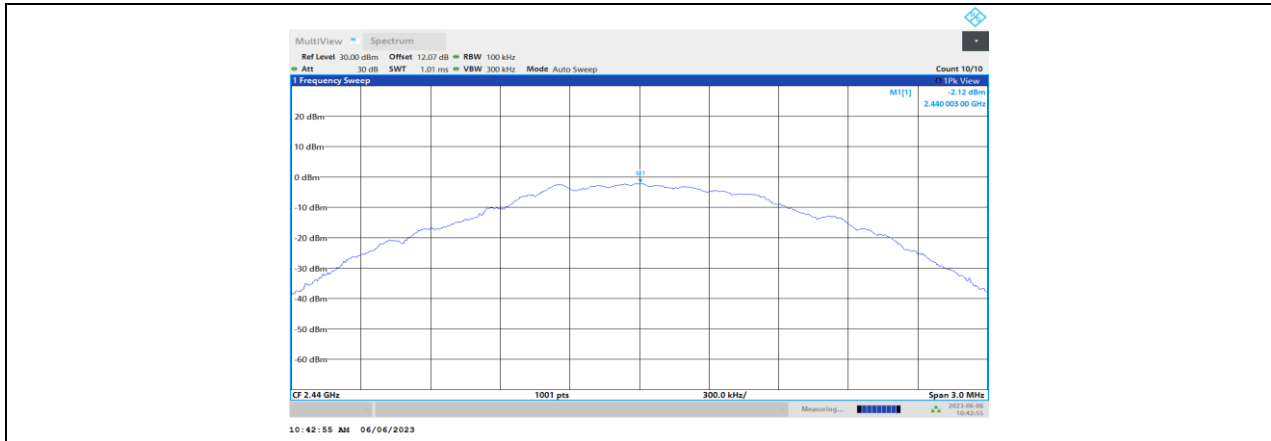

BLE_2M_Ant1_2440_0~Reference

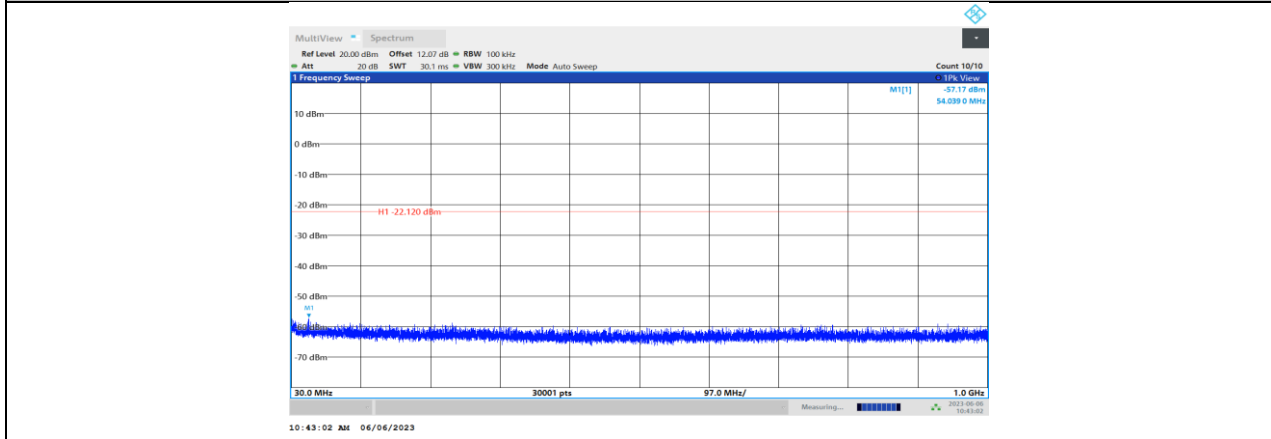

BLE_2M_Ant1_2440_30~1000

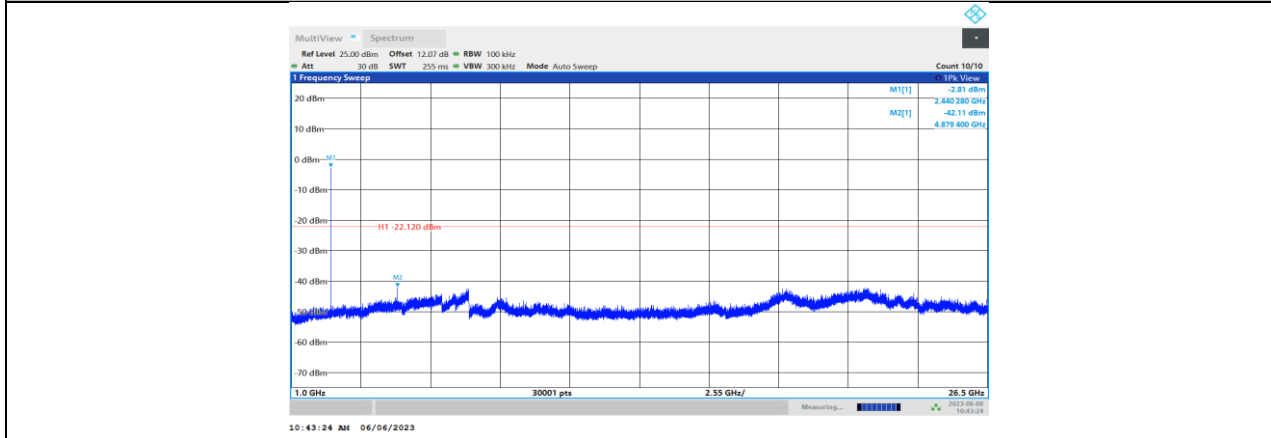

BLE_2M_Ant1_2440_1000~26500

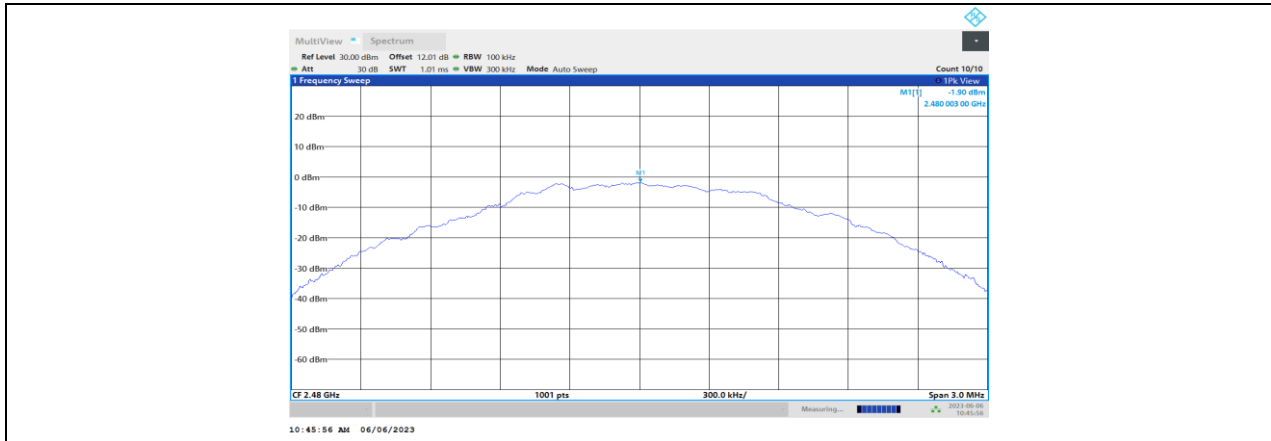

BLE_2M_Ant1_2480_0~Reference

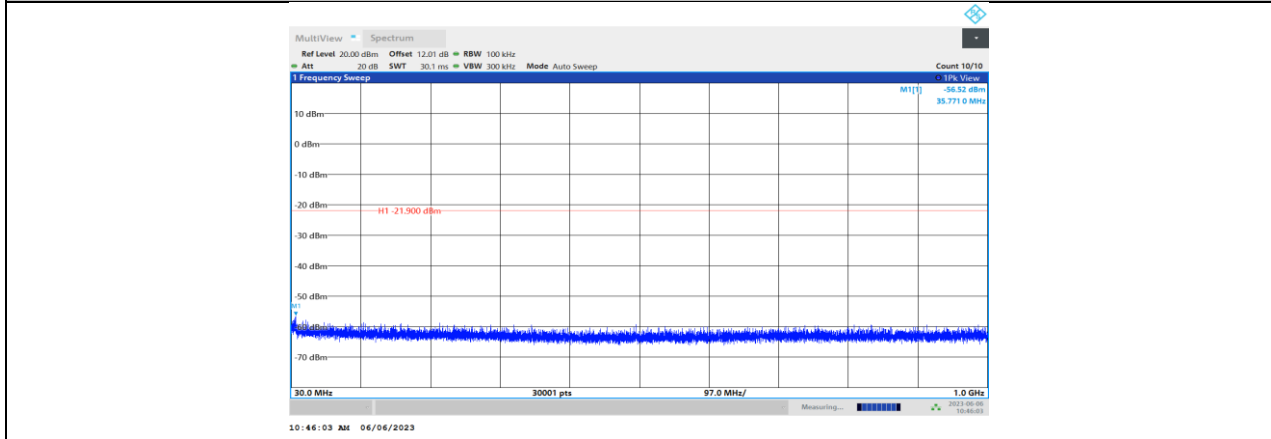

BLE_2M_Ant1_2480_30~1000

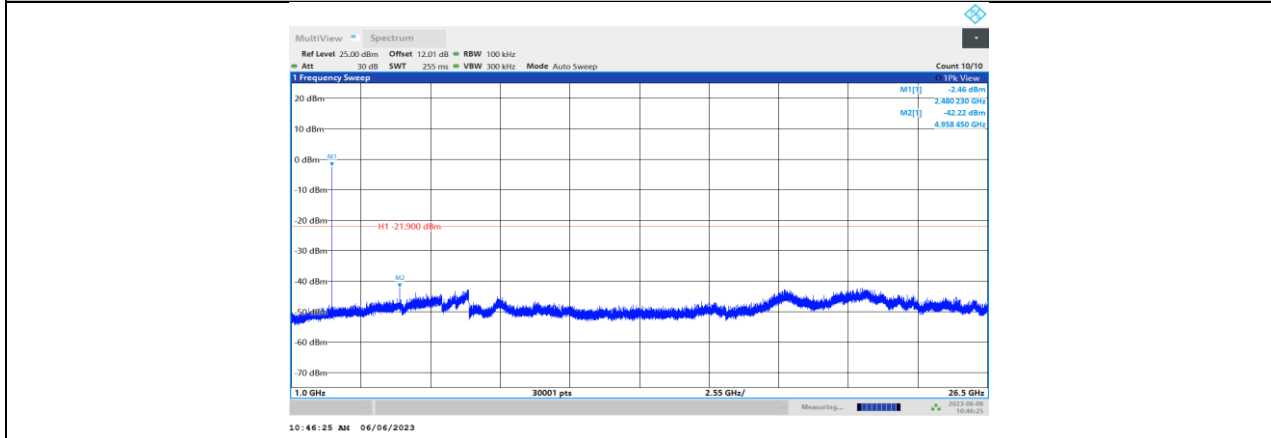

BLE_2M_Ant1_2480_1000~26500

11.7. APPENDIX G: DUTY CYCLE

11.7.1. Test Result

Test Mode	On Time (msec)	Period (msec)	Duty Cycle x (Linear)	Duty Cycle (%)	Duty Cycle Correction Factor (dB)	1/T Minimum VBW (kHz)	Final setting For VBW (kHz)
BLE_1M	100	100	1.0000	100.00	0.00	0.01	0.01
BLE_2M	100	100	1.0000	100.00	0.00	0.01	0.01

Note:

Duty Cycle Correction Factor=10log (1/x).

Where: x is Duty Cycle (Linear)

Where: T is On Time

If that calculated VBW is not available on the analyzer then the next higher value should be used.

11.7.2. Test Graphs



END OF REPORT