

FCC Radio Test Report

FCC ID: 2AIGWYU-01

Original Grant

Report No. : TB-FCC148092
Applicant : Shenzhen Kairuixiang Electronics Co.,Ltd.
Equipment Under Test (EUT)
EUT Name : Anti lost of Bluetooth
Model No. : YU-01
Serial No. : YU-02, YU-03, YU-05, YU-06, YU-07, YU-08, YU-09
Brand Name : N/A
Receipt Date : 2016-03-31
Test Date : 2016-03-31 to 2016-05-12
Issue Date : 2016-05-13
Standards : FCC Part 15: 2015, Subpart C(15.247)
Test Method : ANSI C63.10: 2013
Conclusions : **PASS**

In the configuration tested, the EUT complied with the standards specified above,

Test/Witness Engineer :

IWAN SU

Approved & Authorized :

Ray Lai

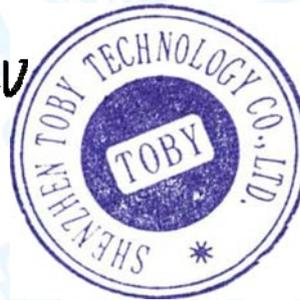

This report details the results of the testing carried out on one sample. The results contained in this test report do not relate to other samples of the same product. The manufacturer should ensure that all products in series production are in conformity with the product sample detailed in the report.

Contents

CONTENTS.....	2
1. GENERAL INFORMATION ABOUT EUT	4
1.1 Client Information.....	4
1.2 General Description of EUT (Equipment Under Test)	4
1.3 Block Diagram Showing the Configuration of System Tested.....	5
1.4 Description of Support Units	5
1.5 Description of Test Mode.....	5
1.6 Description of Test Software Setting	6
1.7 Measurement Uncertainty	7
1.8 Test Facility.....	7
2. TEST SUMMARY	8
3. TEST EQUIPMENT.....	9
4. CONDUCTED EMISSION TEST	10
4.1 Test Standard and Limit.....	10
4.2 Test Setup.....	10
4.3 Test Procedure.....	10
4.4 EUT Operating Mode	11
4.5 Test Data.....	11
5. RADIATED EMISSION TEST	12
5.1 Test Standard and Limit.....	12
5.2 Test Setup.....	13
5.3 Test Procedure.....	14
5.4 EUT Operating Condition	15
5.5 Test Data.....	15
6. RESTRICTED BANDS REQUIREMENT	24
6.1 Test Standard and Limit.....	24
6.2 Test Setup.....	24
6.3 Test Procedure.....	24
6.4 EUT Operating Condition	25
6.5 Test Data.....	25
7. BANDWIDTH TEST.....	31
7.1 Test Standard and Limit.....	31
7.2 Test Setup.....	31
7.3 Test Procedure.....	31
7.4 EUT Operating Condition	31
7.5 Test Data.....	32
8. PEAK OUTPUT POWER TEST.....	34
8.1 Test Standard and Limit.....	34
8.2 Test Setup.....	34

- 8.3 Test Procedure.....34
- 8.4 EUT Operating Condition34
- 8.5 Test Data.....35
- 9. POWER SPECTRAL DENSITY TEST37**
 - 9.1 Test Standard and Limit.....37
 - 9.2 Test Setup.....37
 - 9.3 Test Procedure.....37
 - 9.4 EUT Operating Condition37
 - 9.5 Test Data.....38
- 10. ANTENNA REQUIREMENT.....40**
 - 10.1 Standard Requirement.....40
 - 10.2 Antenna Connected Construction.....40
 - 10.3 Result.....40

1. General Information about EUT

1.1 Client Information

Applicant : Shenzhen Kairuixiang Electronics Co.,Ltd.
Address : Room 8029, F8, Saige Square, Huaqiang North, Futian District, Shenzhen City, China
Manufacturer : Shenzhen Kairuixiang Electronics Co.,Ltd.
Address : Room 8029, F8, Saige Square, Huaqiang North, Futian District, Shenzhen City, China

1.2 General Description of EUT (Equipment Under Test)

EUT Name	: Anti lost of Bluetooth	
Models No.	: YU-01, YU-02, YU-03, YU-05, YU-06, YU-07, YU-08, YU-09	
Model Difference	: All these models are identical in the same PCB, layout and electrical circuit, the only difference is model name for commercial.	
Product Description	Operation Frequency: BLE: 2402MHz~2480MHz	
	Number of Channel:	BLE: 40 channels <i>see note(3)</i>
	RF Output Power:	-0.816 dBm Conducted Power
	Antenna Gain:	-1 dBi PCB Antenna
	Modulation Type:	GFSK
	Bit Rate of Transmitter:	1Mbps(GFSK)
Power Supply	: DC power by Lithium battery.	
Power Rating	: DC 3V by Lithium battery.	
Connecting I/O Port(S)	: Please refer to the User's Manual	

Note:

- (1) This Test Report is FCC Part 15.247 for Bluetooth BLE, the test procedure follows the FCC KDB 558074 D01 DTS Meas Guidance v03r05.
- (2) For a more detailed features description, please refer to the manufacturer's specifications or the User's Manual.
- (3) Antenna information provided by the applicant.
- (4) Channel List:

Channel	Frequency (MHz)	Channel	Frequency (MHz)	Channel	Frequency (MHz)
00	2402	14	2430	28	2458
01	2404	15	2432	29	2460

02	2406	16	2434	30	2462
03	2408	17	2436	31	2464
04	2410	18	2438	32	2466
05	2412	19	2440	33	2468
06	2414	20	2442	34	2470
07	2416	21	2444	35	2472
08	2418	22	2446	36	2474
09	2420	23	2448	37	2476
10	2422	24	2450	38	2478
11	2424	25	2452	39	2480
12	2426	26	2454		
13	2428	27	2456		

1.3 Block Diagram Showing the Configuration of System Tested

TX Mode

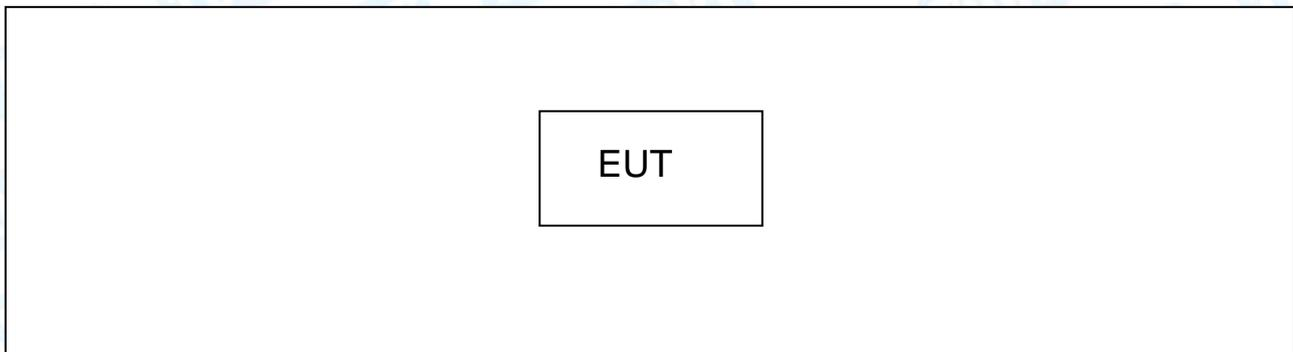

1.4 Description of Support Units

The EUT has been tested as an independent unit.

1.5 Description of Test Mode

To investigate the maximum EMI emission characteristics generated from EUT, the test system was pre-scanning tested based on the consideration of following EUT operation mode or test configuration mode which possibly have effect on EMI emission level. Each of these EUT operation mode(s) or test configuration mode(s) mentioned below was evaluated respectively.

For Conducted Test	
Final Test Mode	Description
Mode 1	TX Mode

For Radiated Test	
Final Test Mode	Description
Mode 2	TX Mode
Mode 3	TX Mode (Channel 00/20/39)

Note:

- (1) For all test, we have verified the construction and function in typical operation. And all the test modes were carried out with the EUT in transmitting operation in maximum power with all kinds of data rate.

According to ANSI C63.10 standards, the measurements are performed at the highest, middle, lowest available channels, and the worst case data rate as follows:

Bluetooth BLE Mode: GFSK Modulation Transmitting mode.

- (2) During the testing procedure, the continuously transmitting with the maximum power mode was programmed by the customer.
- (3) The EUT is considered a mobile unit; in normal use it was positioned on X-plane. The worst case was found positioned on X-plane. Therefore only the test data of this X-plane was used for radiated emission measurement test.

1.6 Description of Test Software Setting

During testing channel & Power controlling software provided by the customer was used to control the operating channel as well as the output power level. The RF output power selection is for the setting of RF output power expected by the customer and is going to be fixed on the firmware of the final end product power parameters of RF setting.

Test Software Version	BK3256 RF Test_V1.3		
Frequency	2402 MHz	2442MHz	2480 MHz
BLE GFSK	DEF	DEF	DEF

1.7 Measurement Uncertainty

The reported uncertainty of measurement $y \pm U$, where expanded uncertainty U is based on a standard uncertainty multiplied by a coverage factor of $k=2$, providing a level of confidence of approximately 95 %.

Test Item	Parameters	Expanded Uncertainty (U_{Lab})
Conducted Emission	Level Accuracy: 9kHz~150kHz	± 3.42 dB
	150kHz to 30MHz	± 3.42 dB
Radiated Emission	Level Accuracy: 9kHz to 30 MHz	± 4.60 dB
Radiated Emission	Level Accuracy: 30MHz to 1000 MHz	± 4.40 dB
Radiated Emission	Level Accuracy: Above 1000MHz	± 4.20 dB

1.8 Test Facility

The testing was performed by the Shenzhen Toby Technology Co., Ltd., in their facilities located at:

1A/F., Bldg.6, Yusheng Industrial Zone, The National Road No.107 Xixiang Section 467, Xixiang, Bao'an, Shenzhen, Guangdong, China.

At the time of testing, the following bodies accredited the Laboratory:

CNAS (L5813)

The Laboratory has been accredited by CNAS to ISO/IEC 17025: 2005 General Requirements for the Competence of Testing and Calibration Laboratories for the competence in the field of testing. And the Registration No.: CNAS L5813.

FCC List No.: (811562)

The Laboratory is listed in the United States of American Federal Communications Commission (FCC), and the registration number is 811562.

IC Registration No.: (11950A-1)

The Laboratory has been registered by Certification and Engineering Bureau of Industry Canada for radio equipment testing. The site registration: Site# 11950A-1.

2. Test Summary

FCC Part 15 Subpart C(15.247)/RSS 247 Issue 1				
Standard Section		Test Item	Judgment	Remark
FCC	IC			
15.203		Antenna Requirement	PASS	N/A
15.207	RSS-GEN 7.2.4	Conducted Emission	N/A	(1)
15.205	RSS-GEN 7.2.2	Restricted Bands	PASS	N/A
15.247(a)(2)	RSS 247 5.2 (1)	6dB Bandwidth	PASS	N/A
15.247(b)	RSS 247 5.4 (4)	Peak Output Power	PASS	N/A
15.247(e)	RSS 247 5.2 (2)	Power Spectral Density	PASS	N/A
15.247(d)	RSS 247 5.5	Transmitter Radiated Spurious Emission	PASS	N/A

Note (1)The EUT is powered by DC battery, no requirement for this test item.
N/A is an abbreviation for Not Applicable.

3. Test Equipment

Conducted Emission Test					
Equipment	Manufacturer	Model No.	Serial No.	Last Cal.	Cal. Due Date
EMI Test Receiver	Rohde & Schwarz	ESCI	100321	Aug. 07, 2015	Aug. 06, 2016
RF Switching Unit	Compliance Direction Systems Inc	RSU-A4	34403	Aug. 07, 2015	Aug. 06, 2016
AMN	SCHWARZBECK	NNBL 8226-2	8226-2/164	Aug. 07, 2015	Aug. 06, 2016
LISN	Rohde & Schwarz	ENV216	101131	Aug. 08, 2015	Aug. 07, 2016
Radiation Emission Test					
Equipment	Manufacturer	Model No.	Serial No.	Last Cal.	Cal. Due Date
Spectrum Analyzer	Agilent	E4407B	MY45106456	Aug. 29, 2015	Aug. 28, 2016
EMI Test Receiver	Rohde & Schwarz	ESCI	100010/007	Aug. 07, 2015	Aug. 06, 2016
Bilog Antenna	ETS-LINDGREN	3142E	00117537	Mar. 26, 2016	Mar. 25, 2017
Bilog Antenna	ETS-LINDGREN	3142E	00117542	Mar. 26, 2016	Mar. 25, 2017
Horn Antenna	ETS-LINDGREN	3117	00143207	Mar. 26, 2016	Mar. 25, 2017
Horn Antenna	ETS-LINDGREN	3117	00143209	Mar. 26, 2016	Mar. 25, 2017
Pre-amplifier	Sonoma	310N	185903	Mar. 26, 2016	Mar. 25, 2017
Pre-amplifier	HP	8447B	3008A00849	Mar. 26, 2016	Mar. 25, 2017
Cable	HUBER+SUHNER	100	SUCOFLEX	Mar. 26, 2016	Mar. 25, 2017
Positioning Controller	ETS-LINDGREN	2090	N/A	N/A	N/A

4. Conducted Emission Test

4.1 Test Standard and Limit

4.1.1 Test Standard

FCC Part 15.207

4.1.2 Test Limit

Conducted Emission Test Limit

Frequency	Maximum RF Line Voltage (dB μ V)	
	Quasi-peak Level	Average Level
150kHz~500kHz	66 ~ 56 *	56 ~ 46 *
500kHz~5MHz	56	46
5MHz~30MHz	60	50

Notes:

(1) *Decreasing linearly with logarithm of the frequency.

(2) The lower limit shall apply at the transition frequencies.

(3) The limit decrease in line with the logarithm of the frequency in the range of 0.15 to 0.50MHz.

4.2 Test Setup

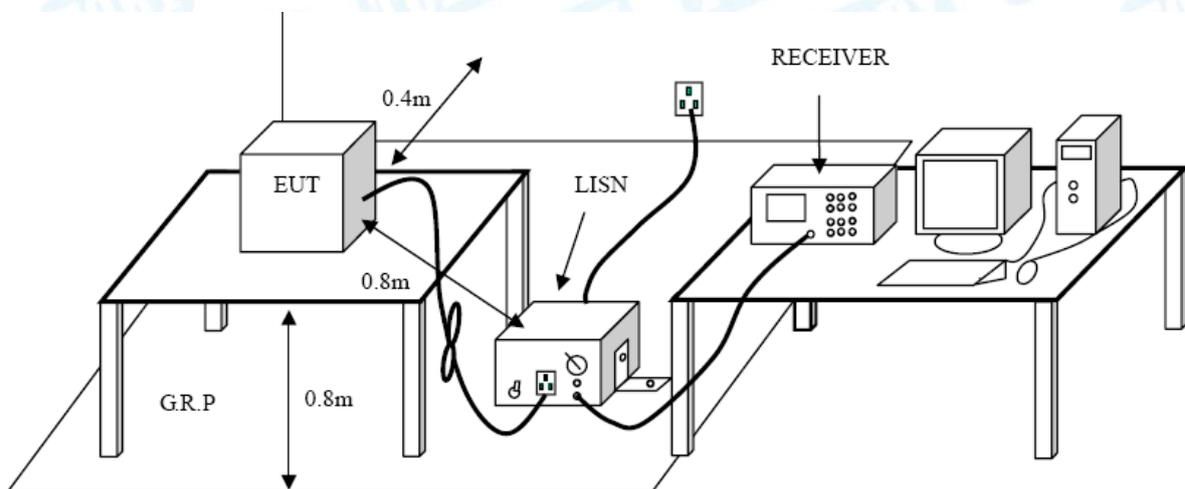

4.3 Test Procedure

The EUT was placed 0.8 meters from the horizontal ground plane with EUT being connected to the power mains through a line impedance stabilization network (LISN). All other support equipments powered from additional LISN(s). The LISN provide 50 Ohm/ 50uH of coupling impedance for the measuring instrument.

Interconnecting cables that hang closer than 40 cm to the ground plane shall be folded back and forth in the center forming a bundle 30 to 40 cm long.

I/O cables that are not connected to a peripheral shall be bundled in the center. The end of the cable may be terminated, if required, using the correct terminating impedance. The overall length shall not exceed 1 m.

LISN at least 80 cm from nearest part of EUT chassis.

The bandwidth of EMI test receiver is set at 9kHz, and the test frequency band is from 0.15MHz to 30MHz.

4.4 EUT Operating Mode

Please refer to the description of test mode.

4.5 Test Data

The EUT is powered by DC battery, no requirement for this test item.

5. Radiated Emission Test

5.1 Test Standard and Limit

5.1.1 Test Standard

FCC Part 15.209

5.1.2 Test Limit

Radiated Emission Limits (9kHz~1000MHz)

Frequency (MHz)	Field Strength (microvolt/meter)	Measurement Distance (meters)
0.009~0.490	2400/F(KHz)	300
0.490~1.705	24000/F(KHz)	30
1.705~30.0	30	30
30~88	100	3
88~216	150	3
216~960	200	3
Above 960	500	3

Radiated Emission Limit (Above 1000MHz)

Frequency (MHz)	Class A (dBuV/m)(at 3 M)		Class B (dBuV/m)(at 3 M)	
	Peak	Average	Peak	Average
Above 1000	80	60	74	54

Note:

- (1) The tighter limit applies at the band edges.
- (2) Emission Level(dBuV/m)=20log Emission Level(uV/m)

5.2 Test Setup

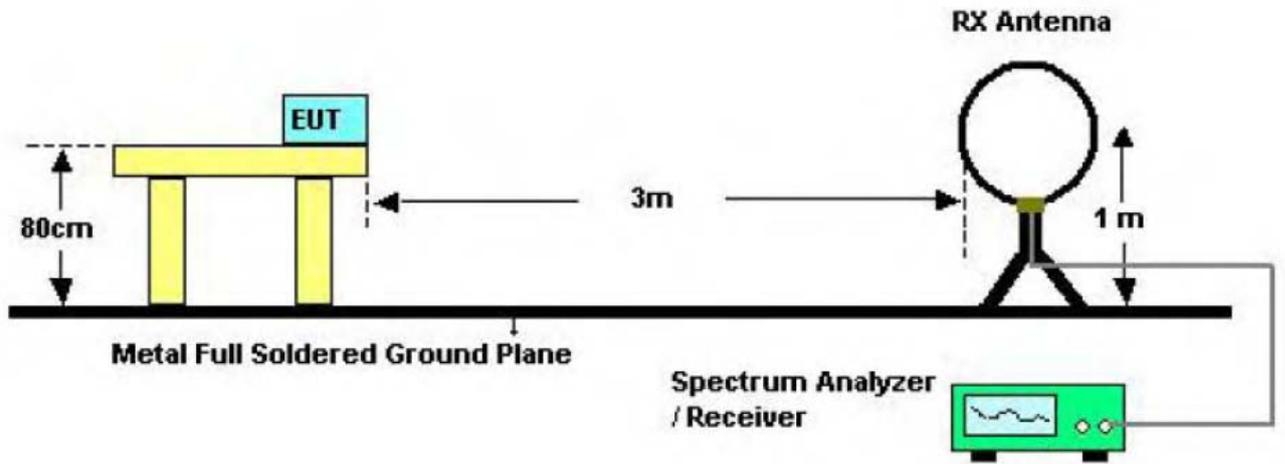

Below 30MHz Test Setup

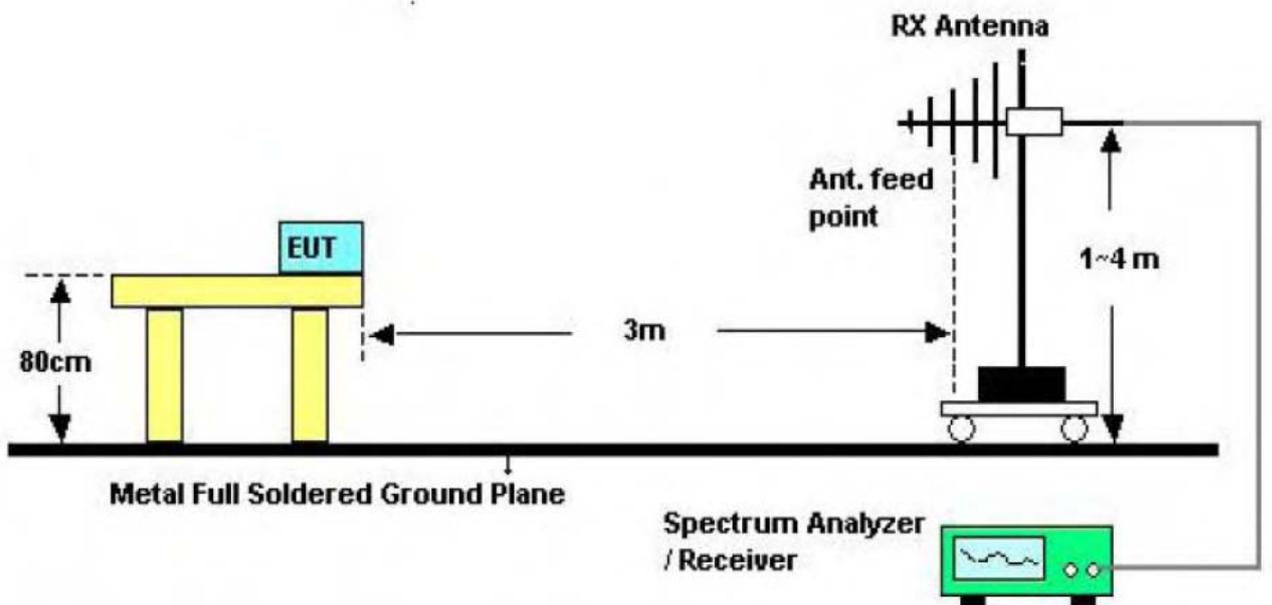

Below 1000MHz Test Setup

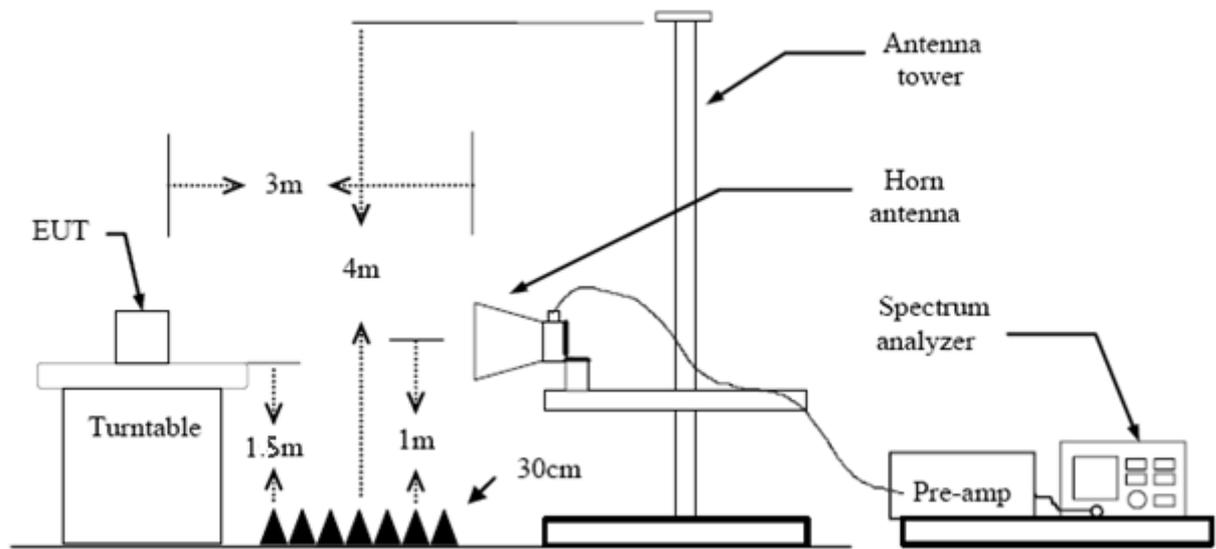

Above 1GHz Test Setup

5.3 Test Procedure

- (1) The measuring distance of 3m shall be used for measurements at frequency up to 1GHz and above 1 GHz. The EUT was placed on a rotating 0.8m high above ground, the table was rotated 360 degrees to determine the position of the highest radiation.
- (2) Measurements at frequency above 1GHz. The EUT was placed on a rotating 1.5m high above the ground. RF absorbers covered the ground plane with a minimum area of 3.0m by 3.0m between the EUT and measurement receiver antenna. The RF absorber shall not exceed 30cm in high above the conducting floor. The table was rotated 360 degrees to determine the position of the highest radiation.
- (3) The Test antenna shall vary between 1m and 4m, Both Horizontal and Vertical antenna are set to make measurement.
- (4) The initial step in collecting conducted emission data is a spectrum analyzer peak detector mode pre-scanning the measurement frequency range. Significant peaks are then marked and then Quasi Peak detector mode re-measured.
- (5) If the Peak Mode measured value compliance with and lower than Quasi Peak Mode Limit Bellow 1 GHz, the EUT shall be deemed to meet QP Limits and then no additional QP Mode measurement performed. But the Peak Value and average value both need to comply with applicable limit above 1 GHz.
- (6) Testing frequency range below 1GHz the measuring instrument use VBW=120 kHz with Quasi-peak detection.
- (7) Testing frequency range above 1GHz the measuring instrument use RBW=1 MHz and VBW=3 MHz with Peak Detector for Peak Values, and use RBW=1 MHz and VBW=10 Hz with Peak Detector for Average Values.
- (8) For the actual test configuration, please see the test setup photo.

5.4 EUT Operating Condition

The Equipment Under Test was set to Continual Transmitting in maximum power.

5.5 Test Data

Remark: During testing above 1GHz the measuring instrument use RBW=1 MHz and VBW=3 MHz with Peak Detector for Peak Values, and use RBW=1 MHz and VBW=10 kHz with Peak Detector for Average Values.

Test data please refer the following pages.

EUT:	Anti lost of Bluetooth	Model:	YU-01
Temperature:	25 °C	Relative Humidity:	55%
Test Voltage:	DC 3V		
Ant. Pol.	Horizontal		
Test Mode:	BLE TX 2402 Mode		
Remark:	Only worse case is reported		

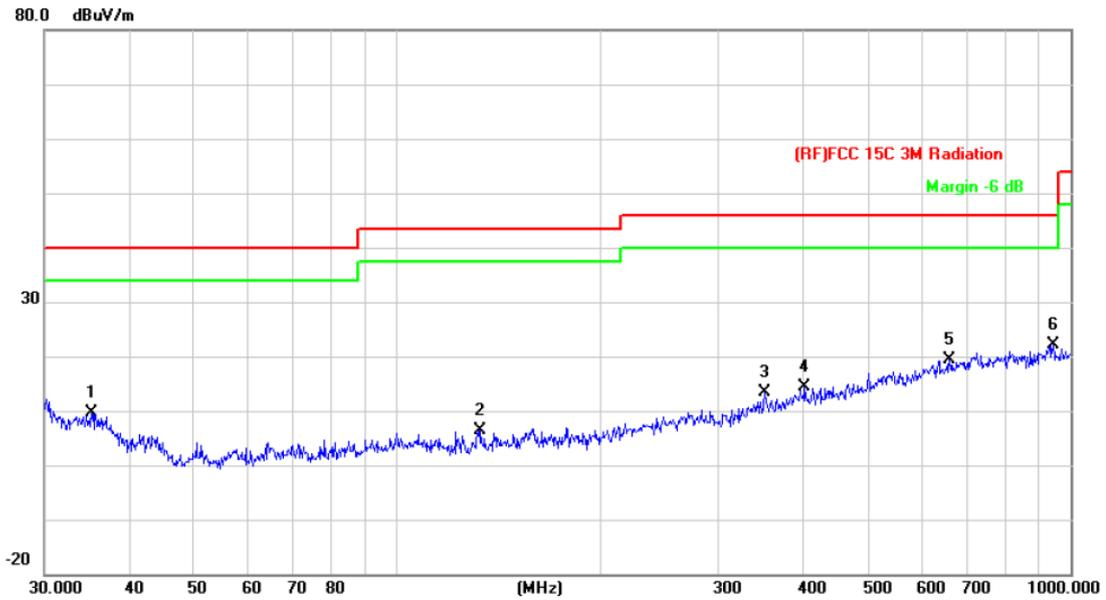

No.	Mk.	Freq. MHz	Reading Level dBuV	Correct Factor dB/m	Measure- ment dBuV/m	Limit dBuV/m	Over dB	Detector
1		35.2512	26.83	-17.21	9.62	40.00	-30.38	peak
2		133.1511	28.43	-22.12	6.31	43.50	-37.19	peak
3		351.7079	27.93	-14.60	13.33	46.00	-32.67	peak
4		403.2500	27.22	-12.82	14.40	46.00	-31.60	peak
5		661.1505	27.57	-8.21	19.36	46.00	-26.64	peak
6	*	942.1305	26.87	-4.83	22.04	46.00	-23.96	peak

*:Maximum data x:Over limit !:over margin

Emission Level= Read Level+ Correct Factor

EUT:	Anti lost of Bluetooth	Model:	YU-01
Temperature:	25 °C	Relative Humidity:	55%
Test Voltage:	DC 3V		
Ant. Pol.	Vertical		
Test Mode:	BLE TX 2402 Mode		
Remark:	Only worse case is reported		

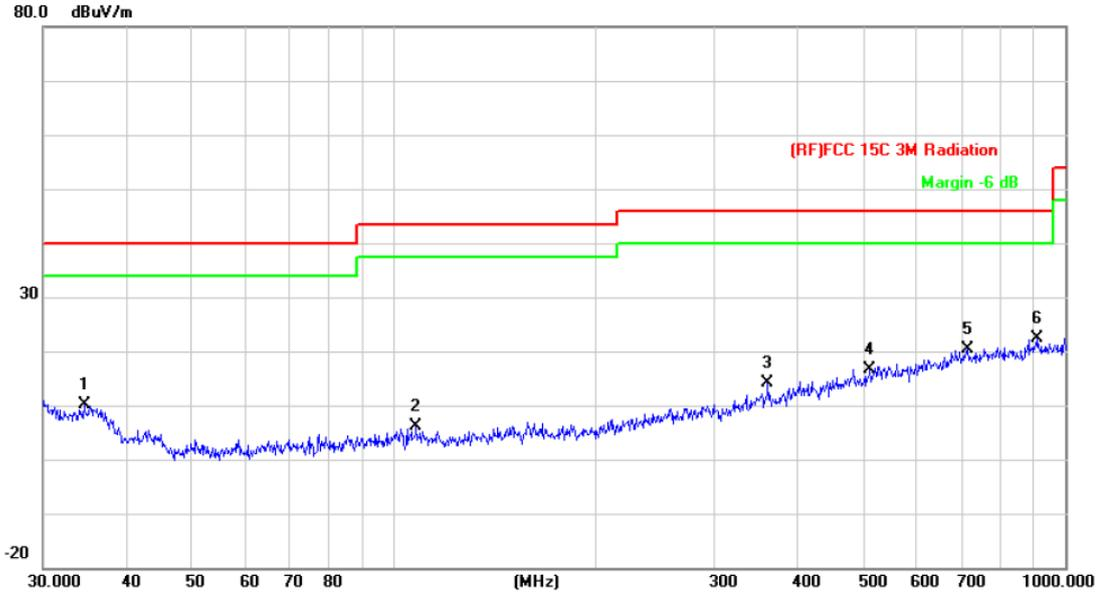

No.	Mk.	Freq.	Reading Level	Correct Factor	Measurement	Limit	Over	Detector
		MHz	dBuV	dB/m	dBuV/m	dBuV/m	dB	
1		34.5173	26.79	-16.76	10.03	40.00	-29.97	peak
2		107.8877	27.93	-21.86	6.07	43.50	-37.43	peak
3		360.4476	28.67	-14.55	14.12	46.00	-31.88	peak
4		511.8352	27.64	-10.97	16.67	46.00	-29.33	peak
5		714.1734	27.50	-7.02	20.48	46.00	-25.52	peak
6	*	909.6667	27.41	-4.96	22.45	46.00	-23.55	peak

*:Maximum data x:Over limit !:over margin

Emission Level= Read Level+ Correct Factor

EUT:	Anti lost of Bluetooth	Model:	YU-01
Temperature:	25 °C	Relative Humidity:	55%
Test Voltage:	DC 3V		
Ant. Pol.	Horizontal		
Test Mode:	BLE Mode TX 2402 MHz		
Remark:	No report for the emission which more than 10 dB below the prescribed limit.		

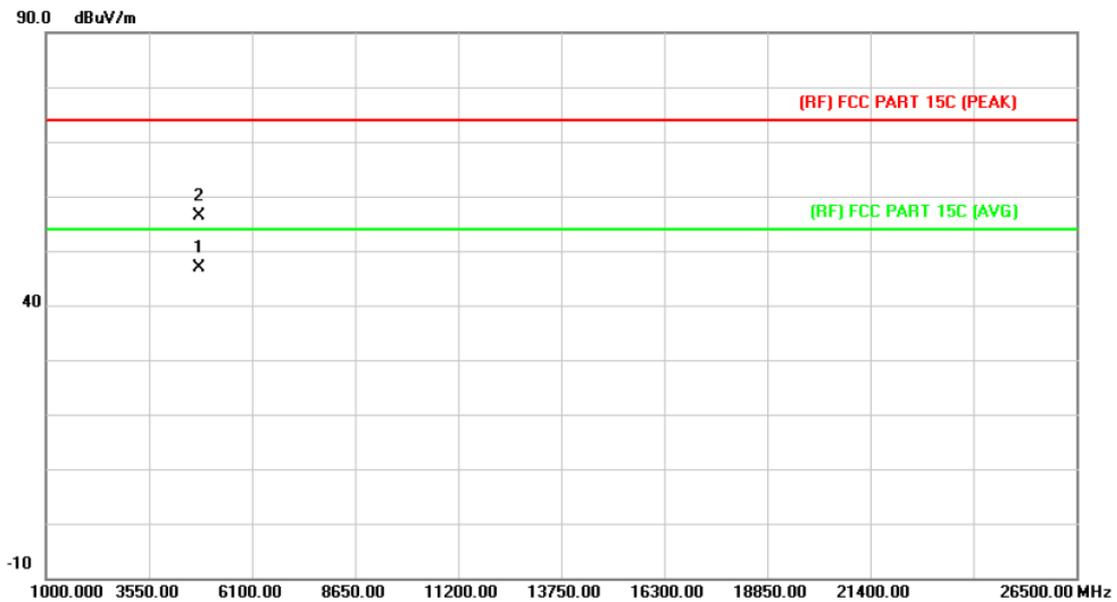

No.	Mk.	Freq.	Reading Level	Correct Factor	Measurement	Limit	Over	Detector
		MHz	dBuV	dB/m	dBuV/m	dBuV/m	dB	
1	*	4803.954	33.44	13.44	46.88	54.00	-7.12	AVG
2		4804.366	42.92	13.44	56.36	74.00	-17.64	peak

Emission Level= Read Level+ Correct Factor

EUT:	Anti lost of Bluetooth	Model:	YU-01
Temperature:	25 °C	Relative Humidity:	55%
Test Voltage:	DC 3V		
Ant. Pol.	Vertical		
Test Mode:	BLE Mode TX 2402 MHz		
Remark:	No report for the emission which more than 10 dB below the prescribed limit.		

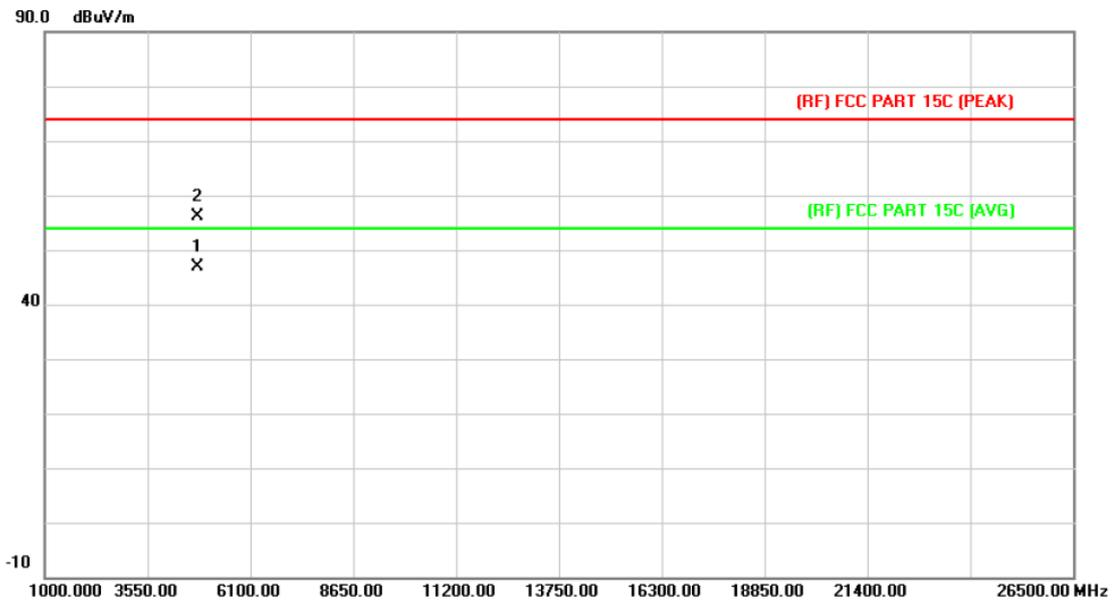

No.	Mk.	Freq.	Reading Level	Correct Factor	Measurement	Limit	Over	Detector
		MHz	dBuV	dB/m	dBuV/m	dBuV/m	dB	
1	*	4803.629	33.50	13.44	46.94	54.00	-7.06	AVG
2		4804.418	42.74	13.44	56.18	74.00	-17.82	peak

Emission Level= Read Level+ Correct Factor

EUT:	Anti lost of Bluetooth	Model:	YU-01
Temperature:	25 °C	Relative Humidity:	55%
Test Voltage:	DC 3V		
Ant. Pol.	Horizontal		
Test Mode:	BLE Mode TX 2442 MHz		
Remark:	No report for the emission which more than 10 dB below the prescribed limit.		

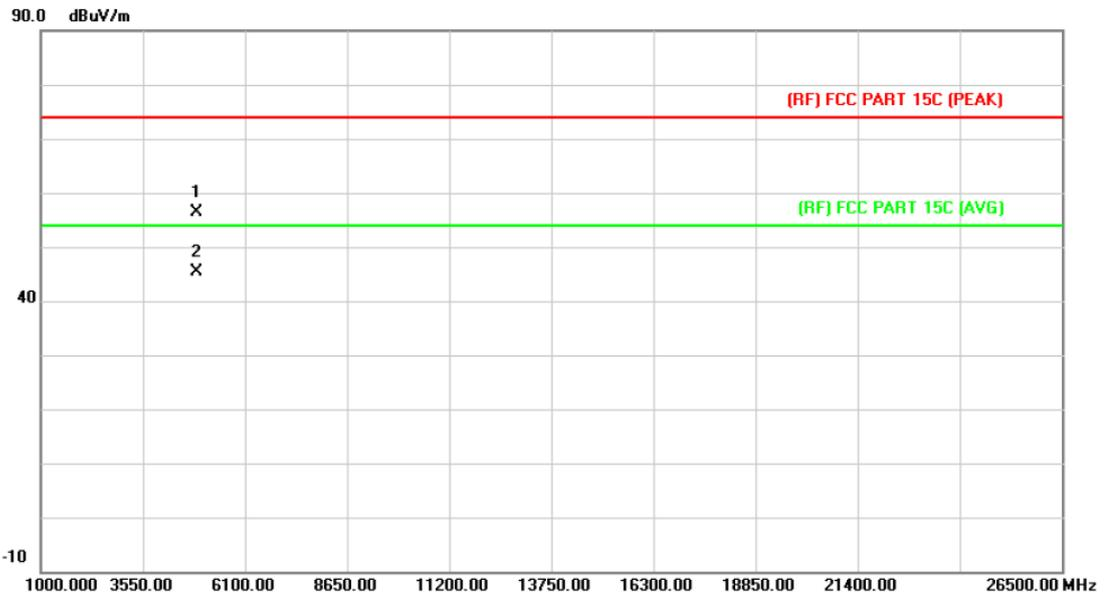

No.	Mk.	Freq.	Reading Level	Correct Factor	Measurement	Limit	Over	Detector
		MHz	dBuV	dB/m	dBuV/m	dBuV/m	dB	
1		4883.985	42.43	13.92	56.35	74.00	-17.65	peak
2	*	4883.985	31.58	13.92	45.50	54.00	-8.50	AVG

Emission Level= Read Level+ Correct Factor

EUT:	Anti lost of Bluetooth	Model:	YU-01
Temperature:	25 °C	Relative Humidity:	55%
Test Voltage:	DC 3V		
Ant. Pol.	Vertical		
Test Mode:	BLE Mode TX 2442 MHz		
Remark:	No report for the emission which more than 10 dB below the prescribed limit.		

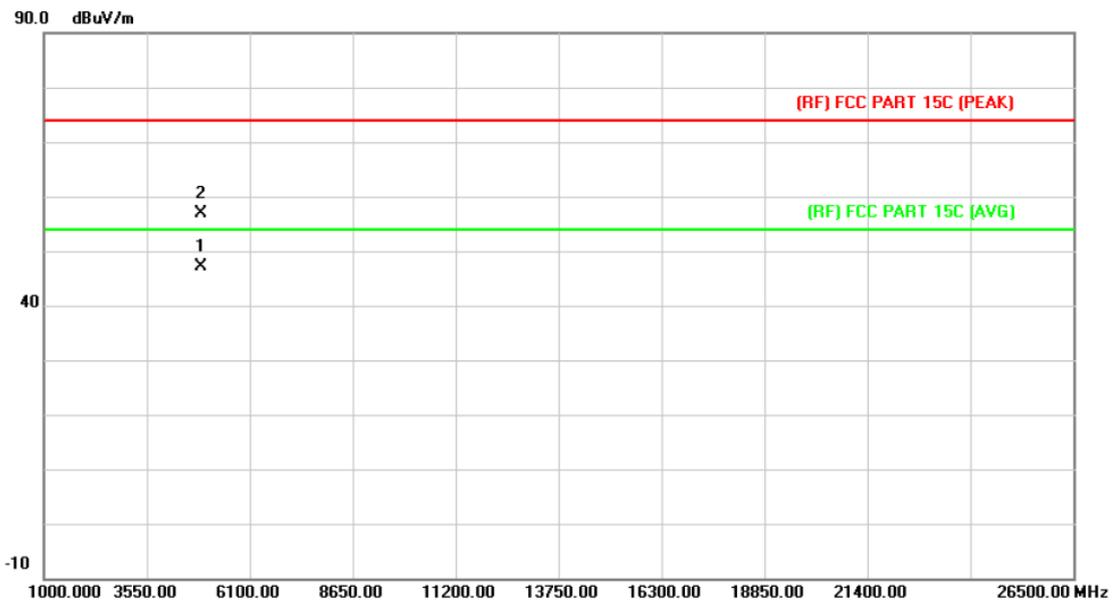

No.	Mk.	Freq. MHz	Reading Level dBuV	Correct Factor dB/m	Measure- ment dBuV/m	Limit dBuV/m	Over dB	Detector
1	*	4883.856	33.24	13.92	47.16	54.00	-6.84	AVG
2		4883.999	42.91	13.92	56.83	74.00	-17.17	peak

Emission Level= Read Level+ Correct Factor

EUT:	Anti lost of Bluetooth	Model:	YU-01
Temperature:	25 °C	Relative Humidity:	55%
Test Voltage:	DC 3V		
Ant. Pol.	Horizontal		
Test Mode:	BLE Mode TX 2480 MHz		
Remark:	No report for the emission which more than 10 dB below the prescribed limit.		

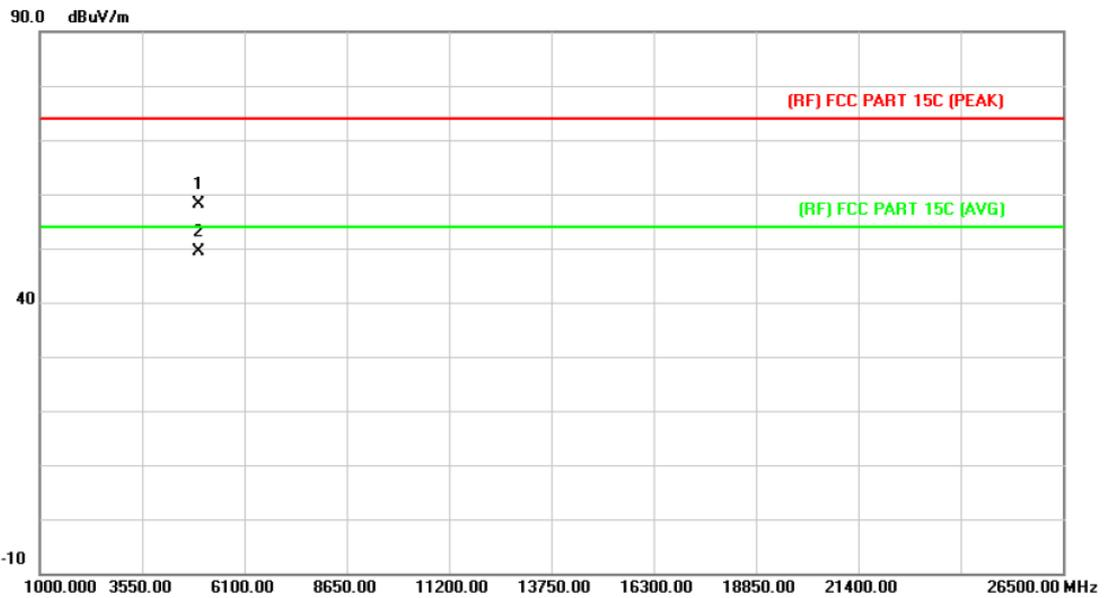

No.	Mk.	Freq.	Reading Level	Correct Factor	Measurement	Limit	Over	Detector
		MHz	dBuV	dB/m	dBuV/m	dBuV/m	dB	
1		4960.048	43.66	14.36	58.02	74.00	-15.98	peak
2	*	4960.048	35.03	14.36	49.39	54.00	-4.61	AVG

Emission Level= Read Level+ Correct Factor

EUT:	Anti lost of Bluetooth	Model:	YU-01
Temperature:	25 °C	Relative Humidity:	55%
Test Voltage:	DC 3V		
Ant. Pol.	Vertical		
Test Mode:	BLE Mode TX 2480 MHz		
Remark:	No report for the emission which more than 10 dB below the prescribed limit.		

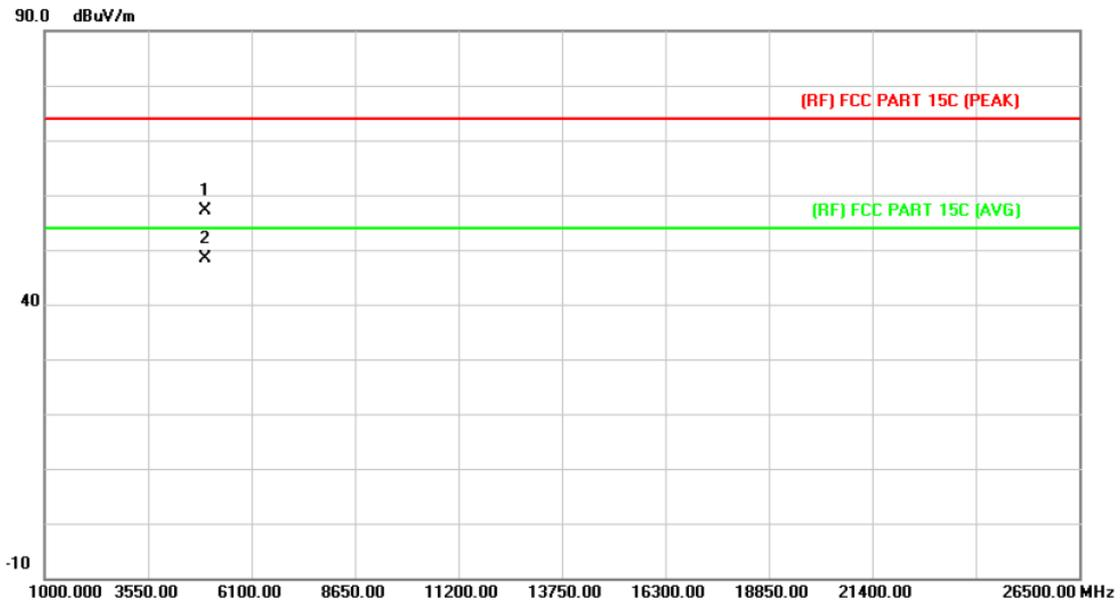

No.	Mk.	Freq. MHz	Reading Level dBuV	Correct Factor dB/m	Measure- ment dBuV/m	Limit dBuV/m	Over dB	Detector
1		4960.067	42.68	14.36	57.04	74.00	-16.96	peak
2	*	4960.328	33.90	14.36	48.26	54.00	-5.74	AVG

Emission Level= Read Level+ Correct Factor

6. Restricted Bands Requirement

6.1 Test Standard and Limit

6.1.1 Test Standard

FCC Part 15.209 FCC Part 15.205

6.1.2 Test Limit

Restricted Frequency Band (MHz)	Class B (dBuV/m)(at 3 M)	
	Peak	Average
2310 ~2390	74	54
2483.5 ~2500	74	54

6.2 Test Setup

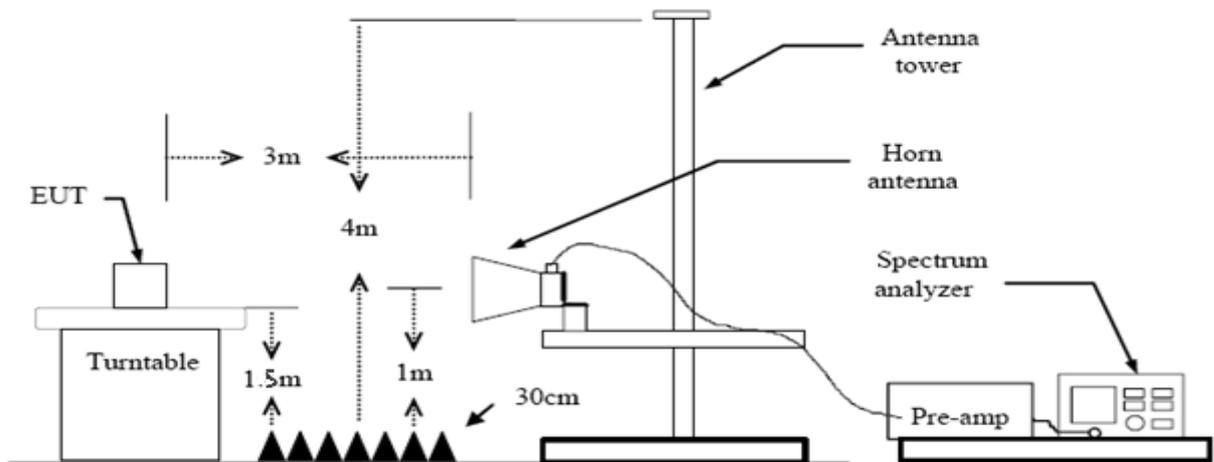

6.3 Test Procedure

- (1) The measuring distance of 3m shall be used for measurements at frequency up to 1GHz and above 1 GHz. The EUT was placed on a rotating 0.8m high above ground, the table was rotated 360 degrees to determine the position of the highest radiation.
- (2) Measurements at frequency above 1GHz. The EUT was placed on a rotating 1.5m high above the ground. RF absorbers covered the ground plane with a minimum area of 3.0m by 3.0m between the EUT and measurement receiver antenna. The RF absorber shall not exceed 30cm in high above the conducting floor. The table was rotated 360 degrees to determine the position of the highest radiation.
- (3) The Test antenna shall vary between 1m and 4m, Both Horizontal and Vertical antenna are set to make measurement.
- (4) The initial step in collecting conducted emission data is a spectrum analyzer peak detector mode pre-scanning the measurement frequency range. Significant peaks are then marked

and then Quasi Peak detector mode re-measured.

- (5) If the Peak Mode measured value compliance with and lower than Quasi Peak Mode Limit Bellow 1 GHz, the EUT shall be deemed to meet QP Limits and then no additional QP Mode measurement performed. But the Peak Value and average value both need to comply with applicable limit above 1 GHz.
- (6) Testing frequency range below 1GHz the measuring instrument use VBW=120 kHz with Quasi-peak detection.
- (7) Testing frequency range above 1GHz the measuring instrument use RBW=1 MHz and VBW=3 MHz with Peak Detector for Peak Values, and use RBW=1 MHz and VBW=10 Hz with Peak Detector for Average Values.
- (8) For the actual test configuration, please see the test setup photo.

6.4 EUT Operating Condition

The Equipment Under Test was set to Continual Transmitting in maximum power.

6.5 Test Data

Remark: During testing above 1GHz the measuring instrument use RBW=1 MHz and VBW=3 MHz with Peak Detector for Peak Values, and use RBW=1 MHz and VBW=10 kHz with Peak Detector for Average Values.

Test data please refer the following pages.

(1) Radiation Test

EUT:	Anti lost of Bluetooth	Model:	YU-01
Temperature:	25 °C	Relative Humidity:	55%
Test Voltage:	DC 3V		
Ant. Pol.	Horizontal		
Test Mode:	BLE Mode TX 2402 MHz		
Remark:	N/A		

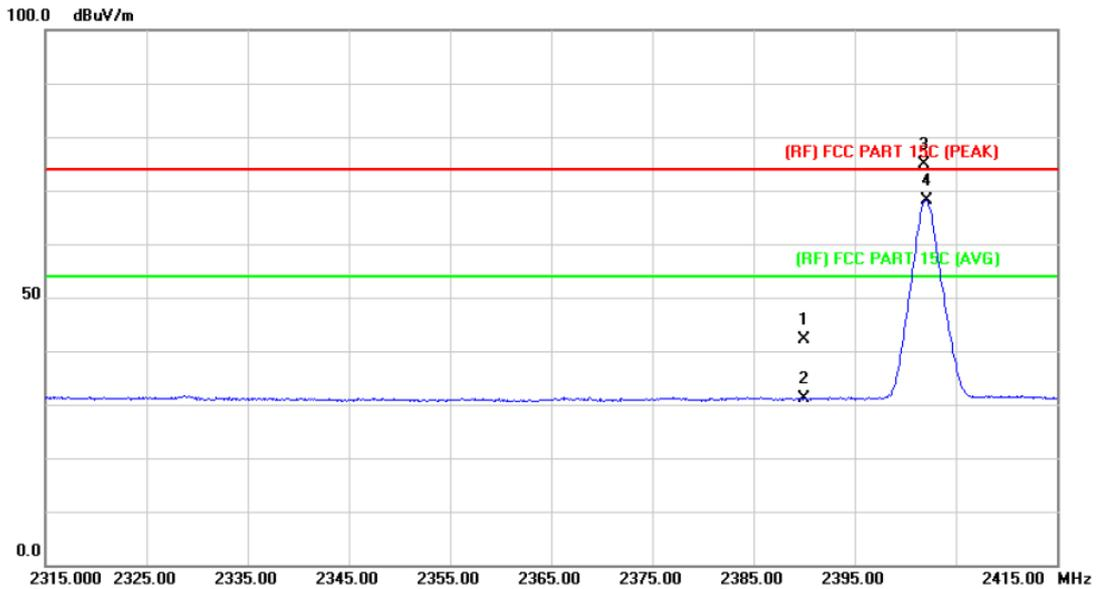

No.	Mk.	Freq.	Reading Level	Correct Factor	Measurement	Limit	Over	Detector
		MHz	dBuV	dB/m	dBuV/m	dBuV/m	dB	
1		2390.000	41.29	0.77	42.06	74.00	-31.94	peak
2		2390.000	30.30	0.77	31.07	54.00	-22.93	AVG
3	X	2401.900	73.97	0.82	74.79	Fundamental Frequency		peak
4	*	2402.100	67.36	0.82	68.18	Fundamental Frequency		AVG

Emission Level= Read Level+ Correct Factor

EUT:	Anti lost of Bluetooth	Model:	YU-01
Temperature:	25 °C	Relative Humidity:	55%
Test Voltage:	DC 3V		
Ant. Pol.	Vertical		
Test Mode:	BLE Mode TX 2480 MHz		
Remark:	N/A		

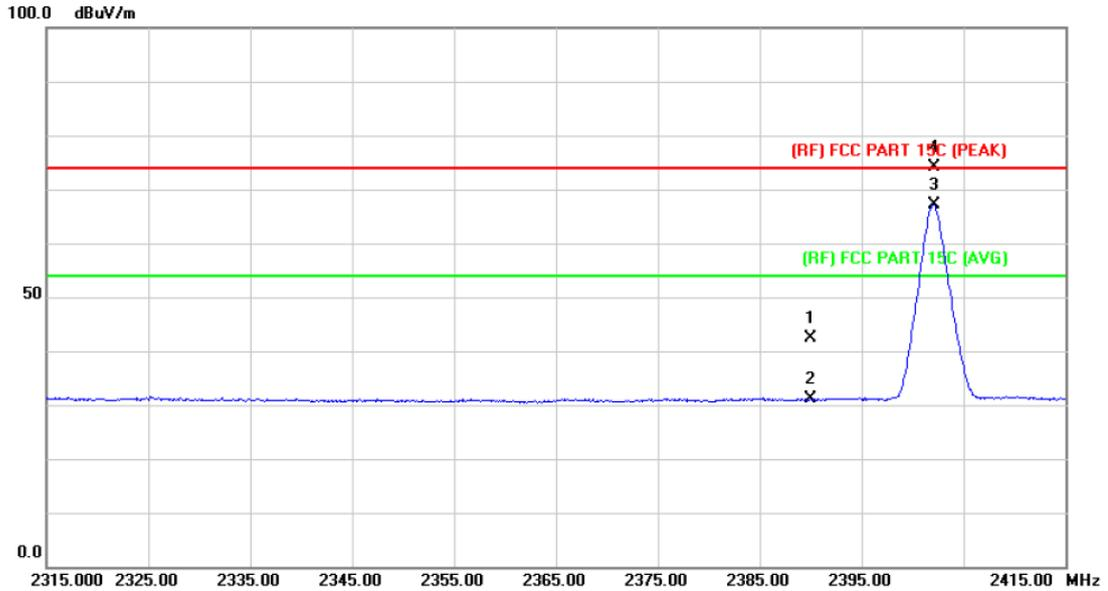

No.	Mk.	Freq. MHz	Reading Level dBuV	Correct Factor dB/m	Measure- ment dBuV/m	Limit dBuV/m	Over dB	Detecto
1		2390.000	41.62	0.77	42.39	74.00	-31.61	peak
2		2390.000	30.29	0.77	31.06	54.00	-22.94	AVG
3	*	2402.100	66.40	0.82	67.22	Fundamental Frequency		AVG
4	X	2402.200	73.25	0.82	74.07	Fundamental Frequency		peak

Emission Level= Read Level+ Correct Factor

EUT:	Anti lost of Bluetooth	Model:	YU-01
Temperature:	25 °C	Relative Humidity:	55%
Test Voltage:	DC 3V		
Ant. Pol.	Horizontal		
Test Mode:	BLE Mode TX 2480 MHz		
Remark:	N/A		

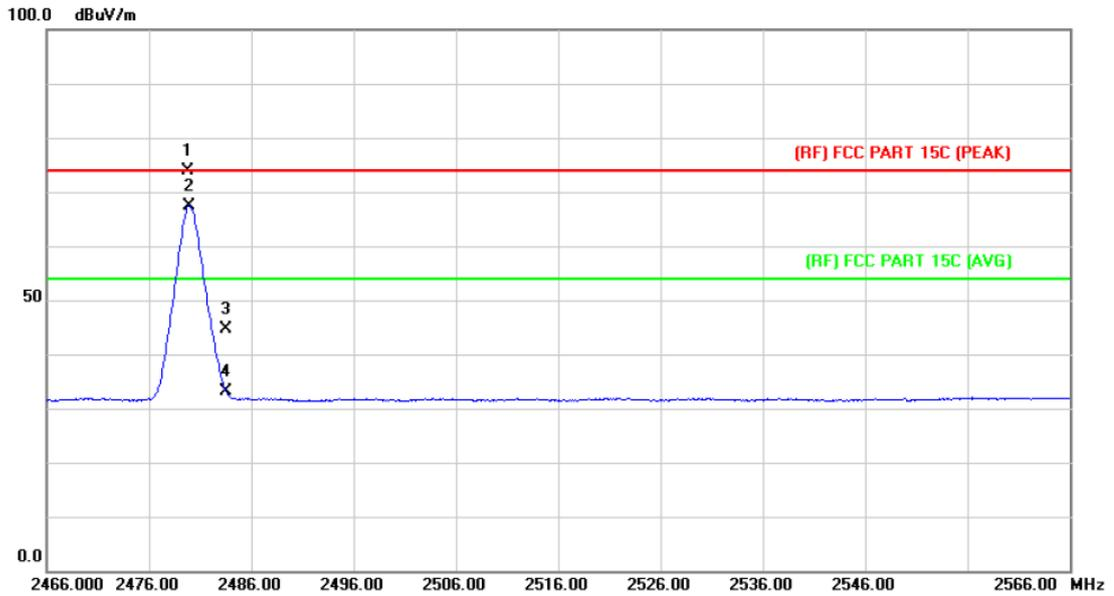

No.	Mk.	Freq. MHz	Reading Level dBuV	Correct Factor dB/m	Measure- ment dBuV/m	Limit dBuV/m	Over dB	Detector
1		2479.800	72.81	1.15	73.96	Fundamental Frequency		peak
2	*	2479.900	66.35	1.15	67.50	Fundamental Frequency		AVG
3		2483.500	43.38	1.17	44.55	74.00	-29.45	peak
4		2483.500	32.06	1.17	33.23	54.00	-20.77	AVG

Emission Level= Read Level+ Correct Factor

EUT:	Anti lost of Bluetooth	Model:	YU-01
Temperature:	25 °C	Relative Humidity:	55%
Test Voltage:	DC 3V		
Ant. Pol.	Vertical		
Test Mode:	BLE Mode TX 2480 MHz		
Remark:	N/A		

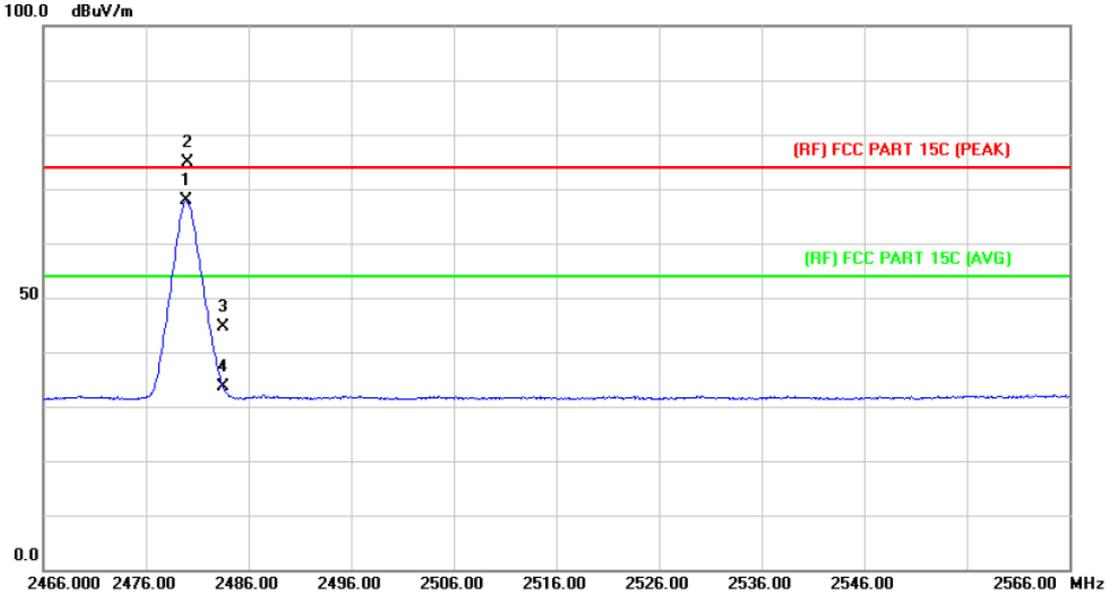

No.	Mk.	Freq. MHz	Reading Level dBuV	Correct Factor dB/m	Measure- ment dBuV/m	Limit dBuV/m	Over dB	Detector
1	*	2479.900	66.77	1.15	67.92	Fundamental Frequency		AVG
2	X	2480.000	73.84	1.15	74.99	Fundamental Frequency		peak
3		2483.500	43.39	1.17	44.56	74.00	-29.44	peak
4		2483.500	32.49	1.17	33.66	54.00	-20.34	AVG

Emission Level= Read Level+ Correct Factor

(2) Conducted Test

EUT:	Anti lost of Bluetooth	Model:	YU-01
Temperature:	25 °C	Relative Humidity:	55%
Test Voltage:	DC 3V		
Test Mode:	BLE Mode TX 2402MHz / BLE Mode TX 2480MHz		
Remark:	The EUT is programed in continuously transmitting mode		

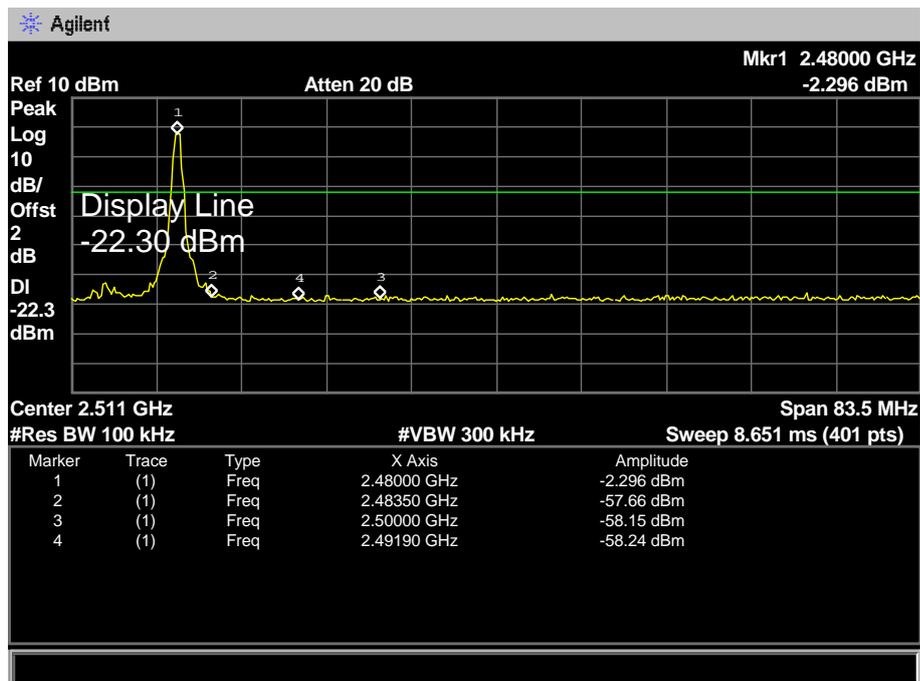
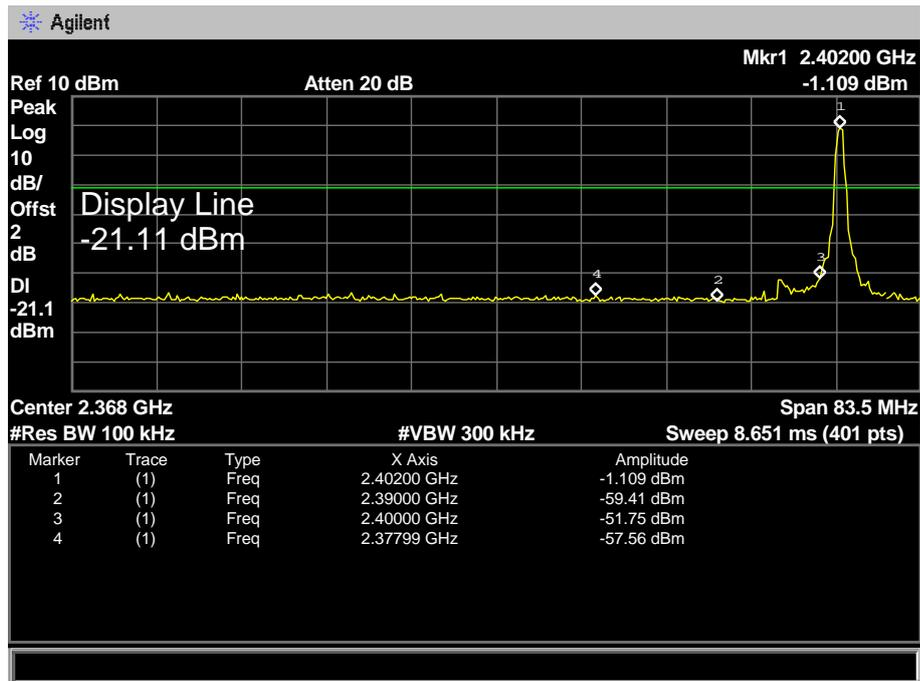

7. Bandwidth Test

7.1 Test Standard and Limit

7.1.1 Test Standard

FCC Part 15.247 (a)(2)

7.1.2 Test Limit

FCC Part 15 Subpart C(15.247)/RSS-247		
Test Item	Limit	Frequency Range(MHz)
Bandwidth	≥ 500 KHz (6dB bandwidth)	2400~2483.5

7.2 Test Setup

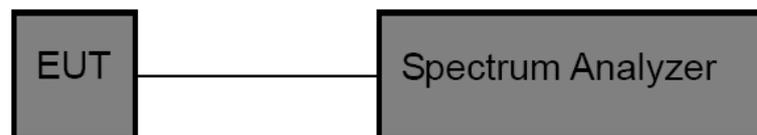

7.3 Test Procedure

- (1) The EUT was directly connected to the spectrum analyzer and antenna output port as show in the block diagram above.
- (2) The bandwidth is measured at an amplitude level reduced 6dB from the reference level. The reference level is the level of the highest amplitude signal observed from the transmitter at the fundamental frequency. Once the reference level is established, the equipment is conditioned with typical modulating signal to produce the worst -case (i.e the widest) bandwidth.
- (3) Measure the channel separation the spectrum analyzer was set to Resolution Bandwidth:100 kHz, and Video Bandwidth:300 kHz, Detector: Peak, Sweep Time set auto.

7.4 EUT Operating Condition

The EUT was set to continuously transmitting in each mode and low, middle and high channel for the test.

7.5 Test Data

EUT:	Anti lost of Bluetooth	Model:	YU-01
Temperature:	25 °C	Relative Humidity:	55%
Test Voltage:	DC 3V		
Test Mode:	BLE TX Mode		
Channel frequency (MHz)	6dB Bandwidth (kHz)	99% Bandwidth (kHz)	Limit (kHz)
2402	507.906	928.2096	>=500
2442	514.252	929.8551	
2480	513.645	932.2189	

BLE Mode

2402 MHz

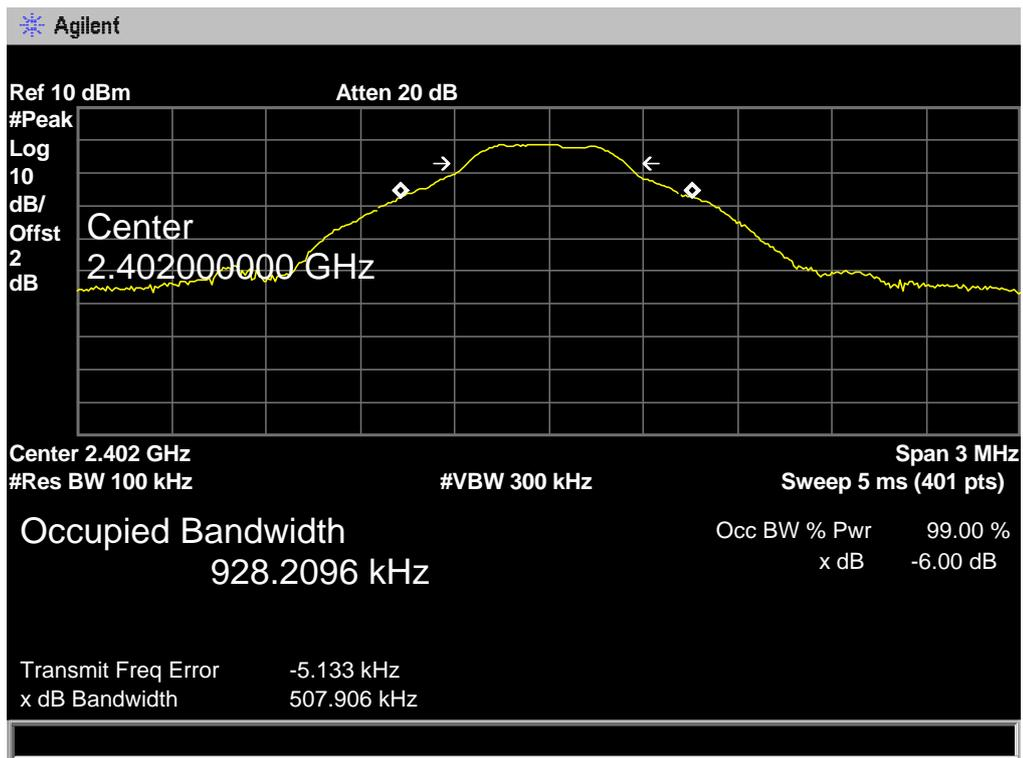

BLE Mode

2442 MHz

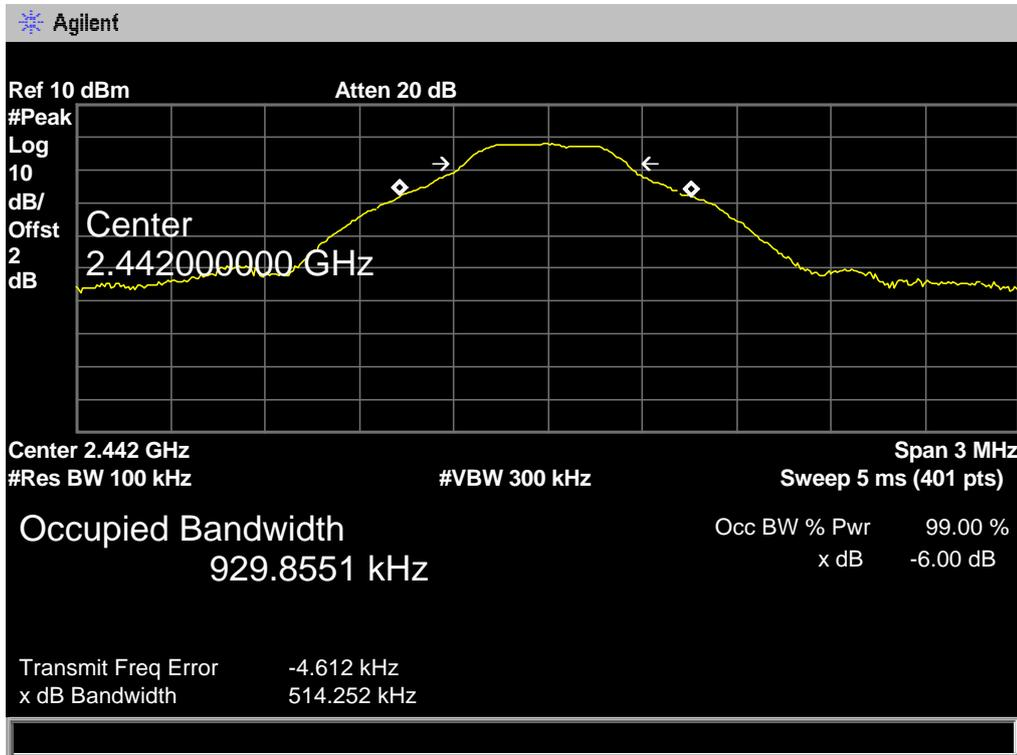

BLE Mode

2480 MHz

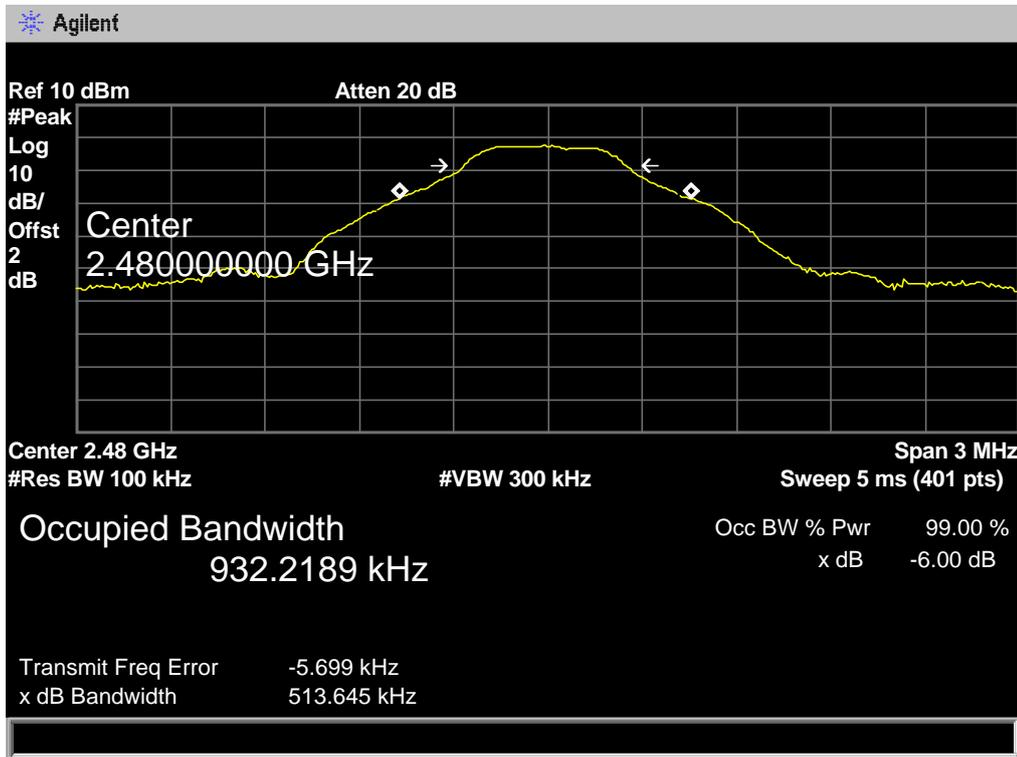

8. Peak Output Power Test

8.1 Test Standard and Limit

8.1.1 Test Standard

FCC Part 15.247 (b)

8.1.2 Test Limit

FCC Part 15 Subpart C(15.247)/RSS-247		
Test Item	Limit	Frequency Range(MHz)
Peak Output Power	1 Watt or 30 dBm	2400~2483.5

8.2 Test Setup

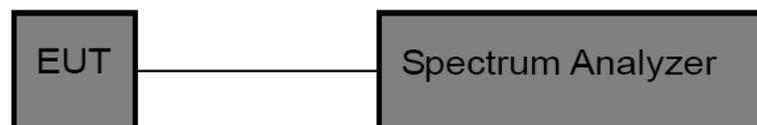

8.3 Test Procedure

The EUT was directly connected to the Spectrum Analyzer and antenna output port as show in the block diagram above. The measurement is according to section 9.1.1 of KDB 558074 D01 DTS Meas Guidance v03r05.

- (1) Set the $RBW \geq DTS$ Bandwidth
- (2) Set $VBW \geq 3 * RBW$
- (3) Set $Span \geq 3 * RBW$
- (4) Sweep time=auto
- (5) Detector= peak
- (6) Trace mode= maxhold.
- (7) Allow trace to fully stabilize, and then use peak marker function to determine the peak amplitude level.

8.4 EUT Operating Condition

The EUT was set to continuously transmitting in the max power during the test.

8.5 Test Data

EUT:	Anti lost of Bluetooth	Model:	YU-01
Temperature:	25 °C	Relative Humidity:	55%
Test Voltage:	DC 3V		
Test Mode:	BLE TX Mode		
Channel frequency (MHz)	Test Result (dBm)	Limit (dBm)	
2402	-0.816	30	
2442	-1.384		
2480	-2.011		
BLE Mode			
2402 MHz			

The screenshot shows an Agilent spectrum analyzer interface. The main display area shows a yellow trace representing the signal spectrum. A marker is placed on the trace at 2.402030000 GHz, indicating a power level of -0.816 dBm. The plot is set to a center frequency of 2.402 GHz, a resolution bandwidth (Res BW) of 1 MHz, and a span of 3 MHz. The sweep time is 5 ms with 401 points. The attenuation is set to 20 dB. The reference level is 10 dBm. The plot also shows the peak log offset and the marker details.

BLE Mode

2442 MHz

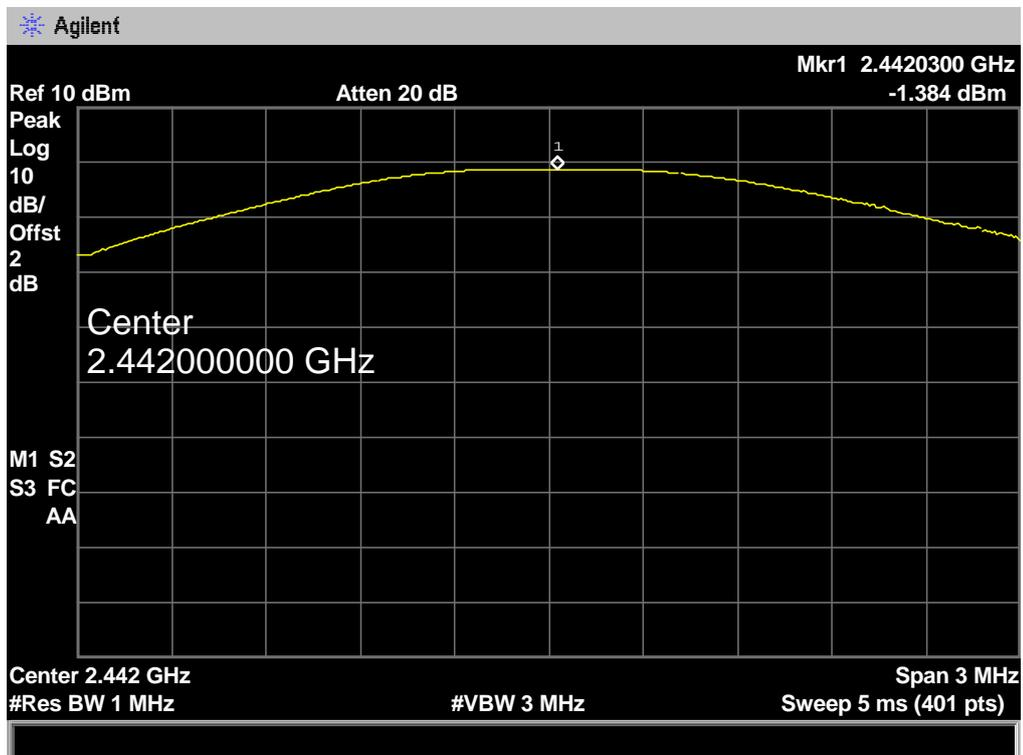

BLE Mode

2480 MHz

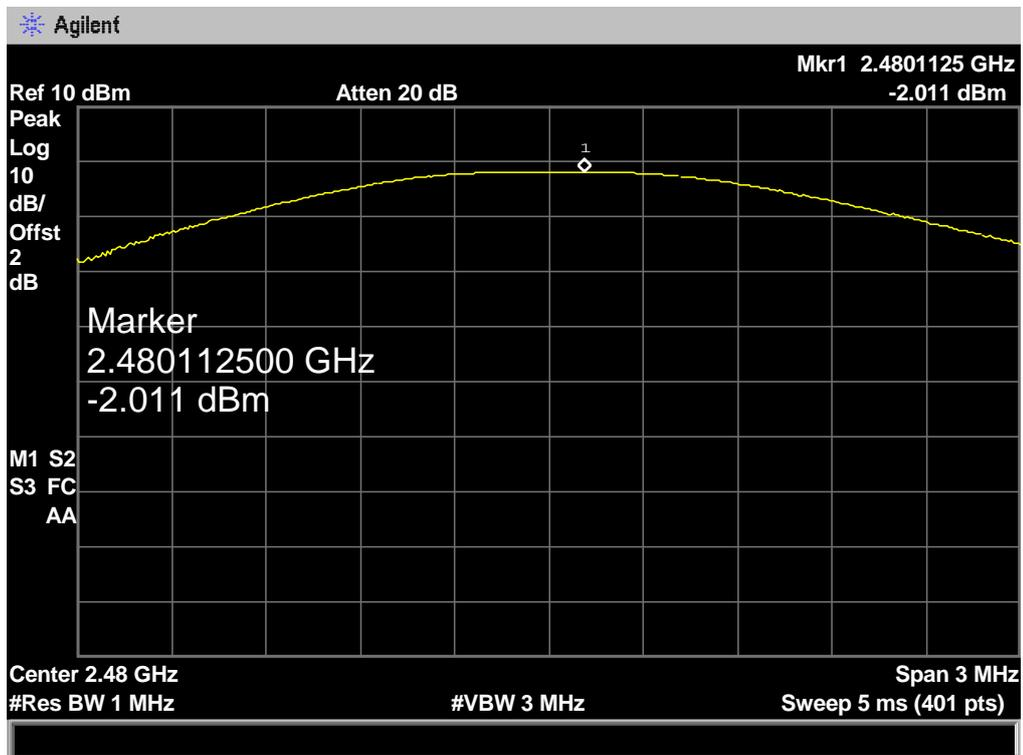

9. Power Spectral Density Test

9.1 Test Standard and Limit

9.1.1 Test Standard

FCC Part 15.247 (e)

9.1.2 Test Limit

FCC Part 15 Subpart C(15.247)		
Test Item	Limit	Frequency Range(MHz)
Power Spectral Density	8dBm(in any 3 kHz)	2400~2483.5

9.2 Test Setup

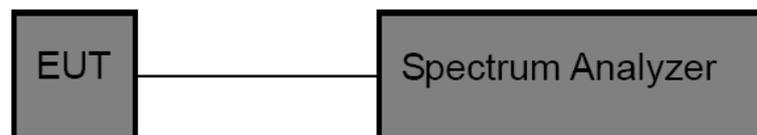

9.3 Test Procedure

The EUT was directly connected to the Spectrum Analyzer and antenna output port as show in the block diagram above. The measurement according to section 10.2 of KDB 558074 D01 DTS Meas Guidance v03r05.

- (1) The EUT was directly connected to the spectrum analyzer and antenna output port as show in the block diagram above.
- (2) Set analyser center frequency to DTS channel center frequencyc.
- (3) Set the span to 1.5 times the DTS bandwidth.
- (4) Set the RBW to: 3 kHz
- (5) Set the VBW to: 10 kHz
- (6) Detector: peak
- (7) Sweep time: auto
- (8) Allow trace to fully stabilize. Then use the peak marker function to determine the maximum amplitude level.

9.4 EUT Operating Condition

The EUT was set to continuously transmitting in each mode and low, Midle and high channel for the test.

9.5 Test Data

EUT:	Anti lost of Bluetooth	Model:	YU-01
Temperature:	25 °C	Relative Humidity:	55%
Test Voltage:	DC 3V		
Test Mode:	BLE TX Mode		
Channel Frequency (MHz)	Power Density (3 kHz/dBm)	Limit (dBm)	
2402	-10.93	8	
2442	-11.68		
2480	-12.39		
BLE Mode			
2402 MHz			
<p>The screenshot shows a spectrum analyzer display with a yellow signal trace. A marker is placed at 2.401979750 GHz, indicating a power density of -10.93 dBm. The display includes a grid, a reference level of 10 dBm, and an attenuation of 20 dB. The center frequency is 2.402 GHz, the resolution bandwidth is 3 kHz, and the span is 900 kHz. The sweep time is 102.9 ms with 401 points.</p>			

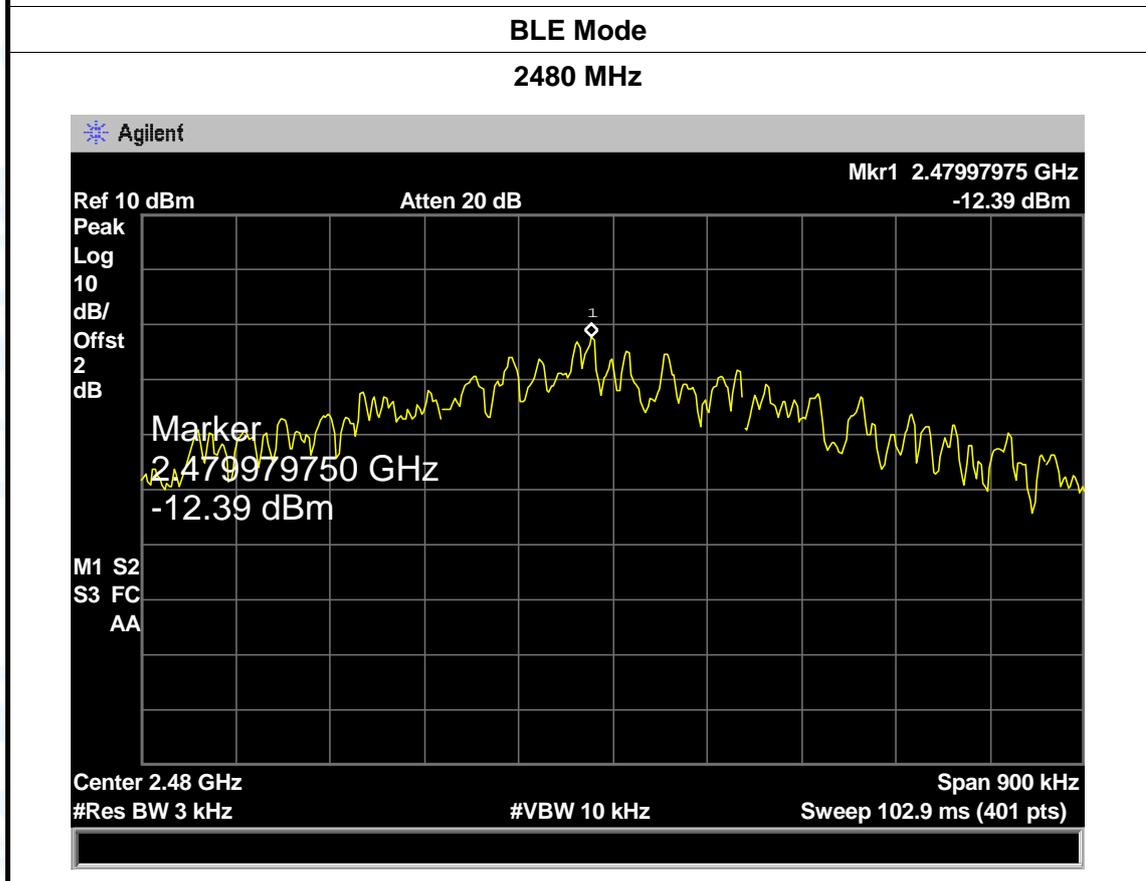
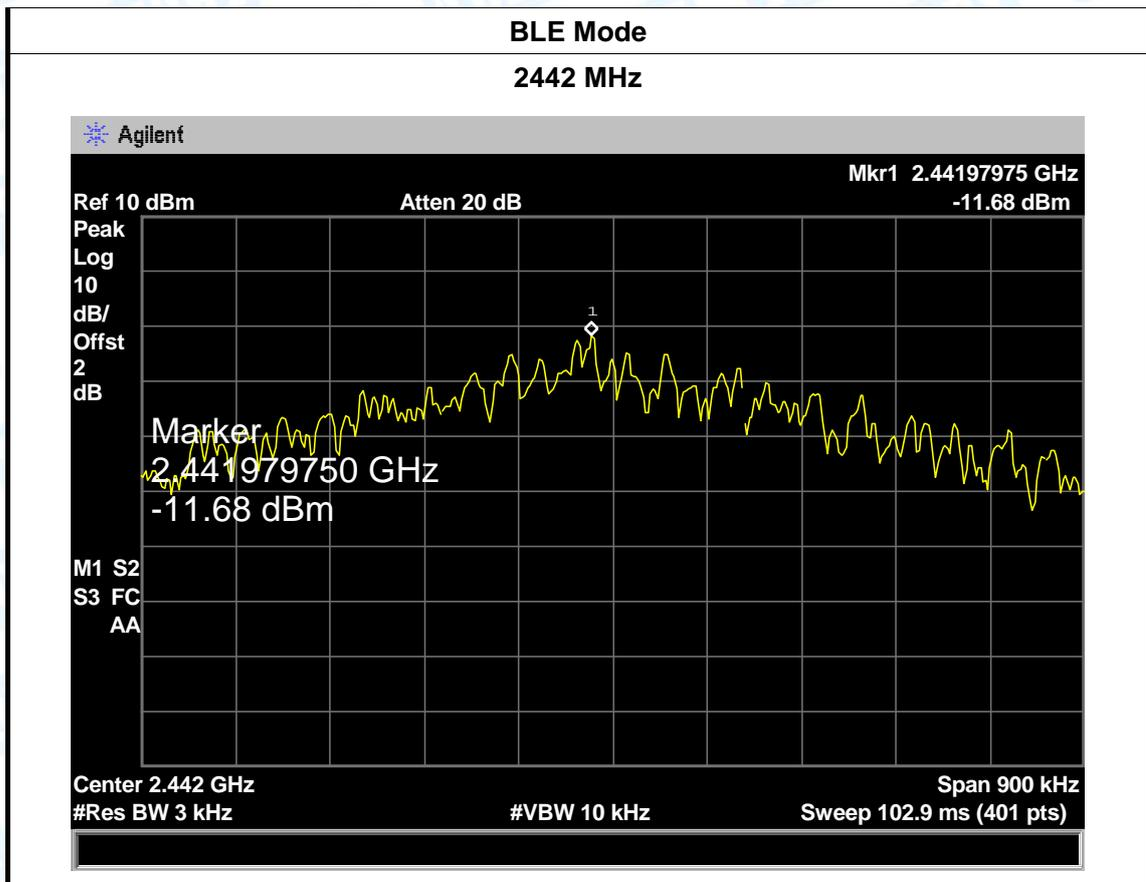

10. Antenna Requirement

10.1 Standard Requirement

10.1.1 Standard

FCC Part 15.203

10.1.2 Requirement

An intentional radiator shall be designed to ensure that no antenna other than that furnished by the responsible party shall be used with the device. The use of a permanently attached antenna or of an antenna that uses a unique coupling to the intentional radiator shall be considered sufficient to comply with the provisions of this Section. The manufacturer may design the unit so that a broken antenna can be replaced by the user, but the use of a standard antenna jack or electrical connector is prohibited.

10.2 Antenna Connected Construction

The directional gains of the antenna used for transmitting is -1 dBi, and the antenna de-signed with permanent attachment and no consideration of replacement. Please see the EUT photo for details.

10.3 Result

The EUT antenna is a PCB Antenna. It complies with the standard requirement.

Antenna Type
<input checked="" type="checkbox"/> Permanent attached antenna
<input type="checkbox"/> Unique connector antenna
<input type="checkbox"/> Professional installation antenna