





Test Report No.: AN2211WDG0179

ANTENNA TEST REPORT

Applicant	Shanghai Zhiwei robot Co., Ltd
Address	Room 603, puruan building, No.2 Boyun Road, Pudong New Area

Manufacturer or Supplier	Shanghai Zhiwei robot Co., Ltd
Address	Room 603, puruan building, No.2 Boyun Road, Pudong New Area
Product	Antenna
Brand Name	N/A
Model	DFR0706
Max. Peak Gain	-2.16 dBi
Date of tests	Nov. 22, 2022 & Apr. 11, 2023

Tested by Andy Zhu Supervisor / EMC Department	Approved by Glyn He Assistant Manager / EMC Department
	 Date: Apr. 11, 2023

This report is governed by, and incorporates by reference, the Conditions of Testing as posted at the date of issuance of this report at <http://www.bureauveritas.com/home/about-us/our-business/cps/about-us/terms-conditions/> and is intended for your exclusive use. Any copying or replication of this report to or for any other person or entity, or use of our name or trademark, is permitted only with our prior written permission. This report sets forth our findings solely with respect to the test samples identified herein. The results set forth in this report are not indicative or representative of the quality or characteristics of the lot from which a test sample was taken or any similar or identical product unless specifically and expressly noted. Our report includes all of the tests requested by you and the results thereof based upon the information that you provided to us. Measurement uncertainty is only provided upon request for accredited tests. Statements of conformity are based on simple acceptance criteria without taking measurement uncertainty into account, unless otherwise requested in writing. You have 60 days from date of issuance of this report to notify us of any material error or omission caused by our negligence or if you require measurement uncertainty; provided, however, that such notice shall be in writing and shall specifically address the issue you wish to raise. A failure to raise such issue within the prescribed time shall constitute your unqualified acceptance of the completeness of this report, the tests conducted and the correctness of the report contents.

Bureau Veritas Shenzhen Co., Ltd.
Dongguan Branch

No. 96, Guantai Road (Houjie Section), Houjie
Town, Dongguan City, Guangdong Province.
523942. People's Republic of China.

Tel.: +86 769 8998 2098
Fax: +86 769 8593 1080
Email: customerservice.dg@bureauveritas.com



TABLE OF CONTENTS

1. MEASUREMENTS SETUP	3
2. SIZE OF THE ANTENNA.....	3
3. TEST INSTRUMENTS	4
4. TEST RESULTS.....	5
5. PHOTOGRAPHS OF THE TEST CONFIGURATION.....	19

1. MEASUREMENTS SETUP

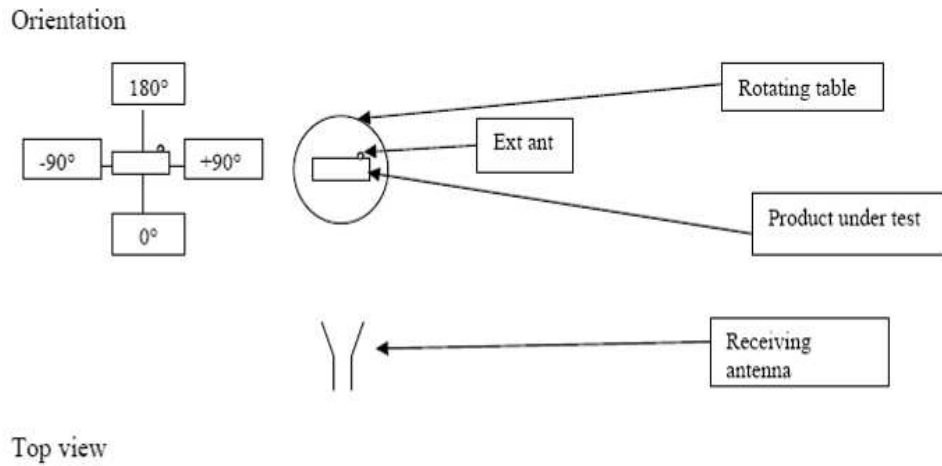

2. SIZE OF THE ANTENNA

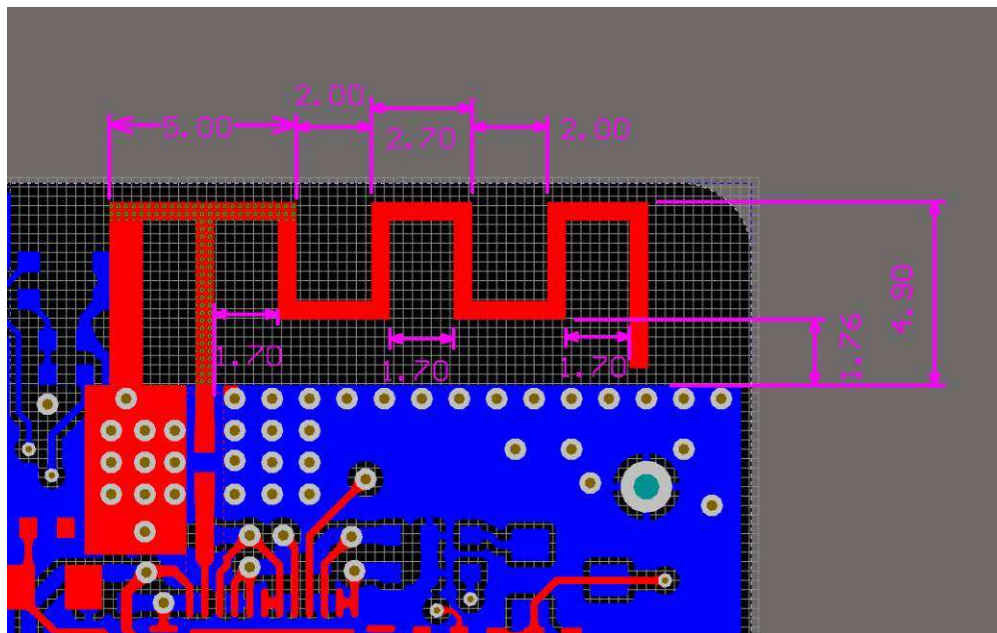

3. TEST INSTRUMENTS

Equipment	Manufacturer	Model No.	Serial No.	Next Cal.
Signal Generator	Agilent	N5183A	MY50140980	Jul. 20, 23
Spectrum Analyzer	Rohde&Schwarz	FSV40	101003	Jan. 11, 24
Broad-Band Horn Antenna	SCHWARZBECK	BBHA 9120 D	9120D-1247	Apr. 23, 23
Broad-Band Horn Antenna	SCHWARZBECK	BBHA 9120 B	00740	Jul. 20, 23
Turn Table	MF	MF-7802	MF780208191	N/A
Controller	MF	MF-7802	MF780208243	N/A
Test Software	BV ADT	BV ADT Antenna Pattern	V6.2	N/A

- NOTE:** 1. The test was performed in Fully Anechoic Room.
 2. The calibration interval of the above test instruments is 12 months and the calibrations are traceable to CEPREI/CHINA, GRGT/CHINA and NIM/CHINA.

4. TEST RESULTS

ANTENNA	FREQUENCY (MHz)	ANTENNA POLARITY	MAX. PEAK GAIN (dBi)
PCB	2402	Horizontal	-3.48
		Vertical	-7.45
	2440	Horizontal	-3.23
		Vertical	-7.70
	2480	Horizontal	-2.16
		Vertical	-8.47

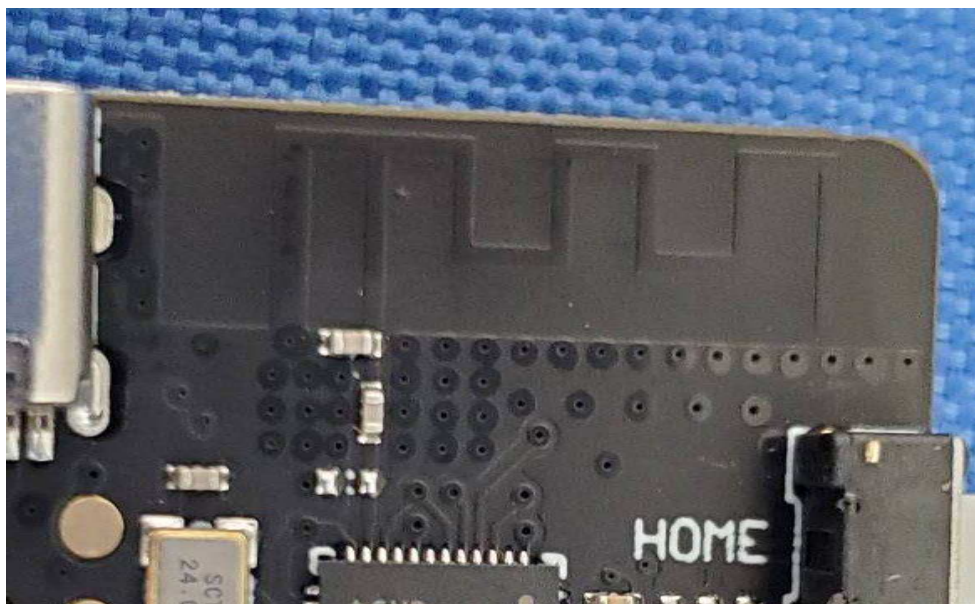

Frequency: 2402 MHz (Horizontal)

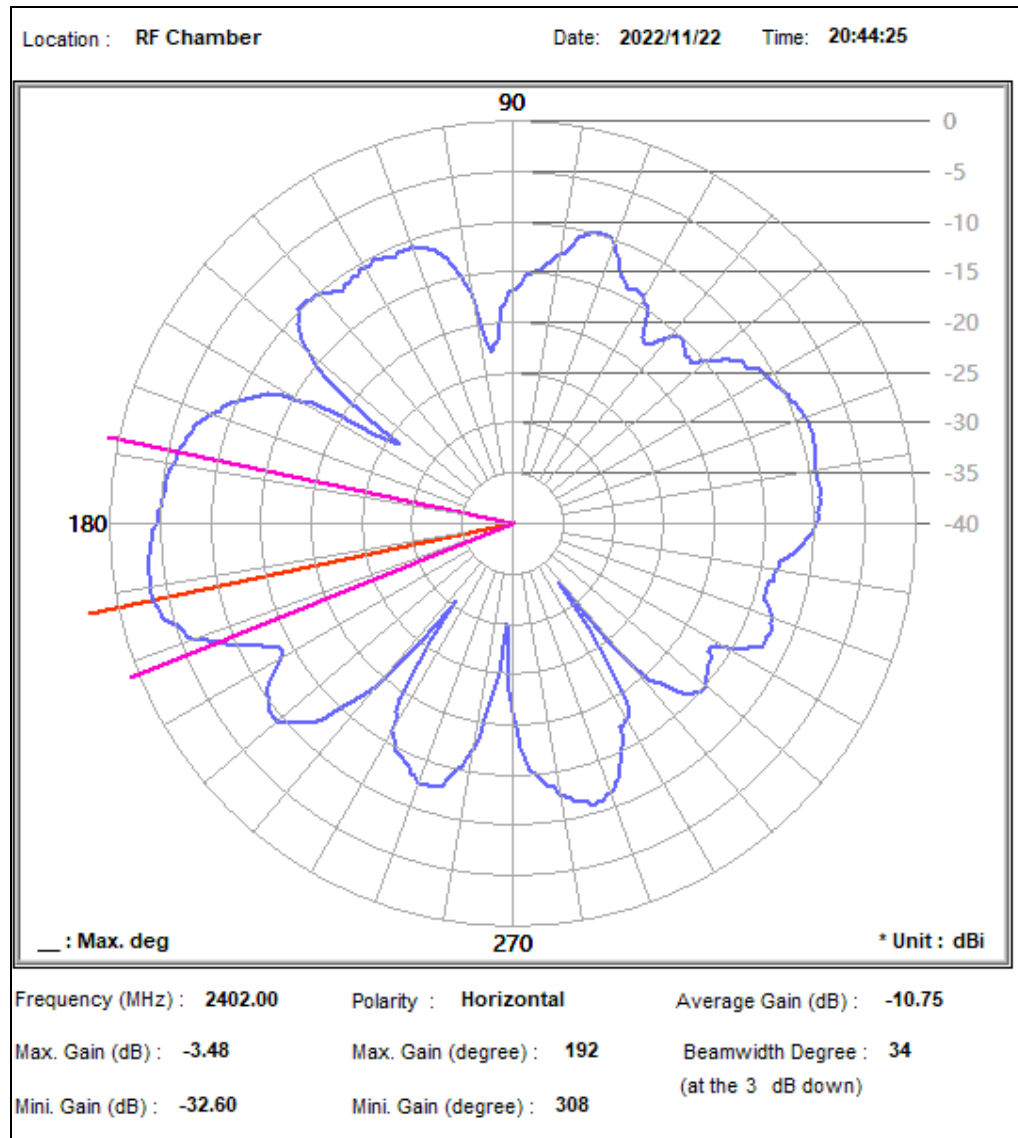

Frequency: 2402 MHz (Vertical)

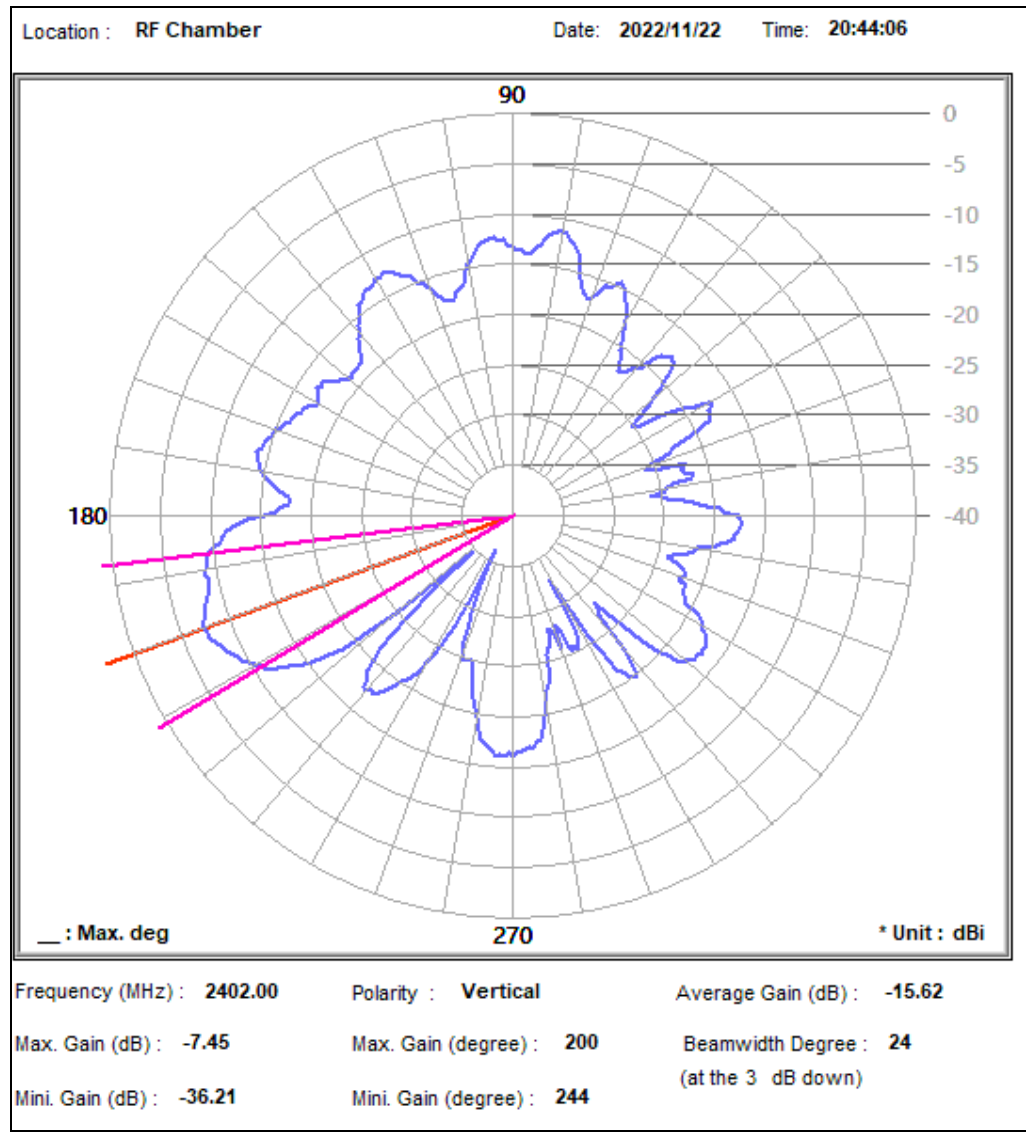

Frequency: 2440 MHz (Horizontal)

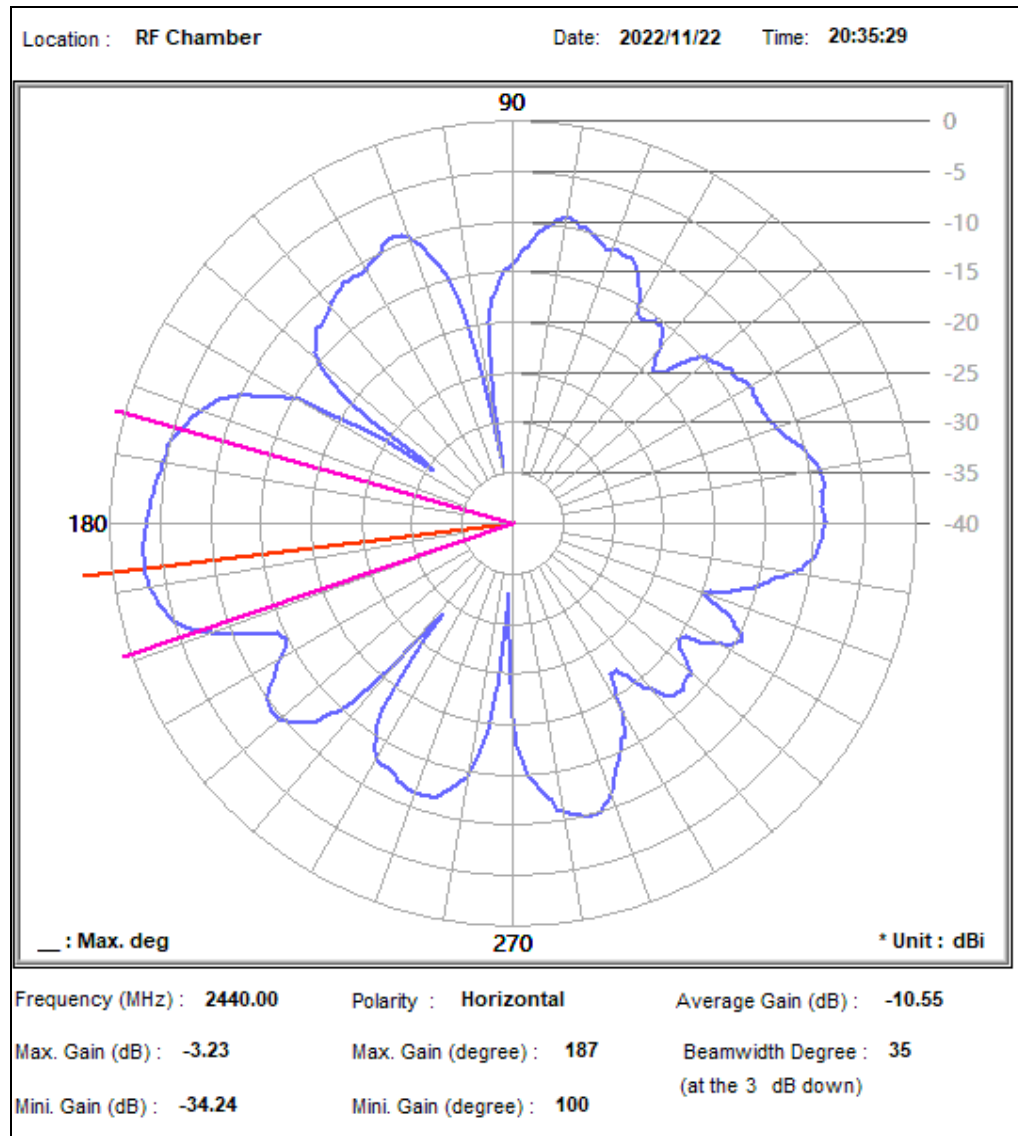

Frequency: 2440 MHz (Vertical)

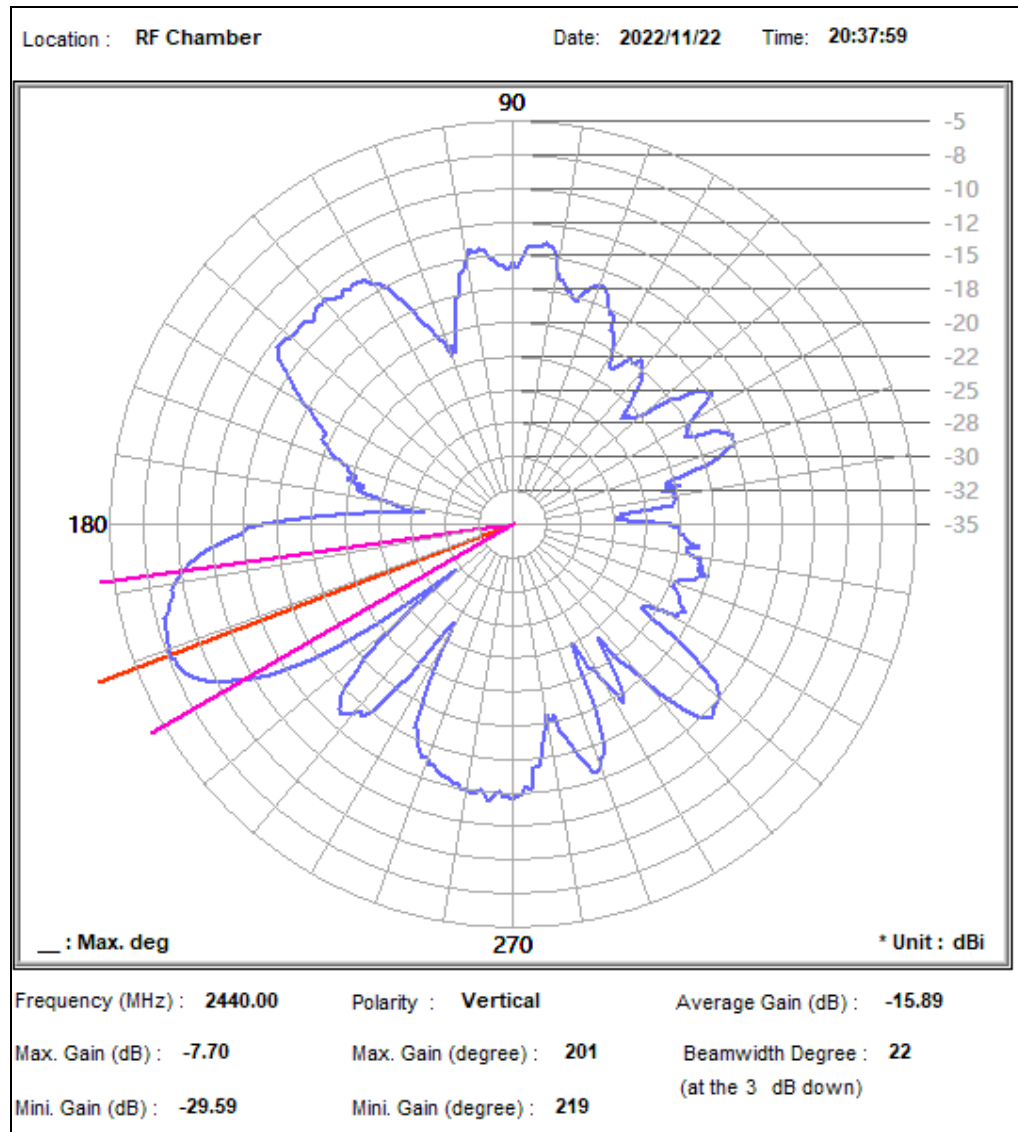



Test Report No.: AN2211WDG0179

Frequency: 2480 MHz (Horizontal)

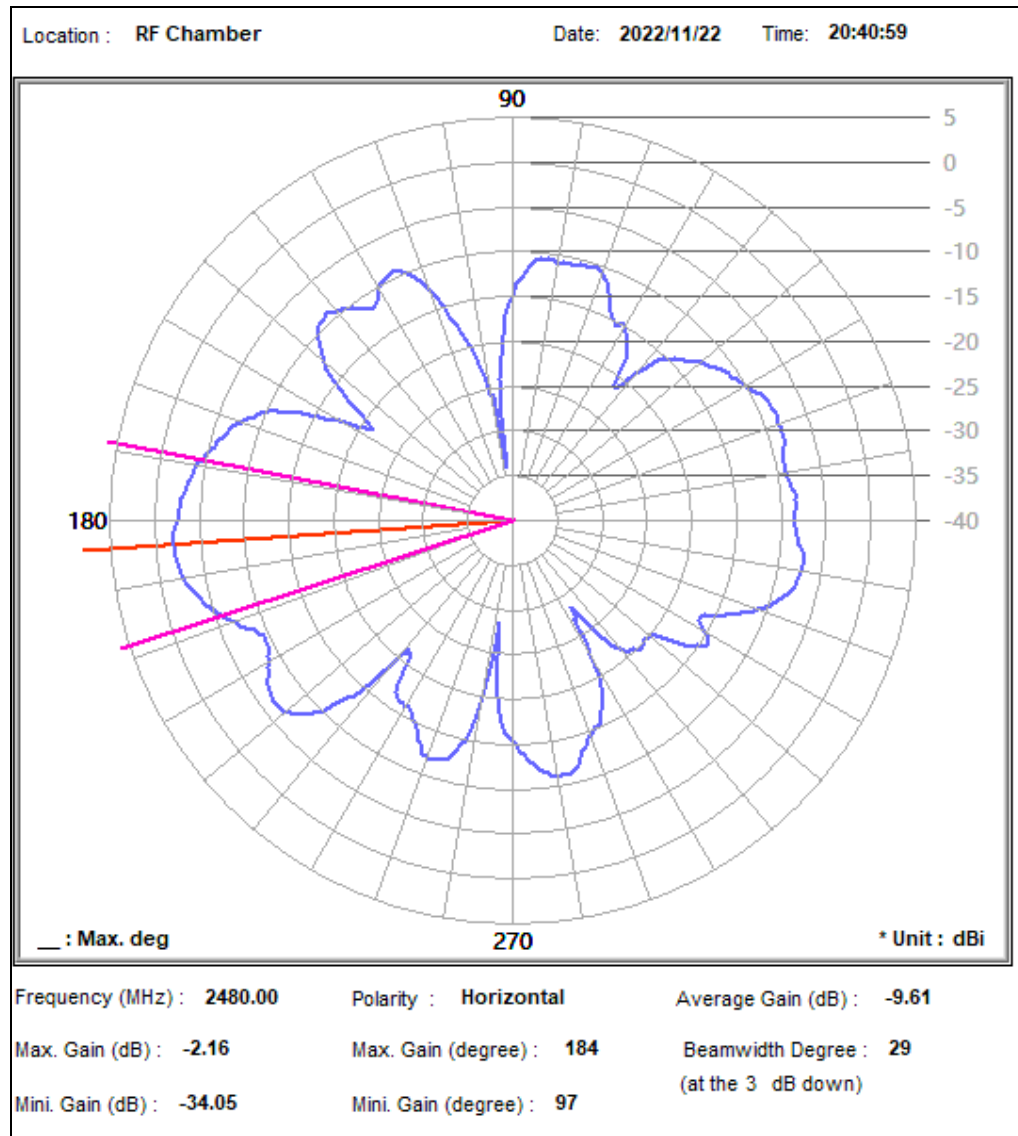

Bureau Veritas Shenzhen Co., Ltd.
Dongguan Branch

No. 96, Guantai Road (Houjie Section), Houjie
Town, Dongguan City, Guangdong Province.
523942. People's Republic of China.

Tel.: +86 769 8998 2098
Fax: +86 769 8593 1080
Email: customerservice.dg@bureauveritas.com

Frequency: 2480 MHz (Vertical)

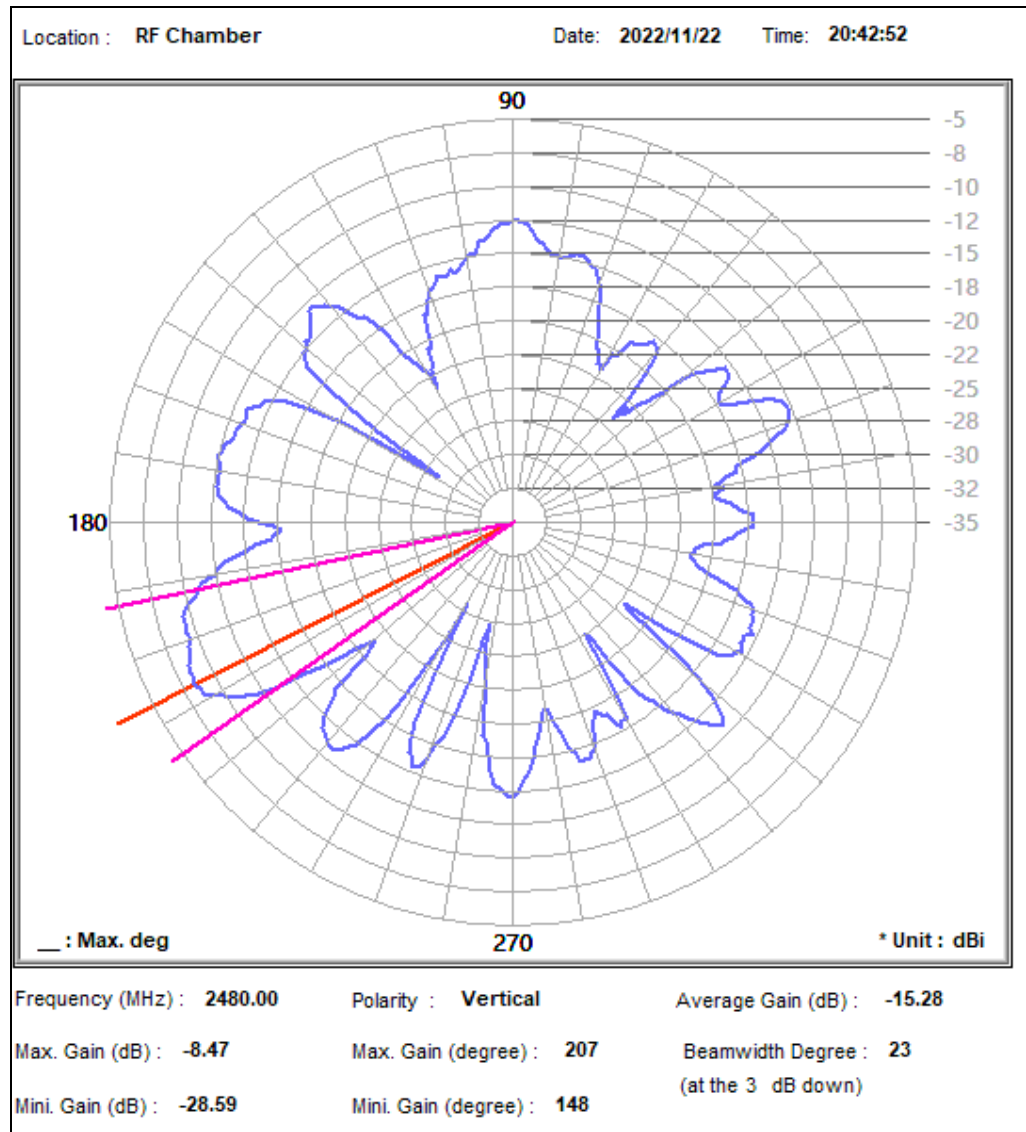



Test Report No.: AN2211WDG0179

ANTENNA	FREQUENCY (MHz)	ANTENNA POLARITY	MAX. PEAK GAIN (dBi)
PCB	2412	Horizontal	-3.03
		Vertical	-6.80
	2437	Horizontal	-2.51
		Vertical	-6.76
	2462	Horizontal	-2.34
		Vertical	-7.17

Frequency: 2412 MHz (Horizontal)

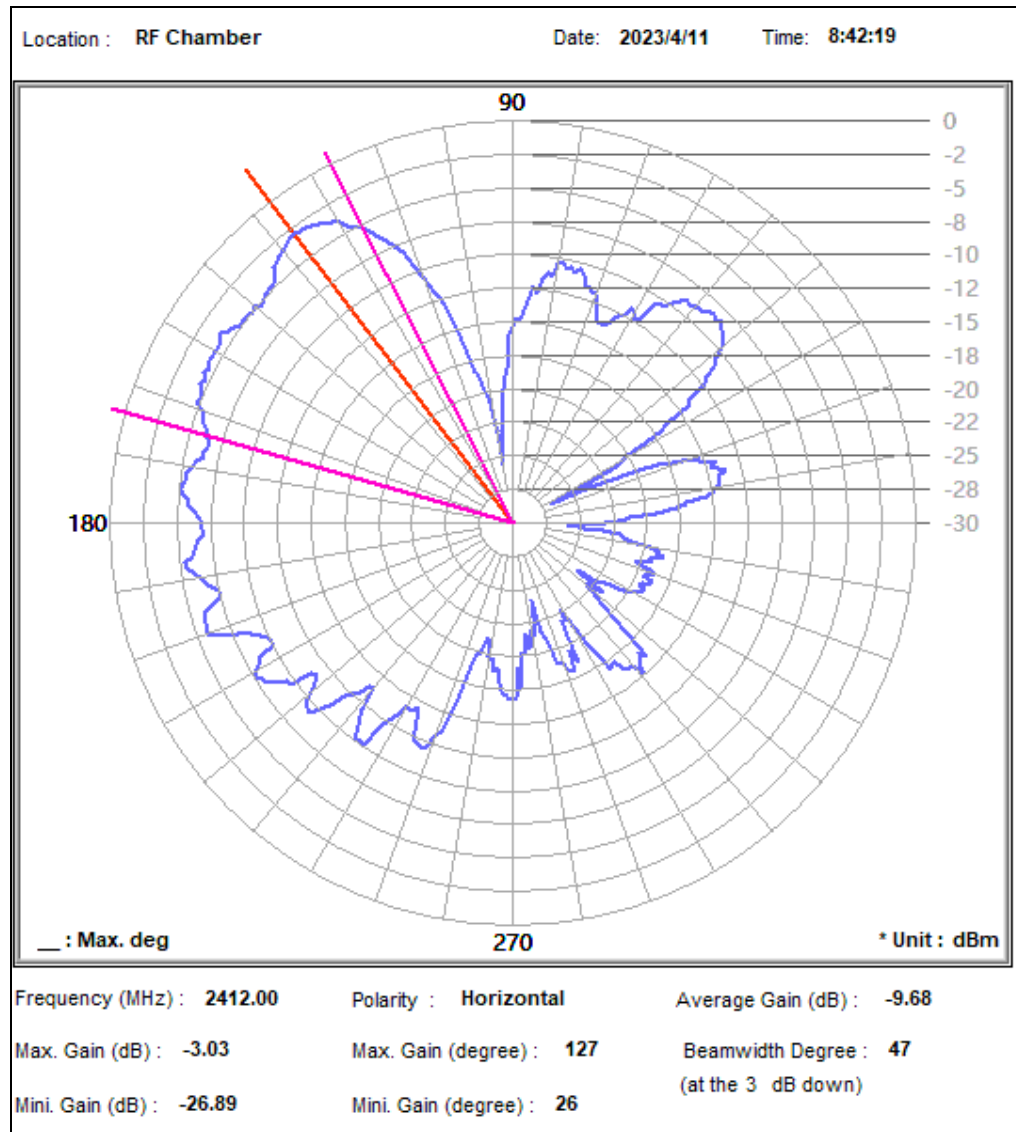



Frequency: 2412 MHz (Vertical)

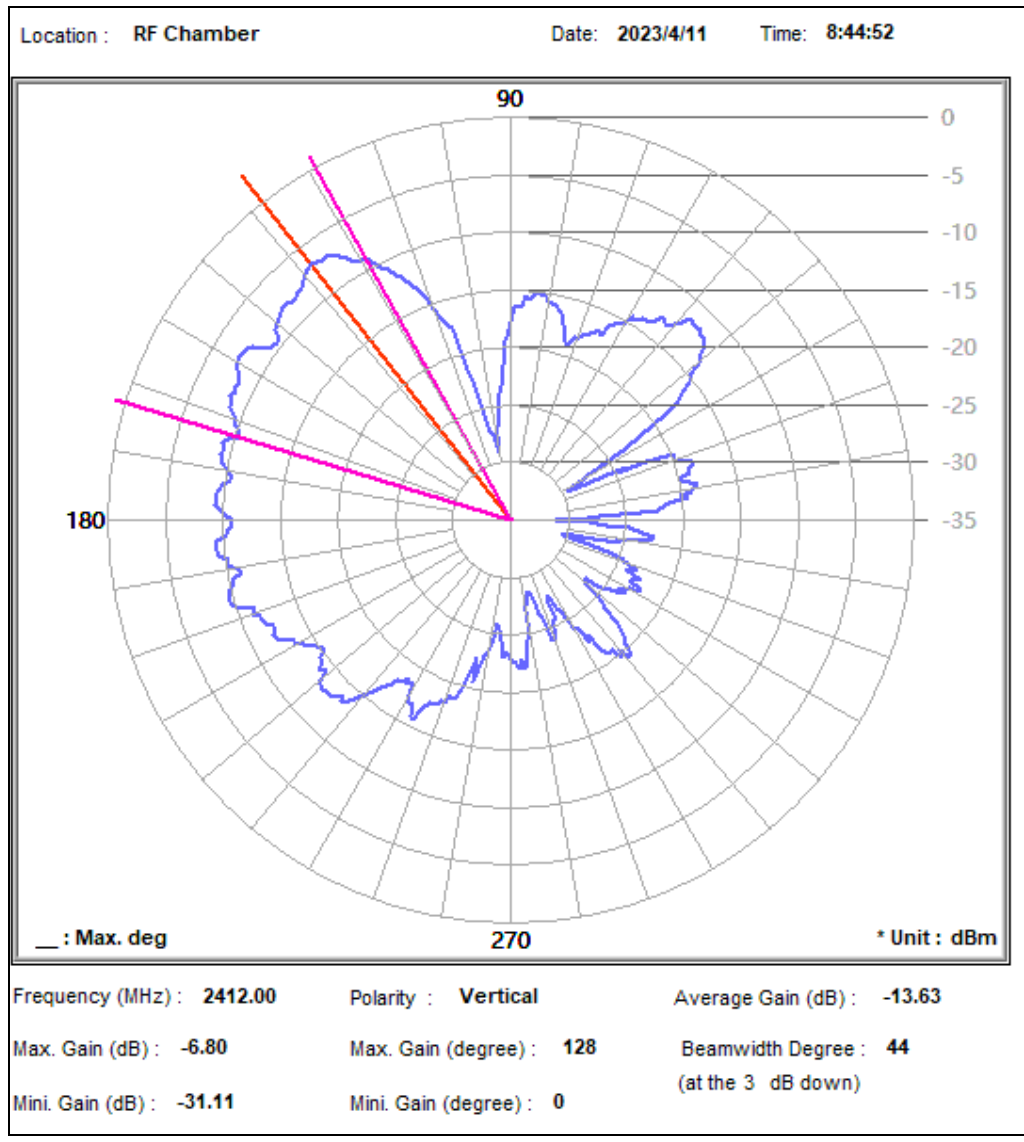

Frequency: 2437 MHz (Horizontal)

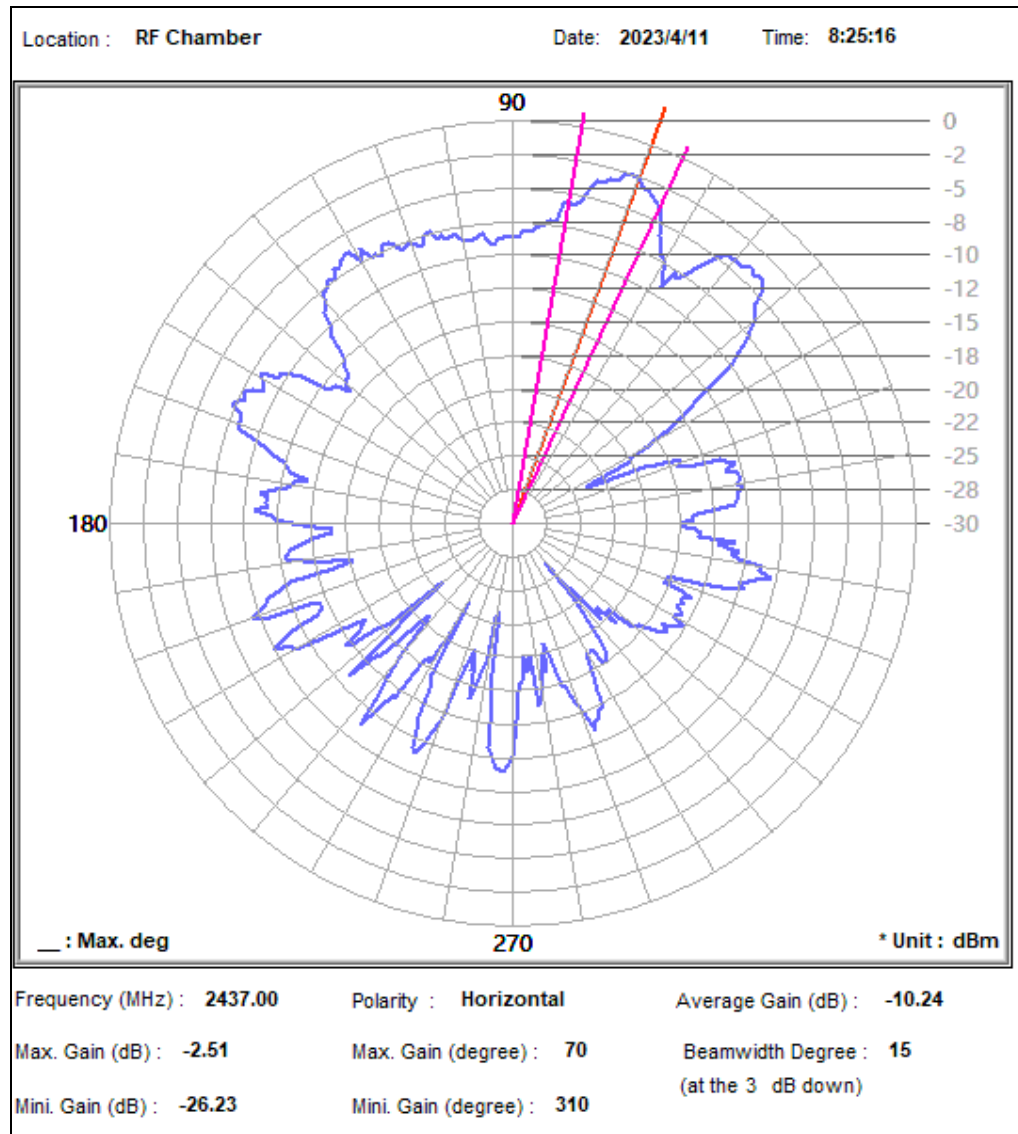



Test Report No.: AN2211WDG0179

Frequency: 2437 MHz (Vertical)

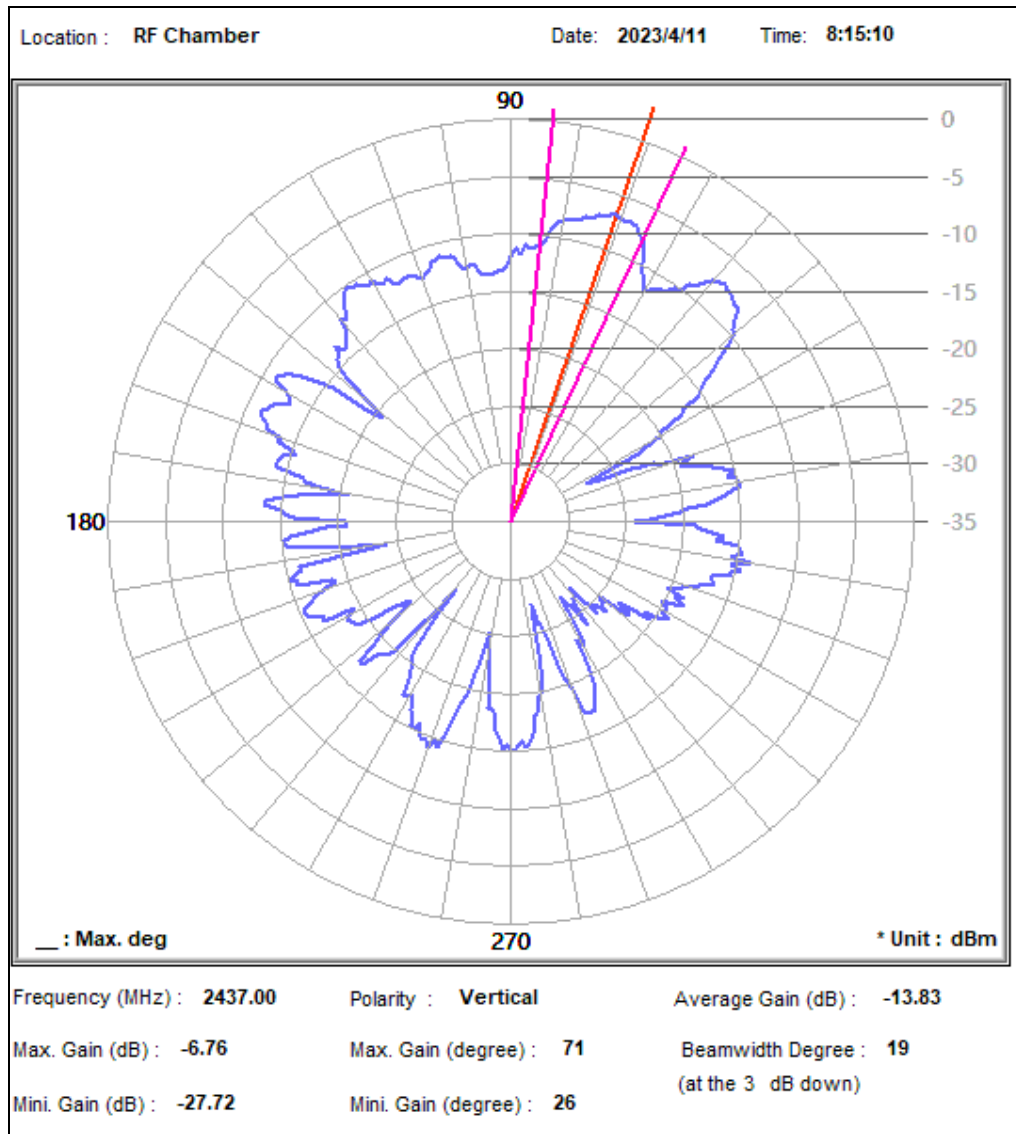

Bureau Veritas Shenzhen Co., Ltd.
Dongguan Branch

No. 96, Guantai Road (Houjie Section), Houjie
Town, Dongguan City, Guangdong Province.
523942. People's Republic of China.

Tel.: +86 769 8998 2098
Fax: +86 769 8593 1080
Email: customerservice.dg@bureauveritas.com

Frequency: 2462 MHz (Horizontal)

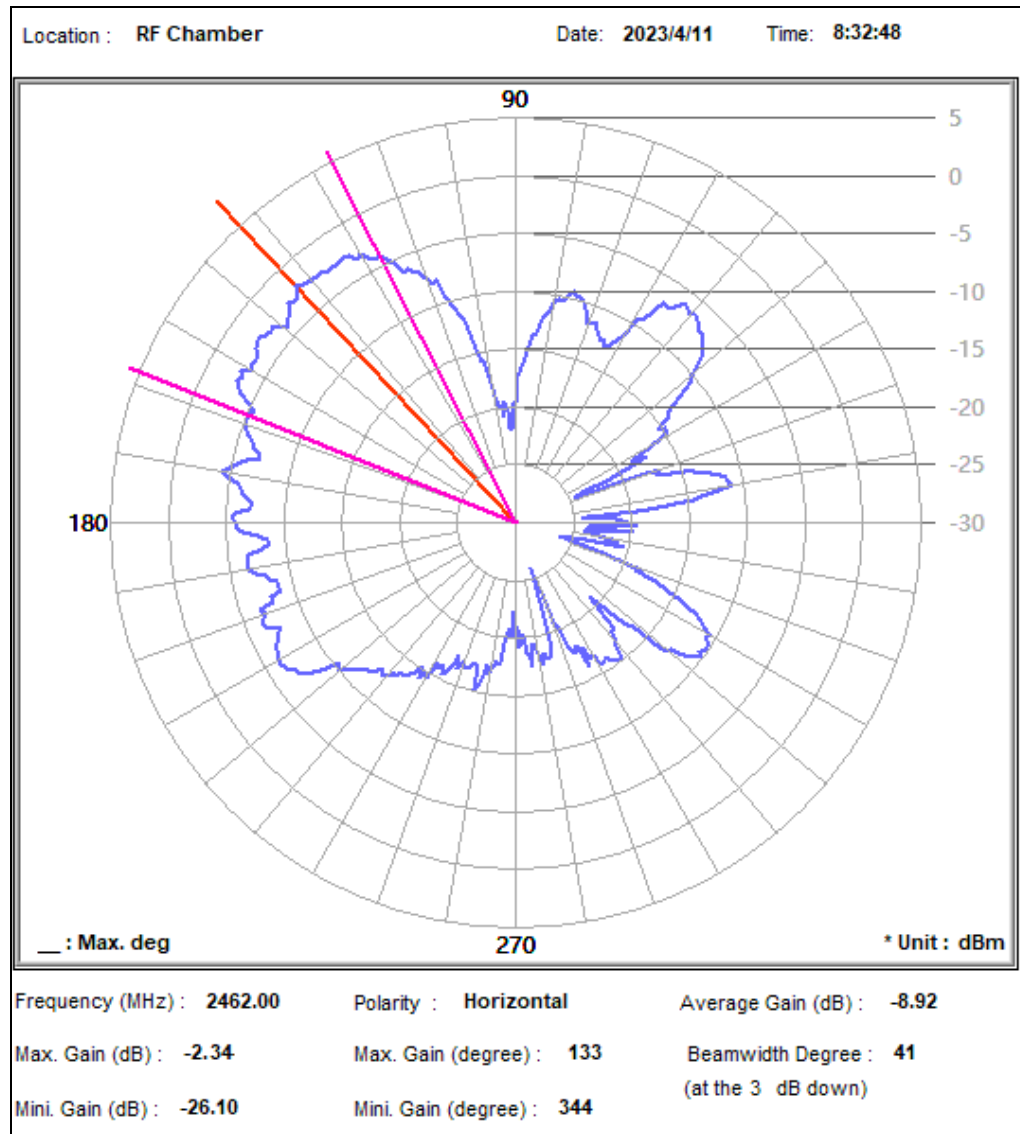

Frequency: 2462 MHz (Vertical)

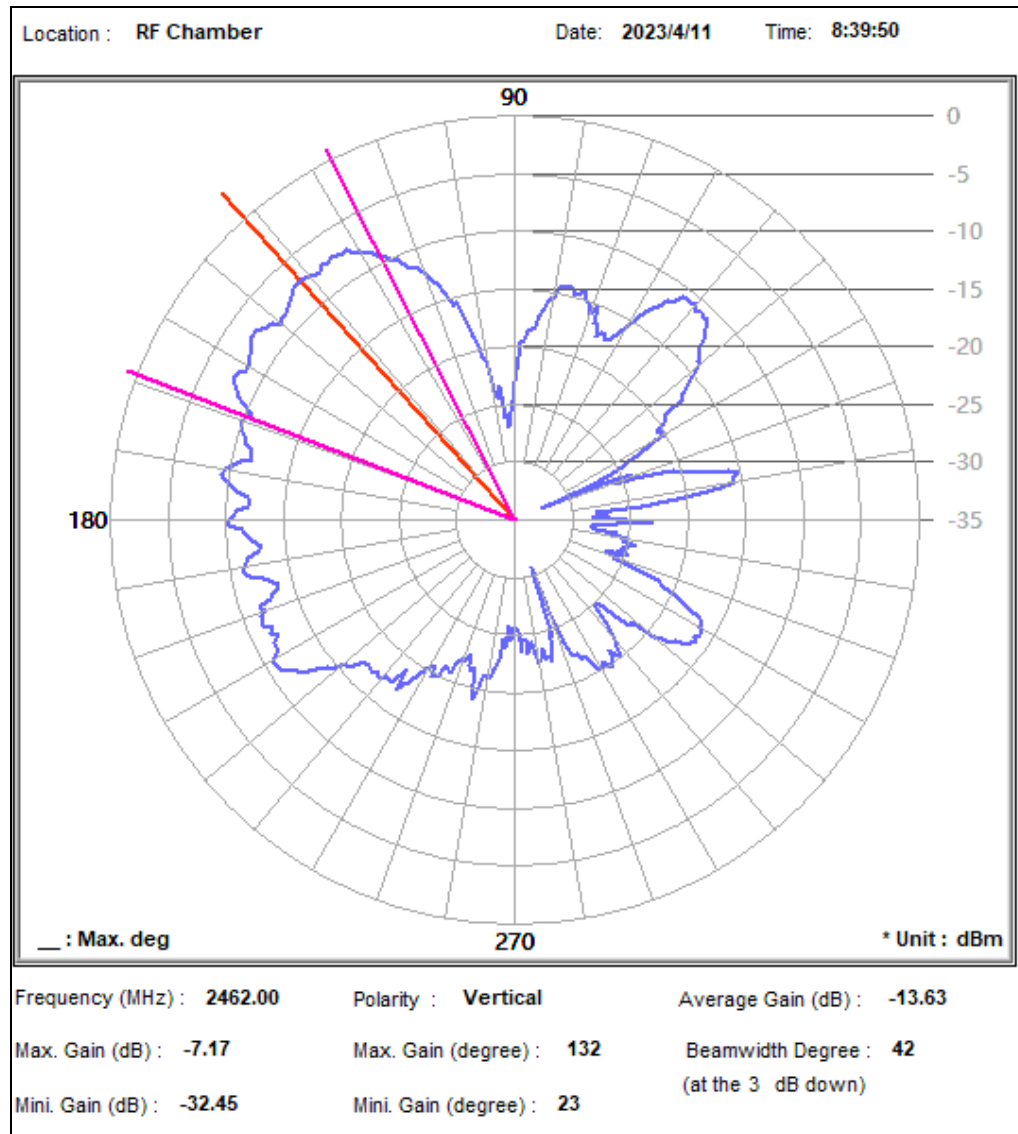

5. PHOTOGRAPHS OF THE TEST CONFIGURATION

