

FCC PART 24TEST REPORT**Part 24 Subpart E**

Report Reference No..... : UNIA2018120611-4FR-01

FCC ID..... : 2A12O-OT303BL

Compiled by

(position+printed name+signature) .: File administrators Kahn yang



Supervised by

(position+printed name+signature) .: Technique principal Sherwin Qian

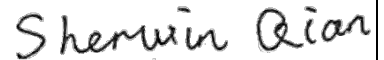

Approved by

(position+printed name+signature) .: Manager Liuze



Date of issue : Dec. 20, 2018

Testing Laboratory Name : Shenzhen United Testing Technology Co., Ltd.Address..... : 2F, Annex Bldg, Jiahuangyuan Tech Park, #365 Baotian 1 Rd,
Tiegang Community, Xixiang Str, Bao'an District, Shenzhen, China**Applicant's name : Shenzhen Omni Intelligent Technology Co., Ltd.**Address..... : 5th. Floor Block 4, Lianchuang Technical Zone, 21th. Bulan Road,
Longgang, Shenzhen, China**Test specification :**Standard : **FCC CFR Title 47 Part 2, Part 24E**
EIA/TIA 603-D: 2010
KDB 971168 D01

TRF Originator..... : Shenzhen United Testing Technology Co., Ltd.

Shenzhen United Testing Technology Co., Ltd. All rights reserved.

This publication may be reproduced in whole or in part for non-commercial purposes as long as the Shenzhen United Testing Technology Co., Ltd. is acknowledged as copyright owner and source of the material. Shenzhen United Testing Technology Co., Ltd. takes no responsibility for and will not assume liability for damages resulting from the reader's interpretation of the reproduced material due to its placement and context.

Test item description : Sharing scooter IOT controller

Trade Mark : Omni

Manufacturer : Shenzhen Omni Intelligent Technology Co., Ltd.

Model/Type reference..... : OT303BL

Listed Models : N/A

Modulation Type : QPSK, 16QAM

Rating : DC 36V From DC Power

Hardware version : V2.0

Software version..... : V2.0

Result : **PASS**

Revision History

Revision	Issue Date	Revisions	Revised By
V1.0	2018-12-20	Initial Issue	Kahn yang

Contents

<u>1</u>	<u>TEST STANDARDS</u>	<u>5</u>
<u>2</u>	<u>SUMMARY</u>	<u>6</u>
2.1	General Remarks	6
2.2	Product Description	6
2.3	Equipment under Test	6
2.4	Short description of the Equipment under Test (EUT)	6
2.5	Normal Accessory setting	7
2.6	EUT configuration	7
2.7	Related Submittal(s) / Grant (s)	7
2.8	Modifications	7
2.9	GeneralTest Conditions/Configurations	7
<u>3</u>	<u>TEST ENVIRONMENT</u>	<u>8</u>
3.1	Address of the test laboratory	8
3.2	Environmental conditions	8
3.3	Test Description	9
3.4	Equipments Used during the Test	10
<u>4</u>	<u>TEST CONDITIONS AND RESULTS</u>	<u>11</u>
4.1	Output Power	11
4.2	Peak-to-Average Ratio (PAR)	17
4.3	Occupied Bandwidth and Emission Bandwidth	24
4.4	Band Edge compliance	31
4.5	Spurious Emssion on Antenna Port	38
4.6	Radiated Spurious Emssion	57
4.7	Frequency Stability	65
<u>5</u>	<u>TEST SETUP PHOTOS OF THE EUT</u>	<u>67</u>
<u>6</u>	<u>EXTERNAL AND INTERNAL PHOTOS OF THE EUT</u>	<u>68</u>

1 TEST STANDARDS

The tests were performed according to following standards:

[FCC Part 24](#) :PUBLIC MOBILE SERVICES

[TIA/EIA 603 D June 2010](#):Land Mobile FM or PM Communications Equipment Measurement and Performance Standards.

[47 CFR FCC Part 15 Subpart B](#): - Unintentional Radiators

[FCC Part 2](#): FREQUENCY ALLOCA-TIONS AND RADIO TREATY MAT-TERS; GENERAL RULES AND REG-ULATIONS

[KDB971168 D01:v02r02](#)MEASUREMENT GUIDANCE FOR CERTIFICATION OF LICENSED DIGITAL TRANSMITTERS

[ANSI C63.4:2014](#):Methods of Measurement of Radio-Noise Emissions from Low-Voltage Electrical and Electronic Equipment in the Range of 9 kHz to 40 GHz

2 SUMMARY

2.1 General Remarks

Date of receipt of test sample	:	Dec. 10, 2018
Testing commenced on	:	Dec. 10, 2018
Testing concluded on	:	Dec. 20, 2018

2.2 Product Description

The **Sharing scooter IOT controller AB**'s Model:OT303BL or the "EUT" as referred to in this report; more general information as follows, for more details, refer to the user's manual of the EUT.

Name of EUT	Sharing scooter IOT controller
Model/Type reference:	OT303BL
List Model:	/
Power supply:	DC 36V
Adapter Information	/
Modulation Type	QPSK,16QAM
Antenna Type	Internal
Antenna Gain	-1.01dBi
Operation Frequency Band	LTE Band 2
Operation frequency	LTE Band 2: 1850.7~1909.3 MHz
LTE Release	R8
Extreme temp. Tolerance	-30°C to +50°C
Extreme vol. Limits	32.4VDC to 39.6VDC (nominal: 36.0VDC)

2.3 Equipment under Test

Power supply system utilised

Power supply voltage	:	<input type="radio"/> 120V/ 60 Hz	<input type="radio"/> 115V/60Hz
		<input type="radio"/> 12 V DC	<input type="radio"/> 24 V DC
		<input checked="" type="radio"/> Other (specified in blank below)	

DC 36V From DC Power;

2.4 Short description of the Equipment under Test (EUT)

2.4.1 General Description

OT303BL is subscriber equipment in the WCDMA/GPRS /LTE system. The HSPA/UMTS frequency band is Band 2 and Band 5, LTE frequency band is band 2. band 4; The GPRS frequency band includes GSM850 and GSM900 and DCS1800 and PCS1900, but only GSM850 and PCS1900 bands test data included in this report. The Sharing scooter IOT controller implements such functions as RF signal receiving/transmitting, HSPA/UMTS ,LTE and GPRS protocol processing, etc. Externally it provides micro SD card interface and SIM card interface.

2.5 Normal Accessory setting

Fully charged battery was used during the test.

2.6 EUT configuration

The following peripheral devices and interface cables were connected during the measurement:

● - supplied by the manufacturer

○ - supplied by the lab

<input type="radio"/>	Power Cable	Length (m) :	/
		Shield :	/
		Detachable :	/
<input type="radio"/>	Multimeter	Manufacturer :	/
		Model No. :	/

2.7 Related Submittal(s) / Grant (s)

This submittal(s) (test report) is intended for **FCC ID: 2A12O-OT303BL** filing to comply with FCC Part 24, Rules.

2.8 Modifications

No modifications were implemented to meet testing criteria.

2.9 General Test Conditions/Configurations

2.10.1 Test Environment

EnvironmentParameter	SelectedValuesDuringTests	
Relative Humidity	Ambient	
Temperature	TN	Ambient
Voltage	VL	32.4V
	VN	36.0V
	VH	39.6V

NOTE:VL=lowerextreme testvoltageVN=nominalvoltage
VH=upperextreme testvoltageTN=normaltemperature

3 TEST ENVIRONMENT

3.1 Address of the test laboratory

Shenzhen United Testing Technology Co., Ltd.
2F, Annex Bldg, Jiahuangyuan Tech Park, #365 Baotian 1 Rd, Tiegang Community, Xixiang Str, Bao'an District, Shenzhen, China

3.2 Environmental conditions

During the measurement the environmental conditions were within the listed ranges:

Temperature:	15-35 ° C
Humidity:	30-60 %
Atmospheric pressure:	950-1050mbar

3.3 Test Description

PCSBand (1850-1915MHz pairedwith 1930-1995MHz)

Test Item	FCCRuleNo.	Requirements	Verdict
Effective(Isotropic)RadiatedOutputPower	§2.1046, §24.232	EIRP \leq 2W	Pass
Peak-AverageRatio	§2.1046, §24.232	FCC:Limit \leq 13dB	Pass
ModulationCharacteristics	§2.1047	Digitalmodulation	N/A
Bandwidth	§2.1049	OBW: Nolimit. EBW: Nolimit.	Pass
BandEdgesCompliance	§2.1051, §24.238	\leq -13dBm/1%*EBW, In1MHzbandsimmediatelyoutsideandadjacentto Thefrequency block.	Pass
SpuriousEmissionatAntennaTerminals	§2.1051, §24.238	\leq -13dBm/1MHz, from9kHzto10thharmonicsbut outsideauthorized Operatingfrequency ranges.	Pass
Field Strengthof Spurious Radiation	§2.1053, §24.238	\leq -13dBm/1MHz.	Pass
Frequency Stability	§2.1055, §24.235	FCC:withinauthorizedfrequency block.	Pass
NOTE 1:For theverdict,the“N/A”denotes“not applicable”,the“N/T”denotes “nottested”.			

Remark:

1. The measurement uncertainty is not included in the test result.

3.4 Equipments Used during the Test

Item	Equipment	Manufacturer	Model No.	Serial No.	Calibrated until
CONDUCTED EMISSIONS TEST					
1	AMN	Schwarzbeck	NNLK8121	8121370	2019.9.9
2	AMN	ETS	3810/2	00020199	2019.9.9
3	EMI TEST RECEIVER	Rohde&Schwarz	ESCI	101210	2019.9.9
4	AAN	TESEQ	T8-Cat6	38888	2019.9.9
RADIATED EMISSION TEST					
1	Horn Antenna	Sunol	DRH-118	A101415	2019.9.29
2	BicoNILog Antenna	Sunol	JB1 Antenna	A090215	2019.9.29
3	PREAMP	HP	8449B	3008A00160	2019.9.9
4	PREAMP	HP	8447D	2944A07999	2019.9.9
5	EMI TEST RECEIVER	Rohde&Schwarz	ESR3	101891	2019.9.9
6	VECTOR Signal Generator	Rohde&Schwarz	SMU200A	101521	2019.9.28
7	Signal Generator	Agilent	E4421B	MY4335105	2019.9.28
8	MXA Signal Analyzer	Agilent	N9020A	MY50510140	2019.9.28
9	MXA Signal Analyzer	Agilent	N9020A	MY51110104	2019.9.9
10	ANT Tower&Turn table Controller	Champro	EM 1000	60764	2019.9.28
11	Anechoic Chamber	Taihe Maorui	9m*6m*6m	966A0001	2019.9.9
12	Shielding Room	Taihe Maorui	6.4m*4m*3m	643A0001	2019.9.9
13	RF Power sensor	DARE	RPR3006W	15I00041SNO88	2019.3.14
14	RF Power sensor	DARE	RPR3006W	15I00041SNO89	2019.3.14
15	RF power divider	Anritsu	K241B	992289	2019.9.28
16	Wideband radio communication tester	Rohde&Schwarz	CMW500	154987	2019.9.28
17	Biconical antenna	Schwarzbeck	VHA 9103	91032360	2019.9.8
18	Biconical antenna	Schwarzbeck	VHA 9103	91032361	2019.9.8
19	Broadband Hybrid Antennas	Schwarzbeck	VULB9163	VULB9163#958	2019.9.8
20	Horn Antenna	Schwarzbeck	BBHA9120D	9120D-1680	2020.1.12
21	Active Receive Loop Antenna	Schwarzbeck	FMZB 1919B	00023	2019.11.02
22	Horn Antenna	Schwarzbeck	BBHA 9170	BBHA9170651	2019.03.14
23	Microwave Broadband Pre-amplifier	Schwarzbeck	BBV 9721	100472	2019.10.14
24	Active Loop Antenna	Com-Power	AL-130R	10160009	2019.05.10
25	Power Meter	KEYSIGHT	N1911A	MY50520168	2019.05.10
26	Frequency Meter	VICTOR	VC2000	997406086	2019.05.10
27	DC Power Source	HYELEC	HY5020E	055161818	2019.05.10

4 TEST CONDITIONS AND RESULTS

4.1 Output Power

4.1.1 Conducted Output Power

TEST APPLICABLE

During the process of testing, the EUT was controlled via R&S Digital Radio Communication tester (CMW500) to ensure max power transmission and proper modulation. This result contains output power and EIRP measurements for the EUT. In all cases, output power is within the specified limits.

TEST CONFIGURATION

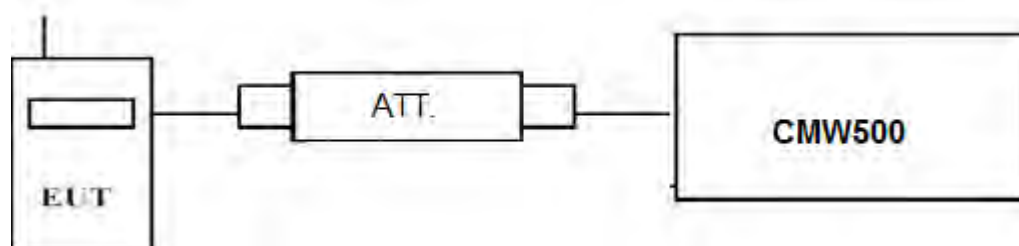

TEST PROCEDURE

Conducted Power Measurement:

- Place the EUT on a bench and set it in transmitting mode.
- Connect a low loss RF cable from the antenna port to a CMW500 by an Att.
- EUT Communicate with CMW500 then selects a channel for testing.
- Add a correction factor to the display CMW500, and then test.

TEST RESULTS

Remark:

- We measured all RB Configuration refer 3GPP TS136 521 for each Channel Bandwidth of LTE FDD Band 2;

LTE FDD Band 2				
TX Channel Bandwidth	Frequency (MHz)	RB Size/Offset	Burst Average Power [dBm]	
			QPSK	16QAM
1.4 MHz	1850.7	1 RB low	22.65	22.16
		1 RB high	21.83	22.41
		50% RB mid	21.71	21.41
		100% RB	21.37	20.55
	1880.0	1 RB low	22.32	21.77
		1 RB high	22.76	22.28
		50% RB mid	22.27	21.63
		100% RB	22.2	20.36
	1909.3	1 RB low	23.25	21.86
		1 RB high	22.77	22.33
		50% RB mid	22.02	21.72
		100% RB	21.36	20.77
3 MHz	1851.5	1 RB low	21.08	21.72
		1 RB high	21.17	20.93
		50% RB mid	20.76	20.49
		100% RB	21.75	20.69
	1880.0	1 RB low	22.31	21.85
		1 RB high	22.44	22.66
		50% RB mid	21.48	20.31
		100% RB	21.65	20.51
1908.5	1 RB low	22.99	21.88	

		1 RB high	22.01	21.52
		50% RB mid	21.11	20.53
		100% RB	21.25	21.35
5 MHz	1852.5	1 RB low	21.68	20.96
		1 RB high	22.27	21.85
		50% RB mid	20.76	20.15
		100% RB	20.56	20.77
	1880.0	1 RB low	23.26	22.76
		1 RB high	22.36	20.97
		50% RB mid	21.36	20.88
		100% RB	22.61	20.78
	1907.5	1 RB low	23.18	22.35
		1 RB high	22.12	21.17
		50% RB mid	21.47	20.37
		100% RB	22.79	20.46
10 MHz	1855.0	1 RB low	22.55	20.71
		1 RB high	21.49	22.54
		50% RB mid	20.36	20.25
		100% RB	20.14	20.65
	1880.0	1 RB low	22.61	21.82
		1 RB high	22.45	22.89
		50% RB mid	20.87	21.44
		100% RB	22.28	20.78
	1905.0	1 RB low	22.44	20.49
		1 RB high	22.17	20.97
		50% RB mid	20.36	20.85
		100% RB	20.98	20.44
15 MHz	1857.5	1 RB low	21.03	21.35
		1 RB high	22.43	22.36
		50% RB mid	20.34	20.59
		100% RB	20.93	21.11
	1880.0	1 RB low	22.39	20.66
		1 RB high	22.73	21.81
		50% RB mid	22.68	21.72
		100% RB	22.77	21.78
	1902.5	1 RB low	22.79	21.63
		1 RB high	21.47	21.57
		50% RB mid	21.29	20.66
		100% RB	21.53	20.94
20 MHz	1860.0	1 RB low	21.46	20.84
		1 RB high	22.9	22.98
		50% RB mid	21.02	20.32
		100% RB	22.52	20.01
	1880.0	1 RB low	23.51	21.33
		1 RB high	22.65	21.48
		50% RB mid	22.81	20.91
		100% RB	22.22	20.34
	1900.0	1 RB low	22.72	22.66
		1 RB high	22.15	21.25
		50% RB mid	21.83	20.47
		100% RB	20.37	20.88

4.1.2. Radiated Output Power

LIMIT

This is the test for the maximum radiated power from the EUT.

Rule Part 24.232(b) specifies, "Mobile/portable stations are limited to 2 watts e.i.r.p.

TEST CONFIGURATION

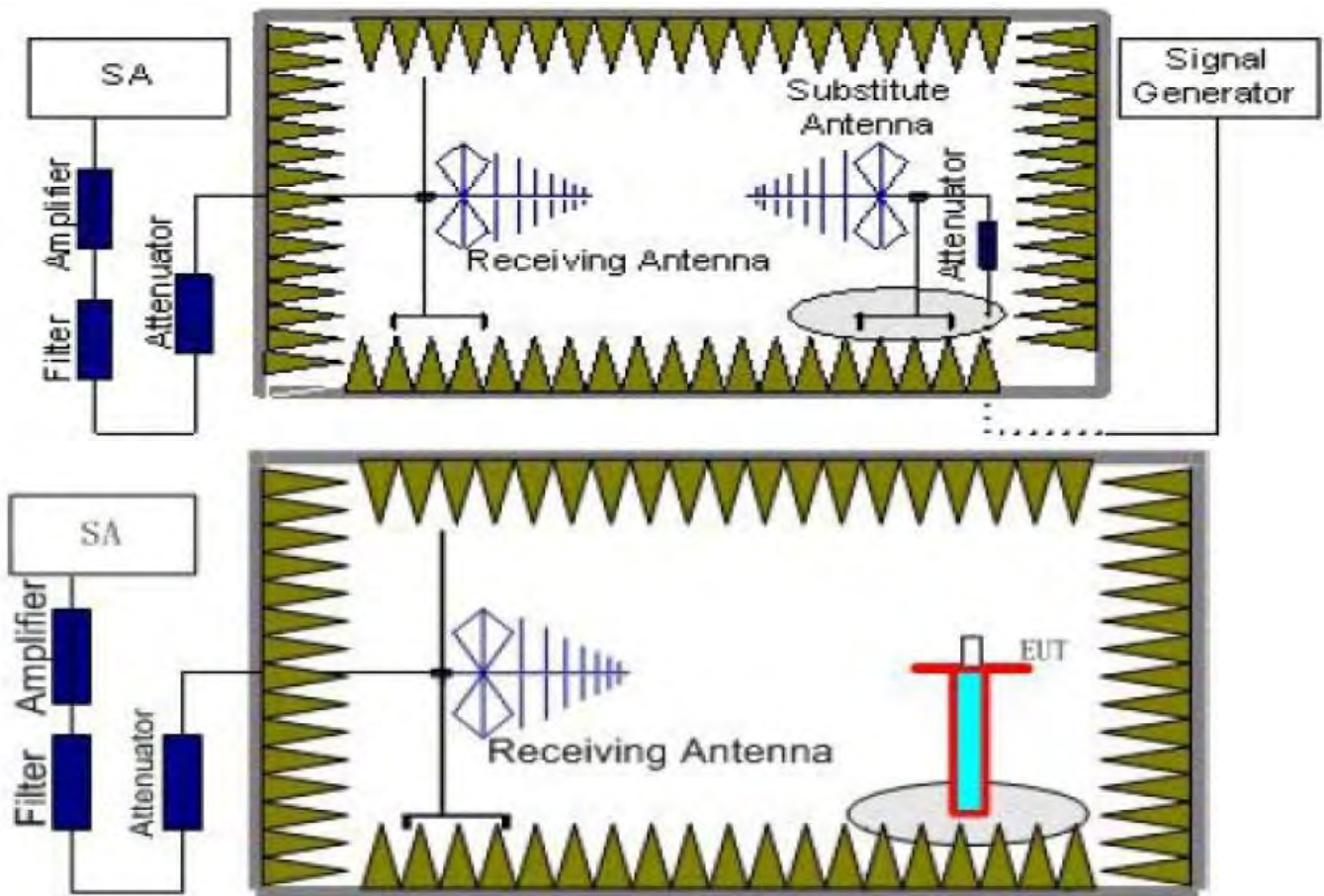

TEST PROCEDURE

1. EUT was placed on a 1.50 meter high non-conductive stand at a 3 meter test distance from the receive antenna. A receiving antenna was placed on the antenna mast 3 meters from the EUT for emission measurements. The height of receiving antenna is 1.50m. Detected emissions were maximized at each frequency by rotating the EUT through 360° and adjusting the receiving antenna polarization. The radiated emission measurements of all transmit frequencies in three channels (High, Middle, Low) were measured with peak detector.
2. A log-periodic antenna or double-ridged waveguide horn antenna shall be substituted in place of the EUT. The log-periodic antenna will be driven by a signal generator and the level will be adjusted till the same power value on the spectrum analyzer or receiver. The level of the spurious emissions can be calculated through the level of the signal generator, cable loss, the gain of the substitution antenna and the reading of the spectrum analyzer or receiver.
3. The EUT is then put into continuously transmitting mode at its maximum power level during the test. Set Test Receiver or Spectrum RBW=1MHz, VBW=3MHz, And the maximum value of the receiver should be recorded as (P_r).
4. The EUT shall be replaced by a substitution antenna. In the chamber, a substitution antenna for the frequency band of interest is placed at the reference point of the chamber. An RF Signal source for the frequency band of interest is disconnected to the substitution antenna with a cable that has been constructed to not interfere with the radiation pattern of the antenna. A power (P_{Mea}) is applied to the input of the substitution antenna, and adjust the level of the signal generator output until the value of the receiver reach the previously recorded (P_r). The power of signal source (P_{Mea}) is recorded. The test should be performed by rotating the test item and adjusting the receiving antenna polarization.

5. An amplifier should be connected to the Signal Source output port. And the cable should be connect between the Amplifier and the Substitution Antenna. The cable loss (P_{cl}), the Substitution Antenna Gain (G_a) and the Amplifier Gain (P_{Ag}) should be recorded after test.
The measurement results are obtained as described below:
Power(EIRP)= $P_{Mea} - P_{Ag} - P_{cl} + G_a$
We used SMF100A microwave signal generator which signal level can up to 33dBm,so we not used power Amplifier for substitution test; The measurement results are amend as described below:
Power(EIRP)= $P_{Mea} - P_{cl} + G_a$
6. This value is EIRP since the measurement is calibrated using an antenna of known gain (2.15 dBi) and known input power.
7. ERP can be calculated from EIRP by subtracting the gain of the dipole, ERP = EIRP-2.15dBi.

TEST RESULTS

Radiated Measurement:

Remark:

1. We measured all RB Configuration refer 3GPP TS136 521 for each Channel Bandwidth of LTE FDD Band 2; recorded worst case for each Channel Bandwidth of LTE FDD Band 2.
2. $EIRP = P_{Mea}(dBm) - P_{cl}(dB) + P_{Ag}(dB) + G_a(dBi)$
3. We measured both Horizontal and Vertical direction, recorded worst case direction.

LTE FDD Band 2_Channel Bandwidth 1.4MHz_QPSK

Frequency (MHz)	P_{Mea} (dBm)	P_{cl} (dB)	G_a Antenna Gain(dB)	P_{Ag} (dB)	Burst Average EIRP (dBm)	Limit (dBm)	Margin (dB)	Polarization
1850.7	-21.37	3.41	10.24	33.60	19.06	33.01	13.95	V
1880.0	-19.62	3.49	10.24	33.60	20.73	33.01	12.28	V
1909.3	-19.06	3.55	10.23	33.60	21.22	33.01	11.79	V

LTE FDD Band 2_Channel Bandwidth 3MHz_QPSK

Frequency (MHz)	P_{Mea} (dBm)	P_{cl} (dB)	G_a Antenna Gain(dB)	P_{Ag} (dB)	Burst Average EIRP (dBm)	Limit (dBm)	Margin (dB)	Polarization
1851.5	-21.48	3.41	10.24	33.60	18.95	33.01	14.06	V
1880.0	-20.03	3.49	10.24	33.60	20.32	33.01	12.69	V
1908.5	-19.76	3.55	10.23	33.60	20.52	33.01	12.49	V

LTE FDD Band 2_Channel Bandwidth 5MHz_QPSK

Frequency (MHz)	P_{Mea} (dBm)	P_{cl} (dB)	G_a Antenna Gain(dB)	P_{Ag} (dB)	Burst Average EIRP (dBm)	Limit (dBm)	Margin (dB)	Polarization
1852.5	-20.14	3.41	10.24	33.60	20.29	33.01	12.72	V
1880.0	-17.98	3.49	10.24	33.60	22.37	33.01	10.64	V
1907.5	-19.34	3.55	10.23	33.60	20.94	33.01	12.07	V

LTE FDD Band 2_Channel Bandwidth 10MHz_QPSK

Frequency (MHz)	P_{Mea} (dBm)	P_{cl} (dB)	G_a Antenna Gain(dB)	P_{Ag} (dB)	Burst Average EIRP (dBm)	Limit (dBm)	Margin (dB)	Polarization
1855.0	-21.35	3.41	10.24	33.60	19.08	33.01	13.93	V
1880.0	-20.78	3.49	10.24	33.60	19.57	33.01	13.44	V
1905.0	-19.46	3.55	10.23	33.60	20.82	33.01	12.19	V

LTE FDD Band 2_Channel Bandwidth 15MHz_QPSK

Frequency (MHz)	P _{Mea} (dBm)	P _{cl} (dB)	G _a Antenna Gain(dB)	P _{Aq} (dB)	Burst Average EIRP (dBm)	Limit (dBm)	Margin (dB)	Polarization
1857.5	-19.75	3.41	10.24	33.60	20.68	33.01	12.33	V
1880.0	-19.51	3.49	10.24	33.60	20.84	33.01	12.17	V
1902.5	-20.65	3.55	10.23	33.60	19.63	33.01	13.38	V

LTE FDD Band 2_Channel Bandwidth 20MHz_QPSK

Frequency (MHz)	P _{Mea} (dBm)	P _{cl} (dB)	G _a Antenna Gain(dB)	P _{Aq} (dB)	Burst Average EIRP (dBm)	Limit (dBm)	Margin (dB)	Polarization
1860.0	-19.26	3.41	10.24	33.60	21.17	33.01	11.84	V
1880.0	-19.15	3.49	10.24	33.60	21.20	33.01	11.81	V
1900.0	-21.44	3.55	10.23	33.60	18.84	33.01	14.17	V

LTE FDD Band 2_Channel Bandwidth 1.4MHz_16QAM

Frequency (MHz)	P _{Mea} (dBm)	P _{cl} (dB)	G _a Antenna Gain(dB)	P _{Aq} (dB)	Burst Average EIRP (dBm)	Limit (dBm)	Margin (dB)	Polarization
1850.7	-21.04	3.41	10.24	33.60	19.39	33.01	13.62	V
1880.0	-20.89	3.49	10.24	33.60	19.46	33.01	13.55	V
1909.3	-21.64	3.55	10.23	33.60	18.64	33.01	14.37	V

LTE FDD Band 2_Channel Bandwidth 3MHz_16QAM

Frequency (MHz)	P _{Mea} (dBm)	P _{cl} (dB)	G _a Antenna Gain(dB)	P _{Aq} (dB)	Burst Average EIRP (dBm)	Limit (dBm)	Margin (dB)	Polarization
1851.5	-21.11	3.41	10.24	33.60	19.32	33.01	13.69	V
1880.0	-20.12	3.49	10.24	33.60	20.23	33.01	12.78	V
1908.5	-20.45	3.55	10.23	33.60	19.83	33.01	13.18	V

LTE FDD Band 2_Channel Bandwidth 5MHz_16QAM

Frequency (MHz)	P _{Mea} (dBm)	P _{cl} (dB)	G _a Antenna Gain(dB)	P _{Aq} (dB)	Burst Average EIRP (dBm)	Limit (dBm)	Margin (dB)	Polarization
1852.5	-21.71	3.41	10.24	33.60	18.72	33.01	14.29	V
1880.0	-21.07	3.49	10.24	33.60	19.28	33.01	13.73	V
1907.5	-21.27	3.55	10.23	33.60	19.01	33.01	14.00	V

LTE FDD Band 2_Channel Bandwidth 10MHz_16QAM

Frequency (MHz)	P _{Mea} (dBm)	P _{cl} (dB)	G _a Antenna Gain(dB)	P _{Aq} (dB)	Burst Average EIRP (dBm)	Limit (dBm)	Margin (dB)	Polarization
1855.0	-22.17	3.41	10.24	33.60	18.26	33.01	14.75	V
1880.0	-20.68	3.49	10.24	33.60	19.67	33.01	13.34	V
1905.0	-20.89	3.55	10.23	33.60	19.39	33.01	13.62	V

LTE FDD Band 2_Channel Bandwidth 15MHz_16QAM

Frequency (MHz)	P _{Mea} (dBm)	P _{cl} (dB)	G _a Antenna Gain(dB)	P _{Aq} (dB)	Burst Average EIRP (dBm)	Limit (dBm)	Margin (dB)	Polarization
1857.5	-21.66	3.41	10.24	33.60	18.77	33.01	14.24	V
1880.0	-21.05	3.49	10.24	33.60	19.30	33.01	13.71	V
1902.5	-21.28	3.55	10.23	33.60	19.00	33.01	14.01	V

LTE FDD Band 2_Channel Bandwidth 20MHz_16QAM

Frequency (MHz)	P _{Mea} (dBm)	P _{cl} (dB)	G _a Antenna Gain(dB)	P _{Aq} (dB)	Burst Average EIRP (dBm)	Limit (dBm)	Margin (dB)	Polarization
1860.0	-22.33	3.41	10.24	33.60	18.10	33.01	14.91	V
1880.0	-20.75	3.49	10.24	33.60	19.60	33.01	13.41	V
1900.0	-22.14	3.55	10.23	33.60	18.14	33.01	14.87	V

4.2 Peak-to-Average Ratio (PAR)

LIMIT

The Peak-to-Average Ratio (PAR) of the transmission may not exceed 13 dB.

TEST CONFIGURATION

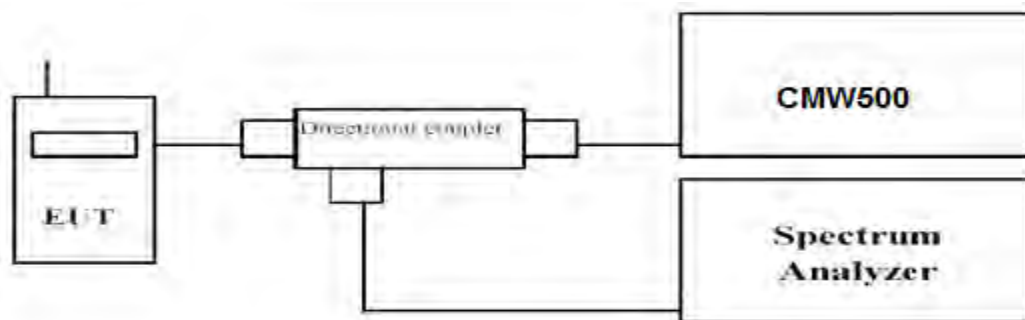

TEST PROCEDURE

1. Refer to instrument's analyzer instruction manual for details on how to use the power statistics/CCDF function;
2. Set resolution/measurement bandwidth \geq signal's occupied bandwidth;
3. Set the number of counts to a value that stabilizes the measured CCDF curve;
4. Set the measurement interval as follows:
 - 1). for continuous transmissions, set to 1 ms,
 - 2). for burst transmissions, employ an external trigger that is synchronized with the EUT burst timing sequence, or use the internal burst trigger with a trigger level that allows the burst to stabilize and set the measurement interval to a time that is less than or equal to the burst duration.
5. Record the maximum PAPR level associated with a probability of 0.1%.

TEST RESULTS

Remark:

1. We measured all RB Configuration refer 3GPP TS136 521 for each Channel Bandwidth of LTE FDD Band 2; recorded worst case for each Channel Bandwidth of LTE FDD Band 2.

LTE FDD Band 2				
TX Channel Bandwidth	Frequency (MHz)	RB Size/Offset	PAPR(dB)	
			QPSK	16QAM
1.4 MHz	1850.7	1RB#0	3.91	4.67
	1880.0		5.23	6.04
	1909.3		5.71	6.49
3 MHz	1851.5	1RB#0	4.26	5.11
	1880.0		5.27	6.04
	1908.5		5.56	6.51
5 MHz	1852.5	1RB#0	4.35	5.07
	1880.0		5.48	6.28
	1907.5		5.62	6.38
10 MHz	1855.0	1RB#0	4.86	5.47
	1880.0		5.40	6.15
	1905.0		5.36	6.18
15 MHz	1857.5	1RB#0	5.13	6.13
	1880.0		5.17	6.39
	1902.5		5.18	6.29
20 MHz	1860.0	1RB#0	6.07	6.75
	1880.0		6.00	6.73
	1900.0		6.02	6.70

LTE FDD Band 2 – 1.4 MHz Channel Bandwidth PAPR

QPSK

16QAM

Low Channel

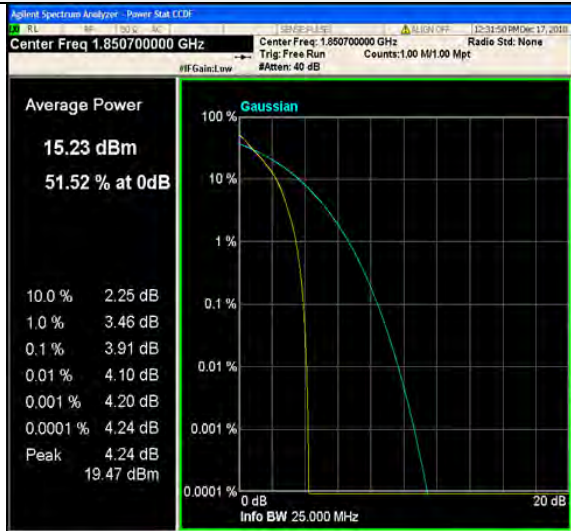

1RB#0

1RB#0

Middle Channel

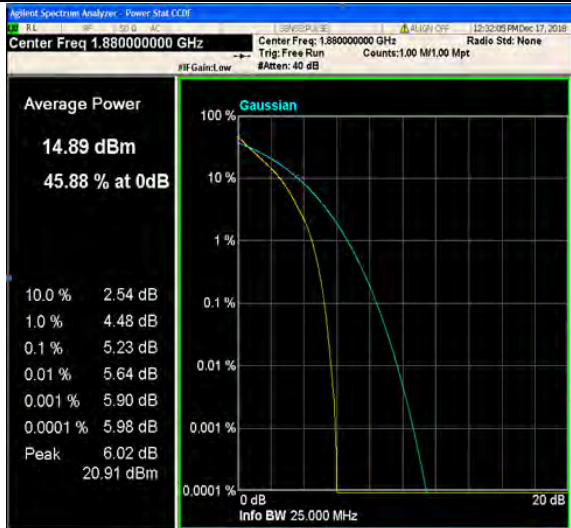

1RB#0

1RB#0

High Channel



1RB#0

1RB#0

LTE FDD Band 2-3MHz Channel Bandwidth PAPR

QPSK

16QAM

Low Channel

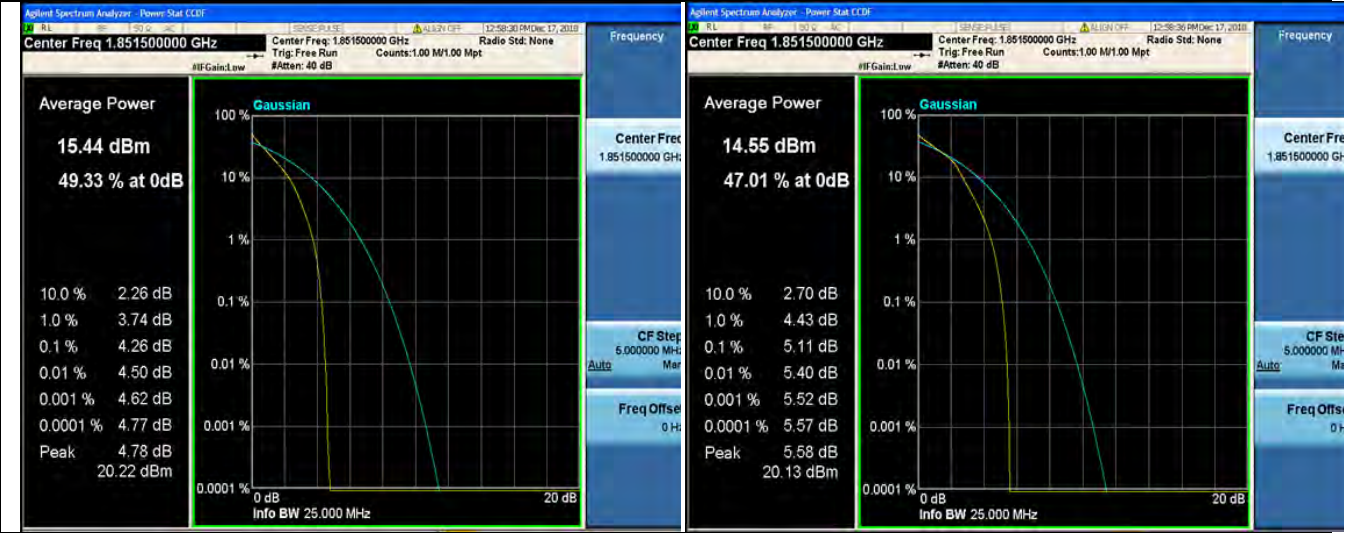

1RB#0

1RB#0

Middle Channel

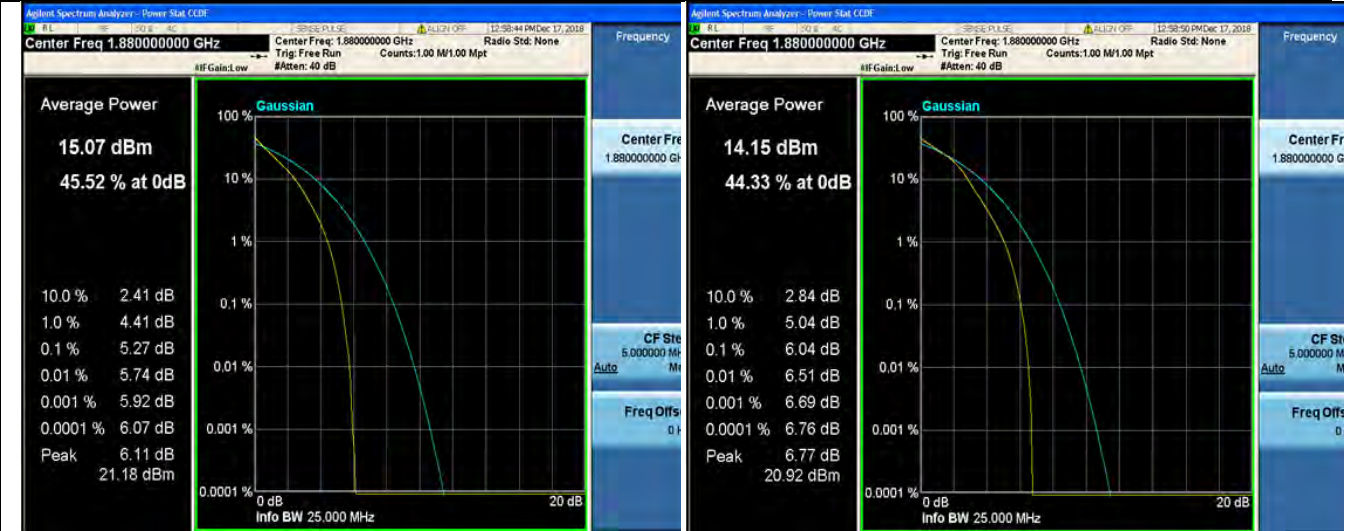

1RB#0

1RB#0

High Channel

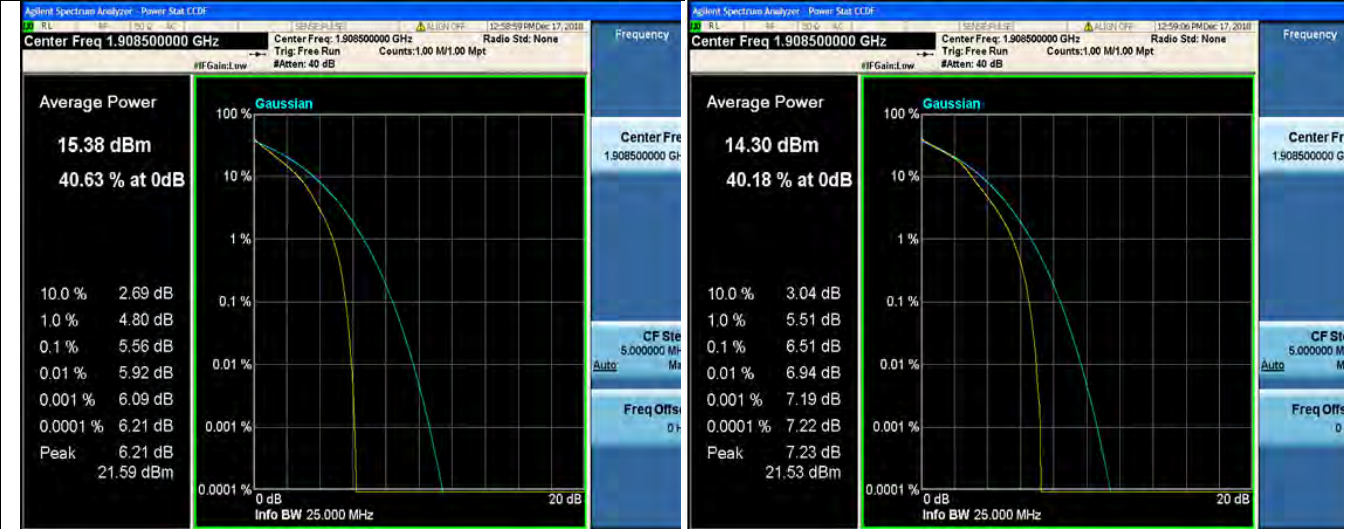

1RB#0

1RB#0

LTE FDD Band 2-5MHz Channel Bandwidth PAPR

QPSK

16QAM

Low Channel

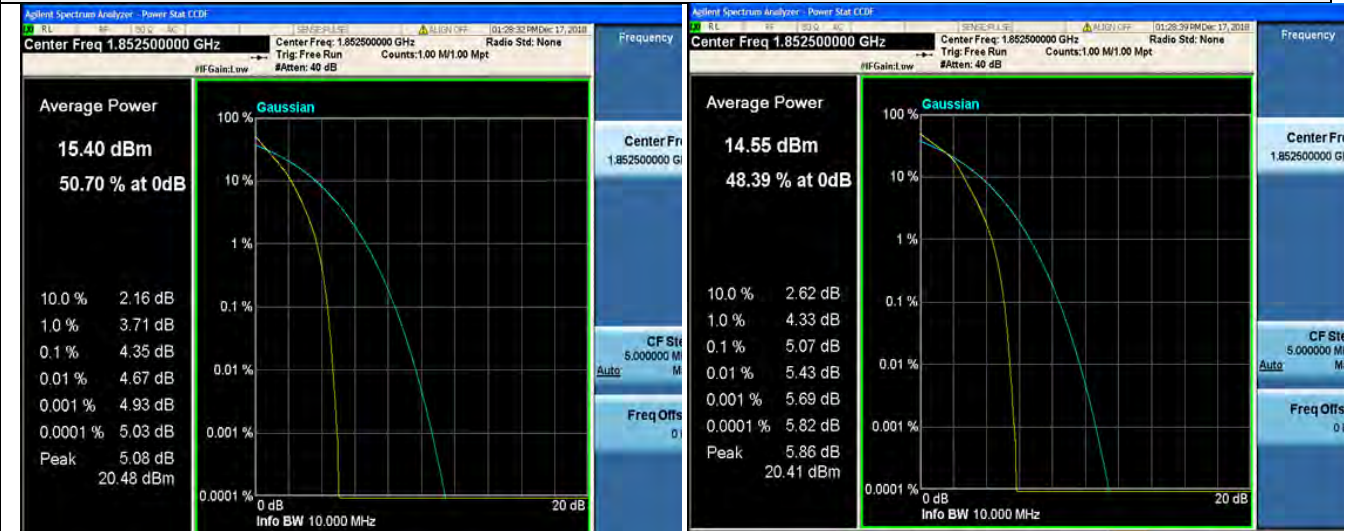

1RB#0

1RB#0

Middle Channel

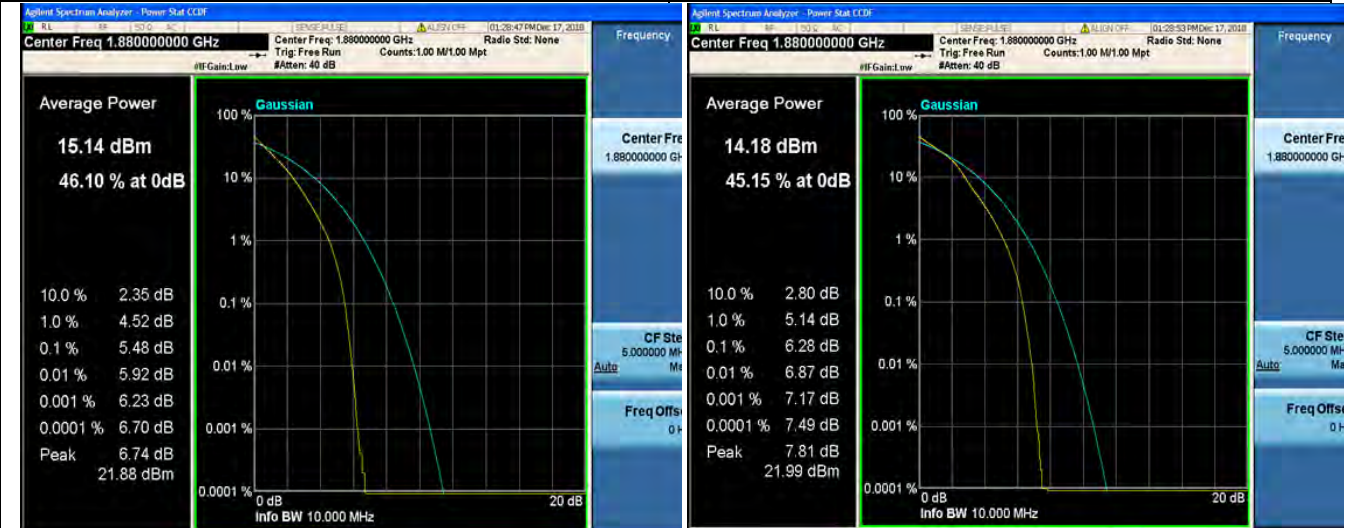

1RB#0

1RB#0

High Channel

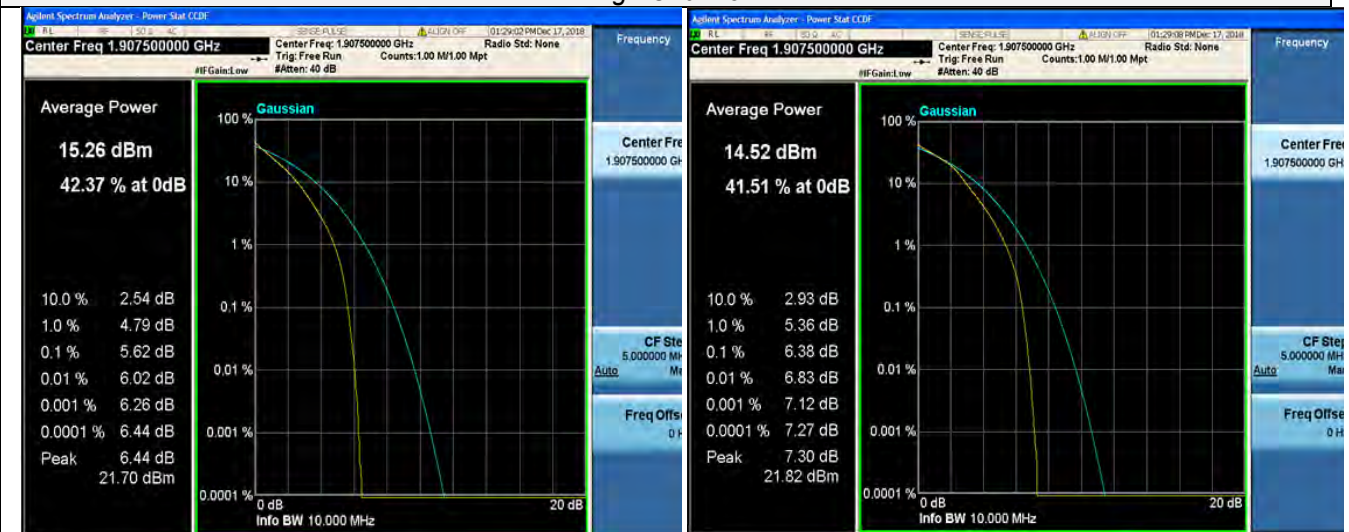

1RB#0

1RB#0

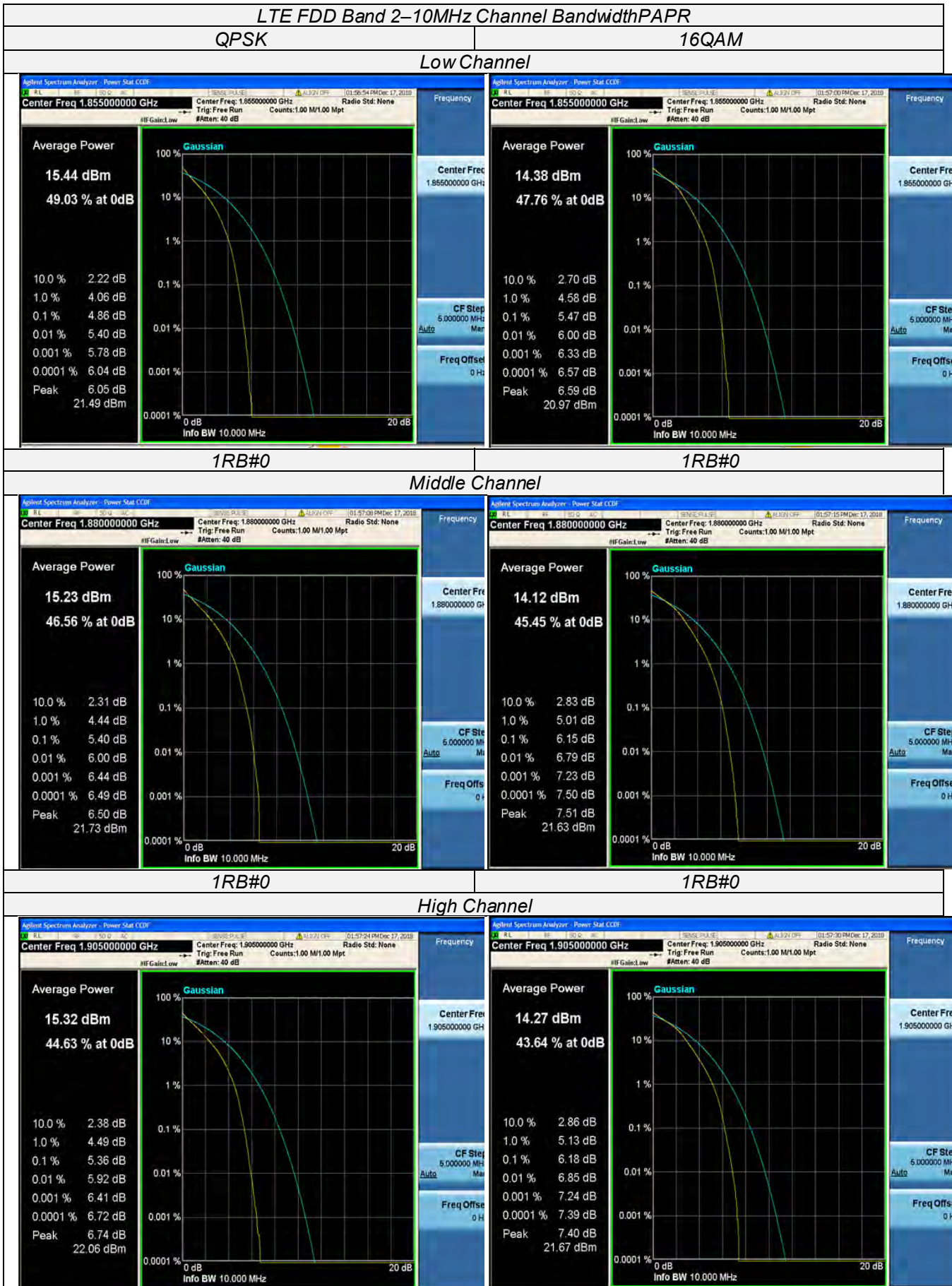

1RB#0	1RB#0
-------	-------

<i>LTE FDD Band 2– 15 MHz Channel BandwidthPAPR</i>	
QPSK	16QAM
<i>Low Channel</i>	

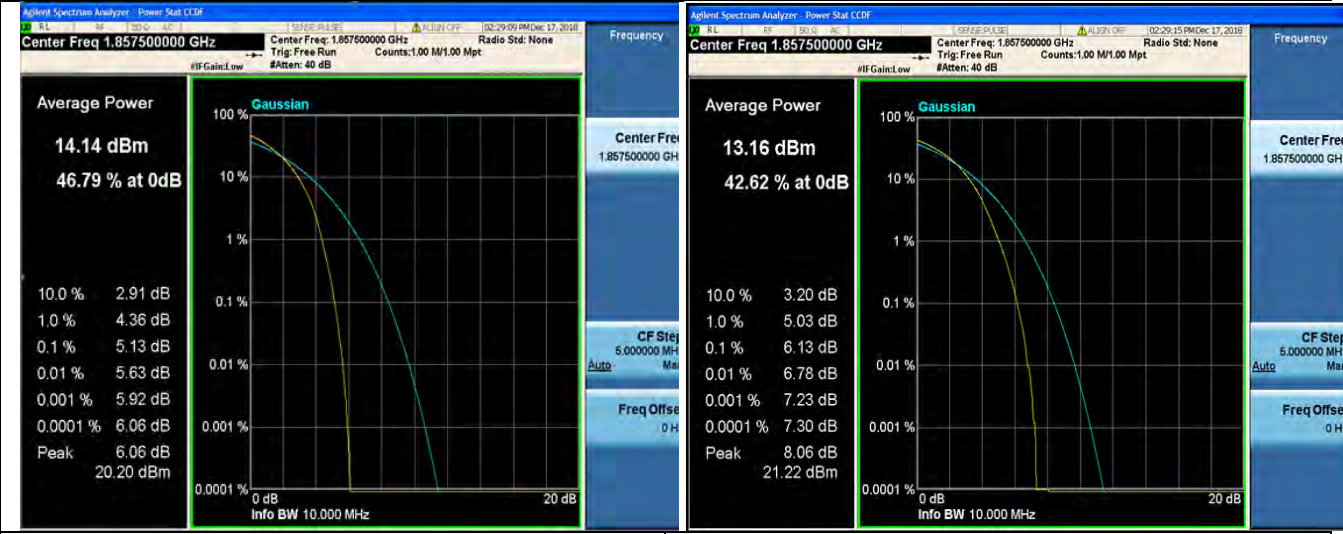

1RB#0	1RB#0
-------	-------

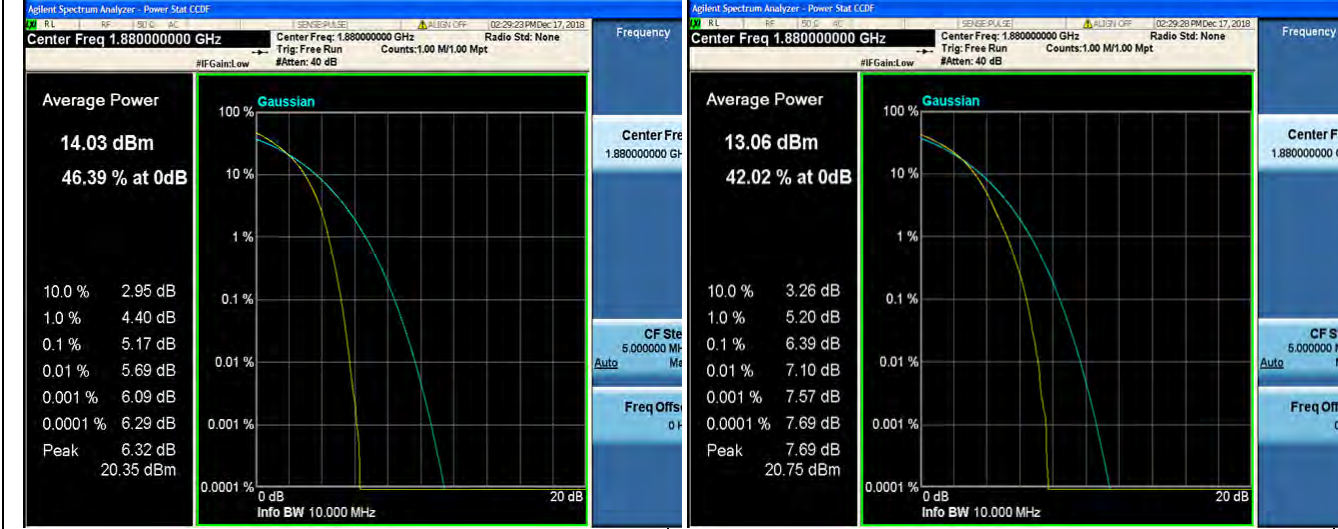

1RB#0	1RB#0
-------	-------

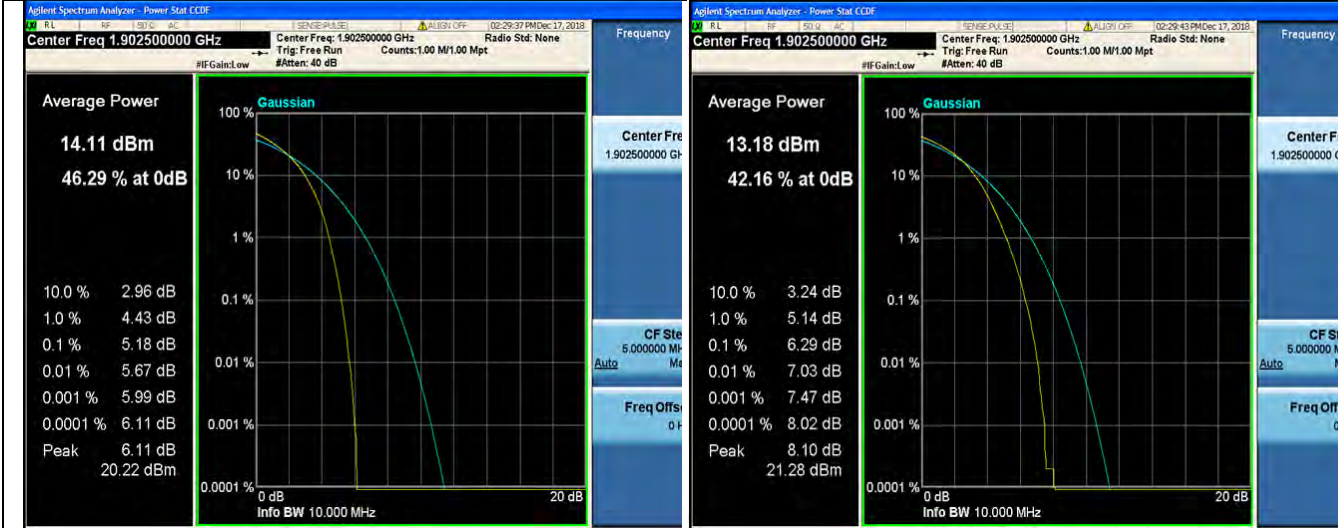

1RB#0	1RB#0
-------	-------



4.3 Occupied Bandwidth and Emission Bandwidth

LIMIT

N/A

TEST CONFIGURATION

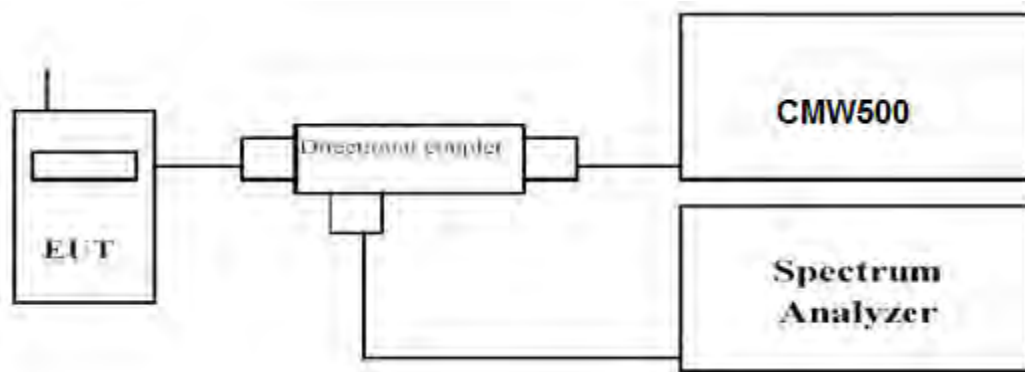

TEST PROCEDURE

The transmitter output was connected to a calibrated coaxial cable and coupler, the other end of which was connected to a spectrum analyzer. The occupied bandwidth was measured with the spectrum analyzer at low, middle and high channel in each band. The -26dBc Emission bandwidth was also measured and recorded. Set RBW was set to about 1% of emission BW, VBW ≥ 3 times RBW.

-26dBc display line was placed on the screen (or 99% bandwidth), the occupied bandwidth is the delta frequency between the two points where the display line intersects the signal trace.

TEST RESULTS

Remark:

1. We were tested all RB Configuration refer 3GPP TS136 521 for each Channel Bandwidth of LTE FDD Band 2; recorded worst case for each Channel Bandwidth of LTE FDD Band 2.

LTE FDD Band 2						
TX Channel Bandwidth	RB Size/Offset	Frequency (MHz)	-26dBc Emission bandwidth (MHz)		99% Occupied bandwidth (MHz)	
			QPSK	16QAM	QPSK	16QAM
1.4 MHz	6RB#0	1850.7	1.0937	1.0977	1.326	1.371
		1880.0	1.0859	1.0909	1.256	1.266
		1909.3	1.0886	1.0912	1.261	1.270
3 MHz	15RB#0	1851.5	2.7006	2.6991	2.953	2.976
		1880.0	2.6930	2.6968	2.903	2.921
		1908.5	2.6958	2.6948	2.938	2.936
5 MHz	25RB#0	1852.5	4.4979	4.5013	4.905	4.856
		1880.0	4.4979	4.4936	4.862	4.860
		1907.5	4.4996	4.5059	4.890	4.899
10 MHz	50RB#0	1855.0	8.9374	8.9287	9.525	9.476
		1880.0	8.9110	8.9236	9.526	9.378
		1905.0	8.9342	8.9203	9.444	9.477
15 MHz	75RB#0	1857.5	13.397	13.396	14.11	14.07
		1880.0	13.371	13.367	14.03	14.11
		1902.5	13.384	13.393	14.05	14.04
20 MHz	100RB#0	1860.0	17.832	17.843	18.63	18.58
		1880.0	17.820	17.819	18.58	18.58
		1900.0	17.854	17.842	18.70	18.61

LTE FDD Band 2 – 1.4 MHz Channel Bandwidth Occupied Bandwidth and Emission Bandwidth

QPSK

16QAM

Low Channel

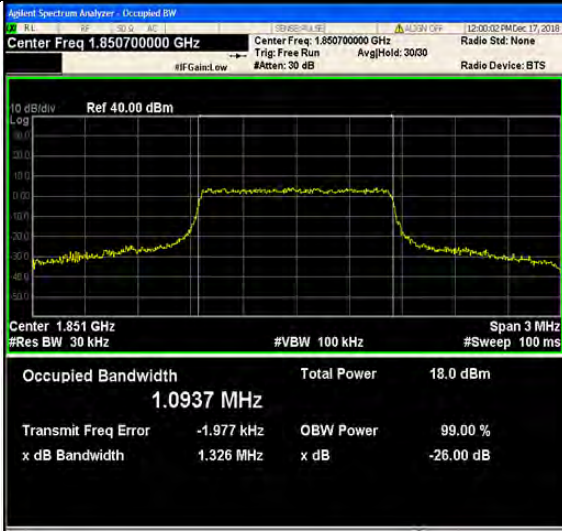

6RB#0

6RB#0

Middle Channel

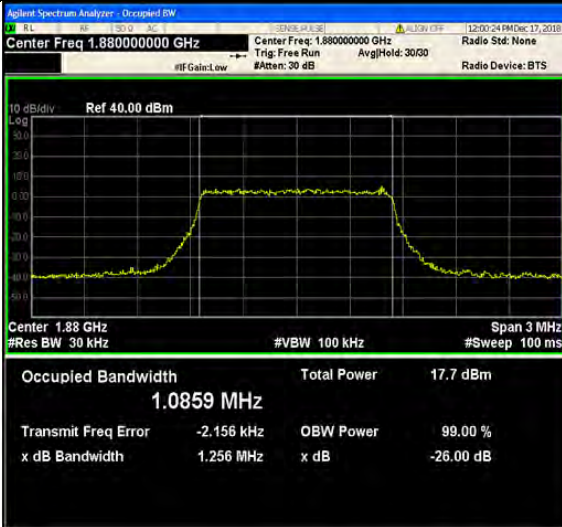

6RB#0

6RB#0

High Channel

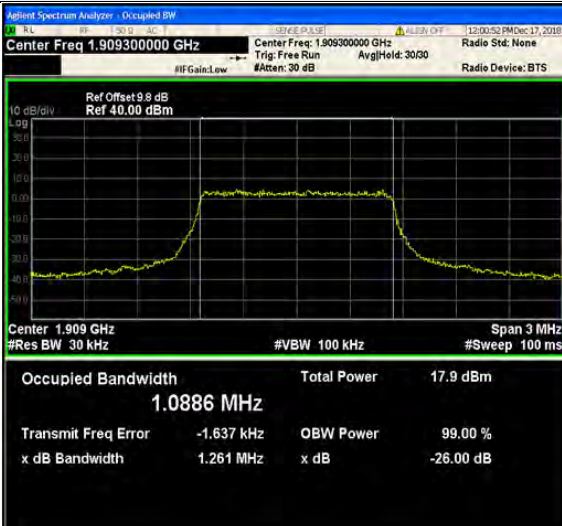

6RB#0

6RB#0

LTE FDD Band 2-3MHz Channel Bandwidth Occupied Bandwidth and Emission Bandwidth

QPSK

16QAM

Low Channel



15RB#0

15RB#0

Middle Channel

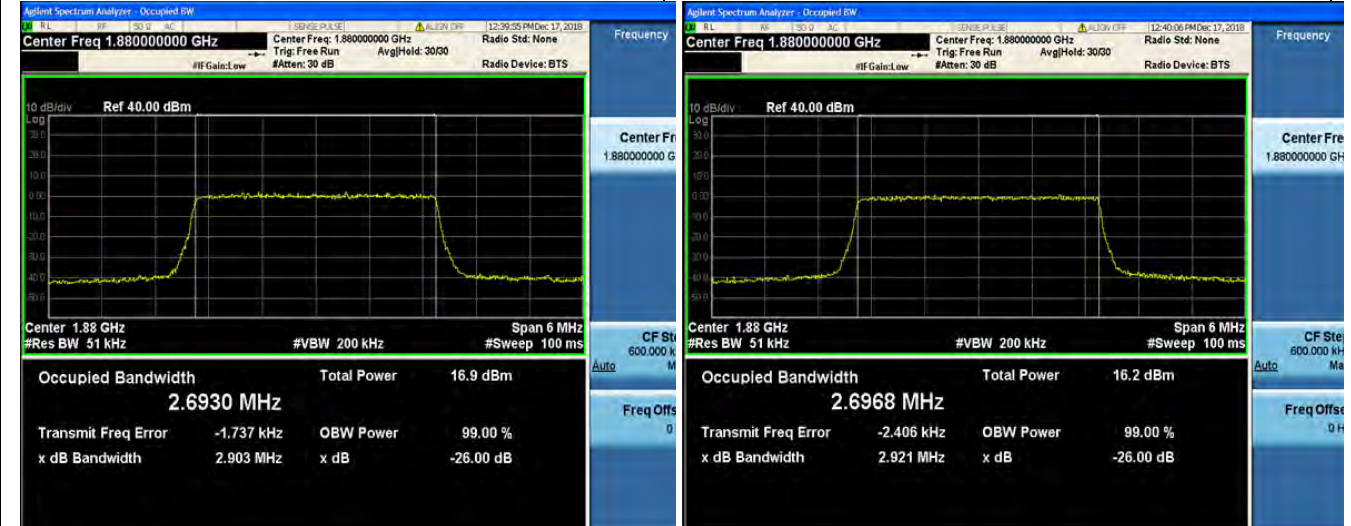

15RB#0

15RB#0

High Channel

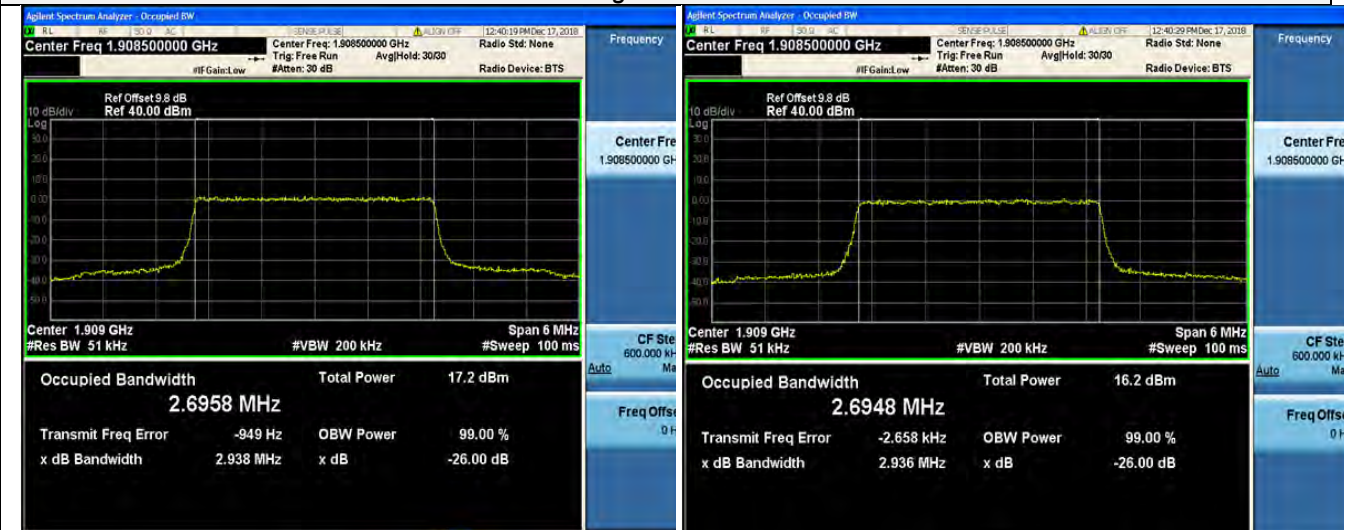

15RB#0

15RB#0

LTE FDD Band 2-5MHz Channel Bandwidth Occupied Bandwidth and Emission Bandwidth

QPSK

16QAM

Low Channel

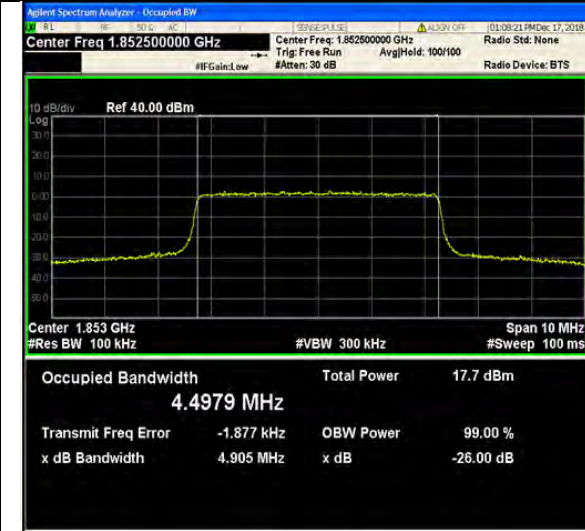

25RB#0

25RB#0

Middle Channel

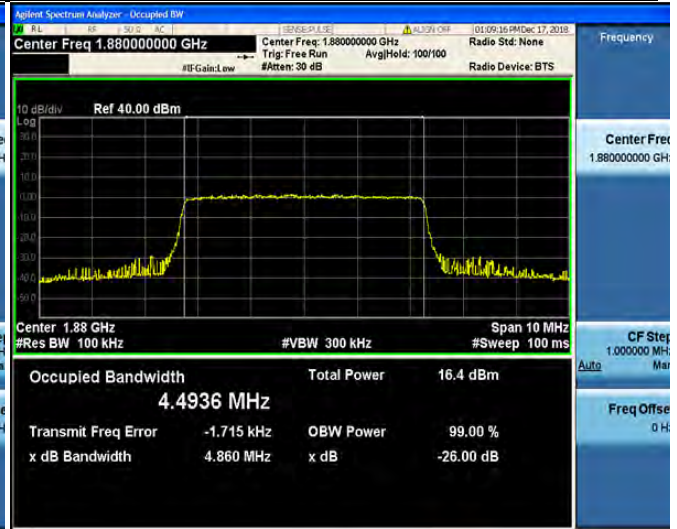
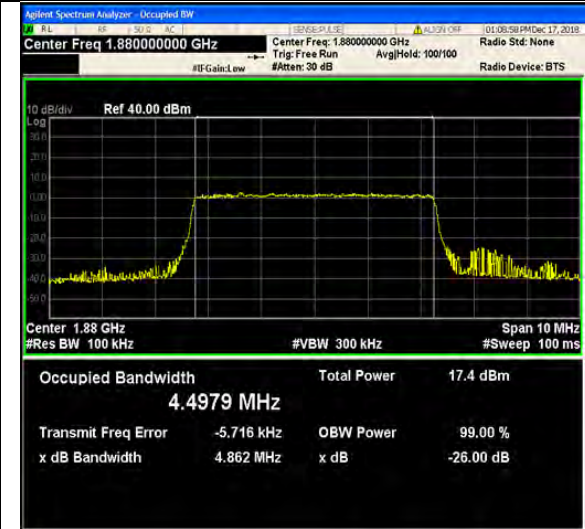

25RB#0

25RB#0

High Channel

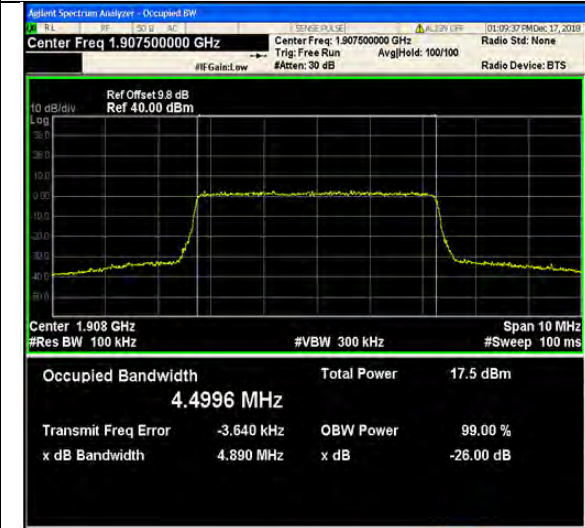

25RB#0

25RB#0

LTE FDD Band 2-15MHz Channel Bandwidth Occupied Bandwidth and Emission Bandwidth

QPSK

16QAM

Low Channel

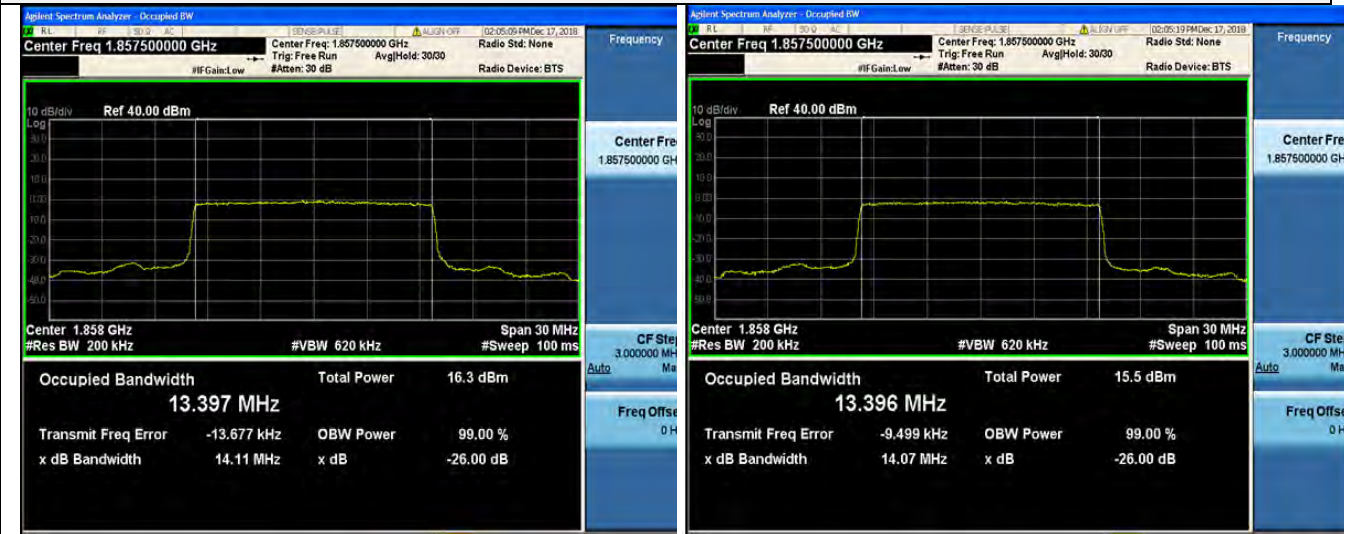

75RB#0

75RB#0

Middle Channel

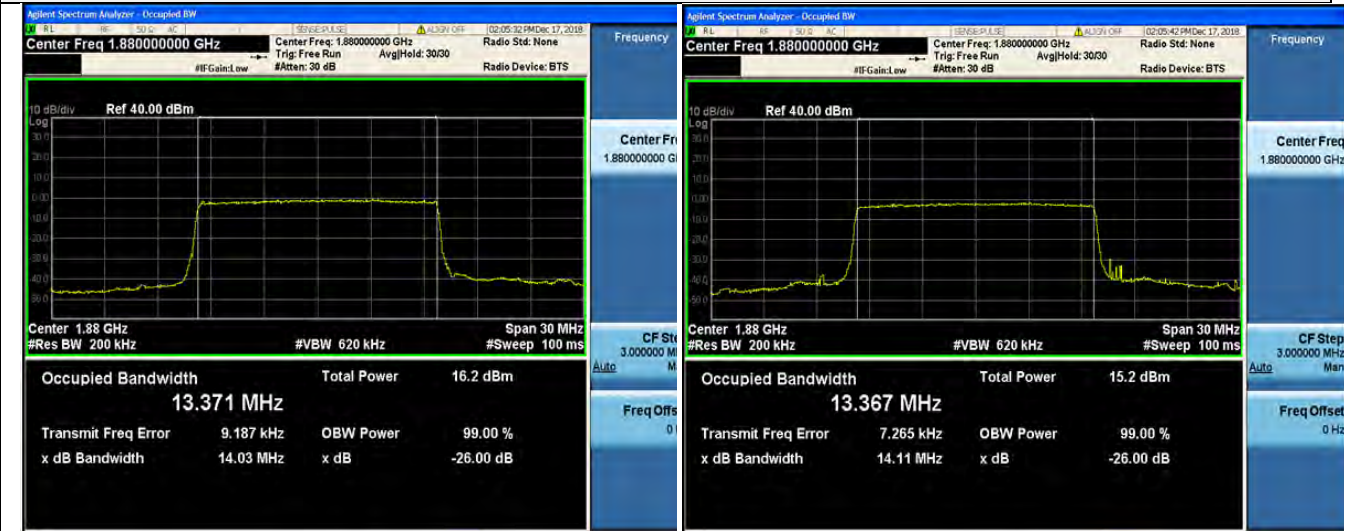

75RB#0

75RB#0

High Channel

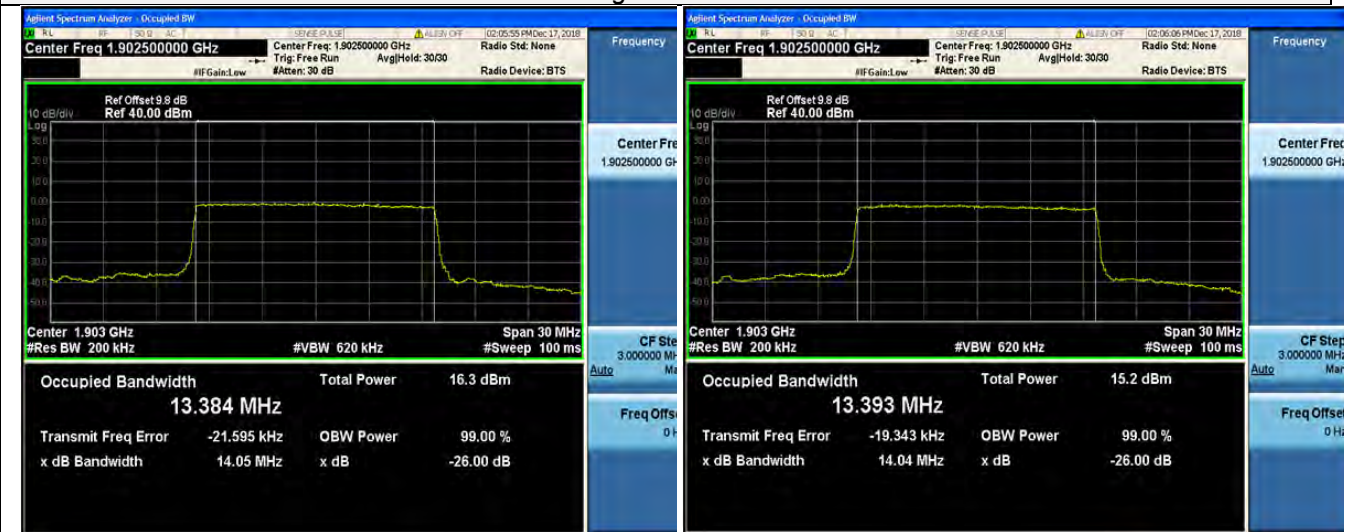

75RB#0

75RB#0

LTE FDD Band 2-20MHz Channel Bandwidth Occupied Bandwidth and Emission Bandwidth

QPSK

16QAM

Low Channel

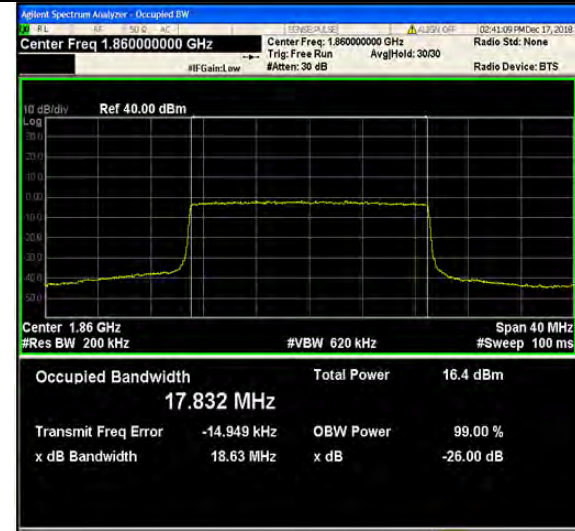

100RB#0

100RB#0

Middle Channel

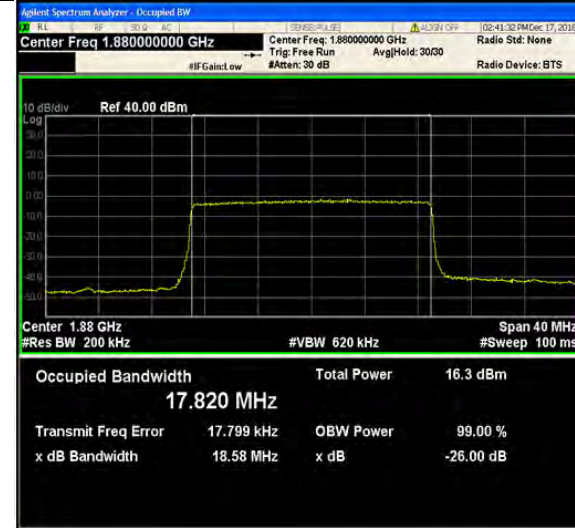

100RB#0

100RB#0

High Channel

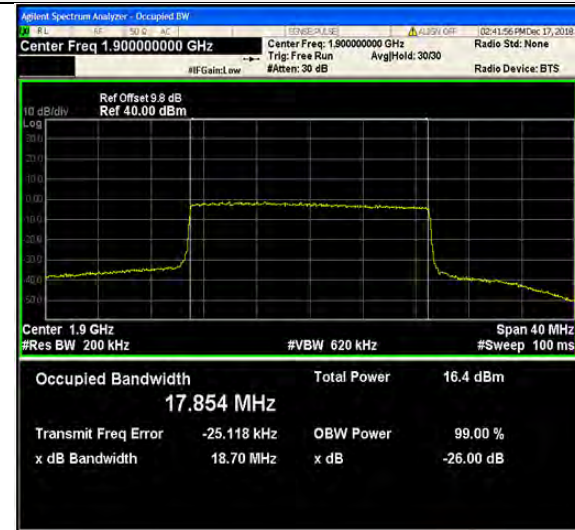

100RB#0

100RB#0

4.4 Band Edge compliance

LIMIT

Per FCC §24.238 the power of any emission outside of the authorized operating frequency ranges must be attenuated below the transmitting power (P) by a factor of at least $43 + 10\log(P)$ dB.

TEST CONFIGURATION

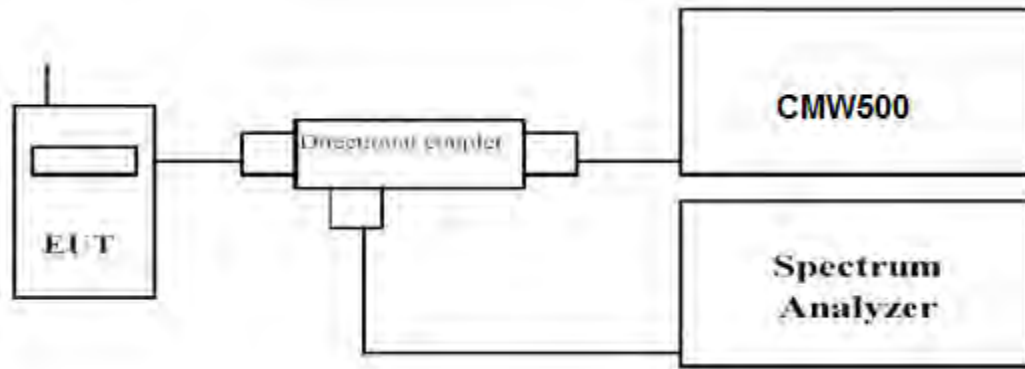

TEST PROCEDURE

1. The transmitter output port was connected to base station.
2. The RF output of EUT was connected to the power meter by RF cable and attenuator, the path loss was compensated to the results for each measurement.
3. Set EUT at maximum power through base station.
4. Select lowest and highest channels for each band and different modulation.
5. Measure Band edge using RMS (Average) detector by spectrum

TEST RESULTS

Remark:

1. We were tested all RB Configuration refer 3GPP TS136 521 for each Channel Bandwidth of LTE FDD Band 2; recorded worst case for each Channel Bandwidth of LTE FDD Band 2.

LTE FDD Band 2 – 1.4 MHz Channel Bandwidth Band Edge Compliance

QPSK

16QAM

Low Channel



6RB#0

6RB#0

High Channel

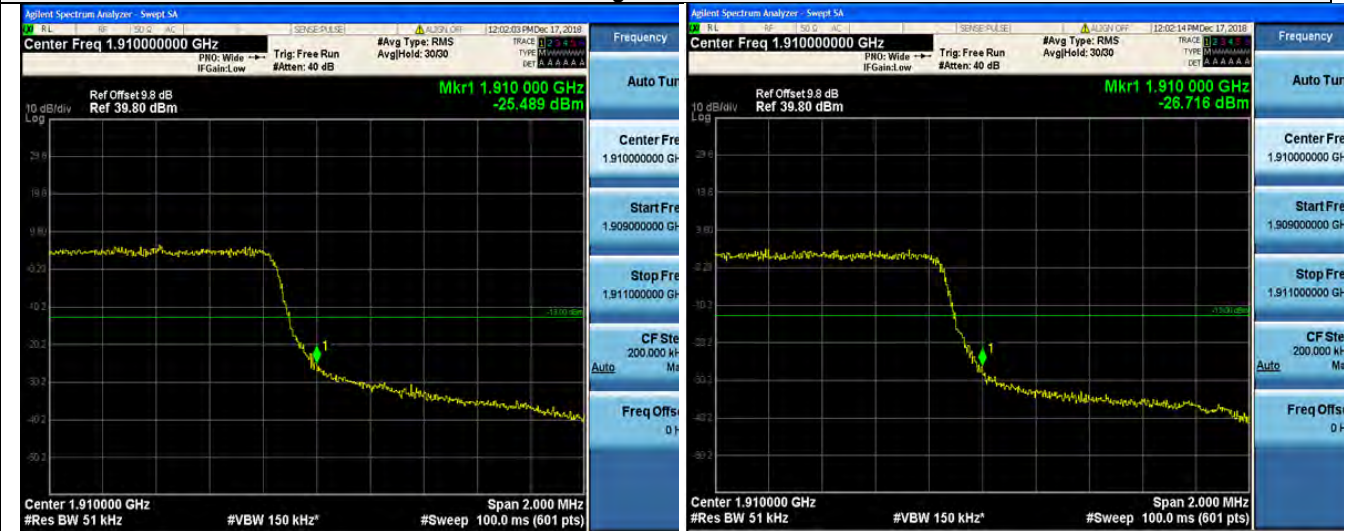

6RB#0

6RB#0

LTE FDD Band 2-3MHz Channel Bandwidth Band Edge Compliance

QPSK

16QAM

Low Channel

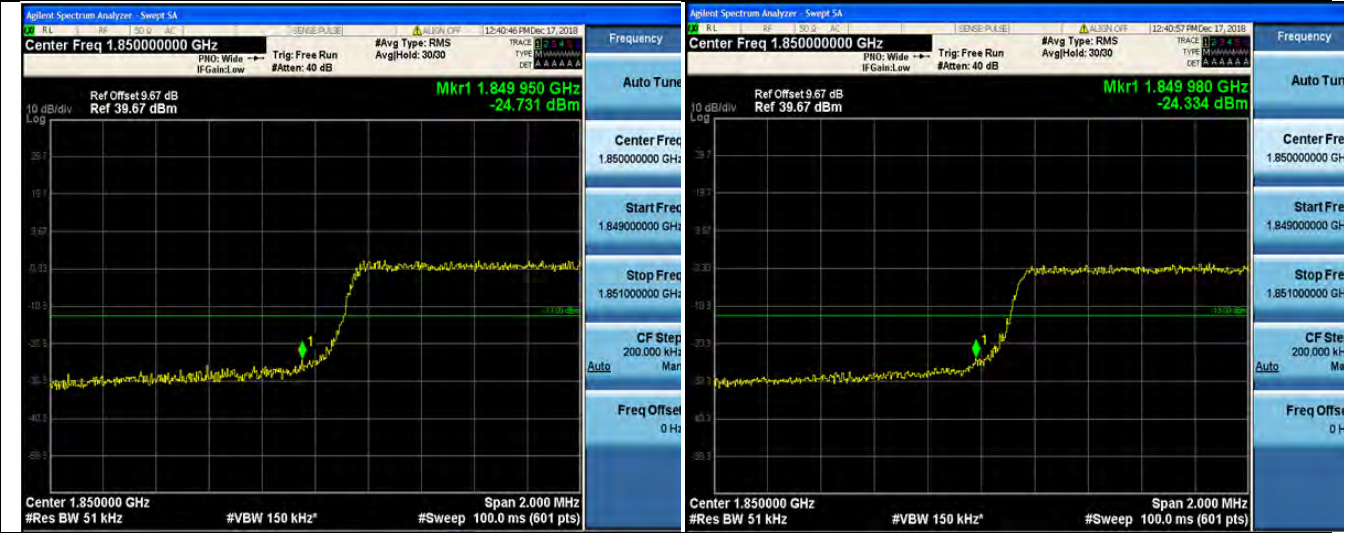

15RB#0

15RB#0

High Channel



15RB#0

15RB#0

LTE FDD Band 2-5MHz Channel Bandwidth Band Edge Compliance

QPSK

16QAM

Low Channel

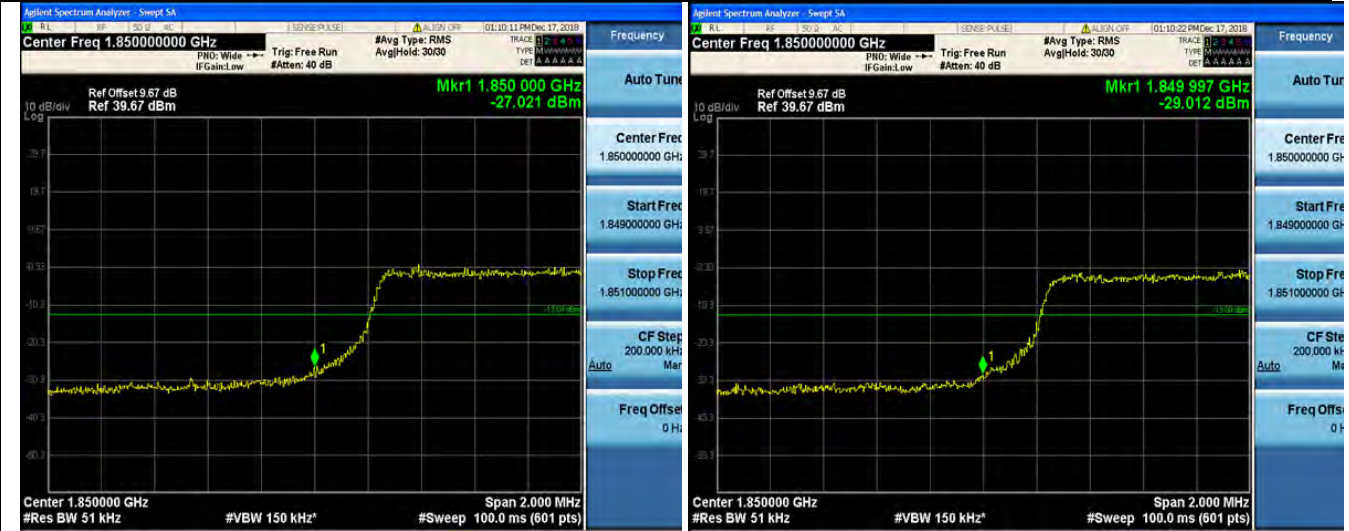

25RB#0

25RB#0

High Channel

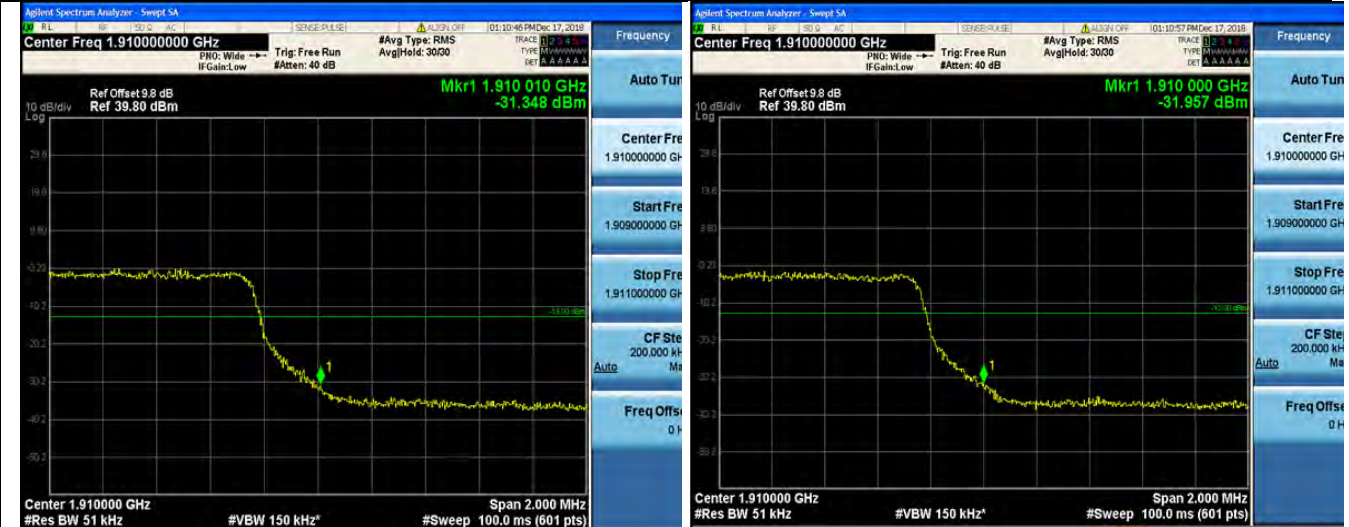

25RB#0

25RB#0

LTE FDD Band 2 – 10 MHz Channel Bandwidth Band Edge Compliance

QPSK

16QAM

Low Channel



50RB#0

50RB#0

High Channel



50RB#0

50RB#0

LTE FDD Band 2-15MHz Channel Bandwidth Band Edge Compliance

QPSK

16QAM

Low Channel

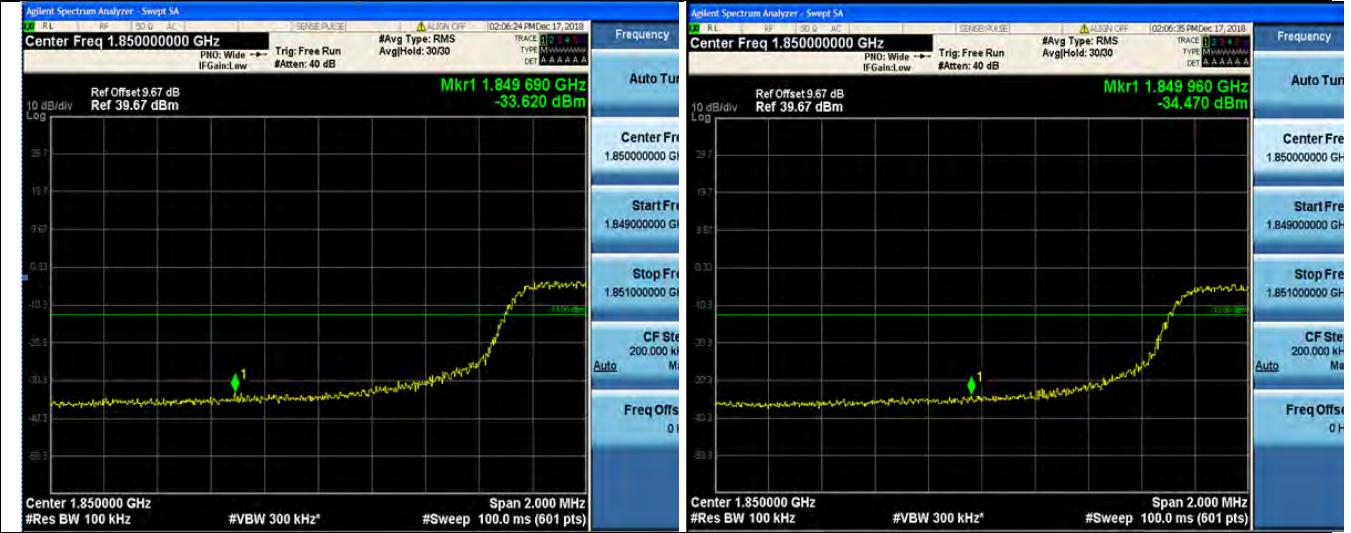

75RB#0

75RB#0

High Channel

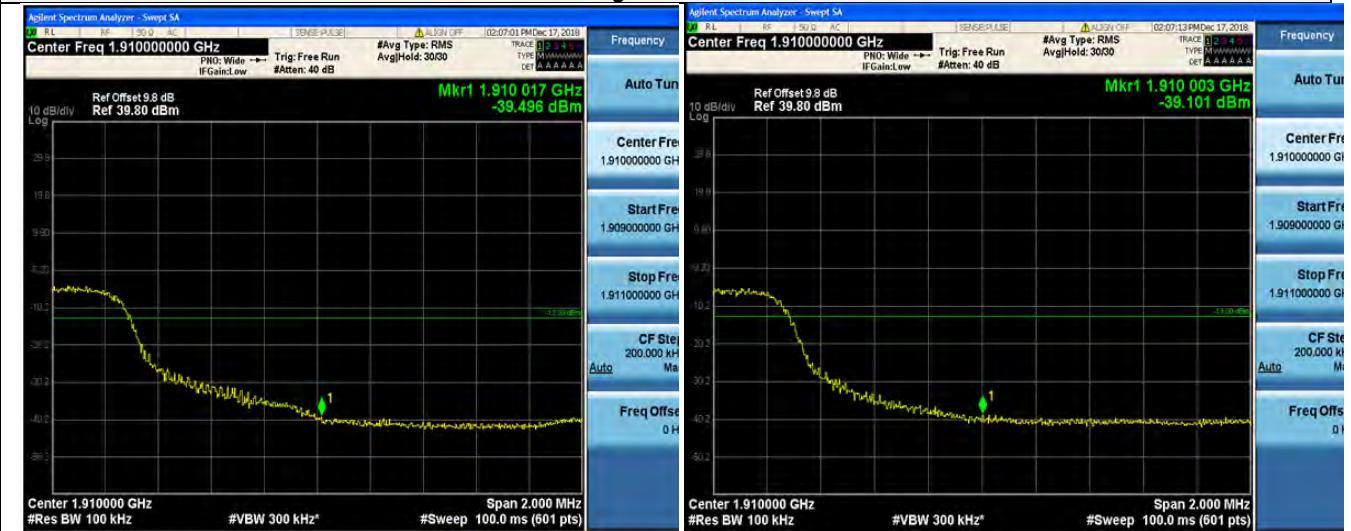

75RB#0

75RB#0

LTE FDD Band 2-20MHz Channel Bandwidth Band Edge Compliance

QPSK

16QAM

Low Channel

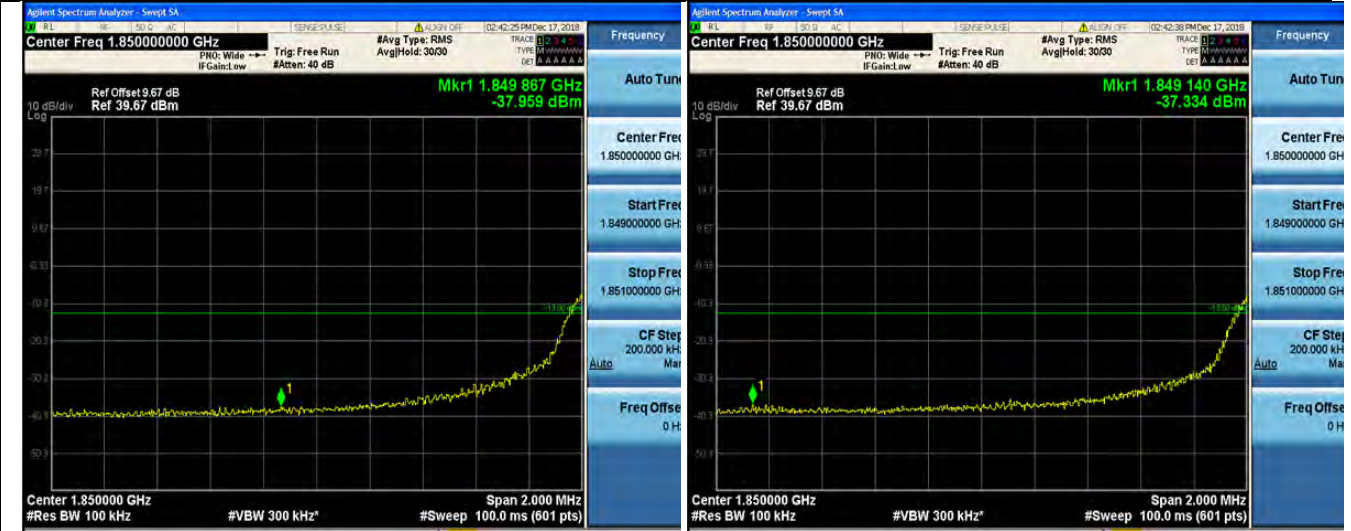

100RB#0

100RB#0

High Channel

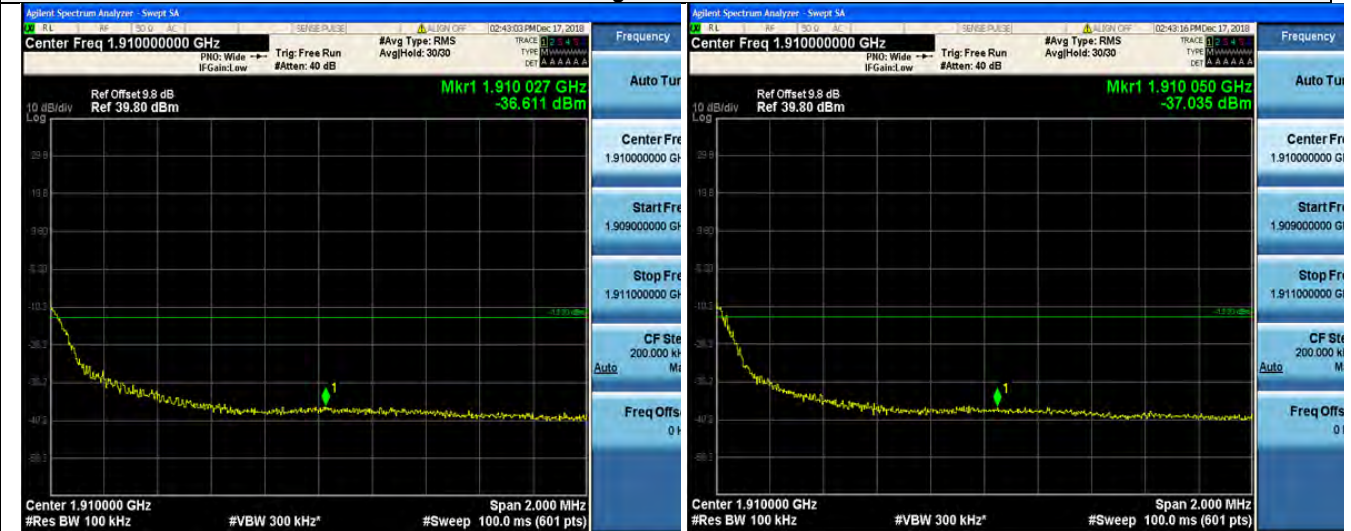

100RB#0

100RB#0

4.5 Spurious Emission on Antenna Port

LIMIT

Per FCC §24.238, the power of any emission outside of the authorized operating frequency ranges must be attenuated below the transmitting power (P) by a factor of at least $43 + 10\log(P)$ dB.

TEST CONFIGURATION

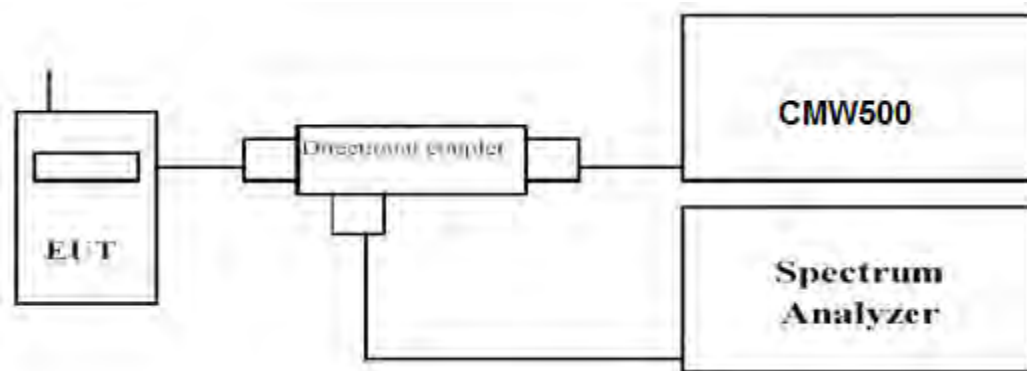

TEST PROCEDURE

The EUT was setup according to EIA/TIA 603D

- Place the EUT on a bench and set it in transmitting mode.
- Connect a low loss RF cable from the antenna port to a spectrum analyzer and CMW500 by a Directional Couple.
- EUT Communicate with CMW500, then select a channel for testing.
- Add a correction factor to the display of spectrum, and then test.
- The resolution bandwidth of the spectrum analyzer was set sufficient scans were taken to show the out of band Emission if any up to 10th harmonic.
- Please refer to following tables for test antenna conducted emissions.

Working Frequency	Sub range (GHz)	RBW	VBW	Sweep time (s)
LTE FDD Band 2	0.01~20	1 MHz	3 MHz	Auto

TEST RESULTS

Remark:

- We were tested all RB Configuration refer 3GPP TS136 521 for each Channel Bandwidth of LTE FDD Band 2; recorded worst case at the QPSK Mode for each Channel Bandwidth of LTE FDD Band 2

LTE FDD Band 2-1.4MHz Channel Bandwidth

Low Channel

QPSK

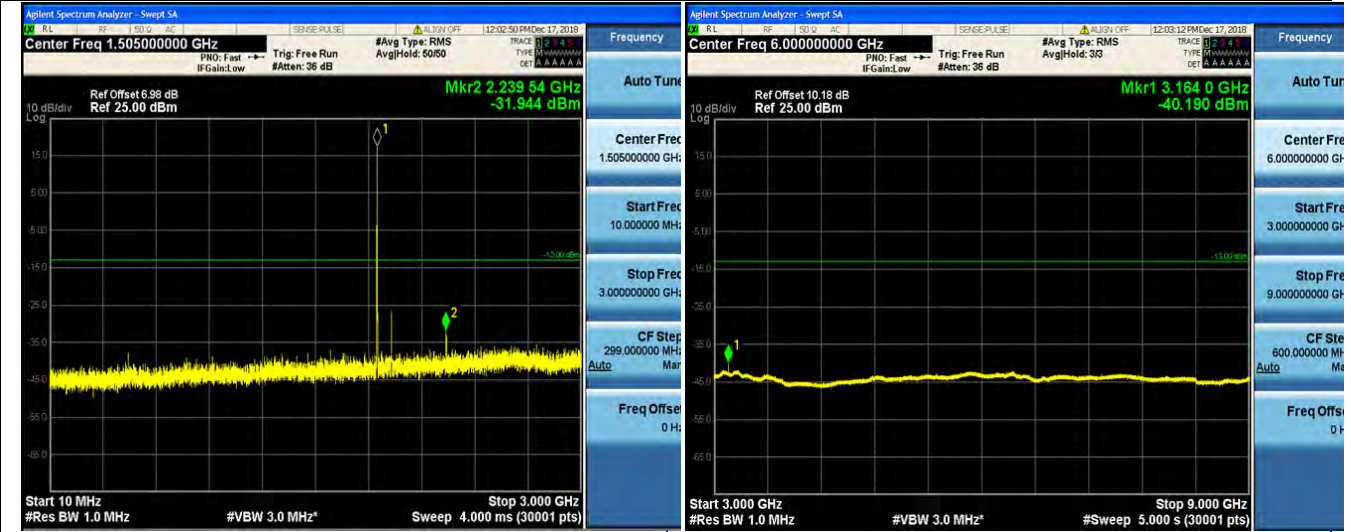

LTE FDD Band 2-1.4MHz Channel Bandwidth
Middle Channel
QPSK



10MHz~3GHz

3GHz~9GHz



9 GHz~15 GHz

15 GHz~20GHz

LTE FDD Band 2-1.4MHz Channel Bandwidth
High Channel
QPSK

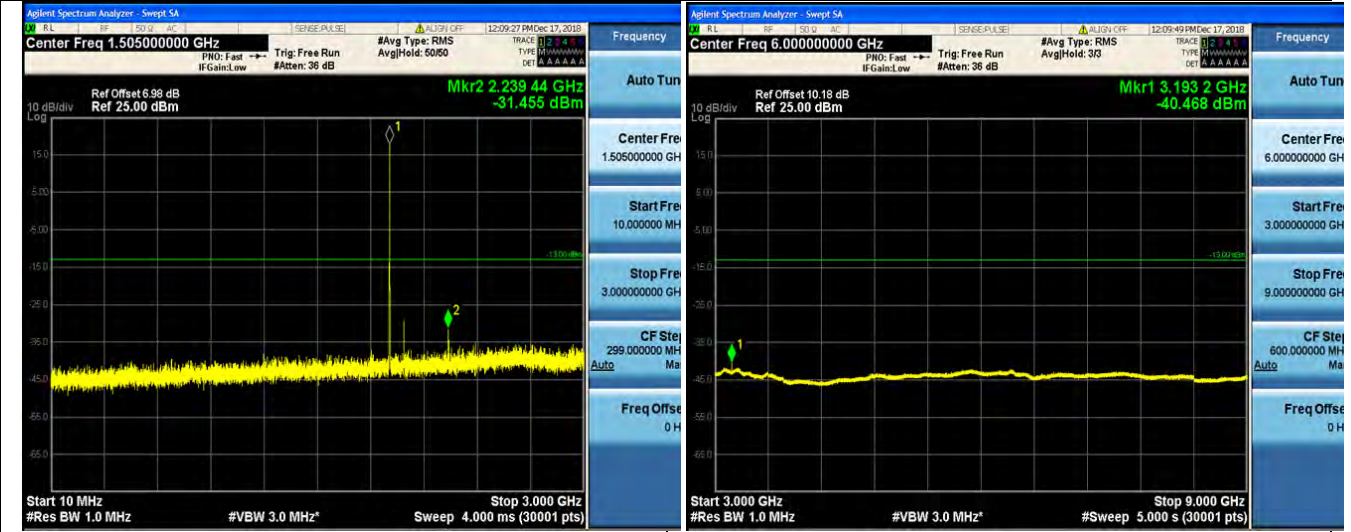

10MHz~3GHz

3GHz~9GHz



9 GHz ~15 GHz

15 GHz ~20GHz

LTE FDD Band 2-3MHz Channel Bandwidth

Low Channel

QPSK

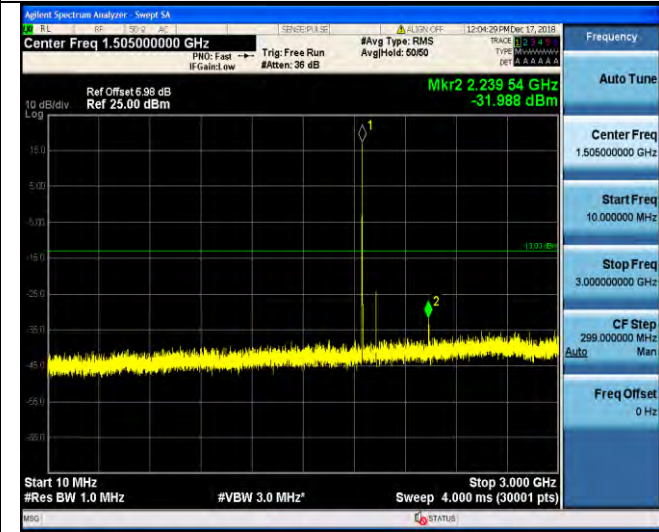

10MHz~3GHz

3GHz~9GHz



9 GHz~15 GHz

15 GHz~20GHz

LTE FDD Band 2-3MHz Channel Bandwidth
Middle Channel
QPSK

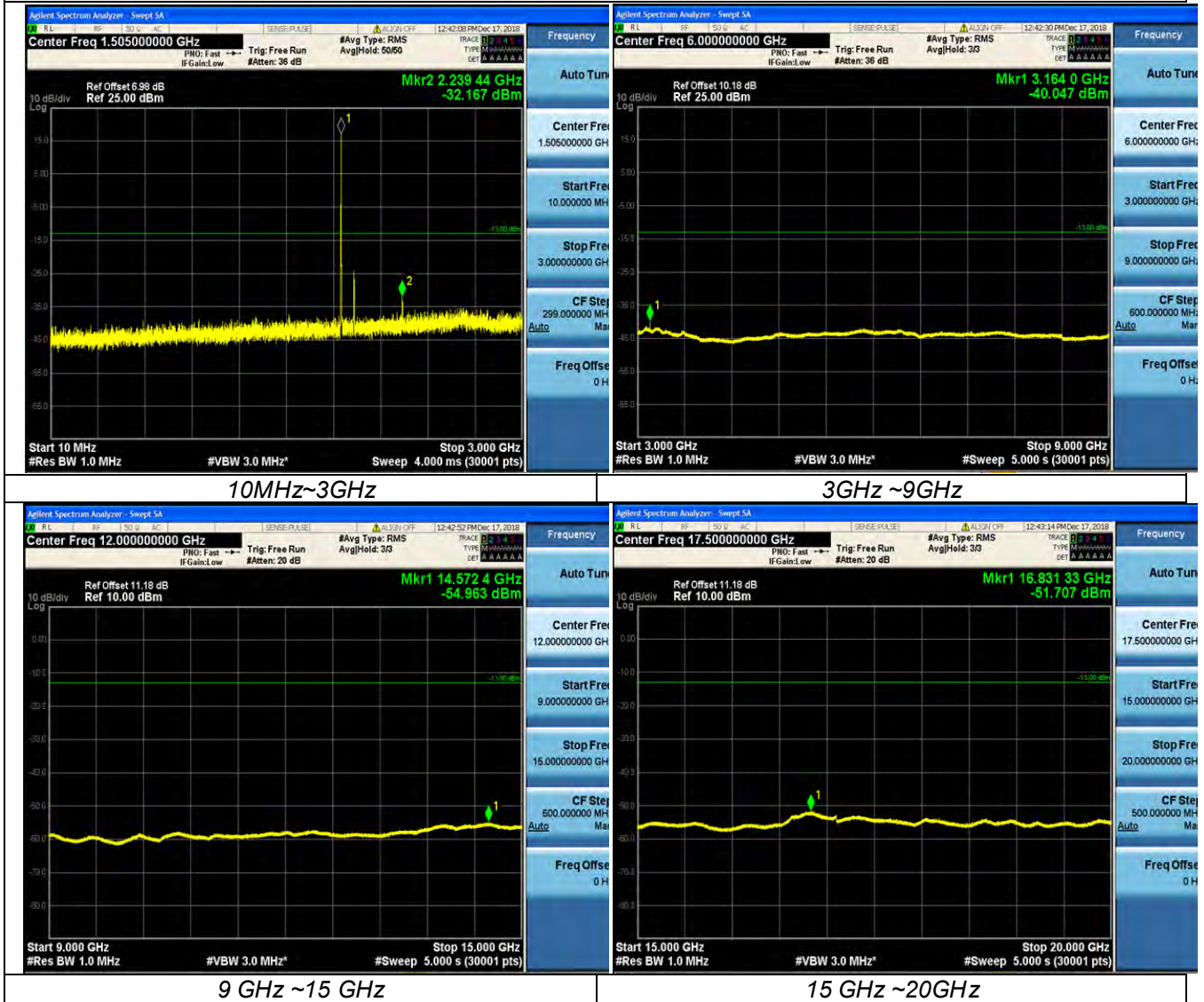

LTE FDD Band 2-3MHz Channel Bandwidth
High Channel
QPSK

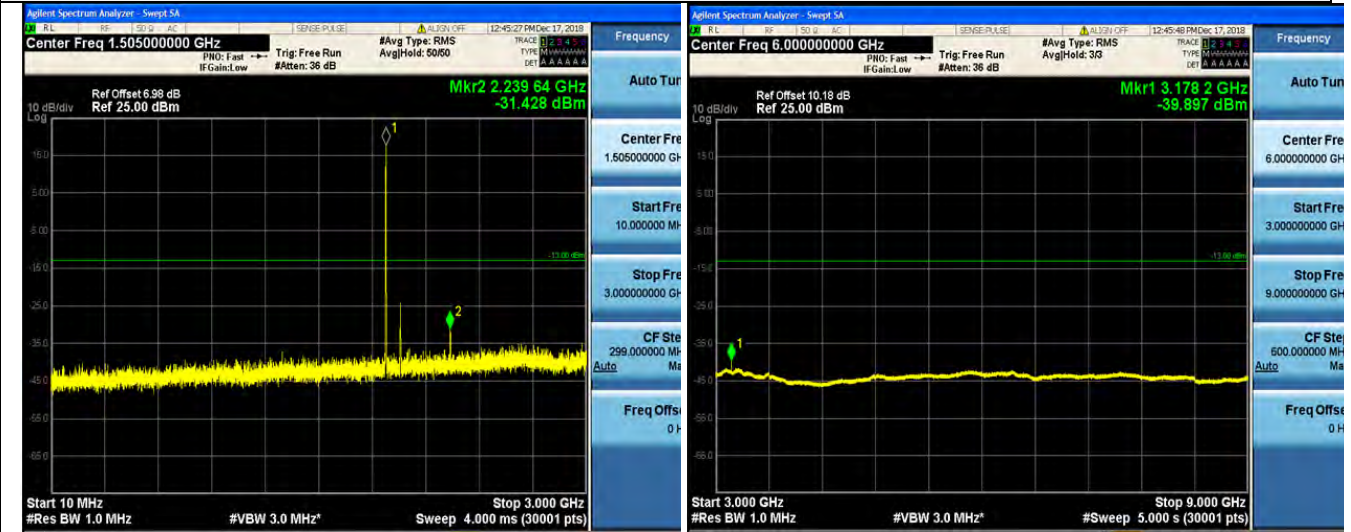

10MHz~3GHz

3GHz~9GHz



9 GHz~15 GHz

15 GHz~20GHz

LTE FDD Band 2-5 MHz Channel Bandwidth

Low Channel

QPSK

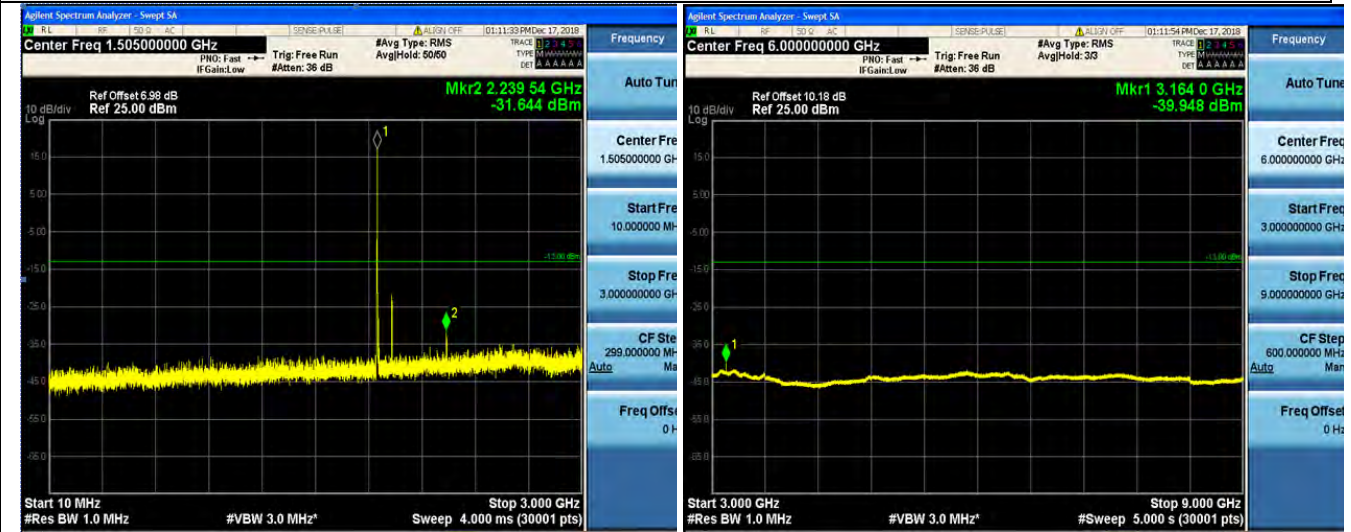

LTE FDD Band 2-5 MHz Channel Bandwidth
Middle Channel
QPSK

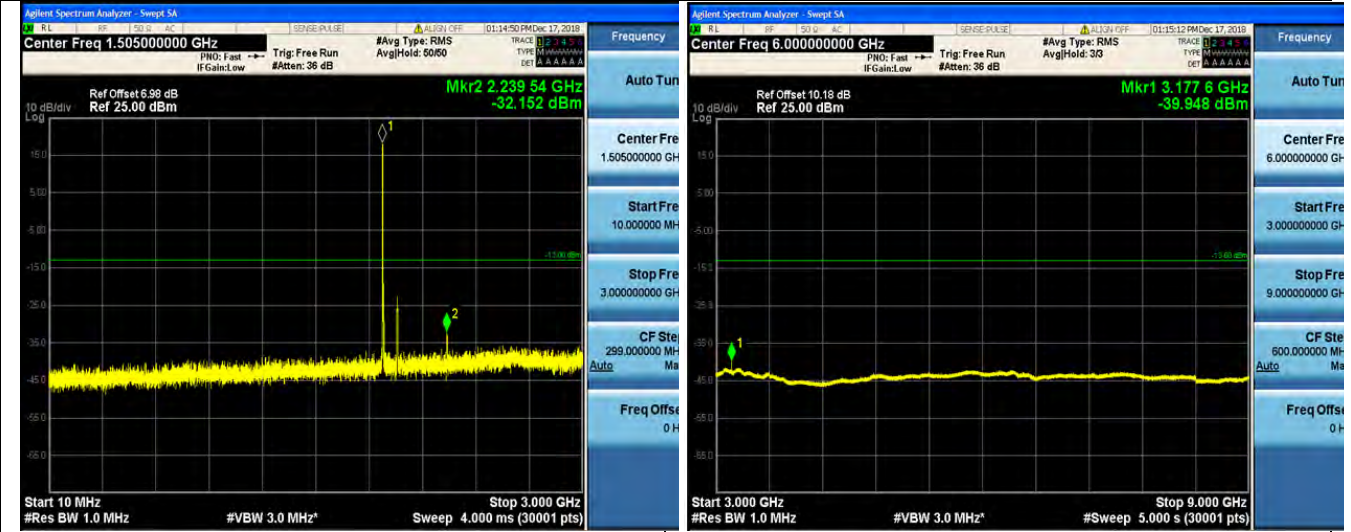

10MHz~3GHz

3GHz~9GHz

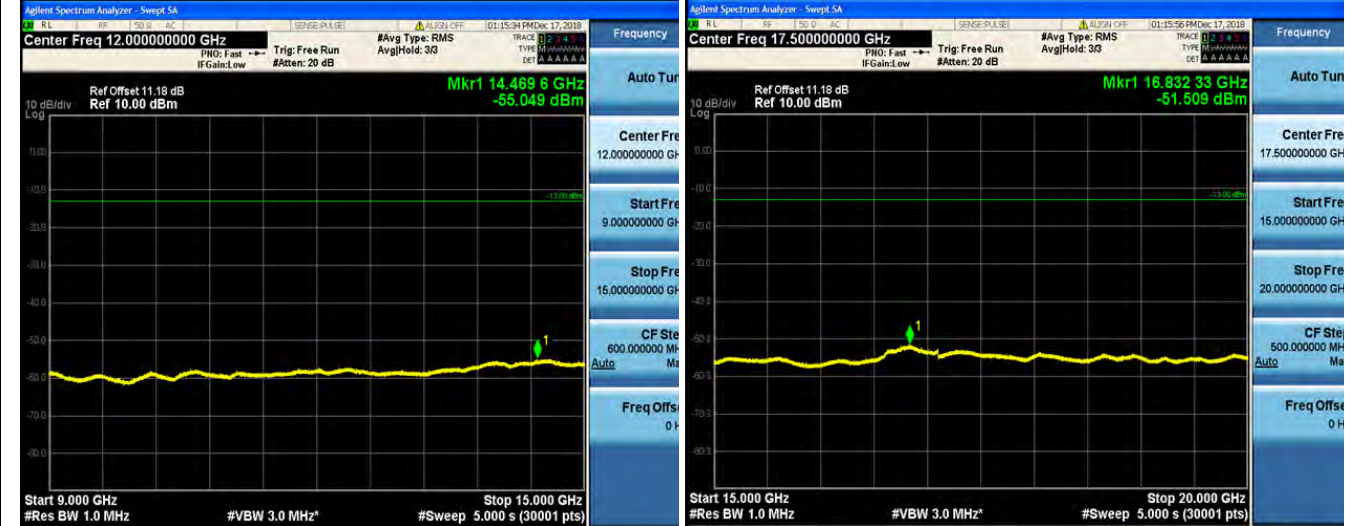

9 GHz~15 GHz

15 GHz~20GHz

LTE FDD Band 2-5 MHz Channel Bandwidth
High Channel
QPSK



10MHz~3GHz

3GHz~9GHz



9 GHz~15 GHz

15 GHz~20GHz

LTE FDD Band 2-10 MHz Channel Bandwidth
 Low Channel
 QPSK

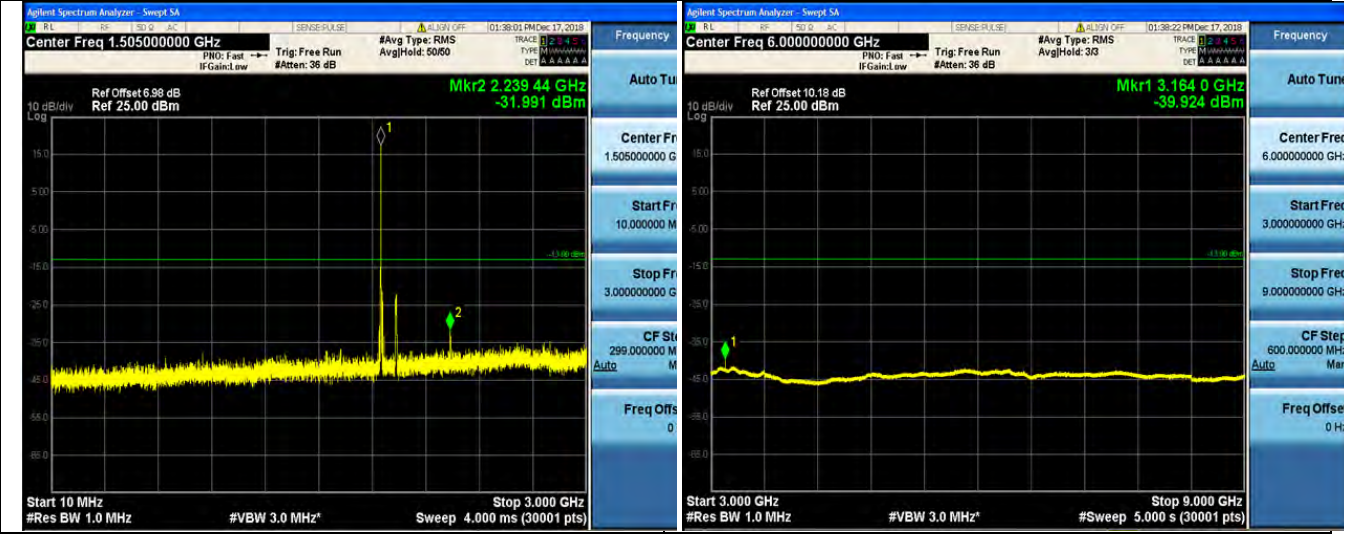

10MHz~3GHz

3GHz ~9GHz



9 GHz ~15 GHz

15 GHz ~20GHz

LTE FDD Band 2-10 MHz Channel Bandwidth
Middle Channel
QPSK

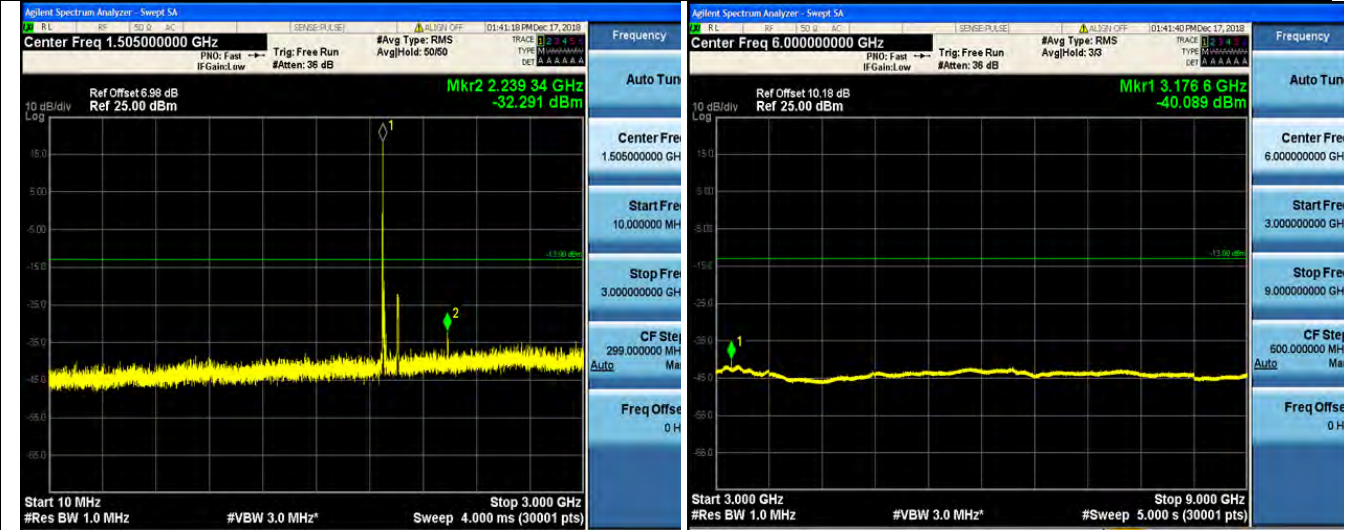

10MHz~3GHz

3GHz~9GHz



9 GHz~15 GHz

15 GHz~20GHz

LTE FDD Band 2-10 MHz Channel Bandwidth
High Channel
QPSK

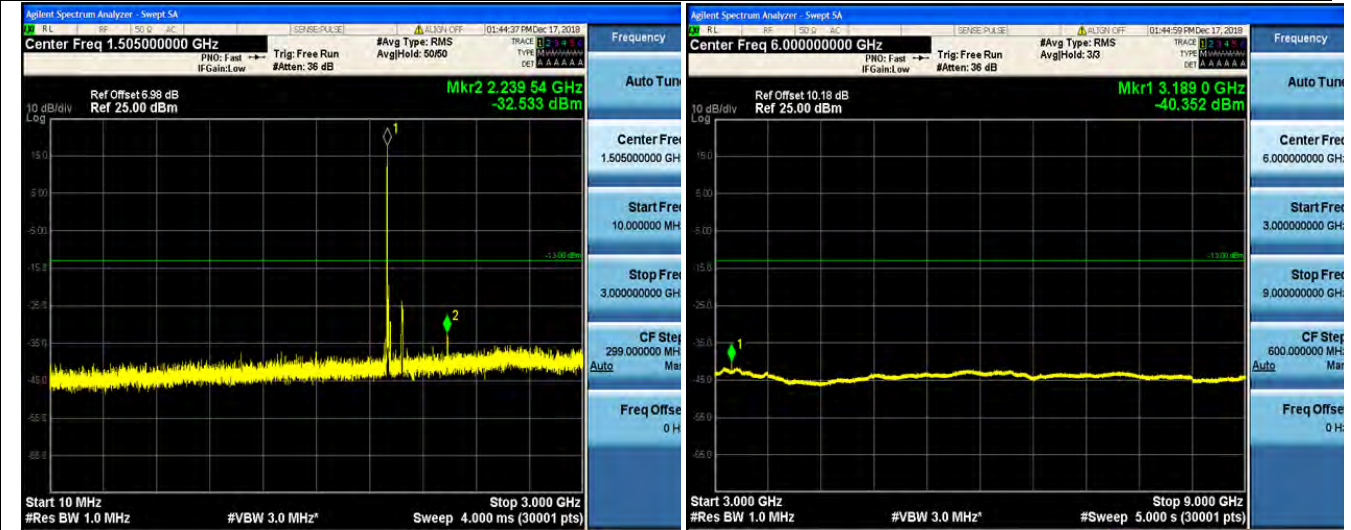

10MHz~3GHz

3GHz~9GHz



9 GHz~15 GHz

15 GHz~20GHz

LTE FDD Band 2-15 MHz Channel Bandwidth

Low Channel

QPSK

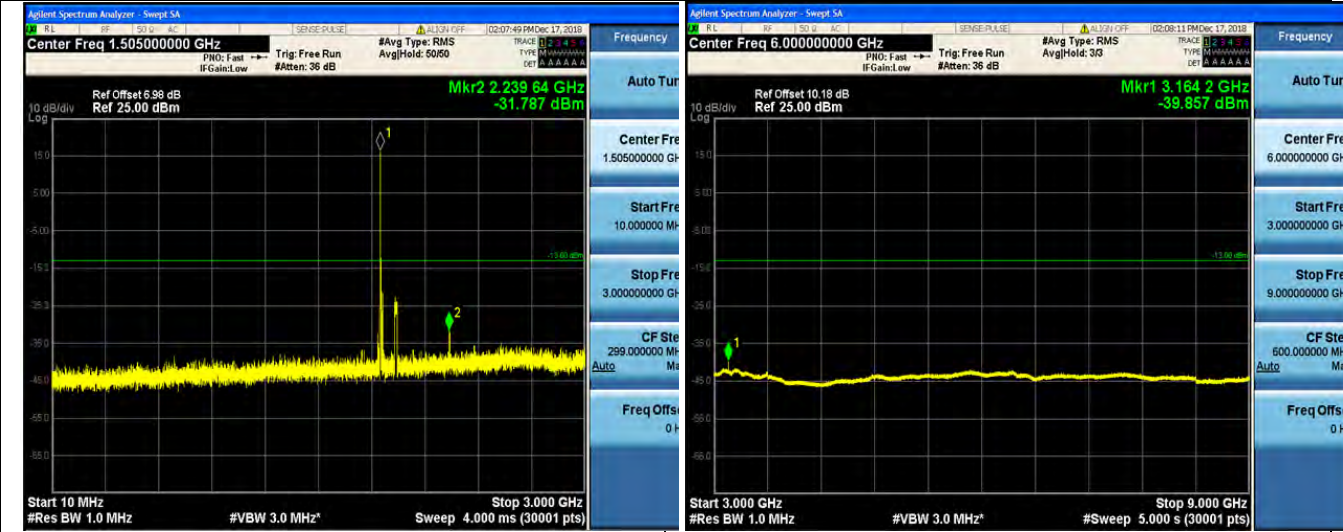

10MHz~3GHz

3GHz~9GHz



9 GHz~15 GHz

15 GHz~20GHz

LTE FDD Band 2-15 MHz Channel Bandwidth
Middle Channel
QPSK

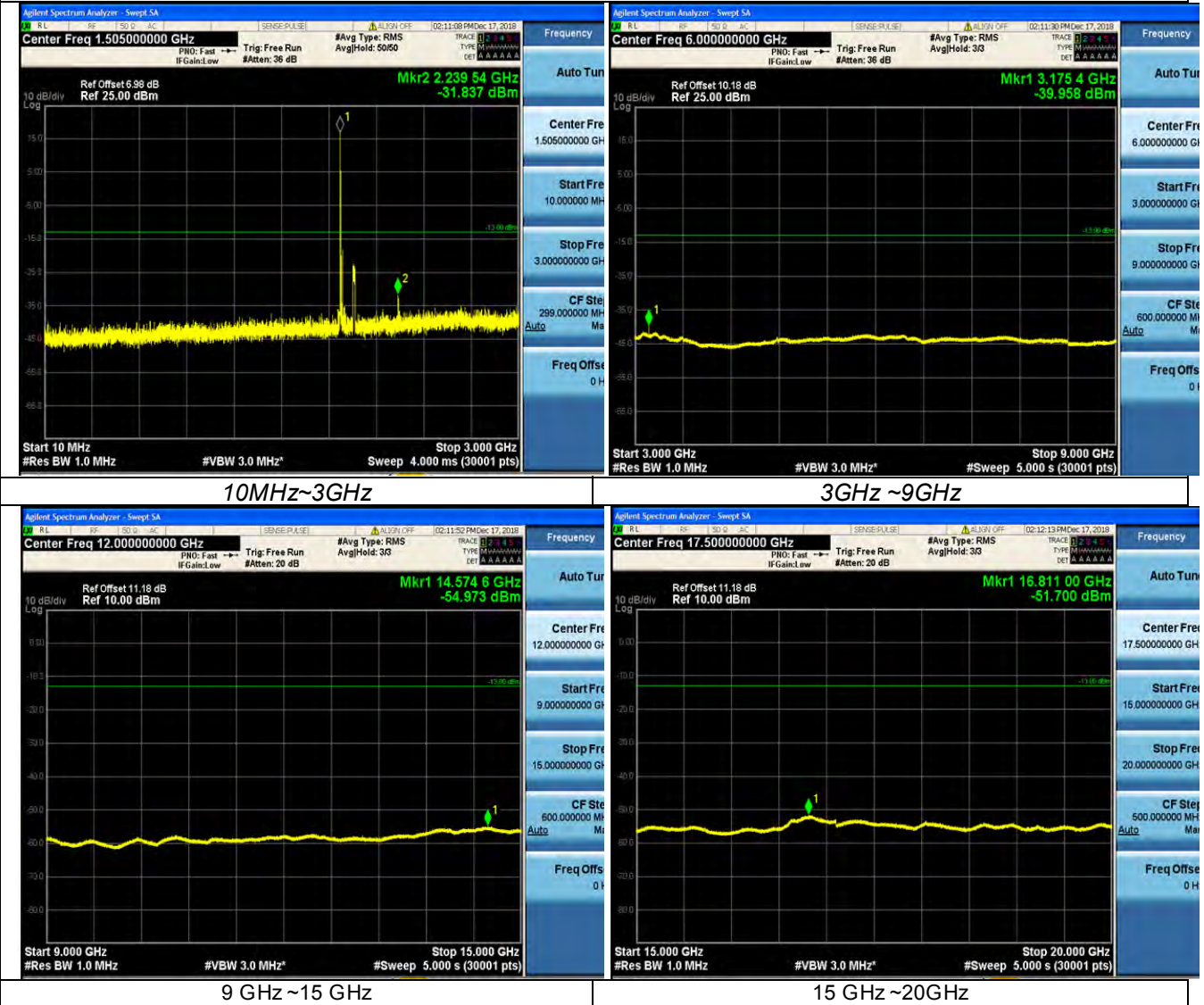

LTE FDD Band 2-15 MHz Channel Bandwidth
High Channel
QPSK

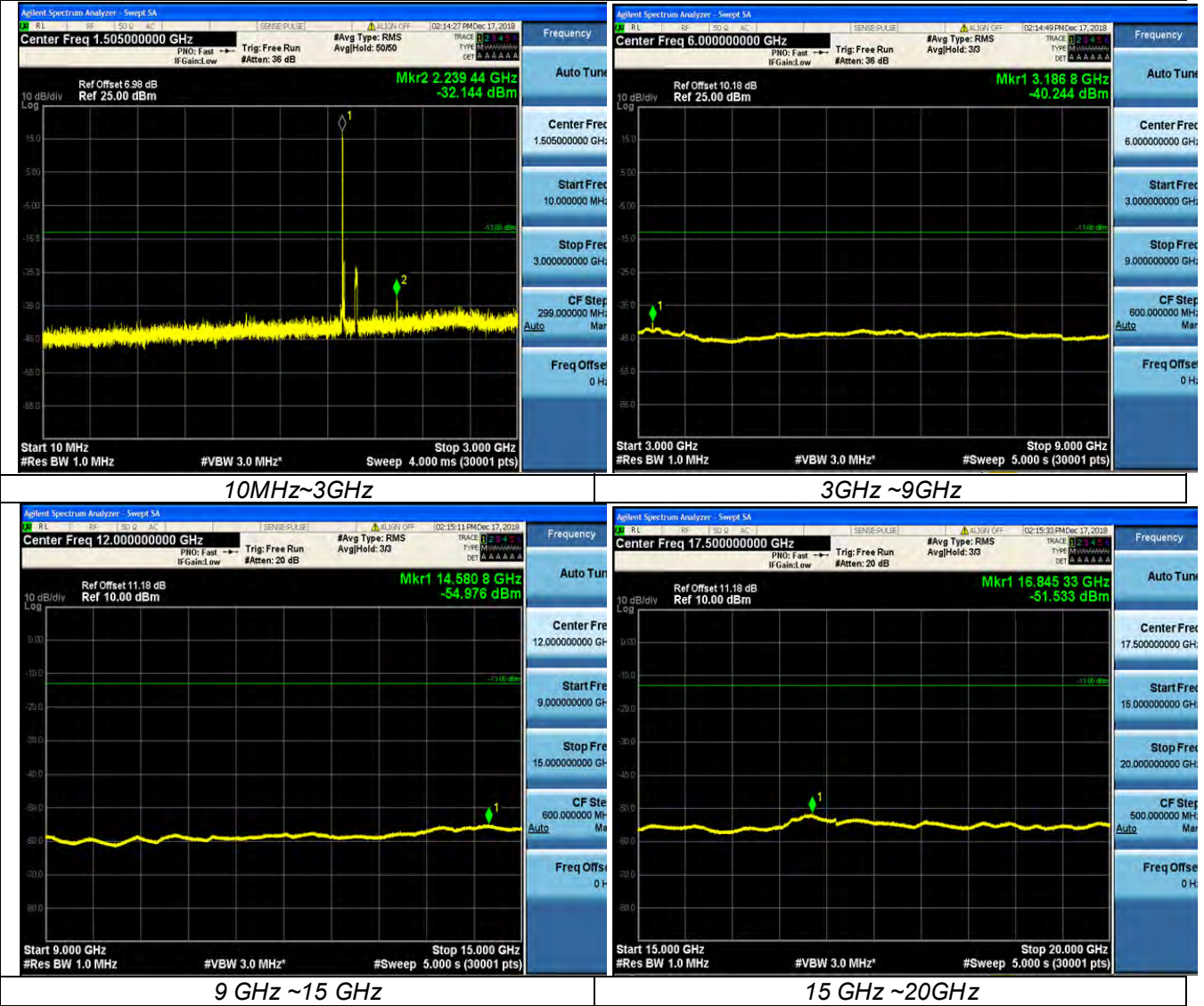

LTE FDD Band 2-20 MHz Channel Bandwidth
Low Channel
QPSK

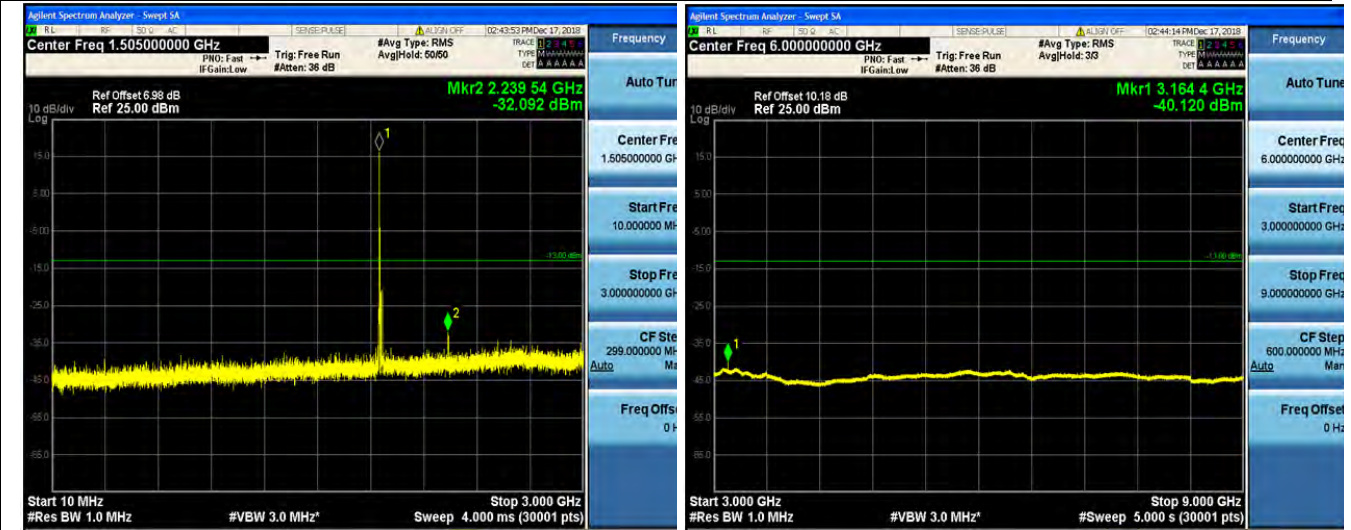

10MHz~3GHz

3GHz~9GHz



9 GHz~15 GHz

15 GHz~20GHz

LTE FDD Band 2-20 MHz Channel Bandwidth
Middle Channel
QPSK

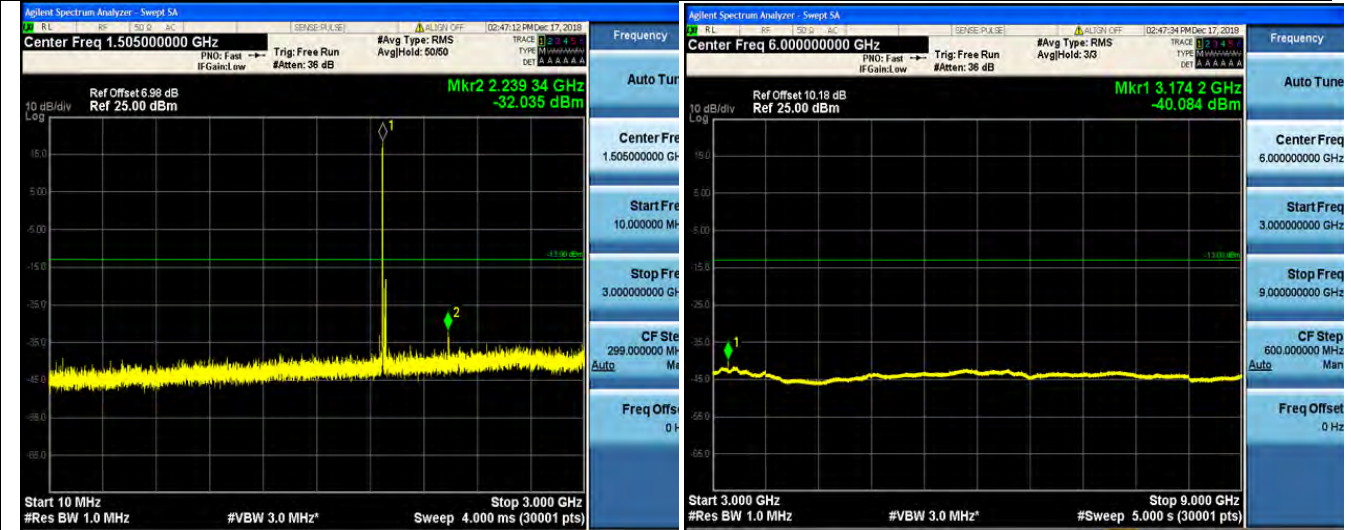

10MHz~3GHz

3GHz~9GHz



9 GHz~15 GHz

15 GHz~20GHz

LTE FDD Band 2-20 MHz Channel Bandwidth
High Channel
QPSK

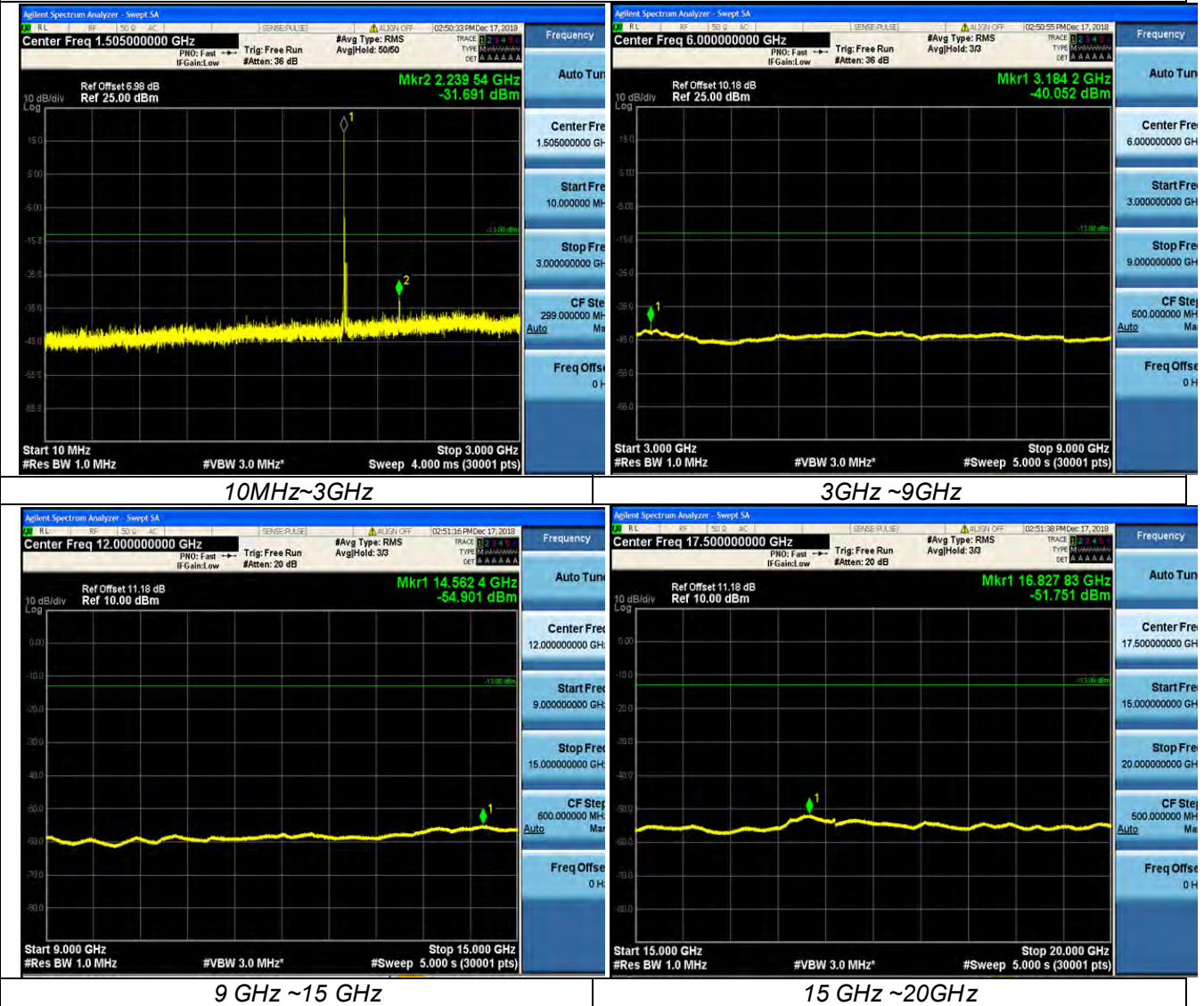

4.6 Radiated Spurious Emission

TEST APPLICABLE

Per FCC §24.238, the power of any emission outside of the authorized operating frequency ranges must be attenuated below the transmitting power (P) by a factor of at least $43 + 10\log(P)$ dB.

TEST CONFIGURATION

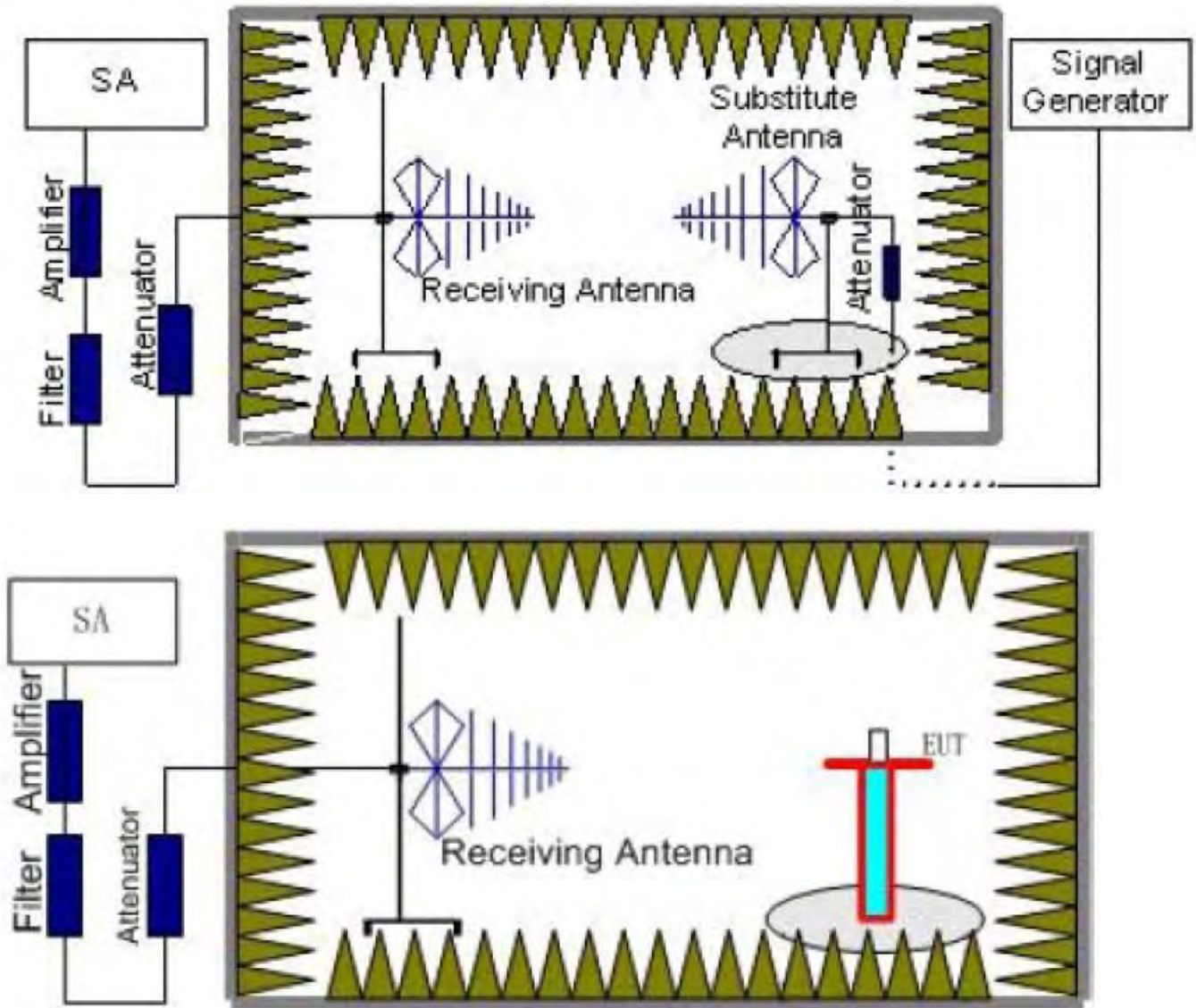

TEST PROCEDURE

1. EUT was placed on a 1.50 meter high non-conductive stand at a 3 meter test distance from the receive antenna. A receiving antenna was placed on the antenna mast 3 meters from the EUT for emission measurements. The height of receiving antenna is 1.50m. Detected emissions were maximized at each frequency by rotating the EUT through 360° and adjusting the receiving antenna polarization. The radiated emission measurements of all transmit frequencies in three channels (High, Middle, Low) were measured with peak detector.
2. A log-periodic antenna or double-ridged waveguide horn antenna shall be substituted in place of the EUT. The log-periodic antenna will be driven by a signal generator and the level will be adjusted till the same power value on the spectrum analyzer or receiver. The level of the spurious emissions can be calculated through the level of the signal generator, cable loss, the gain of the substitution antenna and the reading of the spectrum analyzer or receiver.

3. The EUT is then put into continuously transmitting mode at its maximum power level during the test. Set Test Receiver or Spectrum RBW=1MHz, VBW=3MHz, And the maximum value of the receiver should be recorded as (P_r).
4. The EUT shall be replaced by a substitution antenna. In the chamber, a substitution antenna for the frequency band of interest is placed at the reference point of the chamber. An RF Signal source for the frequency band of interest is connected to the substitution antenna with a cable that has been constructed to not interfere with the radiation pattern of the antenna. A power (P_{Mea}) is applied to the input of the substitution antenna, and adjust the level of the signal generator output until the value of the receiver reach the previously recorded (P_r). The power of signal source (P_{Mea}) is recorded. The test should be performed by rotating the test item and adjusting the receiving antenna polarization.
5. A amplifier should be connected to the Signal Source output port. And the cable should be connect between the Amplifier and the Substitution Antenna. The cable loss (P_{cl}), the Substitution Antenna Gain (G_a) and the Amplifier Gain (P_{Ag}) should be recorded after test.
The measurement results are obtained as described below:
 $Power(EIRP) = P_{Mea} - P_{Ag} - P_{cl} + G_a$
6. This value is EIRP since the measurement is calibrated using an antenna of known gain (2.15 dBi) and known input power.
7. ERP can be calculated from EIRP by subtracting the gain of the dipole, $ERP = EIRP - 2.15dBi$.
8. In order to make sure test results more clearly, we set frequency range and sweep time for difference frequency range as follows table:

Working Frequency	Subrange (GHz)	RBW	VBW	Sweep time (s)
LTE FDD Band 2	0.03~1	100KHz	300KHz	10
	1~20	1 MHz	3 MHz	2

TEST LIMITS

According to 24.238 specify that the power of any emission outside of the authorized operating frequency ranges must be attenuated below the transmitting power (P) by a factor of at least $43 + 10 \log(P)$ dB. The specification that emissions shall be attenuated below the transmitter power (P) by at least $43 + 10 \log(P)$ dB, translates in the relevant power range (1 to 0.001 W) to -13 dBm. At 1 W the specified minimum attenuation becomes 43 dB and relative to a 30 dBm (1 W) carrier becomes a limit of -13 dBm. At 0.001 W (0 dBm) the minimum attenuation is 13 dB, which again yields a limit of -13 dBm. In this way a translation of the specification from relative to absolute terms is carried out.

Frequency	Channel	Frequency Range	Verdict
LTE FDD Band 2	Low	30MHz -20GHz	PASS
	Middle	30MHz -20GHz	PASS
	High	30MHz -20GHz	PASS

Radiated Measurement:

Remark:

1. We measured all RB Configuration refer 3GPP TS136 521 for each Channel Bandwidth of LTE FDD Band 2; recorded worst case for each Channel Bandwidth of LTE FDD Band 2.
2. $EIRP = P_{Mea}(dBm) - P_{cl}(dB) + G_a(dBi)$
3. Not recorded other points as values lower than limits.
4. $Margin = Limit - EIRP$

LTE FDD Band 2_Channel Bandwidth 1.4MHz_QPSK_Low Channel

Frequency (MHz)	P _{Mea} (dBm)	P _{cl} (dB)	Diatance	G _a Antenna Gain(dB)	Peak EIRP (dBm)	Limit (dBm)	Margin (dB)	Polarization
3701.4	-44.43	4.39	3.00	12.34	-36.48	-13.00	23.48	H
5552.1	-50.51	5.31	3.00	13.52	-42.30	-13.00	29.30	H
3701.4	-50.87	4.39	3.00	12.34	-42.92	-13.00	29.92	V
5552.1	-54.64	5.31	3.00	13.52	-46.43	-13.00	33.43	V

LTE FDD Band 2_Channel Bandwidth 1.4MHz_QPSK_Middle Channel

Frequency (MHz)	P _{Mea} (dBm)	P _{cl} (dB)	Diatance	G _a Antenna Gain(dB)	Peak EIRP (dBm)	Limit (dBm)	Margin (dB)	Polarization
3760.0	-41.89	4.41	3.00	12.34	-33.96	-13.00	20.96	H
5640.0	-48.96	5.38	3.00	13.58	-40.76	-13.00	27.76	H
3760.0	-42.26	4.41	3.00	12.34	-34.33	-13.00	21.33	V
5640.0	-46.09	5.38	3.00	13.58	-37.89	-13.00	24.89	V

LTE FDD Band 2_Channel Bandwidth 1.4MHz_QPSK_High Channel

Frequency (MHz)	P _{Mea} (dBm)	P _{cl} (dB)	Diatance	G _a Antenna Gain(dB)	Peak EIRP (dBm)	Limit (dBm)	Margin (dB)	Polarization
3806.6	-43.92	4.45	3.00	12.45	-35.92	-13.00	22.92	H
5709.9	-48.02	5.47	3.00	13.66	-39.83	-13.00	26.83	H
3806.6	-45.74	4.45	3.00	12.45	-37.74	-13.00	24.74	V
5709.9	-50.51	5.48	3.00	13.66	-42.33	-13.00	29.33	V

LTE FDD Band 2_Channel Bandwidth 3MHz_QPSK_Low Channel

Frequency (MHz)	P _{Mea} (dBm)	P _{cl} (dB)	Diatance	G _a Antenna Gain(dB)	Peak EIRP (dBm)	Limit (dBm)	Margin (dB)	Polarization
3703.0	-45.52	4.39	3.00	12.34	-37.57	-13.00	24.57	H
5554.5	-49.44	5.31	3.00	13.52	-41.23	-13.00	28.23	H
3703.0	-40.61	4.39	3.00	12.34	-32.66	-13.00	19.66	V
5554.5	-51.29	5.31	3.00	13.52	-43.08	-13.00	30.08	V

LTE FDD Band 2_Channel Bandwidth 3MHz_QPSK_Middle Channel

Frequency (MHz)	P _{Mea} (dBm)	P _{cl} (dB)	Diatance	G _a Antenna Gain(dB)	Peak EIRP (dBm)	Limit (dBm)	Margin (dB)	Polarization
3760.0	-44.15	4.41	3.00	12.34	-36.22	-13.00	23.22	H
5640.0	-50.39	5.38	3.00	13.58	-42.19	-13.00	29.19	H
3760.0	-42.84	4.41	3.00	12.34	-34.91	-13.00	21.91	V
5640.0	-51.55	5.38	3.00	13.58	-43.35	-13.00	30.35	V

LTE FDD Band 2_Channel Bandwidth 3MHz_QPSK_High Channel

Frequency (MHz)	P _{Mea} (dBm)	P _{cl} (dB)	Diatance	G _a Antenna Gain(dB)	Peak EIRP (dBm)	Limit (dBm)	Margin (dB)	Polarization
3817.0	-45.46	4.45	3.00	12.45	-37.46	-13.00	24.46	H
5725.5	-48.53	5.47	3.00	13.66	-40.34	-13.00	27.34	H
3817.0	-45.39	4.45	3.00	12.45	-37.39	-13.00	24.39	V
5725.5	-50.82	5.48	3.00	13.66	-42.64	-13.00	29.64	V

LTE FDD Band 2_Channel Bandwidth 5MHz_QPSK_LowChannel

Frequency (MHz)	PMea (dBm)	Pcl (dB)	Diatance	Ga Antenna Gain(dB)	Peak EIRP (dBm)	Limit (dBm)	Margin (dB)	Polarization
3705.0	-45.44	4.39	3.00	12.34	-37.49	-13.00	24.49	H
5557.5	-50.09	5.31	3.00	13.52	-41.88	-13.00	28.88	H
3705.0	-44.25	4.39	3.00	12.34	-36.30	-13.00	23.30	V
5557.5	-51.23	5.31	3.00	13.52	-43.02	-13.00	30.02	V

LTE FDD Band 2_Channel Bandwidth 5MHz_QPSK_Middle Channel

Frequency (MHz)	PMea (dBm)	Pcl (dB)	Diatance	Ga Antenna Gain(dB)	Peak EIRP (dBm)	Limit (dBm)	Margin (dB)	Polarization
3760.0	-44.42	4.41	3.00	12.34	-36.49	-13.00	23.49	H
5640.0	-51.86	5.38	3.00	13.58	-43.66	-13.00	30.66	H
3760.0	-43.54	4.41	3.00	12.34	-35.61	-13.00	22.61	V
5640.0	-53.78	5.38	3.00	13.58	-45.58	-13.00	32.58	V

LTE FDD Band 2_Channel Bandwidth 5MHz_QPSK_High Channel

Frequency (MHz)	PMea (dBm)	Pcl (dB)	Diatance	Ga Antenna Gain(dB)	Peak EIRP (dBm)	Limit (dBm)	Margin (dB)	Polarization
3815.0	-45.84	4.45	3.00	12.45	-37.84	-13.00	24.84	H
5722.5	-49.45	5.47	3.00	13.66	-41.26	-13.00	28.26	H
3815.0	-44.54	4.45	3.00	12.45	-36.54	-13.00	23.54	V
5722.5	-52.15	5.48	3.00	13.66	-43.97	-13.00	30.97	V

LTE FDD Band 2_Channel Bandwidth 10MHz_QPSK_LowChannel

Frequency (MHz)	PMea (dBm)	Pcl (dB)	Diatance	Ga Antenna Gain(dB)	Peak EIRP (dBm)	Limit (dBm)	Margin (dB)	Polarization
3710.0	-42.38	4.39	3.00	12.34	-34.43	-13.00	21.43	H
5565.0	-49.88	5.31	3.00	13.52	-41.67	-13.00	28.67	H
3710.0	-43.77	4.39	3.00	12.34	-35.82	-13.00	22.82	V
5565.0	-53.17	5.31	3.00	13.52	-44.96	-13.00	31.96	V

LTE FDD Band 2_Channel Bandwidth 10MHz_QPSK_Middle Channel

Frequency (MHz)	PMea (dBm)	Pcl (dB)	Diatance	Ga Antenna Gain(dB)	Peak EIRP (dBm)	Limit (dBm)	Margin (dB)	Polarization
3760.0	-41.17	4.41	3.00	12.34	-33.24	-13.00	20.24	H
5640.0	-50.48	5.38	3.00	13.58	-42.28	-13.00	29.28	H
3760.0	-44.04	4.41	3.00	12.34	-36.11	-13.00	23.11	V
5640.0	-51.37	5.38	3.00	13.58	-43.17	-13.00	30.17	V

LTE FDD Band 2_Channel Bandwidth 10MHz_QPSK_High Channel

Frequency (MHz)	PMea (dBm)	Pcl (dB)	Diatance	Ga Antenna Gain(dB)	Peak EIRP (dBm)	Limit (dBm)	Margin (dB)	Polarization
3810.0	-46.16	4.45	3.00	12.45	-38.16	-13.00	25.16	H
5715.0	-52.13	5.47	3.00	13.66	-43.94	-13.00	30.94	H
3810.0	-43.43	4.45	3.00	12.45	-35.43	-13.00	22.43	V
5715.0	-52.59	5.48	3.00	13.66	-44.41	-13.00	31.41	V

LTE FDD Band 2_Channel Bandwidth 15MHz_QPSK_LowChannel

Frequency (MHz)	PMea (dBm)	Pcl (dB)	Diatance	Ga Antenna Gain(dB)	Peak EIRP (dBm)	Limit (dBm)	Margin (dB)	Polarization
3715.0	-44.28	4.39	3.00	12.34	-36.33	-13.00	23.33	H
5572.5	-49.87	5.31	3.00	13.52	-41.66	-13.00	28.66	H
3715.0	-44.98	4.39	3.00	12.34	-37.03	-13.00	24.03	V
5572.5	-51.15	5.31	3.00	13.52	-42.94	-13.00	29.94	V

LTE FDD Band 2_Channel Bandwidth 15MHz_QPSK_Middle Channel

Frequency (MHz)	PMea (dBm)	Pcl (dB)	Diatance	Ga Antenna Gain(dB)	Peak EIRP (dBm)	Limit (dBm)	Margin (dB)	Polarization
3760.0	-40.93	4.41	3.00	12.34	-33.00	-13.00	20.00	H
5640.0	-51.88	5.38	3.00	13.58	-43.68	-13.00	30.68	H
3760.0	-37.43	4.41	3.00	12.34	-29.50	-13.00	16.50	V
5640.0	-55.17	5.38	3.00	13.58	-46.97	-13.00	33.97	V

LTE FDD Band 2_Channel Bandwidth 15MHz_QPSK_High Channel

Frequency (MHz)	PMea (dBm)	Pcl (dB)	Diatance	Ga Antenna Gain(dB)	Peak EIRP (dBm)	Limit (dBm)	Margin (dB)	Polarization
3805.0	-43.31	4.45	3.00	12.45	-35.31	-13.00	22.31	H
5707.5	-50.89	5.47	3.00	13.66	-42.70	-13.00	29.70	H
3805.0	-41.72	4.45	3.00	12.45	-33.72	-13.00	20.72	V
5707.5	-54.57	5.48	3.00	13.66	-46.39	-13.00	33.39	V

LTE FDD Band 2_Channel Bandwidth 20MHz_QPSK_LowChannel

Frequency (MHz)	PMea (dBm)	Pcl (dB)	Diatance	Ga Antenna Gain(dB)	Peak EIRP (dBm)	Limit (dBm)	Margin (dB)	Polarization
3715.0	-42.54	4.39	3.00	12.34	-34.59	-13.00	21.59	H
5572.5	-50.16	5.31	3.00	13.52	-41.95	-13.00	28.95	H
3715.0	-43.16	4.39	3.00	12.34	-35.21	-13.00	22.21	V
5572.5	-52.96	5.31	3.00	13.52	-44.75	-13.00	31.75	V

LTE FDD Band 2_Channel Bandwidth 20MHz_QPSK_Middle Channel

Frequency (MHz)	PMea (dBm)	Pcl (dB)	Diatance	Ga Antenna Gain(dB)	Peak EIRP (dBm)	Limit (dBm)	Margin (dB)	Polarization
3720.0	-42.76	4.41	3.00	12.34	-34.83	-13.00	21.83	H
5580.0	-49.82	5.38	3.00	13.58	-41.62	-13.00	28.62	H
3720.0	-44.89	4.41	3.00	12.34	-36.96	-13.00	23.96	V
5580.0	-50.44	5.38	3.00	13.58	-42.24	-13.00	29.24	V

LTE FDD Band 2_Channel Bandwidth 20MHz_QPSK_High Channel

Frequency (MHz)	PMea (dBm)	Pcl (dB)	Diatance	Ga Antenna Gain(dB)	Peak EIRP (dBm)	Limit (dBm)	Margin (dB)	Polarization
3800.0	-46.57	4.45	3.00	12.45	-38.57	-13.00	25.57	H
5700.0	-50.74	5.47	3.00	13.66	-42.55	-13.00	29.55	H
3800.0	-50.83	4.45	3.00	12.45	-42.83	-13.00	29.83	V
5700.0	-57.63	5.48	3.00	13.66	-49.45	-13.00	36.45	V

LTE FDD Band 2_Channel Bandwidth 1.4MHz_16QAM_Low Channel

Frequency (MHz)	PMea (dBm)	Pcl (dB)	Diatance	Ga Antenna Gain(dB)	Peak EIRP (dBm)	Limit (dBm)	Margin (dB)	Polarization
3701.4	-40.64	4.39	3.00	12.34	-32.69	-13.00	19.69	H
5552.1	-55.17	5.31	3.00	13.52	-46.96	-13.00	33.96	H
3701.4	-38.29	4.39	3.00	12.34	-30.34	-13.00	17.34	V
5552.1	-51.05	5.31	3.00	13.52	-42.84	-13.00	29.84	V

LTE FDD Band 2_Channel Bandwidth 1.4MHz_16QAM_Middle Channel

Frequency (MHz)	PMea (dBm)	Pcl (dB)	Diatance	Ga Antenna Gain(dB)	Peak EIRP (dBm)	Limit (dBm)	Margin (dB)	Polarization
3760.0	-40.05	4.41	3.00	12.34	-32.12	-13.00	19.12	H
5640.0	-47.94	5.38	3.00	13.58	-39.74	-13.00	26.74	H
3760.0	-50.39	4.41	3.00	12.34	-42.46	-13.00	29.46	V
5640.0	-51.24	5.38	3.00	13.58	-43.04	-13.00	30.04	V

LTE FDD Band 2_Channel Bandwidth 1.4MHz_16QAM_High Channel

Frequency (MHz)	PMea (dBm)	Pcl (dB)	Diatance	Ga Antenna Gain(dB)	Peak EIRP (dBm)	Limit (dBm)	Margin (dB)	Polarization
3806.6	-45.66	4.45	3.00	12.45	-37.66	-13.00	24.66	H
5709.9	-49.43	5.47	3.00	13.66	-41.24	-13.00	28.24	H
3806.6	-51.12	4.45	3.00	12.45	-43.12	-13.00	30.12	V
5709.9	-55.31	5.48	3.00	13.66	-47.13	-13.00	34.13	V

LTE FDD Band 2_Channel Bandwidth 3MHz_16QAM_Low Channel

Frequency (MHz)	PMea (dBm)	Pcl (dB)	Diatance	Ga Antenna Gain(dB)	Peak EIRP (dBm)	Limit (dBm)	Margin (dB)	Polarization
3703.0	-46.79	4.39	3.00	12.34	-38.84	-13.00	25.84	H
5554.5	-49.68	5.31	3.00	13.52	-41.47	-13.00	28.47	H
3703.0	-52.11	4.39	3.00	12.34	-44.16	-13.00	31.16	V
5554.5	-55.41	5.31	3.00	13.52	-47.20	-13.00	34.20	V

LTE FDD Band 2_Channel Bandwidth 3MHz_16QAM_Middle Channel

Frequency (MHz)	PMea (dBm)	Pcl (dB)	Diatance	Ga Antenna Gain(dB)	Peak EIRP (dBm)	Limit (dBm)	Margin (dB)	Polarization
3760.0	-42.92	4.41	3.00	12.34	-34.99	-13.00	21.99	H
5640.0	-47.84	5.38	3.00	13.58	-39.64	-13.00	26.64	H
3760.0	-51.07	4.41	3.00	12.34	-43.14	-13.00	30.14	V
5640.0	-53.89	5.38	3.00	13.58	-45.69	-13.00	32.69	V

LTE FDD Band 2_Channel Bandwidth 3MHz_16QAM_High Channel

Frequency (MHz)	PMea (dBm)	Pcl (dB)	Diatance	Ga Antenna Gain(dB)	Peak EIRP (dBm)	Limit (dBm)	Margin (dB)	Polarization
3817.0	-44.67	4.45	3.00	12.45	-36.67	-13.00	23.67	H
5725.5	-51.61	5.47	3.00	13.66	-43.42	-13.00	30.42	H
3817.0	-49.51	4.45	3.00	12.45	-41.51	-13.00	28.51	V
5725.5	-56.48	5.48	3.00	13.66	-48.30	-13.00	35.30	V

LTE FDD Band 2_Channel Bandwidth 5MHz_16QAM_Low Channel

Frequency (MHz)	PMea (dBm)	Pcl (dB)	Diatance	Ga Antenna Gain(dB)	Peak EIRP (dBm)	Limit (dBm)	Margin (dB)	Polarization
3705.0	-46.78	4.39	3.00	12.34	-38.83	-13.00	25.83	H
5557.5	-51.98	5.31	3.00	13.52	-43.77	-13.00	30.77	H
3705.0	-51.98	4.39	3.00	12.34	-44.03	-13.00	31.03	V
5557.5	-55.07	5.31	3.00	13.52	-46.86	-13.00	33.86	V

LTE FDD Band 2_Channel Bandwidth 5MHz_16QAM_Middle Channel

Frequency (MHz)	PMea (dBm)	Pcl (dB)	Diatance	Ga Antenna Gain(dB)	Peak EIRP (dBm)	Limit (dBm)	Margin (dB)	Polarization
3760.0	-44.15	4.41	3.00	12.34	-36.22	-13.00	23.22	H
5640.0	-48.69	5.38	3.00	13.58	-40.49	-13.00	27.49	H
3760.0	-50.76	4.41	3.00	12.34	-42.83	-13.00	29.83	V
5640.0	-54.03	5.38	3.00	13.58	-45.83	-13.00	32.83	V

LTE FDD Band 2_Channel Bandwidth 5MHz_16QAM_High Channel

Frequency (MHz)	PMea (dBm)	Pcl (dB)	Diatance	Ga Antenna Gain(dB)	Peak EIRP (dBm)	Limit (dBm)	Margin (dB)	Polarization
3815.0	-46.08	4.45	3.00	12.45	-38.08	-13.00	25.08	H
5722.5	-50.15	5.47	3.00	13.66	-41.96	-13.00	28.96	H
3815.0	-50.05	4.45	3.00	12.45	-42.05	-13.00	29.05	V
5722.5	-56.48	5.48	3.00	13.66	-48.30	-13.00	35.30	V

LTE FDD Band 2_Channel Bandwidth 10MHz_16QAM_Low Channel

Frequency (MHz)	PMea (dBm)	Pcl (dB)	Diatance	Ga Antenna Gain(dB)	Peak EIRP (dBm)	Limit (dBm)	Margin (dB)	Polarization
3710.0	-47.68	4.39	3.00	12.34	-39.73	-13.00	26.73	H
5565.0	-50.25	5.31	3.00	13.52	-42.04	-13.00	29.04	H
3710.0	-55.52	4.39	3.00	12.34	-47.57	-13.00	34.57	V
5565.0	-57.76	5.31	3.00	13.52	-49.55	-13.00	36.55	V

LTE FDD Band 2_Channel Bandwidth 10MHz_16QAM_Middle Channel

Frequency (MHz)	PMea (dBm)	Pcl (dB)	Diatance	Ga Antenna Gain(dB)	Peak EIRP (dBm)	Limit (dBm)	Margin (dB)	Polarization
3760.0	-41.64	4.41	3.00	12.34	-33.71	-13.00	20.71	H
5640.0	-50.12	5.38	3.00	13.58	-41.92	-13.00	28.92	H
3760.0	-48.86	4.41	3.00	12.34	-40.93	-13.00	27.93	V
5640.0	-53.72	5.38	3.00	13.58	-45.52	-13.00	32.52	V

LTE FDD Band 2_Channel Bandwidth 10MHz_16QAM_High Channel

Frequency (MHz)	PMea (dBm)	Pcl (dB)	Diatance	Ga Antenna Gain(dB)	Peak EIRP (dBm)	Limit (dBm)	Margin (dB)	Polarization
3810.0	-46.25	4.45	3.00	12.45	-38.25	-13.00	25.25	H
5715.0	-51.64	5.47	3.00	13.66	-43.45	-13.00	30.45	H
3810.0	-51.73	4.45	3.00	12.45	-43.73	-13.00	30.73	V
5715.0	-56.39	5.48	3.00	13.66	-48.21	-13.00	35.21	V

LTE FDD Band 2_Channel Bandwidth 15MHz_16QAM_Low Channel

Frequency (MHz)	P _{Mea} (dBm)	P _{cl} (dB)	Diatance	G _a Antenna Gain(dB)	Peak EIRP (dBm)	Limit (dBm)	Margin (dB)	Polarization
3715.0	-48.33	4.39	3.00	12.34	-40.38	-13.00	27.38	H
5572.5	-51.94	5.31	3.00	13.52	-43.73	-13.00	30.73	H
3715.0	-54.48	4.39	3.00	12.34	-46.53	-13.00	33.53	V
5572.5	-57.11	5.31	3.00	13.52	-48.90	-13.00	35.90	V

LTE FDD Band 2_Channel Bandwidth 15MHz_16QAM_Middle Channel

Frequency (MHz)	P _{Mea} (dBm)	P _{cl} (dB)	Diatance	G _a Antenna Gain(dB)	Peak EIRP (dBm)	Limit (dBm)	Margin (dB)	Polarization
3760.0	-42.43	4.41	3.00	12.34	-34.50	-13.00	21.50	H
5640.0	-50.35	5.38	3.00	13.58	-42.15	-13.00	29.15	H
3760.0	-51.13	4.41	3.00	12.34	-43.20	-13.00	30.20	V
5640.0	-54.93	5.38	3.00	13.58	-46.73	-13.00	33.73	V

LTE FDD Band 2_Channel Bandwidth 15MHz_16QAM_High Channel

Frequency (MHz)	P _{Mea} (dBm)	P _{cl} (dB)	Diatance	G _a Antenna Gain(dB)	Peak EIRP (dBm)	Limit (dBm)	Margin (dB)	Polarization
3805.0	-48.32	4.45	3.00	12.45	-40.32	-13.00	27.32	H
5707.5	-52.01	5.47	3.00	13.66	-43.82	-13.00	30.82	H
3805.0	-51.52	4.45	3.00	12.45	-43.52	-13.00	30.52	V
5707.5	-58.02	5.48	3.00	13.66	-49.84	-13.00	36.84	V

LTE FDD Band 2_Channel Bandwidth 20MHz_16QAM_Low Channel

Frequency (MHz)	P _{Mea} (dBm)	P _{cl} (dB)	Diatance	G _a Antenna Gain(dB)	Peak EIRP (dBm)	Limit (dBm)	Margin (dB)	Polarization
3715.0	-51.34	4.39	3.00	12.34	-43.39	-13.00	30.39	H
5572.5	-52.06	5.31	3.00	13.52	-43.85	-13.00	30.85	H
3715.0	-54.37	4.39	3.00	12.34	-46.42	-13.00	33.42	V
5572.5	-57.68	5.31	3.00	13.52	-49.47	-13.00	36.47	V

LTE FDD Band 2_Channel Bandwidth 20MHz_16QAM_Middle Channel

Frequency (MHz)	P _{Mea} (dBm)	P _{cl} (dB)	Diatance	G _a Antenna Gain(dB)	Peak EIRP (dBm)	Limit (dBm)	Margin (dB)	Polarization
3720.0	-43.95	4.41	3.00	12.34	-36.02	-13.00	23.02	H
5580.0	-49.57	5.38	3.00	13.58	-41.37	-13.00	28.37	H
3720.0	-51.11	4.41	3.00	12.34	-43.18	-13.00	30.18	V
5580.0	-54.27	5.38	3.00	13.58	-46.07	-13.00	33.07	V

LTE FDD Band 2_Channel Bandwidth 20MHz_16QAM_High Channel

Frequency (MHz)	P _{Mea} (dBm)	P _{cl} (dB)	Diatance	G _a Antenna Gain(dB)	Peak EIRP (dBm)	Limit (dBm)	Margin (dB)	Polarization
3800.0	-50.04	4.45	3.00	12.45	-42.04	-13.00	29.04	H
5700.0	-54.11	5.47	3.00	13.66	-45.92	-13.00	32.92	H
3800.0	-51.76	4.45	3.00	12.45	-43.76	-13.00	30.76	V
5700.0	-59.25	5.48	3.00	13.66	-51.07	-13.00	38.07	V

4.7 Frequency Stability

LIMIT

According to §24.235, §2.1055 requirement, the frequency stability shall be sufficient to ensure that the fundamental emissions stay within the authorized bands of operation and should not exceed 2.5ppm.

TEST CONFIGURATION

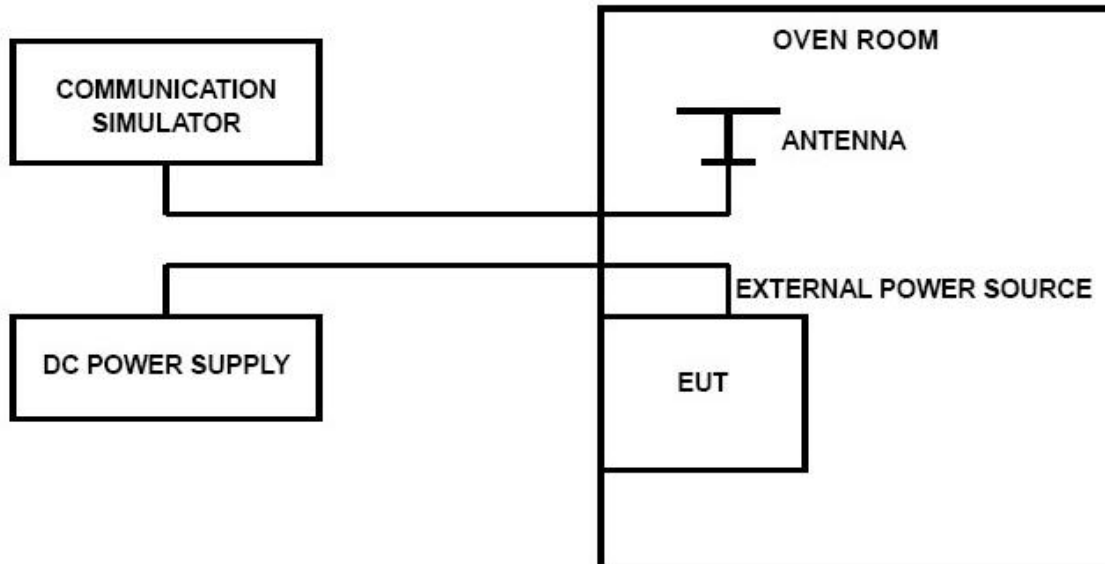

TEST PROCEDURE

The EUT was setup according to EIA/TIA 603D

Frequency Stability Under Temperature Variations:

In order to measure the carrier frequency under the condition of AFC lock, it is necessary to make measurements with the EUT in a "call mode". This is accomplished with the use of R&S CMW500 DIGITAL RADIO COMMUNICATION TESTER.

1. Measure the carrier frequency at room temperature.
2. Subject the EUT to overnight soak at -30°C.
3. With the EUT, powered via nominal voltage, connected to the CMW500 and in a simulated call on middle channel for LTE band 2, measure the carrier frequency. These measurements should be made within 2 minutes of Powering up the EUT, to prevent significant self-warming.
4. Repeat the above measurements at 10°C increments from -30°C to +50°C. Allow at least 1.5 hours at each temperature, unpowered, before making measurements.
5. Re-measure carrier frequency at room temperature with nominal voltage. Vary supply voltage from minimum voltage to maximum voltage, in 0.1Volt increments re-measuring carrier frequency at each voltage. Pause at nominal voltage for 1.5 hours unpowered, to allow any self-heating to stabilize, before continuing.
6. Subject the EUT to overnight soak at +50°C.
7. With the EUT, powered via nominal voltage, connected to the CMW500 and in a simulated call on the centre channel, measure the carrier frequency. These measurements should be made within 2 minutes of Powering up the EUT, to prevent significant self-warming.
8. Repeat the above measurements at 10 °C increments from +50°C to -30°C. Allow at least 1.5 hours at each temperature, unpowered, before making measurements
9. At all temperature levels hold the temperature to +/- 0.5°C during the measurement procedure.

Frequency Stability Under Voltage Variations:

Set chamber temperature to 20°C. Use a variable AC power supply / DC power source to power the EUT and set the voltage to rated voltage. Set the spectrum analyzer RBW low enough to obtain the desired frequency resolution and recorded the frequency.

Reduce the input voltage to specify extreme voltage variation ($\pm 15\%$) and endpoint, record the maximum frequency change.

TEST RESULTS

Remark:

1. We tested all RB Configuration refer 3GPP TS136 521 for each Channel Bandwidth of LTE FDD Band 2; recorded worst case.

LTE Band 2, 1.4MHz bandwidth , QPSK (worst case of all bandwidths)

LTE FDD Band 2					
DC Power	Temperature (°C)	Frequency error(Hz)	Frequency error(ppm)	Limit (ppm)	Verdict
36.0	20	29	0.0154	+/- 2.50	PASS
32.4	20	34	0.0181	+/- 2.50	PASS
39.6	20	19	0.0101	+/- 2.50	PASS
36.0	-30	25	0.0133	+/- 2.50	PASS
36.0	-20	21	0.0112	+/- 2.50	PASS
36.0	-10	26	0.0138	+/- 2.50	PASS
36.0	0	37	0.0197	+/- 2.50	PASS
36.0	10	29	0.0154	+/- 2.50	PASS
36.0	20	24	0.0128	+/- 2.50	PASS
36.0	30	27	0.0144	+/- 2.50	PASS
36.0	40	19	0.0101	+/- 2.50	PASS
36.0	50	27	0.0144	+/- 2.50	PASS

LTE Band 2, 1.4MHz bandwidth , 16QAM (worst case of all bandwidths)

LTE FDD Band 2					
DC Power	Temperature (°C)	Frequency error(Hz)	Frequency error(ppm)	Limit (ppm)	Verdict
36.0	20	37	0.0197	+/- 2.50	PASS
32.4	20	41	0.0218	+/- 2.50	PASS
39.6	20	55	0.0293	+/- 2.50	PASS
36.0	-30	60	0.0319	+/- 2.50	PASS
36.0	-20	33	0.0176	+/- 2.50	PASS
36.0	-10	45	0.0239	+/- 2.50	PASS
36.0	0	34	0.0181	+/- 2.50	PASS
36.0	10	26	0.0138	+/- 2.50	PASS
36.0	20	29	0.0154	+/- 2.50	PASS
36.0	30	33	0.0176	+/- 2.50	PASS
36.0	40	24	0.0128	+/- 2.50	PASS
36.0	50	13	0.0069	+/- 2.50	PASS

5 Test Setup Photos of the EUT

Reference to the annex of Test Photos.

6 External and Internal Photos of the EUT

Reference to the annex of External Photos and Internal Photos.

*******End of Report*******