

Test Report

FCC ID: 2AHYV-JAIREXEC

Date of issue: June 13, 2019

| | |
|---------------------|---|
| Report Number: | MTi190523E143 |
| Sample Description: | Bluetooth Headset |
| Model(s): | JBuds Air Executive |
| Applicant: | PEAG,LLC dba JLab Audio |
| Address: | 2281 Las Palmas Drive, Suite 101 Carlsbad, CA 92011 |
| Date of Test: | May 09, 2019 to June 13, 2019 |

Shenzhen Microtest Co., Ltd.
<http://www.mtitest.com>

This test report is valid for the tested samples only. It cannot be reproduced except in full without prior written consent of Shenzhen Microtest Co., Ltd.

Table of Contents

| | |
|---|-----------|
| 1 GENERAL INFORMATION | 5 |
| 1.1 DESCRIPTION OF EUT | 5 |
| 1.2 OPERATION CHANNEL LIST | 5 |
| 1.3 TEST CHANNEL LIST | 6 |
| 1.4 ANCILLARY EQUIPMENT LIST | 6 |
| 1.5 DESCRIPTION OF SUPPORT UNITS | 6 |
| 2 SUMMARY OF TEST RESULTS | 7 |
| 3 TEST FACILITIES AND ACCREDITATIONS | 8 |
| 3.1 TEST LABORATORY | 8 |
| 3.2 ENVIRONMENTAL CONDITIONS..... | 8 |
| 3.3 MEASUREMENT UNCERTAINTY | 8 |
| 3.4 TEST SOFTWARE | 8 |
| 4 EQUIPMENT LIST | 9 |
| 5 TEST RESULT | 10 |
| 5.1 ANTENNA REQUIREMENT..... | 10 |
| 5.1.1 STANDARD REQUIREMENT..... | 10 |
| 5.1.2 EUT ANTENNA..... | 10 |
| 5.2 PEAK OUTPUT POWER..... | 11 |
| 5.2.1 LIMIT | 11 |
| 5.2.2 TEST SETUP..... | 11 |
| 5.2.3 TEST PROCEDURE | 11 |
| 5.2.4 TEST RESULTS | 11 |
| 5.3 CONDUCTED EMISSION | 18 |
| 5.3.1 LIMITS..... | 18 |
| 5.3.2 TEST SETUP..... | 18 |
| 5.3.3 TEST PROCEDURE | 19 |
| 5.3.4 TEST RESULTS | 19 |
| 5.4 RADIATED SPURIOUS EMISSION | 24 |
| 5.4.1 LIMITS..... | 24 |
| 5.4.2 TEST SETUP..... | 25 |
| 5.4.3 TEST PROCEDURE | 26 |
| 5.4.4 TEST RESULTS | 27 |
| 5.4.4.1 RADIATION EMISSION | 27 |
| 5.4.4.2 BAND EDGE – RADIATED | 31 |
| 5.4.4.3 SPURIOUS EMISSION IN RESTRICTED BAND 3260MHZ-18000MHZ | 32 |
| 5.5 20DB OCCUPIED CHANNEL BANDWIDTH | 33 |
| 5.5.1 LIMIT | 33 |
| 5.5.2 TEST SETUP..... | 33 |
| 5.5.3 TEST PROCEDURE | 33 |
| 5.5.4 TEST RESULTS | 33 |
| 5.6 CARRIER FREQUENCY SEPARATION | 40 |
| 5.6.1 LIMIT | 40 |
| 5.6.2 TEST SETUP..... | 40 |
| 5.6.3 TEST PROCEDURE | 40 |
| 5.6.4 TEST RESULTS | 40 |
| 5.7 HOPPING CHANNEL | 46 |
| 5.7.1 LIMIT | 46 |
| 5.7.2 TEST SETUP..... | 46 |
| 5.7.3 TEST PROCEDURE | 46 |
| 5.7.4 TEST RESULTS | 46 |

| | |
|--|-----------|
| 5.8 DWELL TIME | 49 |
| 5.8.1 LIMIT | 49 |
| 5.8.2 TEST SETUP..... | 49 |
| 5.8.3 TEST PROCEDURE | 49 |
| 5.8.4 TEST RESULTS | 49 |
| 5.9 CONDUCTED BANDEDGE | 54 |
| 5.9.1 LIMIT | 54 |
| 5.9.2 TEST SETUP..... | 54 |
| 5.9.3 TEST PROCEDURE | 54 |
| 5.9.4 TEST RESULTS | 54 |
| 5.10 SPURIOUS RF CONDUCTED EMISSIONS | 61 |
| 5.10.1 Conformance Limit | 61 |
| 5.10.2 Measuring Instruments | 61 |
| 5.10.3 Test Setup | 61 |
| 5.10.4 Test Procedure | 61 |
| 5.10.5 Test Results..... | 61 |
| PHOTOGRAPHS OF THE TEST SETUP..... | 64 |
| PHOTOGRAPHS OF THE EUT..... | 66 |

TEST REPORT

Applicant's name: PEAG,LLC dba JLab Audio

Address: 2281 Las Palmas Drive, Suite 101 Carlsbad, CA 92011

Manufacture's Name: PEAG,LLC dba JLab Audio

Address: 2281 Las Palmas Drive, Suite 101 Carlsbad, CA 92011

Product name: Bluetooth Headset

Trademark: JLAB

Model name: JBuds Air Executive

Standards: FCC Part 15.247

Test Procedure: ANSI C63.10-2013

This device described above has been tested by Shenzhen Microtest Co., Ltd. and the test results show that the equipment under test (EUT) is in compliance with the FCC requirements. And it is applicable only to the tested sample identified in the report.

Tested by:



Jone Lee

June 13, 2019

Reviewed by:



Blue Zheng

June 13, 2019

Approved by:



Smith Chen

June 13, 2019

1 General Information

1.1 Description of EUT

| | |
|------------------------------|--|
| Product name: | Bluetooth Headset |
| Model name: | JBuds Air Executive |
| Serial model: | N/A |
| Difference in series models: | N/A |
| Operation frequency: | 2402-2480MHz |
| Modulation type: | GFSK, $\pi/4$ -DQPSK,8DPSK |
| Bit Rate of transmitter: | 1 Mbps, 2Mbps, 3Mbps |
| Antenna type: | Metal Antenna |
| Antenna gain: | -1dBi |
| Max. output power: | 3.830dBm |
| Hardware version: | V0C |
| Software version: | V0C |
| Power supply: | DC 3.7V from Battery or DC 5V from adapter |
| Adapter information: | N/A |
| Battery: | The Headset : DC 3.7V 60mAh The Charging Box : DC 3.7V 700mAh |

1.2 Operation channel list

| Channel | Frequency (MHz) | Channel | Frequency (MHz) | Channel | Frequency (MHz) |
|---------|-----------------|---------|-----------------|---------|-----------------|
| 00 | 2402 | 27 | 2429 | 54 | 2456 |
| 01 | 2403 | 28 | 2430 | 55 | 2457 |
| 02 | 2404 | 29 | 2431 | 56 | 2458 |
| 03 | 2405 | 30 | 2432 | 57 | 2459 |
| 04 | 2406 | 31 | 2433 | 58 | 2460 |
| 05 | 2407 | 32 | 2434 | 59 | 2461 |
| 06 | 2408 | 33 | 2435 | 60 | 2462 |
| 07 | 2409 | 34 | 2436 | 61 | 2463 |
| 08 | 2410 | 35 | 2437 | 62 | 2464 |
| 09 | 2411 | 36 | 2438 | 63 | 2465 |

| | | | | | |
|----|------|----|------|----|------|
| 10 | 2412 | 37 | 2439 | 64 | 2466 |
| 11 | 2413 | 38 | 2440 | 65 | 2467 |
| 12 | 2414 | 39 | 2441 | 66 | 2468 |
| 13 | 2415 | 40 | 2442 | 67 | 2469 |
| 14 | 2416 | 41 | 2443 | 68 | 2470 |
| 15 | 2417 | 42 | 2444 | 69 | 2471 |
| 16 | 2418 | 43 | 2445 | 70 | 2472 |
| 17 | 2419 | 44 | 2446 | 71 | 2473 |
| 18 | 2420 | 45 | 2447 | 72 | 2474 |
| 19 | 2421 | 46 | 2448 | 73 | 2475 |
| 20 | 2422 | 47 | 2449 | 74 | 2476 |
| 21 | 2423 | 48 | 2450 | 75 | 2477 |
| 22 | 2424 | 49 | 2451 | 76 | 2478 |
| 23 | 2425 | 50 | 2452 | 77 | 2479 |
| 24 | 2426 | 51 | 2453 | 78 | 2480 |
| 25 | 2427 | 52 | 2454 | -- | -- |
| 26 | 2428 | 53 | 2455 | -- | -- |

1.3 Test channel list

| Channel | Channel | Frequency (MHz) |
|---------|---------|-----------------|
| Low | 00 | 2402 |
| Middle | 39 | 2441 |
| High | 78 | 2480 |

1.4 Ancillary equipment list

| Equipment | Model | S/N | Manufacturer | Certificate type |
|-----------|-------|-----|--------------|------------------|
| Adapter | / | / | / | / |

1.5 Description of Support Units

The EUT has been tested as an independent unit together with other necessary accessories or support units. The following support units or accessories were used to form a representative test configuration during the tests.

| Item | Equipment | Brand | Model/Type No. | Series No. | Note |
|------|-----------|-------|----------------|------------|------|
| / | / | / | / | / | / |

Note:

(1)The support equipment was authorized by Declaration of Confirmation.

(2)For detachable type I/O cable should be specified the length in cm in 『Length』 column.

2 Summary of Test Results

Test procedures according to the technical standards:

| No. | Standard Section | Test Item | Result | Remark |
|-----|------------------|---------------------------------|--------|--------|
| 1 | 15.203 | Antenna requirement | Pass | |
| 2 | 15.247(b)(1) | Peak output power | Pass | |
| 3 | 15.207 | Conducted emission | Pass | |
| 4 | 15.247(d) | Band edge | Pass | |
| 5 | 15.205/15.209 | Spurious emission | Pass | |
| 6 | 15.247(a)(1) | 20dB occupied bandwidth | Pass | |
| 7 | 15.247(a)(1) | Carrier Frequencies Separation | Pass | |
| 8 | 15.247(a)(1) | Hopping channel number | Pass | |
| 9 | 15.247(a)(1) | Dwell time | Pass | |
| 10 | 15.205 | Spurious RF Conducted Emissions | Pass | |

3 Test Facilities and Accreditations

3.1 Test laboratory

| | |
|-----------------------|---|
| Test Laboratory | Shenzhen Microtest Co., Ltd. |
| Location | No.102A & 302A, East Block, Hengfang Industrial Park, Xingye Road, Xixiang, Bao'an District, Shenzhen, Guangdong, China |
| FCC Registration No.: | 448573 |

3.2 Environmental conditions

| | |
|----------------------|--------------|
| Temperature: | 15°C~35°C |
| Humidity | 20%~75% |
| Atmospheric pressure | 98kPa~101kPa |

3.3 Measurement uncertainty

The reported uncertainty of measurement $y \pm U$ where expanded uncertainty U is based on a standard uncertainty multiplied by a coverage factor of $k=2$ providing a level of confidence of approximately 95 %

| No. | Item | Uncertainty |
|-----|-------------------------------|-------------------------|
| 1 | Conducted Emission Test | $\pm 1.38\text{dB}$ |
| 2 | RF power, conducted | $\pm 0.16\text{dB}$ |
| 3 | Spurious emissions, conducted | $\pm 0.21\text{dB}$ |
| 4 | All emissions, radiated(<1G) | $\pm 4.68\text{dB}$ |
| 5 | All emissions, radiated(>1G) | $\pm 4.89\text{dB}$ |
| 6 | Temperature | $\pm 0.5^\circ\text{C}$ |
| 7 | Humidity | $\pm 2\%$ |

3.4 Test software

| Software Name | Manufacturer | Model | Version |
|----------------|--------------|-------|-----------|
| RF Test System | Farad | LZ-RF | Lz_Rf 3A3 |

4 Equipment List

| Equipment No. | Equipment Name | Manufacturer | Model | Serial No. | Calibration date | Due date |
|---------------|--------------------------------------|-------------------------------|----------------|---------------|------------------|------------|
| MTI-E001 | Spectrum Analyzer | Agilent | E4407B | MY41441082 | 2018/09/18 | 2019/09/17 |
| MTI-E004 | EMI Test Receiver | Rohde&schwarz | ESPI | 1000314 | 2018/09/18 | 2019/09/17 |
| MTI-E006 | Broadband antenna | schwarabeck | VULB9163 | 872 | 2018/09/18 | 2019/09/17 |
| MTI-E007 | Horn antenna | schwarabeck | BBHA9120D | 1201 | 2018/09/18 | 2019/09/17 |
| MTI-E014 | amplifier | America | 8447D | 3113A06150 | 2018/09/18 | 2019/09/17 |
| MTI-E015 | Conduction Immunity Signal Generator | Schloder | CDG6000 | 126A1343/2015 | 2018/09/18 | 2019/09/17 |
| MTI-E016 | Coupled decoupling network | Schloder | CDA M2/M3 | A2210332/2015 | 2018/09/18 | 2019/09/17 |
| MTI-E034 | amplifier | Agilent | 8449B | 3008A02400 | 2018/09/18 | 2019/09/17 |
| MTI-E037 | Artificial power network | Schwarzbeck | NSLK8127 | #841 | 2018/09/18 | 2019/09/17 |
| MTI-E040 | Spectrum analyzer | Agilent | N9020A | MY49100060 | 2018/09/18 | 2019/09/17 |
| MTI-E041 | Signal generator | Agilent | N5182A | MY49060455 | 2018/09/18 | 2019/09/17 |
| MTI-E042 | Analog signal generator | Agilent | E4421B | GB40051240 | 2018/09/18 | 2019/09/17 |
| MTI-E043 | Power probe | Dare Instruments | RPR3006W | 16I00054SN016 | 2018/09/18 | 2019/09/17 |
| MTI-E047 | 10dB attenuator | Mini-Circuits | UNAT-10+ | 15542 | 2018/09/18 | 2019/09/17 |
| MTI-E049 | spectrum analyzer | Rohde&schwarz | FSP-38 | 100019 | 2018/09/18 | 2019/09/17 |
| MTI-E050 | PSG Signal generator | Agilent | E8257D | MY46520873 | 2018/09/18 | 2019/09/17 |
| MTI-E061 | Active Loop Antenna 9kHz - 30MHz | Schwarzbeck | FMZB 1519 B | 00044 | 2018/09/18 | 2019/09/17 |
| MTI-E052 | 18-40GHz amplifier | Chengdu step Micro Technology | ZLNA-18-40G-21 | 1608001 | 2018/09/18 | 2019/09/17 |
| MTI-E053 | 15-40G Antenna | Schwarzbeck | BBHA9170 | BBHA9170582 | 2018/09/18 | 2019/09/17 |
| MTI-E058 | Artificial power network | Schwarzbeck | NSLK8127 | #841 | 2018/09/18 | 2019/09/17 |

Note: the calibration interval of the above test instruments is 12 months and the calibrations are traceable to international system unit (SI).

5 Test Result

5.1 Antenna requirement

5.1.1 Standard requirement

15.203 requirement: For intentional device, according to 15.203: an intentional radiator shall be designed to ensure that no antenna other than that furnished by the responsible party shall be used with the device

5.1.2 EUT Antenna

The EUT antenna is PCB antenna (-1.0dBi). It comply with the standard requirement. In case of replacement of broken antenna the same antenna type must be used.

5.2 Peak output power

5.2.1 Limit

| FCC Part15 Subpart C | | | |
|----------------------|-------------------|-----------------|-----------------------|
| Section | Test Item | Limit | Frequency Range (MHz) |
| 15.247(b)(1) | Peak output power | Power<1W(30dBm) | 2400-2483.5 |

5.2.2 Test setup

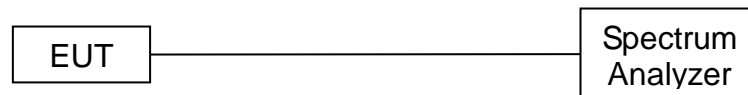

5.2.3 Test procedure

- (1) The EUT was directly connected to the spectrum analyzer and antenna output port as show in the block diagram above.
- (2) Spectrum Setting:
 RBW=1MHz, VBW=3MHz, Detector=Peak (If 20dB BW ≤1 MHz)
 RBW=3MHz, VBW=8MHz, Detector=Peak (If 20dB BW > 1 MHz)
- (3) The EUT was set to continuously transmitting in the max power during the test.

5.2.4 Test results

Test data

| | | | |
|---------------|-------------------|---------------------|---------------------|
| EUT : | Bluetooth Headset | Model Name : | JBuds Air Executive |
| Temperature : | 25 °C | Relative Humidity : | 60% |
| Pressure : | 1012 hPa | Test Voltage : | DC 3.7V by battery |

GFSK

| Test Channel | Frequency (MHz) | Maximum Peak Output Power(dBm) | Limit (dBm) |
|--------------|-----------------|--------------------------------|-------------|
| CH00 | 2402 | 2.728 | 30 |
| CH39 | 2441 | 2.905 | 30 |
| CH78 | 2480 | 3.830 | 30 |

$\pi/4$ -DQPSK

| Test Channel | Frequency (MHz) | Maximum Peak Output Power(dBm) | Limit (dBm) |
|--------------|-----------------|--------------------------------|-------------|
| CH00 | 2402 | 1.253 | 30 |
| CH39 | 2441 | 1.581 | 30 |
| CH78 | 2480 | 0.053 | 30 |

8DPSK

| Test Channel | Frequency (MHz) | Maximum Peak Output Power(dBm) | Limit (dBm) |
|--------------|-----------------|--------------------------------|-------------|
| CH00 | 2402 | 1.718 | 30 |
| CH39 | 2441 | 1.636 | 30 |
| CH78 | 2480 | 0.659 | 30 |

Test plots

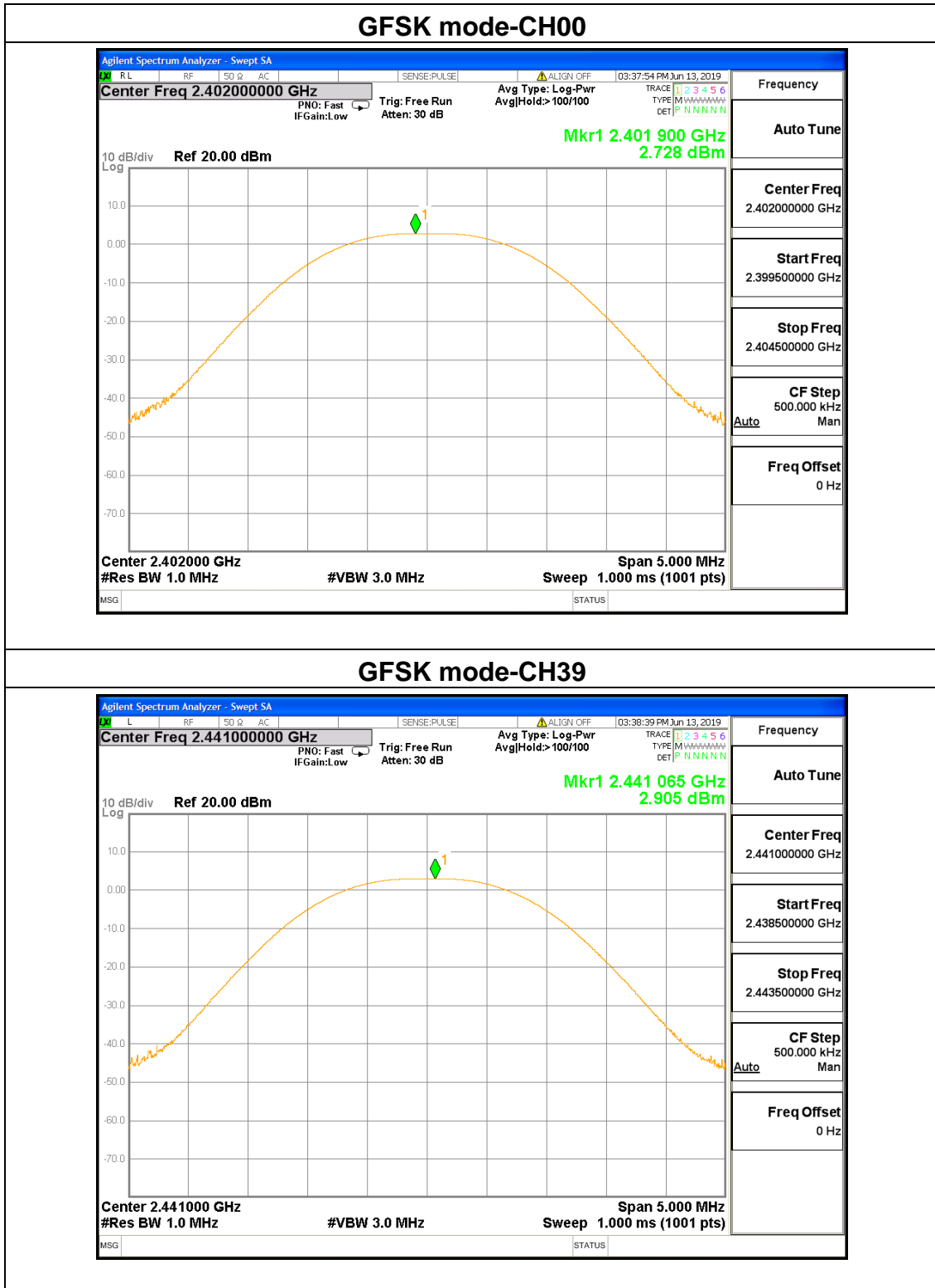

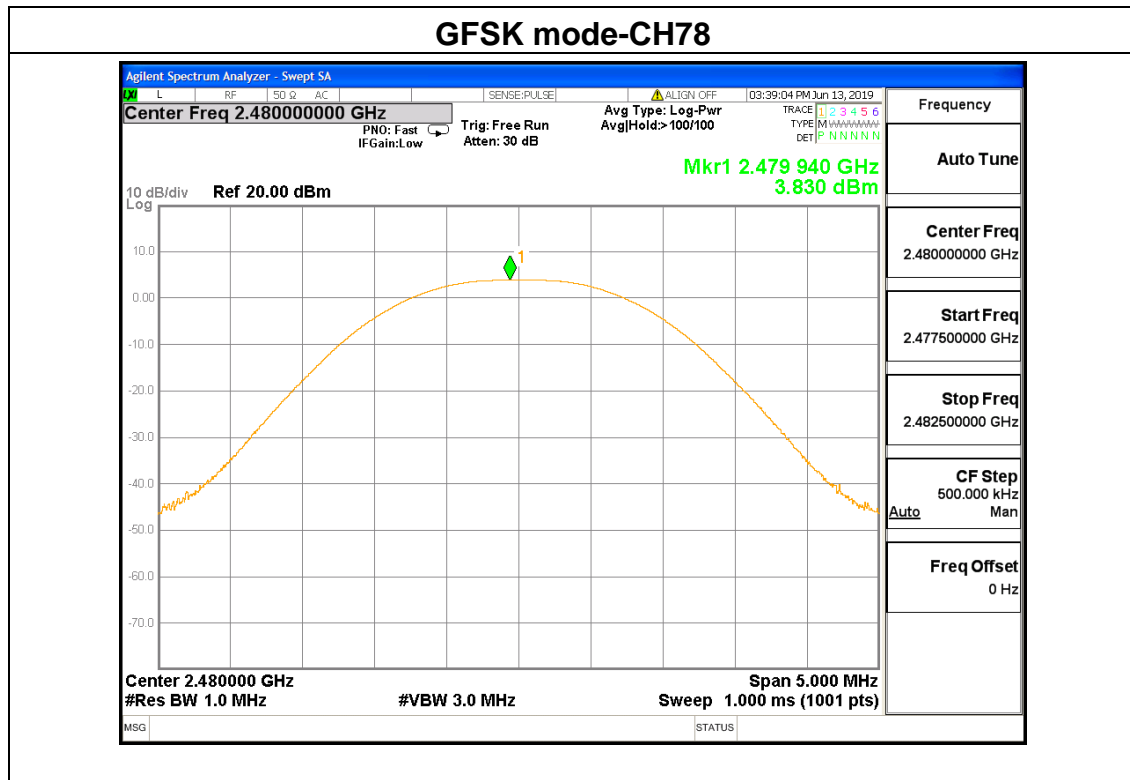

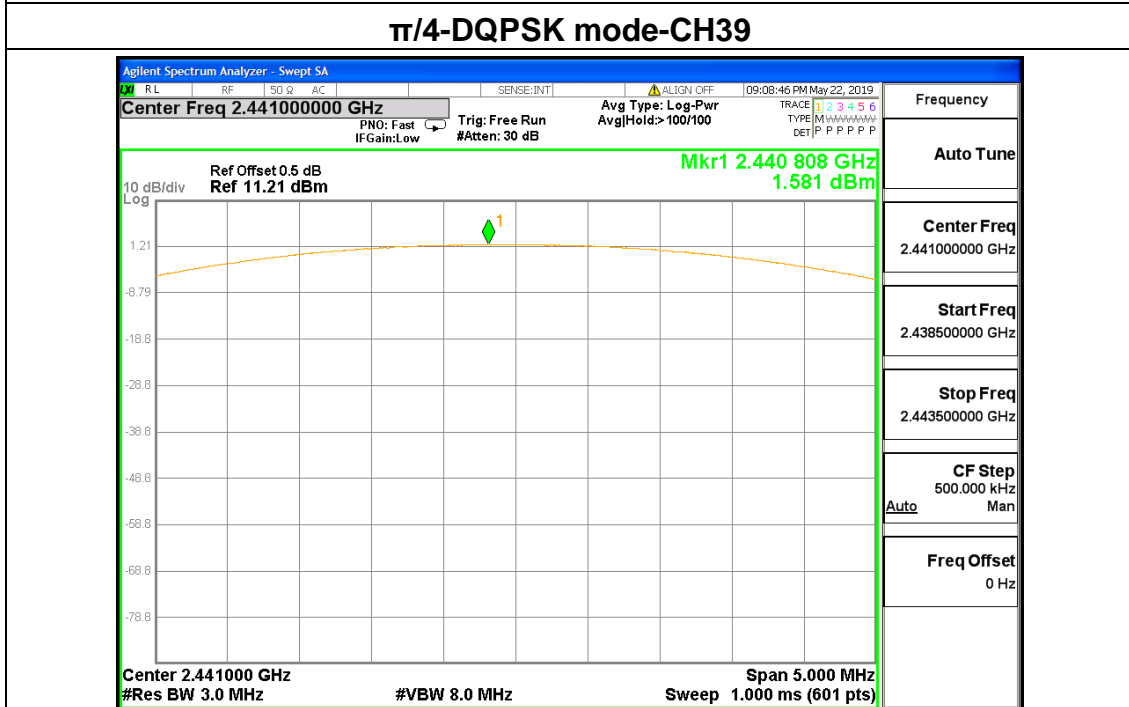
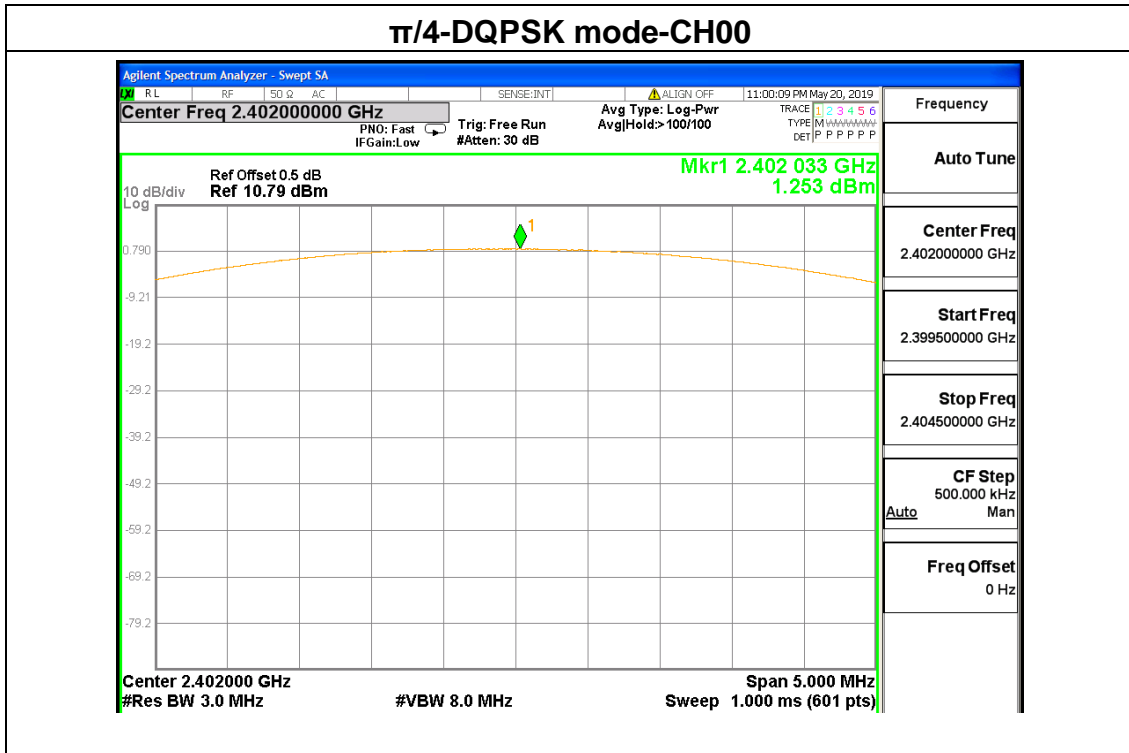

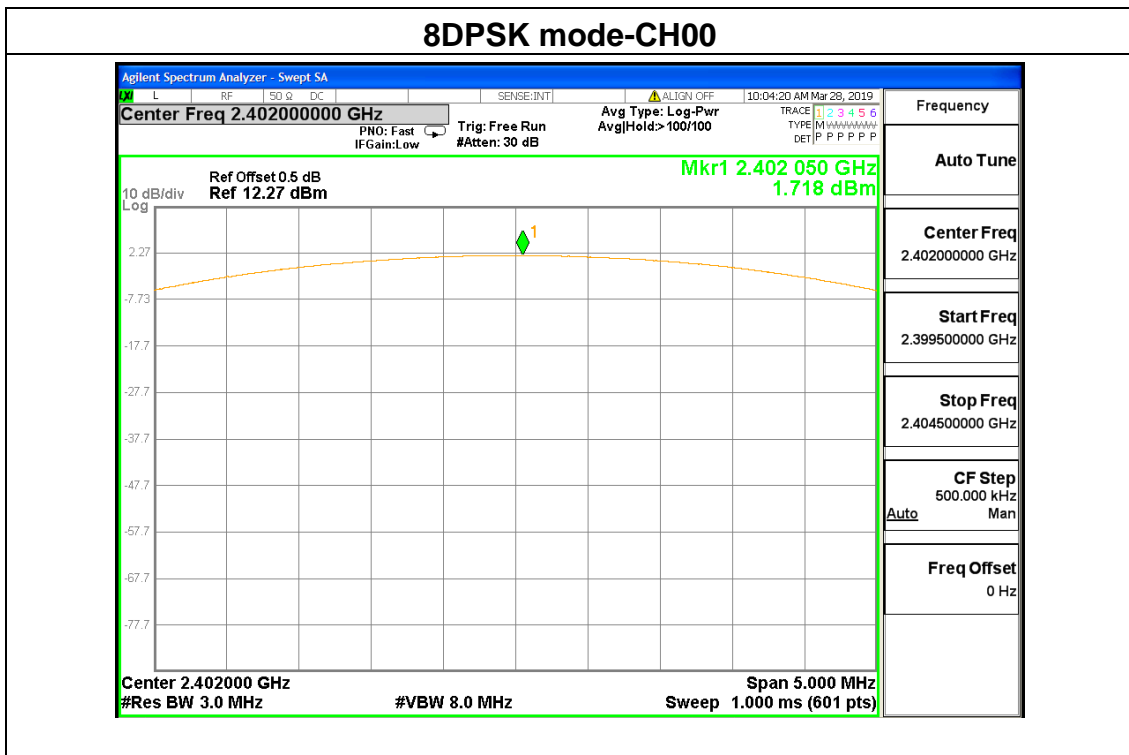
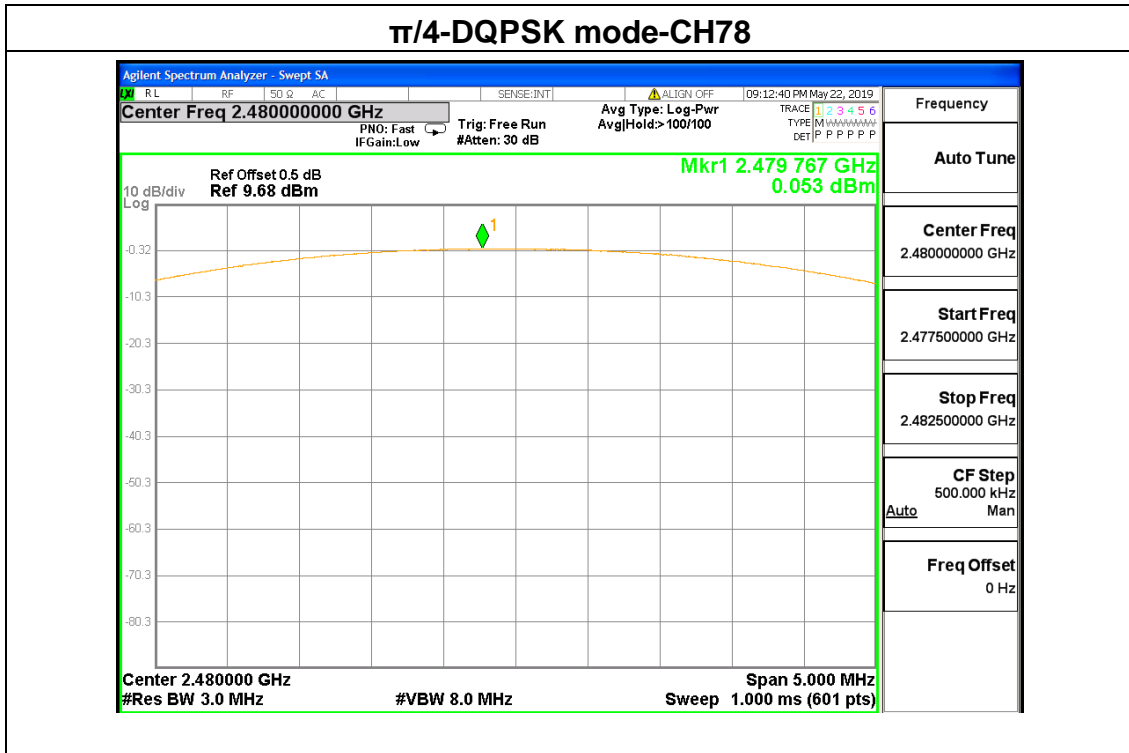

8DPSK mode-39

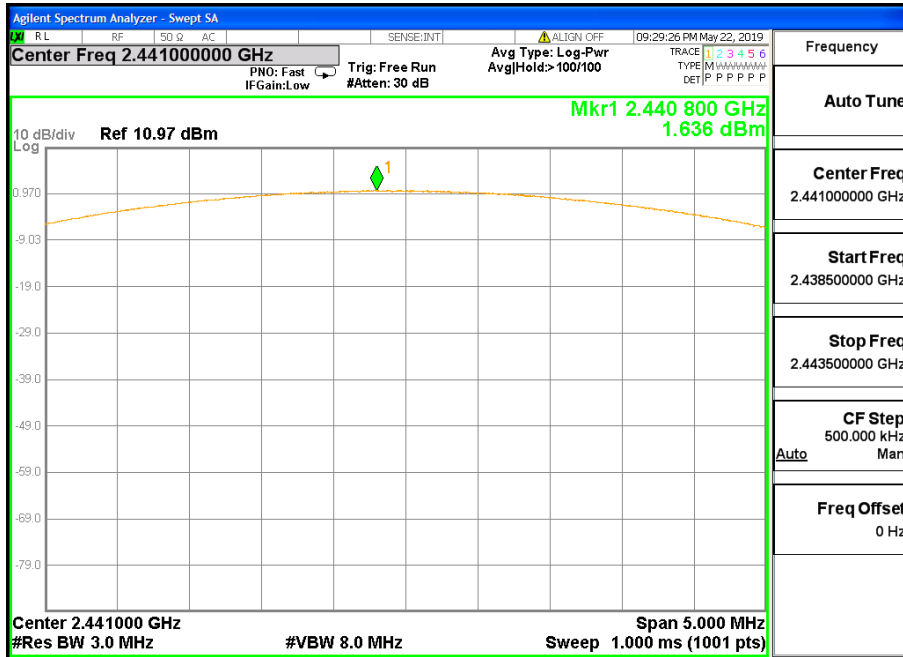

8DPSK mode-CH78

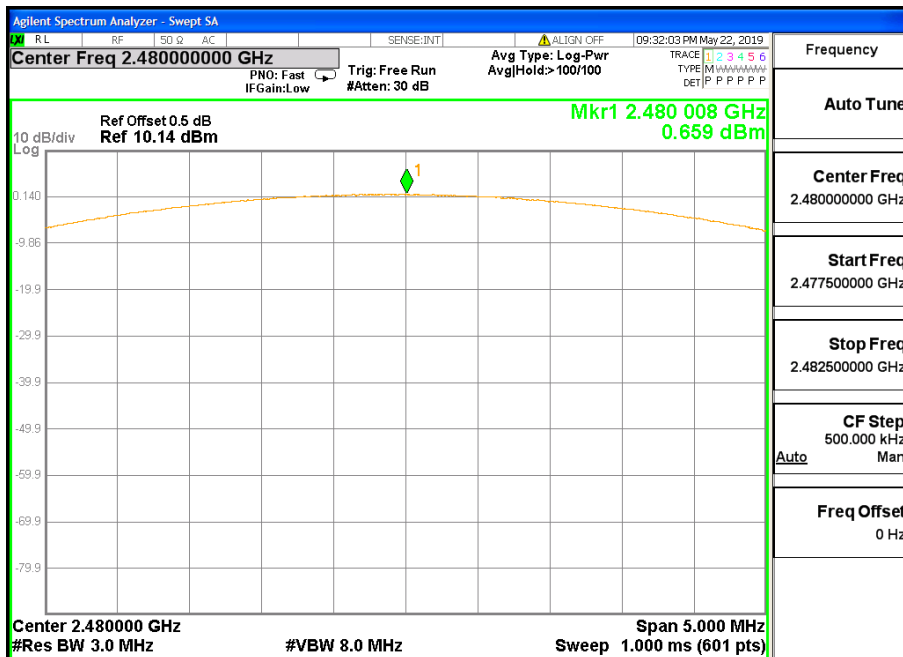

5.3 Conducted emission

5.3.1 Limits

| FREQUENCY (MHz) | Class B (dBuV) | |
|-----------------|----------------|-----------|
| | Quasi-peak | Average |
| 0.15 -0.5 | 66 - 56 * | 56 - 46 * |
| 0.50 -5.0 | 56.00 | 46.00 |
| 5.0 -30.0 | 60.00 | 50.00 |

Note

(1)The tighter limit applies at the band edges.

(2)The limit of " * " marked band means the limitation decreases linearly with the logarithm of the frequency in the range.

5.3.2 Test setup

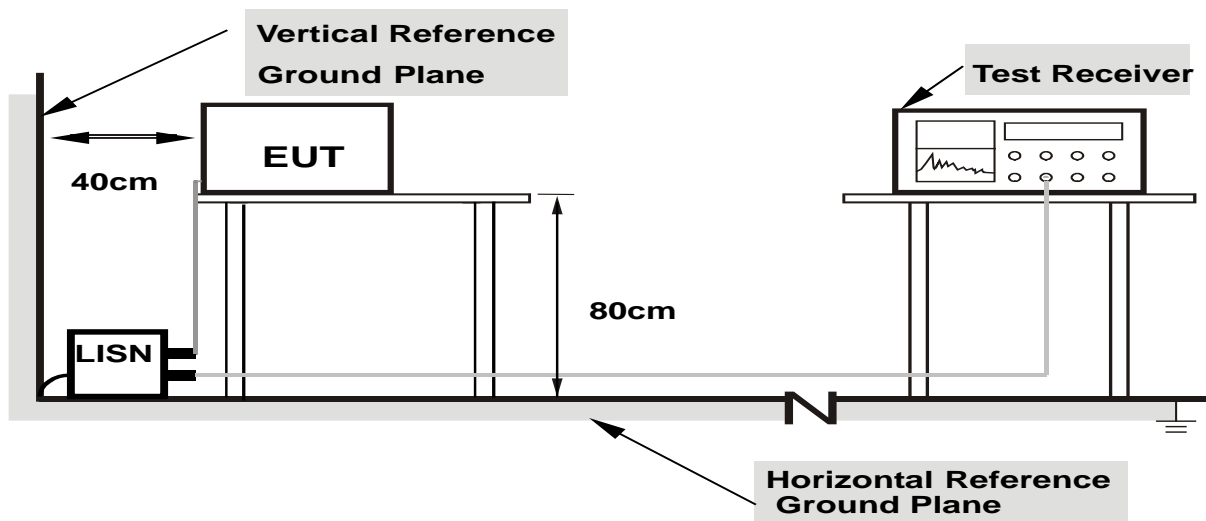

Note: 1.Support units were connected to second LISN.

2.Both of LISNs (AMN) are 80 cm from EUT and at least 80 from other units and other metal planes

5.3.3 Test procedure

a. EUT Operating Conditions

The EUT was configured for testing in a typical fashion (as a customer would normally use it). The EUT has been programmed to continuously transmit during test. This operating condition was tested and used to collect the included data.

b. The following table is the setting of the receiver

| Receiver Parameters | Setting |
|---------------------|----------|
| Attenuation | 10 dB |
| Start Frequency | 0.15 MHz |
| Stop Frequency | 30 MHz |
| IF Bandwidth | 9 kHz |

- c. The EUT was placed 0.8 meters from the horizontal ground plane with EUT being connected to the power mains through a line impedance stabilization network (LISN). All other support equipments powered from additional LISN(s). The LISN provide 50 Ohm/ 50uH of coupling impedance for the measuring instrument.
- d. Interconnecting cables that hang closer than 40 cm to the ground plane shall be folded back and forth in the center forming a bundle 30 to 40 cm long.
- e. I/O cables that are not connected to a peripheral shall be bundled in the center. The end of the cable may be terminated, if required, using the correct terminating impedance. The overall length shall not exceed 1 m.
- f. LISN at least 80 cm from nearest part of EUT chassis.

For the actual test configuration, please refer to the related Item –EUT Test Photos.

5.3.4 Test results

Test data

| | | | |
|----------------|---------------------------------|---------------------|---------------------|
| EUT : | Bluetooth Headset | Model Name. : | JBuds Air Executive |
| Temperature : | 26 °C | Relative Humidity : | 54% |
| Pressure : | 1010hPa | Phase : | L |
| Test Voltage : | DC 5V from adapter AC 120V/60Hz | Test Mode : | Normal link |

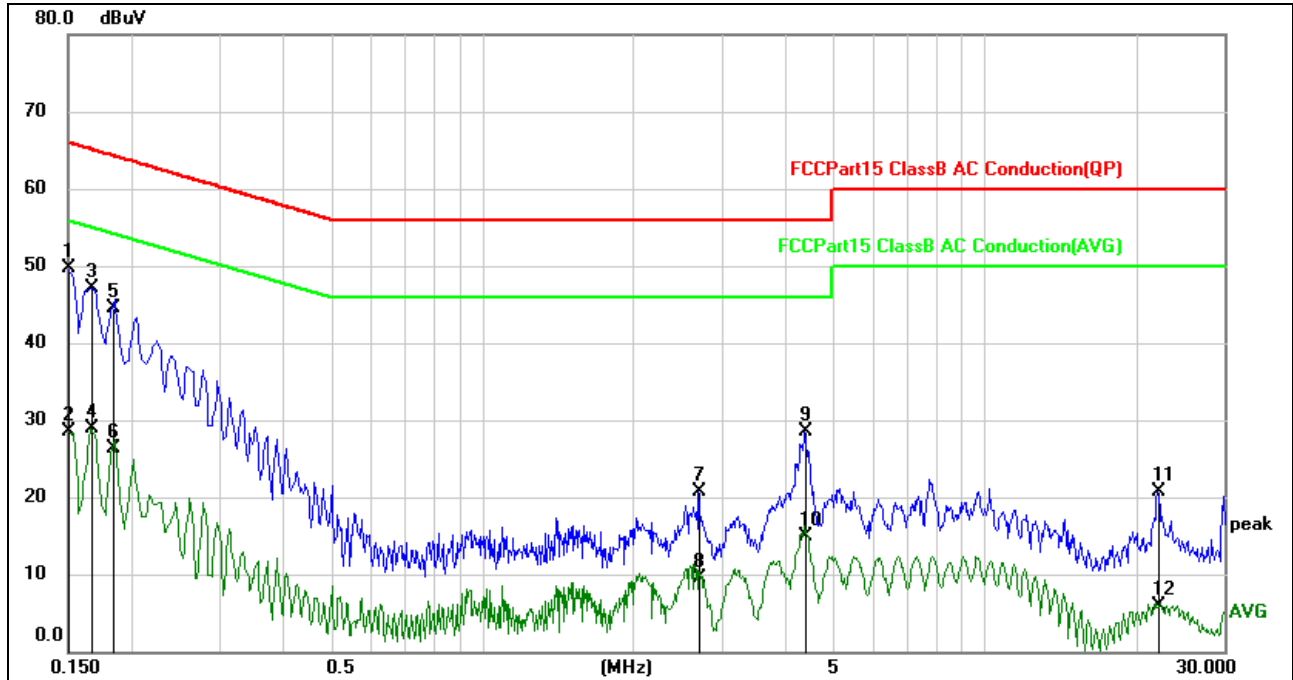

| No. | Mk. | Freq. | Reading Level | Correct Factor | Measurement | Limit | Over | Detector | Comment |
|-----|-----|---------|---------------|----------------|-------------|-------|--------|----------|---------|
| | | MHz | dBuV | dB | dBuV | dBuV | dB | | |
| 1 | * | 0.1500 | 39.97 | 9.73 | 49.70 | 66.00 | -16.30 | QP | |
| 2 | | 0.1500 | 18.70 | 9.73 | 28.43 | 56.00 | -27.57 | AVG | |
| 3 | | 0.1660 | 37.34 | 9.73 | 47.07 | 65.16 | -18.09 | QP | |
| 4 | | 0.1660 | 19.24 | 9.73 | 28.97 | 55.16 | -26.19 | AVG | |
| 5 | | 0.1835 | 34.87 | 9.73 | 44.60 | 64.33 | -19.73 | QP | |
| 6 | | 0.1835 | 16.52 | 9.73 | 26.25 | 54.33 | -28.08 | AVG | |
| 7 | | 2.6940 | 10.76 | 9.99 | 20.75 | 56.00 | -35.25 | QP | |
| 8 | | 2.6940 | -0.57 | 9.99 | 9.42 | 46.00 | -36.58 | AVG | |
| 9 | | 4.3859 | 18.54 | 10.04 | 28.58 | 56.00 | -27.42 | QP | |
| 10 | | 4.3859 | 4.95 | 10.04 | 14.99 | 46.00 | -31.01 | AVG | |
| 11 | | 22.0940 | 10.47 | 10.15 | 20.62 | 60.00 | -39.38 | QP | |
| 12 | | 22.0940 | -4.25 | 10.15 | 5.90 | 50.00 | -44.10 | AVG | |

| | | | |
|----------------|---------------------------------|---------------------|---------------------|
| EUT : | Bluetooth Headset | Model Name. : | JBuds Air Executive |
| Temperature : | 26 °C | Relative Humidity : | 54% |
| Pressure : | 1010hPa | Phase : | N |
| Test Voltage : | DC 5V from adapter AC 120V/60Hz | Test Mode : | Normal link |

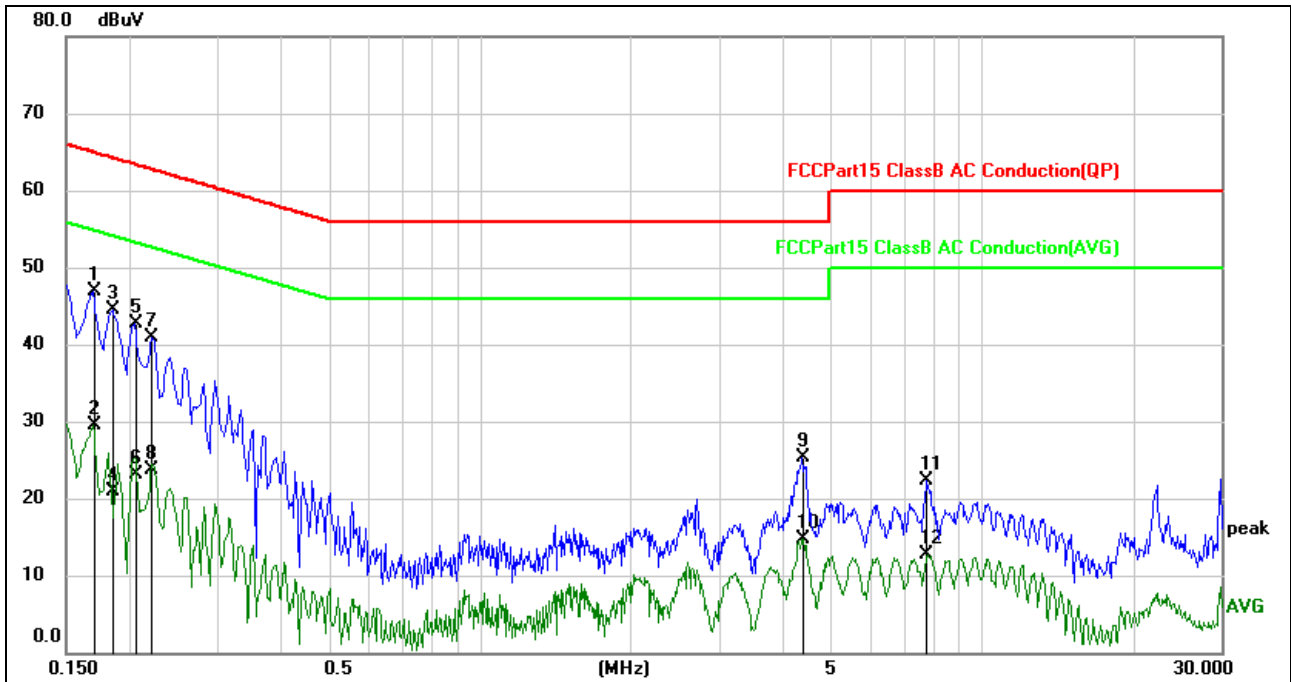

| No. | Mk. | Freq. | Reading Level | Correct Factor | Measurement | Limit | Over | Detector | Comment |
|-----|-----|--------|---------------|----------------|-------------|-------|--------|----------|---------|
| | | MHz | dBuV | dB | dBuV | dBuV | dB | | |
| 1 | * | 0.1700 | 37.09 | 9.73 | 46.82 | 64.96 | -18.14 | QP | |
| 2 | | 0.1700 | 19.68 | 9.73 | 29.41 | 54.96 | -25.55 | AVG | |
| 3 | | 0.1860 | 34.80 | 9.73 | 44.53 | 64.21 | -19.68 | QP | |
| 4 | | 0.1860 | 11.13 | 9.73 | 20.86 | 54.21 | -33.35 | AVG | |
| 5 | | 0.2060 | 32.94 | 9.73 | 42.67 | 63.37 | -20.70 | QP | |
| 6 | | 0.2060 | 13.44 | 9.73 | 23.17 | 53.37 | -30.20 | AVG | |
| 7 | | 0.2220 | 31.26 | 9.73 | 40.99 | 62.74 | -21.75 | QP | |
| 8 | | 0.2220 | 13.99 | 9.73 | 23.72 | 52.74 | -29.02 | AVG | |
| 9 | | 4.4060 | 15.32 | 10.04 | 25.36 | 56.00 | -30.64 | QP | |
| 10 | | 4.4060 | 4.59 | 10.04 | 14.63 | 46.00 | -31.37 | AVG | |
| 11 | | 7.7540 | 12.09 | 10.18 | 22.27 | 60.00 | -37.73 | QP | |
| 12 | | 7.7540 | 2.59 | 10.18 | 12.77 | 50.00 | -37.23 | AVG | |

| | | | |
|----------------|---------------------------------|---------------------|---------------------|
| EUT : | Bluetooth Headset | Model Name. : | JBuds Air Executive |
| Temperature : | 26 °C | Relative Humidity : | 54% |
| Pressure : | 1010hPa | Phase : | L |
| Test Voltage : | DC 5V from adapter AC 240V/60Hz | Test Mode : | Normal link |

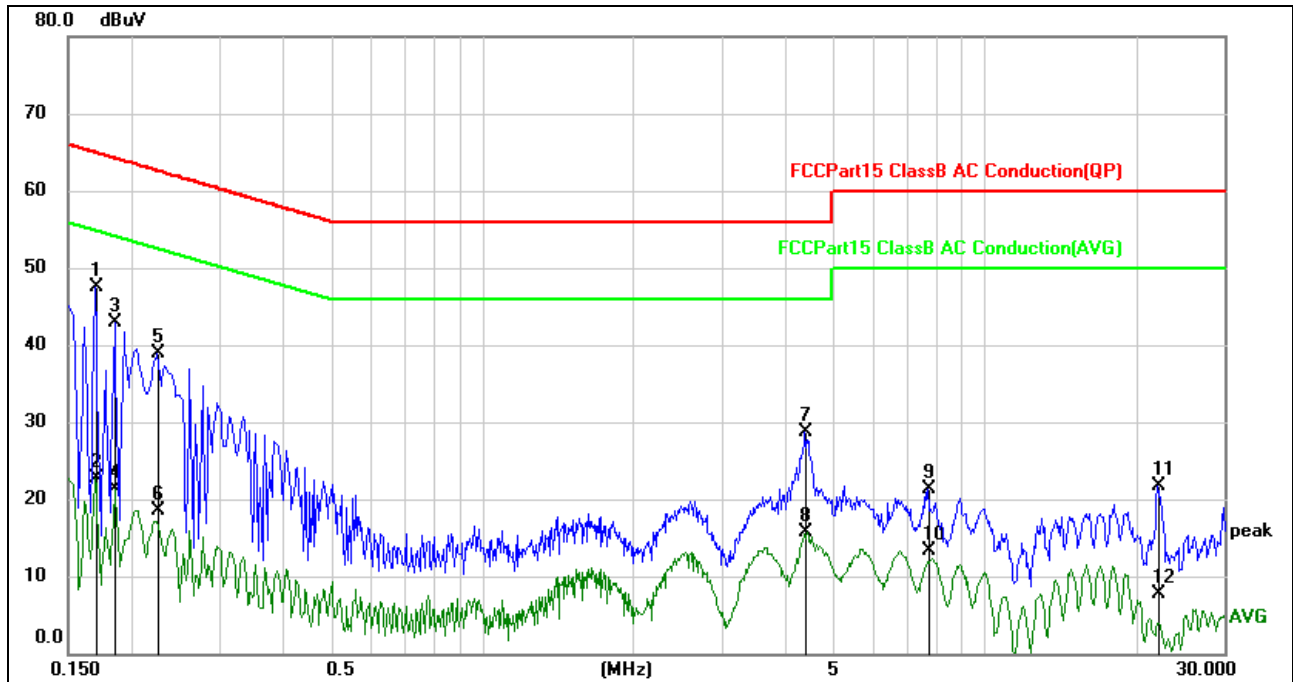

| No. | Mk. | Freq. | Reading Level | Correct Factor | Measurement | Limit | Over | Detector | Comment |
|-----|-----|---------|---------------|----------------|-------------|-------|--------|----------|---------|
| | | MHz | dBuV | dB | dBuV | dBuV | dB | | |
| 1 | * | 0.1700 | 37.79 | 9.73 | 47.52 | 64.96 | -17.44 | QP | |
| 2 | | 0.1700 | 13.03 | 9.73 | 22.76 | 54.96 | -32.20 | AVG | |
| 3 | | 0.1860 | 33.09 | 9.73 | 42.82 | 64.21 | -21.39 | QP | |
| 4 | | 0.1860 | 11.52 | 9.73 | 21.25 | 54.21 | -32.96 | AVG | |
| 5 | | 0.2260 | 29.11 | 9.73 | 38.84 | 62.60 | -23.76 | QP | |
| 6 | | 0.2260 | 8.74 | 9.73 | 18.47 | 52.60 | -34.13 | AVG | |
| 7 | | 4.4020 | 18.68 | 10.04 | 28.72 | 56.00 | -27.28 | QP | |
| 8 | | 4.4020 | 5.57 | 10.04 | 15.61 | 46.00 | -30.39 | AVG | |
| 9 | | 7.6940 | 11.18 | 10.18 | 21.36 | 60.00 | -38.64 | QP | |
| 10 | | 7.6940 | 3.07 | 10.18 | 13.25 | 50.00 | -36.75 | AVG | |
| 11 | | 22.1340 | 11.50 | 10.15 | 21.65 | 60.00 | -38.35 | QP | |
| 12 | | 22.1340 | -2.38 | 10.15 | 7.77 | 50.00 | -42.23 | AVG | |

| | | | |
|----------------|---------------------------------|---------------------|---------------------|
| EUT : | Bluetooth Headset | Model Name. : | JBuds Air Executive |
| Temperature : | 26 °C | Relative Humidity : | 54% |
| Pressure : | 1010hPa | Phase : | N |
| Test Voltage : | DC 5V from adapter AC 240V/60Hz | Test Mode : | Normal link |

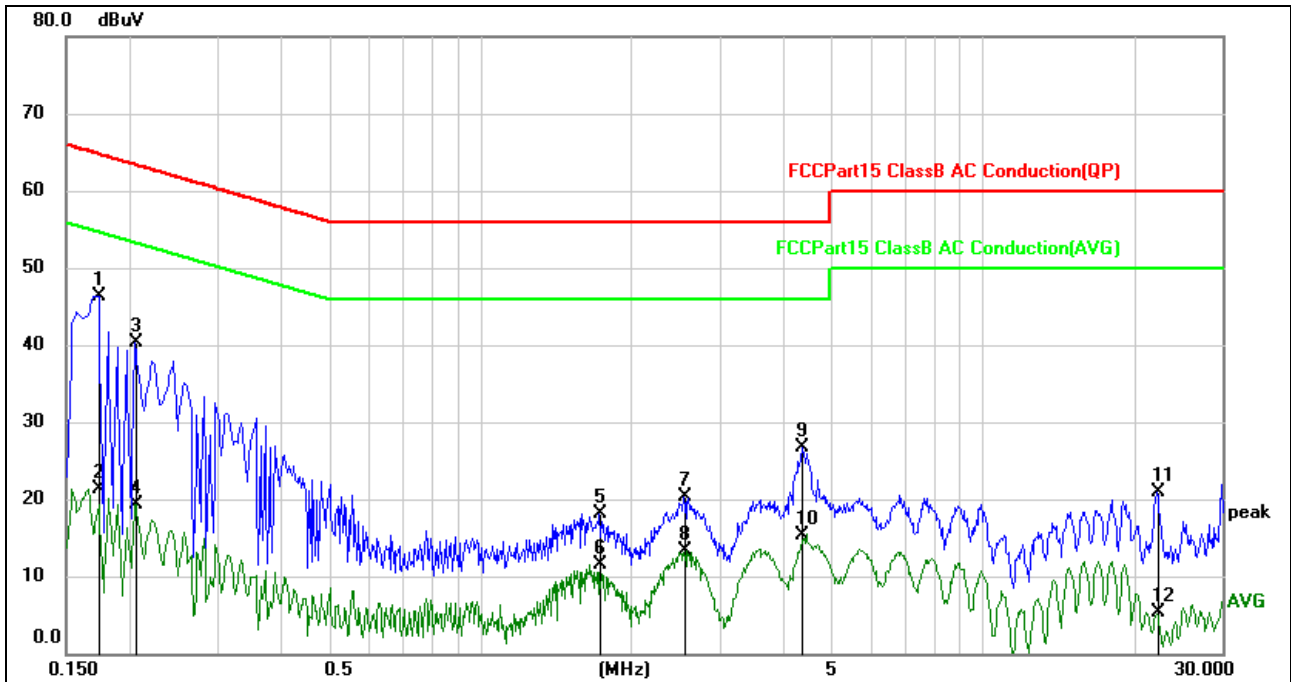

| No. | Mk. | Freq. | Reading Level | Correct Factor | Measurement | Limit | Over | Detector | Comment |
|-----|-----|---------|---------------|----------------|-------------|-------|--------|----------|---------|
| | | MHz | dBuV | dB | dBuV | dBuV | dB | | |
| 1 | * | 0.1740 | 36.53 | 9.73 | 46.26 | 64.77 | -18.51 | QP | |
| 2 | | 0.1740 | 11.63 | 9.73 | 21.36 | 54.77 | -33.41 | AVG | |
| 3 | | 0.2060 | 30.65 | 9.73 | 40.38 | 63.37 | -22.99 | QP | |
| 4 | | 0.2060 | 9.60 | 9.73 | 19.33 | 53.37 | -34.04 | AVG | |
| 5 | | 1.7300 | 8.18 | 9.97 | 18.15 | 56.00 | -37.85 | QP | |
| 6 | | 1.7300 | 1.45 | 9.97 | 11.42 | 46.00 | -34.58 | AVG | |
| 7 | | 2.5460 | 10.26 | 9.98 | 20.24 | 56.00 | -35.76 | QP | |
| 8 | | 2.5460 | 3.29 | 9.98 | 13.27 | 46.00 | -32.73 | AVG | |
| 9 | | 4.3820 | 16.74 | 10.04 | 26.78 | 56.00 | -29.22 | QP | |
| 10 | | 4.3820 | 5.36 | 10.04 | 15.40 | 46.00 | -30.60 | AVG | |
| 11 | | 22.2180 | 10.77 | 10.16 | 20.93 | 60.00 | -39.07 | QP | |
| 12 | | 22.2180 | -4.78 | 10.16 | 5.38 | 50.00 | -44.62 | AVG | |

5.4 Radiated spurious emission

5.4.1 Limits

20dBc in any 100 kHz bandwidth outside the operating frequency band. In case the emission fall within the restricted band specified on 15.205(a), then the 15.209(a) limit in the table below has to be followed.

| Frequency (MHz) | Field Strength (micorvolts/meter) | Measurement Distance (meters) |
|-----------------|-----------------------------------|-------------------------------|
| 0.009~0.490 | 2400/F(KHz) | 300 |
| 0.490~1.705 | 24000/F(KHz) | 30 |
| 1.705~30.0 | 30 | 30 |
| 30~88 | 100 | 3 |
| 88~216 | 150 | 3 |
| 216~960 | 200 | 3 |
| Above 960 | 500 | 3 |

| Spectrum Parameter | Setting |
|---------------------------------------|--|
| Attenuation | Auto |
| Start Frequency | 1000 MHz |
| Stop Frequency | 10th carrier harmonic |
| RB / VB (emission in restricted band) | 1 MHz / 1 MHz for Peak, 1 MHz / 10Hz for Average |

| Receiver Parameter | Setting |
|------------------------|----------------------------------|
| Attenuation | Auto |
| Start ~ Stop Frequency | 9kHz~150kHz / RB 200Hz for QP |
| Start ~ Stop Frequency | 150kHz~30MHz / RB 9kHz for QP |
| Start ~ Stop Frequency | 30MHz~1000MHz / RB 120kHz for QP |

5.4.2 Test setup

Radiated emission test-up frequency below 30MHz

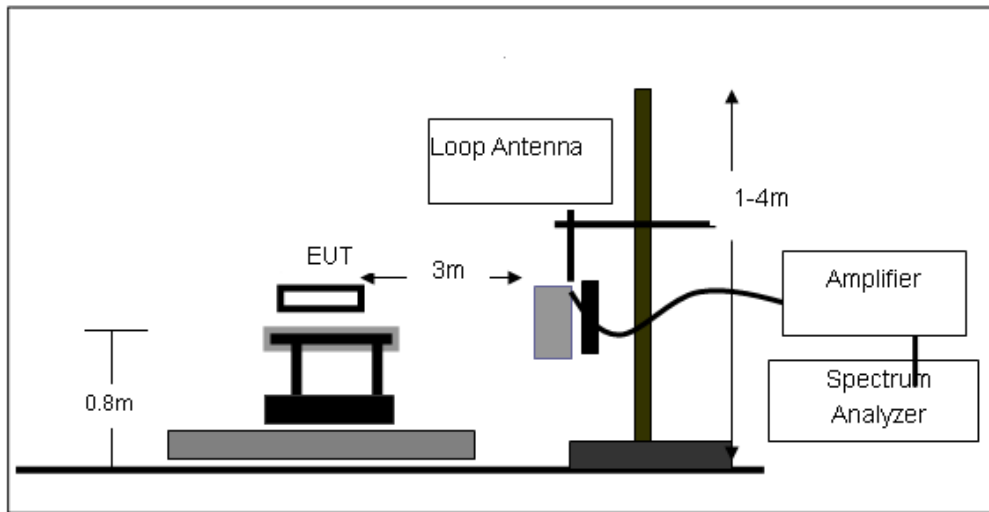

Radiated emission test-up frequency 30MHz~1GHz

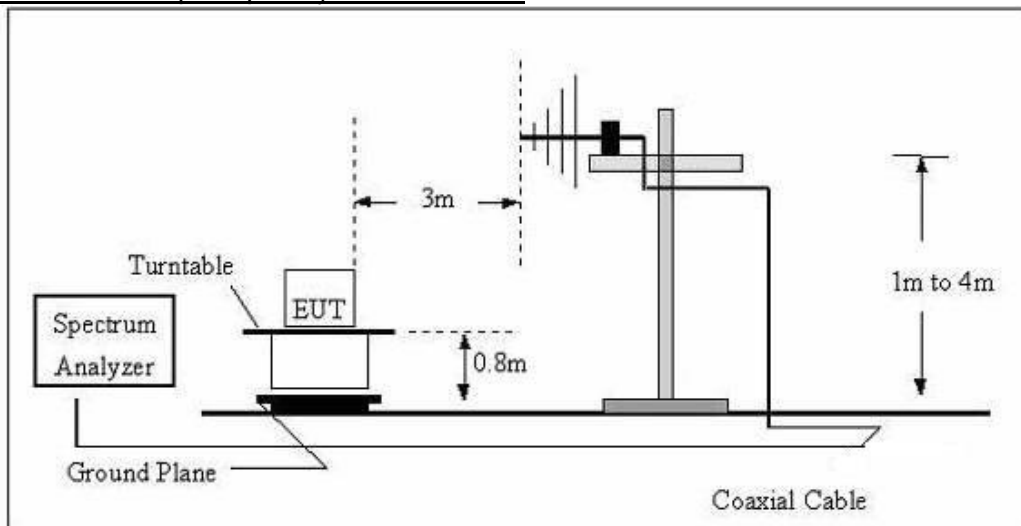

Radiated emission test-up frequency above 1GHz

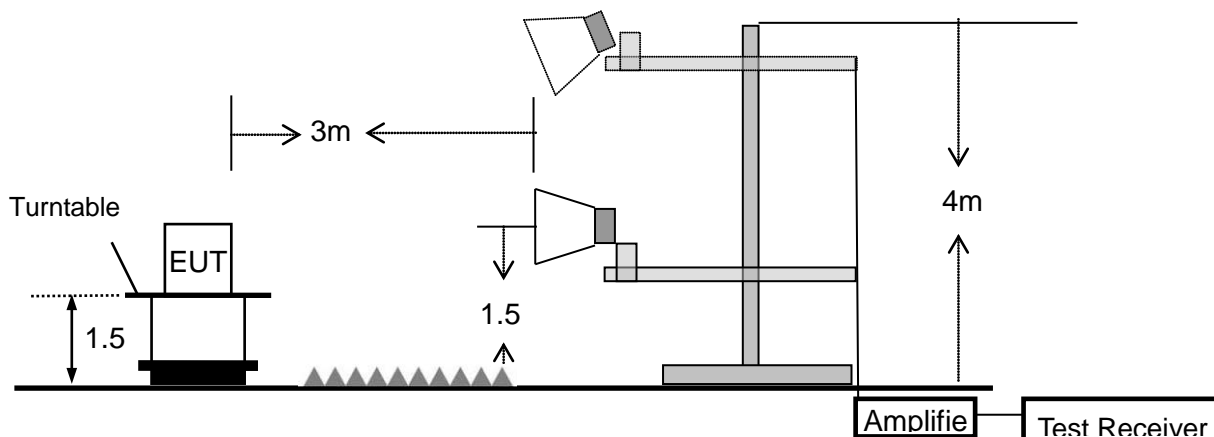

5.4.3 Test procedure

- a. EUT operating conditions. The EUT tested system was configured as the statements of 2.4 Unless otherwise a special operating condition is specified in the follows during the testing.
- b. The measuring distance of at 3 m shall be used for measurements at frequency up to 1GHz. For frequencies above 1GHz, any suitable measuring distance may be used.
- c. The EUT was placed on the top of a rotating table 0.8 meters above the ground at a 3 meter open area test site. The table was rotated 360 degrees to determine the position of the highest radiation.
- d. The height of the equipment or of the substitution antenna shall be 0.8 m; the height of the test antenna shall vary between 1 m to 4 m. Both horizontal and vertical polarizations of the antenna are set to make the measurement.
- e. For emission measurements above 1 GHz, the EUT shall be placed at a height of 1.5 m above the floor on a support that is RF transparent for the frequencies of interest. Final measurements for the EUT require a measurement antenna height scan of 1 m to 4 m.
- f. The initial step in collecting conducted emission data is a spectrum analyzer peak detector mode pre-scanning the measurement frequency range. Significant peaks are then marked and then Quasi Peak detector mode re-measured.
- g. If the Peak Mode measured value compliance with and lower than Quasi Peak Mode Limit, the EUT shall be deemed to meet QP Limits and then no additional QP Mode measurement performed.
- h. For the actual test configuration, please refer to the related Item –EUT Test photos.

Note: Both horizontal and vertical antenna polarities were tested . The worst case emissions were reported.

During the radiated emission test, the Spectrum Analyzer was set with the following configurations:

| Frequency Band (MHz) | Function | Resolution bandwidth | Video Bandwidth |
|----------------------|----------|----------------------|-----------------|
| 30 to 1000 | QP | 120 kHz | 300 kHz |
| Above 1000 | Peak | 1 MHz | 1 MHz |
| | Average | 1 MHz | 10 Hz |

Note: for the frequency ranges below 30 MHz, a narrower RBW is used for these ranges but the measured value should add a RBW correction factor (RBWCF) where $RBWCF [dB] = 10 \cdot \lg(100 [kHz] / \text{narrower RBW [kHz]})$. , the narrower RBW is 1 kHz and RBWCF is 20 dB for the frequency 9 kHz to 150 kHz, and the narrower RBW is 10 kHz and RBWCF is 10 dB for the frequency 150 kHz to 30 MHz.

5.4.4 Test results

5.4.4.1 Radiation emission

Below 30MHz

| | | | |
|--------------|-------------------|--------------------|---------------------|
| EUT: | Bluetooth Headset | Model Name: | JBuds Air Executive |
| Temperature: | 20 °C | Relative Humidity: | 48% |
| Pressure: | 1010 hPa | Test Voltage: | DC 3.7V by battery |
| Test Mode: | TX | Polarization : | -- |

| Freq. | Reading | Limit | Margin | State |
|-------|----------|----------|--------|-------|
| (MHz) | (dBuV/m) | (dBuV/m) | (dB) | P/F |
| -- | -- | -- | -- | Pass |
| -- | -- | -- | -- | Pass |

Note:

The amplitude of spurious emissions which are attenuated by more than 20dB below the permissible value has no need to be reported.

Distance extrapolation factor = $40 \log(\text{specific distance}/\text{test distance})$ (dB);

Limit line = specific limits(dBuV) + distance extrapolation factor.

Between 30MHz – 1GHz

Note1 : Emission Level = Meter Reading + Factor, Margin= Emission Level- Limit, Factor = Antenna Factor + Cable Loss – Pre-amplifier.

Note2: The three modulated high, medium and low channels have been tested. The report only shows the worst mode. The worst mode is GFSK CH78

| | | | |
|--------------------|-------------------|----------------|---------------------|
| EUT : | Bluetooth Headset | Model Name : | JBuds Air Executive |
| Relative Humidity: | 52% | Phase: | H |
| Pressure: | 1010 hPa | Test Voltage : | DC 3.7V by battery |
| Test Mode : | TX | | |

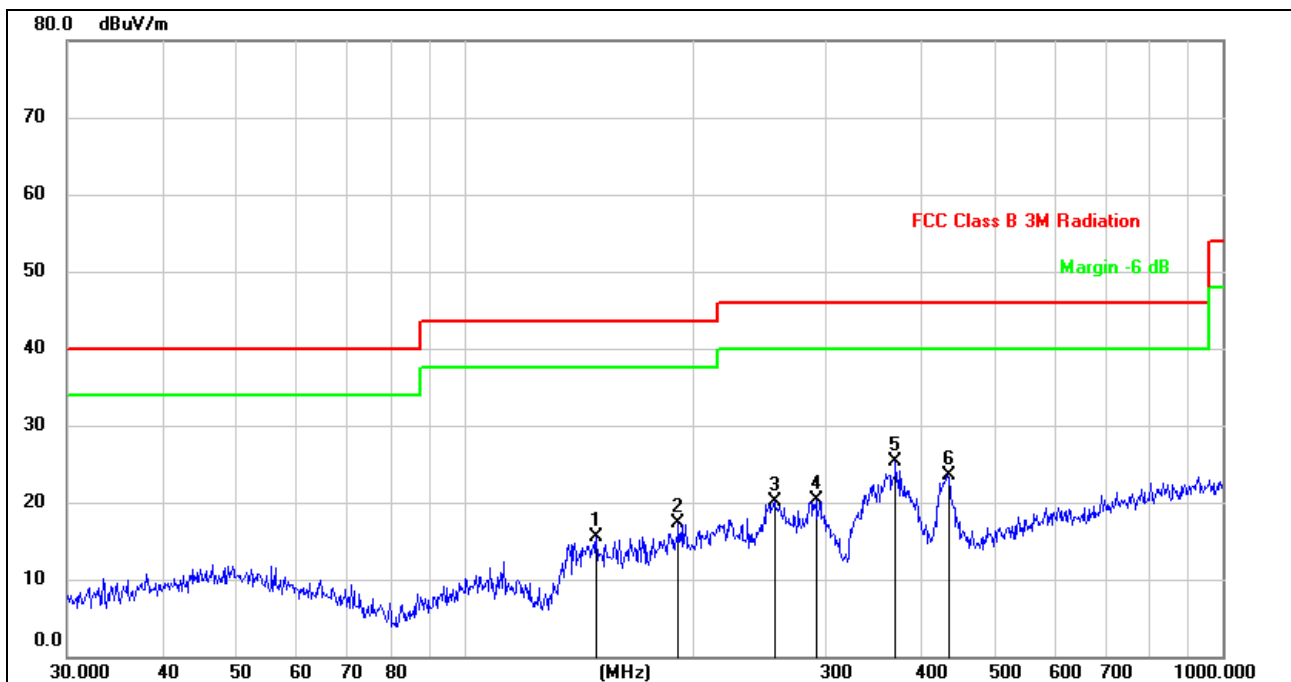

| No. | Mk. | Freq. MHz | Reading Level dBuV | Correct Factor dBuV/m | Measure- ment dBuV/m | Limit dBuV/m | Over dB | Detector |
|-----|-----|--------------|--------------------------|-----------------------------|----------------------------|-----------------|------------|----------|
| 1 | | 149.4857 | 31.96 | -16.51 | 15.45 | 43.50 | -28.05 | QP |
| 2 | | 191.7450 | 30.98 | -13.63 | 17.35 | 43.50 | -26.15 | QP |
| 3 | | 256.5211 | 31.91 | -11.75 | 20.16 | 46.00 | -25.84 | QP |
| 4 | | 291.0360 | 31.48 | -11.19 | 20.29 | 46.00 | -25.71 | QP |
| 5 | * | 370.7023 | 35.08 | -9.87 | 25.21 | 46.00 | -20.79 | QP |
| 6 | | 434.0651 | 32.44 | -8.91 | 23.53 | 46.00 | -22.47 | QP |

| | | | |
|--------------------|-------------------|----------------|---------------------|
| EUT : | Bluetooth Headset | Model Name : | JBuds Air Executive |
| Relative Humidity: | 52% | Phase: | V |
| Pressure: | 1010 hPa | Test Voltage : | DC 3.7V by battery |
| Test Mode : | TX | | |

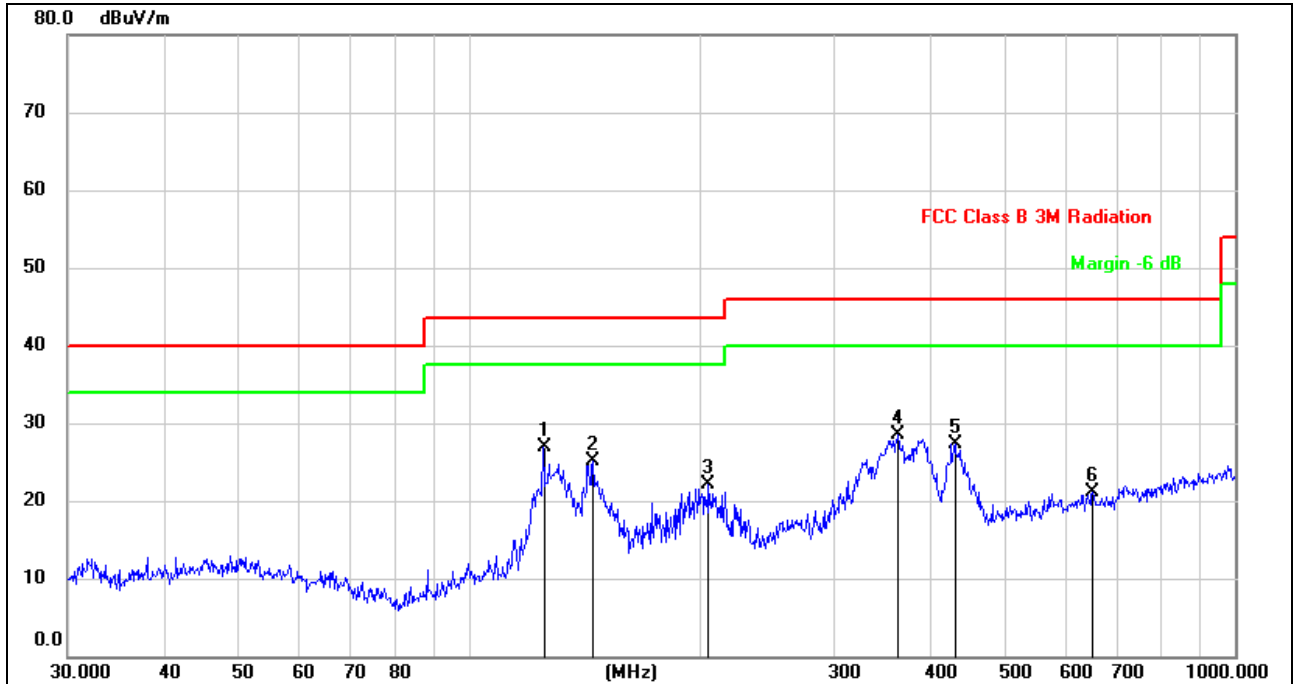

| No. | Mk. | Freq. MHz | Reading Level dBuV | Correct Factor dBuV/m | Measure- ment dBuV/m | Limit dBuV/m | Over dB | Detect |
|-----|-----|--------------|--------------------------|-----------------------------|----------------------------|-----------------|------------|--------|
| 1 | * | 125.0066 | 42.77 | -15.89 | 26.88 | 43.50 | -16.62 | QP |
| 2 | | 145.3505 | 41.69 | -16.62 | 25.07 | 43.50 | -18.43 | QP |
| 3 | | 205.6750 | 35.21 | -13.01 | 22.20 | 43.50 | -21.30 | QP |
| 4 | | 362.9844 | 38.39 | -9.83 | 28.56 | 46.00 | -17.44 | QP |
| 5 | | 431.0316 | 36.16 | -8.89 | 27.27 | 46.00 | -18.73 | QP |
| 6 | | 651.9416 | 27.41 | -6.40 | 21.01 | 46.00 | -24.99 | QP |

1G-25GHz

- Note: (1) All Readings are Peak Value (VBW=3MHz) and AV Value (VBW=10Hz).
 (2) Emission Level= Antenna Factor + Cable Loss + Read Level - Preamp Factor
 (3) All other emissions more than 20dB below the limit.

All the modulation modes have been tested, and the worst result was report as below:

| Frequency (MHz) | Read Level (dBμV) | Cable loss (dB) | Antenna Factor dB/m | Preamp Factor (dB) | Emission Level (dBμV/m) | Limits (dBμV/m) | Margin (dB) | Remark | Comment |
|--|----------------------|--------------------|------------------------|-----------------------|----------------------------|--------------------|----------------|--------|------------|
| Low Channel (2402 MHz)(GFSK)--Above 1G | | | | | | | | | |
| 4804.03 | 64.08 | 5.21 | 35.59 | 44.30 | 60.58 | 74.00 | -13.42 | Pk | Vertical |
| 4804.03 | 42.12 | 5.21 | 35.59 | 44.30 | 38.62 | 54.00 | -15.38 | AV | Vertical |
| 7206.27 | 61.76 | 6.48 | 36.27 | 44.60 | 59.91 | 74.00 | -14.09 | Pk | Vertical |
| 7206.27 | 44.50 | 6.48 | 36.27 | 44.60 | 42.65 | 54.00 | -11.35 | AV | Vertical |
| 4804.11 | 61.63 | 5.21 | 35.55 | 44.30 | 58.09 | 74.00 | -15.91 | Pk | Horizontal |
| 4804.11 | 42.50 | 5.21 | 35.55 | 44.30 | 38.96 | 54.00 | -15.04 | AV | Horizontal |
| 7206.22 | 63.41 | 6.48 | 36.27 | 44.52 | 61.64 | 74.00 | -12.36 | Pk | Horizontal |
| 7206.22 | 46.94 | 6.48 | 36.27 | 44.52 | 45.17 | 54.00 | -8.83 | AV | Horizontal |
| Mid Channel (2441 MHz)(GFSK)--Above 1G | | | | | | | | | |
| 4882.4 | 62.97 | 5.21 | 35.66 | 44.20 | 59.64 | 74.00 | -14.36 | Pk | Vertical |
| 4882.4 | 43.61 | 5.21 | 35.66 | 44.20 | 40.28 | 54.00 | -13.72 | AV | Vertical |
| 7323.24 | 60.78 | 7.10 | 36.50 | 44.43 | 59.95 | 74.00 | -14.05 | Pk | Vertical |
| 7323.24 | 47.98 | 7.10 | 36.50 | 44.43 | 47.15 | 54.00 | -6.85 | AV | Vertical |
| 4882.11 | 60.82 | 5.21 | 35.66 | 44.20 | 57.49 | 74.00 | -16.51 | Pk | Horizontal |
| 4882.11 | 48.11 | 5.21 | 35.66 | 44.20 | 44.78 | 54.00 | -9.22 | AV | Horizontal |
| 7323.13 | 61.56 | 7.10 | 36.50 | 44.43 | 60.73 | 74.00 | -13.27 | Pk | Horizontal |
| 7323.13 | 41.60 | 7.10 | 36.50 | 44.43 | 40.77 | 54.00 | -13.23 | AV | Horizontal |
| High Channel (2480 MHz)(GFSK)-- Above 1G | | | | | | | | | |
| 4960.4 | 66.40 | 5.21 | 35.52 | 44.21 | 62.92 | 74.00 | -11.08 | Pk | Vertical |
| 4960.4 | 42.52 | 5.21 | 35.52 | 44.21 | 39.04 | 54.00 | -14.96 | AV | Vertical |
| 7440.2 | 62.53 | 7.10 | 36.53 | 44.60 | 61.56 | 74.00 | -12.44 | Pk | Vertical |
| 7440.2 | 45.83 | 7.10 | 36.53 | 44.60 | 44.86 | 54.00 | -9.14 | AV | Vertical |
| 4960.23 | 67.44 | 5.21 | 35.52 | 44.21 | 63.96 | 74.00 | -10.04 | Pk | Horizontal |
| 4960.23 | 48.35 | 5.21 | 35.52 | 44.21 | 44.87 | 54.00 | -9.13 | AV | Horizontal |
| 7440.3 | 61.41 | 7.10 | 36.53 | 44.60 | 60.44 | 74.00 | -13.56 | Pk | Horizontal |
| 7440.3 | 44.88 | 7.10 | 36.53 | 44.60 | 43.91 | 54.00 | -10.09 | AV | Horizontal |

5.4.4.2 Band edge – radiated

All the modulation modes have been tested, and the worst result was report as below:

| Frequency (MHz) | Meter Reading (dBμV) | Cable Loss (dB) | Antenna Factor dB/m | Preamp Factor (dB) | Emission Level (dBμV/m) | Limits (dBμV/m) | Margin (dB) | Detector Type | Comment |
|--------------------------|----------------------------|-----------------------|---------------------------|--------------------------|-------------------------------|--------------------|----------------|------------------|------------|
| 1Mbps (GFSK)-hopping | | | | | | | | | |
| 2310.00 | 56.36 | 2.97 | 27.80 | 43.80 | 43.33 | 74 | -30.67 | Pk | Horizontal |
| 2310.00 | 43.93 | 2.97 | 27.80 | 43.80 | 30.90 | 54 | -23.10 | AV | Horizontal |
| 2310.00 | 58.69 | 2.97 | 27.80 | 43.80 | 45.66 | 74 | -28.34 | Pk | Vertical |
| 2310.00 | 42.13 | 2.97 | 27.80 | 43.80 | 29.10 | 54 | -24.90 | AV | Vertical |
| 2390.00 | 57.74 | 3.14 | 27.21 | 43.80 | 44.29 | 74 | -29.71 | Pk | Vertical |
| 2390.00 | 42.36 | 3.14 | 27.21 | 43.80 | 28.91 | 54 | -25.09 | AV | Vertical |
| 2390.00 | 58.04 | 3.14 | 27.21 | 43.80 | 44.59 | 74 | -29.41 | Pk | Horizontal |
| 2390.00 | 41.88 | 3.14 | 27.21 | 43.80 | 28.43 | 54 | -25.57 | AV | Horizontal |
| 2483.50 | 58.65 | 3.58 | 27.70 | 44.00 | 45.93 | 74 | -28.07 | Pk | Vertical |
| 2483.50 | 42.86 | 3.58 | 27.70 | 44.00 | 30.14 | 54 | -23.86 | AV | Vertical |
| 2483.50 | 58.98 | 3.58 | 27.70 | 44.00 | 46.26 | 74 | -27.74 | Pk | Horizontal |
| 2483.50 | 41.71 | 3.58 | 27.70 | 44.00 | 28.99 | 54 | -25.01 | AV | Horizontal |
| 1Mbps(GFSK)- Non-hopping | | | | | | | | | |
| 2310.00 | 56.36 | 2.97 | 27.80 | 43.80 | 43.33 | 74 | -30.67 | Pk | Horizontal |
| 2310.00 | 43.81 | 2.97 | 27.80 | 43.80 | 30.78 | 54 | -23.22 | AV | Horizontal |
| 2310.00 | 59.39 | 2.97 | 27.80 | 43.80 | 46.36 | 74 | -27.64 | Pk | Vertical |
| 2310.00 | 43.71 | 2.97 | 27.80 | 43.80 | 30.68 | 54 | -23.32 | AV | Vertical |
| 2390.00 | 58.52 | 3.14 | 27.21 | 43.80 | 45.07 | 74 | -28.93 | Pk | Vertical |
| 2390.00 | 42.38 | 3.14 | 27.21 | 43.80 | 28.93 | 54 | -25.07 | AV | Vertical |
| 2390.00 | 57.82 | 3.14 | 27.21 | 43.80 | 44.37 | 74 | -29.63 | Pk | Horizontal |
| 2390.00 | 42.16 | 3.14 | 27.21 | 43.80 | 28.71 | 54 | -25.29 | AV | Horizontal |
| 2483.50 | 59.32 | 3.58 | 27.70 | 44.00 | 46.60 | 74 | -27.40 | Pk | Vertical |
| 2483.50 | 42.18 | 3.58 | 27.70 | 44.00 | 29.46 | 54 | -24.54 | AV | Vertical |
| 2483.50 | 59.32 | 3.58 | 27.70 | 44.00 | 46.60 | 74 | -27.40 | Pk | Horizontal |
| 2483.50 | 42.15 | 3.58 | 27.70 | 44.00 | 29.43 | 54 | -24.57 | AV | Horizontal |

5.4.4.3 Spurious Emission in Restricted Band 3260MHz-18000MHz

All the modulation modes have been tested, and the worst result was report as below:

| Frequency (MHz) | Reading Level (dB μ V) | Cable Loss (dB) | Antenna Factor (dB/m) | Preamplifier Factor (dB) | Emission Level (dB μ V/m) | Limits (dB μ V/m) | Margin (dB) | Detector Type | Comment |
|--------------------|-------------------------------|--------------------|--------------------------|-----------------------------|----------------------------------|--------------------------|----------------|---------------|------------|
| 3260 | 60.21 | 4.04 | 29.57 | 44.70 | 49.12 | 74 | -24.88 | Pk | Vertical |
| 3260 | 50.02 | 4.04 | 29.57 | 44.70 | 38.93 | 54 | -15.07 | AV | Vertical |
| 3260 | 62.33 | 4.04 | 29.57 | 44.70 | 51.24 | 74 | -22.76 | Pk | Horizontal |
| 3260 | 51.25 | 4.04 | 29.57 | 44.70 | 40.16 | 54 | -13.84 | AV | Horizontal |
| 3332 | 64.27 | 4.26 | 29.87 | 44.40 | 54.00 | 74 | -20.00 | Pk | Vertical |
| 3332 | 54.72 | 4.26 | 29.87 | 44.40 | 44.45 | 54 | -9.55 | AV | Vertical |
| 3332 | 64.03 | 4.26 | 29.87 | 44.40 | 53.76 | 74 | -20.24 | Pk | Horizontal |
| 3332 | 53.51 | 4.26 | 29.87 | 44.40 | 43.24 | 54 | -10.76 | AV | Horizontal |
| 17797 | 43.31 | 10.99 | 43.95 | 43.50 | 54.75 | 74 | -19.25 | Pk | Vertical |
| 17797 | 33.44 | 10.99 | 43.95 | 43.50 | 44.88 | 54 | -9.12 | AV | Vertical |
| 17788 | 45.67 | 11.81 | 43.69 | 44.60 | 56.57 | 74 | -17.43 | Pk | Horizontal |
| 17788 | 32.58 | 11.81 | 43.69 | 44.60 | 43.48 | 54 | -10.52 | AV | Horizontal |

5.5 20dB occupied channel bandwidth

5.5.1 Limit

| FCC Part15 (15.247) , Subpart C | | | |
|---------------------------------|----------------|-------|-----------------------|
| Section | Test Item | Limit | Frequency Range (MHz) |
| 15.247a(1) | 20dB bandwidth | N/A | 2400-2483.5 |

5.5.2 Test setup

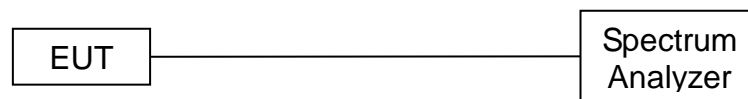

5.5.3 Test procedure

- (1) The EUT was directly connected to the spectrum analyzer and antenna output port as show in the block diagram above.
- (2) Spectrum Setting:
Bandwidth: RBW=30 kHz, VBW=100 kHz, detector= Peak

5.5.4 Test results

Test data

| | | | |
|---------------|-------------------|---------------------|---------------------|
| EUT : | Bluetooth Headset | Model Name : | JBuds Air Executive |
| Temperature : | 25 °C | Relative Humidity : | 60% |
| Pressure : | 1012 hPa | Test Voltage : | DC 3.7V by battery |

| Mode | Frequency (MHz) | 20dB Bandwidth (MHz) | Limit (kHz) | Result |
|----------------|-----------------|----------------------|-------------|--------|
| GFSK | 2402 | 1.022 | N/A | Pass |
| | 2441 | 0.9633 | N/A | Pass |
| | 2480 | 1.020 | N/A | Pass |
| π /4-DQPSK | 2402 | 1.370 | N/A | Pass |
| | 2441 | 1.369 | N/A | Pass |
| | 2480 | 1.369 | N/A | Pass |
| 8DPSK | 2402 | 1.352 | N/A | Pass |
| | 2441 | 1.350 | N/A | Pass |
| | 2480 | 1.351 | N/A | Pass |

Test plots

GFSK mode

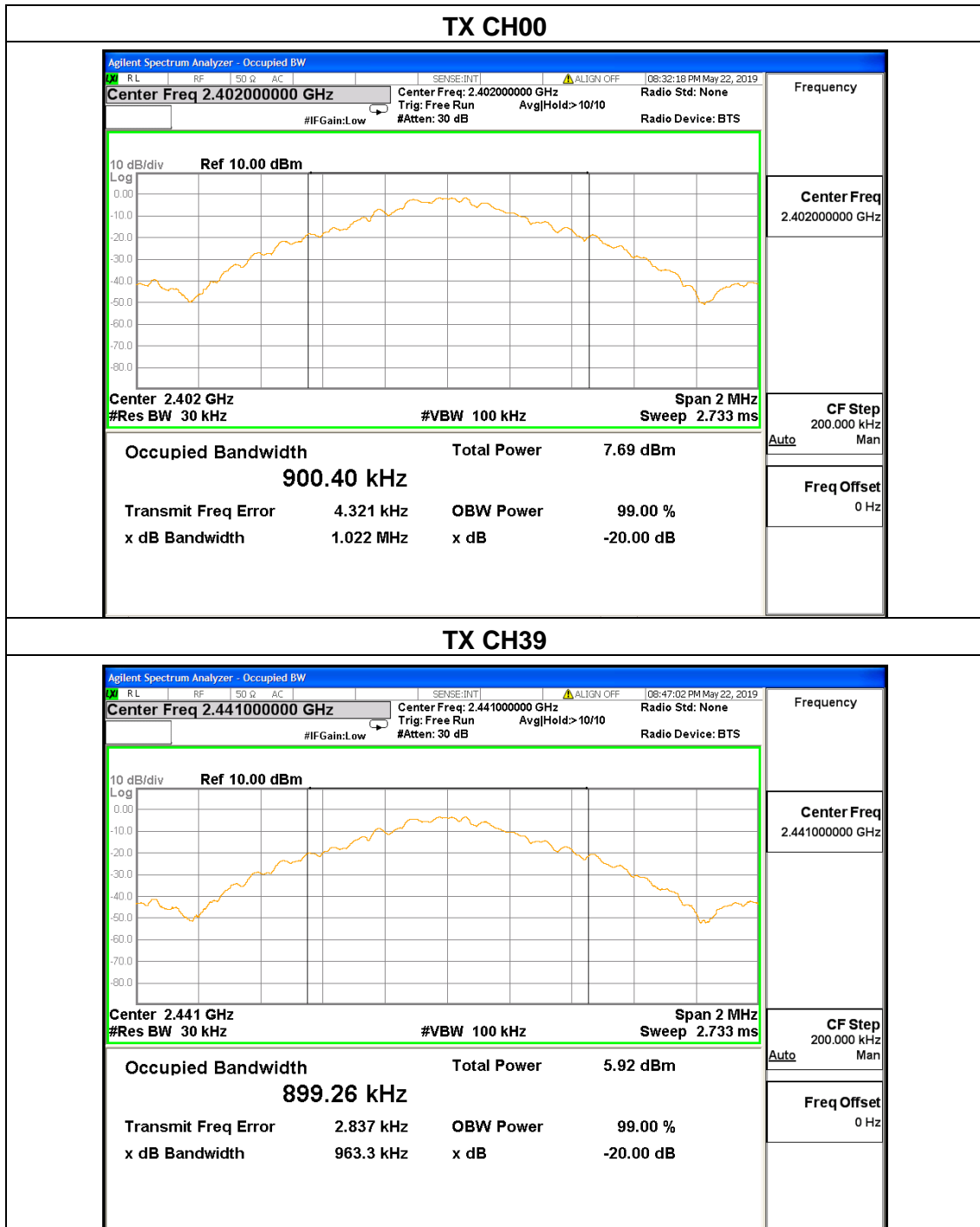

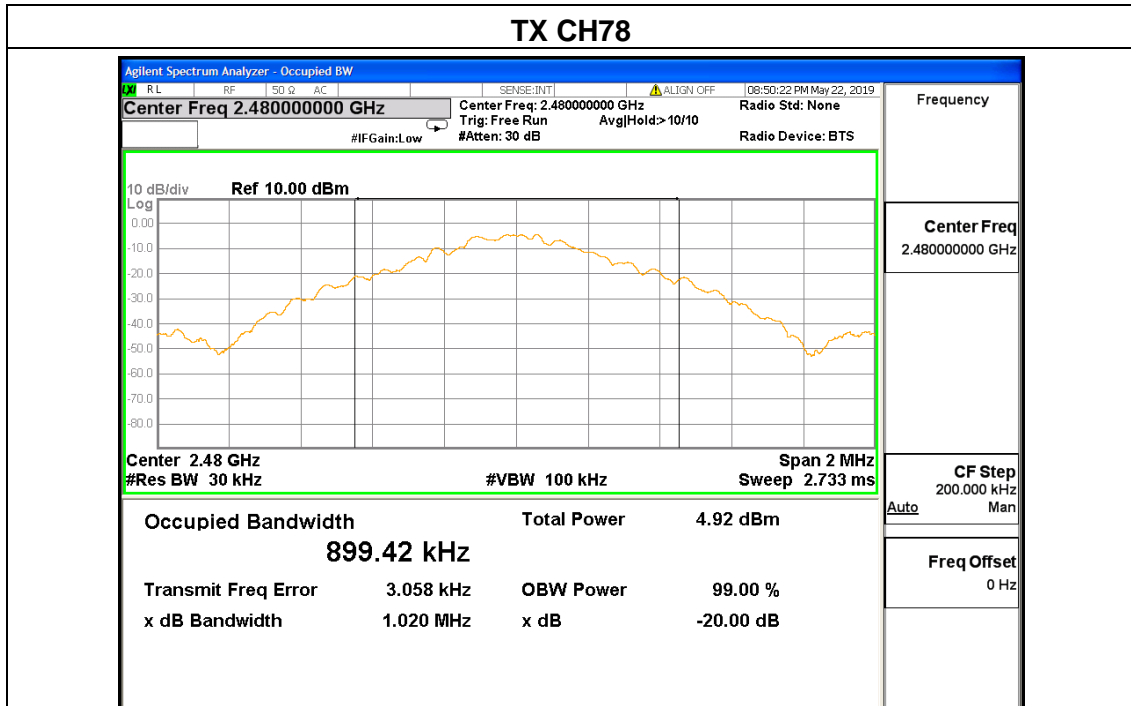

$\pi/4$ -DQPSK

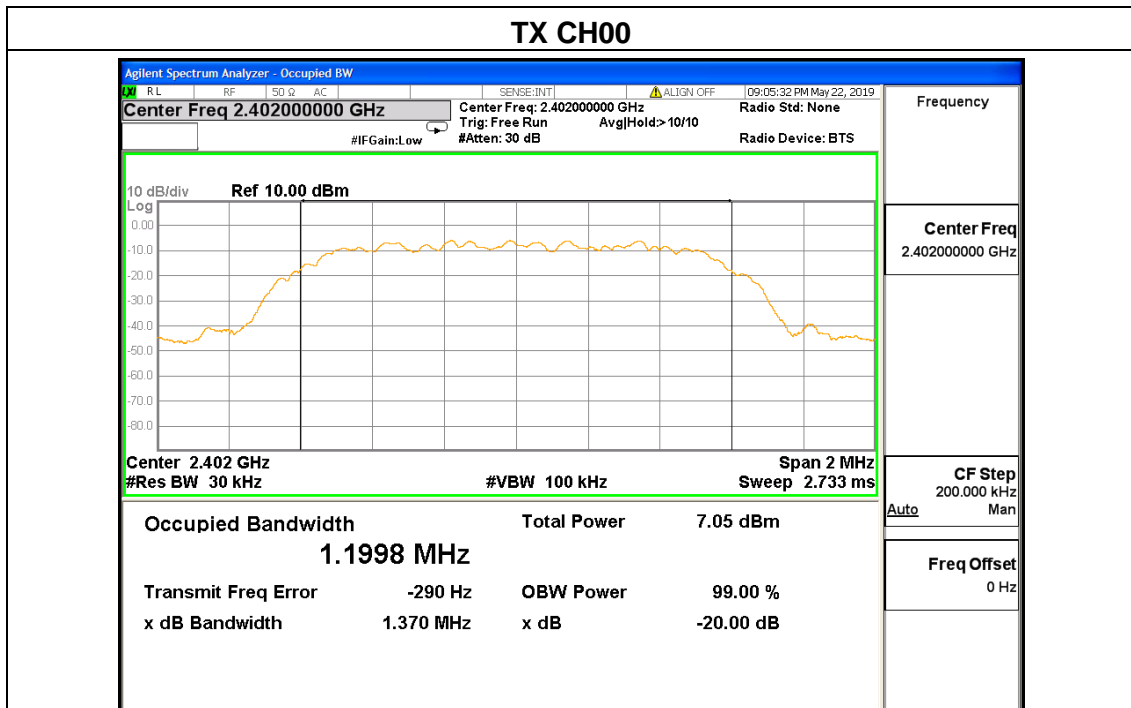

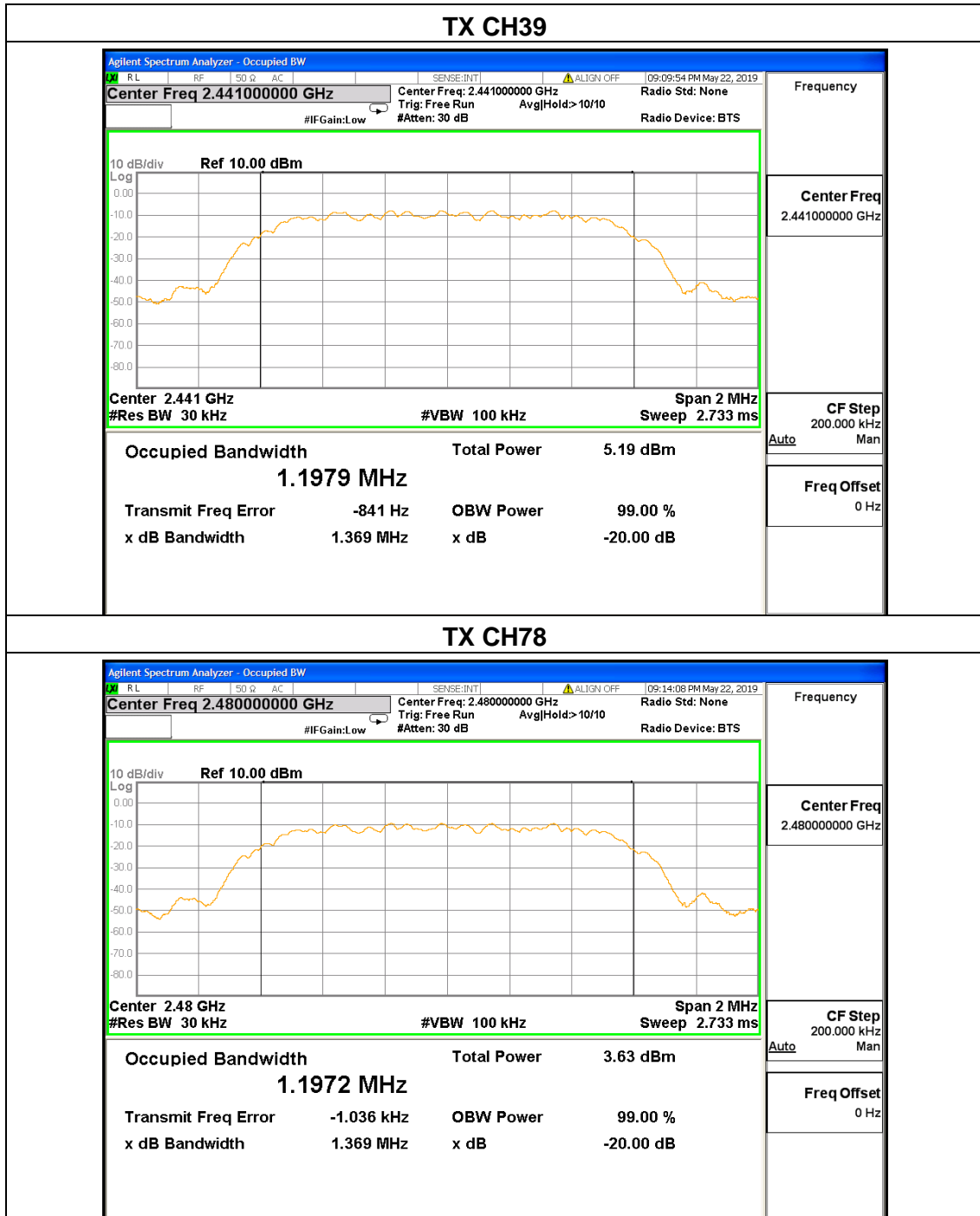

8DPSK mode

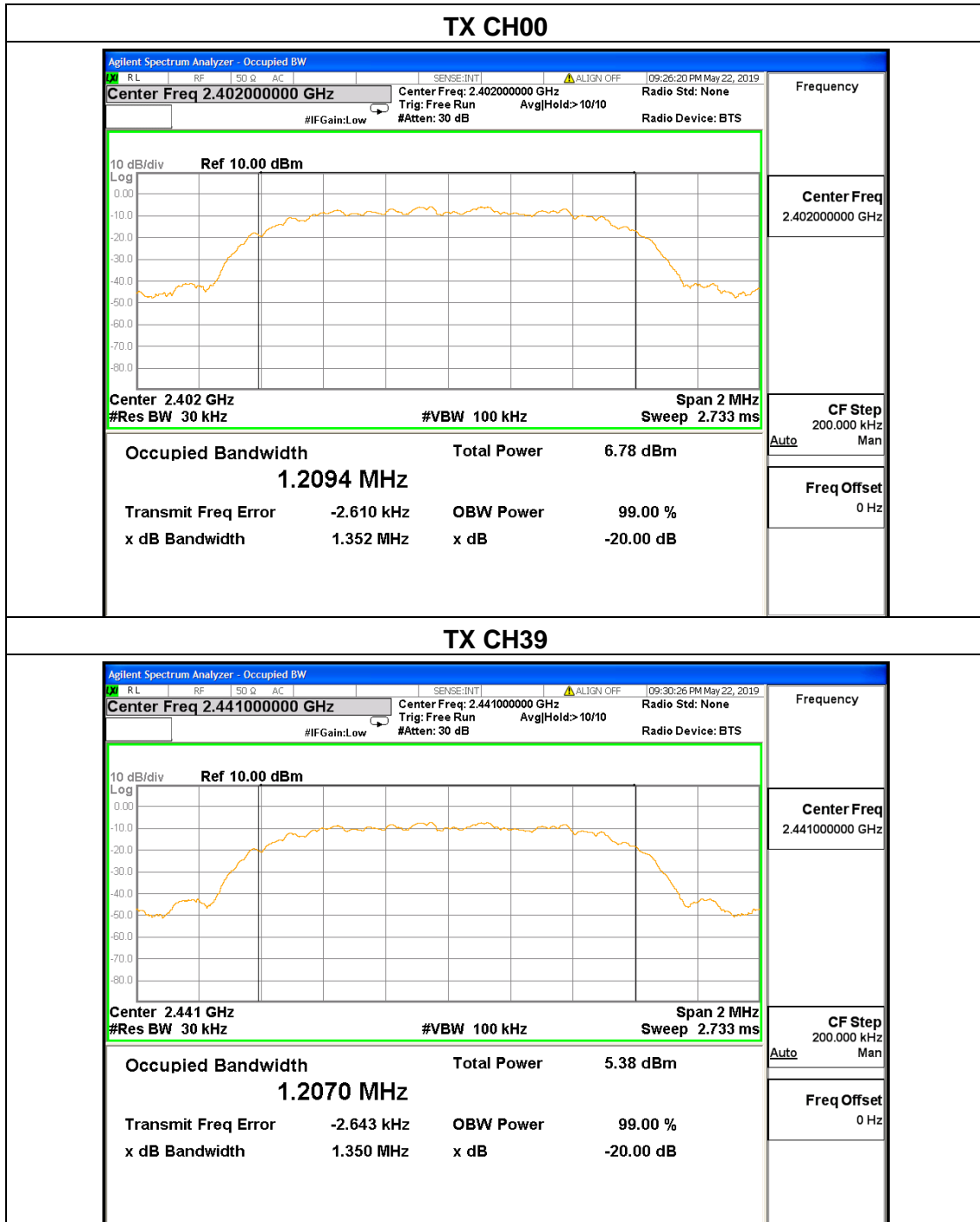

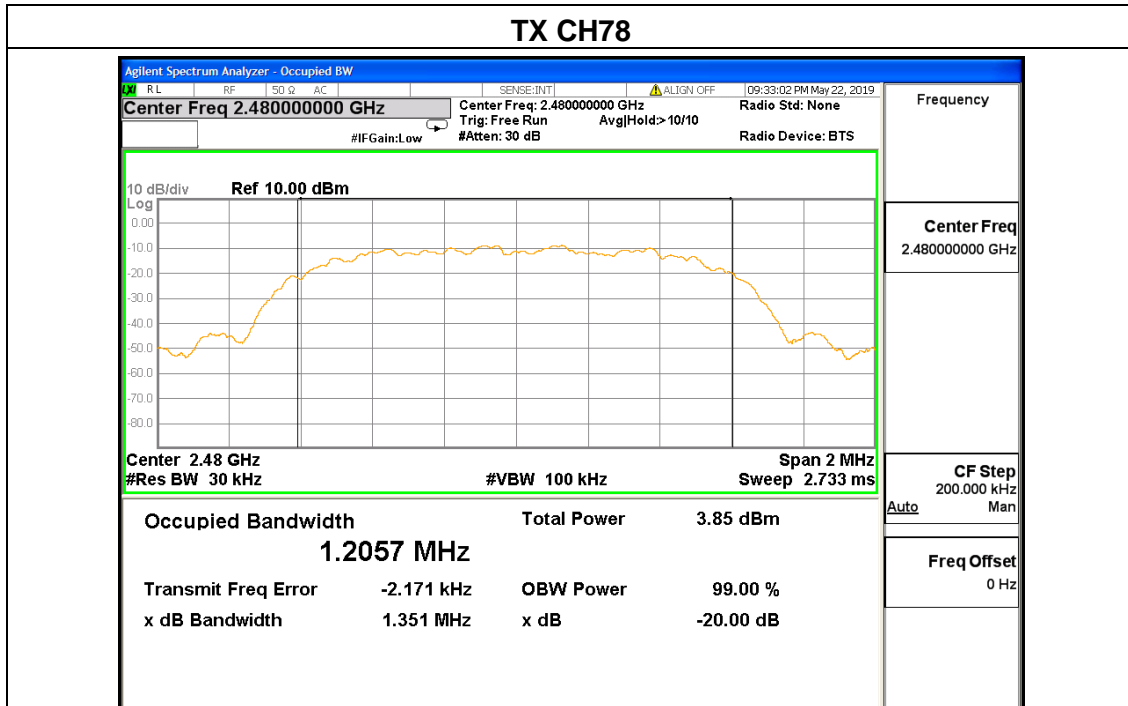

5.6 Carrier frequency separation

5.6.1 Limit

| FCC Part15 (15.247) , Subpart C | | | |
|---------------------------------|--------------------|---|-----------------------|
| Section | Test Item | Limit | Frequency Range (MHz) |
| 15.247(a)(1) | Channel Separation | >25KHz or >two-thirds of the 20 dB bandwidth (Which is greater) | 2400-2483.5 |

5.6.2 Test setup

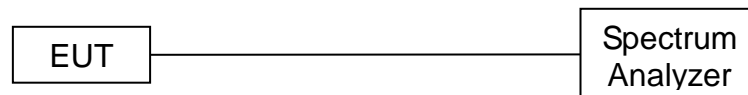

5.6.3 Test procedure

- (1) The EUT was directly connected to the spectrum analyzer and antenna output port as show in the block diagram above.
- (2) Spectrum Setting:
RBW=30 kHz, VBW=100 kHz, detector= Peak, Sweep Time =auto.
- (3) The EUT was set to the Hopping Mode for Channel Separation Test and continuously transmitting for the Test.

5.6.4 Test results

Test data

| | | | |
|---------------|---|---------------------|---------------------|
| EUT : | Bluetooth Headset | Model Name : | JBuds Air Executive |
| Temperature : | 25 °C | Relative Humidity : | 60% |
| Pressure : | 1012 hPa | Test Voltage : | DC 3.7V by battery |
| Test Mode : | GFSK, $\pi/4$ -DQPSK, 8DPSK /CH00, CH39, CH78 | | |

| Mode | Channel | Frequency (MHz) | Test Result (kHz) | Limit | | Result |
|----------------|---------|--------------------|----------------------|---------|----------------|--------|
| | | | | | (kHz) | |
| GFSK | Low | 2402 | 1000 | 681.333 | 2/3 of 20dB BW | Pass |
| | Middle | 2441 | 1005 | 642.200 | 2/3 of 20dB BW | Pass |
| | High | 2480 | 995 | 680.000 | 2/3 of 20dB BW | Pass |
| $\pi/4$ -DQPSK | Low | 2402 | 1005 | 913.333 | 2/3 of 20dB BW | Pass |
| | Middle | 2441 | 1005 | 912.667 | 2/3 of 20dB BW | Pass |
| | High | 2480 | 1000 | 912.667 | 2/3 of 20dB BW | Pass |
| 8DPSK | Low | 2402 | 1002 | 901.333 | 2/3 of 20dB BW | Pass |
| | Middle | 2441 | 1000 | 900.000 | 2/3 of 20dB BW | Pass |
| | High | 2480 | 1000 | 900.667 | 2/3 of 20dB BW | Pass |

Test plots

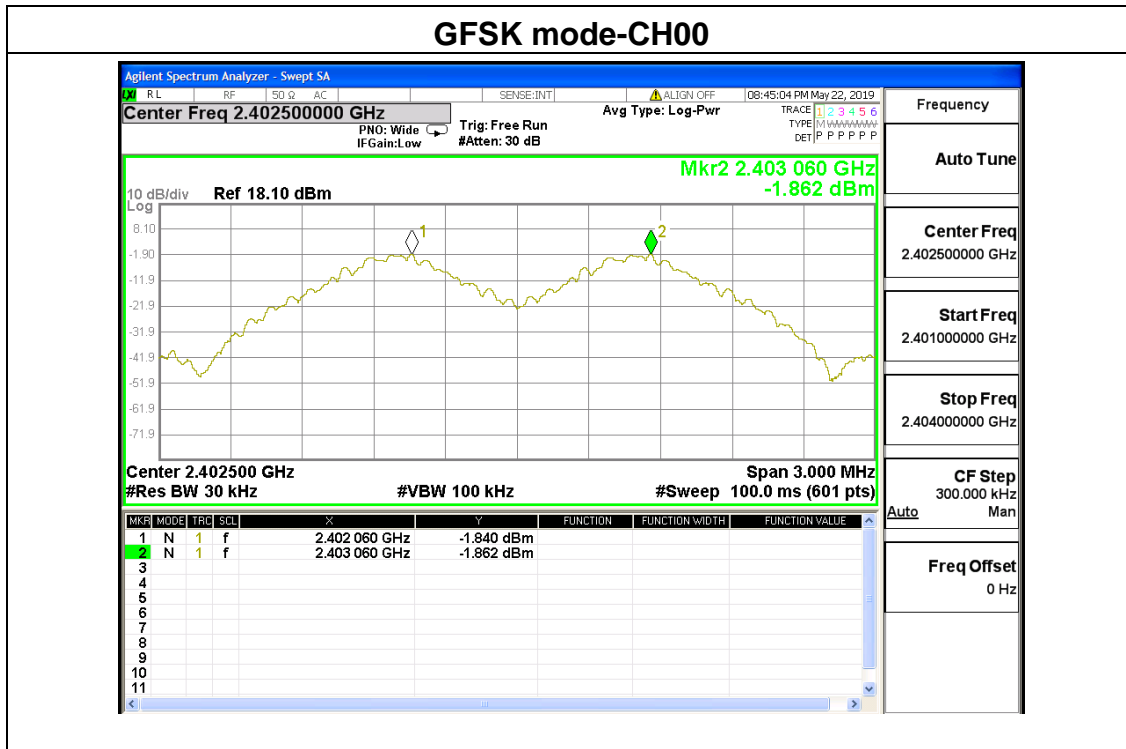

GFSK mode-CH39

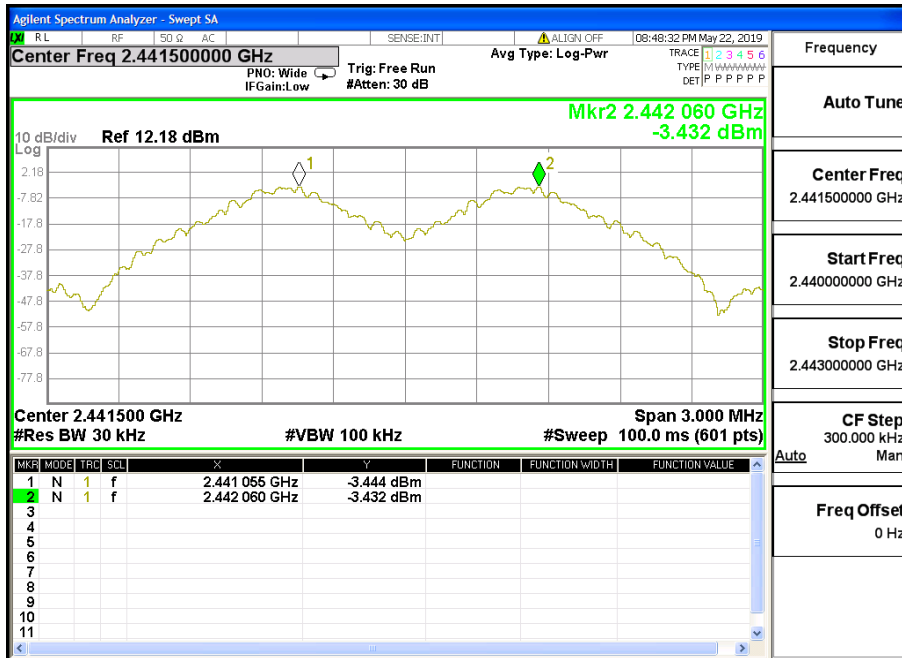

GFSK mode-CH78

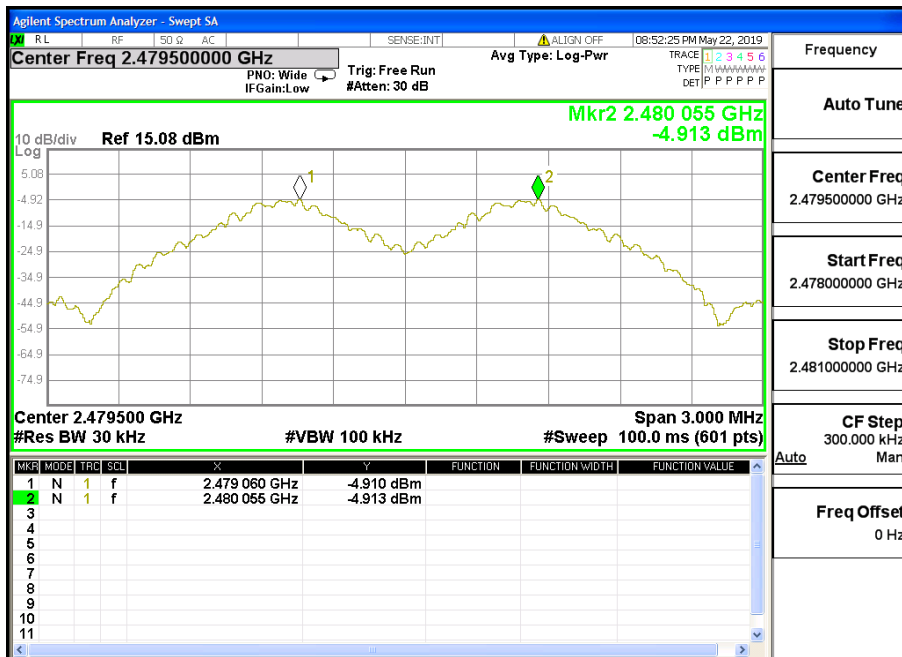

$\pi/4$ -DQPSK mode-CH00

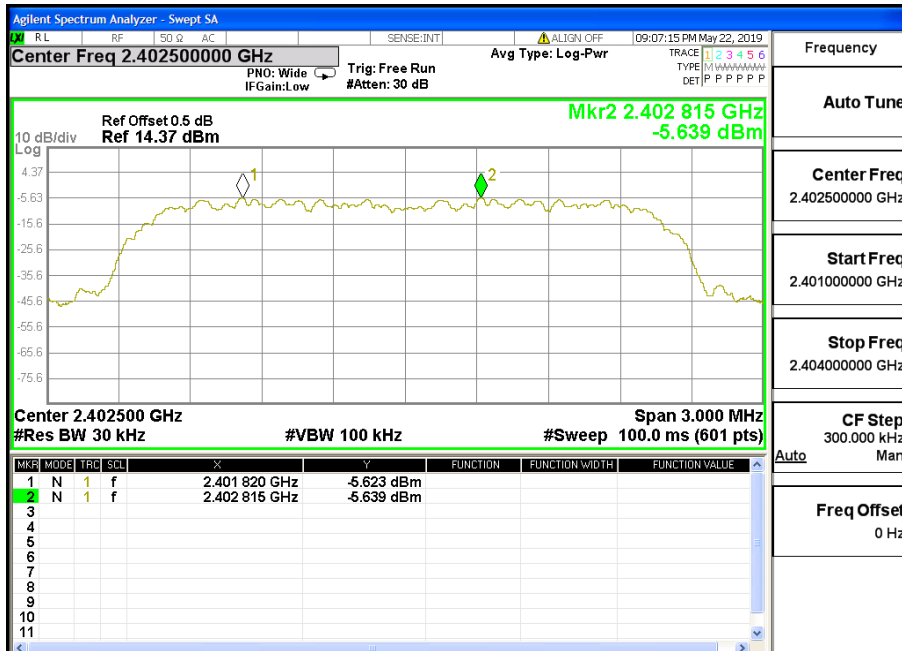

$\pi/4$ -DQPSK mode-CH39

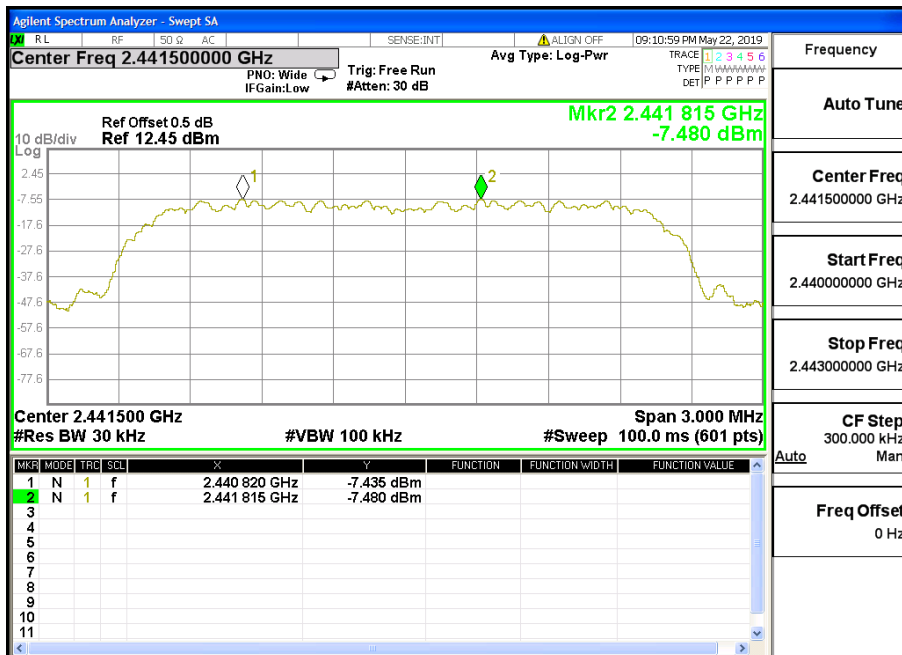

$\pi/4$ -DQPSK mode-CH78

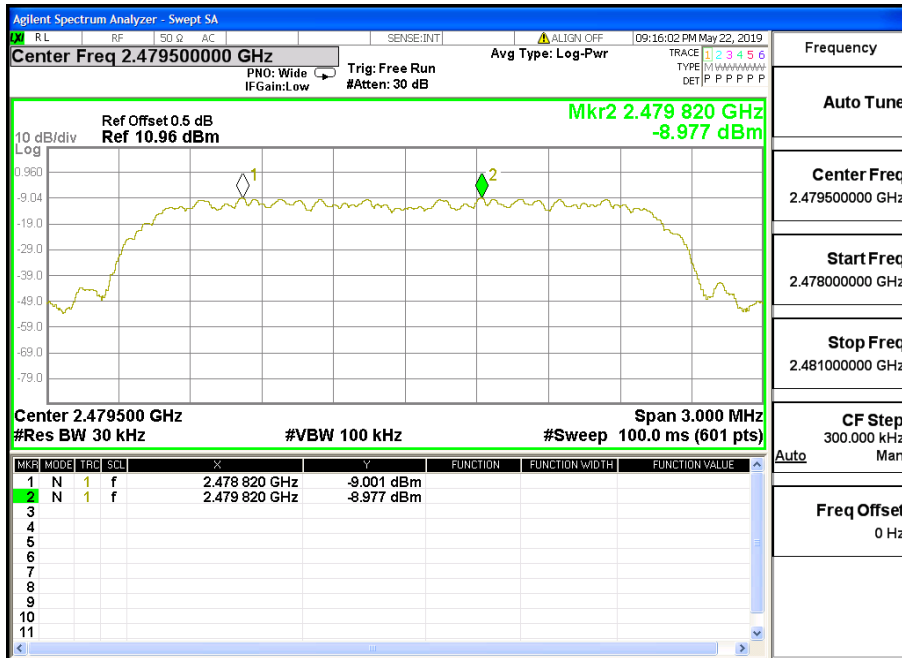

8DPSK mode-CH00

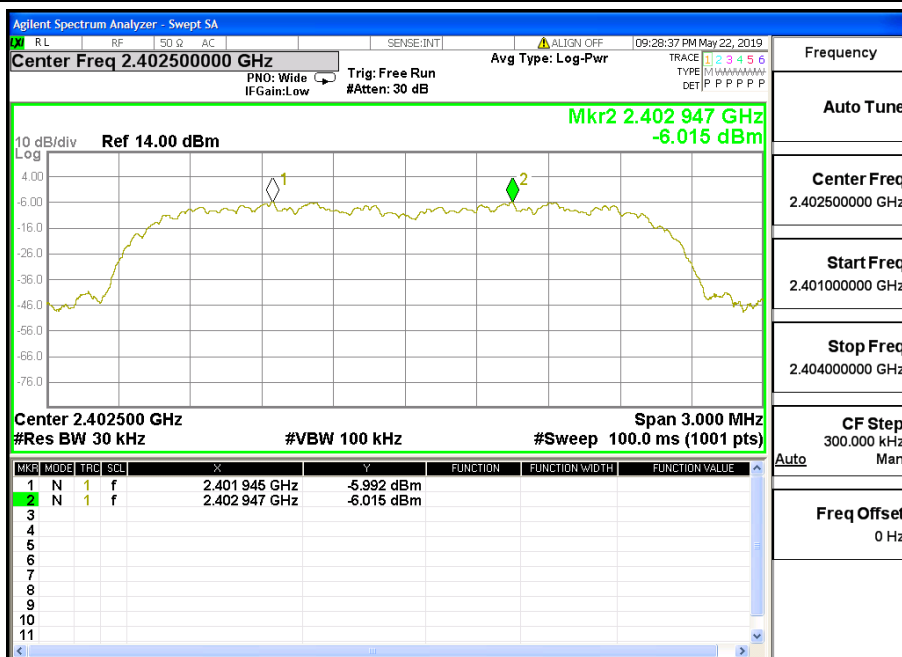

8DPSK mode-39

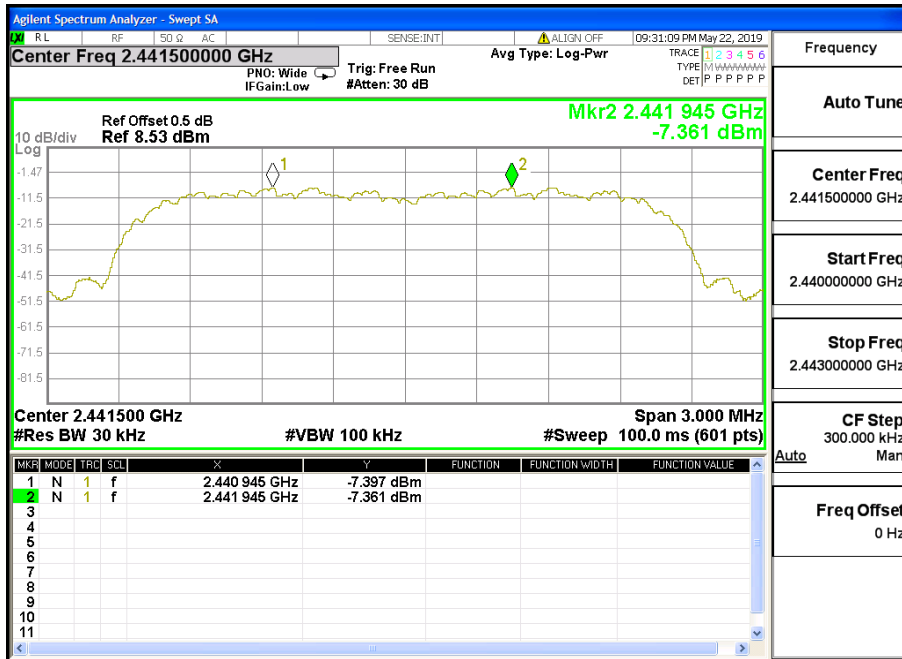

8DPSK mode-CH78

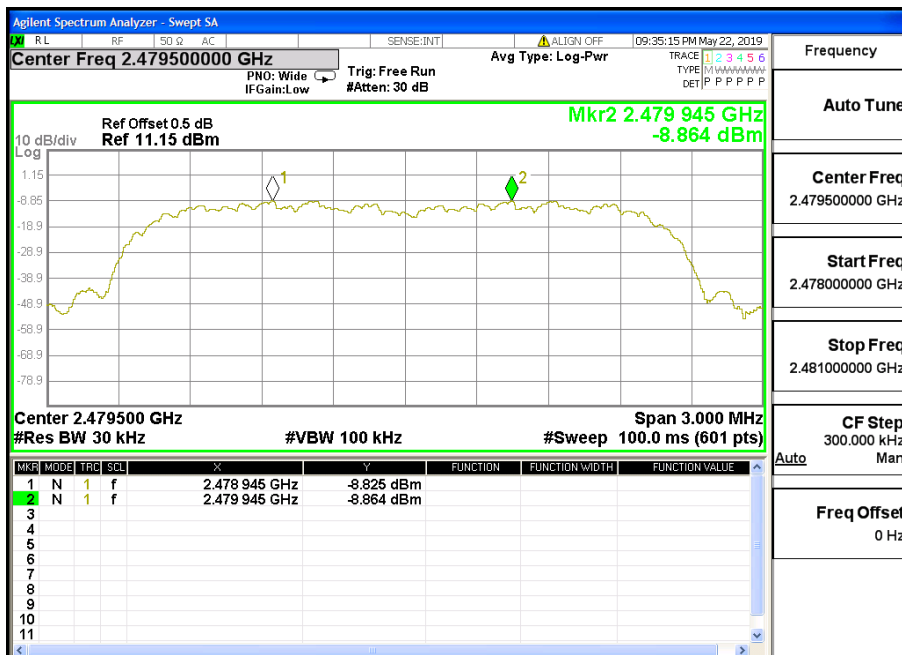

5.7 Hopping Channel

5.7.1 Limit

Frequency hopping systems in the 2400-2483.5MHz band shall use at least 15 channels.

5.7.2 Test setup

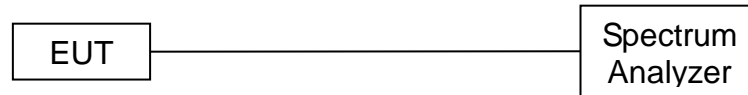

5.7.3 Test procedure

The testing follows ANSI C63.10-2013 clause 7.8.3

The RF output of EUT was connected to the spectrum analyzer by RF cable and attenuator.

The path loss was compensated to the results for each measurement.

Set to the maximum power setting and enable the EUT transmit continuously.

The EUT must have its hopping function enabled.

Use the following spectrum analyzer settings:

Span = the frequency band of operation

RBW : To identify clearly the individual channels, set the RBW to less than 30% of the channel spacing or the 20 dB bandwidth, whichever is smaller.

VBW \geq RBW

Sweep = auto

Detector function = peak

Trace = max hold

5.7.4 Test results

| Mode | Quantity of Hopping Channel | Limit | Results |
|-----------------------------|-----------------------------|-------|---------|
| GFSK, $\pi/4$ -DQPSK, 8DPSK | 79 | >15 | Pass |

Test plots

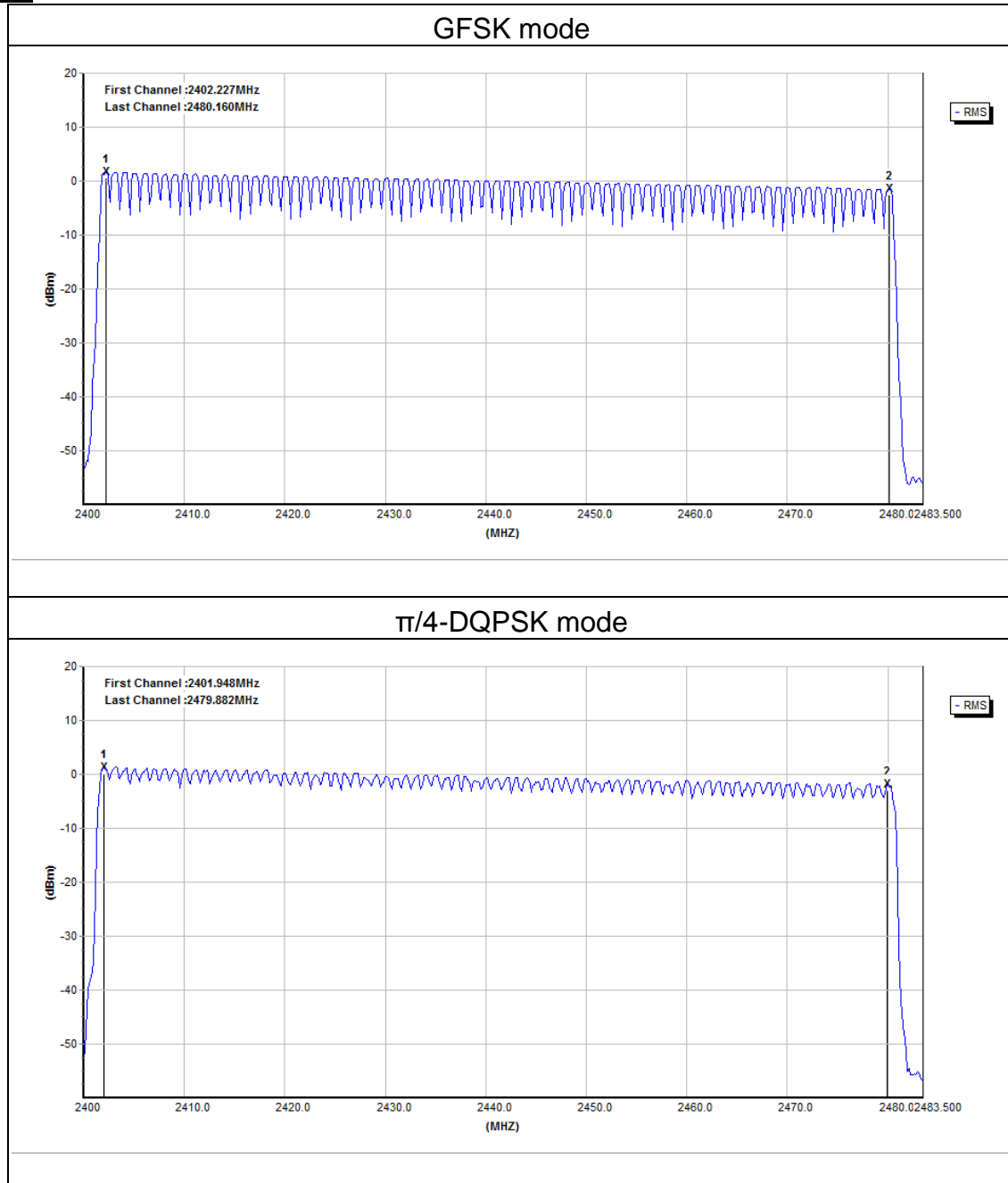

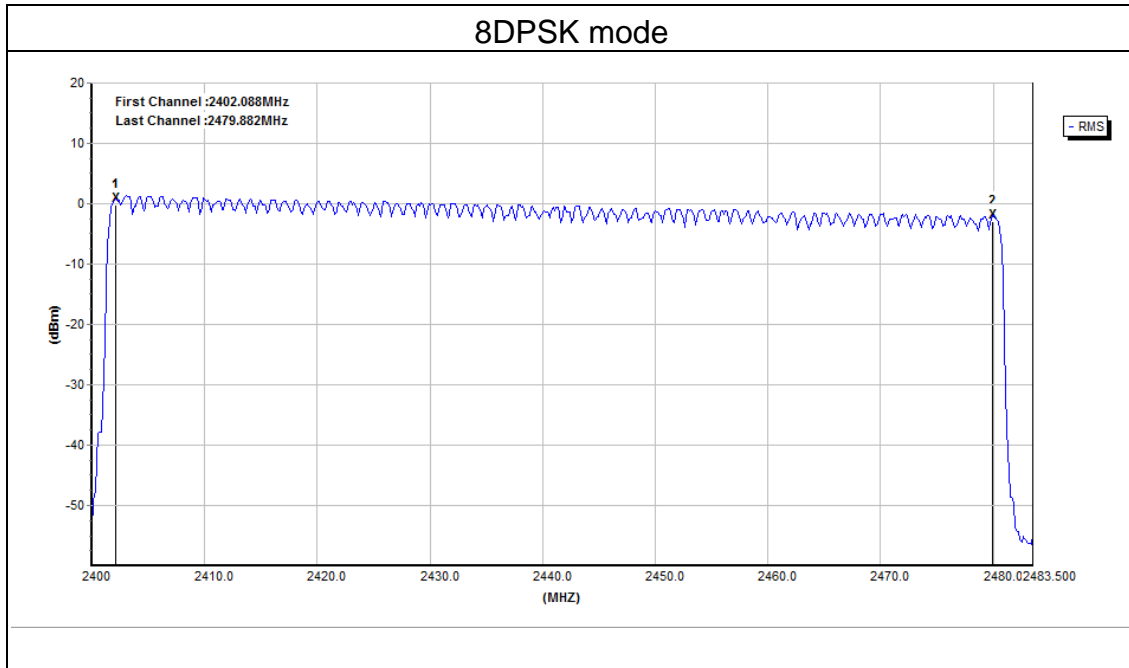

5.8 Dwell time

5.8.1 Limit

| FCC Part15 (15.247) , Subpart C | | | |
|---------------------------------|------------|---------|-----------------------|
| Section | Test Item | Limit | Frequency Range (MHz) |
| 15.247(a)(a) | Dwell time | 0.4 sec | 2400-2483.5 |

5.8.2 Test setup

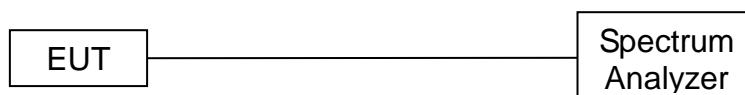

5.8.3 Test procedure

- (1) The EUT was directly connected to the spectrum analyzer and antenna output port as show in the block diagram above.
- (2) Spectrum Setting: RBW=1MHz, VBW=1MHz, Span=0Hz, Detector=Peak
- (3) Use video trigger with the trigger level set to enable triggering only on full pulses.
- (4) Sweep Time is more than once pulse time.
- (5) Set the center frequency on any frequency would be measure and set the frequency span to zero span.
- (6) Measure the maximum time duration of one single pulse.
- (7) Set the EUT for packet transmitting.
- (8) Measure the maximum time duration of one single pulse.
- (9) The EUT was set to the Hopping Mode for Dwell Time Test

5.8.4 Test results

Test data

| | | | |
|---------------|-----------------------------------|---------------------|---------------------|
| EUT : | Bluetooth Headset | Model Name : | JBuds Air Executive |
| Temperature : | 25 °C | Relative Humidity : | 60% |
| Pressure : | 1012 hPa | Test Voltage : | DC 3.7V by battery |
| Test Mode : | GFSK, $\pi/4$ -DQPSK, 8DPSK /CH39 | | |

| Mode | Data Packet | Frequency (MHz) | Pulse Duration (ms) | Dwell Time (ms) | Limit(s) | Conclusion |
|---------------|-------------|-----------------|---------------------|-----------------|----------|------------|
| GFSK | DH1 | 2441 | 0.39 | 124.80 | <0.4 | Pass |
| | DH3 | 2441 | 1.64 | 262.40 | <0.4 | Pass |
| | DH5 | 2441 | 2.9 | 309.33 | <0.4 | Pass |
| $\pi/4$ DQPSK | 2DH1 | 2441 | 0.38 | 121.60 | <0.4 | Pass |
| | 2DH3 | 2441 | 1.65 | 264.00 | <0.4 | Pass |
| | 2DH5 | 2441 | 2.9 | 309.33 | <0.4 | Pass |
| 8DPSK | 3DH1 | 2441 | 0.39 | 124.80 | <0.4 | Pass |
| | 3DH3 | 2441 | 1.65 | 264.00 | <0.4 | Pass |
| | 3DH5 | 2441 | 2.9 | 309.33 | <0.4 | Pass |

Note1: A period time = 0.4 (s) * 79 = 31.6(s)

Note2:

DH1 time slot = Pulse Duration * (1600/(2*79)) * A period time

DH3 time slot = Pulse Duration * (1600/(4*79)) * A period time

DH5 time slot = Pulse Duration * (1600/(6*79)) * A period time

Note3: For GFSK, $\pi/4$ -DQPSK and 8DPSK: The test period: T= 0.4 Second/Channel x 79 Channel = 31.6 s

Test plots

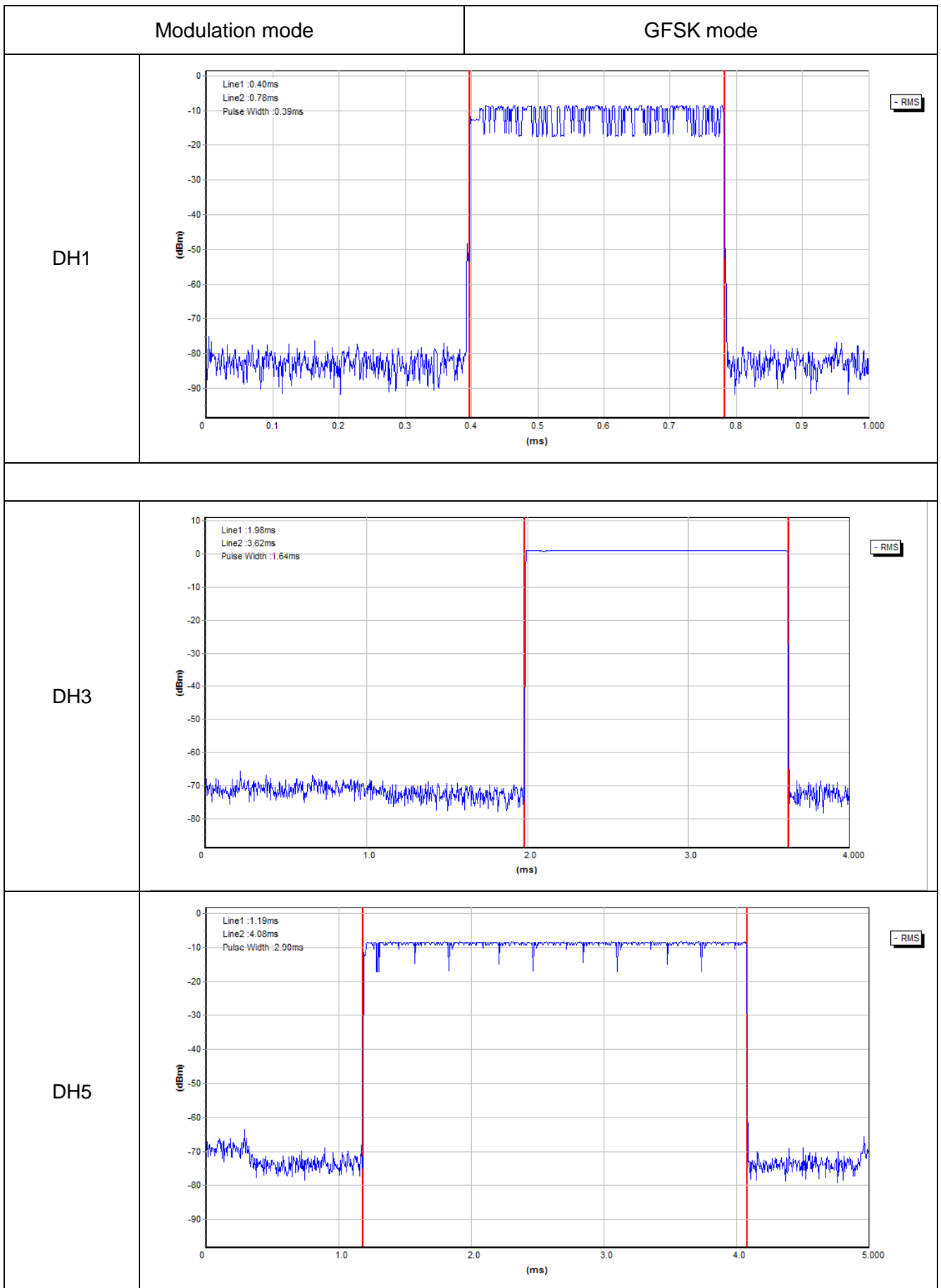

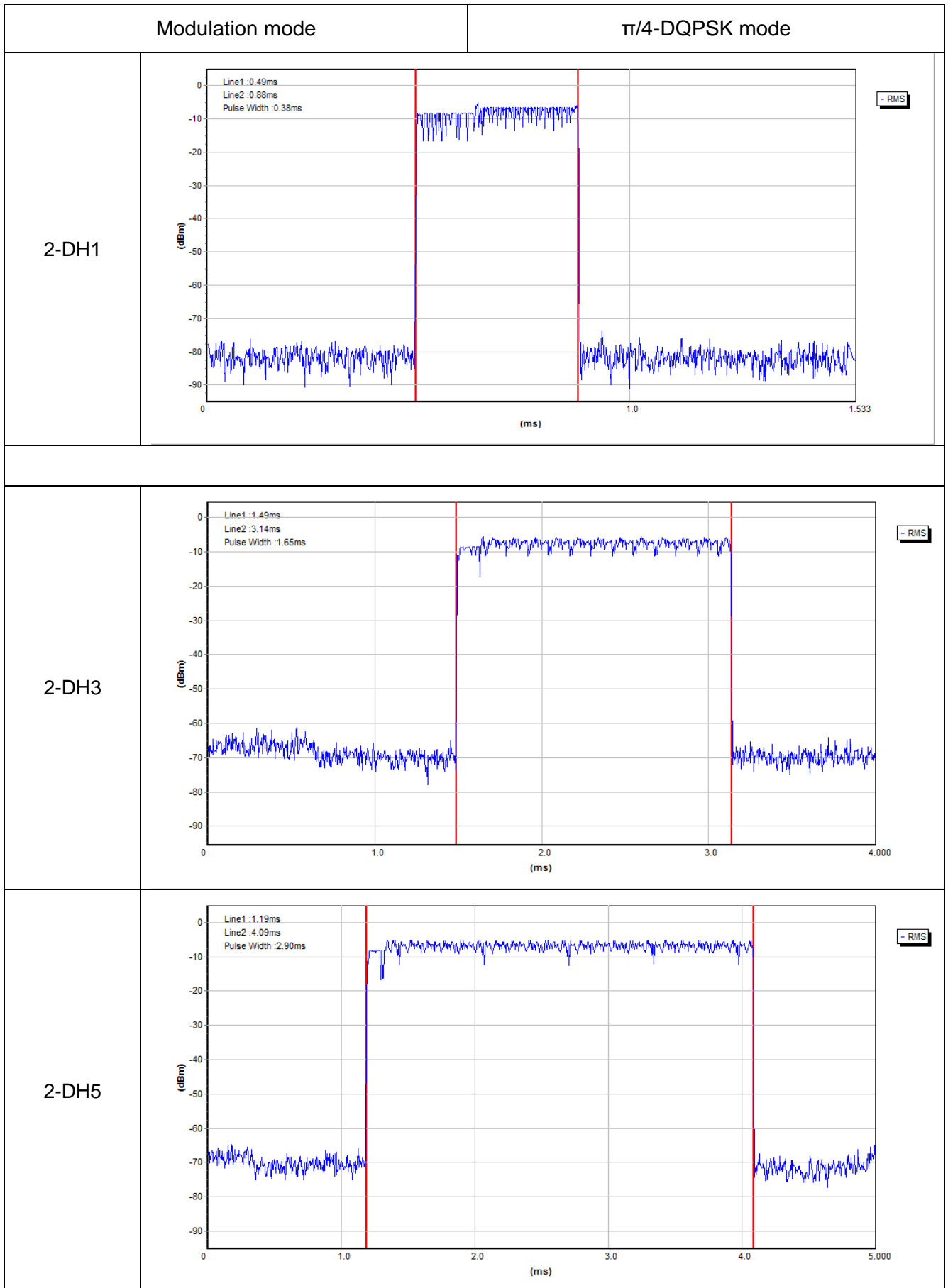

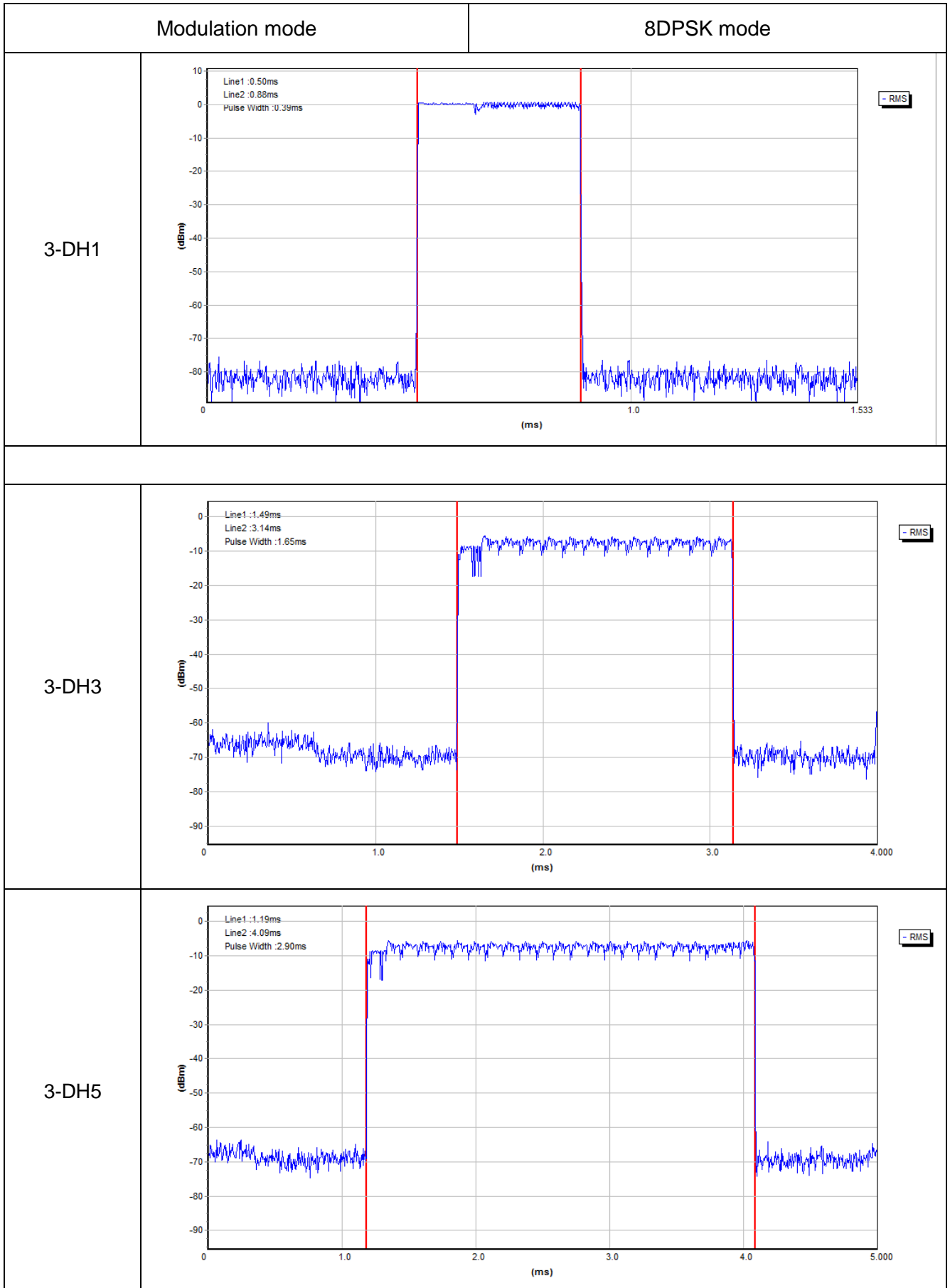

5.9 Conducted bandedge

5.9.1 Limit

In any 100 kHz bandwidth outside the frequency band in which the spread spectrum or digitally modulated intentional radiator is operating, the radio frequency power that is produced by the intentional radiator shall be at least 20 dB below that in the 100 kHz bandwidth within the band that contains the highest level of the desired power, based on either an RF conducted or a radiated measurement, provided the transmitter demonstrates compliance with the peak conducted power limits. If the transmitter complies with the conducted power limits based on the use of RMS averaging over a time interval, as permitted under paragraph (b)(3) of this section, the attenuation required under this paragraph shall be 30 dB instead of 20 dB. Attenuation below the general limits specified in §15.209(a) is not required. In addition, radiated emissions which fall in the restricted bands, as defined in §15.205(a), must also comply with the radiated emission limits specified in §15.209(a) (see §15.205(c)).

5.9.2 Test setup

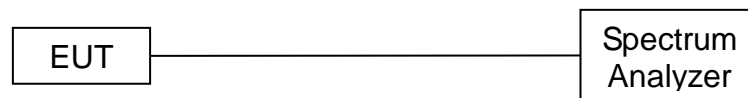

5.9.3 Test procedure

- a) Check the calibration of the measuring instrument using either an internal calibrator or a known signal from an external generator.
- b) Position the EUT without connection to measurement instrument. Turn on the EUT and connect its antenna terminal to measurement instrument via a low loss cable. Then set it to any one measured frequency within its operating range, and make sure the instrument is operated in its linear range.
- c) Set RBW to 100 kHz and VBW of spectrum analyzer to 300 kHz with a convenient frequency span including 100 kHz bandwidth from band edge.
- d) Measure the highest amplitude appearing on spectral display and set it as a reference level. Plot the graph with marking the highest point and edge frequency.
- e) Repeat above procedures until all measured frequencies were complete.

5.9.4 Test results

Test data

| | | | |
|---------------|-------------------|---------------------|---------------------|
| EUT : | Bluetooth Headset | Model Name : | JBuds Air Executive |
| Temperature : | 25 °C | Relative Humidity : | 60% |
| Pressure : | 1012 hPa | Test Voltage : | DC 3.7V by battery |

Test plots

GFSK: Band Edge, Left Side

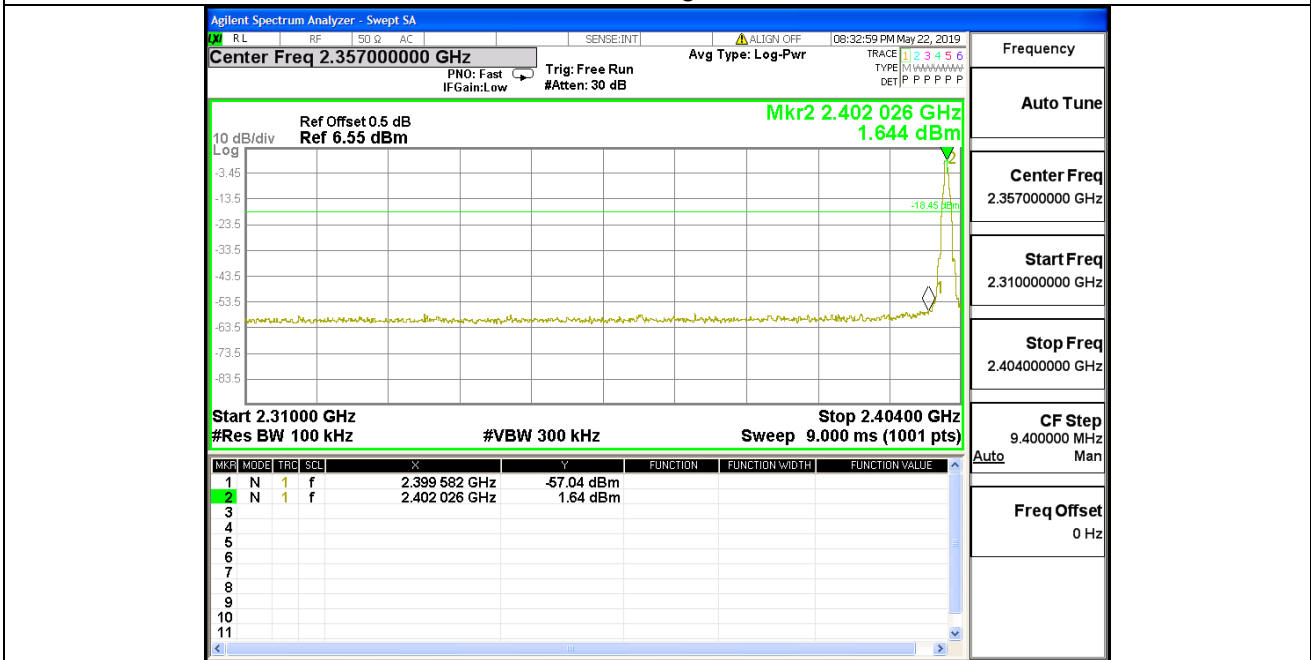

GFSK: Band Edge, Right Side

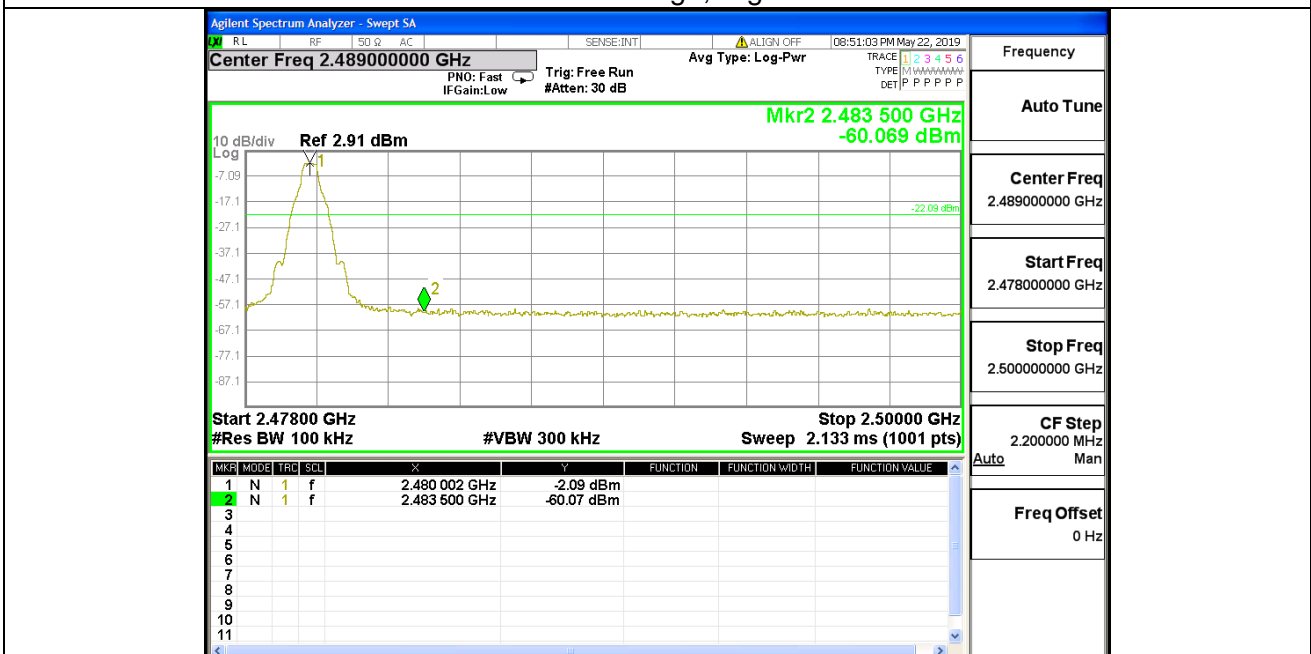

$\pi/4$ -DQPSK: Band Edge, Left Side

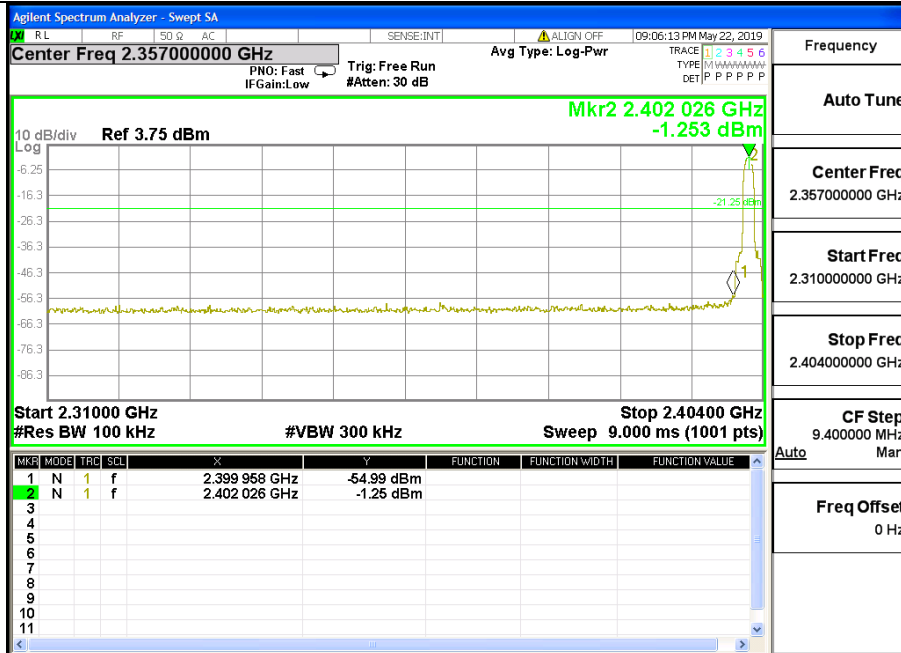

$\pi/4$ -DQPSK: Band Edge, Right Side

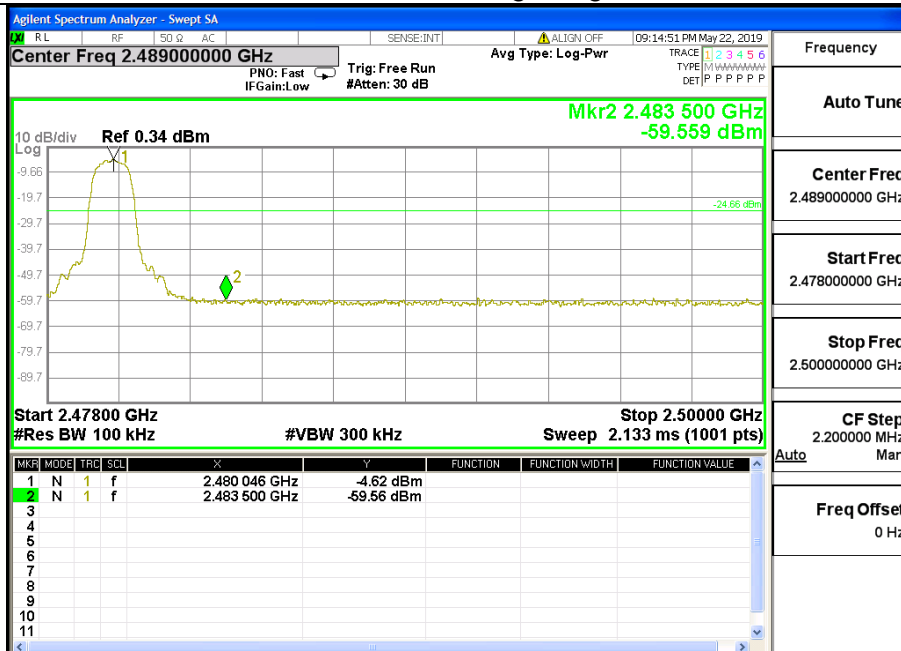

8DPSK: Band Edge, Left Side

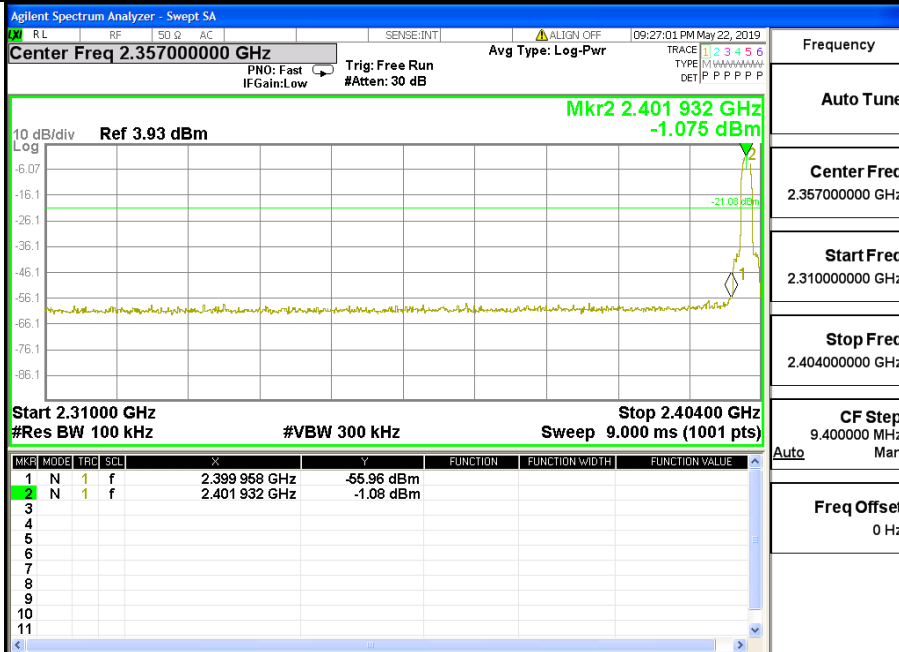

8DPSK: Band Edge, Right Side

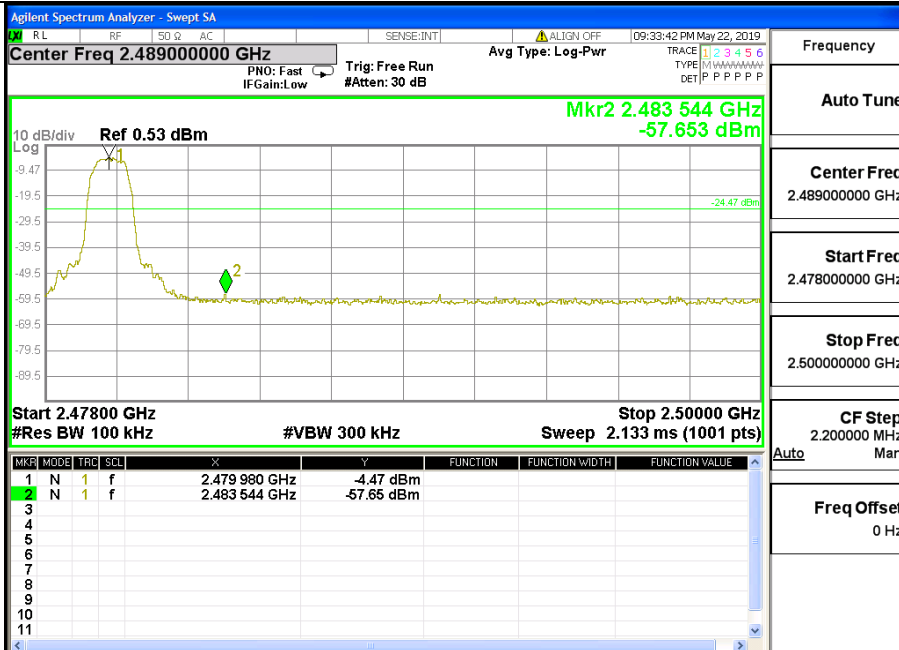

Hopping Mode
Test plots

GFSK: Band Edge, Left Side

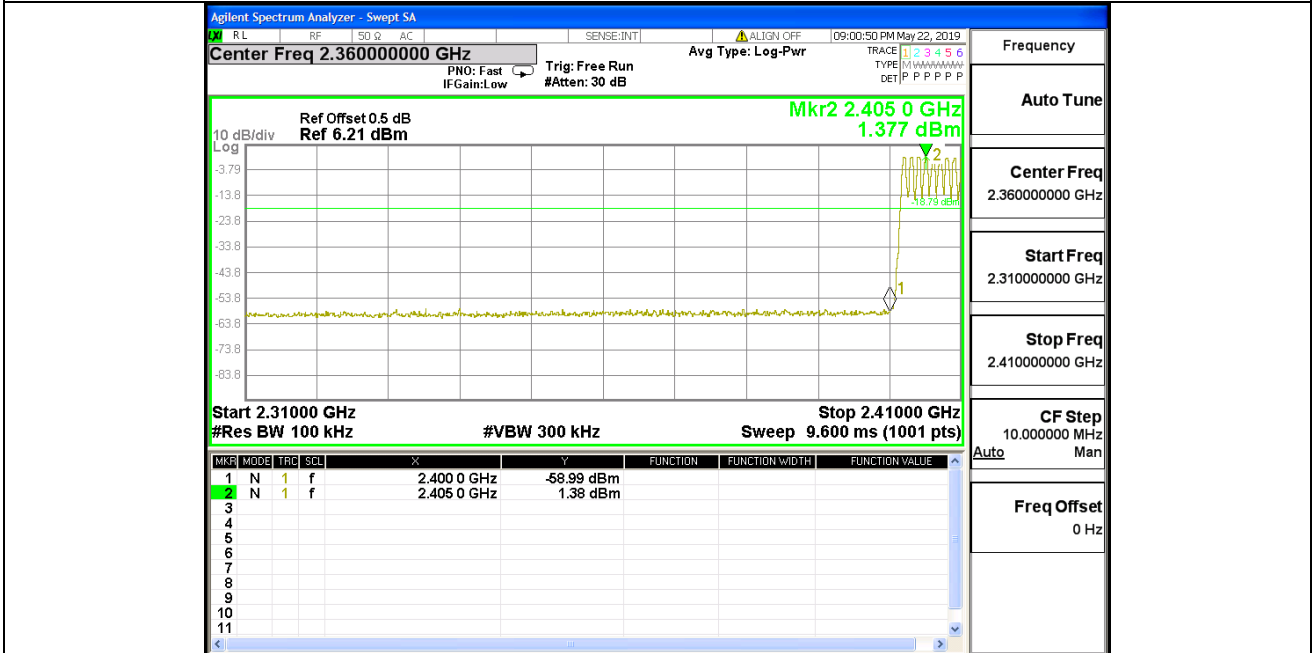

GFSK: Band Edge, Right Side

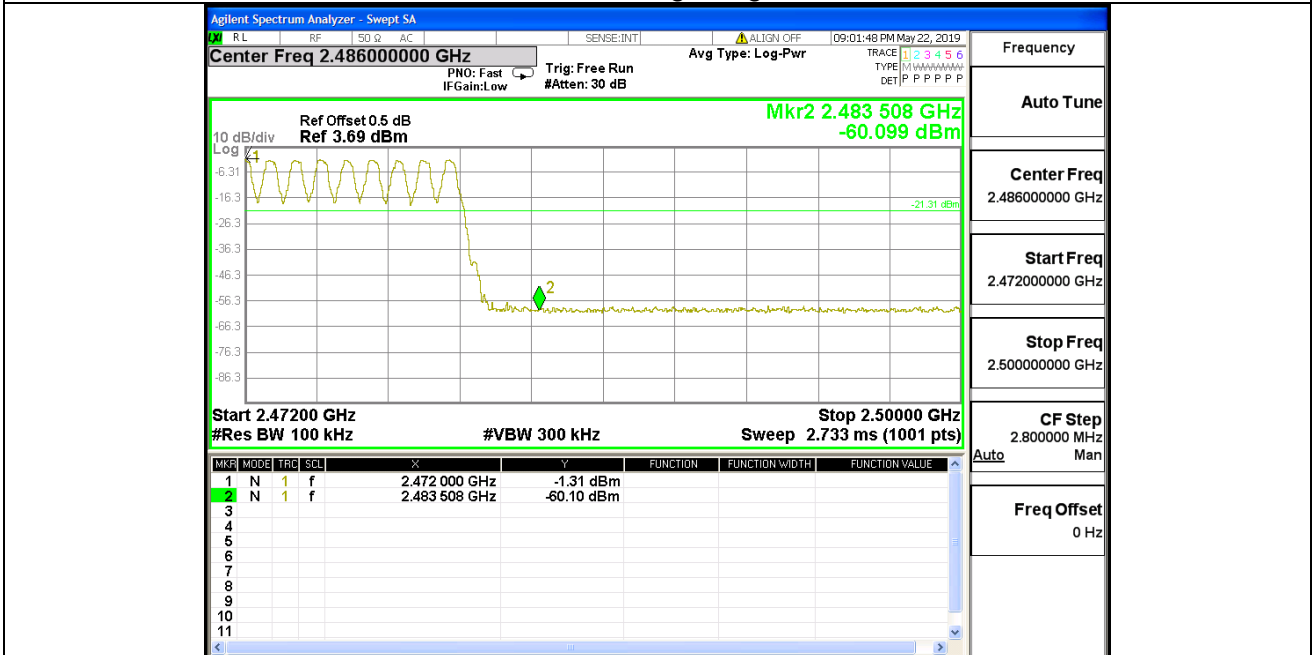

$\pi/4$ -DQPSK: Band Edge, Left Side

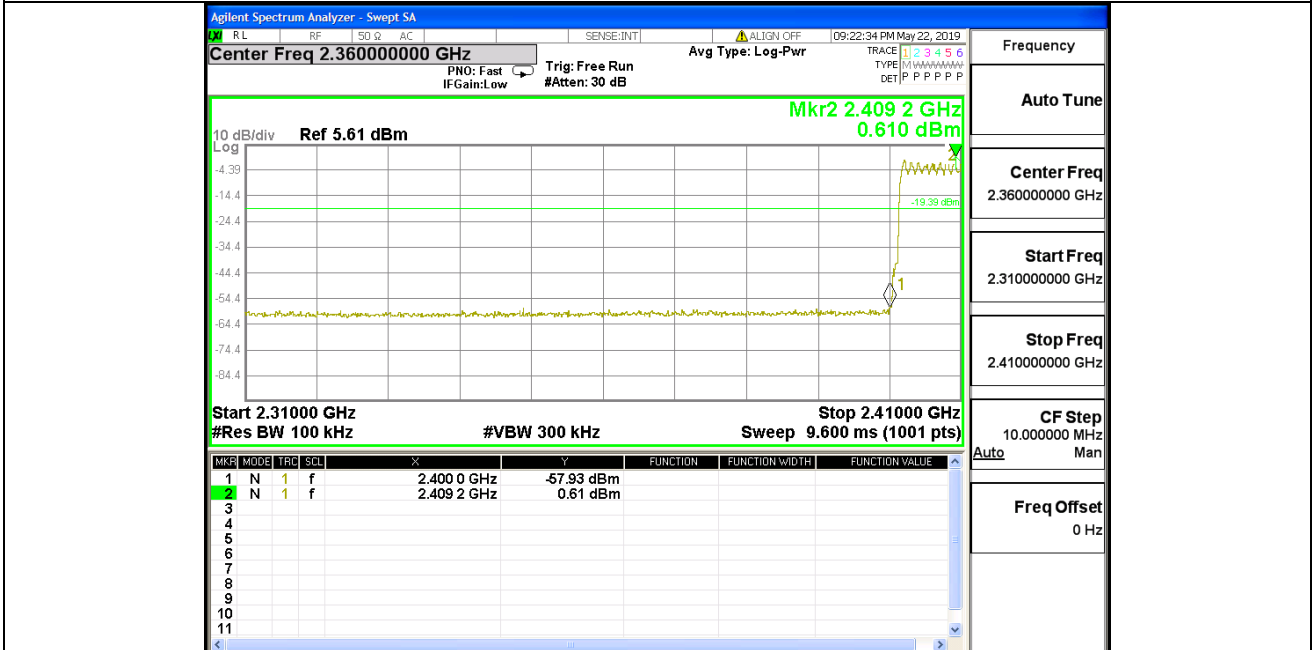

$\pi/4$ -DQPSK Band Edge, Right Side

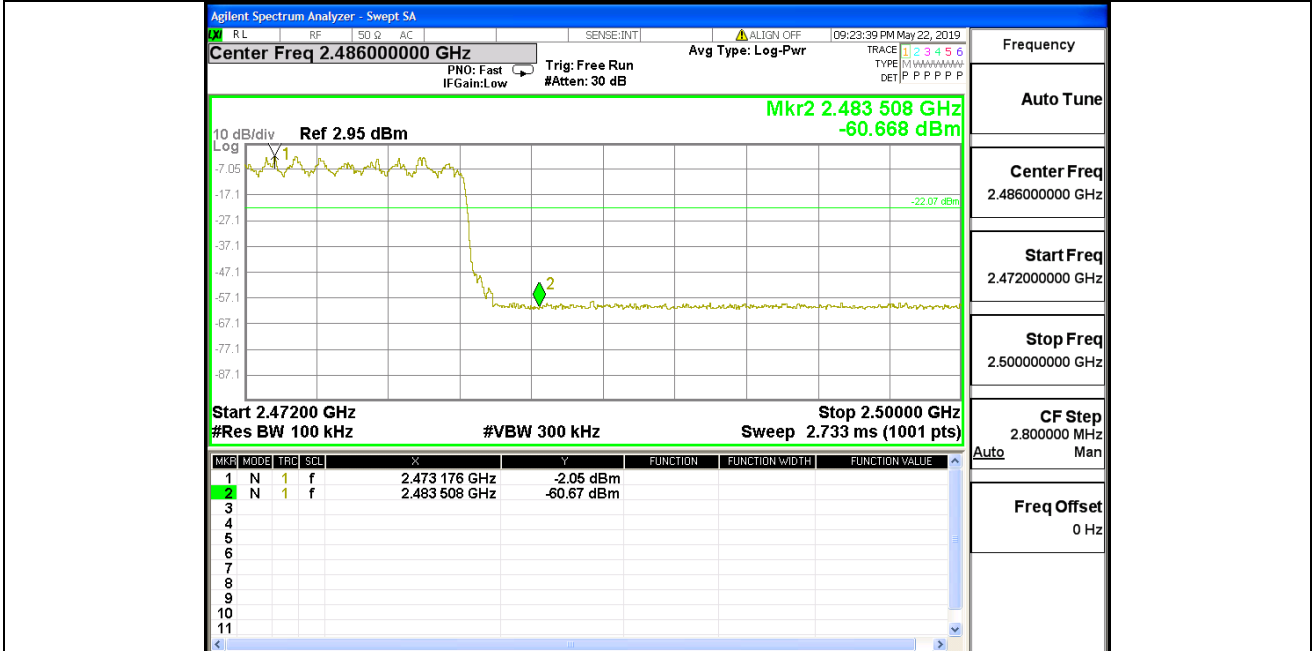

8DPSK: Band Edge, Left Side

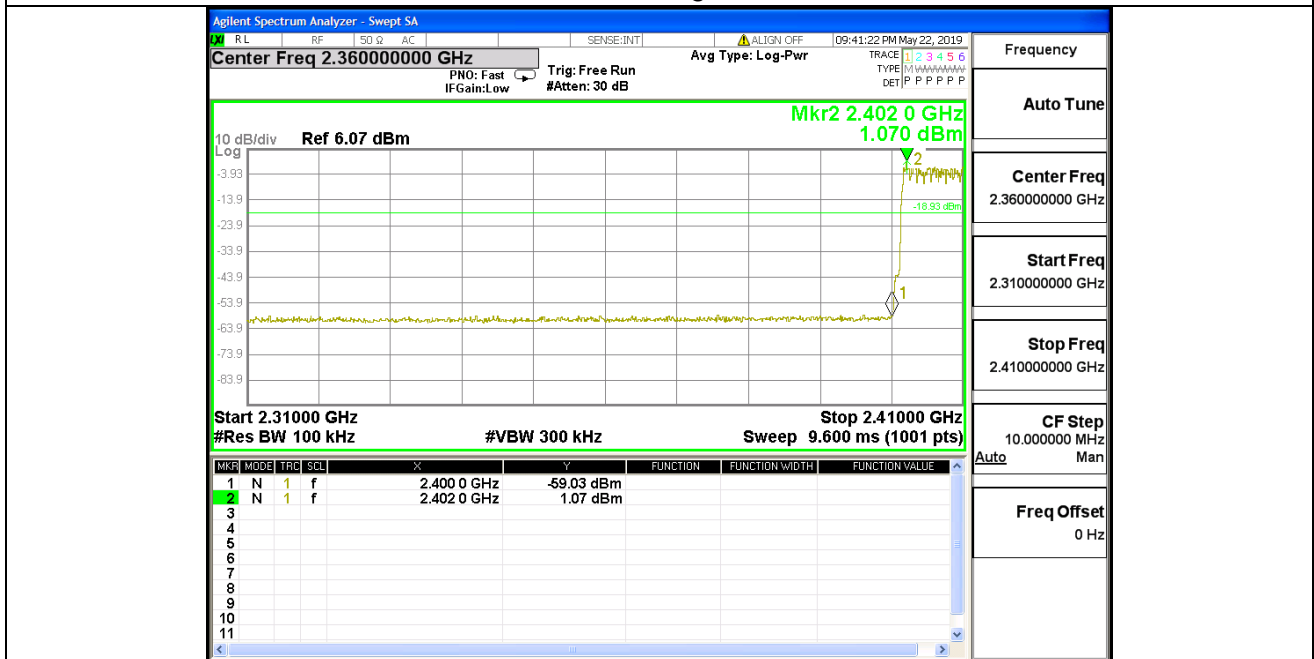

8DPSK Band Edge, Right Side

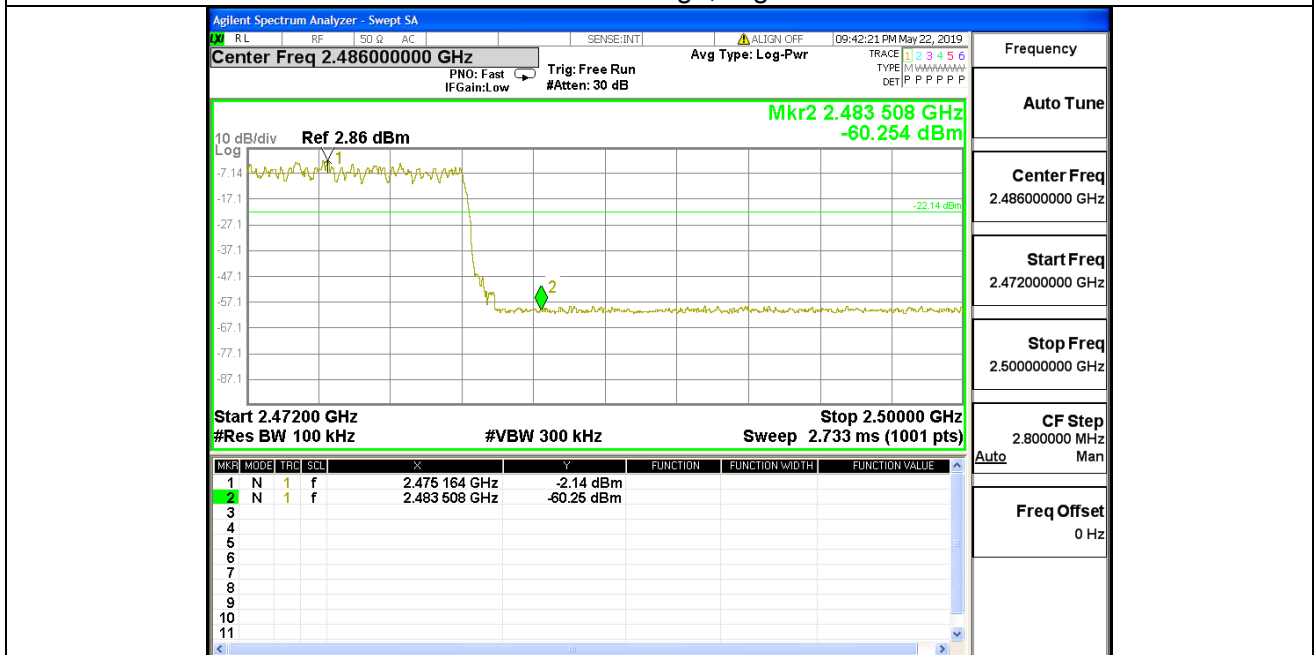

5.10 Spurious RF Conducted Emissions

5.10.1 Conformance Limit

Below -20dB of the highest emission level in operating band.

5.10.2 Measuring Instruments

The Measuring equipment is listed in the section 6.3 of this test report.

5.10.3 Test Setup

Please refer to Section 6.1 of this test report.

5.10.4 Test Procedure

The Spurious RF conducted emissions compliance of RF radiated emission should be measured by following the guidance in ANSI C63.10-2013 with respect to maximizing the emission by rotating the EUT, measuring the emission while the EUT is situated in three orthogonal planes (if appropriate), adjusting the measurement antenna height and polarization etc. Set RBW=100kHz and VBW=300KHz to measure the peak field strength, and measure frequency range from 9KHz to 26.5GHz.

5.10.5 Test Results

Remark: The measurement frequency range is from 9KHz to the 10th harmonic of the fundamental frequency. The lowest, middle and highest channels are tested to verify the spurious emissions and band edge measurement data.

The worst mode is GFSK mode, and the report only show the worst mode data.

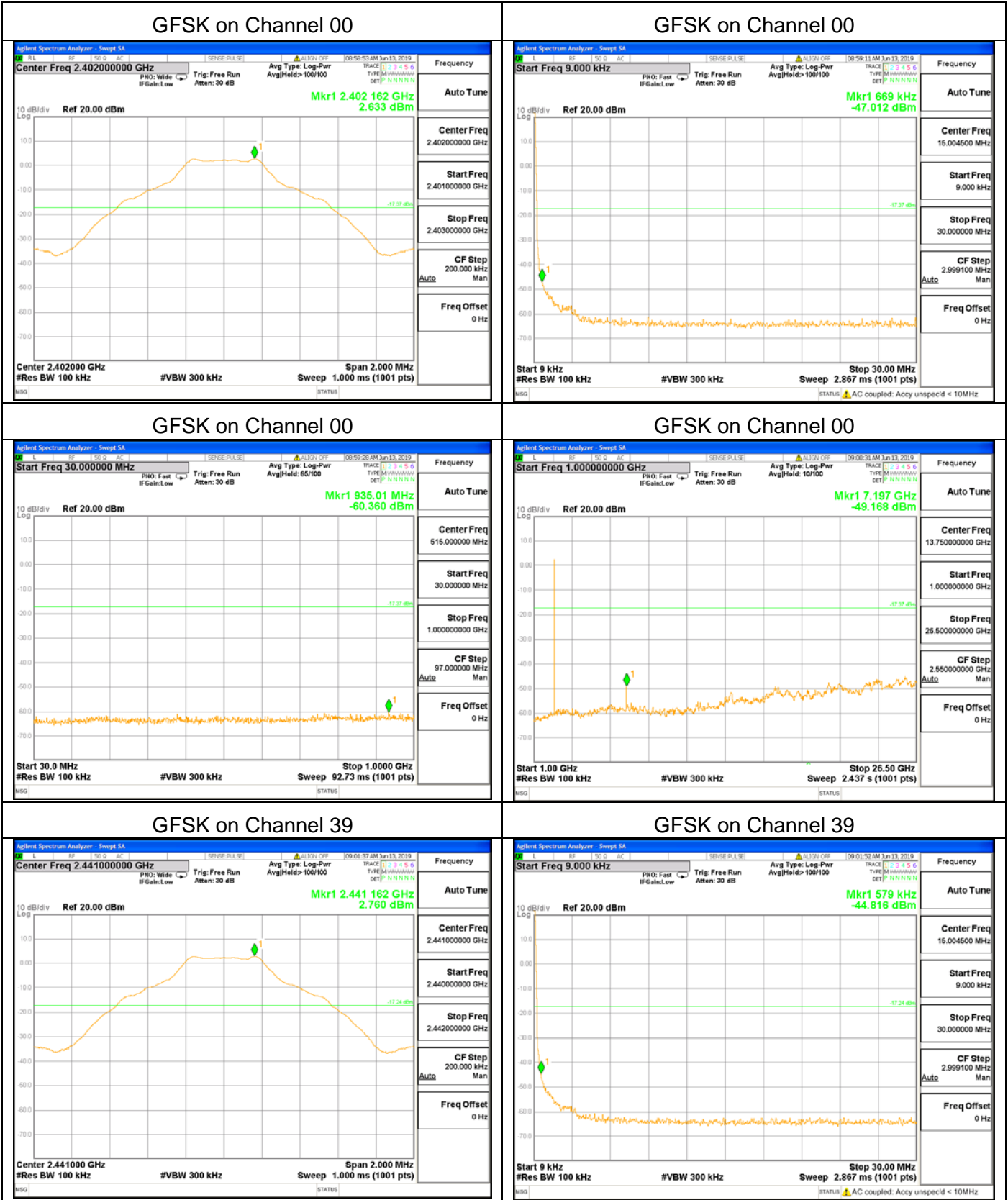

GFSK on Channel 39

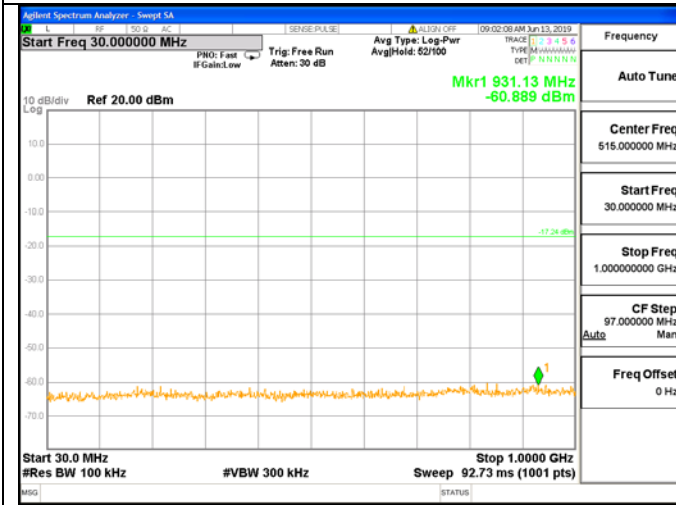

GFSK on Channel 39

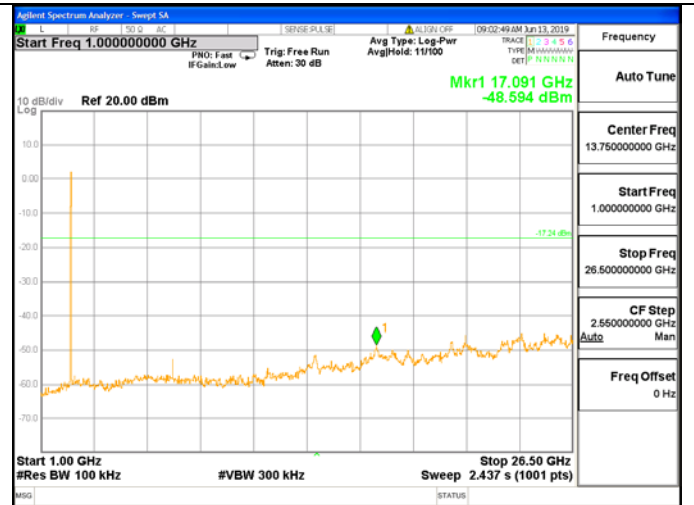

GFSK on Channel 79

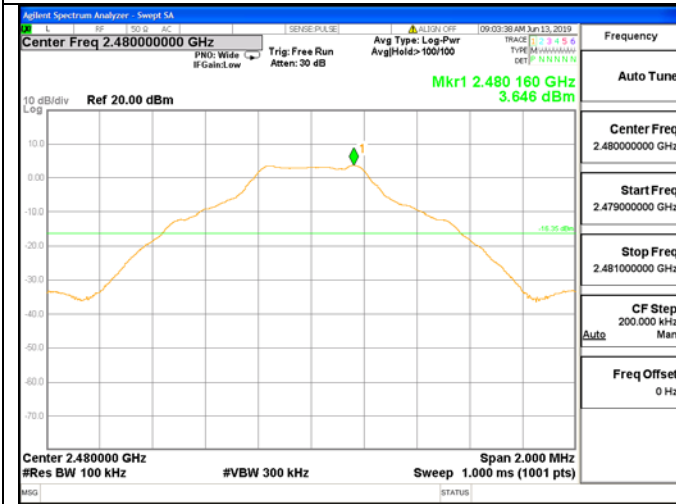

GFSK on Channel 79

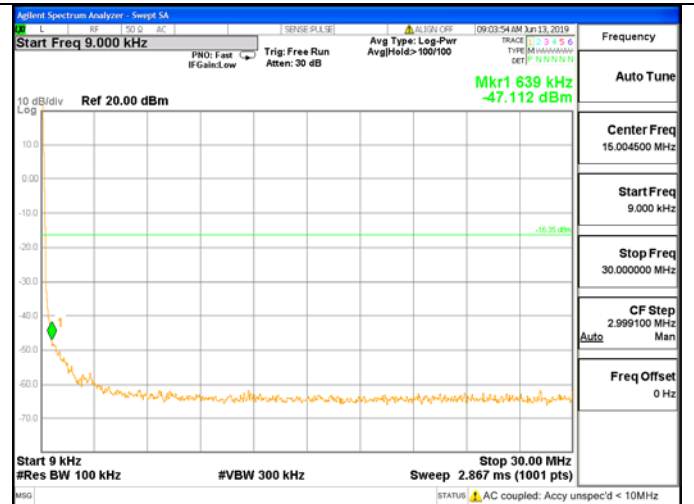

GFSK on Channel 79

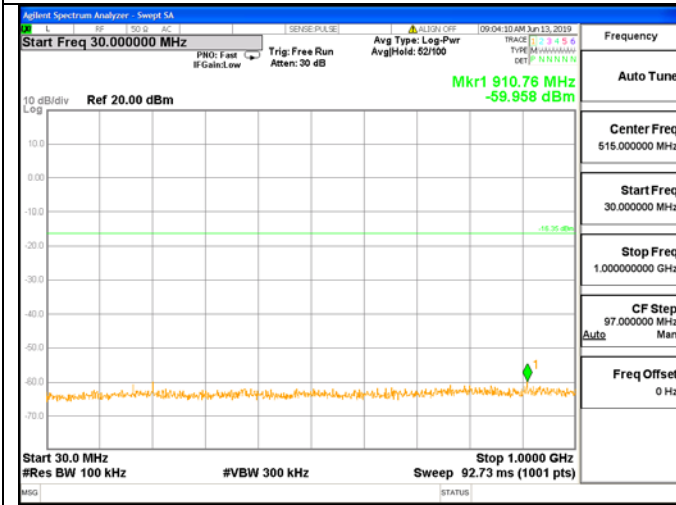

GFSK on Channel 79

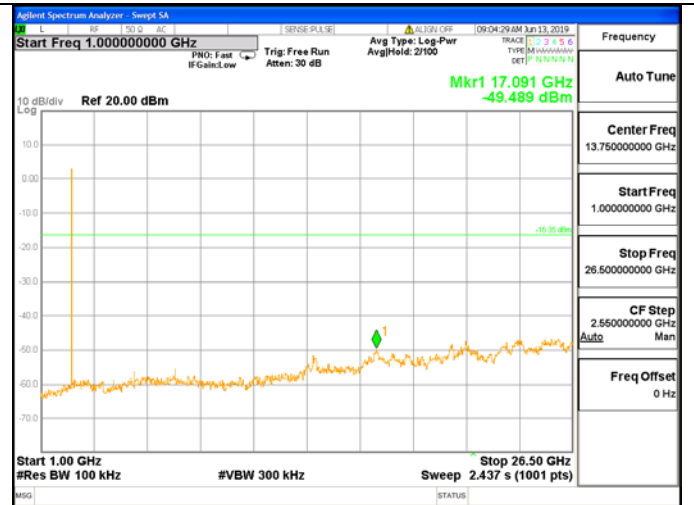

Photographs of the Test Setup

Radiated emission

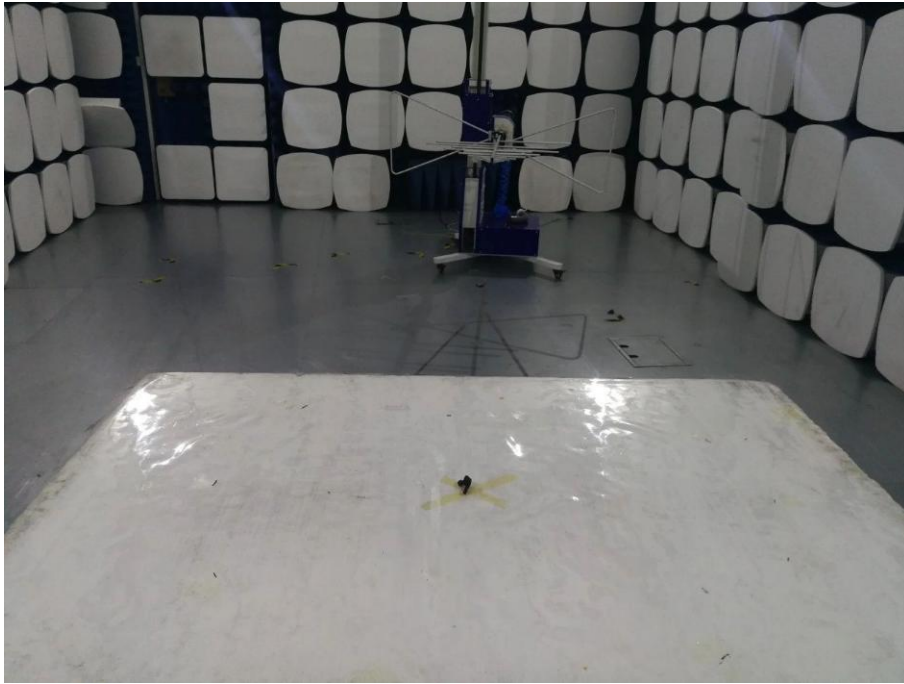

Conducted emission



Photographs of the EUT

See the APPENDIX 1: EUT PHOTO in the report No.: MTi190523E143-1.

----END OF REPORT----