



HEAVY DUTY

JHD22

AM/FM/WX/BT/PA/USB Heavy Duty Radio

Installation and Operation Manual

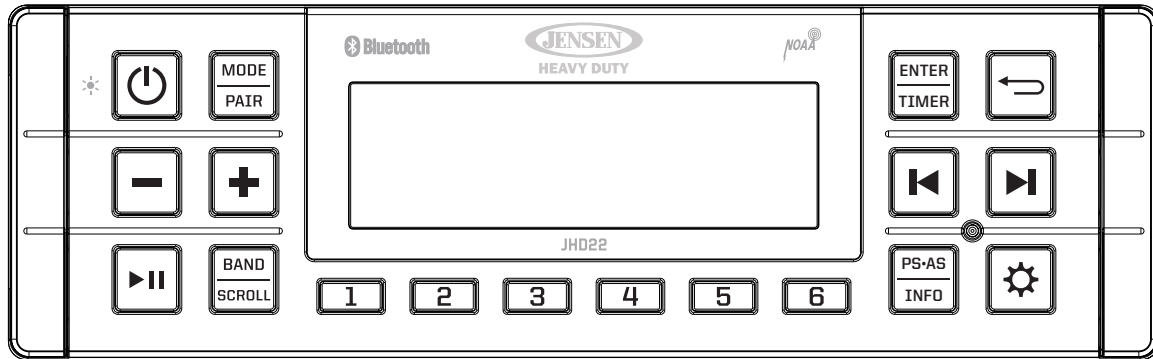

CONTENTS

Introduction	3
Safety Information	4
Installation	4
Wiring	6
Basic Operation	7
Tuner Operation.....	10
Bluetooth Operation	12
Care and Maintenance	14
Troubleshooting	15
Specifications.....	16
FCC Notes.....	17

INTRODUCTION

System Features

Features of Jensen JHD22 mobile audio system include:

- 14 Characters Alpha-Numeric Segmented LCD
- AM/FM (US/Europe /Japan/Russia) Tuner with 30 Presets (12AM, 18FM)
- Weatherband Tune
- Mute
- Bluetooth Streaming Audio (Supports A2DP and AVRCP)
- Loudness
- Electronic Bass, Treble, Balance, Fader Controls
- Maximum Output Power RMS 40W x 4
- Clock 12/24 Hour Selectable
- Work Clock Timer
- Low Battery Voltage Alert
- Illumination Dimming
- USB Charging
- 2-Channel Pre-amp Line Level Outputs
- 2- Wire Power with Non-Volatile Memory and Clock/Time support

Content List

- Jensen Heavy Duty Radio
- Hardware Kit
- Mounting Bracket
- Quick Reference Guide

Hardware Kit Contents

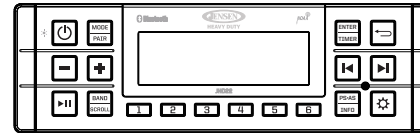

Commander

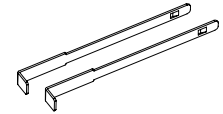

Din Sleeve
Removal Tool

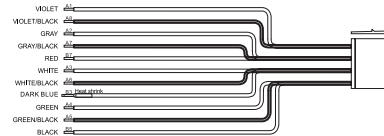

Harness

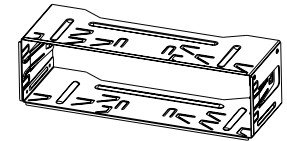

Din Sleeve

SAFETY INFORMATION

When Driving

Keep the volume level low enough to be aware of the road and traffic conditions.

When Washing Your Vehicle

Do not expose the product to water of excessive moisture. Moisture can cause electrical shorts, fire or other damage.

When Parked

Parking in direct sunlight can produce very high temperatures inside your vehicle. Give the interior a chance to cool down before starting playback.

Use the Proper Power Supply

This product is designed to operate with a 12 volt DC negative ground battery system.

WARNING:

- TO REDUCE THE RISK OF FIRE OR ELECTRIC SHOCK, DO NOT EXPOSE THIS EQUIPMENT TO RAIN OR MOISTURE.
- TO REDUCE THE RISK OF FIRE OR ELECTRIC SHOCK AND ANNOYING INTERFERENCE, USE ONLY THE RECOMMENDED ACCESSORIES.

INSTALLATION

This unit is designed for installation in vehicle cabs with an existing 1-DIN radio opening. In many cases, a special installation kit will be required to mount the radio to the dashboard. See the dealer where the radio was purchased for kit availability. Always check the kit application before purchasing to make sure the kit works with your vehicle.

Before you Begin

1. Disconnect Battery
Before you begin, always disconnect the battery negative terminal.
2. Remove Transport Screws

Important Notes

- Before final installation, test the wiring connections to make sure the unit is connected properly and the system works.
- Use only the parts included with the unit to ensure proper installation. The use of unauthorized parts can cause malfunctions.
- Consult with your nearest dealer if installation requires the drilling of holes or other modifications to your vehicle.
- Install the unit where it does not interfere with driving and cannot injure passengers during a sudden or emergency stop.
- If the installation angle exceeds 30° from horizontal, the unit might not give optimum performance.

- Avoid installing the unit where it will be subjected to high temperatures from direct sunlight, hot air, or from a heater, or subject to excessive dust, dirt or vibration.

DIN Front Mount

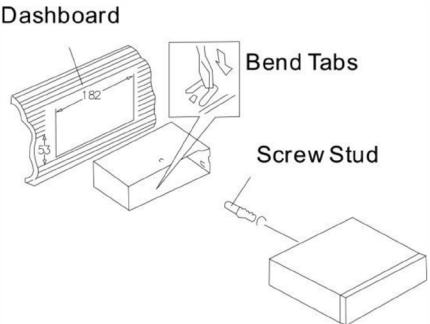
1. Slide the mounting sleeve off of the chassis if it has not already been removed. If it is locked into position, use the removal keys (supplied) to disengage it. The removal keys are depicted in "Removing the Unit" on page 6 .
2. Check the dashboard opening size by sliding the mounting sleeve into it. If the opening is not large enough, carefully cut or files as necessary until the sleeve easily slides into the opening. Do not force the sleeve into the opening or cause it to bend or bow. Check that there will be sufficient space behind the dashboard for the radio chassis.
3. Locate the series of bend tabs along the top, bottom and sides of the mounting sleeve. With the sleeve fully inserted into the dashboard opening, bend as many of the tabs outward as necessary to firmly secure the sleeve to the dashboard.

4. Place the radio in front of the dashboard opening so the wiring can be brought through the mounting sleeve.
5. Follow the wiring diagram carefully and make certain all connections are secure and insulated with crimp connectors or electrical tape to ensure proper operation.
6. After completing the wiring connections, turn the unit on to confirm operation (vehicle accessory switch must be on). If the unit does not operate, recheck all wiring until the problem is corrected. Once proper operation is achieved, turn the accessory switch off and proceed with final mounting of the chassis.
7. Carefully slide the radio into the mounting sleeve making sure it is right-side-up until it is fully seated and the spring clips lock it into place.
8. Attach one end of the perforated support strap (supplied) to the screw stud on the rear of the chassis using the hex nut provided. Fasten the other end of the dashboard either above or below the radio using the screw and plain washer provided. Bend the strap, as necessary, to position it. Some vehicle installations provide cavity for rear support. In these applications, place the rubber bushing over the screw stud and insert.

CAUTION: The perforated rear support strap or rear rubber mounting bushing must be used in the installation of the radio. Installation without either may result in damage to the radio or the mounting surface and void the manufacturer's warranty.

9. Test radio operation by referring to the operating instructions for the unit.

Removing the Unit

To remove the radio after installation, remove the plastic end caps, insert the removal keys straight back until they click, and then pull the radio out. If removal keys are inserted at an angle, they will not lock properly to release the unit.

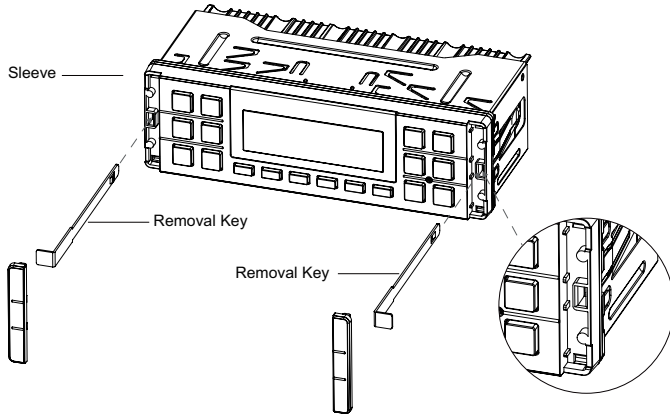

Reconnect Battery

When wiring is complete, reconnect the battery negative terminal.

WIRING

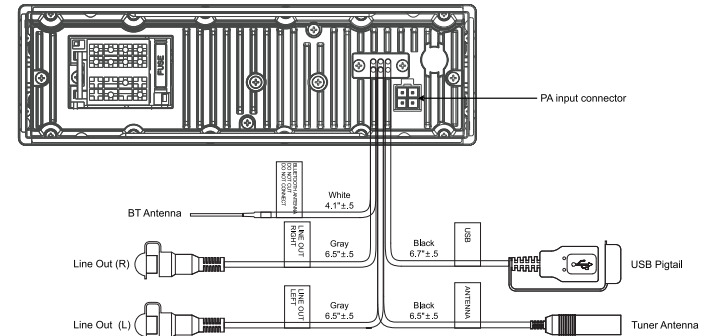

DETAIL A
SHOWN FROM PIN VIEW

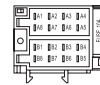

PIN NO.	WIRE COLOR	DESCRIPTION
A1	VIOLET	RIGHT REAR SPEAKER(+)
A2	GRAY	RIGHT FRONT SPEAKER(+)
A3	WHITE	LEFT FRONT SPEAKER(+)
A4	GREEN	LEFT REAR SPEAKER(+)
A5	GREEN/BLACK	LEFT REAR SPEAKER(-)
A6	WHITE/BLACK	LEFT FRONT SPEAKER(-)
A7	GRAY/BLACK	RIGHT FRONT SPEAKER(-)
A8	VIOLET/BLACK	RIGHT REAR SPEAKER(-)
B1	N/A	NO CONNECTION
B2	N/A	NO CONNECTION
B3	DARK BLUE	AMP REMOTE
B4	N/A	NO CONNECTION
B5	BLACK	GROUND
B6	N/A	NO CONNECTION
B7	RED	+12V ACC SWITCHED
B8	N/A	NO CONNECTION

WARNING!

Do not connect the +12VDC ACC switched wire to the battery. This wire **MUST** be connected to the Accessory/Ignition wire or a +12 volts switched power source.

BASIC OPERATION

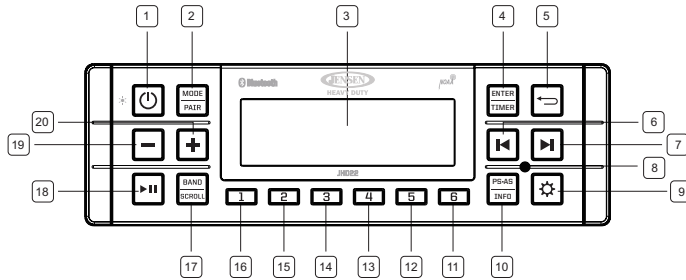

Power On/Off

Press the **POWER** button (1) to turn the unit on. The unit will resume at the last mode (Tuner, BT, etc.) after turn on. Press and hold the **POWER** button (1) to enter standby mode.

Volume Control

To increase the volume, press the **+** button (20). To decrease the volume, press the **-** button (19).

Play/Pause/Mute

Press the **▶||** button (18) on the control panel to pause or mute the audio output. Press **▶||** button again to unmute or restore the audio output to the previous level.

Mode

Press the **MODE** button (2) to select a different mode of operation, as indicated on the display panel. Available modes include the following: FM > AM > Weather Band > BT Audio. FM is the default source mode on initial power up.

NOTE: Weatherband mode will be skipped when the Region menu option is set to "Europe/ Russia / Japan".

Reset

The **RESET** button (8) should be activated for the following reasons:

- Initial installation of the unit when all wiring is completed.
- Function buttons do not operate.
- Error symbol on the display.

Use a ball point pen or thin metal object to press the reset button. This may be necessary should the unit display an error code.

Audio Menu

Press the **SETUP** button (9) to access the audio menu. You can navigate through the audio menu items by pressing the **SETUP** button repeatedly or **◀** or **▶** buttons (6, 7). Once the desired menu item appears on the display, adjust that option by pressing the **+** or **-** buttons (20, 19) within 5 seconds. The unit will automatically exit the audio menu after five seconds of inactivity. The following menu items can be adjusted.

Loudness:

Press the **+** or **-** buttons (20, 19) to toggle the loudness on/off. When listening to music at low volumes, this feature will boost the bass/treble range to compensate for the characteristics of human hearing.

Bass Level

Press the **+** or **-** buttons to adjust the Bass level range from "-7" to "+7".

Treble Level

Press the **+** or **-** buttons to adjust the Treble level range from “-7” to “+7”.

Balance

Press the **+** or **-** buttons to adjust the Balance between the left and right speakers from “Left 7” to “Right 7”.

Fade

Press the **+** or **-** buttons to adjust the Fader between the rear and front speakers from “Rear 7” to “Front 7”.

System Menu

1. Press and hold the **SETUP** button (9) for more than 2 seconds to enter the system menu.
2. Press the **SETUP** button repeatedly or **◀** or **▶** buttons (6, 7) to navigate the system menu.
3. Press the **+** or **-** buttons (20, 19) to adjust the selected menu item. Press the **ENTER/TIMER** button (4) to select the desired item.

The unit will automatically exit the system menu after 5 seconds of inactivity.

The following items can be adjusted:

- LCD Dimmer (1-10): Adjust LCD backlight
- Bluetooth Devices: Press to **ENTER/TIMER** button (4) to enter sub-menu. Press **◀** or **▶** buttons (6, 7) to navigate list. List loops. Press **ENTER/TIMER** button to select device. Press **◀** or **▶** to navigate selected device’s menu

of available options (Lock/Unlock > Connect/ Disconnect > Delete and List loops). Press **ENTER/TIMER** button to select options.

- Lock/Unlock: Press **ENTER/TIMER** button to lock or unlock device. Lock icon displays next to device name in menu when device is locked.
- Connect/Disconnect: Press **ENTER/TIMER** button to connect or disconnect previous paired device.
- Delete: Option only available if selected device is unlocked. Press **ENTER/TIMER** button to delete.
- Clock Set: Setting the clock (HH:MM) and hour format.
- Low Voltage Alarm (On/Off): Monitor voltage on ACC line and send alert when voltage is low.
- Low Voltage Auto Off (On/Off): Automatically turn off power to radio when battery voltage is low.
- Preset-Only Tuning (On/Off): If ‘Preset-Only Tune’ is set to ‘On’ in System Settings, only presets from all bands are recalled in sequence.
- Tuning Region (USA/EURO/RUSSIA/JAPAN): Set frequency spacing for various regions.
 - USA Tuning Region (AM > FM > WX > Bluetooth)
 - Europe, Japan & Russia Tuning Region (AM > FM > Bluetooth)
- Key Beep (On/Off): Turn the audible beep On/Off (heard when functions/ buttons are selected). Beep tone off will not affect Battery Alarm audible tone.

- Reset System Defaults: Press the **ENTER/TIMER** button and Press **◀** or **▶** buttons to select Confirm. Press the **ENTER/TIMER** to return the unit to factory default set up values.
- System Info: Display firmware version

NOTE: Bluetooth Device menu options are only available while the Bluetooth feature is ON and the radio is in Bluetooth Audio mode.

NOTE: A locked Bluetooth device will not be overwritten from the list.

Low Voltage Alarm Operation

If Low Voltage Alarm is set to "On", an alarm will sound (8 beeps every 30 sec) when the voltage drops to 10.5V (+/- 0.3V). A visual warning (LOW VOLTAGE) will appear, Press any button to dismiss visual warning, (reappear every 10-minutes) in the LCD display.

NOTE: "Off" is the default setting for Low Voltage Alarm. If the audio is muted or the volume is set to 0, the audible beep will not be heard.

Liquid Crystal Display (LCD)

The liquid crystal display (LCD) panel (3) displays the frequency, time and activated functions. Press the **POWER** button (1) to turn the dimmer On (selected brightness level) and press again to turn dimmer Off (maximum brightness level).

NOTE: LCD panels may take longer to respond when subjected to cold temperatures for an extended period of time. In addition, the visibility of the characters on the LCD may decrease slightly. The LCD display will return to normal when the temperature increases to a normal range.

Setting the Clock

To set the clock to display the current time, turn the vehicle ignition on and turn the radio on. Enter the system menu and adjust the clock by selecting the "Set Clock" menu item.

- Press **ENTER/TIMER** button (4) to enter clock setting menu.
- press **◀** or **▶** to select hours, minutes, or 12/24 hour format.
- Press **+** or **-** to adjust the setting field.

When no adjustment is made, the time will become set and normal operation will resume.

Setting Work Timer

To activate the work timer clock and running in the background,

- Press **ENTER/TIMER** button (4) to display work timer.
- Press **ENTER/TIMER** button again to start/stop work timer.
- Press & hold **ENTER/TIMER** button to reset work timer.
- Press **RETURN** button (5) to exit work timer display.

If timer is exited while running, "TIMER" flashed every 10 seconds for 2 seconds in place of clock in footer right on the display.

PA Operation

- Connect PA Microphone (JMICHFP) with a 4-PIN connector to the 4-PIN socket on the rear of the unit.
- The unit will automatically switch to PA mode when the mic switch is pushed "ON".
- The PA output level can be adjusted using the volume + or – buttons (20, 19).
- With radio power off, the radio will wake up when PA mic button is pressed to make an announcement. Please note that it will take a few seconds before the radio "wakes up" and PA is active. Radio will return to the off state when the PA mic is released.

TUNER OPERATION

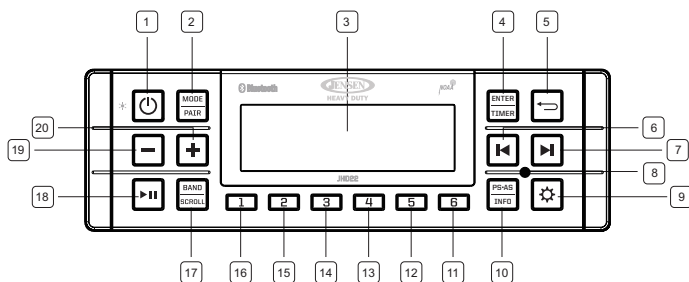

Select a Band

Press the **BAND/SCROLL** button (17) to change between FM1, FM2, FM3, AM1 and AM2.

Manual Tuning

Press & hold the **◀** or **▶** buttons (6, 7) to seek stations up/down step by step.

Auto Seek Tuning

Press the **◀** or **▶** buttons (6, 7) to automatically seek the next or previous strong station.

NOTE: Seek tuning is not available for weather band channels. Use the up or down tuning buttons to manually select any of the seven available weather band channels.

Preset Stations

Six numbered preset buttons store and recall stations.

Store a Station

Select a station, then press and hold a preset button from **1 – 6** on the number buttons (11-16) for two seconds. The preset number will appear on the LCD.

Recall a Station

Press a preset button from **1 – 6** on the number buttons to select the corresponding stored station.

NOTE: Preset buttons are pre-assigned frequencies in weather band mode.

Automatically Store / Preset Scan (AS/PS)

Automatically Store

Select an **AM** or **FM** band. Press and hold the **AS•PS** button (10) for 2 seconds to automatically select 6 strong stations. "Storing Presets" appears on the screen and the new stations replace any stations already stored.

Preset Scan

Select a band. Press **AS•PS** (10) to scan stations stored in the current band. The unit will pause for 10 seconds at each preset station. Press **AS•PS** again to stop scanning when the desired station is reached.

Weather Band Operation

What is the NOAA Weather Radio/Weatheradio Canada?

NOAA (National Oceanic and Atmospheric Administration) is a nationwide system that broadcasts local weather emergency information 24 hours a day via the National Weather Service (NWS) network. The U.S. network has more than 530 stations covering the 50 states as well as the adjacent coastal waters, Puerto Rico, the U.S. Virgin Islands and the U.S. Pacific Territories. Each local area has its own transmitting station and there are a total of seven broadcasting frequencies used. A similar system is available in Canada under the Weatheradio Canada service administered by Environment Canada.

Tuning to Weatherband

Press the **MODE** button (2) repeatedly to reach the Weatherband. The indication "WB" will appear on the display panel, along with the current number and channel indication:

"WB-1", "WB-2", "WB-3", "WB-4", "WB-5", "WB-6" or "WB-7". The seven frequencies are shown in the following table:

WB Frequencies

Frequency (MHz)	Preset
162.400	2
162.425	4
162.450	5
162.475	3
162.500	6
162.525	-
162.550	1

The above table also shows which preset button will access the frequency. Note that one frequency cannot be accessed using a preset button. The frequency can only be reached using the tuning controls.

Use the ◀ or ▶ buttons (6, 7) or the preset buttons to tune to each of the seven channels until you find the weatherband station broadcasting in your area.

How many stations can I expect to receive?

Since the broadcasts are local weather and information, the transmission power is usually very low (much less than standard AM or FM stations) so you will usually receive only one station unless you are on the edge of two or more broadcast signals. The most you will receive will be two or three, and that is rare.

Is it possible I won't receive any stations?

Depending on where you are located, there is a possibility you will receive only a very weak signal or none at all. Also, similar to AM and FM signals, weatherband signals are subject to surrounding conditions, weather, obstructions of the signal by hills or mountains, etc.

BLUETOOTH OPERATION

The JHD22 includes built-in Bluetooth technology that allows you to connect this head unit to Bluetooth devices for streaming audio playback.

About Bluetooth Technology

Bluetooth is a short-range wireless radio connectivity technology developed as a cable replacement for various electronic devices. Bluetooth operates in 2.4 GHz frequency range and transmits voice and data at speeds up to 2.1 Mbit/s over a range of up to 10 meters.

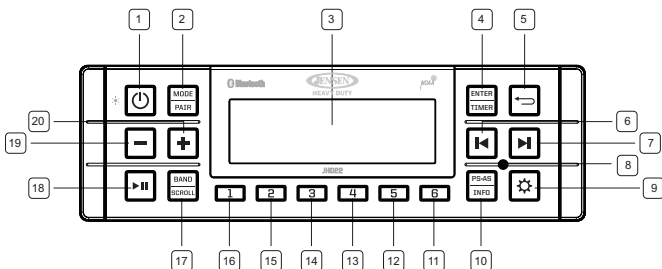

Bluetooth Menu Options

NOTE: Please note that some BT menu options are only available while the unit is in Bluetooth Audio mode.

Press and hold the **SETUP** button (9) for more than 2 seconds to enter the system menu. Press the **SETUP** button repeatedly or **◀** or **▶** buttons (6, 7) to view the Bluetooth Setup Menu options. Press **ENTER/TIMER** button (4) to enter BT Device List menu options.

BT Device List

Press the **ENTER/TIMER** buttons to view a list of previously paired mobile phone device models. Press the **◀** or **▶** buttons to navigate devices from the list. You cannot delete a device that is actively connected. Press the **ENTER/TIMER** button to select the device. Press the **◀** or **▶** buttons to choose Lock/Unlock, Disconnect or Delete for this device.

- **LOCK/UNLOCK:** The JHD22 can store up to 5 devices for Bluetooth connection. The devices are stored in FIFO (First in First Out) order. To prevent a device from being bumped from the list when more than 5 devices are used, you must lock the device. To lock/Unlock a device, press the **ENTER/TIMER** button to display/change the Locked or Unlocked icon.
- **DISCONNECT:** To disconnect a paired device, press the **ENTER/TIMER** button to temporarily remove the Bluetooth

link. The link can be re-established through your phone menu by selecting the JHD22 for connection.

- **DELETE:** To delete a device from the list, press the **ENTER/TIMER** button.

NOTE: Device must be disconnected to be deleted.

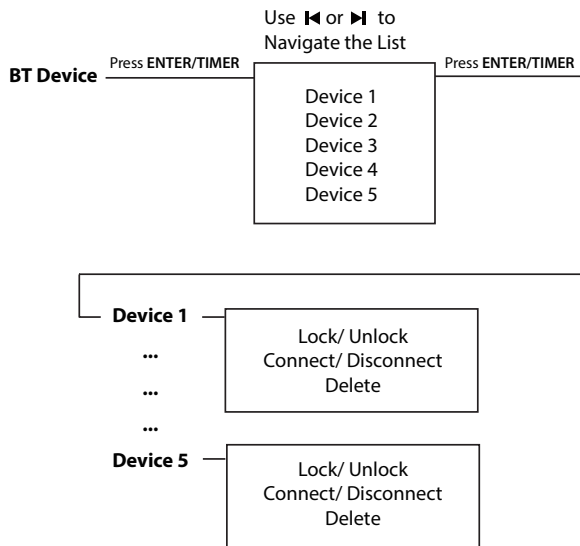

Pairing a Bluetooth Device

Before you begin, consult the owner's manual for the Bluetooth device you want to pair with the JHD22.

Bluetooth Quick Pair:

1. On your personal Bluetooth device, enter the Bluetooth settings list. Make sure your device has Bluetooth turned on and is searching for new devices.
2. Press and hold the **MODE/PAIR** button (2) for three seconds to make the JHD22 available on your Bluetooth device.
3. On your Bluetooth device, select JHD22 once it becomes available to pair and connect your device. Enter the pairing password (0000), if requested.

After connecting successfully, you will be able to listen to music stored on your Bluetooth enabled device through the radio.

BT Audio (A2DP)

The A2DP music is available for Bluetooth enabled phones when the phone is connected. To access Bluetooth mode and play songs stored on your phone, press the **MODE/PAIR** button. While in Bluetooth mode, the Bluetooth Audio icon  will appear on the LCD.

Selecting Tracks

During playback, press the ◀ or ▶ buttons (6, 7) buttons to play the previous or next track.

Pausing Playback

During playback, press the ▶▶ button (18) to pause the Bluetooth AUDIO player. "Pause" will appear on the LCD. Press ▶▶ again to resume playback. If you change to another mode, the mobile phone audio will pause. Press the **MODE/TIMER**

button (2) to return to Bluetooth mode and resume mobile phone audio playback.

NOTE: If a Bluetooth device is disconnected due to the power being turned off or if the device is disconnected inadvertently, the unit will automatically search for the matching Bluetooth device when the power is restored.

CARE AND MAINTENANCE

- Keep the product dry. If it does get wet, wipe it dry immediately. Liquids might contain minerals that can corrode the electronic circuits.
- Keep the product away from dust and dirt, which can cause premature wear of parts.
- Handle the product gently and carefully. Dropping it can damage circuit boards and cases, and can cause the product to work improperly.
- Wipe the product with a dampened cloth occasionally to keep it looking new. Do not use harsh chemicals, cleaning solvents, or strong detergents to clean the product.
- Use and store the product only in normal temperature environments. High temperature can shorten the life of electronic devices, damage batteries, and distort or melt plastic parts.

Ignition

The most common source of noise in reception is the ignition system. This is a result of the radio being placed close to the ignition system (engine). This type of noise can be easily detected because it will vary in intensity of pitch with the speed of the engine.

Usually, the ignition noise can be suppressed considerably by using a radio suppression type high voltage ignition wire and suppressor resistor in the ignition system. (Most vehicles employ this wire and resistor but it may be necessary to check them for correct operation.) Another method of suppression is the use of additional noise suppressors. These can be obtained from most CB radio or electronic supply shops.

Interference

Radio reception in a moving environment is very different from reception in a stationary environment (home). It is very important to understand the difference.

AM reception will deteriorate when passing under a bridge or when passing under high voltage lines. Although AM is subject to environmental noise, it has the ability to be received at great distance. This is because broadcasting signals follow the curvature of the earth and are reflected back by the upper atmosphere.

TROUBLESHOOTING

Symptom	Cause	Solution
No power	The vehicle's accessory switch is not on	If the power supply is properly connected to the vehicle's accessory terminal, switch the ignition key to "ACC".
	Fuse is blown	Replace the fuse.
No sound	Volume too slow	Adjust volume to audible level.
	Wiring is not properly connected	Check wiring connections.
The operation keys do not work	Control panel is not properly installed	Reinstall control panel.
	Built-in microcomputer is not operating properly due to noise	Press the RESET button.
Cannot tune to radio station, auto-seek does not work	Antenna cable is not connected	Insert the antenna cable firmly.
	Signals are too weak	Select a station manually.
ERROR-01 on LCD	Database or decoder error	Change to another mode.

SPECIFICATIONS

FM Radio

Frequency Coverage (USA)	87.5 to 107.9 MHz
Frequency Coverage (Europe/ Russia/ Japan)	87.5 to 108 MHz
Sensitivity (S/N = 30dB)	2.2 μ V
Stereo Separation.....	>25 dB

AM/MW

Frequency Range (USA).....	530-1710 kHz
Frequency Range (Europe/ Russia/ Japan).....	522-1629 kHz
Sensitivity (S/N=20dB)	30 dB

General

Frequency band(s) (for Bluetooth).....	2.4~2.4835GHz
Maximum radio-frequency power transmitted (for Bluetooth)	4 dBm
Operating Voltage	DC 12 Volts
Grounding System	Negative
Ground Speaker Impedance	4-8 ohms per channel

Tone Controls:

Bass (at 100 Hz)	\pm 10 dB
Treble (at 10 kHz)	\pm 10 dB
Maximum Power Output	40W x 4
Idle/Standby Current	<50mA
Fuse Rating	15 Ampere
Max Dimensions	188 (W) x 58 (D) x 89.9 (H)mm

FCC NOTES

WARNING! Changes or modifications to this unit not expressly approved by the party responsible for compliance could void the user's authority to operate the equipment.

NOTE: This equipment has been tested and found to comply with the limits for a Class B digital device, pursuant to Part 15 of the FCC Rules. These limits are designed to provide reasonable protection against harmful interference in a residential installation.

This equipment generates, uses and can radiate radio frequency energy and, if not installed and used in accordance with the instructions, may cause harmful interference to radio communications.

However, there is no guarantee that interference will not occur in a particular installation. If this equipment does cause harmful interference to radio or television reception, which can be determined by turning the equipment off and on, the user is encouraged to try to correct the interference by one or more of the following measures:

- Reorient or relocate the receiving antenna.
- Increase the separation between the equipment and receiver.
- Connect the equipment into an outlet on a circuit different from that to which the receiver is connected.
- Consult the dealer or an experienced radio/TV technician for help.

This equipment complies with FCC radiation exposure limits set forth for an uncontrolled environment. This equipment should be installed and operated with minimum distance 20cm between the radiator & your body.



ASA Electronics Corporation

www.asaelectronics.com
www.jensenheavyduty.com

©2022 ASA Electronics Corporation