



# Inter|Lab<sup>®</sup>

## Antenna Characterization Test Report

**Test Report Reference:** MUS\_HARMAN\_192210#FCAEXT

**Date:** 2019-10-28

**Test Laboratory:**

Bureau Veritas CPS Inc.  
1293 Anvilwood Ave  
Sunnyvale, CA 94089  
USA

**Note:**

The following test results relate only to the devices specified in this document. This report shall not be reproduced in parts without the written approval of the test laboratory.



Test report reference: MUS\_HARMAN\_192210

<b>1</b>	<b>ADMINISTRATIVE DATA</b>	<b>4</b>
1.1	Project Data	4
1.2	Applicant Data	4
1.3	Testing Laboratory	4
1.4	Signature of responsible for testing	5
1.5	Signature of responsible for accreditation scope	5
<b>2</b>	<b>OBJECT UNDER TEST DATA</b>	<b>6</b>
2.1	General SocketGate Description	6
2.2	Auxiliary Equipment	6
2.3	Description of Testing	6
<b>3</b>	<b>INTRODUCTION</b>	<b>7</b>
<b>4</b>	<b>OBJECTIVES AND SUMMARY OF TESTS TO BE PERFORMED</b>	<b>7</b>
<b>5</b>	<b>PASSIVE TESTING</b>	<b>8</b>
5.1	Test set up	8
5.2	Antenna Return Loss	9
5.3	Antenna VSWR	11
5.4	Antenna Efficiency	13
5.5	Antenna Peak Gain	15
5.6	Antenna Average Gain	17
5.7	Radiation Patterns	26
5.7.1	Reference coordinate system	26
5.7.2	EUT Orientation	26
5.7.3	3D Radiation Patterns	27
5.7.4	2D Radiation Patterns	29



---

Test report reference: MUS\_HARMAN\_192210

<b>6 CONCLUSIONS</b>	<b>37</b>
<b>ANEX A</b>	<b>37</b>
<b>BASIC DEFINITIONS OF THE ANTENNA PARAMETERS</b>	<b>37</b>
A.1 Antenna Impedance and Bandwidth	37
A.2 Efficiency	38
A.3 Average Gain	39
A.4 Peak Gain	39
A.5 Radiation Patterns	39
<b>ANEX B</b>	<b>40</b>
<b>ANECHOIC (“NO ECHO”) CHAMBERS</b>	<b>40</b>
B.1 Kinds of anechoic chambers	40
B.1.1 Tapered Anechoic Chamber	40
B.1.2 Near Field Anechoic Chamber	41
B.1.3 Rectangular Chamber	42
B.2 Chamber coordinate systems	42



Test report reference: MUS\_HARMAN\_192210

## 1 Administrative Data

### 1.1 Project Data

Responsible for testing and report:	Alberto Saldivar
Receipt of OUT:	2019-10-15
Date of first test:	2019-10-17
Date of last test:	2019-10-18
Date of Report:	2019-10-28

### 1.2 Applicant Data

Company Name:	Harman International Industries, Inc.
Address:	30001 Cabot Drive Novi, MI 48377 USA

Contact Person:	Mark Bowman
	Phone: +1 (248) 633 5481
	email: <a href="mailto:mark.bowman@harman.com">mark.bowman@harman.com</a>

### 1.3 Testing Laboratory

Company Name:	Bureau Veritas CPS Inc.
Street:	1293 Anvilwood Ave
City:	Sunnyvale, CA 94089
Country:	USA
Contact Person:	Jenil Nathwani
Phone:	+1-949-716-6512
Email:	Jenil.nathwani@us.bureauveritas.com

### Laboratory Details

Identification:	OTA 3 Chamber
Responsible:	Felix Huang.

\*Details of the laboratory equipment available upon request.



---

Test report reference: MUS\_HARMAN\_192210

**1.4 Signature of responsible for testing**

---

Alberto Saldivar

**1.5 Signature of responsible for accreditation scope**

---

Eddie Parsons



---

Test report reference: MUS\_HARMAN\_192210

## 2 Object Under Test Data

### 2.1 General SocketGate Description

Manufacturer	Harman
Model	FCA R1 INT
Serial Number/IMEI	FCAR1DV4C07535190037
Hardware Version	N/A
Software Version	N/A

### 2.2 Auxiliary Equipment

Type	Manufacturer	Model	Version
N/A	N/A	N/A	N/A

### 2.3 Description of Testing

7layers has been tasked to perform passive antenna characterization for Harman antennas in order to evaluate the performance (efficiency, Return Loss, Peak Gain, 2D-3D Radiation Patterns).



---

Test report reference: MUS\_HARMAN\_192210

### **3 Introduction**

This package is for customers who want to identify the most suitable off-the-self antenna for their device in terms of performance. This testing should provide key metrics to indicate if the selected antenna would meet the required performance when paired with the device. The test will be performed in an accredited OTA chamber, producing reliable results to be analysed by our Sr. RF Engineer. This package is also included in the "*Product Review Package*" and does not include antenna matching services.

The services performed will include:

- Testing each antenna in an accredited test environment, providing the characteristics of the antenna.

Deliverables:

- Report detailing the results of each antenna includes radiation pattern, efficiency, return loss and peak gain of each antenna.

Requirements:

- Sample prototype to be tested (if applicable)
- sample of each antenna to be tested

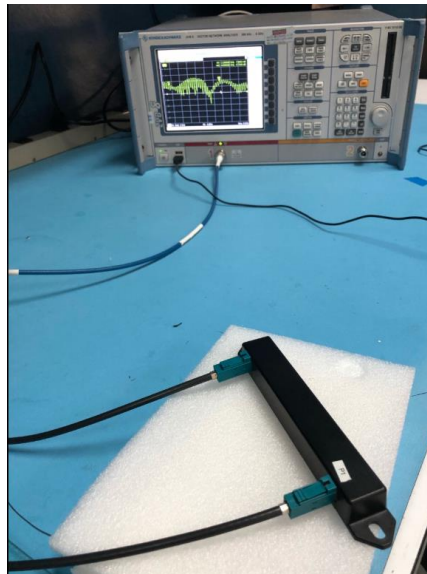
### **4 Objectives and Summary of Tests to be Performed**

- Measure the Return Loss and VSWR of the antennas.
- Measure the efficiency, radiation patterns and peak gain of the antenna.

## 5 Passive testing

### 5.1 Test set up

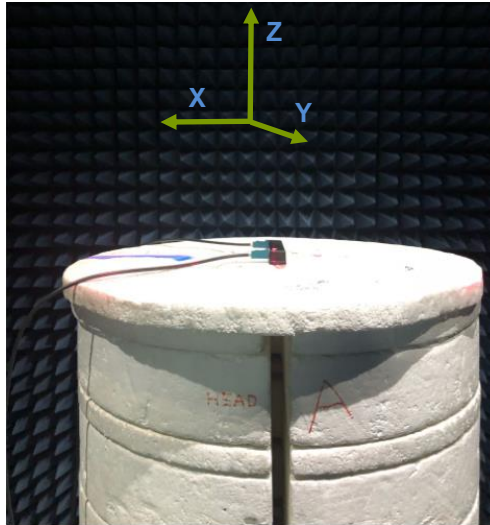
Figure 1 shows the Return Loss test set up with the VNA, the antenna is connected to the VNA using a low loss coaxial cable, the reference plane of the VNA was move it until the end of the low loss coaxial cable in order to measure accurately the Return Loss the antenna.



**Figure 1.** Return Loss and VSWR test set up

Figure 2 shows the OTA test set up for Efficiency and Peak Gain testing, an RF signal is injected to the antenna, and most of this RF signal is radiated by the antenna and measured.

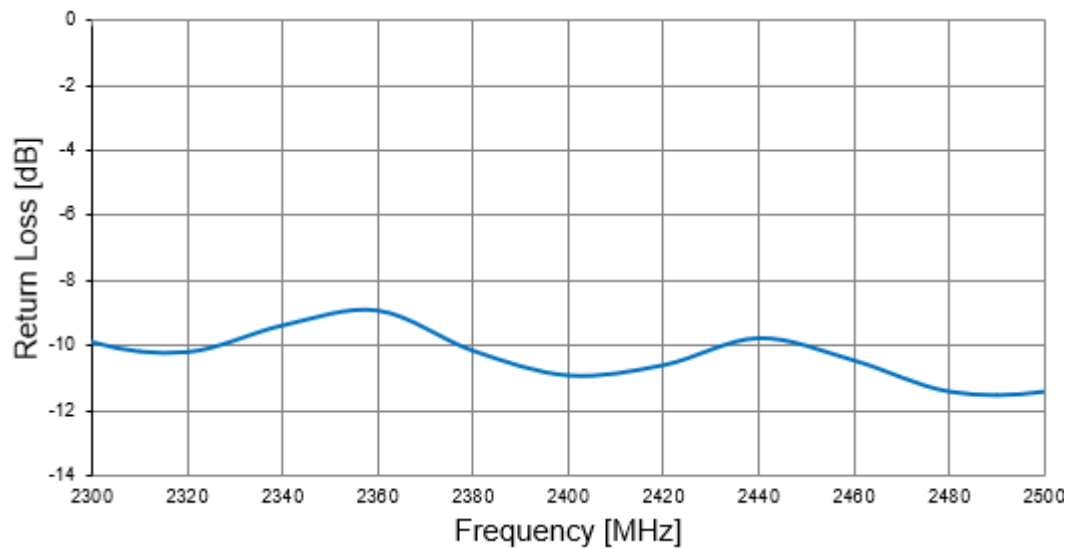




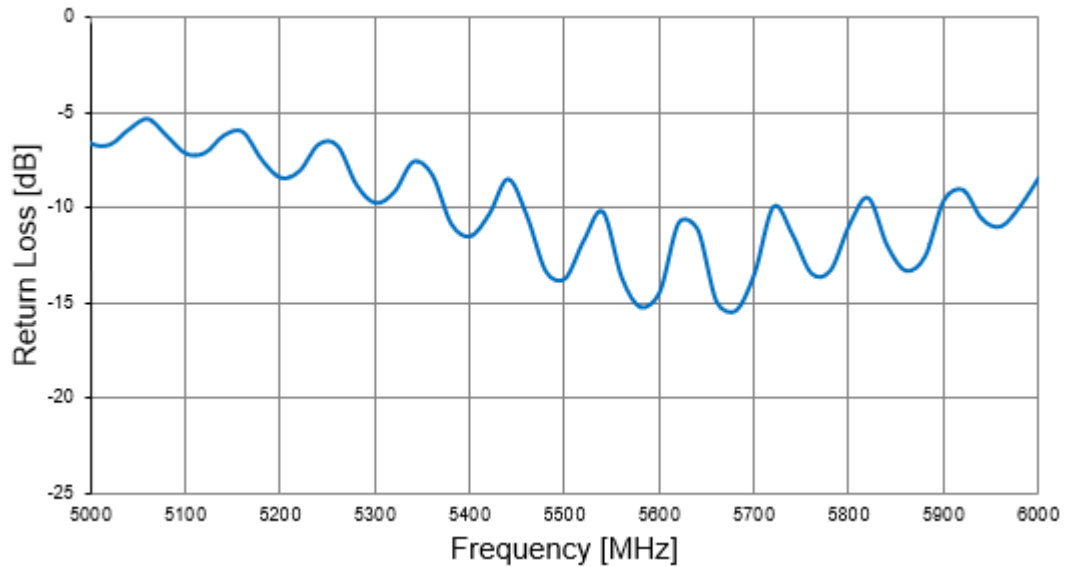
**Figure 2.** OTA test set up

## 5.2 Antenna Return Loss

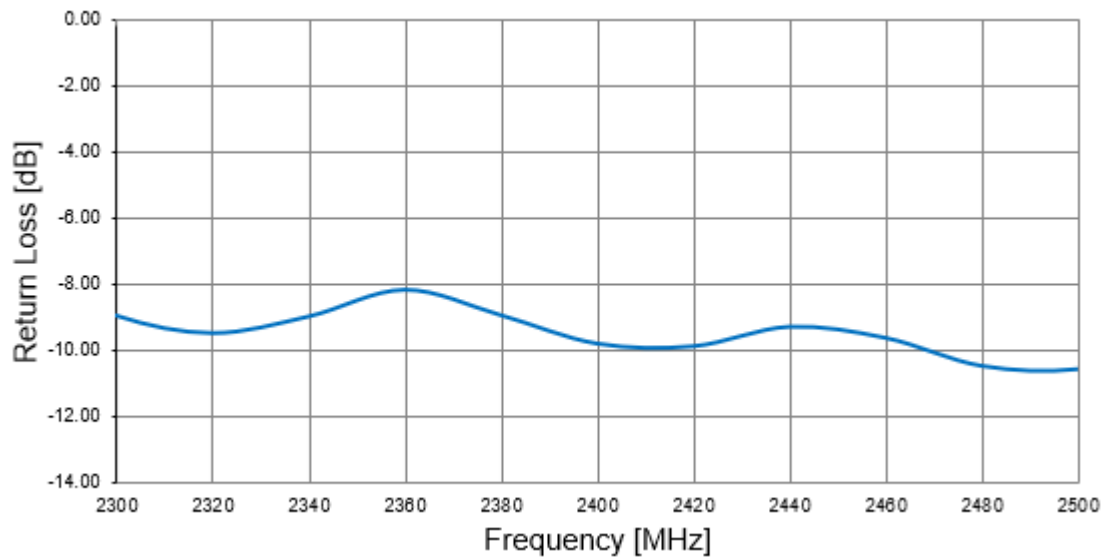
The following figure shows the antenna Return Loss.



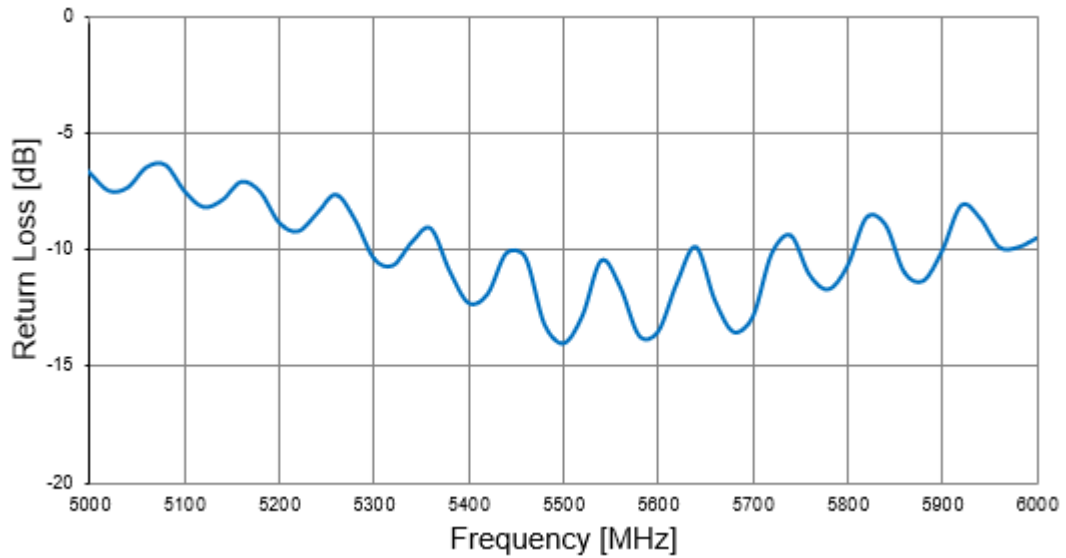
**Figure 3.** Antenna Return Loss at 2.4GHz Port1.



**Figure 4.** Antenna Return Loss at 5.0GHz Port1.



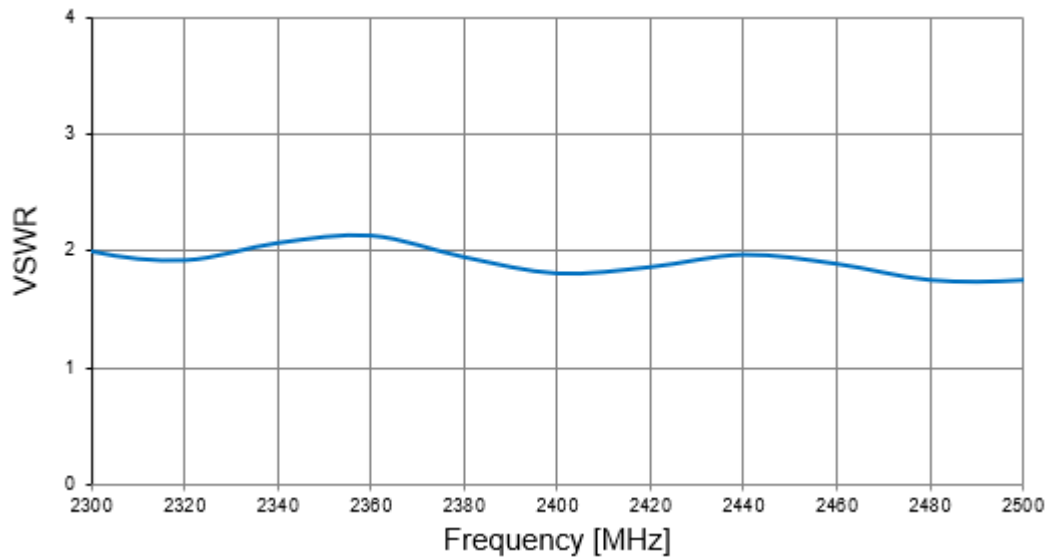
**Figure 5.** Antenna Return Loss at 2.4 GHz Port2.



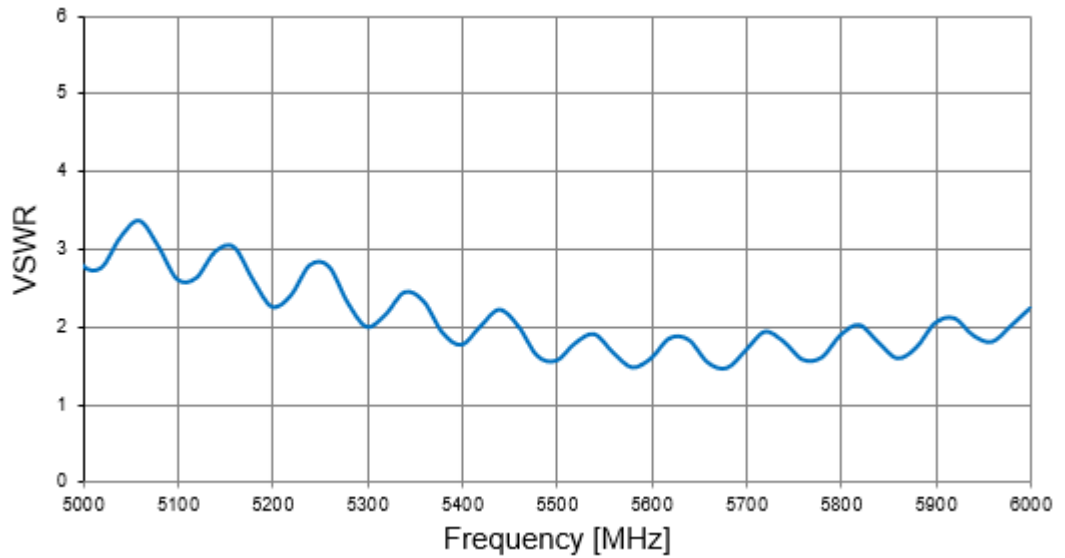
**Figure 6.** Antenna Return Loss at 5.0GHz Port2.

### 5.3 Antenna VSWR

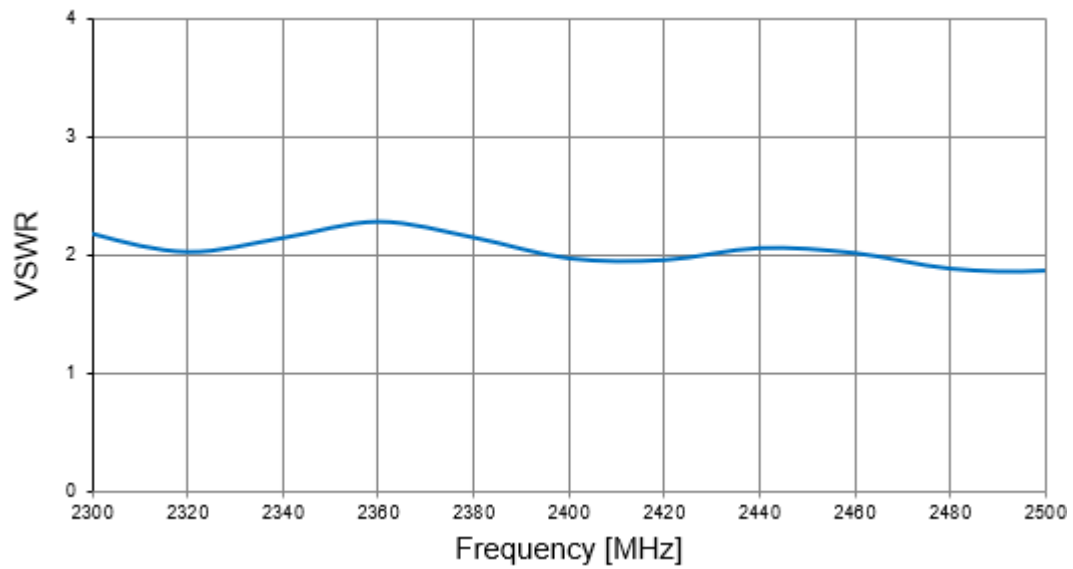
The following figure shows the Antenna VSWR.



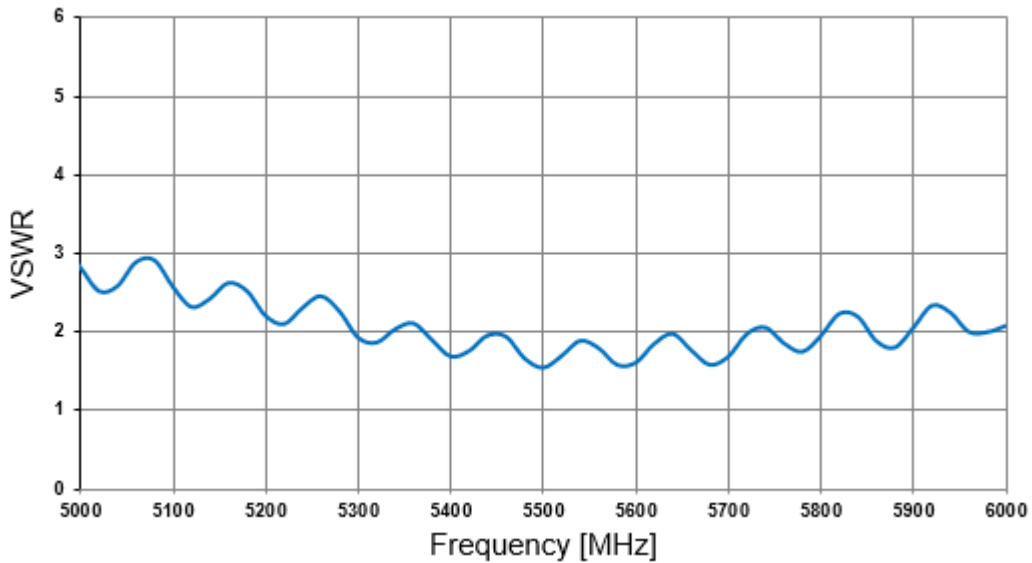
**Figure 7.** Antenna VSWR AT 2.4GHz PORT1.



**Figure 8.** Antenna VSWR at 5.0GHz PORT1.



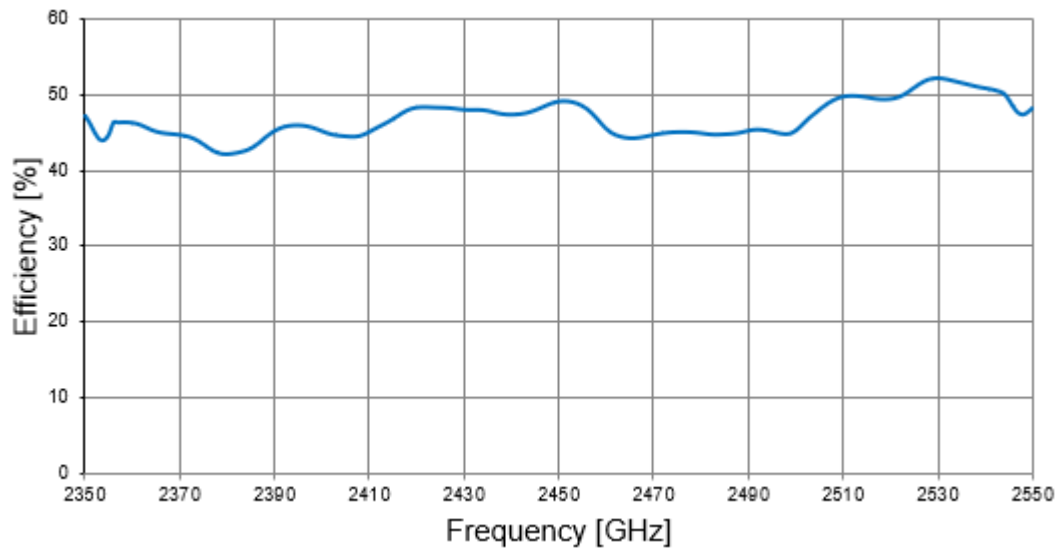
**Figure 9.** Antenna VSWR at 2.4GHz Port2.



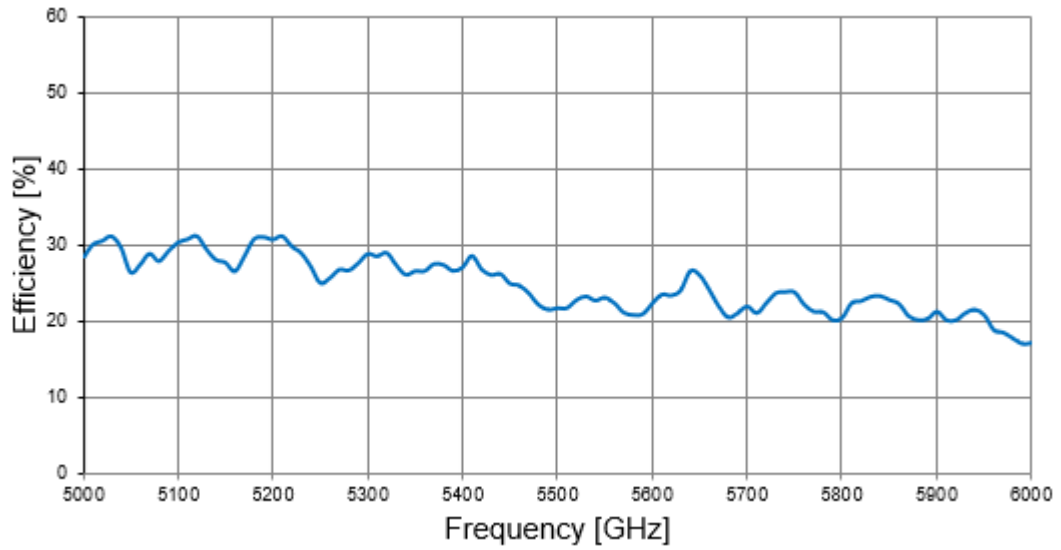
**Figure 10.** Antenna VSWR at 5GHz Port2.

#### 5.4 Antenna Efficiency

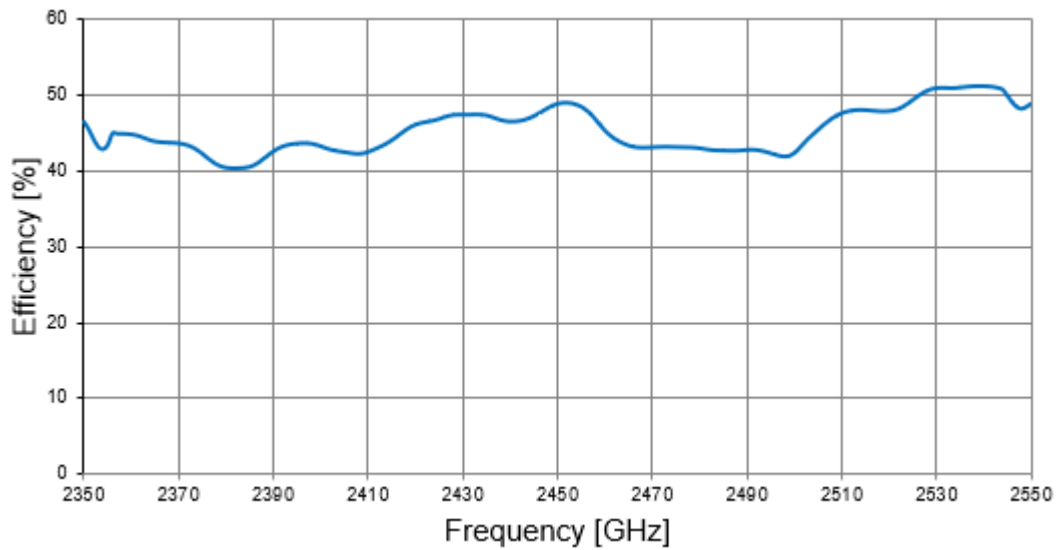
The following figure shows the efficiency of the device.



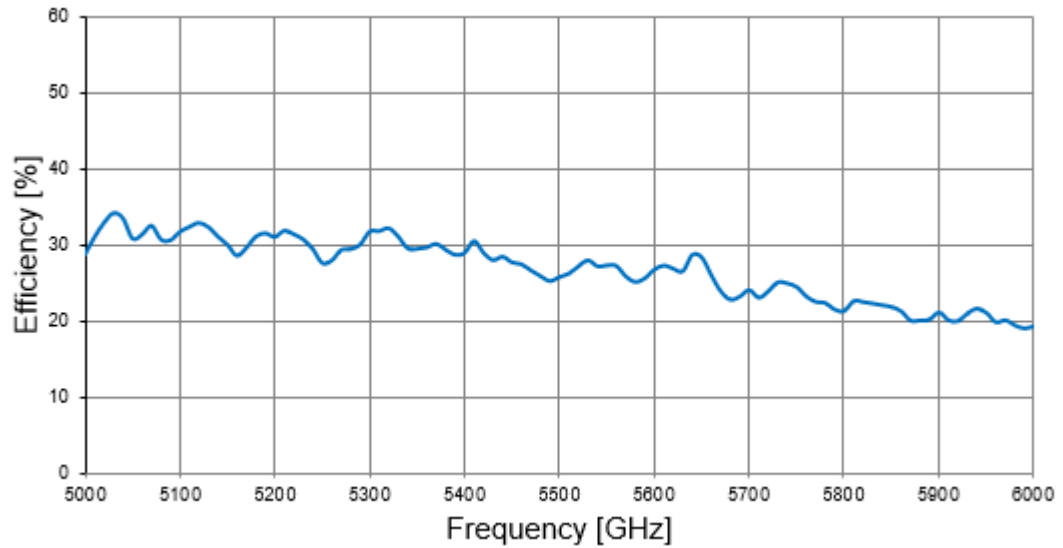
**Figure 11.** Antenna Efficiency at 2.4GHz Port1.



**Figure 12.** Antenna Efficiency at 5GHz Port1.



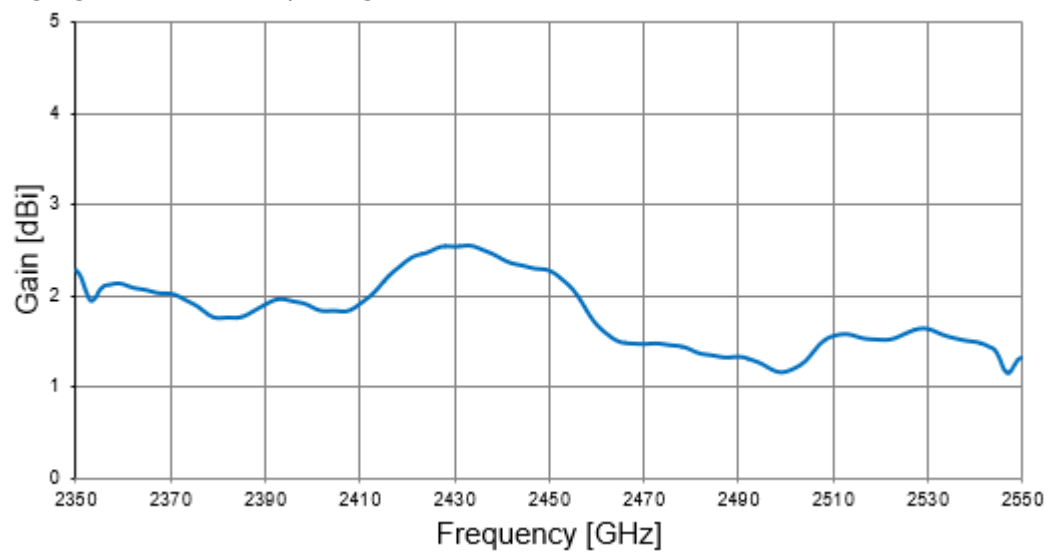
**Figure 13.** Antenna Efficiency at 2.4GHz Port2.



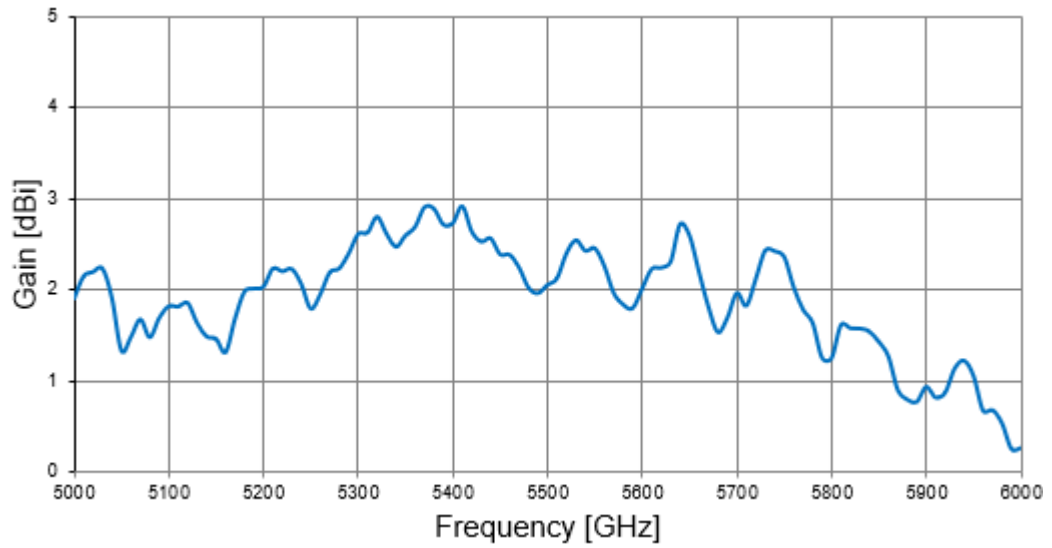
**Figure 14.** Antenna Efficiency at 5GHz Port2.

## 5.5 Antenna Peak Gain

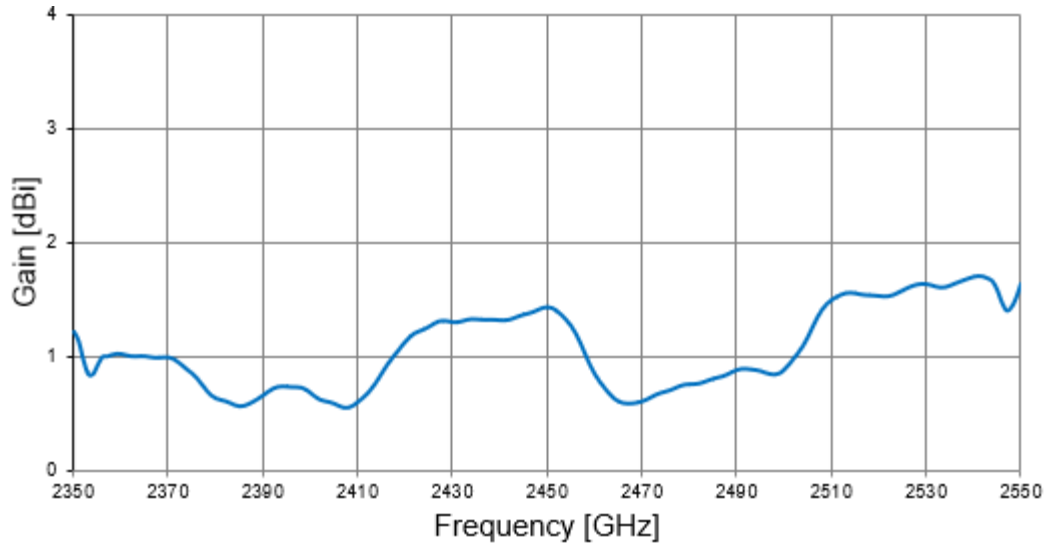
The following figure shows the peak gain of the device.



**Figure 15.** Antenna Peak Gain at 2.4GHz Port1.

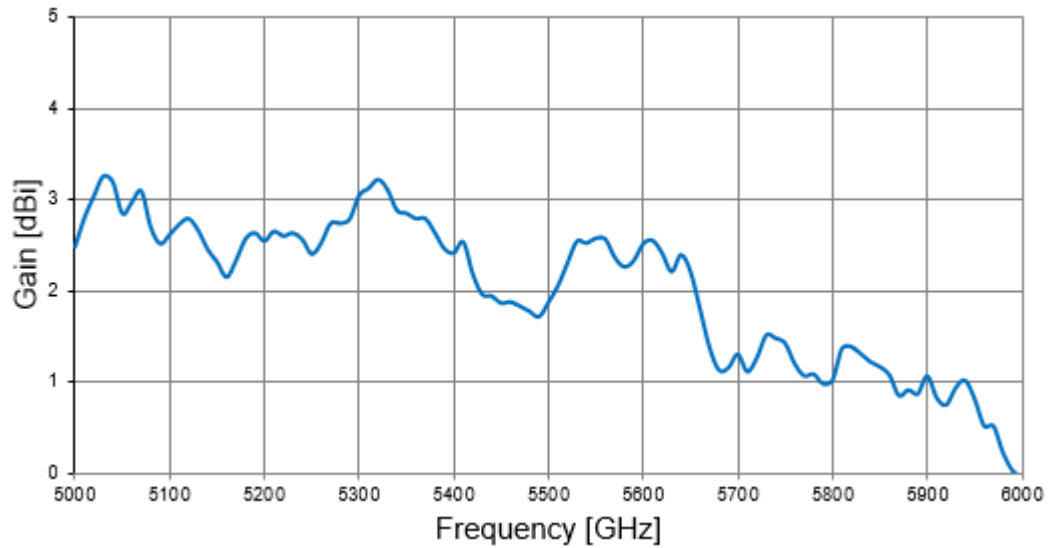


**Figure 16.** Antenna Peak Gain at 5GHz Port1.



**Figure 17.** Antenna Peak Gain at 2.4GHz Port2.

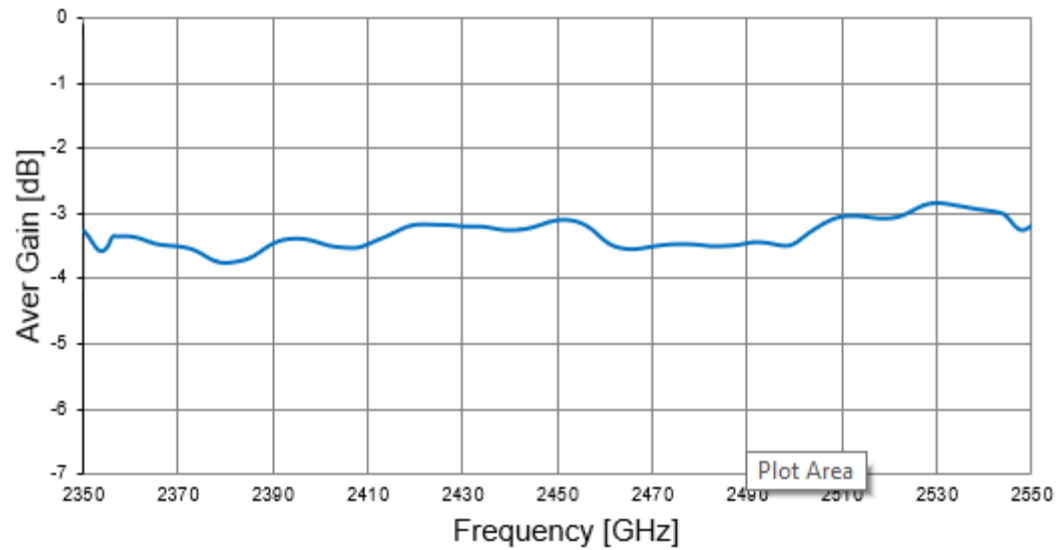




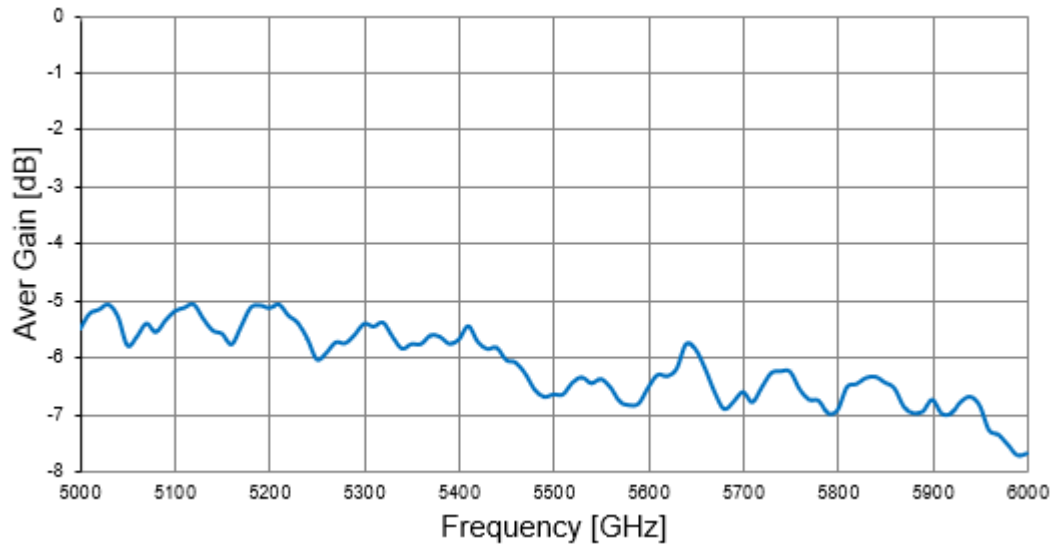
**Figure 18.** Antenna Peak Gain at 5GHz Port2.

### 5.6 Antenna Average Gain

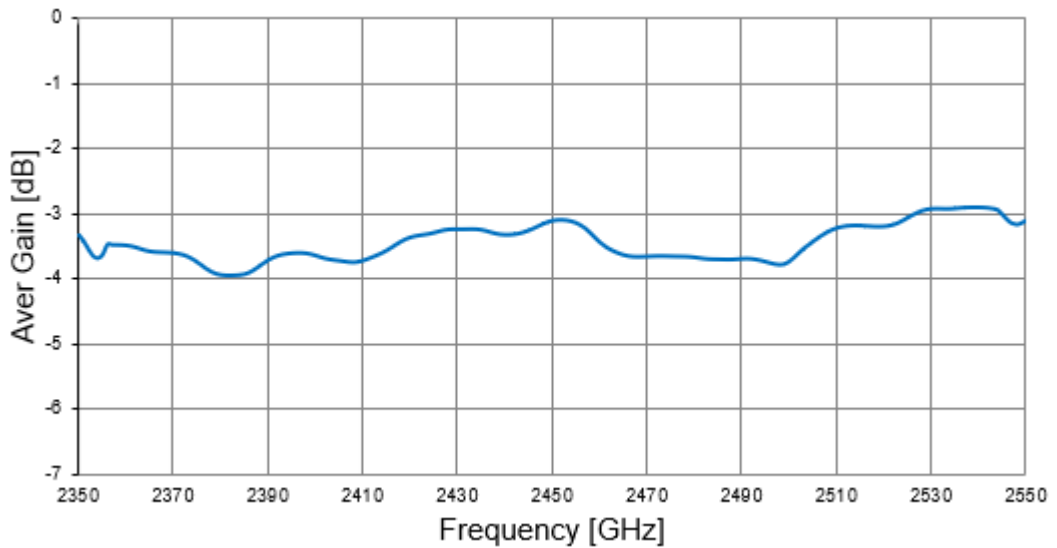
The following figure shows the peak gain of the device.



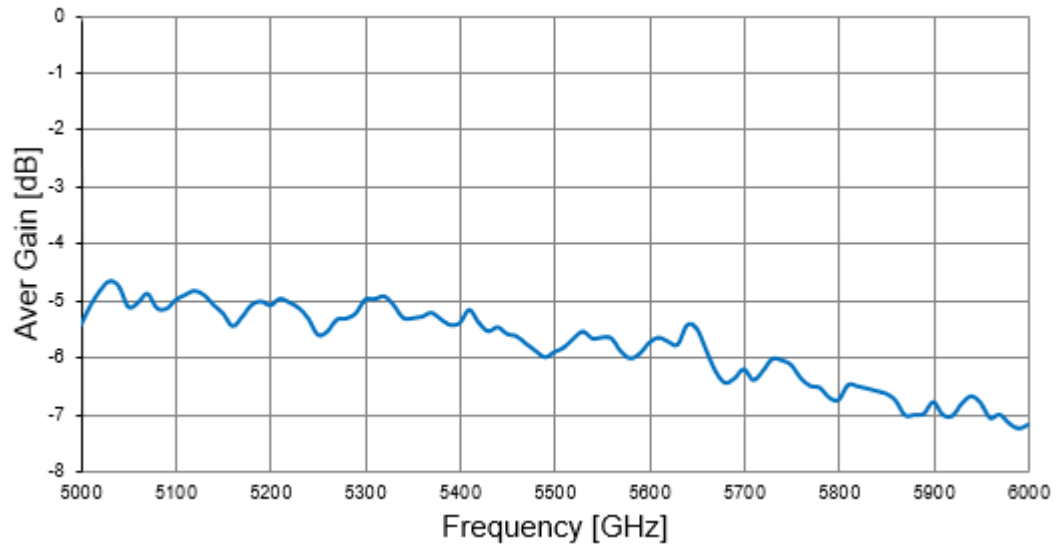
**Figure 19.** Antenna Average Gain at 2.4GHz Port1.



**Figure 20.** Antenna Average Gain at 5GHz Port1.



**Figure 21.** Antenna Average Gain at 2.4GHz Port2.



**Figure 22.** Antenna Average Gain at 5GHz Port2.

Table 1, shows the antenna characteristics at 2.4GHz Port1.

Frequency	Efficiency [%]	Peak Gain [dBi]	Efficiency [dB]
2400	43.239	0.679153	-3.641243586
2402	42.8072	0.621031	-3.684831782
2405	42.4695	0.585872	-3.71922852
2410	42.4954	0.60235	-3.716580785
2415	44.0266	0.851954	-3.562848521
2420	46.0681	1.12984	-3.365996991
2425	46.8201	1.25992	-3.295676631
2430	47.3862	1.29873	-3.243481169
2435	47.29	1.32438	-3.25230686
2440	46.4866	1.31575	-3.326722167
2441	46.4943	1.31497	-3.326002865
2445	47.1948	1.36498	-3.2610585
2450	48.8128	1.43078	-3.114662796
2455	48.434	1.26546	-3.148496626
2460	45.3033	0.844524	-3.438701618

Test report reference: MUS\_HARMAN\_192210

2462	44.2479	0.726717	-3.54107336
2465	43.3365	0.605966	-3.631461667
2470	43.1052	0.606947	-3.654703355
2475	43.1357	0.693123	-3.651631499
2480	42.9821	0.756761	-3.667123698
2485	42.6803	0.804747	-3.697725366
2490	42.76	0.880925	-3.689623035
2495	42.3283	0.871855	-3.733691734
2500	42.338	0.884006	-3.732696614

Table 2, shows the antenna characteristics at 5.0 GHz Port1.

<i>Frequency</i>	<i>Efficiency [%]</i>	<i>Peak Gain [dBi]</i>	<i>Efficiency [dB]</i>
5000	28.7253	2.49	-5.41735427
5020	32.9208	3.04631	-4.825296197
5040	33.4917	3.19507	-4.750628076
5060	31.3565	2.97568	-5.036724191
5080	30.7044	2.70025	-5.127993848
5100	31.726	2.6227	-4.985846801
5120	32.9003	2.79678	-4.828001419
5140	31.0718	2.4613	-5.076335872
5160	28.5462	2.15629	-5.444516958
5180	31.083	2.57369	-5.074770716
5200	31.0356	2.55238	-5.081398541
5220	31.3885	2.60483	-5.03229438
5240	29.4337	2.56887	-5.311551409
5260	27.931	2.53202	-5.539135152
5280	29.4269	2.74474	-5.312554866

Test report reference: MUS\_HARMAN\_192210

5300	31.7546	3.05118	-4.981933535
5320	32.1858	3.2246	-4.923356917
5340	29.518	2.88516	-5.299130716
5360	29.6393	2.79749	-5.281320574
5380	29.3427	2.6419	-5.324999266
5400	28.9211	2.42176	-5.387851929
5420	28.9221	2.19096	-5.387701766
5440	28.4236	1.94946	-5.463209172
5460	27.4002	1.88504	-5.622462672
5480	25.8424	1.78122	-5.876671556
5500	25.7336	1.88104	-5.894994539

<i>Frequency</i>	<i>Efficiency [%]</i>	<i>Peak Gain [dBi]</i>	<i>Efficiency [dB]</i>
5520	27.1509	2.30936	-5.662157698
5540	27.1542	2.52869	-5.661629876
5560	27.1939	2.57156	-5.655285038
5580	25.0774	2.26823	-6.007174927
5600	26.7059	2.51999	-5.733927815
5620	26.817	2.41852	-5.71589808
5640	28.661	2.40023	-5.427086609
5660	25.9603	1.80755	-5.856902931
5680	22.7299	1.13813	-6.434024749
5700	24.0032	1.31009	-6.197308562
5720	23.8226	1.27187	-6.230108413
5740	24.8827	1.48636	-6.041024965
5760	23.1628	1.20707	-6.352089427
5780	22.2856	1.09385	-6.519756688
5800	21.2124	1.02967	-6.73410192



---

Test report reference: MUS\_HARMAN\_192210

5820	22.412	1.39285	-6.495193862
5840	21.9931	1.22797	-6.577135511
5860	21.1857	1.08431	-6.739571818
5880	19.9762	0.921062	-6.994871225
5900	21.0317	1.07353	-6.771256217
5920	19.8851	0.757557	-7.014722207
5940	21.5342	1.0264	-6.668712577
5960	19.7278	0.529015	-7.049213436
5980	19.3111	0.232366	-7.141929872
6000	19.1965	-0.0301562	-7.167779468

Test report reference: MUS\_HARMAN\_192210

Table 1, shows the antenna characteristics at 2.4GHz Port2.

<i>Frequency</i>	<i>Efficiency [%]</i>	<i>Peak Gain [dBi]</i>	<i>Efficiency [dB]</i>
2400	43.239	0.679153	-3.641243586
2402	42.8072	0.621031	-3.684831782
2405	42.4695	0.585872	-3.71922852
2410	42.4954	0.60235	-3.716580785
2415	44.0266	0.851954	-3.562848521
2420	46.0681	1.12984	-3.365996991
2425	46.8201	1.25992	-3.295676631
2430	47.3862	1.29873	-3.243481169
2435	47.29	1.32438	-3.25230686
2440	46.4866	1.31575	-3.326722167
2441	46.4943	1.31497	-3.326002865
2445	47.1948	1.36498	-3.2610585
2450	48.8128	1.43078	-3.11466
2455	48.434	1.26546	-3.1485
2460	45.3033	0.844524	-3.4387
2462	44.2479	0.726717	-3.54107
2465	43.3365	0.605966	-3.63146
2470	43.1052	0.606947	-3.6547
2475	43.1357	0.693123	-3.65163
2480	42.9821	0.756761	-3.66712
2485	42.6803	0.804747	-3.69773
2490	42.76	0.880925	-3.68962
2495	42.3283	0.871855	-3.73369
2500	42.338	0.884006	-3.7327

Test report reference: MUS\_HARMAN\_192210

Table 2, shows the antenna characteristics at 5.0 GHz Port2.

<i>Frequency</i>	<i>Efficiency [%]</i>	<i>Peak Gain [dBi]</i>	<i>Efficiency [dB]</i>
5000	28.7253	2.49	-5.41735427
5020	32.9208	3.04631	-4.8253
5040	33.4917	3.19507	33.4917
5060	31.3565	2.97568	-5.03672
5080	30.7044	2.70025	-5.12799
5100	31.726	2.6227	-4.98585
5120	32.9003	2.79678	-4.828
5140	31.0718	2.4613	-5.07634
5160	28.5462	2.15629	-5.44452
5180	31.083	2.57369	-5.07477
5200	31.0356	2.55238	-5.0814
5220	31.3885	2.60483	-5.03229
5240	29.4337	2.56887	-5.31155
5260	27.931	2.53202	-5.53914
5280	29.4269	2.74474	-5.31255
5300	31.7546	3.05118	-4.98193
5320	32.1858	3.2246	-4.92336
5340	29.518	2.88516	-5.29913
5360	29.6393	2.79749	-5.28132
5380	29.3427	2.6419	-5.325
5400	28.9211	2.42176	-5.38785
5420	28.9221	2.19096	-5.3877
5440	28.4236	1.94946	-5.46321
5460	27.4002	1.88504	-5.62246
5480	25.8424	1.78122	-5.87667
5500	25.7336	1.88104	-5.89499

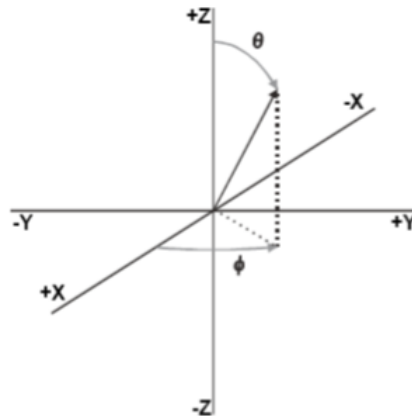


Test report reference: MUS\_HARMAN\_192210

<i>Frequency</i>	<i>Efficiency [%]</i>	<i>Peak Gain [dBi]</i>	<i>Efficiency [dB]</i>
5520	27.1509	2.30936	-5.66216
5540	27.1542	2.52869	-5.66163
5560	27.1939	2.57156	-5.65529
5580	25.0774	2.26823	-6.00717
5600	26.7059	2.51999	-5.73393
5620	26.817	2.41852	-5.7159
5640	28.661	2.40023	-5.42709
5660	25.9603	1.80755	-5.8569
5680	22.7299	1.13813	-6.43402
5700	24.0032	1.31009	-6.19731
5720	23.8226	1.27187	-6.23011
5740	24.8827	1.48636	-6.04102
5760	23.1628	1.20707	-6.35209
5780	22.2856	1.09385	-6.51976
5800	21.2124	1.02967	-6.7341
5820	22.412	1.39285	-6.49519
5840	21.9931	1.22797	-6.57714
5860	21.1857	1.08431	-6.73957
5880	19.9762	0.921062	-6.99487
5900	21.0317	1.07353	-6.77126
5920	19.8851	0.757557	-7.01472
5940	21.5342	1.0264	-6.66871
5960	19.7278	0.529015	-7.04921
5980	19.3111	0.232366	-7.14193
6000	19.1965	-0.0301562	-7.16778

## 5.7 Radiattion Patterns

### 5.7.1 Reference coordinate system



*Figure 23. Reference coordinate system*

X-axis: Theta = +90° / Phi = 0°

Y axis: Theta = +90 and Phi = +90

Z axis: Theta = 0

### 5.7.2 EUT Orientation

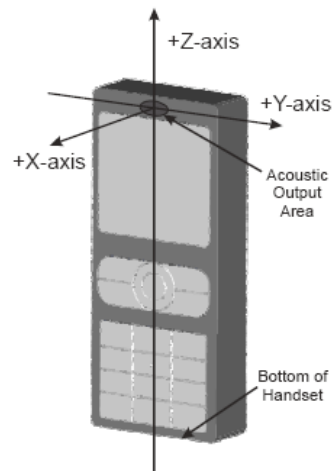


Figure 24. OUT orientation

### 5.7.3 3D Radiation Patterns

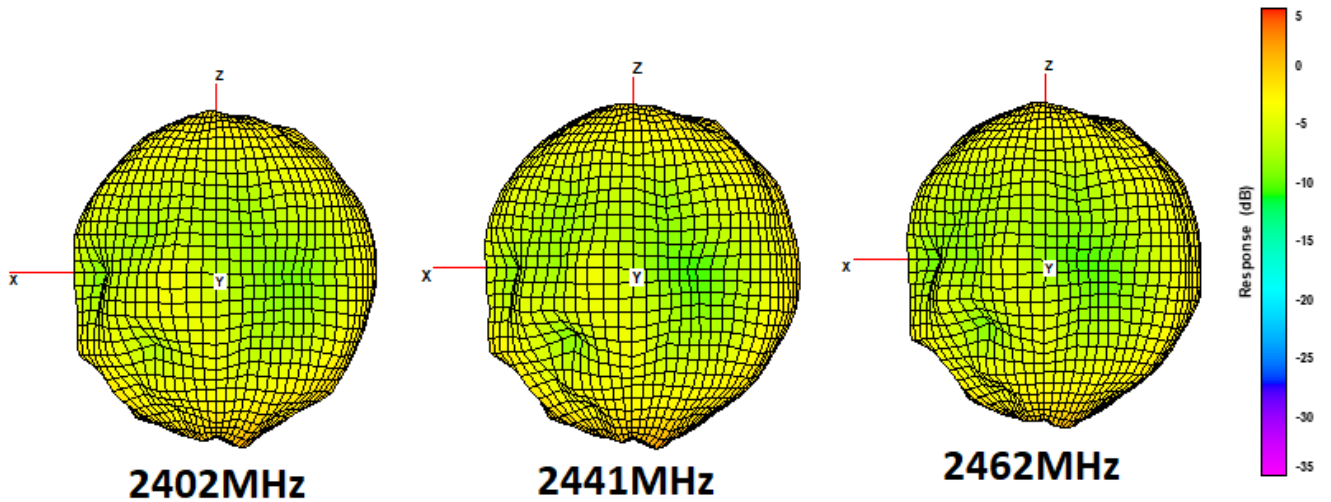


Figure 25. 3D radiation patterns at 2.4GHz Port1.

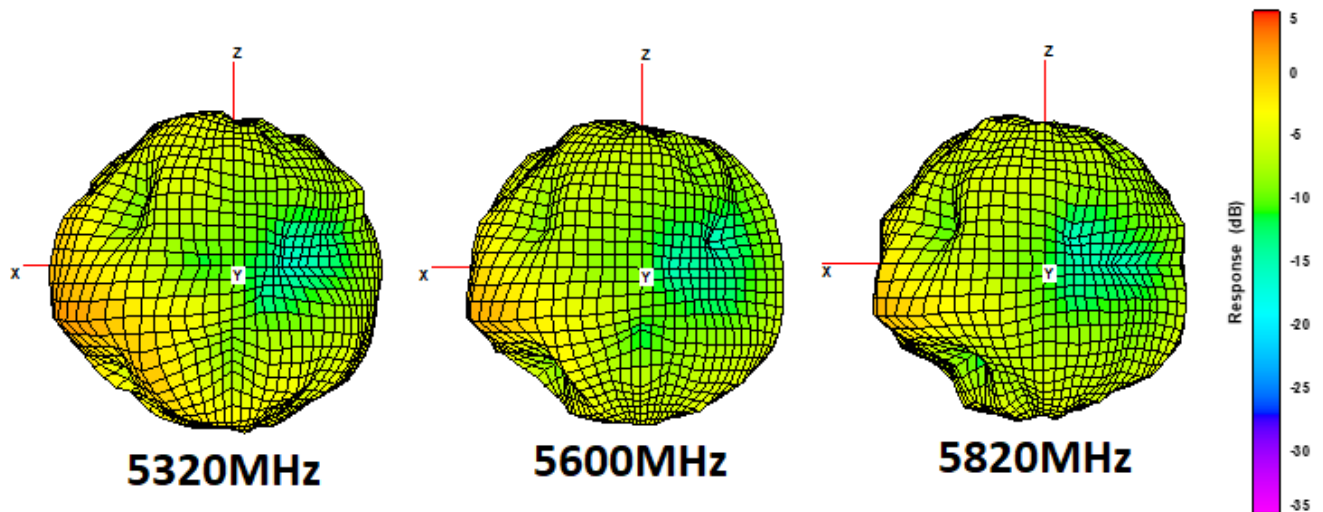


Figure 26. 3D radiation patterns at 5.0GHz Port1.

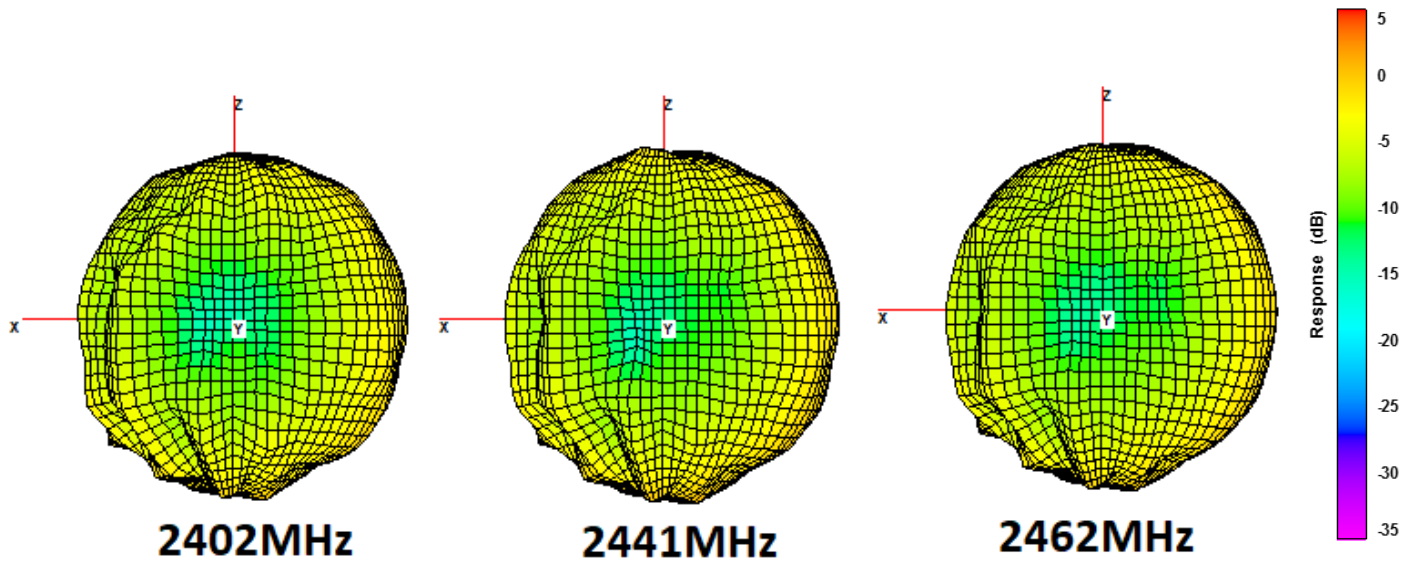


Figure 27. 3D radiation patterns at 2.4GHz Port2.

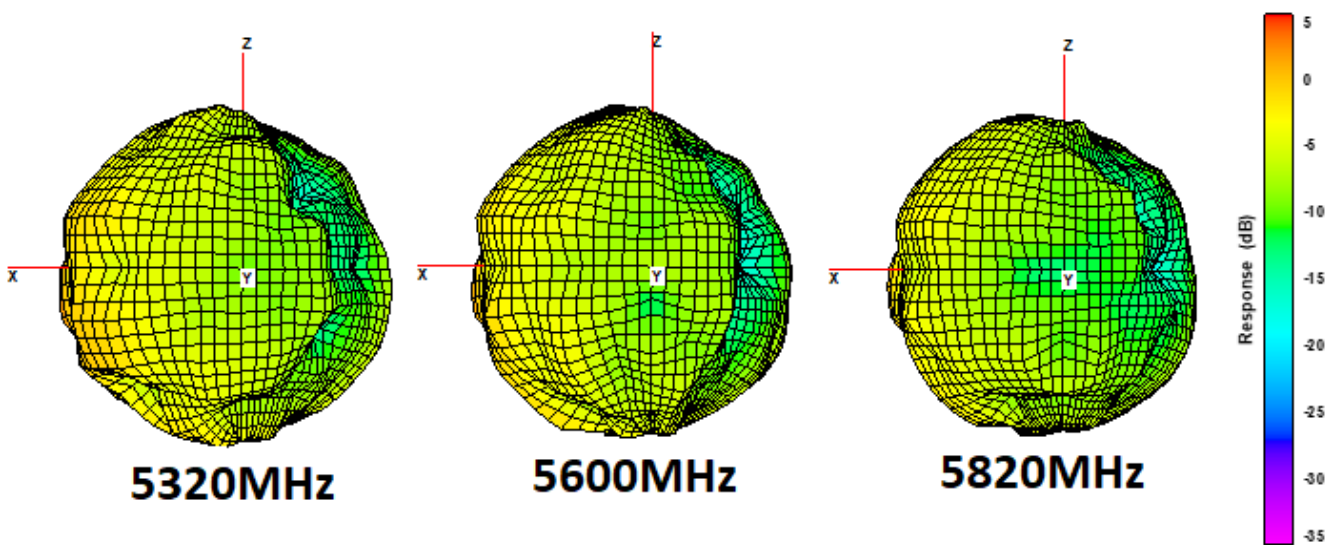
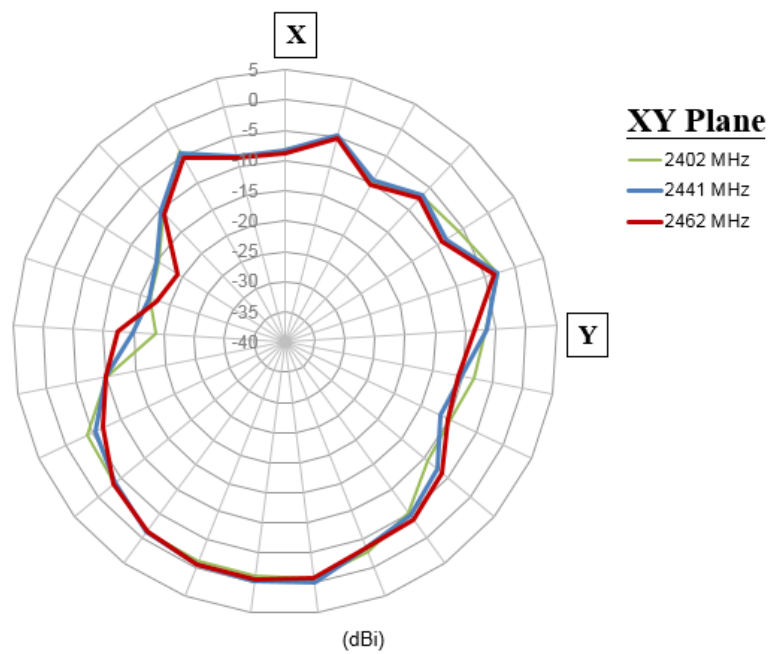
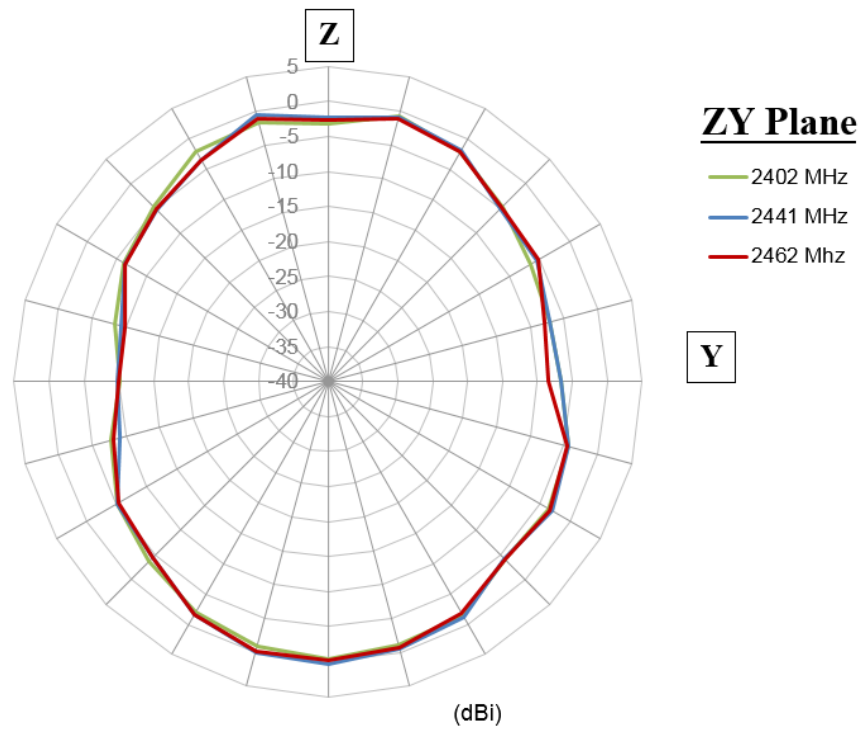
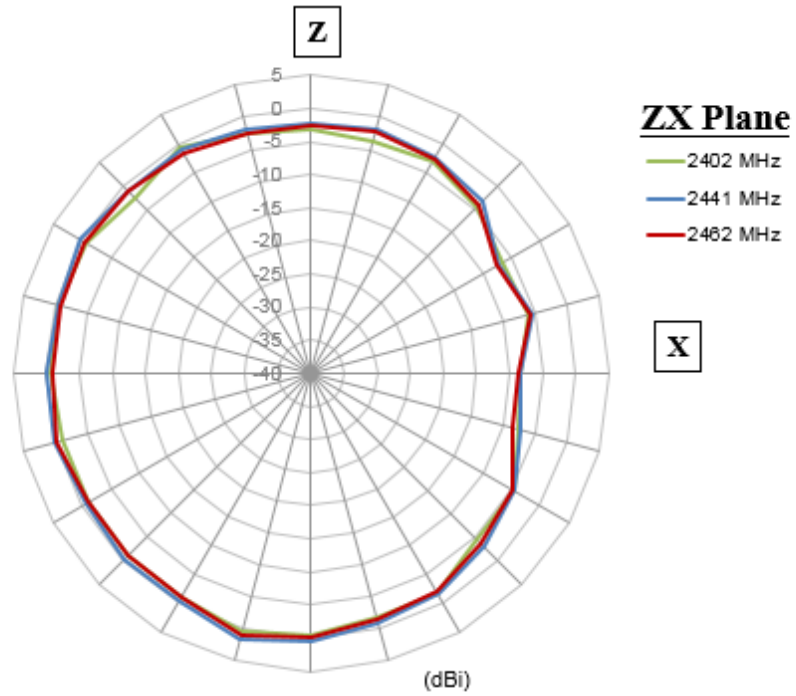


Figure 28. 3D radiation patterns at 5.0GHz Port2.

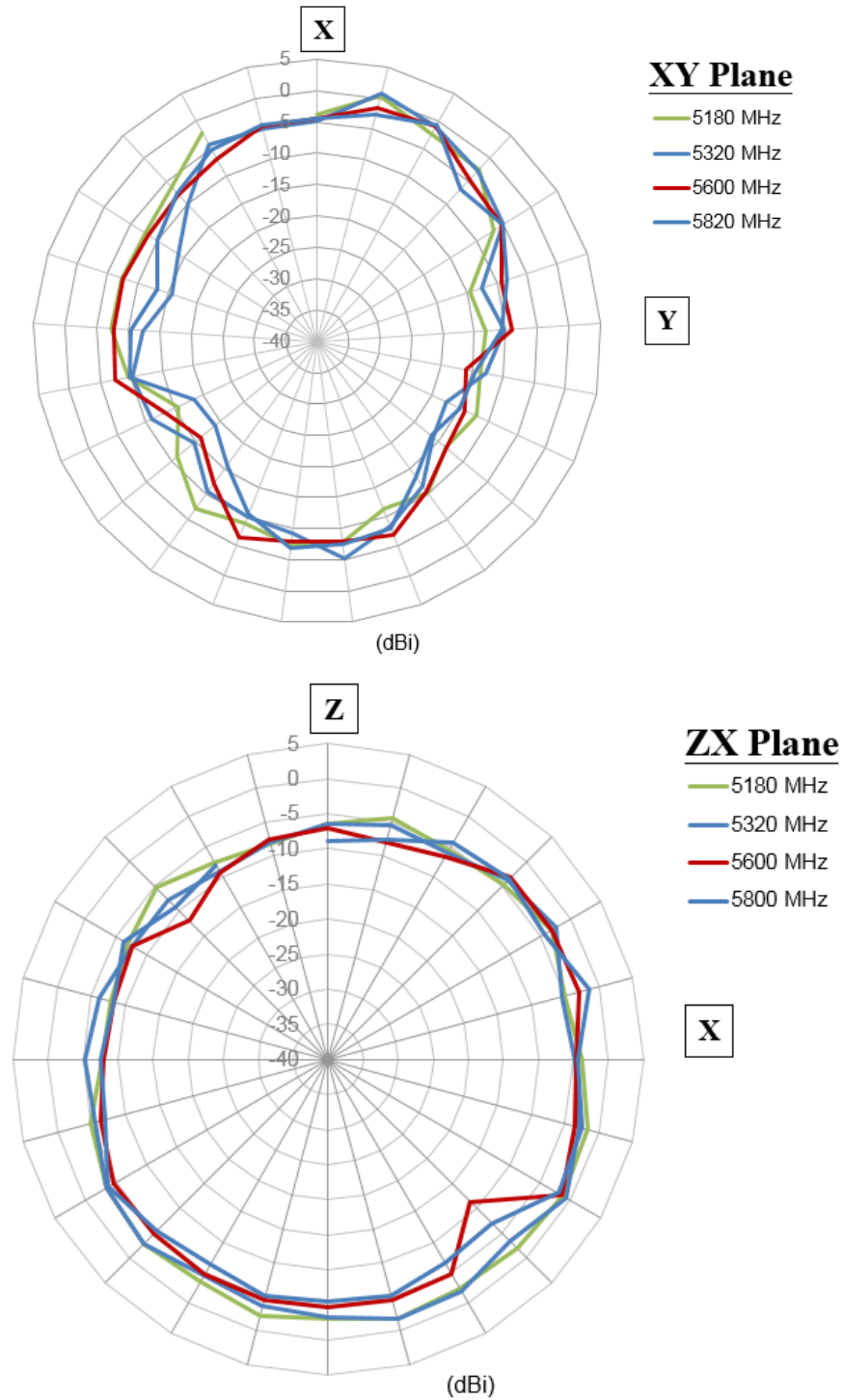
### 5.7.4 2D Radiation Patterns

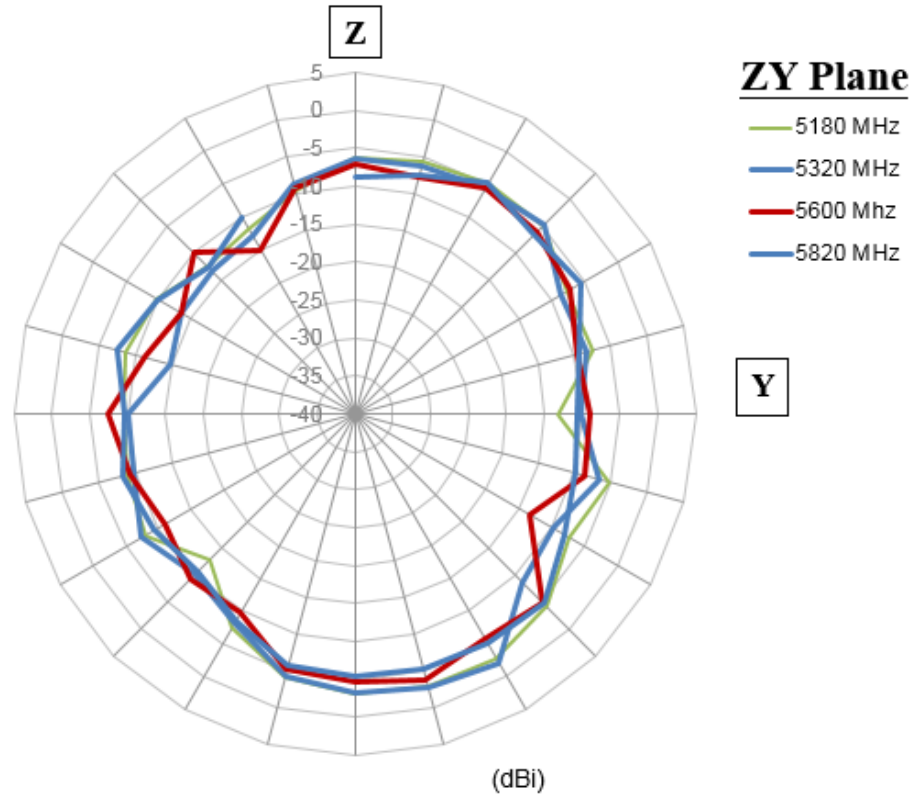
Figure 29, 30, 31 and 32 shows the 2D radiation patterns of the antenna at three different frequencies.





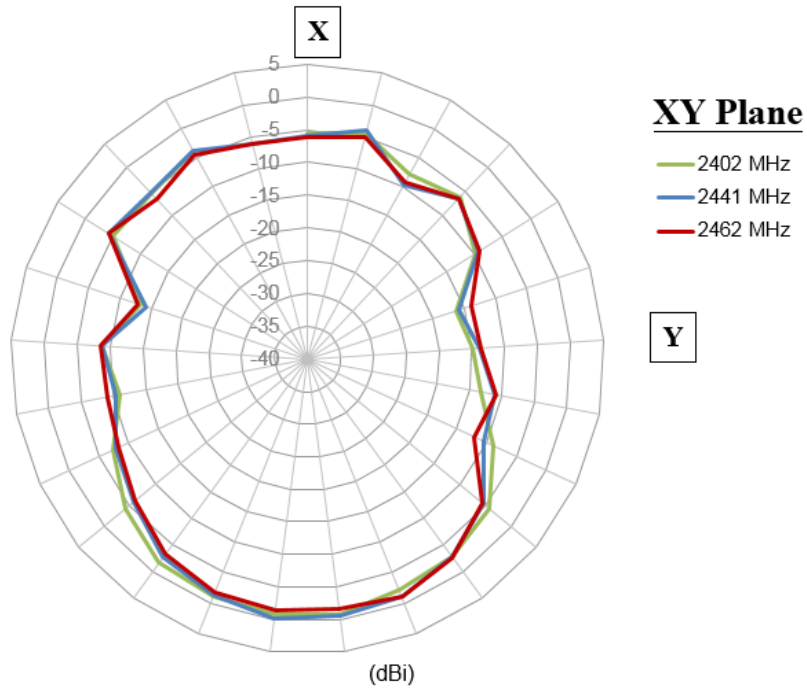
**Figure 29.** 2D radiation patterns WLAN at 2.4GHz Port 1.



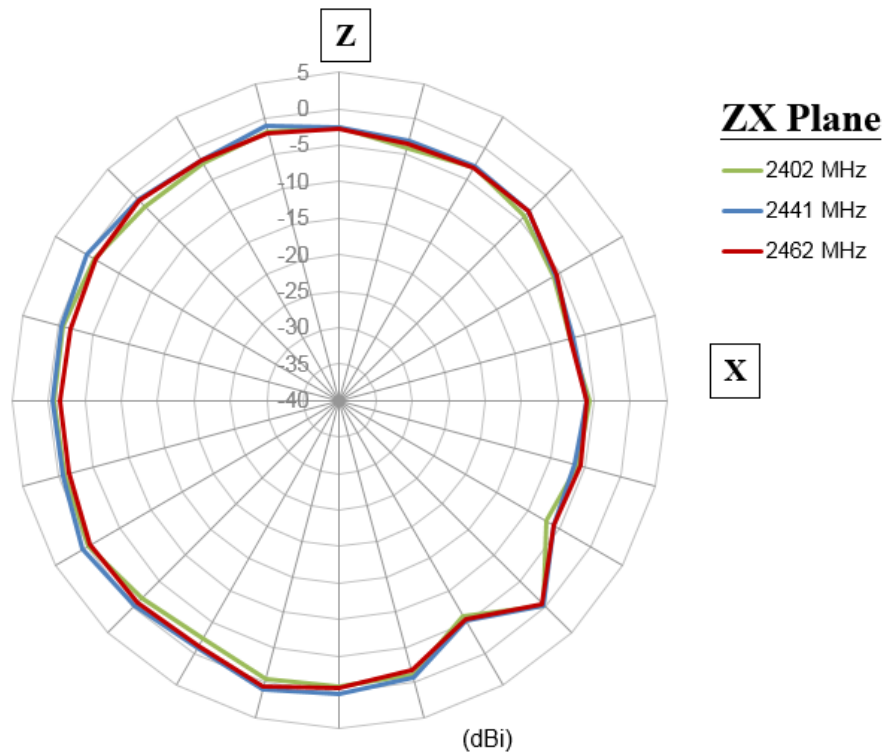


**Figure 30.** 2D radiation patterns WLAN at 5.0GHz Port 1.

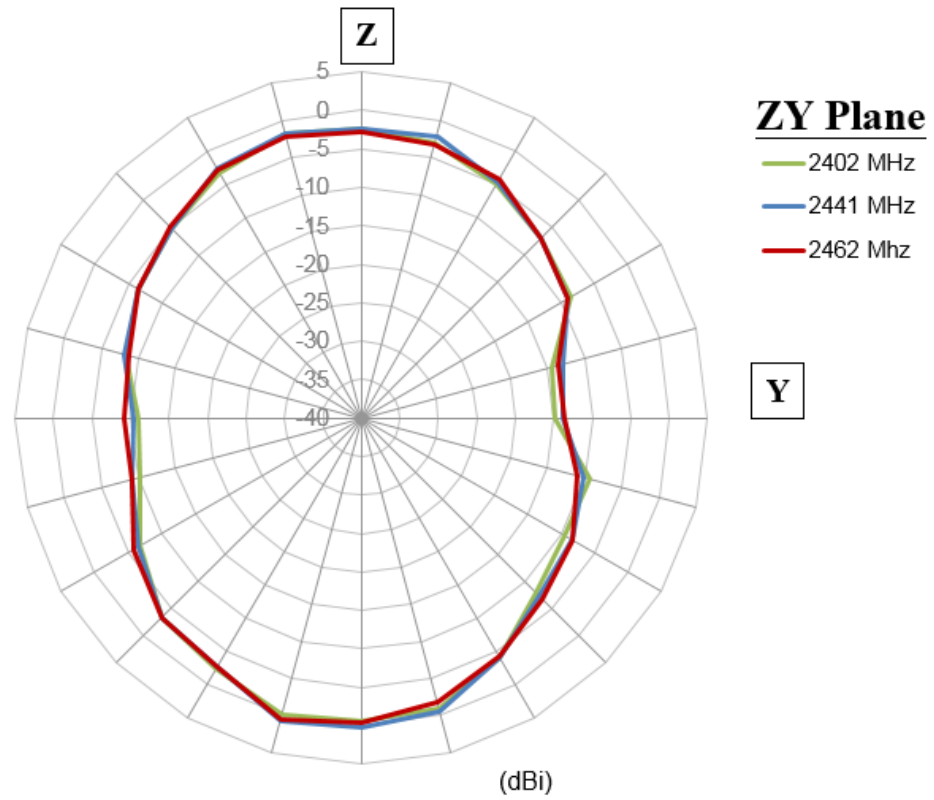




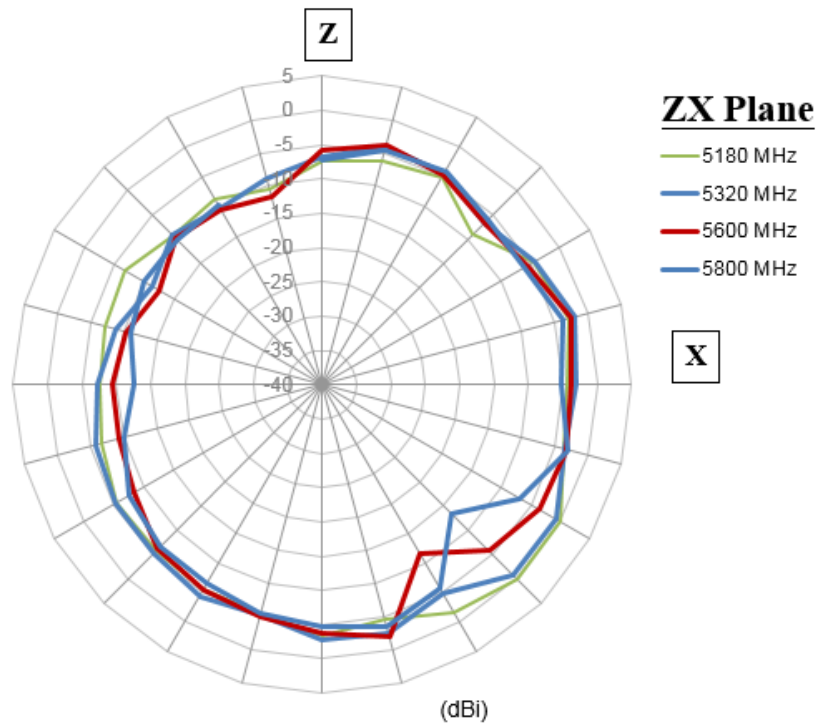
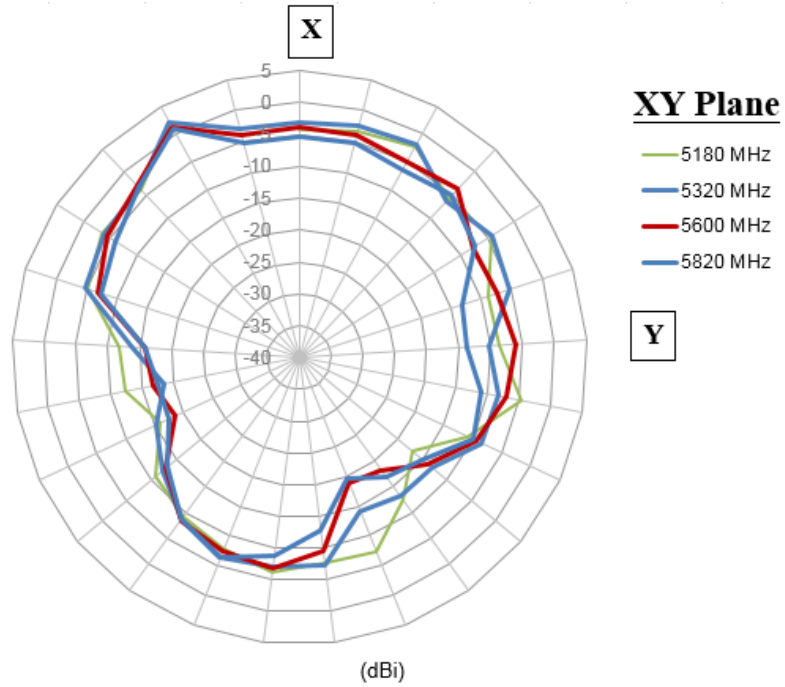
**Y**

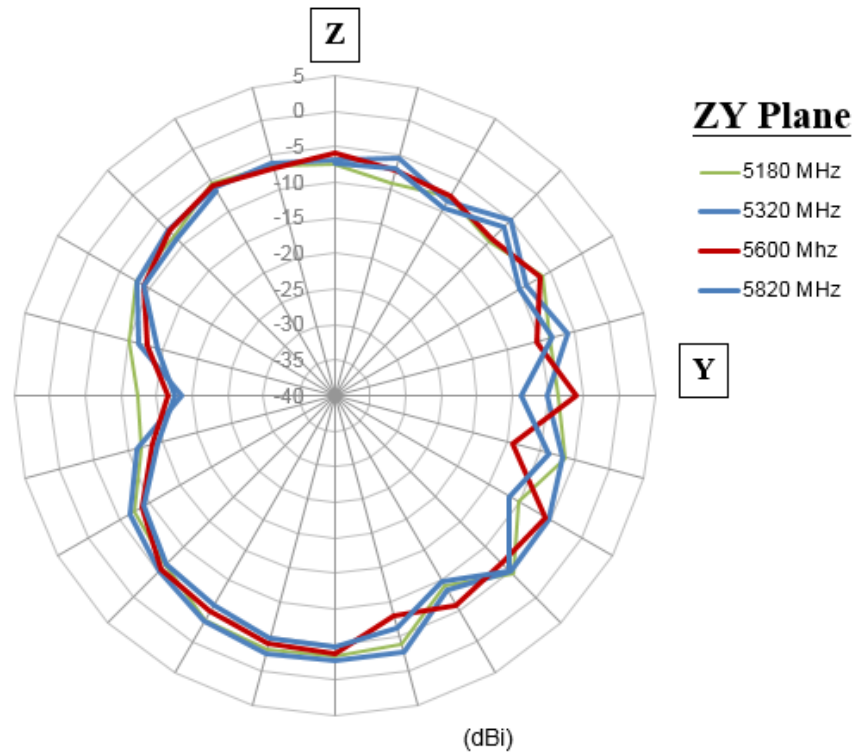


**X**



**Figure 31.** 2D radiation patterns WLAN at 2.4GHz Port 2.





**Figure 32.** 2D radiation patterns WLAN at 5.0GHz Port 2.

## 6 Conclusions

This report presents the antenna characterization of the Harman internal antenna.

### Anex A

#### Basic Definitions of the antenna parameters

##### A.1 Antenna Impedance and Bandwidth

The antenna is essentially a transducer between the characteristic impedance of the radio system (nominally 50 ohms) and the impedance of free space. As such, the antenna impedance and the radio frequencies over which that impedance is maintained are critical. It is essential that the antenna present an acceptable impedance match over the frequency band(s) of operation.

Antenna impedance and the quality of the impedance match are most commonly characterized by either Return Loss (represented by the scattering parameter  $S_{11}$ ) or Voltage Standing Wave Ratio (VSWR); these two parameters are simply different formats of exactly the same impedance data. The Return Loss, is typically measured on a logarithmic (dB) scale, while the VSWR is a unit-less ratio.

These impedance parameters measure how much of the power supplied to the antenna reflects back from the antenna terminals. Ideally, but impossible to achieve if the antenna is perfectly matched to the system, all of the power supplied to the antenna will be radiated with no reflection.

It is important to note that the return loss measured at the antenna terminals is relevant for both receive and transmit operation. In transmit mode, compromised  $S_{11}$  will reflect power back into the final output amplifier, while in receive mode the power is reflected back into the antenna.

**Table A.1.** Return Loss ( $S_{11}$ ) and VSWR Relationship

<b>S11 (dB)</b>	<b>VSWR</b>	<b>Reflection Loss (dB)</b>	<b>Comment</b>
-6.0	3:1	1.2	Marginal
-9.5	2:1	0.5	Acceptable (and typical Antenna Specification)
-15.0	1.4:1	0.15	Good

Test report reference: MUS\_HARMAN\_192210

Some shifting of the frequency response will also occur during normal use when the device is near other objects, a secondary or temporary enclosure, the user's hand or head and so forth. Therefore, excess bandwidth should be designed in from the beginning of the product design.

The bandwidth of an antenna over which the return loss is acceptable is directly proportional to the volume the antenna occupies, so very small antennas can produce inadequate bandwidth, especially in the 700 MHz band where the effective volume is smallest relative to the frequency of operation.

### A.2 Efficiency

The antenna efficiency is arguably the most important performance parameter, assuming the antenna produces an acceptable return loss and Peak Gain over the band of interest.

Efficiency is simply a measure of what portion of the power supplied to the antenna, including any reflection loss, is actually radiated by the antenna.

The efficiency of small antennas that are tightly integrated into a small product can be affected substantially. Nearby grounded conductors and dielectric materials (like a typical plastic housing) will constrain and absorb the near-fields of the antenna and cause significant losses. below illustrates the efficiency concept.

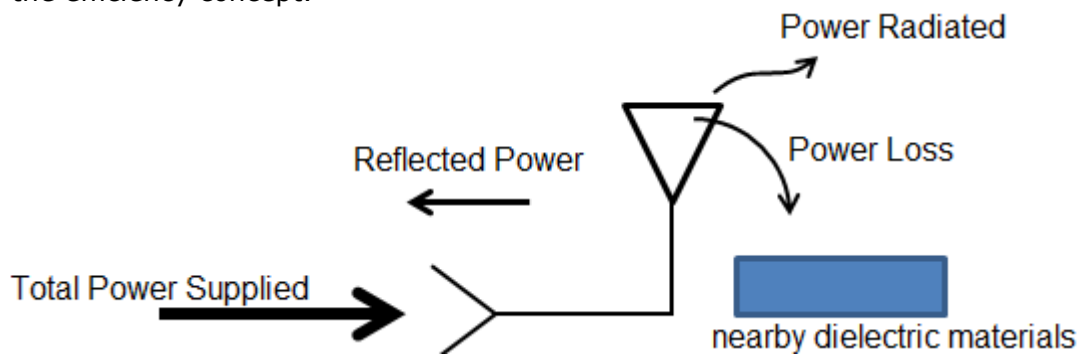


Figure A.1. Efficiency Concept

Common plastic materials, like polycarbonate or ABS (Acrylonitrile Butadiene Styrene), can become significant absorbers of RF energy when very close to an antenna. Energy loss will occur during both receive and transmit operation.

The efficiency of a typical embedded antenna can range from about 40 to 75%. Greater than 75% efficiency is challenging to obtain from a fully embedded antenna and lower than 40% efficiency will typically cause certification failures but this depends on the TRP (Total Radiated Power) and TIS (Total Isotropic Sensitivity) limits from the network provider. In most cases, the efficiency goal should be 60%, with 40% as an absolute minimum.



It is important to understand that good return-loss performance can be inadvertently achieved at the expense of efficiency. An extreme example of this concept is a 50 ohm resistor: the resistor has an excellent return loss but has virtually 0% efficiency, and is obviously not an antenna. Therefore, an understanding of the return loss and efficiency concepts is critical to good antenna design.

### A.3 Average Gain

Efficiency is typically expressed as a percentage, but it is helpful to translate efficiency into the same logarithmic scale used in other antenna performance parameters, when the antenna efficiency is represented in logarithmic scale is named Average Gain. Next table shows the relationship between the Antenna Efficiency in % and the Average Gain in dB

**Table A.2.** Efficiency (%) and Average Gain (dB) Relationship

Efficiency (%)	Average Gain (dB)
90	-0.5
75	-1.2
50	-3.0
25	-6.0

As shown in the table above, antenna efficiency in percentage can be converted to a dB scale (Average Gain) by a  $10 \log (\%)$  function.

### A.4 Peak Gain

Peak Gain is the maximum energy radiated by the antenna in one direction. The peak Gain is usually referred to an isotropic antenna and with the designation dBi.

### A.5 Radiation Patterns

An antenna is a physical device that radiates energy, almost always with some directional dependence. An antenna radiation pattern or antenna pattern is defined as “a mathematical function or a graphical representation of the radiation properties of the antenna as a function of space coordinates. In most cases, the radiation pattern is determined in the far field region. Radiation properties include power flux density, radiation intensity, field strength, directivity, phase or polarization.” The radiation property of most concern is the two- or three-dimensional spatial distribution of radiated energy as a function of the observer’s position along a path or surface of constant radius

An isotropic radiator is defined as “a hypothetical lossless antenna having equal radiation in all directions”.

A directional antenna is one “having the property of radiating or receiving electromagnetic waves more effectively in some directions than in others”.

The omnidirectional antenna has a no directional pattern in a given plane and a directional pattern in any orthogonal plane.” An omnidirectional patterns then special type of a directional pattern”.

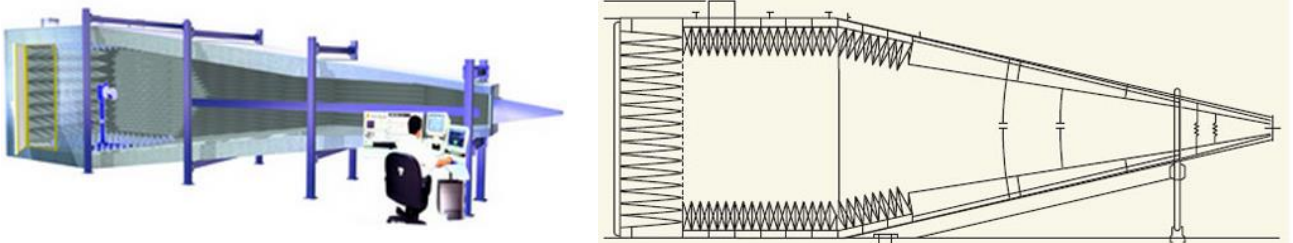
## Anex B

### Anechoic (“No echo”) chambers

A radio frequency “anechoic chamber” is a shielded room whose walls have been covered with a material that scatters or absorbs so much of the incident energy that it can simulate free space. Electromagnetic wave measurements involving very low signal levels are commonly performed in laboratory facilities that provide high isolation from external electromagnetic environment. Shielded enclosures with isolation performance in excess of 100 dB prevent extraneous energy from masking measurements of the intended signals. However, electromagnetic wave generally propagates in all directions and waves reflected by the walls, ceiling, and floor of the shielded enclosure will give rise to a complex wave front at the test region where the test antenna is to be placed. As it is desirable to provide an environment for electromagnetic energy to propagate between the test antenna and the device-under-test (DUT) in a simple and well defined manner, waves propagating towards the walls, ceiling, and floor of the enclosure must be absorbed using a suitable absorbing material. A shielded enclosure with the entire inner surfaces covered with wave absorber to create a non-reflecting environment equivalent to free space is known as Anechoic Chamber.

#### B.1 Kinds of anechoic chambers

##### B.1.1 Tapered Anechoic Chamber

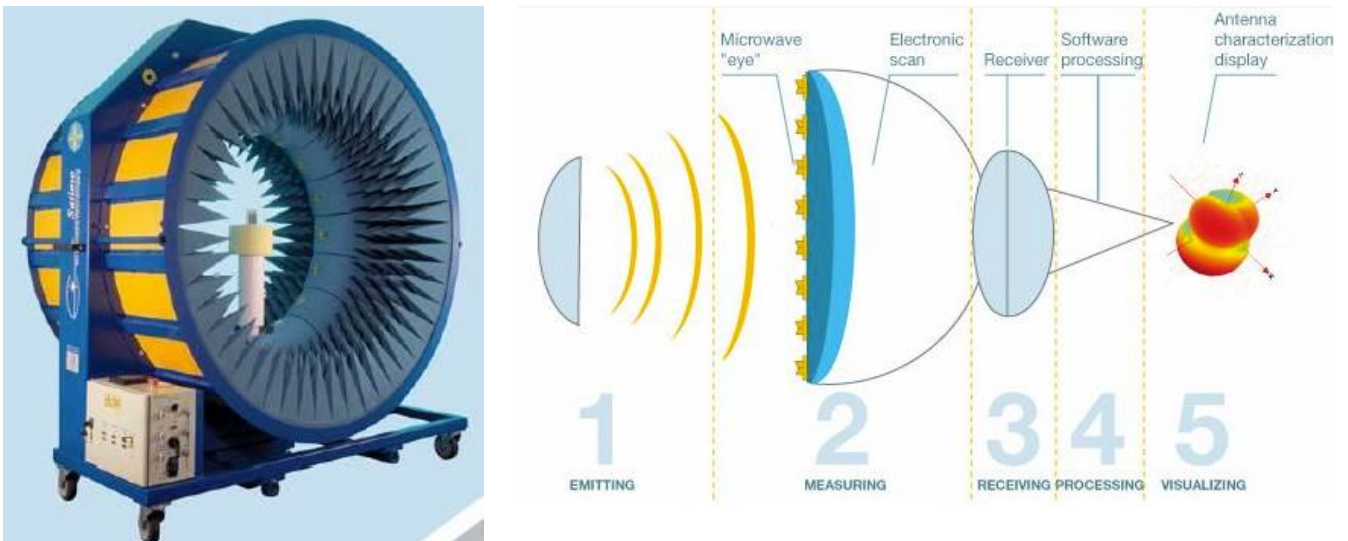


**Figure B.1.** Tapered Anechoic Chamber



- The tapered chamber actually uses the reflections off the walls to its advantage. It was found that suppression of reflections for low frequency broad-beamed antennas was almost impossible.
- Tapering one end of the chamber would cause the chamber to act like an indoor ground reflection range. The reflections off of the chamber walls actually add together to form an almost uniform plane wave at the test region. The shape of this chamber and the wave front emanating from it is reminiscent of horn antenna.
- The cost of a tapered chamber is usually less than a rectangular chamber.
- The tapered chambers are used mostly for low frequencies in the VHF(30-300 MHz) / UHF(300 MHz a 3 GHz) range.

### B.1.2 Near Field Anechoic Chamber

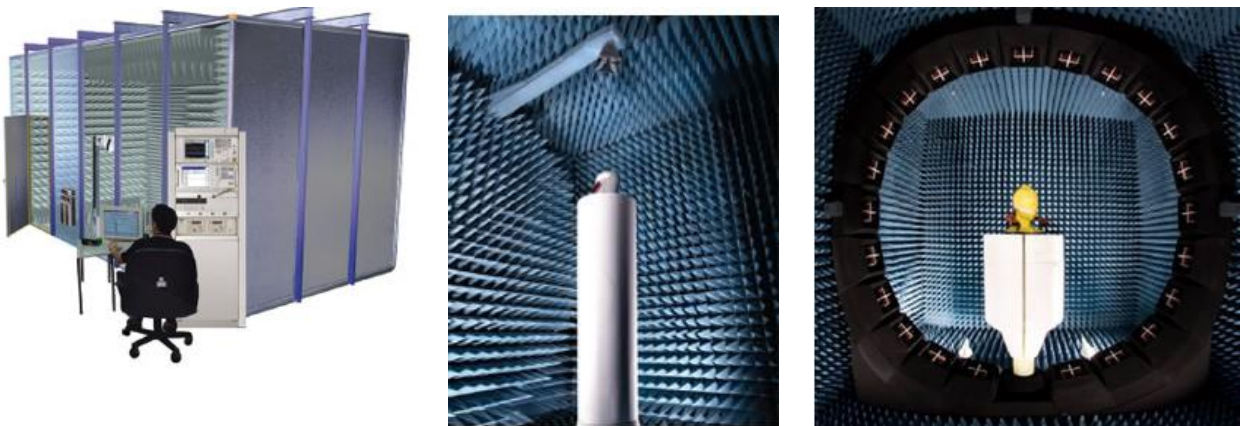


**Figure B.2.** Near Field Anechoic Chamber

- The test antenna is measured in the near-field and a near-field to far-field transform is used to obtain the far-field pattern.
- The disadvantage of this method is that points in different planes are needed to get an accurate far-field calculation.

- Other disadvantage is that this method is very math intensive and requires more equipment to get a complete scan of the antenna.

### B.1.3 Rectangular Chamber



*Figure B.3. Rectangular Anechoic Chamber*

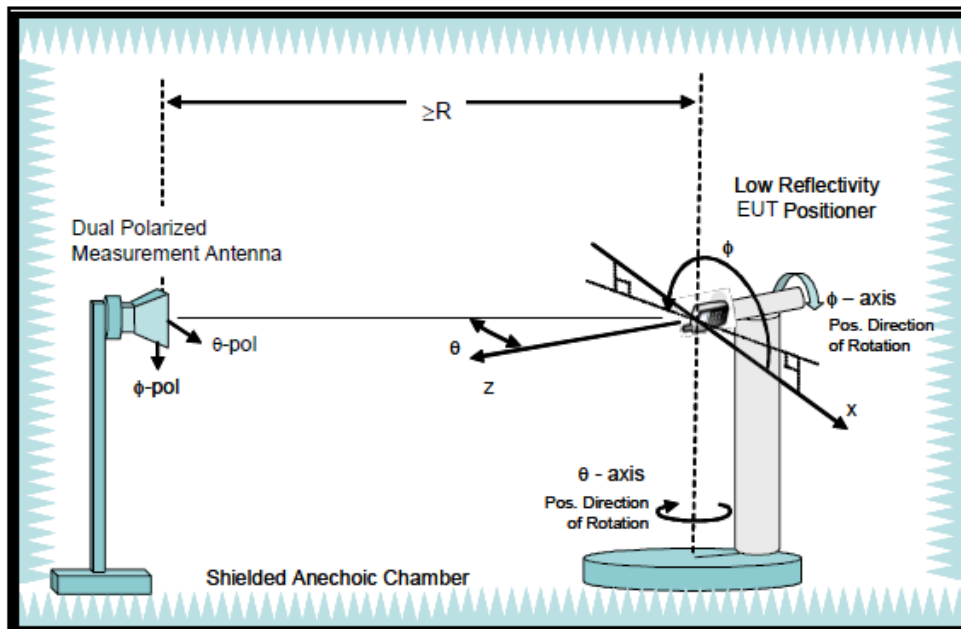
- Most common type of chamber because they are easy to build and easier to design than other types of chambers.
- These chambers range in size depending on what the operating frequency is and also on what is being tested. The major specification is that the chamber must be long enough so that the antennas under test are in the far-field.
- The chamber to be deep enough so that we don't get a skipping affect of the electromagnetic wave off the floor of the chamber.

### B.2 Chamber coordinate systems

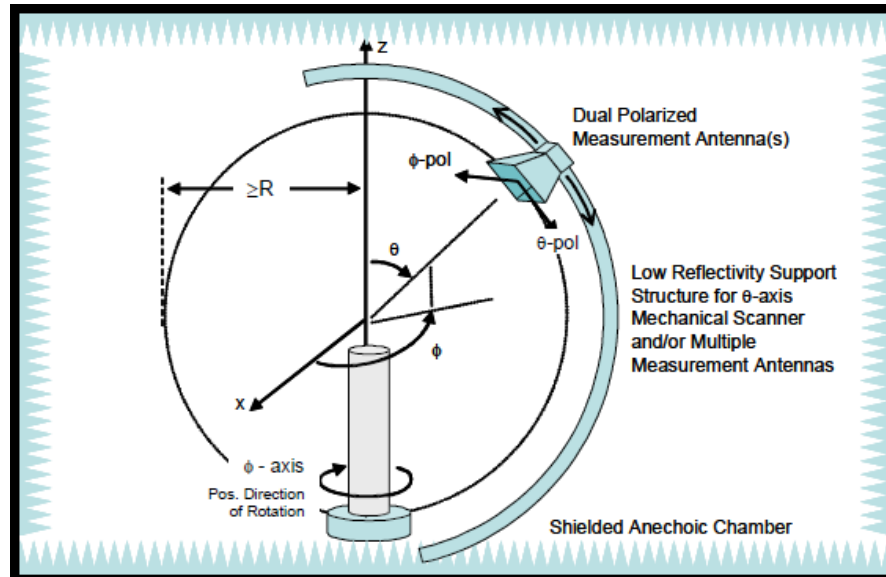
The chambers utilize the spherical measurement system, and can be distributed or combined. Each of the two referenced chamber setups have different coordinate system orientations This is

Test report reference: MUS\_HARMAN\_192210

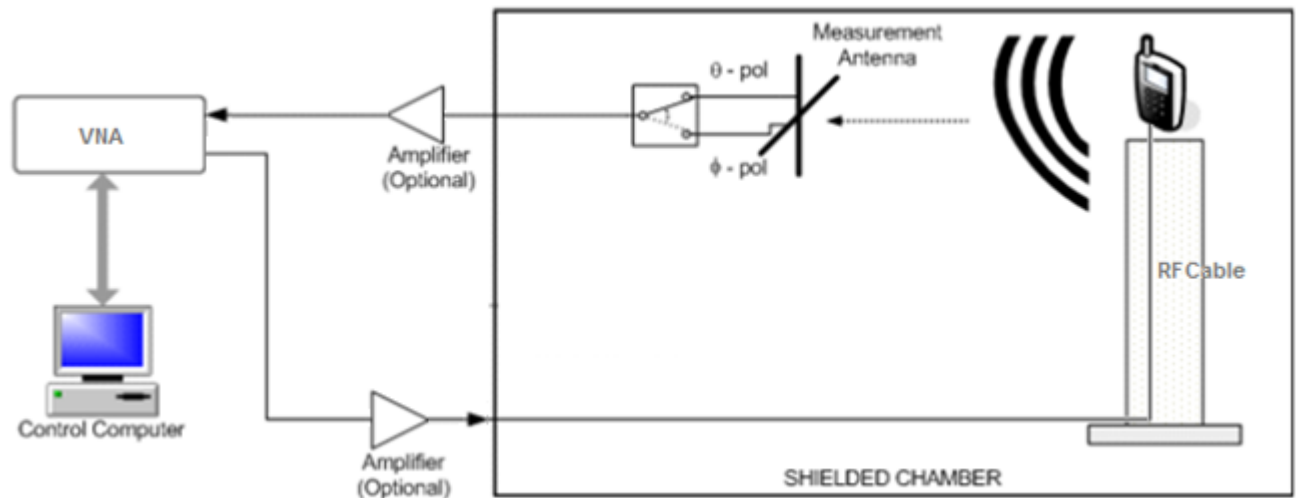
due to the difference in implementation of the chamber axes. However, the EUT coordinate systems will apply independent of the physical orientations of the EUT inside the chamber. Figure B.4 shows the typical setup using a combined axis system. In addition to the pictured Theta axis rotation, the EUT will have to be rotated about the Z-axis (Phi rotation) in order to perform the full spherical scans. Figure B.5 shows the typical setup using the distributed axis system. In this configuration, the Phi and Theta angles are traversed separately by the distributed positioners in the chamber.



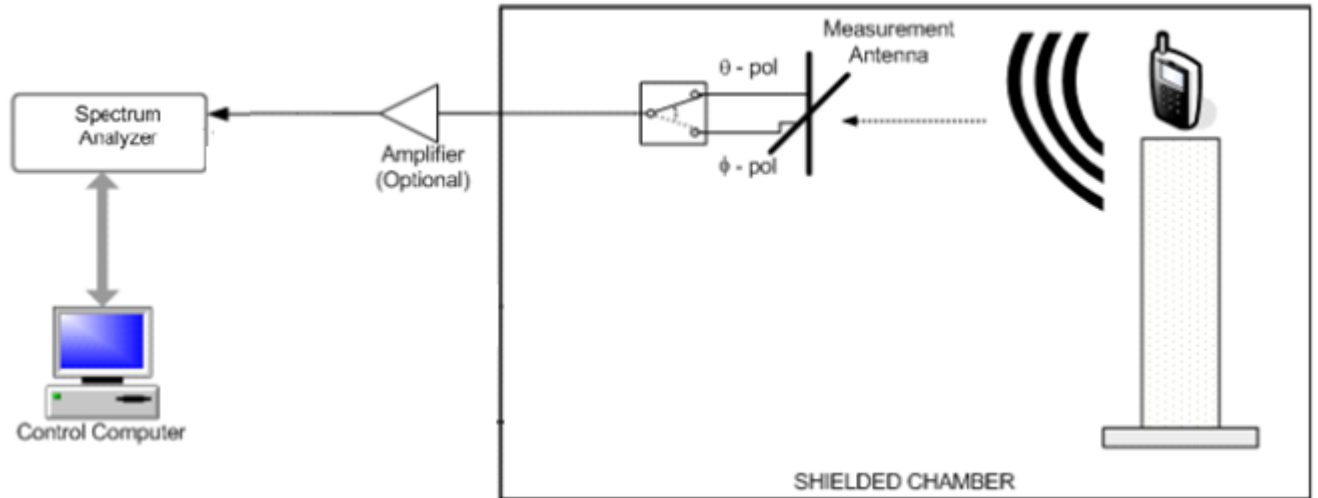
**Figure B.4.** Shows the typical setup using a combined axis system. In addition to the pictured Theta axis rotation, the EUT will have to be rotated about the Z-axis (Phi rotation) in order to perform the full spherical scans.



**Figure B.5.** Shows the typical setup using the distributed axis system. In this configuration, the Phi and Theta angles are traversed separately by the distributed positioners in the chamber.



**Figure B.6.** Simplified block diagram showing the common configuration for the passive antenna measurement



**Figure B.7.** Simplified block diagram showing the common configuration for the TRP, in TX power mode antenna measurement