

FCC Hearing Aid Compatibility (HAC) RF Emission Test Report

Product Name : Smart Phone
Model No. : PH4002

Applicant : Shenzhen Topwell Wireless Communication Co Ltd
Address : 5F, 10Building,Changyuan New Material Port,No.2,Middle Road 1,
High Tech Park, Nanshan District,Shenzhen, China

Date of Receipt : 2016/06/02
Issued Date : 2016/07/25
Report No. : 1660131R-SAUSP01V00
Report Version : V1.0



The test results relate only to the samples tested.
The test results shown in the test report are traceable to the national/international standard through the calibration of the equipment and evaluated measurement uncertainty herein.
This report must not be used to claim product endorsement by TAF or any agency of the government.
The test report shall not be reproduced without the written approval of QuieTek Corporation.

Test Report

Issued Date: 2016/07/25

Report No.:1660131R-SAUSP01V00



Product Name : Smart Phone
 Applicant : Shenzhen Topwell Wireless Communication Co Ltd
 Address : 5F, 10Building,Changyuan New Material Port,No.2,Middle Road
 1, High Tech Park, Nanshan District,Shenzhen, China
 Manufacturer : Shenzhen Topwell Wireless Communication Co Ltd
 Model No. : PH4002
 FCC ID : 2AHDDPCDPH4002
 Applicable Standard : 47CFR § 20.19
 ANSI C63.19 2011
 KDB 285076 D01
 M Category : M3
 Application Type : Certification

Documented By : Anny Chou
 (Senior Adm. Specialist / Anny Chou)

Tested By : Vorana Chen
 (Senior Engineer / Vorana Chen)

Approved By : 
 (Director / Vincent Lin)

TABLE OF CONTENTS

Description	Page
1. General Information.....	4
1.1 EUT Description	4
1.2 Test Environment	5
2. HAC Measurement System	6
2.1 DASYS System Description	6
2.2 HAC Probe	7
2.2.1 HAC E-Field Probe Specification.....	7
2.3 Boundary Detection Unit and Probe Mounting Device	8
2.4 DATA Acquisition Electronics (DAE) and Measurement Server	8
2.5 Robot.....	9
2.6 Light Beam Unit.....	9
2.7 Device Holder	9
2.8 Test Arch Phantom.....	10
3. System Check.....	11
3.1 Dipole Kit.....	11
3.2 System Check.....	12
3.3 System Check Results	12
4. Measurement Description	13
4.1 RF Emission Measurements Reference and Plane.....	13
4.2 Near-Field Emission Automated Test Flowchart.....	14
4.3 Test Procedure Description	15
4.4 Modulation interference factor.....	16
5. HAC RF Emission Limits.....	18
6. Test Equipment List.....	19
7. Measurement Uncertainty.....	20
8. Test Results	21
8.1 HAC RF Emission Test Results Summary.....	21
Appendix.....	22
Appendix A. HAC System Check Data	
Appendix B. HAC RF Emission Measurement Data	
Appendix C. Test Setup Photographs & EUT Photographs	
Appendix D. HAC Probe Calibration Data	
Appendix E. HAC Dipole Calibration Data	

1. General Information

1.1 EUT Description

Product Name	Smart Phone
Model No.	PH4002
FCC ID	2AHDDPCDPH4002
TX Frequency	GSM 850: 824.2 MHz ~ 848.8 MHz PCS 1900: 1850.2 MHz ~ 1909.8MHz WCDMA Band 2: 1852.4 MHz ~ 1907.6 MHz WCDMA Band 4: 1712.4 MHz ~ 1752.6 MHz WCDMA Band 5: 826.4 MHz ~846.6 MHz
RX Frequency	GSM 850: 869.2 MHz ~ 893.8 MHz PCS 1900: 1930.2 MHz ~ 1989.8 MHz WCDMA Band 2: 1932.4 MHz ~ 1987.6 MHz WCDMA Band 4: 2112.4 MHz ~ 2152.6 MHz WCDMA Band 5: 871.4 MHz ~ 891.6 MHz
Device Category	Portable
RF Exposure Environment	Uncontrolled
Max. Output Power (Conducted)	GSM 850: 32.27dBm; PCS 1900: 29.03dBm WCDMA Band II: 21.42dBm; WCDMA Band IV: 18.8dBm WCDMA Band V: 22.08dBm

Note: Air interface as below

Air interface	frequency	Type	C63.19	Simultaneous	VoIP	VoLTE	Additional GSM power Reduction
GSM	850	VO	Yes (2011)	WLAN/BT	N/A	N/A	N/A
GSM	1900	VO	Yes (2011)	WLAN/BT	N/A	N/A	N/A
GPRS/EDGE	850/1900	DT	NO	WLAN/BT	Yes	N/A	N/A
WCDMA	850 (Band V)	VO	Yes (2011) ¹	WLAN/BT	N/A	N/A	N/A
WCDMA	1700 (Band IV)	VO	Yes (2011) ¹	WLAN/BT	N/A	N/A	N/A
WCDMA	1900 (Band II)	VO	Yes (2011) ¹	WLAN/BT	N/A	N/A	N/A
HSPA	850/1700/1900	DT	NO	WLAN/BT	Yes	N/A	N/A
BT	2.4G	DT	NO	WWAN	N/A	N/A	N/A
WLAN	2.4G	DT	NO	WWAN	Yes	N/A	N/A

Type:
VO – CMRS Voice Service
DT – Digital Transport
VD – CMRS IP Voice Service and Digital Transport

Note:
1. Evaluated for MIF and low-power exemption.

1.2 Test Environment

Ambient conditions in the laboratory:

Items	Required	Actual
Temperature (°C)	18-25	22.4± 2
Humidity (%RH)	30-70	54

Site Description:

Accredited by TAF
Accredited Number: 3023
Effective through: December 12, 2017

Site Name: Quietek Corporation

Site Address: No.5-22, Ruishukeng, Linkou Dist.,
New Taipei City 24451,
Taiwan. R.O.C.
TEL: 886-2-8601-3788 / FAX: 886-2-8601-3789
E-Mail: service@quietek.com

2. HAC Measurement System

2.1 DASY5 System Description

The purpose of the Hearing Aid Compatibility extension is to enable measurements of the near electric and magnetic fields generated by wireless communication devices in the region controlled for use by a hearing aid in accordance with ANSI C63.19-2011 and magnetic fields of a wireless device are scanned with free-space probes (e.g., ER3DVX) in a 5 by 5 cm area parallel above the acoustic point. The scanning distance from the device surface depends on the standard version (for ANSI C63.19-2011 15mm from the probe sensor center). The maximum field values in 9 sub-grids of the electrical and a magnetic field scan are evaluated automatically according to the rules defined in the standard and result in a specific “M-class”.

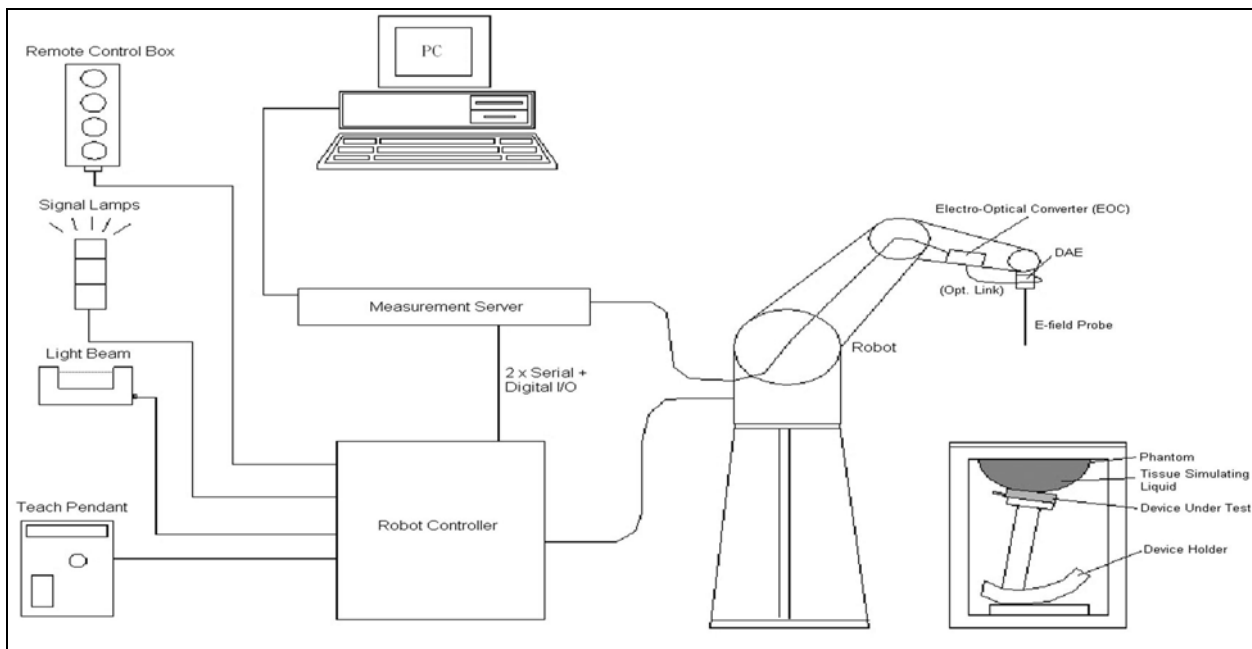

The DASY5 system for performing compliance tests consists of the following items:

- A standard high precision 6-axis robot with controller, teach pendant and software. An arm extension for accommodating the data acquisition electronics (DAE).
- A data acquisition electronics (DAE) which performs the signal amplification, signal multiplexing, AD-conversion, offset measurements, mechanical surface detection, collision detection, etc. The unit is battery powered with standard or rechargeable batteries. The signal is optically transmitted to the EOC.

- The Electro-optical converter (EOC) performs the conversion from optical to electrical signals for the digital communication to the DAE. To use optical surface detection, a special version of the EOC is required. The EOC signal is transmitted to the measurement server.
- The Light Beam used is for probe alignment. This improves the (absolute) accuracy of the probe positioning.
- A computer running WinXP and the DASY5 software.
- Remote control and teach pendant as well as additional circuitry for robot safety such as warning lamps, etc.
- The Arch phantom, the device holder and other accessories according to the targeted measurement.

2.2 HAC Probe

The E-field free space probe (ER3DV6) needs to be calibrated for the respective signal such that the true time-average RMS value is obtained independent of the field strength. The calibration data are in Appendix D.

2.2.1 HAC E-Field Probe Specification

Model	ER3DV6	
Construction	One dipole parallel, two dipoles normal to probe axis Built-in shielding against static charges	
Frequency	100MHz to 6GHz; Linearity: $\pm 0.2\text{dB}$ (100MHz to 3GHz)	
Directivity	$\pm 0.2\text{dB}$ in air (rotation around probe axis) $\pm 0.4\text{dB}$ in air (rotation normal to probe axis)	
Dynamic Range	2V/m to 1000V/m (M3 or better device readings fall well below diode compression point) Linearity: $\pm 0.2\text{dB}$	
Dimensions	Overall length: 330mm (Tip: 16mm) Tip diameter: 8mm (Body: 12mm) Distance from probe tip to dipole centers: 2.5mm	

2.3 Boundary Detection Unit and Probe Mounting Device

The DASY probes use a precise connector and an additional holder for the probe, consisting of a plastic tube and a flexible silicon ring to center the probe. The connector at the DAE is flexibly mounted and held in the default position with magnets and springs. Two switching systems in the connector mount detect frontal and lateral probe collisions and trigger the necessary software response.



2.4 DATA Acquisition Electronics (DAE) and Measurement Server

The data acquisition electronics (DAE) consists of a highly sensitive electrometer-grade preamplifier with auto-zeroing, a channel and gain-switching multiplexer, a fast 16 bit AD-converter and a command decoder and control logic unit. Transmission to the measurement server is accomplished through an optical downlink for data and status information as well as an optical uplink for commands and the clock.

The input impedance of the DAE4 is 200M Ohm; the inputs are symmetrical and floating. Common mode rejection is above 80dB.



The DASY5 measurement server is based on a PC/104 CPU board with a 400MHz intel ULV Celeron, 128MB chipdisk and 128MB RAM. The necessary circuits for communication with the DAE electronics box, as well as the 16 bit AD converter system for optical detection and digital I/O interface are contained on the DASY5 I/O board, which is directly connected to the PC/104 bus of the CPU board.



2.5 Robot

The DASY5 system uses the high precision robots TX60L type out of the newer series from Stäubli SA (France). For the 6-axis controller DASY5 system, the CS8C robot controller version from Stäubli is used.

The XL robot series have many features that are important for our application:

- High precision (repeatability 0.02 mm)
- High reliability (industrial design)
- Jerk-free straight movements
- Low ELF interference (the closed metallic construction shields against motor control fields)
- 6-axis controller



2.6 Light Beam Unit

The light beam switch allows automatic "tooling" of the probe. During the process, the actual position of the probe tip with respect to the robot arm is measured, as well as the probe length and the horizontal probe offset. The software then corrects all movements, such that the robot coordinates are valid for the probe tip.

The repeatability of this process is better than 0.1 mm. If a position has been taught with an aligned probe, the same position will be reached with another aligned probe within 0.1 mm, even if the other probe has different dimensions. During probe rotations, the probe tip will keep its actual position.



2.7 Device Holder

The HAC device holder is made from SPEAG. The holder supports accurate and reliable positioning of any phone effect on near field ± 0.5 dB. It is used to adjust DUT to suitable position.

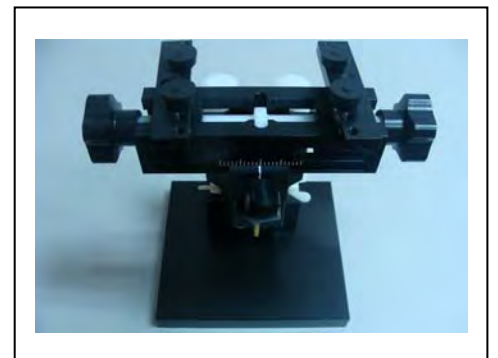

2.8 Test Arch Phantom

The HAC Test Arch phantom is used with several sections, each considering the different vertical distances of the DUT or the dipole as well as the different sensor offsets of the E- and H-Field probes. The Test Arch phantom V4.8 includes a single predefined RF phantom section (V4.9 also a TCoil section).

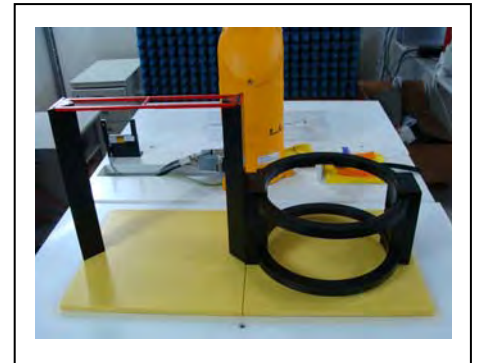

Model	Arch Phantom V 4.9
Dimensions	370 x 370 x 370mm

2.9 Audio Interference Analyzer (AIA)

The Audio Interference Analyzer measures the Modulation Interference Factor (MIF) and the Probe Modulation Factor (PMF) of modulated radiofrequency (RF) signals as required to meet the new hearing-aid-compatibility (HAC) standard. It is also perfectly suited for establishing the connection between base-station emulator and the device under test (DUT). It is compact, i.e., it fits on any emulator, and covers the entire mobile frequency band .



3. System Check

3.1 Dipole Kit

Model	CD835V3	
Frequency Band	800 ~ 960MHz (free space)	
Return Loss	> 15dB	
Calibration	835MHz (Appendix E)	
Power Capability	50W continuous	
Dimensions	Length: 166mm Height: 330mm	

Model	CD1880V3	
Frequency Band	1710 ~ 2000MHz (free space)	
Return Loss	> 18dB	
Calibration	1880MHz (Appendix E)	
Power Capability	50W continuous	
Dimensions	Length: 80.8mm Height: 330mm	

Model	CD2450V3	
Frequency Band	2250 ~ 2650MHz (free space)	
Return Loss	> 18dB	
Calibration	2450MHz (Appendix E)	
Power Capability	50W continuous	
Dimensions	Length: 59.9mm Height: 330mm	

3.2 System Check

The manufacturer calibrates the probes annually. The HAC measurements of the device were done within 24 hours of system accuracy verification, which was done using calibration dipoles. Unmodulated continuous wave of power level of 20dBm was supplied to a dipole antenna placed under Test Arch. The measurement probes are positioned over the illuminated dipole at 15mm distance from the top surface of the dipole element to the calibration reference point of the sensor, defined by the probe manufacturer.

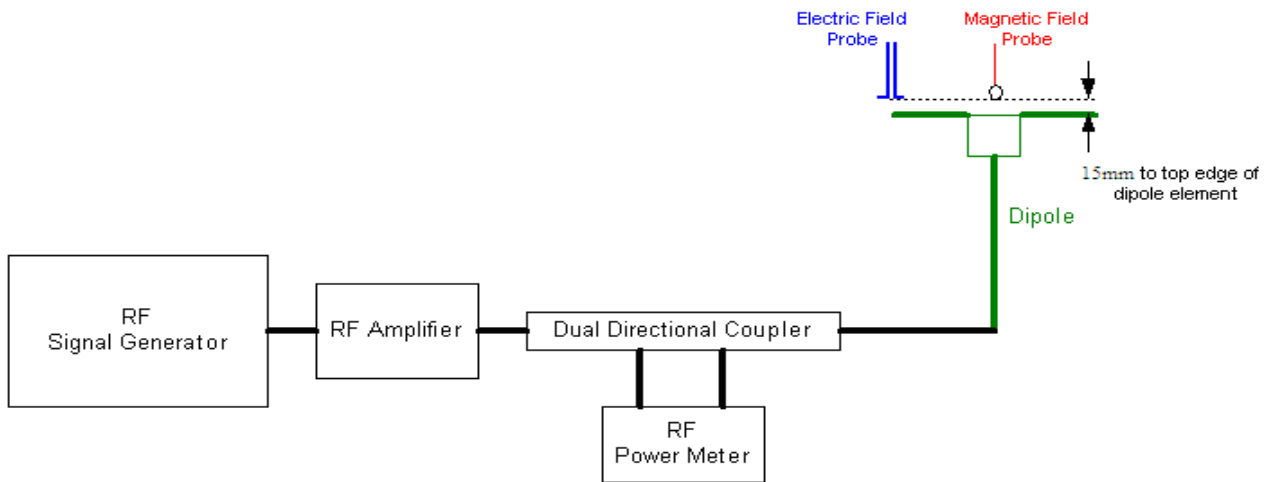

3.3 System Check Results

HAC System Check						
Frequency [MHz]	Input Power (dBm)	Target E-Field (V/m)	Measured E-Field (V/m)		Deviation (%)	Date
			E-Field 1	E-Field 2		
835	20	105.8	103.9	94.12	-6.4	2016/06/22
1880	20	89.1	87.44	85.71	-2.8	2016/06/22

- The measured values were compared with the values provided by the probe manufacturer and must within the allowed tolerance of 25%
- The deviation is $((E\text{-Field 1} + E\text{-Field 2})/2 - \text{Target E-Field}) / \text{Target E-Field} * 100\%$

4. Measurement Description

4.1 RF Emission Measurements Reference and Plane

The figure as below illustrates the references and reference plane that shall be used in the EUT emissions measurement:

- The grid is 5 cm by 5 cm area that is divided into 9 evenly sized blocks or sub-grids.
- The grid is centered on the audio frequency output transducer (speaker) of the EUT.
- The grid is in a reference plane, which is defined as the planar area that contains the highest point in the area of the phone that normally rests against the user's ear. It is parallel to the centerline of the receiver of the EUT and is defined by the points of the receiver-end of the EUT, which, in normal handset use, rest against the ear.
- The measurement plane is parallel to, and 1.5 cm in front of, the reference plane.

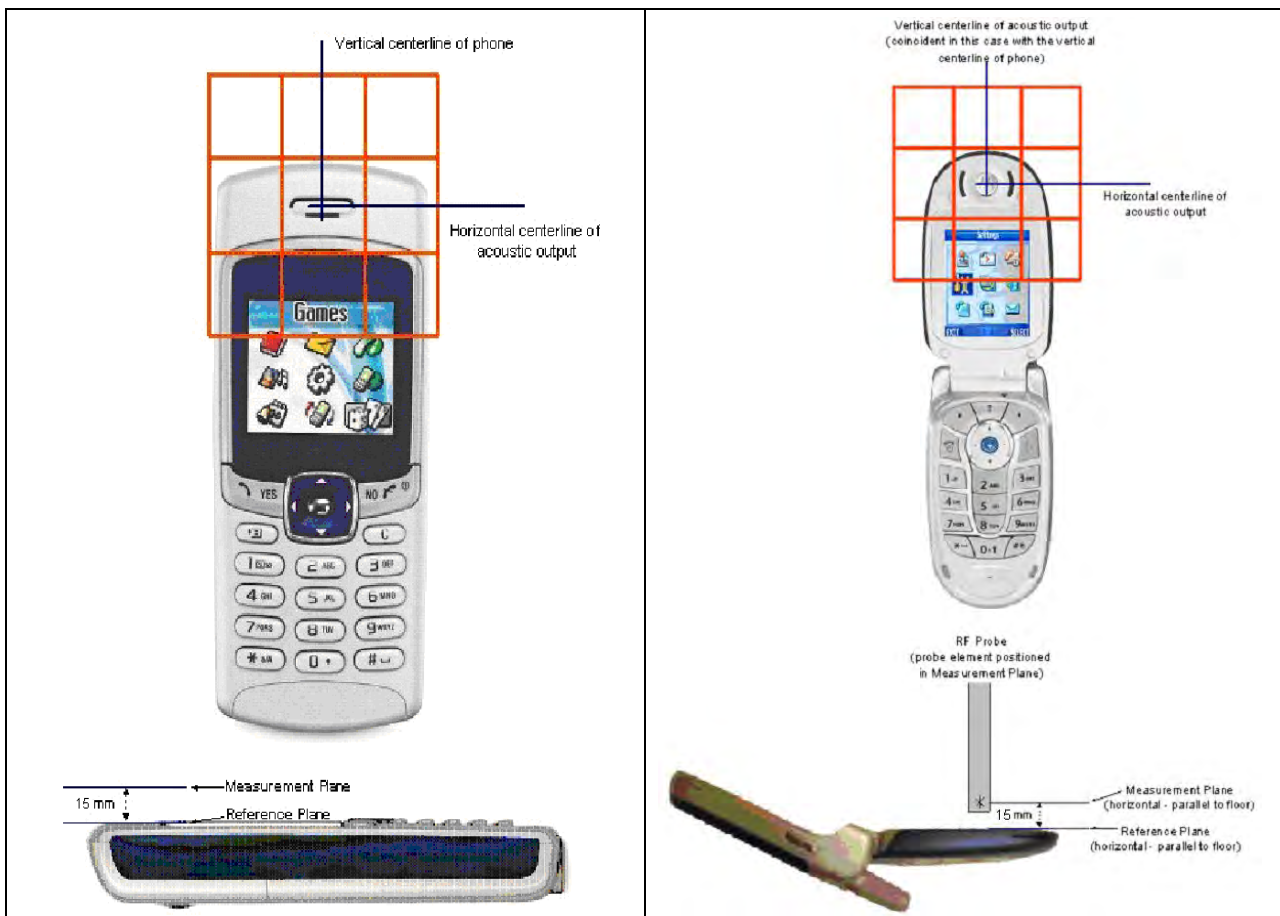

4.2 Near-Field Emission Automated Test Flowchart

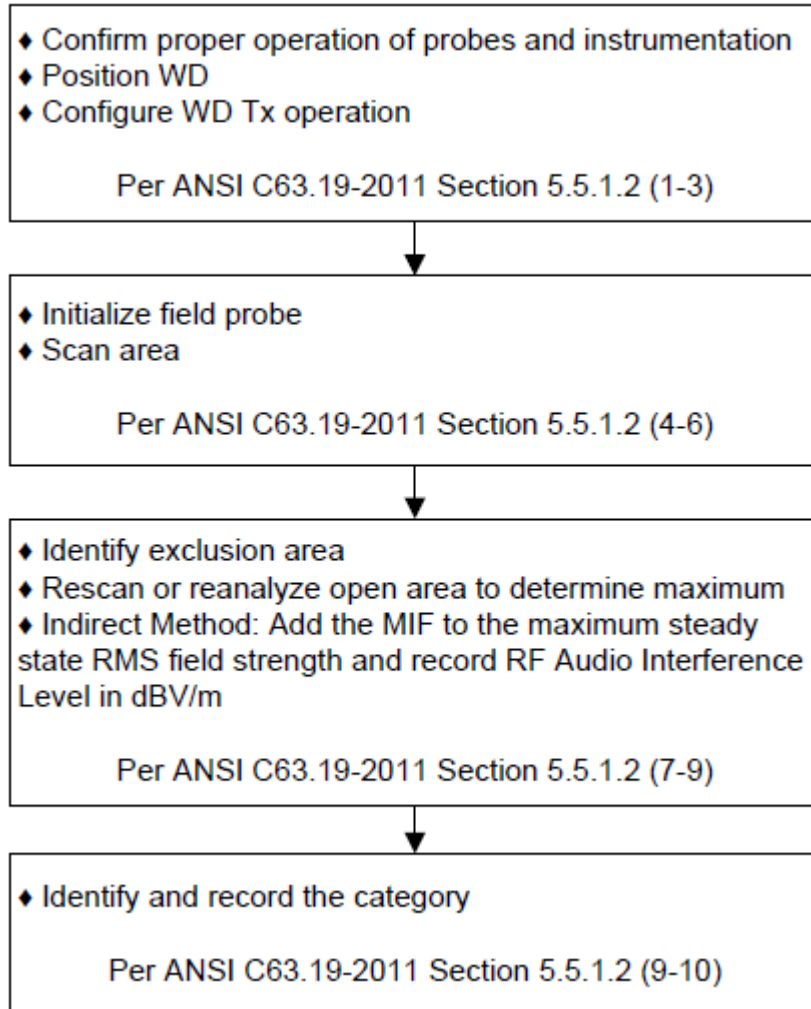

4.3 Test Procedure Description

The following illustrate a typical RF emission test scan over a wireless communication device:

1. Proper operation of the field probe, probe measurement system, other instrumentation, and the positioning system was confirmed.
2. Position the WD in its intended test position, acoustic output point of the device perpendicular to the field probe.
3. The WD operation for maximum rated RF output power was configured and confirmed with the base station simulator, at the test channel and other normal operating parameters as intended for the test. Ensure battery is fully charged before each test.
4. The center sub-grid was centered over the center of the acoustic output (also audio band magnetic output, if applicable). The WD audio output was positioned tangent (as physically possible) to the measurement plane.
5. A surface calibration was performed before each setup change to ensure repeatable spacing and proper maintenance of the measurement plane using the HAC arch.
6. The measurement system measured the field strength at the reference location.
7. Measurements at 2mm or 5mm increments in the 5x 5cm region were performed at a distance 15 mm from the center point of the probe measurement element to the WD. A 360° rotation about the azimuth axis at the maximum interpolated position was measured. For the worst-case condition, the peak reading from this rotation was used in re-evaluating the HAC category.
8. The system performed a drift evaluation by measuring the field at the reference location.

4.4 Modulation interference factor

For any specific fixed and repeatable modulated signal, a modulation interference factor (MIF, expressed in dB) may be developed that relates its interference potential to its steady-state rms signal level or average power level. This factor is a function only of the audio-frequency amplitude modulation characteristics of the signal and is the same for field-strength and conducted power measurements. It is important to emphasize that the MIF is valid only for a specific repeatable audio-frequency amplitude modulation characteristic. Any change in modulation characteristic requires determination and application of a new MIF.

The MIF may be determined using a radiated RF field, a conducted RF signal, or in a preliminary stage, a mathematical analysis of a modeled RF signal:

- a) Using RF illumination or conducted coupling, apply the specific modulated signal in question to the measurement system at a level within its confirmed operating dynamic range.
- b) Measure the steady-state rms level at the output of the fast probe or sensor.
- d) Measure the steady-state average level at the weighting output.
- e) Without changing the square-law detector or weighting system, and using RF illumination or conducted coupling, substitute for the specific modulated signal a 1 kHz, 80% amplitude modulated carrier at the same frequency and adjust its strength until the level at the weighting output equals the step d) measurement.
- f) Without changing the carrier level from step e), remove the 1 kHz modulation and again measure the steady-state rms level indicated at the output of the fast probe or sensor.
- g) The MIF for the specific modulation characteristic is provided by the ratio of the step f) measurement to the step c) measurement, expressed in dB ($20 \times \log(\text{step f})/\text{step c}$)).

The following procedure was used to measure the MIF using SPEAG Audio Interference Analyzer(AIA)

- Couple the RF signal to be evaluated to an Audio Interference Analyzer (AIA). Set the coupling factor (RF attenuation).
- Connect the AIA via USB to the DASY5 PC.
- Generate and run a MIF measurement job with a reference signal. Adjust the configuration of the AIA (MIF scaling based on an 80% AM 1 kHz sine signal) for correct reference reading.
- Generate and run a MIF measurement job for the unknown signal.
- The device was placed into a simulated call using a base station simulator or set to transmit using test software for a given mode.
- Set to continuously transmit a maximum power.
- Using a coupler if needed, the device output signal was connected to the RF in port of the AIA, which was connected to as desktop computer. Alternatively a radiated RF signal may be used with the AIA's built-in antenna
- The MIF measurement procedure in the DASY software was run, and the resulting MIF Value was recorded.

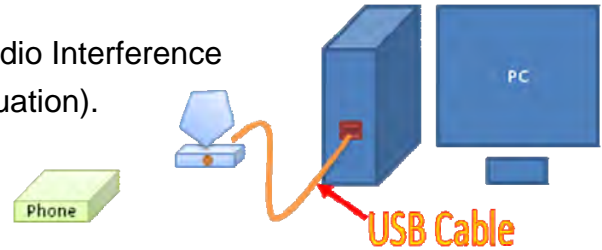

Mode	GSM850			GSM1900		
Channel	128	190	251	512	661	810
GSM	3.48	3.47	3.40	3.50	3.60	3.01

Mode	UMTS II			UMTS IV			UMTS V			
UMTS	Channel	9262	9400	9538	1312	1412	1513	4132	4183	4233
	RMC	-24.01	-22.72	-22.56	-23.03	-22.63	-22.83	-19.52	-17.00	-21.33
	AMR	-14.21	-14.19	-14.19	-14.17	-14.40	-14.42	-14.42	-13.79	-14.01

Low Power Exemption

Mode	Maximum Power(dBm)	Maximum MIF	Power + MIF	C63.19
GSM 850	32.27	3.48	35.75	Yes
GSM 1900	29.03	3.60	32.63	Yes
UMTS II	21.42	-14.19	7.23	No
UMTS IV	18.80	-14.17	4.63	No
UMTS V	22.08	-13.79	8.29	No

Note: According to ANSI C63.19 2011-version. An RF air interface technology of a device is exempt from testing when it's a average antenna input power plus its MIF is ≤ 17 dBm for any of its operating mods.

5. HAC RF Emission Limits

The ANSI Standard presents performance requirements for acceptable interoperability of hearing aids with wireless communications devices. When these parameters are met, a hearing aid operates acceptably in close proximity to a wireless communications device.

TELEPHONE RF PARAMETERS < 960MHz	
CATEGORY NEAR FIELD	E-FIELD EMISSION CW
	(dBV/m)
M1	50.0 to 66.0
M2	45.0 to 50.0
M3	40.0 to 45
M4	< 40
TELEPHONE RF PARAMETERS >960MHz	
M1	40.0 to 45.0
M2	35.0 to 40.0
M3	30.0 to 35.0
M4	< 30.0

6. Test Equipment List

Instrument	Manufacturer	Model No.	Serial No.	Last Calibration	Next Calibration
Stäubli Robot TX60L	Stäubli	TX60L	F09/5BL1A1/A06	2009/05/18	only once
Controller	Speaq	CS8c	N/A	2009/05/18	only once
Test Arch Phantom	Speaq	SD HAC P01 BB	1118	N/A	N/A
Speaq Reference Dipole 835MHz	Speaq	CD835V3	1135	2015/05/26	2017/05/24
Speaq Reference Dipole 1900MHz	Speaq	CD1880V3	1117	2015/05/26	2017/05/24
SAM Twin Phantom	Speaq	QD000 P40 CA	Tp 1515	N/A	N/A
Device Holder	Speaq	N/A	N/A	N/A	N/A
Data Acquisition Electronic	Speaq	DAE4	1207	2015/11/20	2016/11/19
E-Field Probe	Speaq	ER3DV6	2466	2016/05/27	2017/05/26
SAR Software	Speaq	DASY52	Version 52.8 (8)	N/A	N/A
Aprél Dipole Spaccer	Aprél	ALS-DS-U	QTK-295	N/A	N/A
Power Amplifier	Mini-Circuit	ZHL-42	D051404-20	N/A	N/A
Directional Coupler	Agilent	778D-012	50550	N/A	N/A
Universal Radio Communication Tester	R&S	CMU200	104846	2016/07/07	2017/07/06
Vector Network	Agilent	E5071C	MY46108013	2015/12/02	2016/11/30
Signal Generator	Anritsu	MG3694A	041902	2015/08/14	2016/08/12
Power Meter	Anritsu	ML2487A	6K00001447	2015/09/17	2016/09/15
Wide Bandwidth Sensor	Anritsu	MA2411B	1339194	2015/09/17	2016/09/15

7. Measurement Uncertainty

HAC Uncertainty Budget							
According to ANSI C63.19							
Error Description	Uncert. value	Prob. Dist.	Div.	(ci) E	(ci) H	Std. Unc. E	Std. Unc. H
Measurement System							
Probe Calibration	±5.1%	N	1	1	1	±5.1%	±5.1%
Axial Isotropy	±4.7%	R	$\sqrt{3}$	1	1	±2.7%	±2.7%
Sensor Displacement	±16.5%	R	$\sqrt{3}$	1	0.145	±9.5%	±1.4%
Boundary Effects	±2.4%	R	$\sqrt{3}$	1	1	±1.4%	±1.4%
Phantom Boundary Effect	±7.2%	R	$\sqrt{3}$	1	0	±4.1%	±0.0%
Linearity	±4.7%	R	$\sqrt{3}$	1	1	±2.7%	±2.7%
Modulation Interference Factor	±10.0%	R	$\sqrt{3}$	1	1	±5.8%	±5.8%
System Detection Limit	±1.0%	R	$\sqrt{3}$	1	1	±0.6%	±0.6%
Readout Electronics	±0.3%	N	$\sqrt{3}$	1	1	±0.3%	±0.3%
Response Time	±0.8%	R	$\sqrt{3}$	1	1	±0.5%	±0.5%
Integration Time	±2.6%	R	$\sqrt{3}$	1	1	±1.5%	±1.5%
RF Ambient Conditions	±3.0%	R	$\sqrt{3}$	1	1	±1.7%	±1.7%
RF Reflections	±12.0%	R	$\sqrt{3}$	1	1	±6.9%	±6.9%
Probe Positioner	±1.2%	R	$\sqrt{3}$	1	0.67	±0.7%	±0.5%
Probe Positioning	±4.7%	R	$\sqrt{3}$	1	0.67	±2.7%	±1.8%
Extrap. and Interpolation	±1.0%	R	$\sqrt{3}$	1	1	±0.6%	±0.6%
Test Sample Related							
Device Positioning Vertical	±4.7%	R	$\sqrt{3}$	1	0.67	±2.7%	±1.8%
Device Positioning Lateral	±1.0%	R	$\sqrt{3}$	1	1	±0.6%	±0.6%
Device Holder and Phantom	±2.4%	R	$\sqrt{3}$	1	1	±1.4%	±1.4%
Power Drift	±5.0%	R	$\sqrt{3}$	1	1	±2.9%	±2.9%
Phantom and Setup Related							
Phantom Thickness	±2.4%	R	$\sqrt{3}$	1	0.67	±1.4%	±0.9%
Combined Std. Uncertainty						±16.3%	±12.3%
Expanded Std. Uncertainty on Power						±32.6%	±24.6%
Expanded Std. Uncertainty on Field						±16.3%	±12.3%

8. Test Results

8.1 HAC RF Emission Test Results Summary

HAC Measurement						
Product: Smart phone						
Test Mode: E-Field						
Test Band	Antenna Position	Frequency		Conducted Power (dBm)	Peak E-Field(dBV/m)	Rating
		Channel	MHz			
850	Fixed	128	824.2	32.32	38.15	M4
	Fixed	190	836.6	32.27	38.05	M4
	Fixed	251	848.8	32.15	37.67	M4
1900	Fixed	512	1850.2	29.03	31.77	M3
	Fixed	661	1880	29.02	31.65	M3
	Fixed	810	1909.8	28.96	30.52	M3

Appendix

Appendix A. HAC System Check Data

Appendix B. HAC RF Emission Measurement Data

Appendix C. Test Setup Photographs & EUT Photographs

Appendix D. HAC Probe Calibration Data

Appendix E. HAC Dipole Calibration Data

Appendix A. HAC System Check Data

Test Laboratory: QuieTek-a DEKRA

Date/Time: 2016/06/22

HAC Correction 850

DUT: HAC Dipole 835MHz; Type: CD835V3

Communication System: UID 0, CW; Frequency: 835 MHz;

Communication System PAR: 0 dB

Medium parameters used: $\sigma = 0$ S/m, $\epsilon_r = 1$; $\rho = 1000$ kg/m³

Phantom section: RF Section

Ambient Temperature (°C) : 22.4, Humidity (%RH) : 54

Measurement Standard: DASYS (IEEE/IEC/ANSI C63.19-2007)

DASY5 Configuration:

- Probe: ER3DV6 - SN2466; ConvF(1, 1, 1); Calibrated: 2016/05/27;
- Sensor-Surface: (Fix Surface)
- Electronics: DAE4 Sn1207; Calibrated: 2015/11/20
- Phantom: HAC Test Arch with AMCC; Type: SD HAC P01 BA;
- Measurement SW: DASYS2, Version 52.8 (8); SEMCAD X Version 14.6.10 (7331)

Dipole E-Field measurement (E-field scan for ANSI C63.19-2007 & -2011 compliance)/E Scan - measurement distance from the probe sensor center to CD835 = 15mm/Hearing Aid Compatibility Test at 15mm distance (41x361x1): Interpolated grid: dx=0.5000 mm, dy=0.5000 mm

Device Reference Point: 0, 0, -6.3 mm

Reference Value = 93.80 V/m; Power Drift = -0.02 dB

PMR not calibrated. PMF = 1.000 is applied.

E-field emissions = 103.9 V/m

Near-field category: M4 (AWF 0 dB)

PMF scaled E-field

Grid 1 M4 101.3 V/m	Grid 2 M4 103.9 V/m	Grid 3 M4 102.7 V/m
Grid 4 M4 59.79 V/m	Grid 5 M4 60.64 V/m	Grid 6 M4 60.10 V/m
Grid 7 M4 92.83 V/m	Grid 8 M4 94.12 V/m	Grid 9 M4 92.72 V/m

Cursor:

Total = 103.9 V/m

E Category: M4

Location: -0.5, -71, 9.7 mm

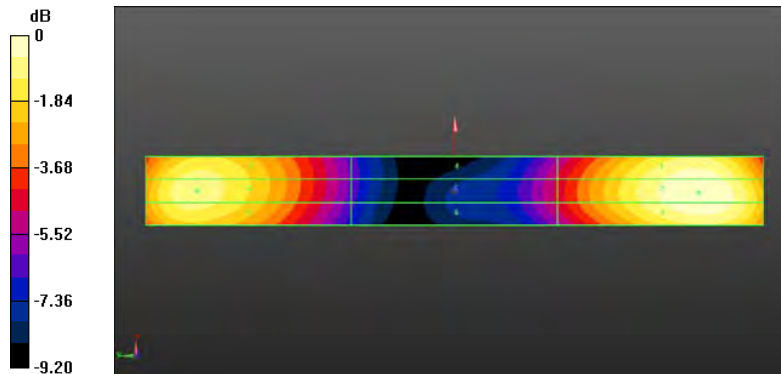

0 dB = 103.9 V/m = 40.33 dBV/m

Test Laboratory: QuieTek-a DEKRA

Date/Time: 2016/06/22

HAC Correction 1900

DUT: HAC Dipole 1880 MHz; Type: CD1880V3

Communication System: UID 0, CW; Frequency: 1880 MHz;

Communication System PAR: 0 dB

Medium parameters used: $\sigma = 0$ S/m, $\epsilon_r = 1$; $\rho = 1000$ kg/m³

Phantom section: RF Section

Ambient Temperature (°C) : 22.4, Humidity (%RH) : 54

Measurement Standard: DASY5 (IEEE/IEC/ANSI C63.19-2007)

DASY5 Configuration:

- Probe: ER3DV6 - SN2466; ConvF(1, 1, 1); Calibrated: 2016/05/27;
- Sensor-Surface: (Fix Surface)
- Electronics: DAE4 Sn1207; Calibrated: 2015/11/20
- Phantom: HAC Test Arch with AMCC; Type: SD HAC P01 BA;
- Measurement SW: DASY52, Version 52.8 (8); SEMCAD X Version 14.6.10 (7331)

Dipole E-Field measurement (E-field scan for ANSI C63.19-2007 & -2011 compliance)/E Scan - measurement distance from the probe sensor center to CD1880 = 15mm/Hearing Aid Compatibility Test at 15mm distance

(41x181x1): Interpolated grid: dx=0.5000 mm, dy=0.5000 mm

Device Reference Point: 0, 0, -6.3 mm

Reference Value = 148.7 V/m; Power Drift = 0.00 dB

PMR not calibrated. PMF = 1.000 is applied.

E-field emissions = 87.44 V/m

Near-field category: M3 (AWF 0 dB)

PMF scaled E-field

Grid 1 M3 84.92 V/m	Grid 2 M3 87.44 V/m	Grid 3 M3 86.77 V/m
Grid 4 M3 69.78 V/m	Grid 5 M3 70.86 V/m	Grid 6 M3 70.24 V/m
Grid 7 M3 84.40 V/m	Grid 8 M3 85.71 V/m	Grid 9 M3 84.65 V/m

Cursor:

Total = 87.44 V/m

E Category: M3

Location: -1, -31.5, 9.7 mm

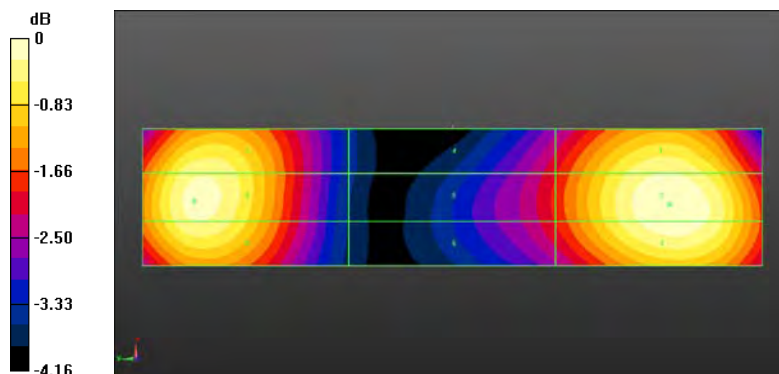

0 dB = 87.44 V/m = 38.83 dBV/m

Appendix B. HAC RF Emission Measurement Data

Test Laboratory: QuieTek-a DEKRA

Date/Time: 2016/06/22

GSM 850 CH 128

DUT: Smart Phone; Type: PH4002

Communication System: UID 0, FCC GSM_850MHz; Frequency: 824.2 MHz;

Communication System PAR: 0 dB

Medium parameters used: $\sigma = 0$ S/m, $\epsilon_r = 1$; $\rho = 1000$ kg/m³

Phantom section: RF Section

Ambient Temperature (°C) : 22.4, Humidity (%RH) : 54

Measurement Standard: DASYS (IEEE/IEC/ANSI C63.19-2011)

DASY5 Configuration:

- Probe: ER3DV6 - SN2466; ConvF(1, 1, 1); Calibrated: 2016/05/27;
- Sensor-Surface: (Fix Surface)
- Electronics: DAE4 Sn1207; Calibrated: 2015/11/20
- Phantom: HAC Test Arch with AMCC; Type: SD HAC P01 BA;
- Measurement SW: DASYS2, Version 52.8 (8); SEMCAD X Version 14.6.10 (7331)

Device E-Field measurement (E-field scan for ANSI C63.19-2007 & -2011 compliance)/E Scan - ER3D: 15 mm from Probe Center to the

Device/Hearing Aid Compatibility Test (101x101x1): Interpolated grid: dx=0.5000 mm, dy=0.5000 mm

Device Reference Point: 0, 0, -6.3 mm

Reference Value = 63.53 V/m; Power Drift = -0.03 dB

Applied MIF = 3.48 dB

RF audio interference level = 38.15 dBV/m

Emission category: M4

MIF scaled E-field

Grid 1 M4 36.73 dBV/m	Grid 2 M4 37.86 dBV/m	Grid 3 M4 37.85 dBV/m
Grid 4 M4 37.12 dBV/m	Grid 5 M4 38.15 dBV/m	Grid 6 M4 38.13 dBV/m
Grid 7 M4 37.29 dBV/m	Grid 8 M4 38.15 dBV/m	Grid 9 M4 38.08 dBV/m

Cursor:

Total = 38.15 dBV/m

E Category: M4

Location: -6.5, 5.5, 8.7 mm

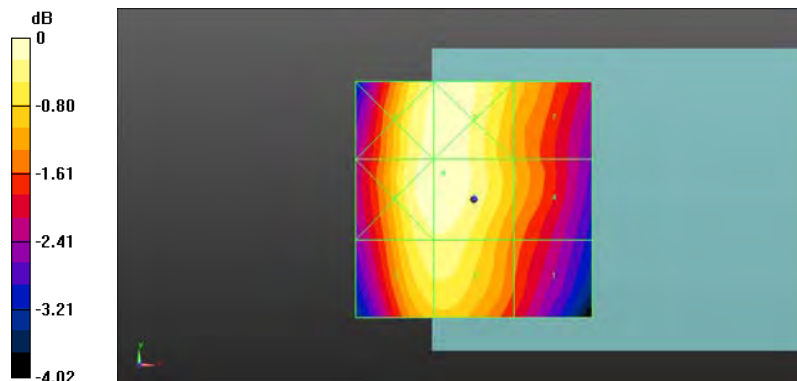

0 dB = 80.83 V/m = 38.15 dBV/m

Test Laboratory: QuieTek-a DEKRA

Date/Time: 2016/06/22

GSM 850 CH 190

DUT: Smart Phone; Type: PH4002

Communication System: UID 0, FCC GSM_850MHz; Frequency: 836.6 MHz;

Communication System PAR: 0 dB

Medium parameters used: $\sigma = 0$ S/m, $\epsilon_r = 1$; $\rho = 1000$ kg/m³

Phantom section: RF Section

Ambient Temperature (°C) : 22.4, Humidity (%RH) : 54

Measurement Standard: DASYS (IEEE/IEC/ANSI C63.19-2011)

DASY5 Configuration:

- Probe: ER3DV6 - SN2466; ConvF(1, 1, 1); Calibrated: 2016/05/27;
- Sensor-Surface: (Fix Surface)
- Electronics: DAE4 Sn1207; Calibrated: 2015/11/20
- Phantom: HAC Test Arch with AMCC; Type: SD HAC P01 BA;
- Measurement SW: DASYS2, Version 52.8 (8); SEMCAD X Version 14.6.10 (7331)

Device E-Field measurement (E-field scan for ANSI C63.19-2007 & -2011 compliance)/E Scan - ER3D: 15 mm from Probe Center to the Device/Hearing Aid Compatibility Test (101x101x1): Interpolated grid: dx=0.5000 mm, dy=0.5000 mm

Device Reference Point: 0, 0, -6.3 mm

Reference Value = 63.27 V/m; Power Drift = -0.09 dB

Applied MIF = 3.47 dB

RF audio interference level = 38.01 dBV/m

Emission category: M4

MIF scaled E-field

Grid 1 M4 36.5 dBV/m	Grid 2 M4 37.62 dBV/m	Grid 3 M4 37.62 dBV/m
Grid 4 M4 37 dBV/m	Grid 5 M4 38.01 dBV/m	Grid 6 M4 37.98 dBV/m
Grid 7 M4 37.38 dBV/m	Grid 8 M4 38.05 dBV/m	Grid 9 M4 37.96 dBV/m

Cursor:

Total = 38.05 dBV/m

E Category: M4

Location: -5, 20, 8.7 mm

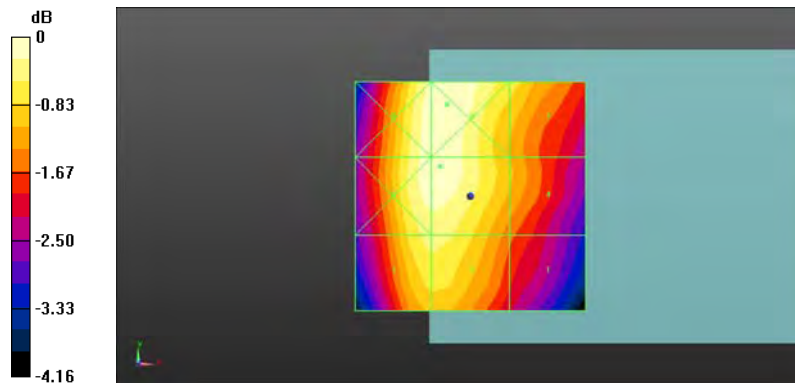

0 dB = 79.91 V/m = 38.05 dBV/m

Test Laboratory: QuieTek-a DEKRA

Date/Time: 2016/06/22

GSM 850 CH 251

DUT: Smart Phone; Type: PH4002

Communication System: UID 0, FCC GSM_850MHz; Frequency: 848.8 MHz;

Communication System PAR: 0 dB

Medium parameters used: $\sigma = 0$ S/m, $\epsilon_r = 1$; $\rho = 1000$ kg/m³

Phantom section: RF Section

Ambient Temperature (°C) : 22.4, Humidity (%RH) : 54

Measurement Standard: DASYS (IEEE/IEC/ANSI C63.19-2011)

DASY5 Configuration:

- Probe: ER3DV6 - SN2466; ConvF(1, 1, 1); Calibrated: 2016/05/27;
- Sensor-Surface: (Fix Surface)
- Electronics: DAE4 Sn1207; Calibrated: 2015/11/20
- Phantom: HAC Test Arch with AMCC; Type: SD HAC P01 BA;
- Measurement SW: DASYS2, Version 52.8 (8); SEMCAD X Version 14.6.10 (7331)

Device E-Field measurement (E-field scan for ANSI C63.19-2007 & -2011 compliance)/E Scan - ER3D: 15 mm from Probe Center to the Device/Hearing Aid Compatibility Test (101x101x1): Interpolated grid: dx=0.5000 mm, dy=0.5000 mm

Device Reference Point: 0, 0, -6.3 mm

Reference Value = 60.11 V/m; Power Drift = -0.10 dB

Applied MIF = 3.40 dB

RF audio interference level = 37.51 dBV/m

Emission category: M4

MIF scaled E-field

Grid 1 M4 35.96 dBV/m	Grid 2 M4 37.02 dBV/m	Grid 3 M4 37 dBV/m
Grid 4 M4 36.54 dBV/m	Grid 5 M4 37.51 dBV/m	Grid 6 M4 37.5 dBV/m
Grid 7 M4 37 dBV/m	Grid 8 M4 37.67 dBV/m	Grid 9 M4 37.59 dBV/m

Cursor:

Total = 37.67 dBV/m

E Category: M4

Location: -4, 24.5, 8.7 mm

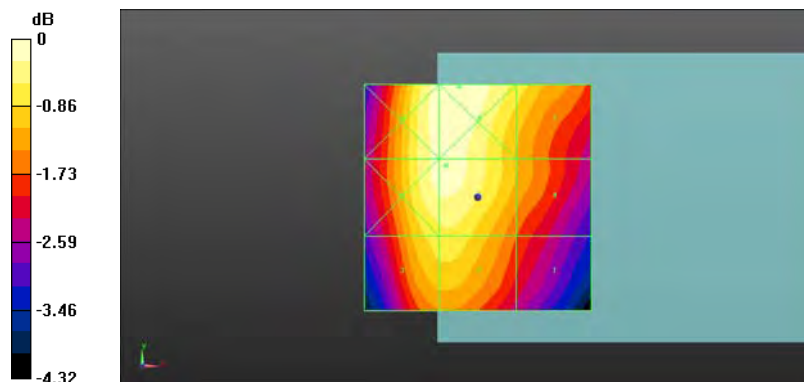

0 dB = 76.45 V/m = 37.67 dBV/m

Test Laboratory: QuieTek-a DEKRA

Date/Time: 2016/06/22

PCS 1900 CH 512

DUT: Smart Phone; Type: PH4002

Communication System: UID 0, FCC PCS_1900MHz; Frequency: 1850.2 MHz;

Communication System PAR: 0 dB

Medium parameters used: $\sigma = 0$ S/m, $\epsilon_r = 1$; $\rho = 1000$ kg/m³

Phantom section: RF Section

Ambient Temperature (°C) : 22.4, Humidity (%RH) : 54

Measurement Standard: DASYS (IEEE/IEC/ANSI C63.19-2011)

DASY5 Configuration:

- Probe: ER3DV6 - SN2466; ConvF(1, 1, 1); Calibrated: 2016/05/27;
- Sensor-Surface: (Fix Surface)
- Electronics: DAE4 Sn1207; Calibrated: 2015/11/20
- Phantom: HAC Test Arch with AMCC; Type: SD HAC P01 BA;
- Measurement SW: DASYS2, Version 52.8 (8); SEMCAD X Version 14.6.10 (7331)

Device E-Field measurement (E-field scan for ANSI C63.19-2007 & -2011 compliance)/E Scan - ER3D: 15 mm from Probe Center to the Device/Hearing Aid Compatibility Test (101x101x1): Interpolated grid: dx=0.5000 mm, dy=0.5000 mm

Device Reference Point: 0, 0, -6.3 mm

Reference Value = 14.19 V/m; Power Drift = 0.02 dB

Applied MIF = 3.50 dB

RF audio interference level = 31.20 dBV/m

Emission category: M3

MIF scaled E-field

Grid 1 M3 31.77 dBV/m	Grid 2 M3 30.11 dBV/m	Grid 3 M4 27.48 dBV/m
Grid 4 M3 30.87 dBV/m	Grid 5 M4 28.4 dBV/m	Grid 6 M4 28.67 dBV/m
Grid 7 M4 29.34 dBV/m	Grid 8 M3 31.2 dBV/m	Grid 9 M3 31.2 dBV/m

Cursor:

Total = 31.77 dBV/m

E Category: M3

Location: 25, -25, 8.7 mm

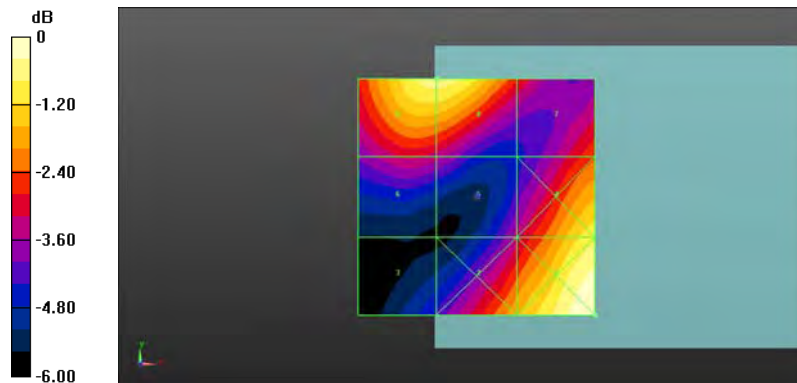

0 dB = 38.79 V/m = 31.77 dBV/m

Test Laboratory: QuieTek-a DEKRA

Date/Time: 2016/06/22

PCS 1900 CH 661

DUT: Smart Phone; Type: PH4002

Communication System: UID 0, FCC PCS_1900MHz; Frequency: 1880 MHz;

Communication System PAR: 0 dB

Medium parameters used: $\sigma = 0$ S/m, $\epsilon_r = 1$; $\rho = 1000$ kg/m³

Phantom section: RF Section

Ambient Temperature (°C) : 22.4, Humidity (%RH) : 54

Measurement Standard: DASYS (IEEE/IEC/ANSI C63.19-2011)

DASY5 Configuration:

- Probe: ER3DV6 - SN2466; ConvF(1, 1, 1); Calibrated: 2016/05/27;
- Sensor-Surface: (Fix Surface)
- Electronics: DAE4 Sn1207; Calibrated: 2015/11/20
- Phantom: HAC Test Arch with AMCC; Type: SD HAC P01 BA;
- Measurement SW: DASYS2, Version 52.8 (8); SEMCAD X Version 14.6.10 (7331)

Device E-Field measurement (E-field scan for ANSI C63.19-2007 & -2011 compliance)/E Scan - ER3D: 15 mm from Probe Center to the Device/Hearing Aid Compatibility Test (101x101x1): Interpolated grid: dx=0.5000 mm, dy=0.5000 mm

Device Reference Point: 0, 0, -6.3 mm

Reference Value = 14.76 V/m; Power Drift = -0.01 dB

Applied MIF = 3.60 dB

RF audio interference level = 31.02 dBV/m

Emission category: M3

MIF scaled E-field

Grid 1 M3 31.65 dBV/m	Grid 2 M3 30.1 dBV/m	Grid 3 M4 28.06 dBV/m
Grid 4 M3 30.78 dBV/m	Grid 5 M4 28.43 dBV/m	Grid 6 M4 28.61 dBV/m
Grid 7 M4 29.33 dBV/m	Grid 8 M3 31.02 dBV/m	Grid 9 M3 30.97 dBV/m

Cursor:

Total = 31.65 dBV/m

E Category: M3

Location: 25, -25, 8.7 mm

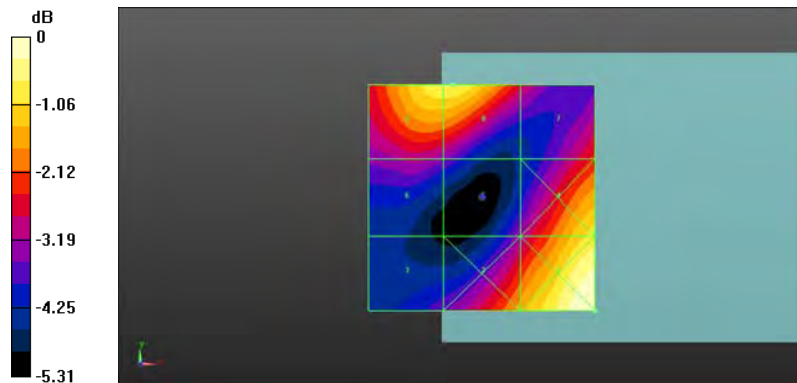

0 dB = 38.25 V/m = 31.65 dBV/m

Test Laboratory: QuieTek-a DEKRA

Date/Time: 2016/06/22

PCS 1900 CH 810

DUT: Smart Phone; Type: PH4002

Communication System: UID 0, FCC PCS_1900MHz; Frequency: 1909.8 MHz;

Communication System PAR: 0 dB

Medium parameters used: $\sigma = 0$ S/m, $\epsilon_r = 1$; $\rho = 1000$ kg/m³

Phantom section: RF Section

Ambient Temperature (°C) : 22.4, Humidity (%RH) : 54

Measurement Standard: DASYS (IEEE/IEC/ANSI C63.19-2011)

DASY5 Configuration:

- Probe: ER3DV6 - SN2466; ConvF(1, 1, 1); Calibrated: 2016/05/27;
- Sensor-Surface: (Fix Surface)
- Electronics: DAE4 Sn1207; Calibrated: 2015/11/20
- Phantom: HAC Test Arch with AMCC; Type: SD HAC P01 BA;
- Measurement SW: DASYS2, Version 52.8 (8); SEMCAD X Version 14.6.10 (7331)

Device E-Field measurement (E-field scan for ANSI C63.19-2007 & -2011 compliance)/E Scan - ER3D: 15 mm from Probe Center to the Device/Hearing Aid Compatibility Test (101x101x1): Interpolated grid: dx=0.5000 mm, dy=0.5000 mm

Device Reference Point: 0, 0, -6.3 mm

Reference Value = 14.64 V/m; Power Drift = -0.14 dB

Applied MIF = 3.01 dB

RF audio interference level = 30.46 dBV/m

Emission category: M3

MIF scaled E-field

Grid 1 M3 30.46 dBV/m	Grid 2 M4 29.47 dBV/m	Grid 3 M4 27.65 dBV/m
Grid 4 M4 29.67 dBV/m	Grid 5 M4 27.89 dBV/m	Grid 6 M4 28.28 dBV/m
Grid 7 M4 28.47 dBV/m	Grid 8 M3 30.52 dBV/m	Grid 9 M3 30.52 dBV/m

Cursor:

Total = 30.52 dBV/m

E Category: M3

Location: -9, 25, 8.7 mm

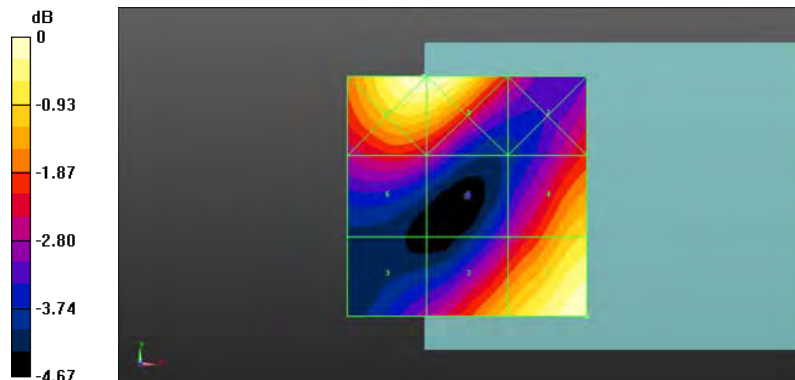

0 dB = 33.59 V/m = 30.52 dBV/m

Appendix C. Test Setup Photographs & EUT Photographs
Test Setup Photographs

HAC Front View



HAC Side View

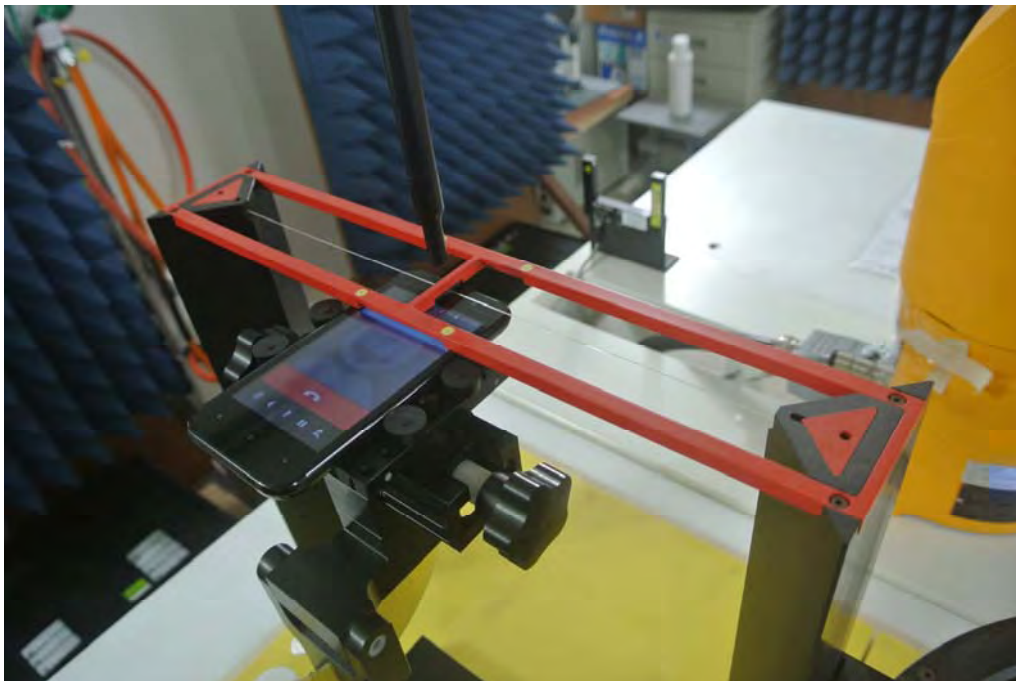

EUT Photographs





Appendix D. HAC Probe Calibration Data

Object: ER3DV6- SN: 2466

1130H

**Calibration Laboratory of
Schmid & Partner
Engineering AG**
Zeughausstrasse 43, 8004 Zurich, Switzerland



S Schweizerischer Kalibrierdienst
S Service suisse d'étalonnage
C Servizio svizzero di taratura
S Swiss Calibration Service

Accredited by the Swiss Accreditation Service (SAS)
The Swiss Accreditation Service is one of the signatories to the EA
Multilateral Agreement for the recognition of calibration certificates

Accreditation No.: **SCS 0108**

Client **Quietek-TW (Auden)**

Certificate No: **ER3-2466_May16**

CALIBRATION CERTIFICATE

Object **ER3DV6 - SN:2466**

Calibration procedure(s) **QA CAL-02.v8, QA CAL-25.v6
Calibration procedure for E-field probes optimized for close near field
evaluations in air**

Calibration date: **May 27, 2016**

This calibration certificate documents the traceability to national standards, which realize the physical units of measurements (SI).
The measurements and the uncertainties with confidence probability are given on the following pages and are part of the certificate.

All calibrations have been conducted in the closed laboratory facility: environment temperature (22 ± 3)°C and humidity < 70%.

Calibration Equipment used (M&TE critical for calibration)

Primary Standards	ID	Cal Date (Certificate No.)	Scheduled Calibration
Power meter NRP	SN: 104778	06-Apr-16 (No. 217-02288/02289)	Apr-17
Power sensor NRP-Z91	SN: 103244	06-Apr-16 (No. 217-02288)	Apr-17
Power sensor NRP-Z91	SN: 103245	06-Apr-16 (No. 217-02289)	Apr-17
Reference 20 dB Attenuator	SN: S5277 (20x)	05-Apr-16 (No. 217-02293)	Apr-17
Reference Probe ER3DV6	SN: 2328	12-Oct-15 (No. ER3-2328_Oct15)	Oct-16
DAE4	SN: 789	31-Mar-16 (No. DAE4-789_Mar16)	Mar-17
Secondary Standards	ID	Check Date (in house)	Scheduled Check
Power meter E4419B	SN: GB41293874	06-Apr-16 (No. 217-02285/02284)	In house check: Jun-16
Power sensor E4412A	SN: MY41498087	06-Apr-16 (No. 217-02285)	In house check: Jun-16
Power sensor E4412A	SN: 000110210	06-Apr-16 (No. 217-02284)	In house check: Jun-16
RF generator HP 8648C	SN: US3642U01700	04-Aug-99 (in house check Apr-13)	In house check: Jun-16
Network Analyzer HP 8753E	SN: US37390585	18-Oct-01 (in house check Oct-15)	In house check: Oct-16

	Name	Function	Signature
Calibrated by:	Michael Weber	Laboratory Technician	
Approved by:	Katja Pokovic	Technical Manager	
			Issued: May 30, 2016

This calibration certificate shall not be reproduced except in full without written approval of the laboratory.



Accredited by the Swiss Accreditation Service (SAS)

The Swiss Accreditation Service is one of the signatories to the EA
Multilateral Agreement for the recognition of calibration certificates

Accreditation No.: **SCS 0108**

Glossary:

NORM _{x,y,z}	sensitivity in free space
DCP	diode compression point
CF	crest factor (1/duty_cycle) of the RF signal
A, B, C, D	modulation dependent linearization parameters
Polarization φ	φ rotation around probe axis
Polarization ϑ	ϑ rotation around an axis that is in the plane normal to probe axis (at measurement center), i.e., $\vartheta = 0$ is normal to probe axis
Connector Angle	information used in DASY system to align probe sensor X to the robot coordinate system

Calibration is Performed According to the Following Standards:

- IEEE Std 1309-2005, " IEEE Standard for calibration of electromagnetic field sensors and probes, excluding antennas, from 9 kHz to 40 GHz", December 2005
- CTIA Test Plan for Hearing Aid Compatibility, Rev 3.0, November 2013

Methods Applied and Interpretation of Parameters:

- NORM_{x,y,z}**: Assessed for E-field polarization $\vartheta = 0$ for XY sensors and $\vartheta = 90$ for Z sensor ($f \leq 900$ MHz in TEM-cell; $f > 1800$ MHz: R22 waveguide).
- NORM(f)_{x,y,z}** = **NORM_{x,y,z}** * *frequency_response* (see Frequency Response Chart).
- DCP_{x,y,z}**: DCP are numerical linearization parameters assessed based on the data of power sweep with CW signal (no uncertainty required). DCP does not depend on frequency nor media.
- PAR**: PAR is the Peak to Average Ratio that is not calibrated but determined based on the signal characteristics
- A_{x,y,z}; B_{x,y,z}; C_{x,y,z}; D_{x,y,z}; VR_{x,y,z}**: A, B, C, D are numerical linearization parameters assessed based on the data of power sweep for specific modulation signal. The parameters do not depend on frequency nor media. VR is the maximum calibration range expressed in RMS voltage across the diode.
- Spherical isotropy (3D deviation from isotropy)**: in a locally homogeneous field realized using an open waveguide setup.
- Sensor Offset**: The sensor offset corresponds to the offset of virtual measurement center from the probe tip (on probe axis). No tolerance required.
- Connector Angle**: The angle is assessed using the information gained by determining the **NORM_x** (no uncertainty required).

Probe ER3DV6

SN:2466

Manufactured: March 31, 2009
Calibrated: May 27, 2016

Calibrated for DASY/EASY Systems
(Note: non-compatible with DASY2 system!)

DASY/EASY - Parameters of Probe: ER3DV6 - SN:2466

Basic Calibration Parameters

	Sensor X	Sensor Y	Sensor Z	Unc (k=2)
Norm ($\mu\text{V}/(\text{V}/\text{m})^2$)	1.77	1.68	1.62	$\pm 10.1 \%$
DCP (mV) ^B	99.4	99.8	101.1	

Modulation Calibration Parameters

UID	Communication System Name		A dB	B dB/ $\sqrt{\mu\text{V}}$	C	D dB	VR mV	Unc ^E (k=2)
0	CW	X	0.0	0.0	1.0	0.00	154.1	$\pm 3.5 \%$
		Y	0.0	0.0	1.0		160.5	
		Z	0.0	0.0	1.0		174.2	
10011- CAB	UMTS-FDD (WCDMA)	X	3.23	66.5	18.6	2.91	123.2	$\pm 1.2 \%$
		Y	3.33	67.3	19.1		128.5	
		Z	3.32	67.0	18.4		139.3	
10021- DAB	GSM-FDD (TDMA, GMSK)	X	22.69	100.0	28.8	9.39	140.1	$\pm 1.7 \%$
		Y	20.88	99.9	28.6		135.0	
		Z	13.00	90.4	25.3		104.4	

The reported uncertainty of measurement is stated as the standard uncertainty of measurement multiplied by the coverage factor $k=2$, which for a normal distribution corresponds to a coverage probability of approximately 95%.

^B Numerical linearization parameter: uncertainty not required.

^E Uncertainty is determined using the max. deviation from linear response applying rectangular distribution and is expressed for the square of the field value.

Frequency Response of E-Field (TEM-Cell:ifi110 EXX, Waveguide: R22)

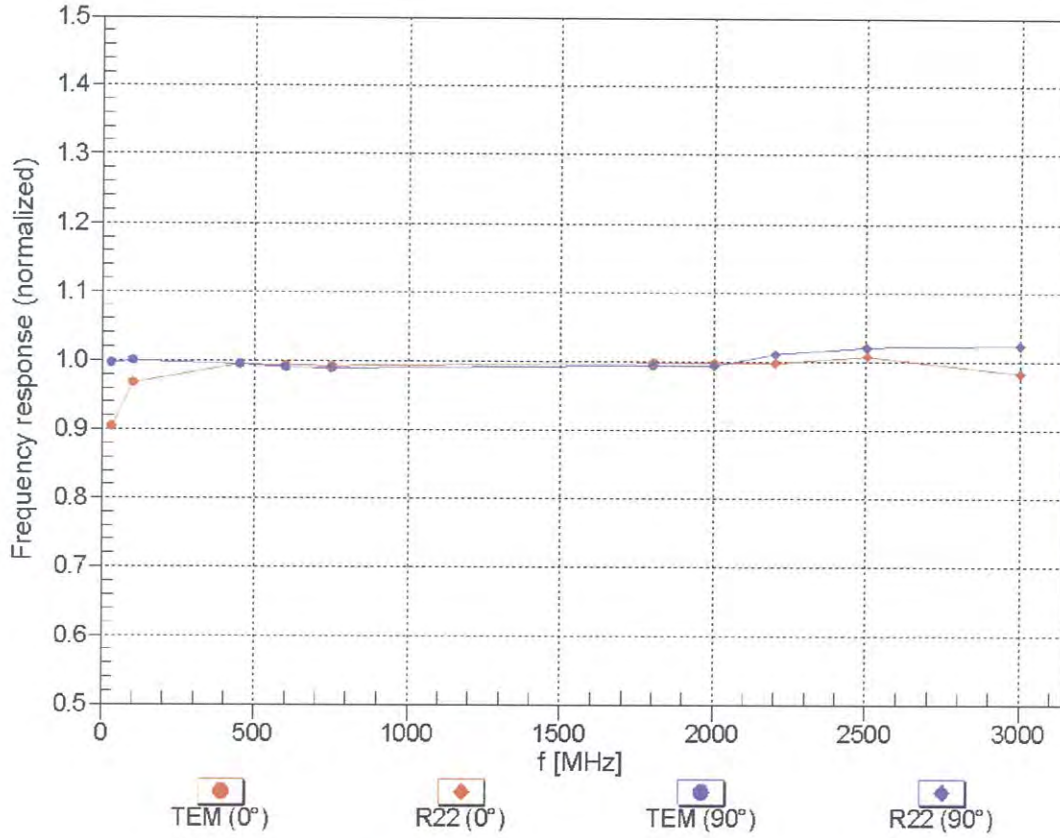

Uncertainty of Frequency Response of E-field: $\pm 6.3\%$ (k=2)

Receiving Pattern (ϕ), $\vartheta = 0^\circ$

f=600 MHz, TEM, 0°

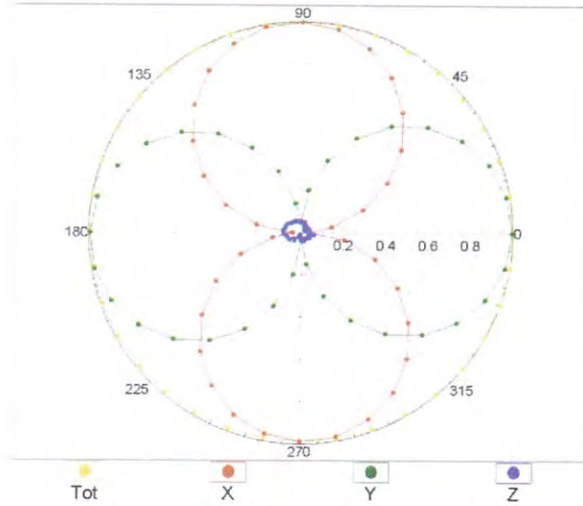

f=2500 MHz, R22, 0°

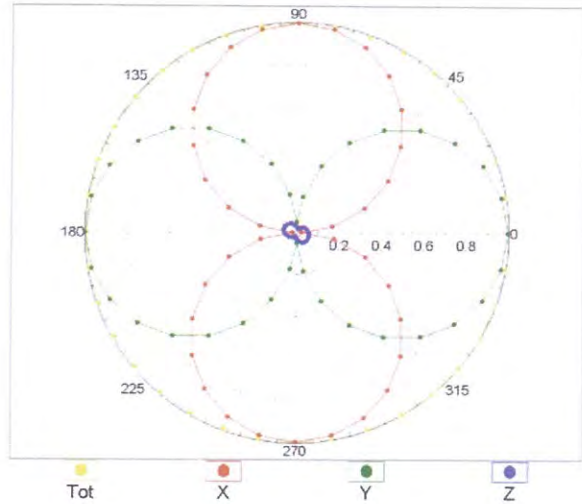

Receiving Pattern (ϕ), $\vartheta = 90^\circ$

f=600 MHz, TEM, 90°

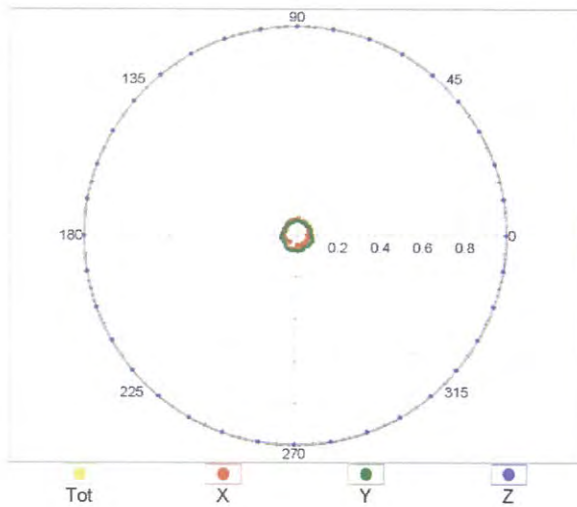

f=2500 MHz, R22, 90°

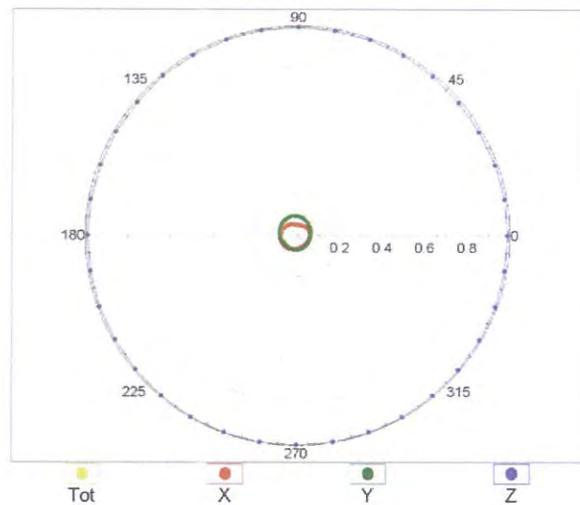

Receiving Pattern (ϕ), $\vartheta = 0^\circ$

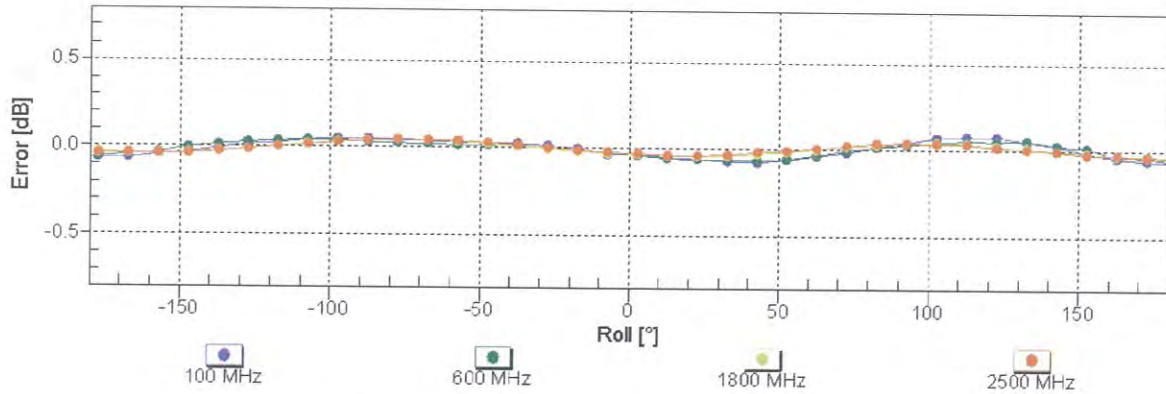

Uncertainty of Axial Isotropy Assessment: $\pm 0.5\%$ ($k=2$)

Receiving Pattern (ϕ), $\vartheta = 90^\circ$

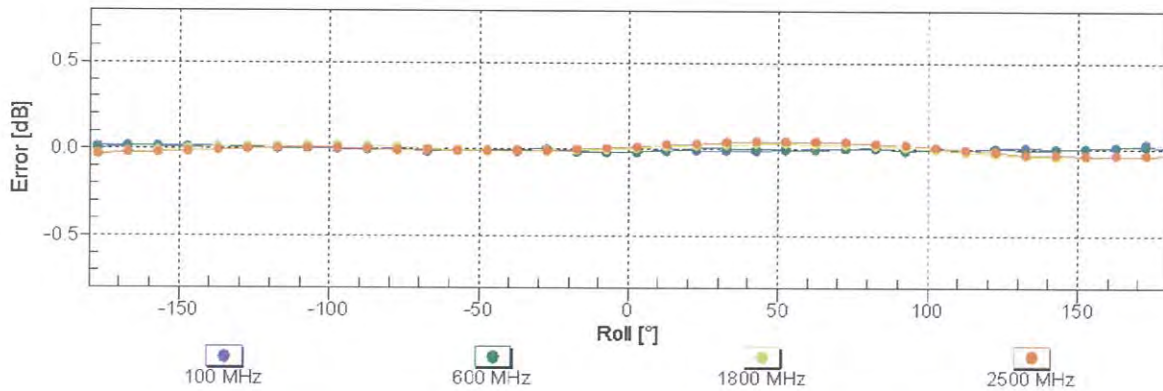

Uncertainty of Axial Isotropy Assessment: $\pm 0.5\%$ ($k=2$)

Dynamic Range f(E-field) (TEM cell , f = 900 MHz)

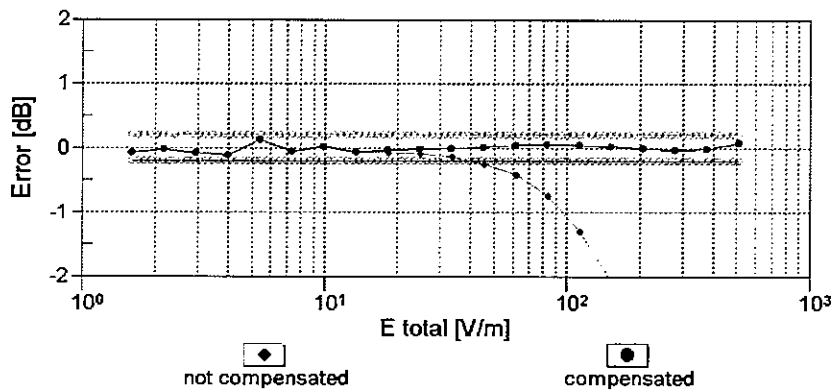
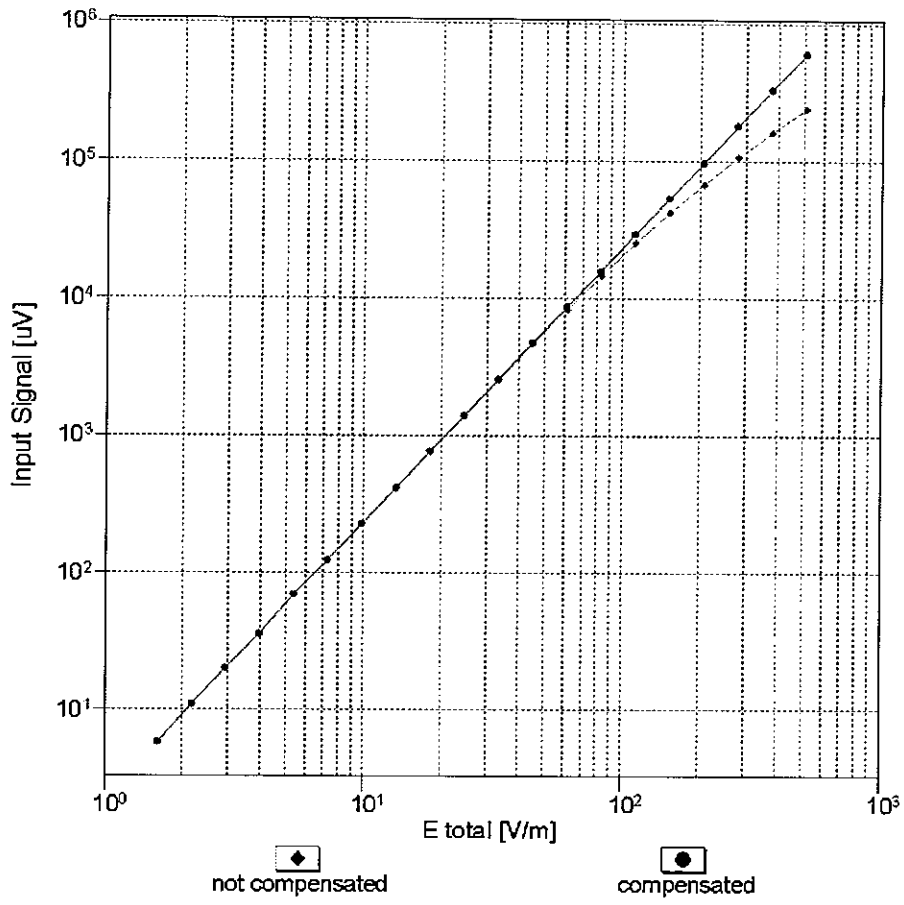

Uncertainty of Linearity Assessment: ± 0.6% (k=2)

Deviation from Isotropy in Air

Error (ϕ, θ), $f = 900$ MHz

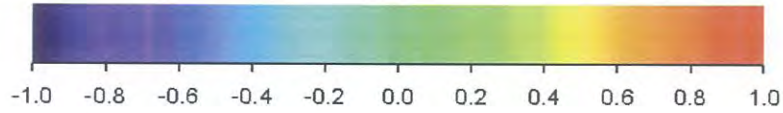
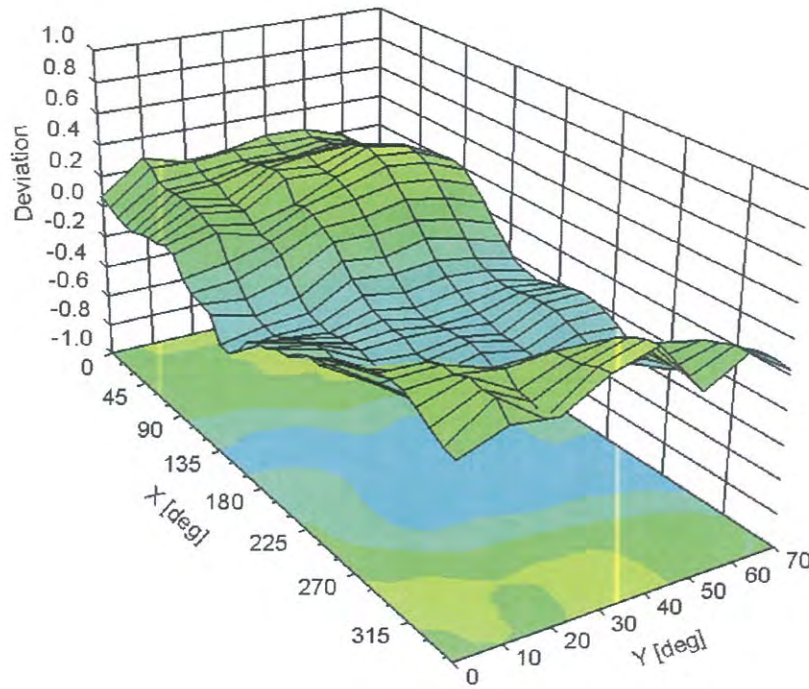

Uncertainty of Spherical Isotropy Assessment: $\pm 2.6\%$ ($k=2$)

DASY/EASY - Parameters of Probe: ER3DV6 - SN:2466

Other Probe Parameters

Sensor Arrangement	Rectangular
Connector Angle (°)	142.5
Mechanical Surface Detection Mode	enabled
Optical Surface Detection Mode	disabled
Probe Overall Length	337 mm
Probe Body Diameter	10 mm
Tip Length	10 mm
Tip Diameter	8 mm
Probe Tip to Sensor X Calibration Point	2.5 mm
Probe Tip to Sensor Y Calibration Point	2.5 mm
Probe Tip to Sensor Z Calibration Point	2.5 mm

Appendix E. HAC Dipole Calibration

Validation Dipole 835MHz

M/N: CD835V3

S/N: 1135

Validation Dipole 1900MHz

M/N: CD1880V3

S/N: 1117



1154 HP

Accredited by the Swiss Accreditation Service (SAS)
The Swiss Accreditation Service is one of the signatories to the EA
Multilateral Agreement for the recognition of calibration certificates

Accreditation No.: **SCS 0108**

Client **Quietek-TW (Auden)**

Certificate No: **CD835V3-1135_May15**

CALIBRATION CERTIFICATE

Object **CD835V3 - SN: 1135**

Calibration procedure(s) **QA CAL-20.v6
Calibration procedure for dipoles in air**

Calibration date: **May 26, 2015**

This calibration certificate documents the traceability to national standards, which realize the physical units of measurements (SI).
The measurements and the uncertainties with confidence probability are given on the following pages and are part of the certificate.

All calibrations have been conducted in the closed laboratory facility: environment temperature (22 ± 3)°C and humidity < 70%.

Calibration Equipment used (M&TE critical for calibration)

Primary Standards	ID #	Cal Date (Certificate No.)	Scheduled Calibration
Power meter EPM-442A	GB37480704	07-Oct-14 (No. 217-02020)	Oct-15
Power sensor HP 8481A	US37292783	07-Oct-14 (No. 217-02020)	Oct-15
Power sensor HP 8481A	MY41092317	07-Oct-14 (No. 217-02021)	Oct-15
Reference 10 dB Attenuator	SN: 5047.2 / 06327	01-Apr-15 (No. 217-02130)	Mar-16
Probe ER3DV6	SN: 2336	31-Dec-14 (No. ER3-2336_Dec14)	Dec-15
Probe H3DV6	SN: 6065	31-Dec-14 (No. H3-6065_Dec14)	Dec-15
DAE4	SN: 781	12-Sep-14 (No. DAE4-781_Sep14)	Sep-15
Secondary Standards	ID #	Check Date (in house)	Scheduled Check
Power meter Agilent 4419B	SN: GB42420191	09-Oct-09 (in house check Sep-14)	In house check: Sep-16
Power sensor HP E4412A	SN: US38485102	05-Jan-10 (in house check Sep-14)	In house check: Sep-16
Power sensor HP 8482A	SN: US37295597	09-Oct-09 (in house check Sep-14)	In house check: Sep-16
Network Analyzer HP 8753E	US37390585	18-Oct-01 (in house check Oct-14)	In house check: Oct-15
RF generator R&S SMT-06	SN: 832283/011	27-Aug-12 (in house check Oct-13)	In house check: Oct-16

	Name	Function	Signature
Calibrated by:	Israe Elnaouq	Laboratory Technician	
Approved by:	Fin Bomholt	Deputy Technical Manager	

Issued: May 27, 2015

This calibration certificate shall not be reproduced except in full without written approval of the laboratory.



Accredited by the Swiss Accreditation Service (SAS)

The Swiss Accreditation Service is one of the signatories to the EA
Multilateral Agreement for the recognition of calibration certificates

Accreditation No.: **SCS 0108**

References

- [1] ANSI-C63.19-2011
American National Standard, Methods of Measurement of Compatibility between Wireless Communications
Devices and Hearing Aids.

Methods Applied and Interpretation of Parameters:

- *Coordinate System:* y-axis is in the direction of the dipole arms. z-axis is from the basis of the antenna (mounted on the table) towards its feed point between the two dipole arms. x-axis is normal to the other axes. In coincidence with the standards [1], the measurement planes (probe sensor center) are selected to be at a distance of 15 mm above the top metal edge of the dipole arms.
- *Measurement Conditions:* Further details are available from the hardcopies at the end of the certificate. All figures stated in the certificate are valid at the frequency indicated. The forward power to the dipole connector is set with a calibrated power meter connected and monitored with an auxiliary power meter connected to a directional coupler. While the dipole under test is connected, the forward power is adjusted to the same level.
- *Antenna Positioning:* The dipole is mounted on a HAC Test Arch phantom using the matching dipole positioner with the arms horizontal and the feeding cable coming from the floor. The measurements are performed in a shielded room with absorbers around the setup to reduce the reflections. It is verified before the mounting of the dipole under the Test Arch phantom, that its arms are perfectly in a line. It is installed on the HAC dipole positioner with its arms parallel below the dielectric reference wire and able to move elastically in vertical direction without changing its relative position to the top center of the Test Arch phantom. The vertical distance to the probe is adjusted after dipole mounting with a DASY5 Surface Check job. Before the measurement, the distance between phantom surface and probe tip is verified. The proper measurement distance is selected by choosing the matching section of the HAC Test Arch phantom with the proper device reference point (upper surface of the dipole) and the matching grid reference point (tip of the probe) considering the probe sensor offset. The vertical distance to the probe is essential for the accuracy.
- *Feed Point Impedance and Return Loss:* These parameters are measured using a HP 8753E Vector Network Analyzer. The impedance is specified at the SMA connector of the dipole. The influence of reflections was eliminated by applying the averaging function while moving the dipole in the air, at least 70cm away from any obstacles.
- *E-field distribution:* E field is measured in the x-y-plane with an isotropic ER3D-field probe with 100 mW forward power to the antenna feed point. In accordance with [1], the scan area is 20mm wide, its length exceeds the dipole arm length (180 or 90mm). The sensor center is 15 mm (in z) above the metal top of the dipole arms. Two 3D maxima are available near the end of the dipole arms. Assuming the dipole arms are perfectly in one line, the average of these two maxima (in subgrid 2 and subgrid 8) is determined to compensate for any non-parallelity to the measurement plane as well as the sensor displacement. The E-field value stated as calibration value represents the maximum of the interpolated 3D-E-field, in the plane above the dipole surface.

The reported uncertainty of measurement is stated as the standard uncertainty of measurement multiplied by the coverage factor $k=2$, which for a normal distribution corresponds to a coverage probability of approximately 95%.

Measurement Conditions

DASY system configuration, as far as not given on page 1.

DASY Version	DASY5	V52.8.8
Phantom	HAC Test Arch	
Distance Dipole Top - Probe Center	15 mm	
Scan resolution	dx, dy = 5 mm	
Frequency	835 MHz \pm 1 MHz	
Input power drift	< 0.05 dB	

Maximum Field values at 835 MHz

E-field 15 mm above dipole surface	condition	Interpolated maximum
Maximum measured above high end	100mW input power	105.8V/m = 40.49 dBV/m
Maximum measured above low end	100mW input power	105.7V/m = 40.48 dBV/m
Averaged maximum above arm	100mW input power	105.8V/m \pm 12.8 % (k=2)

Appendix (Additional assessments outside the scope of SCS 0108)

Antenna Parameters

Frequency	Return Loss	Impedance
800 MHz	16.3 dB	43.8 Ω - 13.1 j Ω
835 MHz	29.5 dB	50.3 Ω + 3.3 j Ω
900 MHz	16.8 dB	55.1 Ω - 14.4 j Ω
950 MHz	20.3 dB	45.4 Ω + 8.0 j Ω
960 MHz	15.4 dB	52.2 Ω + 17.5 j Ω

3.2 Antenna Design and Handling

The calibration dipole has a symmetric geometry with a built-in two stub matching network, which leads to the enhanced bandwidth.

The dipole is built of standard semirigid coaxial cable. The internal matching line is open ended. The antenna is therefore open for DC signals.

Do not apply force to dipole arms, as they are liable to bend. The soldered connections near the feedpoint may be damaged. After excessive mechanical stress or overheating, check the impedance characteristics to ensure that the internal matching network is not affected.

After long term use with 40W radiated power, only a slight warming of the dipole near the feedpoint can be measured.

Impedance Measurement Plot

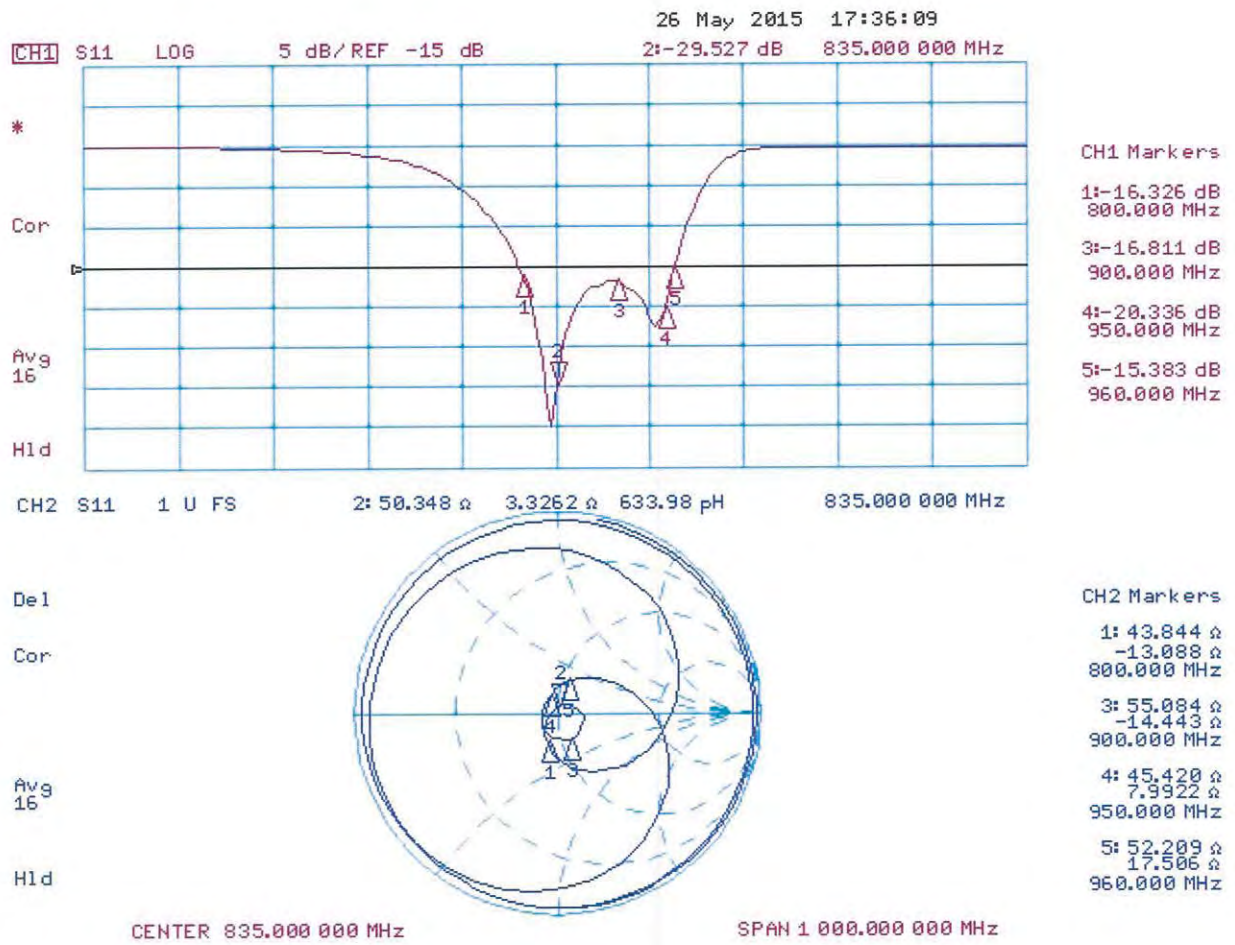

DASY5 E-field Result

Date: 26.05.2015

Test Laboratory: SPEAG Lab2

DUT: HAC-Dipole 835 MHz; Type: CD835V3; Serial: CD835V3 - SN: 1135

Communication System: UID 0 - CW; Frequency: 835 MHz
Medium parameters used: $\sigma = 0$ S/m, $\epsilon_r = 1$; $\rho = 1000$ kg/m³
Phantom section: RF Section
Measurement Standard: DASY5 (IEEE/IEC/ANSI C63.19-2011)

DASY52 Configuration:

- Probe: ER3DV6 - SN2336; ConvF(1, 1, 1); Calibrated: 31.12.2014;
- Sensor-Surface: (Fix Surface)
- Electronics: DAE4 Sn781; Calibrated: 12.09.2014
- Phantom: HAC Test Arch with AMCC; Type: SD HAC P01 BA; Serial: 1070
- DASY52 52.8.8(1222); SEMCAD X 14.6.10(7331)

Reference Dipole E-Field measurement @ 835MHz/E-Scan - 835MHz d=15mm/Hearing Aid Compatibility Test (41x361x1): Interpolated grid: dx=0.5000 mm, dy=0.5000 mm
Device Reference Point: 0, 0, -6.3 mm
Reference Value = 122.3 V/m; Power Drift = -0.02 dB
Applied MIF = 0.00 dB
RF audio interference level = 40.49 dBV/m
Emission category: M3

MIF scaled E-field

Grid 1 M3 40.24 dBV/m	Grid 2 M3 40.48 dBV/m	Grid 3 M3 40.37 dBV/m
Grid 4 M4 35.79 dBV/m	Grid 5 M4 36.04 dBV/m	Grid 6 M4 36 dBV/m
Grid 7 M3 40.23 dBV/m	Grid 8 M3 40.49 dBV/m	Grid 9 M3 40.42 dBV/m

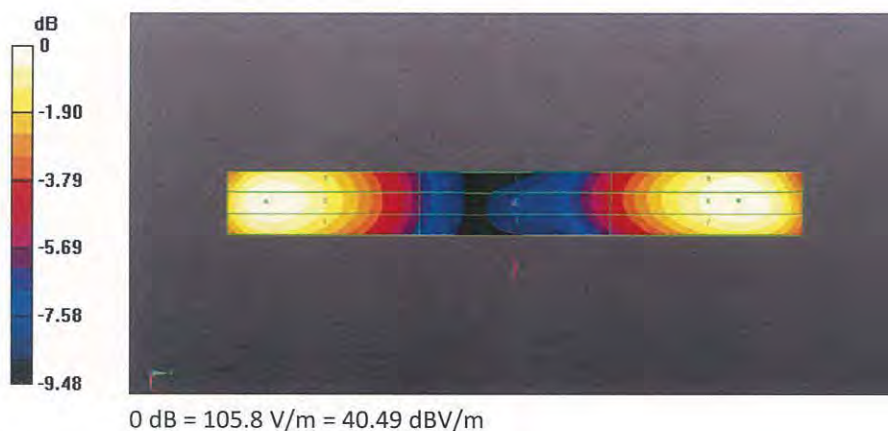

11 33 HP

**Calibration Laboratory of
Schmid & Partner
Engineering AG**
Zeughausstrasse 43, 8004 Zurich, Switzerland



S Schweizerischer Kalibrierdienst
S Service suisse d'étalonnage
S Servizio svizzero di taratura
S Swiss Calibration Service

Accredited by the Swiss Accreditation Service (SAS)
The Swiss Accreditation Service is one of the signatories to the EA
Multilateral Agreement for the recognition of calibration certificates

Accreditation No.: **SCS 0108**

Client **Quietek-TW (Auden)**

Certificate No: **CD1880V3-1117_May15**

CALIBRATION CERTIFICATE

Object **CD1880V3 - SN: 1117**

Calibration procedure(s) **QA CAL-20.v6
Calibration procedure for dipoles in air**

Calibration date: **May 26, 2015**

This calibration certificate documents the traceability to national standards, which realize the physical units of measurements (SI).
The measurements and the uncertainties with confidence probability are given on the following pages and are part of the certificate.

All calibrations have been conducted in the closed laboratory facility: environment temperature (22 ± 3)°C and humidity < 70%.

Calibration Equipment used (M&TE critical for calibration)

Primary Standards	ID #	Cal Date (Certificate No.)	Scheduled Calibration
Power meter EPM-442A	GB37480704	07-Oct-14 (No. 217-02020)	Oct-15
Power sensor HP 8481A	US37292783	07-Oct-14 (No. 217-02020)	Oct-15
Power sensor HP 8481A	MY41092317	07-Oct-14 (No. 217-02021)	Oct-15
Reference 10 dB Attenuator	SN: 5047.2 / 06327	01-Apr-15 (No. 217-02130)	Mar-16
Probe ER3DV6	SN: 2336	31-Dec-14 (No. ER3-2336_Dec14)	Dec-15
Probe H3DV6	SN: 6065	31-Dec-14 (No. H3-6065_Dec14)	Dec-15
DAE4	SN: 781	12-Sep-14 (No. DAE4-781_Sep14)	Sep-15
Secondary Standards	ID #	Check Date (in house)	Scheduled Check
Power meter Agilent 4419B	SN: GB42420191	09-Oct-09 (in house check Sep-14)	In house check: Sep-16
Power sensor HP E4412A	SN: US38485102	05-Jan-10 (in house check Sep-14)	In house check: Sep-16
Power sensor HP 8482A	SN: US37295597	09-Oct-09 (in house check Sep-14)	In house check: Sep-16
Network Analyzer HP 8753E	US37390585	18-Oct-01 (in house check Oct-14)	In house check: Oct-15
RF generator R&S SMT-06	SN: 832283/011	27-Aug-12 (in house check Oct-13)	In house check: Oct-16

	Name	Function	Signature
Calibrated by:	Israe Elnaouq	Laboratory Technician	
Approved by:	Fin Bomholt	Deputy Technical Manager	

Issued: May 27, 2015

This calibration certificate shall not be reproduced except in full without written approval of the laboratory.



Accredited by the Swiss Accreditation Service (SAS)
**The Swiss Accreditation Service is one of the signatories to the EA
Multilateral Agreement for the recognition of calibration certificates**

Accreditation No.: SCS 0108

References

- [1] ANSI-C63.19-2011
American National Standard, Methods of Measurement of Compatibility between Wireless Communications Devices and Hearing Aids.

Methods Applied and Interpretation of Parameters:

- *Coordinate System:* y-axis is in the direction of the dipole arms. z-axis is from the basis of the antenna (mounted on the table) towards its feed point between the two dipole arms. x-axis is normal to the other axes. In coincidence with the standards [1], the measurement planes (probe sensor center) are selected to be at a distance of 15 mm above the top metal edge of the dipole arms.
- *Measurement Conditions:* Further details are available from the hardcopies at the end of the certificate. All figures stated in the certificate are valid at the frequency indicated. The forward power to the dipole connector is set with a calibrated power meter connected and monitored with an auxiliary power meter connected to a directional coupler. While the dipole under test is connected, the forward power is adjusted to the same level.
- *Antenna Positioning:* The dipole is mounted on a HAC Test Arch phantom using the matching dipole positioner with the arms horizontal and the feeding cable coming from the floor. The measurements are performed in a shielded room with absorbers around the setup to reduce the reflections. It is verified before the mounting of the dipole under the Test Arch phantom, that its arms are perfectly in a line. It is installed on the HAC dipole positioner with its arms parallel below the dielectric reference wire and able to move elastically in vertical direction without changing its relative position to the top center of the Test Arch phantom. The vertical distance to the probe is adjusted after dipole mounting with a DASY5 Surface Check job. Before the measurement, the distance between phantom surface and probe tip is verified. The proper measurement distance is selected by choosing the matching section of the HAC Test Arch phantom with the proper device reference point (upper surface of the dipole) and the matching grid reference point (tip of the probe) considering the probe sensor offset. The vertical distance to the probe is essential for the accuracy.
- *Feed Point Impedance and Return Loss:* These parameters are measured using a HP 8753E Vector Network Analyzer. The impedance is specified at the SMA connector of the dipole. The influence of reflections was eliminated by applying the averaging function while moving the dipole in the air, at least 70cm away from any obstacles.
- *E-field distribution:* E field is measured in the x-y-plane with an isotropic ER3D-field probe with 100 mW forward power to the antenna feed point. In accordance with [1], the scan area is 20mm wide, its length exceeds the dipole arm length (180 or 90mm). The sensor center is 15 mm (in z) above the metal top of the dipole arms. Two 3D maxima are available near the end of the dipole arms. Assuming the dipole arms are perfectly in one line, the average of these two maxima (in subgrid 2 and subgrid 8) is determined to compensate for any non-parallelity to the measurement plane as well as the sensor displacement. The E-field value stated as calibration value represents the maximum of the interpolated 3D-E-field, in the plane above the dipole surface.

The reported uncertainty of measurement is stated as the standard uncertainty of measurement multiplied by the coverage factor $k=2$, which for a normal distribution corresponds to a coverage probability of approximately 95%.

Measurement Conditions

DASY system configuration, as far as not given on page 1.

DASY Version	DASY5	V52.8.8
Phantom	HAC Test Arch	
Distance Dipole Top - Probe Center	15 mm	
Scan resolution	dx, dy = 5 mm	
Frequency	1880 MHz \pm 1 MHz	
Input power drift	< 0.05 dB	

Maximum Field values at 1880 MHz

E-field 15 mm above dipole surface	condition	Interpolated maximum
Maximum measured above high end	100mW input power	89.2V/m = 39.01 dBV/m
Maximum measured above low end	100mW input power	89.0V/m = 38.98 dBV/m
Averaged maximum above arm	100mW input power	89.1V/m \pm 12.8 % (k=2)

Appendix (Additional assessments outside the scope of SCS 0108)

Antenna Parameters

Frequency	Return Loss	Impedance
1730 MHz	38.0 dB	51.1 Ω + 0.6 j Ω
1880 MHz	19.0 dB	45.1 Ω + 9.5 j Ω
1900 MHz	19.8 dB	47.7 Ω + 9.8 j Ω
1950 MHz	25.4 dB	51.6 Ω + 5.2 j Ω
2000 MHz	21.9 dB	44.0 Ω + 4.6 j Ω

3.2 Antenna Design and Handling

The calibration dipole has a symmetric geometry with a built-in two stub matching network, which leads to the enhanced bandwidth.

The dipole is built of standard semirigid coaxial cable. The internal matching line is open ended. The antenna is therefore open for DC signals.

Do not apply force to dipole arms, as they are liable to bend. The soldered connections near the feedpoint may be damaged. After excessive mechanical stress or overheating, check the impedance characteristics to ensure that the internal matching network is not affected.

After long term use with 40W radiated power, only a slight warming of the dipole near the feedpoint can be measured.

Impedance Measurement Plot

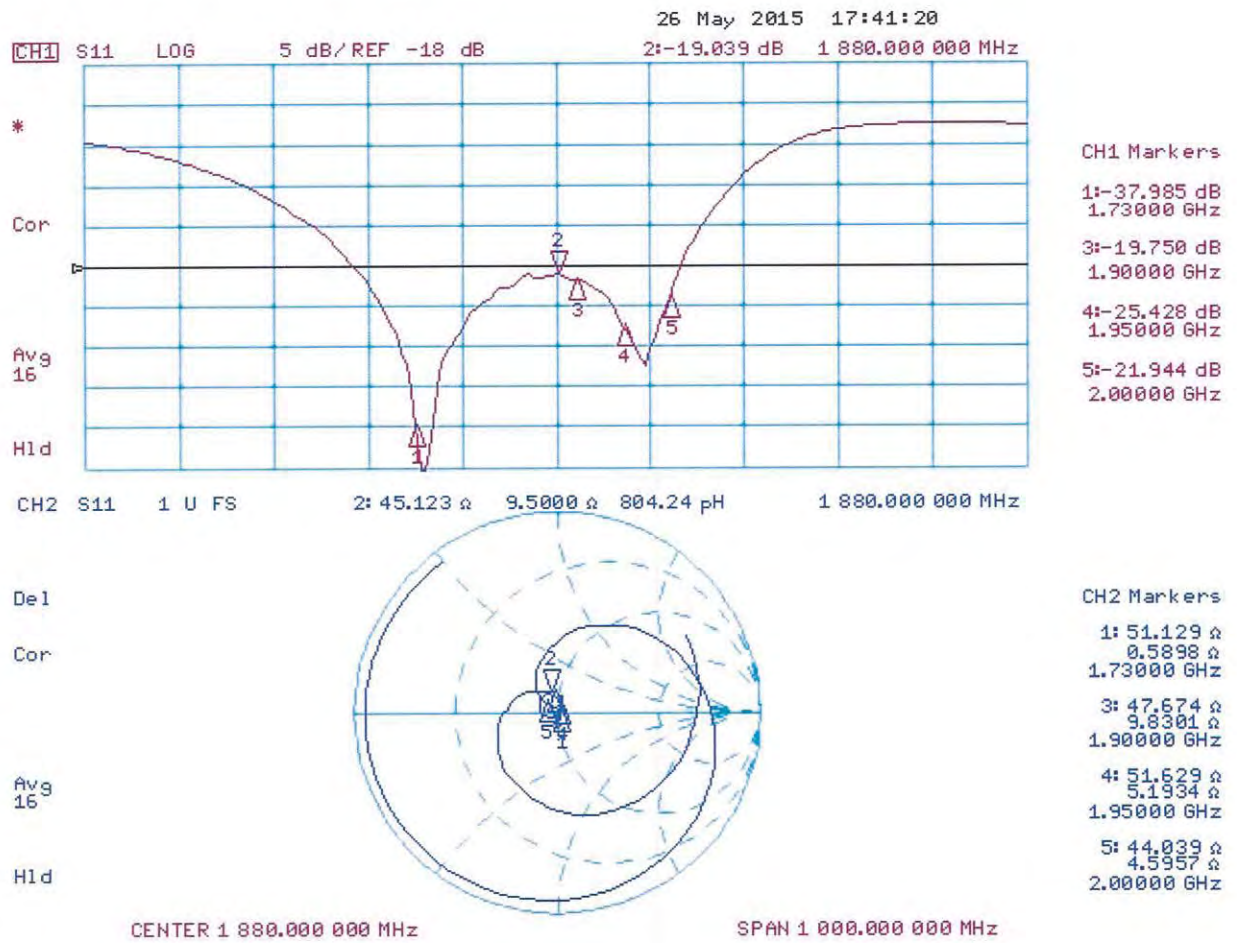

DASY5 E-field Result

Date: 26.05.2015

Test Laboratory: SPEAG Lab2

DUT: HAC Dipole 1880 MHz; Type: CD1880V3; Serial: CD1880V3 - SN: 1117

Communication System: UID 0 - CW; Frequency: 1880 MHz
 Medium parameters used: $\sigma = 0$ S/m, $\epsilon_r = 1$; $\rho = 1000$ kg/m³
 Phantom section: RF Section
 Measurement Standard: DASY5 (IEEE/IEC/ANSI C63.19-2011)

DASY52 Configuration:

- Probe: ER3DV6 - SN2336; ConvF(1, 1, 1); Calibrated: 31.12.2014;
- Sensor-Surface: (Fix Surface)
- Electronics: DAE4 Sn781; Calibrated: 12.09.2014
- Phantom: HAC Test Arch with AMCC; Type: SD HAC P01 BA; Serial: 1070
- DASY52 52.8.8(1222); SEMCAD X 14.6.10(7331)

Reference Dipole E-Field measurement @ 1880MHz/E-Scan - 1880MHz d=15mm/Hearing Aid Compatibility Test (41x181x1): Interpolated grid: dx=0.5000 mm, dy=0.5000 mm
 Device Reference Point: 0, 0, -6.3 mm
 Reference Value = 138.7 V/m; Power Drift = 0.02 dB
 Applied MIF = 0.00 dB
 RF audio interference level = 39.01 dBV/m
Emission category: M2

MIF scaled E-field

Grid 1 M2 38.79 dBV/m	Grid 2 M2 38.98 dBV/m	Grid 3 M2 38.83 dBV/m
Grid 4 M2 36.58 dBV/m	Grid 5 M2 36.76 dBV/m	Grid 6 M2 36.71 dBV/m
Grid 7 M2 38.84 dBV/m	Grid 8 M2 39.01 dBV/m	Grid 9 M2 38.9 dBV/m

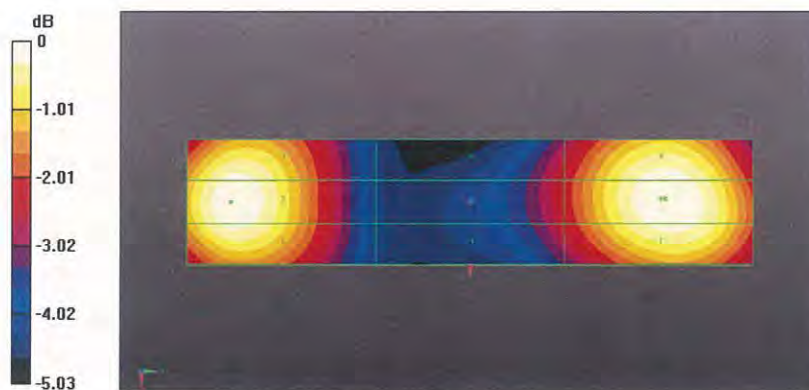

0 dB = 89.24 V/m = 39.01 dBV/m