



中认信通

CHINA CERTIFICATION ICT CO.,LTD (DONGGUAN)



TEST REPORT

Applicant: JEM ACCESSORIES INC.

Address: 32 Brunswick Avenue, Edison, New Jersey, United States,08817

FCC ID: 2AHAS-XLP71009

Product Name: 5 in 1 Lamp & Wireless charger

**Standard(s): 47 CFR Part 15, Subpart C
ANSI C63.10-2013**

The above device has been tested and found compliant with the requirement of the relative standards by China Certification ICT Co., Ltd (Dongguan)

Report Number: CR230953507-00

Date Of Issue: 2024/1/10

Reviewed By: Calvin Chen

Title: RF Engineer

Approved By: Sun Zhong

Title: Manager

Test Laboratory: China Certification ICT Co., Ltd (Dongguan)

No. 113, Pingkang Road, Dalang Town, Dongguan,

Guangdong, China

Tel: +86-769-82016888

Test Facility

The Test site used by China Certification ICT Co., Ltd (Dongguan) to collect test data is located on the No. 113, Pingkang Road, Dalang Town, Dongguan, Guangdong, China.

The lab has been recognized as the FCC accredited lab under the KDB 974614 D01 and is listed in the FCC Public Access Link (PAL) database, FCC Registration No. : 442868, the FCC Designation No. : CN1314.

Declarations

China Certification ICT Co., Ltd (Dongguan) is not responsible for the authenticity of any test data provided by the applicant. Data included from the applicant that may affect test results are marked with a triangle symbol “▲”. Customer model name, addresses, names, trademarks etc. are not considered data.

Unless otherwise stated the results shown in this test report refer only to the sample(s) tested.

This report cannot be reproduced except in full, without prior written approval of the Company.

This report is valid only with a valid digital signature. The digital signature may be available only under the Adobe software above version 7.0.

This report may contain data that are not covered by the accreditation scope and shall be marked with an asterisk “★”.

CONTENTS

DOCUMENT REVISION HISTORY	4
1. GENERAL INFORMATION.....	5
1.1 PRODUCT DESCRIPTION FOR EQUIPMENT UNDER TEST (EUT)	5
1.2 DESCRIPTION OF TEST CONFIGURATION	6
1.2.1 EUT Operation Condition:.....	6
1.2.2 Support Equipment List and Details	6
1.2.3 Support Cable List and Details	6
1.2.4 Block Diagram of Test Setup.....	7
1.3 MEASUREMENT UNCERTAINTY	13
2. SUMMARY OF TEST RESULTS	14
3. REQUIREMENTS AND TEST PROCEDURES	15
3.1 AC LINE CONDUCTED EMISSIONS	15
3.1.1 Applicable Standard.....	15
3.1.2 EUT Setup.....	16
3.1.3 EMI Test Receiver Setup	16
3.1.4 Test Procedure	17
3.1.5 Corrected Amplitude & Margin Calculation.....	17
3.2 RADIATION SPURIOUS EMISSIONS	18
3.2.1 Applicable Standard.....	18
3.2.2 EUT Setup.....	18
3.2.3 EMI Test Receiver & Spectrum Analyzer Setup	19
3.2.4 Corrected Amplitude & Margin Calculation.....	20
3.3 20 DB EMISSION BANDWIDTH:	21
3.3.1 Applicable Standard.....	21
3.3.2 EUT Setup.....	21
3.3.3 Test Procedure	21
3.4 ANTENNA REQUIREMENT	22
3.4.1 Applicable Standard.....	22
3.4.2 Judgment.....	22
4. TEST DATA AND RESULTS.....	23
4.1 AC LINE CONDUCTED EMISSIONS	23
4.2 RADIATION SPURIOUS EMISSIONS	36
4.3 20 DB EMISSION BANDWIDTH	85
5 MAXIMUM PERMISSIBLE EXPOSURE (MPE)	87
5.1 APPLICABLE STANDARD.....	87
5.2 BLOCK DIAGRAM OF TEST SETUP	88
5.3 TEST PROCEDURES	89
5.4 TEST DATA:	90
6. EUT PHOTOGRAPHS	94
7. TEST SETUP PHOTOGRAPHS	95

DOCUMENT REVISION HISTORY

Revision Number	Report Number	Description of Revision	Date of Revision
1.0	CR230953507-00	Original Report	2024/1/10

1. GENERAL INFORMATION

1.1 Product Description for Equipment under Test (EUT)

EUT Name:	5 in 1 Lamp & Wireless charger
EUT Model:	XLP7-1009-BLK
Multiple Models:	XLP7-1009-QV1, XLP7-1009
Operation Frequency:	Airpods: 131.32 kHz Phone horizontal: 127.33 kHz Phone vertical: 127.35kHz
Rated Input Voltage:	DC 5V/3A or DC 9V 2.22A or DC 12V 1.67A
Wireless Output:	Airpods: 3Watts Phone: 5/7.5/10/15Watts
Serial Number:	2B5B-2
Product Number:	014272
EUT Received Date:	2023/9/13
EUT Received Status:	Good
Note: The Multiple models are electrically identical with the test model. Please refer to the declaration letter for more detail, which was provided by manufacturer.	

Antenna Information Detail ▲:

Antenna	Antenna Type	input impedance (Ohm)	Frequency Range	Antenna Gain
Phone horizontal	Coil	Unknown	110-205 kHz	Unknown
Phone vertical	Coil	Unknown	110-205 kHz	Unknown
Airpods	Coil	Unknown	110-205 kHz	Unknown

The Method of §15.203 Compliance:

- Antenna was permanently attached to the unit.
 Antenna use a unique type of connector to attach to the EUT.
 Unit was professionally installed, and installer shall be responsible for verifying that the correct antenna is employed with the unit.

Accessory Information:

Accessory Description	Manufacturer	Model
Adapter	Unknown	XHC8-1028

1.2 Description of Test Configuration

1.2.1 EUT Operation Condition:

EUT Operation Mode:	<p>The system was configured for testing in normal use Mode, which was provided by the manufacturer.</p> <p>The EUT support max 3 Watts wireless output for Airpods, max 15 Watts wireless output for Phone horizontal or Phone vertical. Airpods and Phone horizontal or Phone vertical can simultaneous transmission. Phone horizontal and Phone vertical cannot simultaneous transmission. Select the following mode to test.</p> <p>Test Mode: M1: Light on+Wireless Charging(Phone horizontal 15W) M2: Wireless Charging(Phone horizontal 15W)+Airpods Wireless Charging(3W) M3: Light on+Airpods Wireless Charging(3W)+Type C Charging+USB Charging M4: Wireless Charging(Phone horizontal 15W)+Type C Charging M5: Wireless Charging(Phone horizontal 15W)+ USB Charging M6: Wireless Charging(Phone vertical 15W)+ Type C Charging</p> <p>For M6, worst mode from M1, M2, M4, M5 is M4, so select Wireless Charging(Phone vertical 15W)+ Type C Charging to test</p>
Equipment Modifications:	No
EUT Exercise Software:	No

1.2.2 Support Equipment List and Details

Manufacturer	Description	Model	Serial Number
Apple	iPhone	iPhone 13	JYK4T4LQNK
Unknown	Load 1	20W	/
Unknown	Load 2	20W	/
NANK	Earphone	A2	/

1.2.3 Support Cable List and Details

Cable Description	Shielding Type	Ferrite Core	Length (m)	From Port	To
USB Cable	Yes	No	1	EUT	Adapter
USB Cable	No	No	0.8	EUT	Load 1
USB Cable	No	No	0.8	EUT	Load 2

1.2.4 Block Diagram of Test Setup

AC line conducted emissions:

M1:

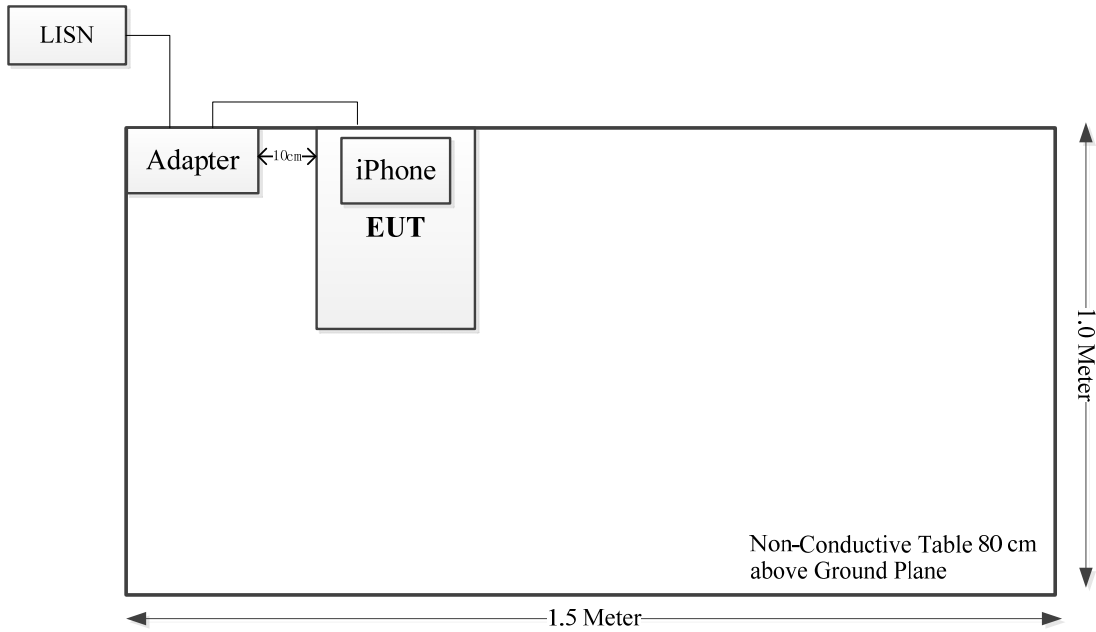

M2:

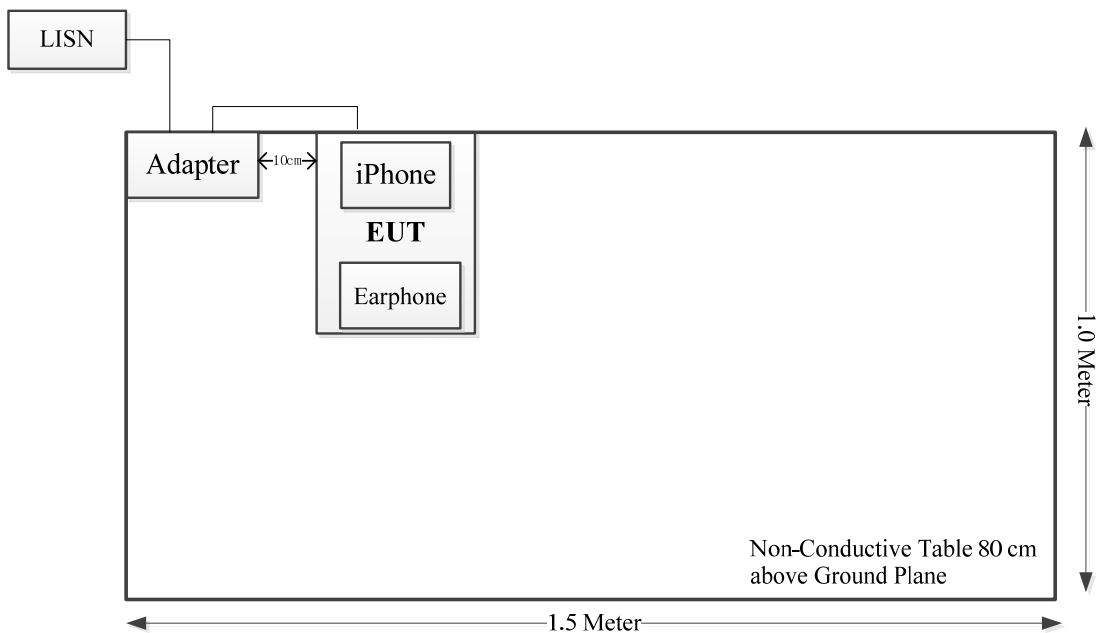

M3:

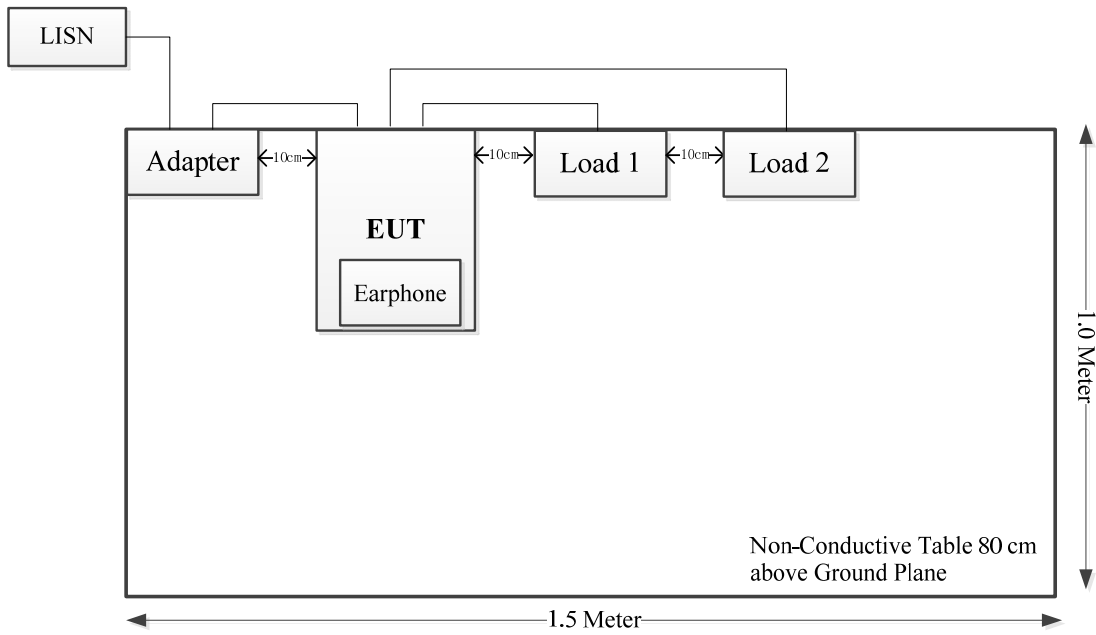

M4:

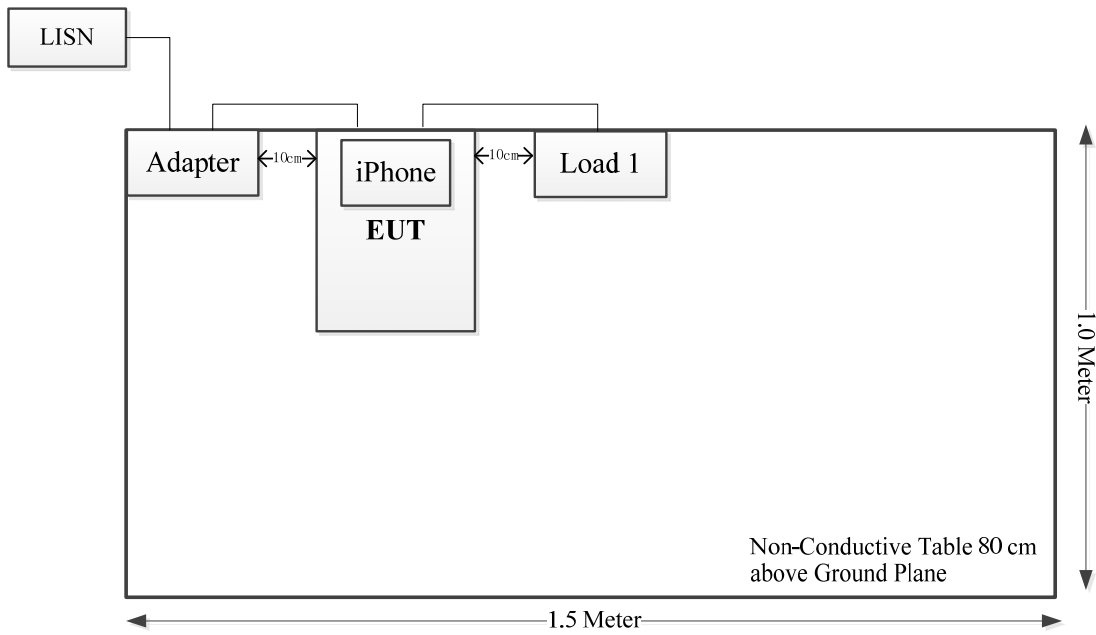

M5:

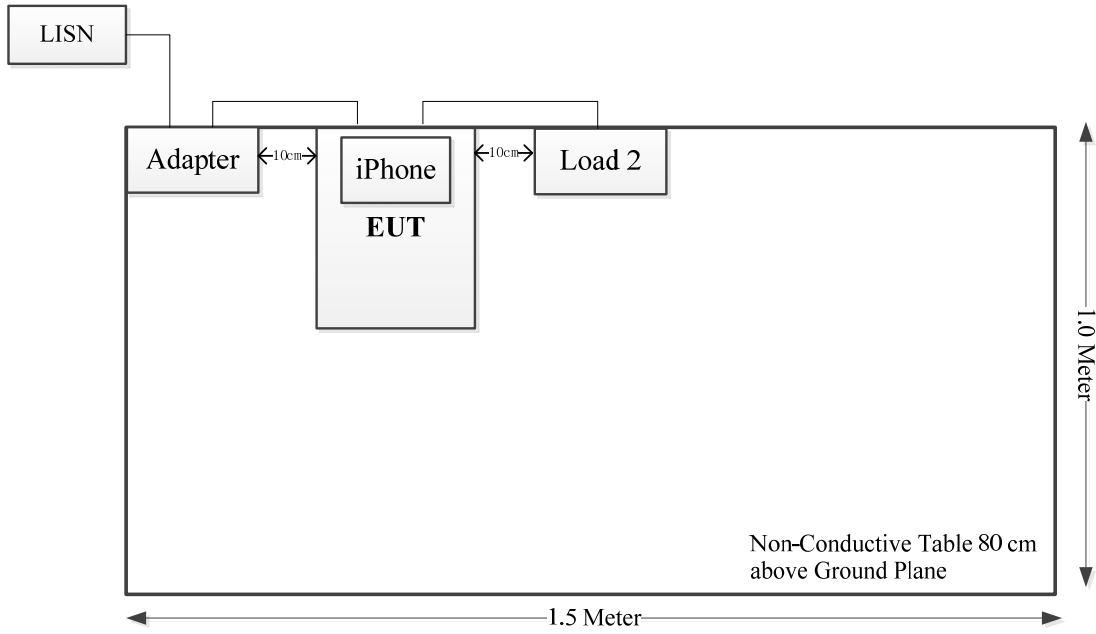

M6:

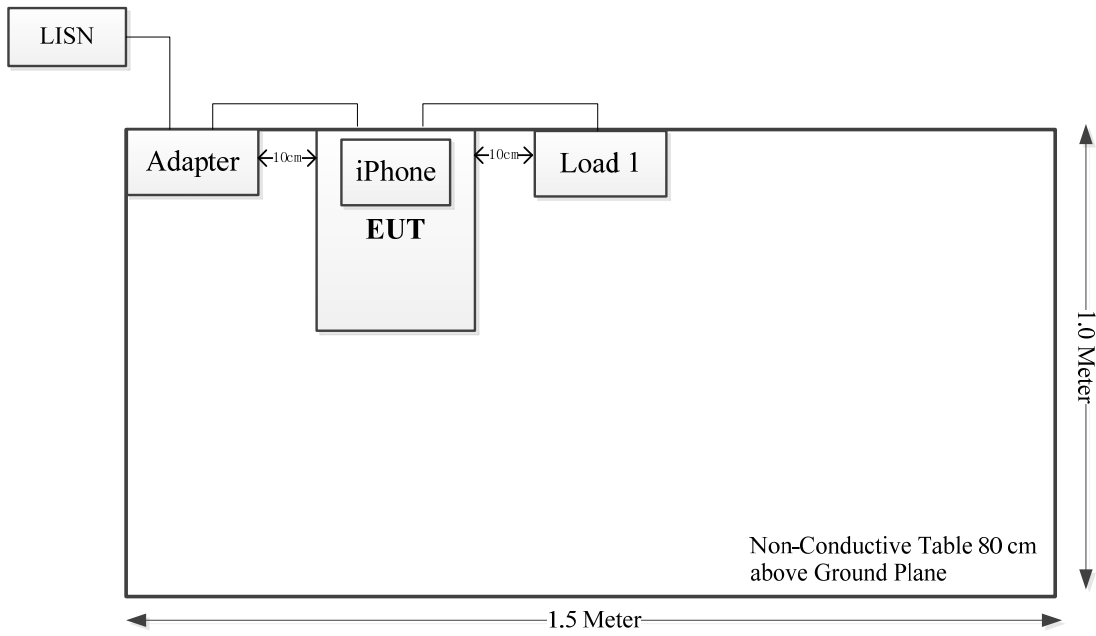

Radiated Emission:

M1:

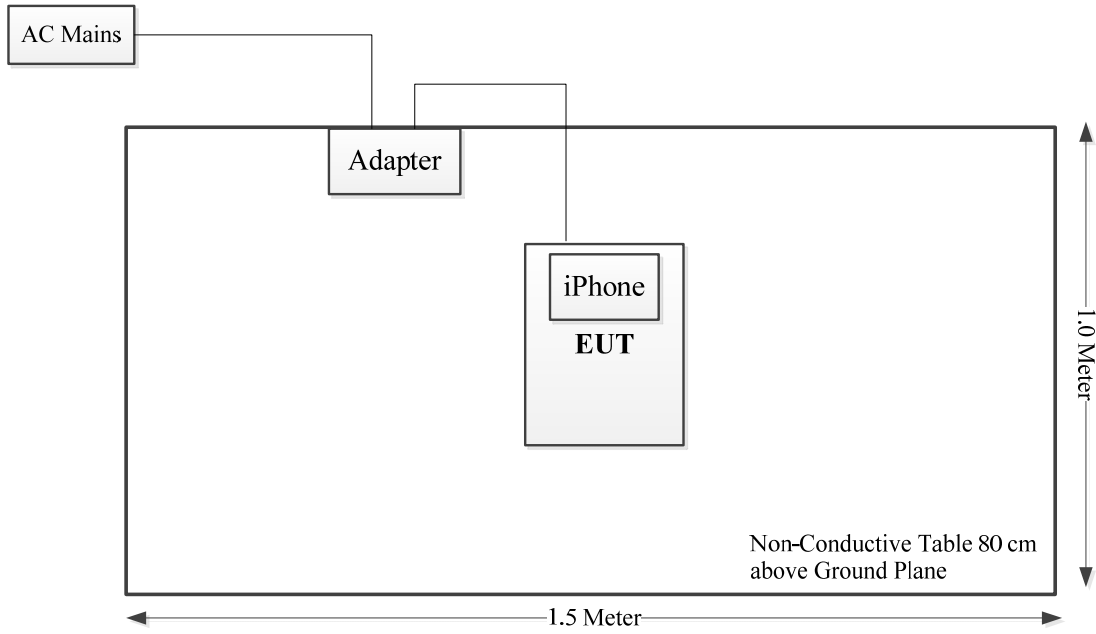

M2:

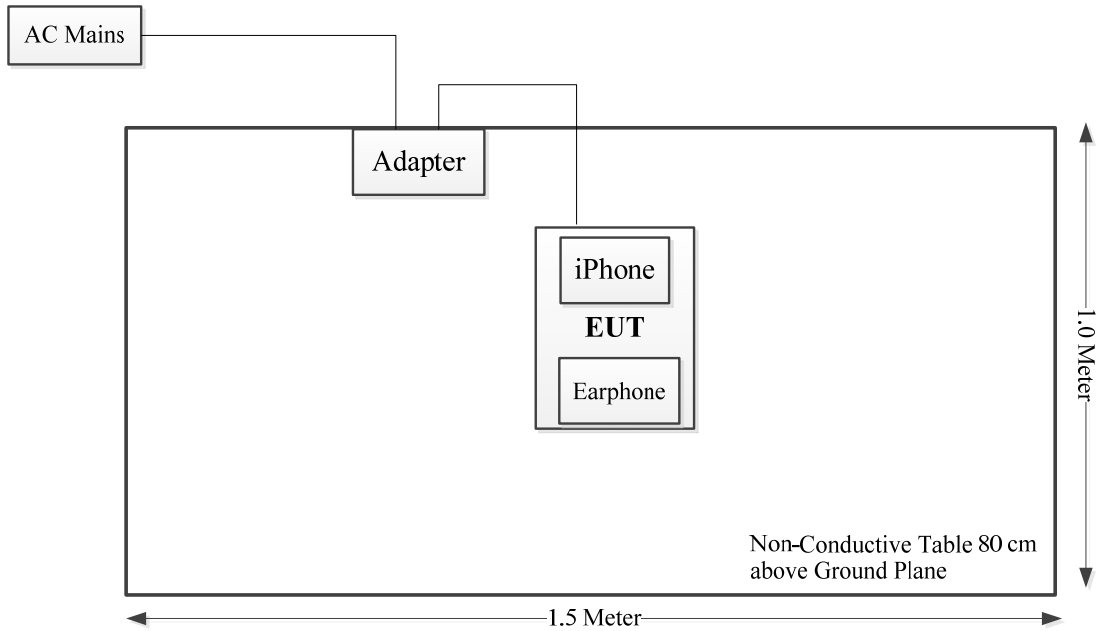

M3:

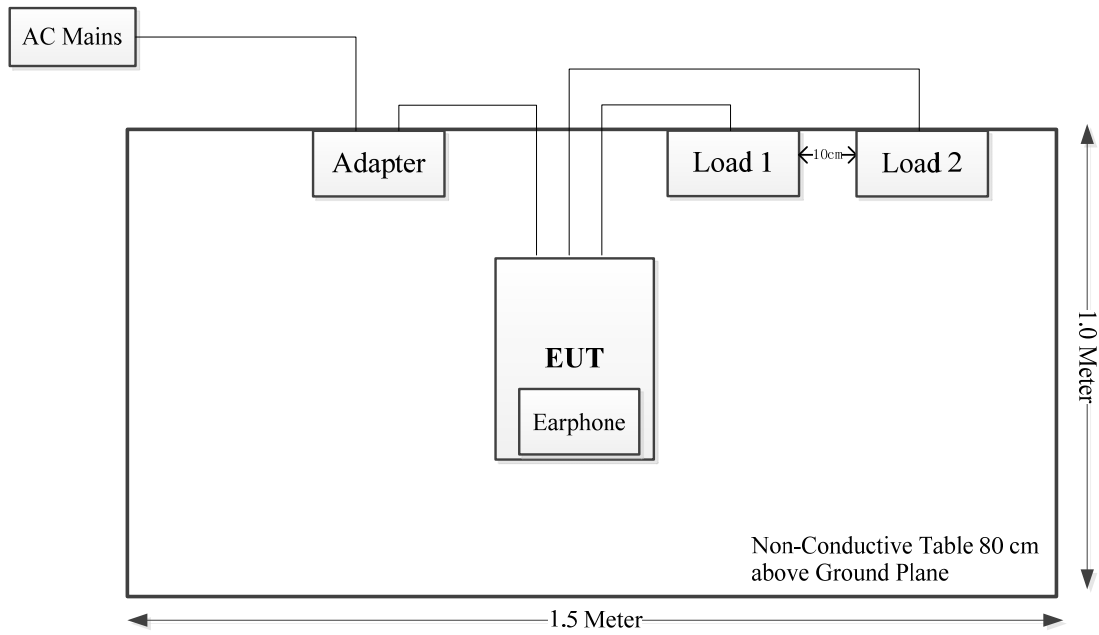

M4:

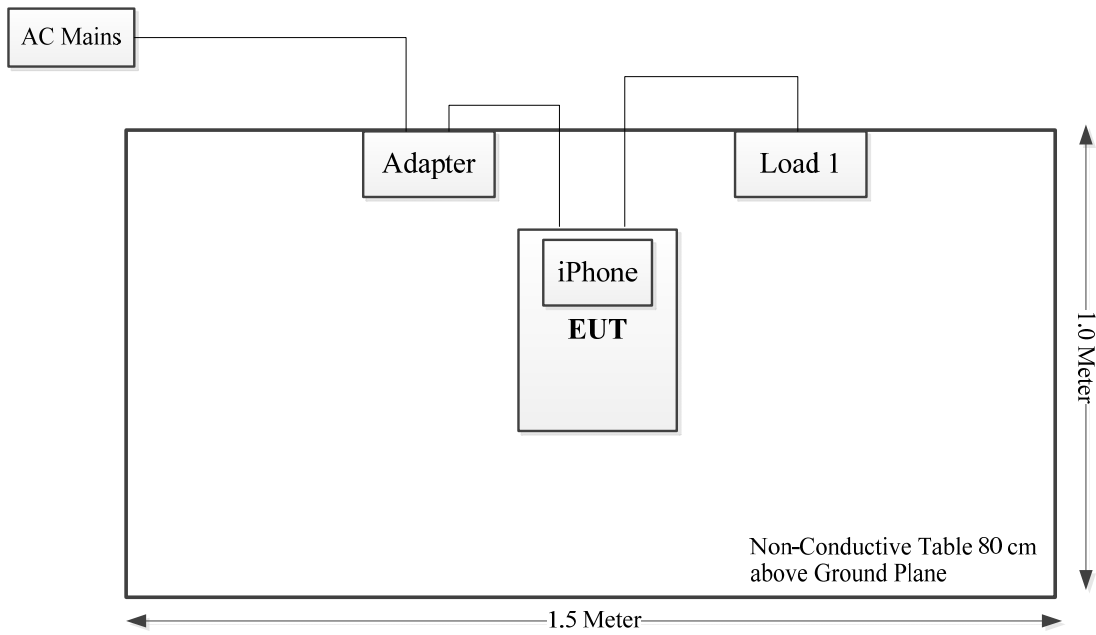

M5:

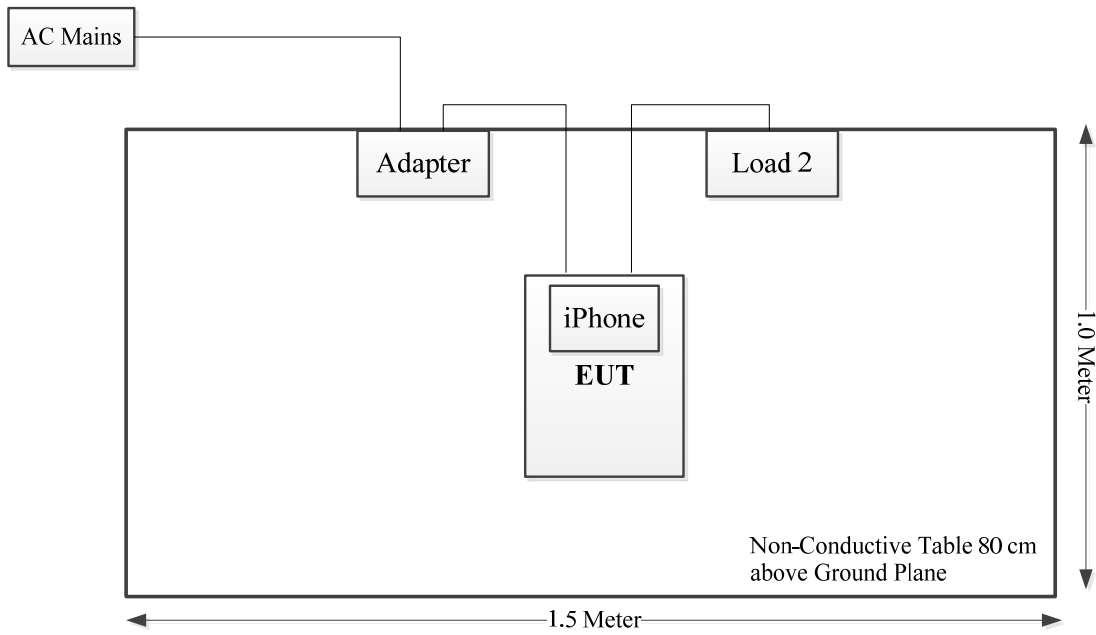

M6:

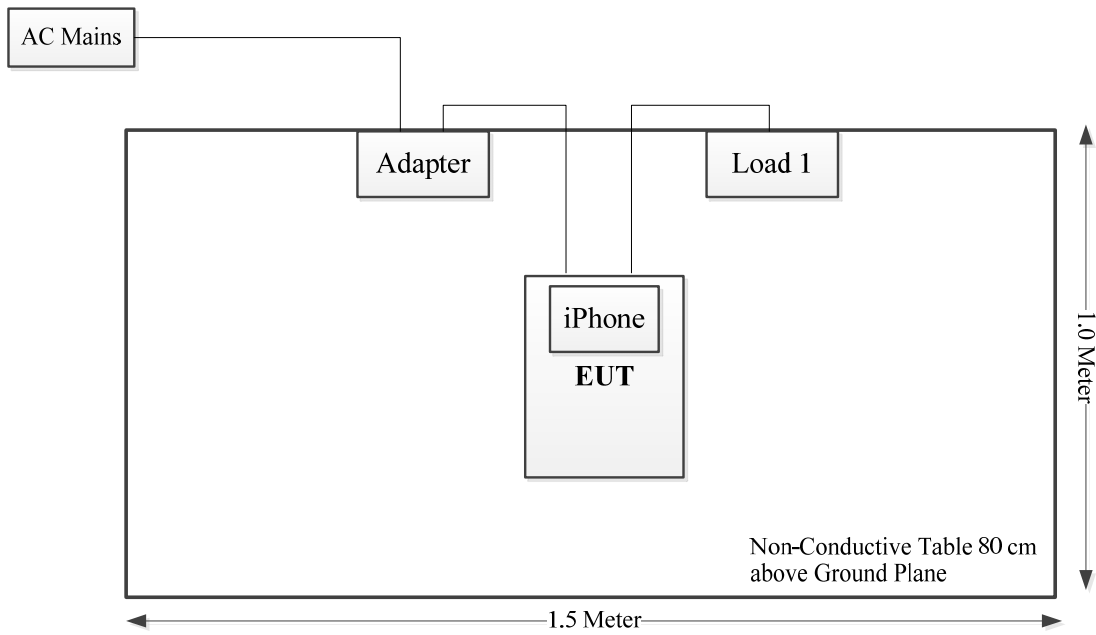

1.3 Measurement Uncertainty

Otherwise required by the applicant or Product Regulations, Decision Rule in this report did not consider the uncertainty. The extended uncertainty given in this report is obtained by combining the standard uncertainty times the coverage factor K with the 95% confidence interval.

Parameter	Measurement Uncertainty
radiated Emissions	9kHz~30MHz: 4.12dB 30M~200MHz: 4.15 dB,200M~1GHz: 5.61 dB,1G~6GHz: 5.14 dB, 6G~18GHz: 5.93 dB,18G~26.5G:5.47 dB,26.5G~40G:5.63 dB
Temperature	±1℃
Humidity	±5%
DC and low frequency voltages	±0.4%
Duty Cycle	1%
AC Power Lines Conducted Emission	2.8 dB (150 kHz to 30 MHz)

2. SUMMARY OF TEST RESULTS

Standard(s) Section	Description of Test	Result
FCC§15.207	AC Line Conducted Emission	Compliant
FCC§15.209 §15.205	Radiated Emission Test	Compliant
FCC§15.215	20 dB Emission Bandwidth	Compliant
FCC§15.203	Antenna Requirement	Compliant
FCC§1.1310 §2.1091	Maximum Permissible Exposure (MPE)	Compliant

3. REQUIREMENTS AND TEST PROCEDURES

3.1 AC Line Conducted Emissions

3.1.1 Applicable Standard

FCC§15.207(a).

(a) Except as shown in paragraphs (b) and (c) of this section, for an intentional radiator that is designed to be connected to the public utility (AC) power line, the radio frequency voltage that is conducted back onto the AC power line on any frequency or frequencies, within the band 150 kHz to 30 MHz, shall not exceed the limits in the following table, as measured using a 50 μ H/50 ohms line impedance stabilization network (LISN). Compliance with the provisions of this paragraph shall be based on the measurement of the radio frequency voltage between each power line and ground at the power terminal. The lower limit applies at the boundary between the frequency ranges.

Frequency of emission (MHz)	Conducted limit (dB μ V)	
	Quasi-peak	Average
0.15-0.5	66 to 56*	56 to 46*
0.5-5	56	46
5-30	60	50

*Decreases with the logarithm of the frequency.

(b) The limit shown in paragraph (a) of this section shall not apply to carrier current systems operating as intentional radiators on frequencies below 30 MHz. In lieu thereof, these carrier current systems shall be subject to the following standards:

(1) For carrier current system containing their fundamental emission within the frequency band 535-1705 kHz and intended to be received using a standard AM broadcast receiver: no limit on conducted emissions.

(2) For all other carrier current systems: 1000 μ V within the frequency band 535-1705 kHz, as measured using a 50 μ H/50 ohms LISN.

(3) Carrier current systems operating below 30 MHz are also subject to the radiated emission limits in §15.205, §15.209, §15.221, §15.223, or §15.227, as appropriate.

(c) Measurements to demonstrate compliance with the conducted limits are not required for devices which only employ battery power for operation and which do not operate from the AC power lines or contain provisions for operation while connected to the AC power lines. Devices that include, or make provisions for, the use of battery chargers which permit operating while charging, AC adapters or battery eliminators or that connect to the AC power lines indirectly, obtaining their power through another device which is connected to the AC power lines, shall be tested to demonstrate compliance with the conducted limits.

3.1.2 EUT Setup

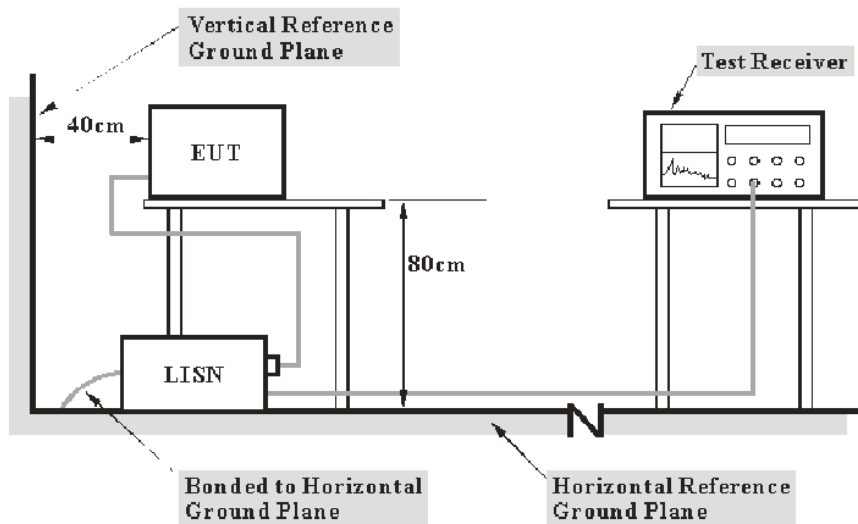

- Note: 1. Support units were connected to second LISN.
 2. Both of LISNs (AMN) 80 cm from EUT and at the least 80 cm from other units and other metal planes support units.

The setup of EUT is according with per ANSI C63.10-2013 measurement procedure. The specification used was with the FCC Part 15.207 limits.

The spacing between the peripherals was 10 cm.

3.1.3 EMI Test Receiver Setup

The EMI test receiver was set to investigate the spectrum from 150 kHz to 30 MHz.

During the conducted emission test, the EMI test receiver was set with the following configurations:

Frequency Range	IF B/W
150 kHz – 30 MHz	9 kHz

3.1.4 Test Procedure

The frequency and amplitude of the six highest ac power-line conducted emissions relative to the limit, measured over all the current-carrying conductors of the EUT power cords, and the operating frequency or frequency to which the EUT is tuned (if appropriate), should be reported, unless such emissions are more than 20 dB below the limit. AC power-line conducted emissions measurements are to be separately carried out only on each of the phase (“hot”) line(s) and (if used) on the neutral line(s), but not on the ground [protective earth] line(s). If less than six emission frequencies are within 20 dB of the limit, then the noise level of the measuring instrument at representative frequencies should be reported. The specific conductor of the power-line cord for each of the reported emissions should be identified. Measure the six highest emissions with respect to the limit on each current-carrying conductor of each power cord associated with the EUT (but not the power cords of associated or peripheral equipment that are part of the test configuration). Then, report the six highest emissions with respect to the limit from among all the measurements identifying the frequency and specific current-carrying conductor identified with the emission. The six highest emissions should be reported for each of the current-carrying conductors, or the six highest emissions may be reported over all the current-carrying conductors.

3.1.5 Corrected Amplitude & Margin Calculation

The basic equation is as follows:

$$\text{Result} = \text{Reading} + \text{Factor}$$

$$\text{Factor} = \text{attenuation caused by cable loss} + \text{voltage division factor of AMN}$$

The “**Margin**” column of the following data tables indicates the degree of compliance within the applicable limit. The equation for margin calculation is as follows:

$$\text{Margin} = \text{Limit} - \text{Result}$$

3.2 Radiation Spurious Emissions

3.2.1 Applicable Standard

FCC §15.209

(a) Except as provided elsewhere in this subpart, the emissions from an intentional radiator shall not exceed the field strength levels specified in the following table:

Frequency (MHz)	Field strength (microvolts/meter)	Measurement distance (meters)
0.009-0.490	2400/F(kHz)	300
0.490-1.705	24000/F(kHz)	30
1.705-30.0	30	30
30-88	100**	3
88-216	150**	3
216-960	200**	3
Above 960	500	3

**Except as provided in paragraph (g), fundamental emissions from intentional radiators operating under this section shall not be located in the frequency bands 54-72 MHz, 76-88 MHz, 174-216 MHz or 470-806 MHz. However, operation within these frequency bands is permitted under other sections of this part, e.g., §§15.231 and 15.241.

3.2.2 EUT Setup

9kHz-30MHz:

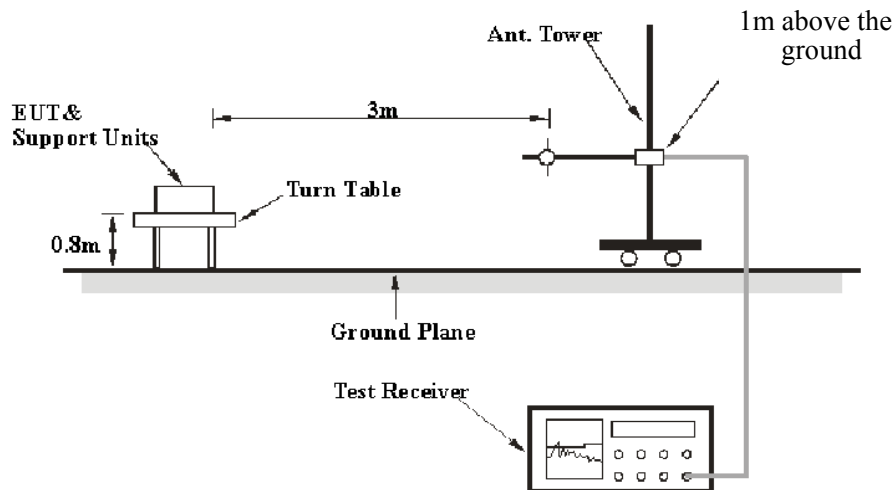

30MHz-1GHz:

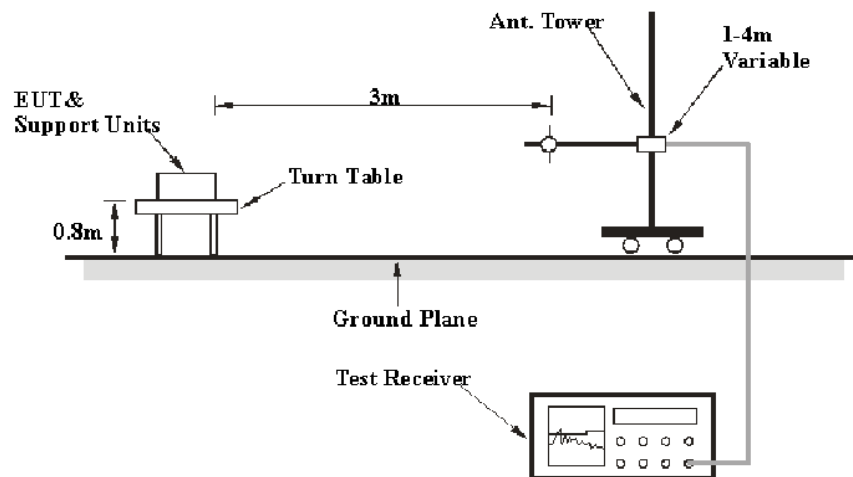

The radiated emission tests were performed in the 3-meter chamber test site, using the setup accordance with the ANSI C63.10-2013. The specification used was the FCC 15.209 limits.

The spacing between the peripherals was 10 cm.

For 9kHz-30MHz test, the lowest height of the magnetic antenna shall be 1 m above the ground and three antenna orientations (parallel, perpendicular, and ground-parallel) shall be measured.

3.2.3 EMI Test Receiver & Spectrum Analyzer Setup

The system was investigated from 9 kHz to 1 GHz.

During the radiated emission test, the EMI test Receiver was set with the following configurations:

Frequency Range	RBW	Video B/W	IF B/W	Measurement
9 kHz – 150 kHz	300 Hz	1 kHz	/	PK
	/	/	200 Hz	QP/AV
150 kHz – 30 MHz	10 kHz	30 kHz	/	PK
	/	/	9 kHz	QP/AV
30 MHz – 1000 MHz	100 kHz	300 kHz	/	PK
			120 kHz	QP

The emission limits shown in the above table are based on measurements employing a CISPR quasi-peak detector except for the frequency bands 9-90 kHz, 110-490 kHz, employing an average detector.

If the maximized peak measured value complies with the limit, then it is unnecessary to perform an QP/Average measurement

3.2.4 Corrected Amplitude & Margin Calculation

The basic equation is as follows:

Result = Reading + Factor

Factor = Antenna Factor + Cable Loss- Amplifier Gain

The “**Margin**” column of the following data tables indicates the degree of compliance within the applicable limit. The equation for margin calculation is as follows:

Margin = Limit – Result

3.3 20 dB Emission Bandwidth:

3.3.1 Applicable Standard

FCC §15.215

Intentional radiators operating under the alternative provisions to the general emission limits, as contained in §15.217 through § 15.257 and in Subpart E of this part, must be designed to ensure that the 20 dB bandwidth of the emission, or whatever bandwidth may otherwise be specified in the specific rule section under which the equipment operates, is contained within the frequency band designated in the rule section under which the equipment is operated. The requirement to contain the designated bandwidth of the emission within the specified frequency band includes the effects from frequency sweeping, frequency hopping and other modulation techniques that may be employed as well as the frequency stability of the transmitter over expected variations in temperature and supply voltage. If a frequency stability is not specified in the regulations, it is recommended that the fundamental emission be kept within at least the central 80% of the permitted band in order to minimize the possibility of out-of band operation.

3.3.2 EUT Setup

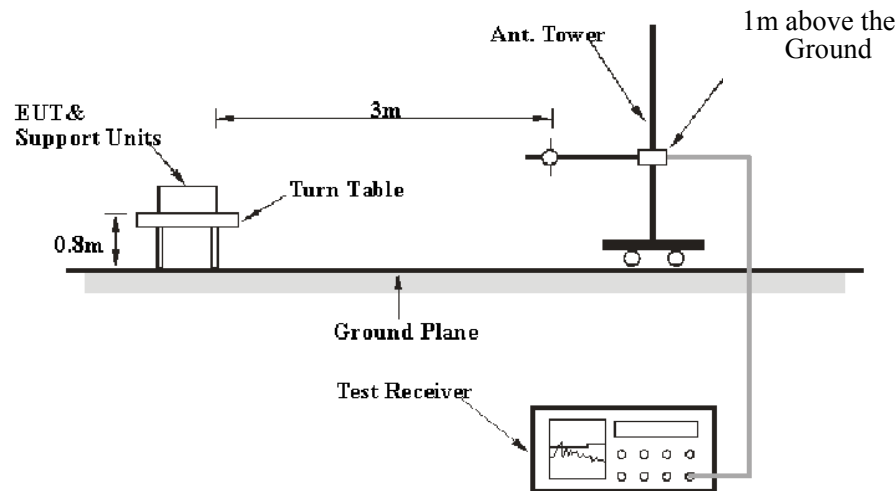

3.3.3 Test Procedure

1. Position the EUT on the test table without connection to measurement instrument. Turn on the EUT. Then set it to any one convenient frequency within its operating range. Set a reference level on the measuring instrument equal to the highest peak value.
2. Measure the frequency difference of two frequencies that were attenuated 20 dB from the reference level. Record the frequency difference as the emission bandwidth.
3. Measure the 99% Occupied bandwidth use the 99% Occupied bandwidth function of the test equipment.

3.4 Antenna Requirement

3.4.1 Applicable Standard

FCC §15.203

An intentional radiator shall be designed to ensure that no antenna other than that furnished by the responsible party shall be used with the device. The use of a permanently attached antenna or of an antenna that uses a unique coupling to the intentional radiator shall be considered sufficient to comply with the provisions of this section. The manufacturer may design the unit so that a broken antenna can be replaced by the user, but the use of a standard antenna jack or electrical connector is prohibited. This requirement does not apply to carrier current devices or to devices operated under the provisions of §§15.211, 15.213, 15.217, 15.219, 15.221, or §15.236. Further, this requirement does not apply to intentional radiators that must be professionally installed, such as perimeter protection systems and some field disturbance sensors, or to other intentional radiators which, in accordance with §15.31(d), must be measured at the installation site. However, the installer shall be responsible for ensuring that the proper antenna is employed so that the limits in this part are not exceeded.

3.4.2 Judgment

Compliant. Please refer to the Antenna Information detail in Section 1.

4. Test DATA AND RESULTS

4.1 AC Line Conducted Emissions

Serial Number:	2B5B-2	Test Date:	2023/11/21-2024/01/09
Test Site:	CE	Test Mode:	M1-M6
Tester:	David Huang	Test Result:	Pass

Environmental Conditions:

Temperature: (°C)	25.5-25.8	Relative Humidity: (%)	49-53	ATM Pressure: (kPa)	101.2-101.3
----------------------	-----------	------------------------------	-------	------------------------	-------------

Test Equipment List and Details:

Manufacturer	Description	Model	Serial Number	Calibration Date	Calibration Due Date
R&S	LISN	ENV216	101134	2023/3/31	2024/3/30
R&S	EMI Test Receiver	ESR3	102726	2023/3/31	2024/3/30
MICRO-COAX	Coaxial Cable	UTIFLEX	C-0200-01	2023/8/6	2024/8/5
Audix	Test Software	E3	190306 (V9)	N/A	N/A

* Statement of Traceability: China Certification ICT Co., Ltd (Dongguan) attests that all calibrations have been performed, traceable to National Primary Standards and International System of Units (SI).

M1:

Project No.: CR230953507-RF
 Tester: David Huang
 Port: Line
 Note: M1 Light on+Wireless Charging (Phone horizontal)

Date: 2023-12-21

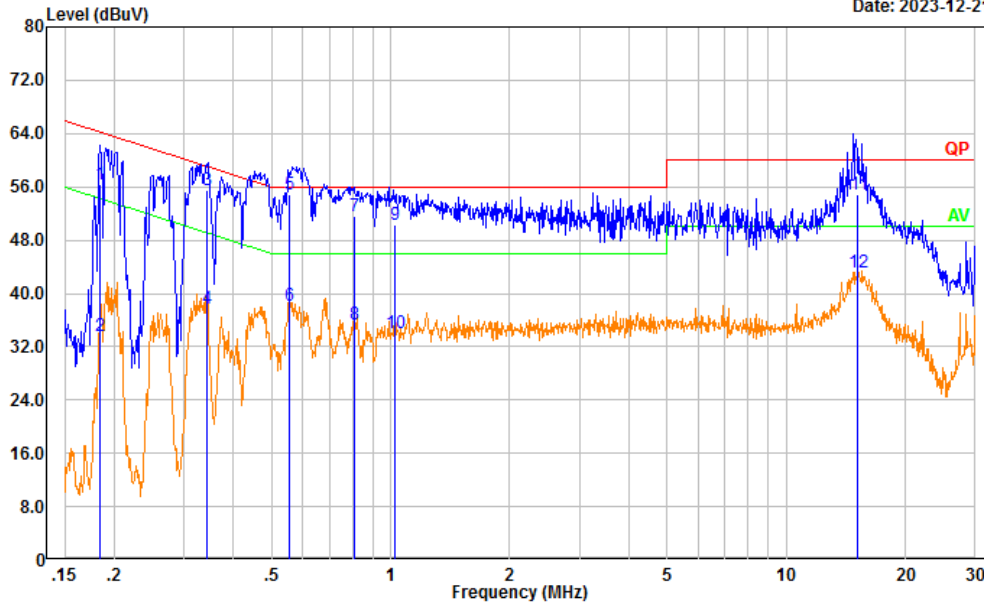

No.	Frequency (MHz)	Reading (dBμV)	Factor (dB)	Result (dBμV)	Limit (dBμV)	Margin (dB)	Detector
1	0.184	46.77	9.61	56.38	64.31	7.93	QP
2	0.184	24.05	9.61	33.66	54.31	20.65	Average
3	0.343	45.83	9.61	55.44	59.12	3.68	QP
4	0.343	28.02	9.61	37.63	49.12	11.49	Average
5	0.554	45.20	9.62	54.82	56.00	1.18	QP
6	0.554	28.57	9.62	38.19	46.00	7.81	Average
7	0.812	42.05	9.62	51.67	56.00	4.33	QP
8	0.812	25.79	9.62	35.41	46.00	10.59	Average
9	1.028	40.70	9.62	50.32	56.00	5.68	QP
10	1.028	24.38	9.62	34.00	46.00	12.00	Average
11	15.170	45.07	9.69	54.76	60.00	5.24	QP
12	15.170	33.38	9.69	43.07	50.00	6.93	Average

Project No.: CR230953507-RF
 Tester: David Huang
 Port: neutral
 Note: M1 Light on+Wireless Charging (Phone horizontal)

Date: 2023-12-21

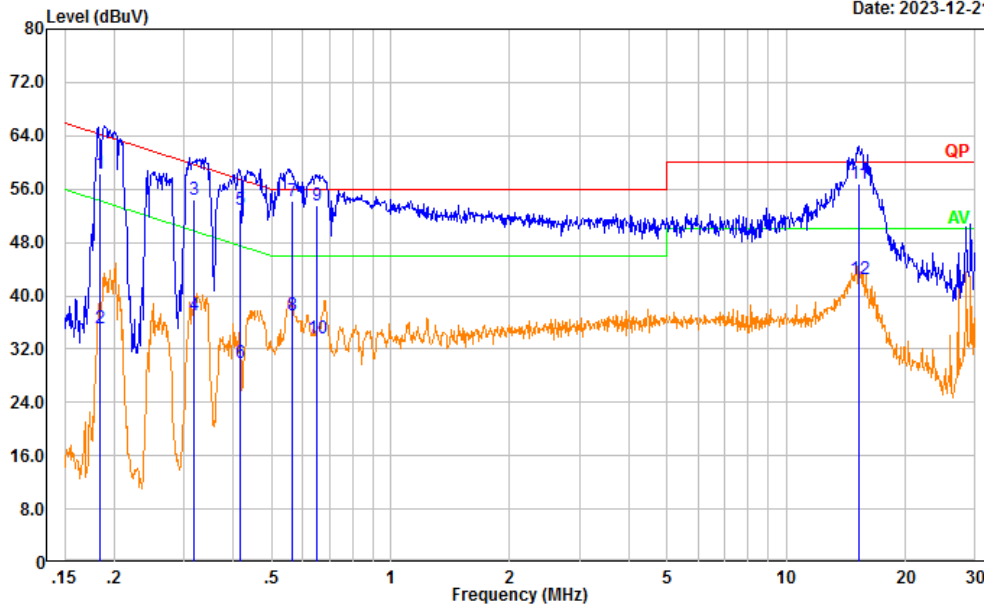

No.	Frequency (MHz)	Reading (dBμV)	Factor (dB)	Result (dBμV)	Limit (dBμV)	Margin (dB)	Detector
1	0.184	48.67	9.61	58.28	64.31	6.03	QP
2	0.184	25.42	9.61	35.03	54.31	19.28	Average
3	0.318	44.81	9.61	54.42	59.76	5.34	QP
4	0.318	27.42	9.61	37.03	49.76	12.73	Average
5	0.415	43.21	9.61	52.82	57.54	4.72	QP
6	0.415	20.39	9.61	30.00	47.54	17.54	Average
7	0.565	44.50	9.62	54.12	56.00	1.88	QP
8	0.565	27.54	9.62	37.16	46.00	8.84	Average
9	0.649	43.87	9.62	53.49	56.00	2.51	QP
10	0.649	24.03	9.62	33.65	46.00	12.35	Average
11	15.214	47.15	9.69	56.84	60.00	3.16	QP
12	15.214	32.85	9.69	42.54	50.00	7.46	Average

M2:

Project No.: CR230953507-RF
 Tester: David Huang
 Port: Line
 Note: M2 Wireless Charging (Phone horizontal) +Airpods Wireless Charging

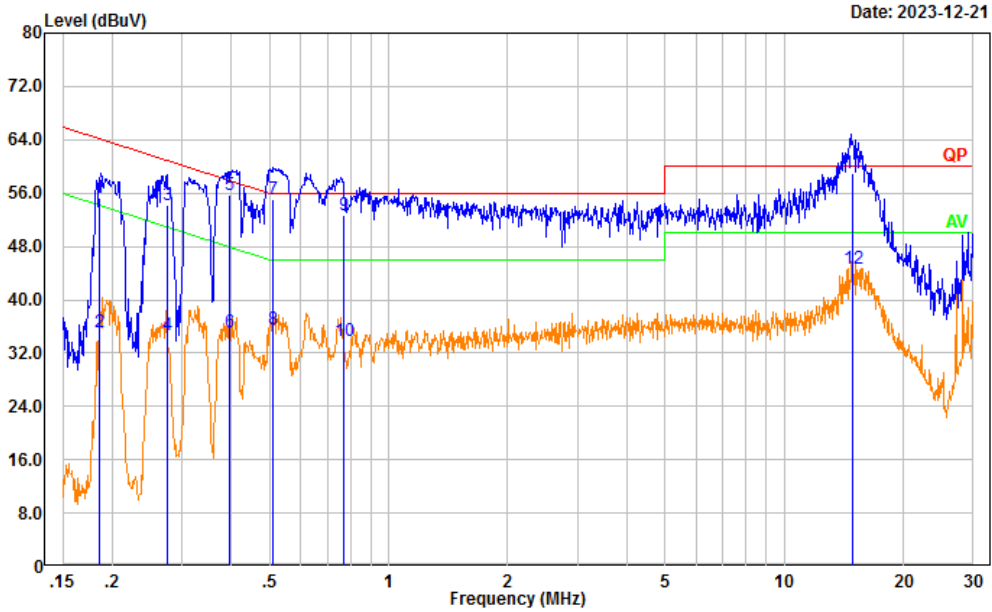

No.	Frequency (MHz)	Reading (dBμV)	Factor (dB)	Result (dBμV)	Limit (dBμV)	Margin (dB)	Detector
1	0.186	45.66	9.61	55.27	64.21	8.94	QP
2	0.186	25.46	9.61	35.07	54.21	19.14	Average
3	0.275	44.63	9.61	54.24	60.95	6.71	QP
4	0.275	25.02	9.61	34.63	50.95	16.32	Average
5	0.395	46.15	9.61	55.76	57.96	2.20	QP
6	0.395	25.44	9.61	35.05	47.96	12.91	Average
7	0.510	45.56	9.61	55.17	56.00	0.83	QP
8	0.510	25.84	9.61	35.45	46.00	10.55	Average
9	0.768	43.16	9.62	52.78	56.00	3.22	QP
10	0.768	24.26	9.62	33.88	46.00	12.12	Average
11	14.844	49.35	9.69	59.04	60.00	0.96	QP
12	14.844	34.87	9.69	44.56	50.00	5.44	Average

Project No.: CR230953507-RF
 Tester: David Huang
 Port: Neutral
 Note: M2 Wireless Charging (Phone horizontal) +Airpods Wireless Charging

Date: 2023-12-21

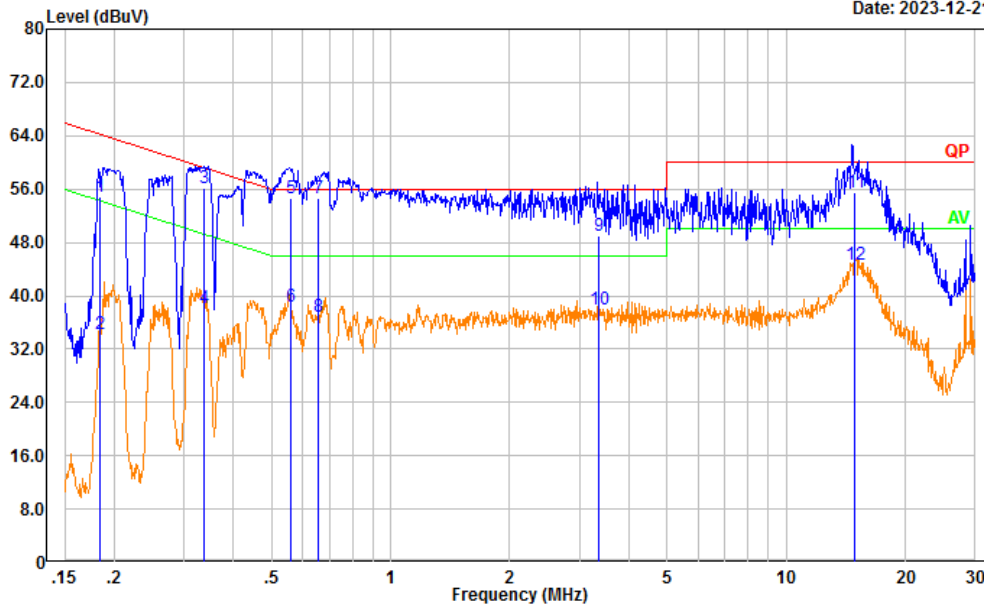

No.	Frequency (MHz)	Reading (dBμV)	Factor (dB)	Result (dBμV)	Limit (dBμV)	Margin (dB)	Detector
1	0.184	45.30	9.61	54.91	64.28	9.37	QP
2	0.184	24.75	9.61	34.36	54.28	19.92	Average
3	0.338	46.44	9.61	56.05	59.25	3.20	QP
4	0.338	28.62	9.61	38.23	49.25	11.02	Average
5	0.557	45.09	9.62	54.71	56.00	1.29	QP
6	0.557	28.80	9.62	38.42	46.00	7.58	Average
7	0.657	45.03	9.62	54.65	56.00	1.35	QP
8	0.657	27.23	9.62	36.85	46.00	9.15	Average
9	3.346	39.36	9.65	49.01	56.00	6.99	QP
10	3.346	28.34	9.65	37.99	46.00	8.01	Average
11	14.910	45.84	9.69	55.53	60.00	4.47	QP
12	14.910	34.96	9.69	44.65	50.00	5.35	Average

M3:

Project No.: CR230953507-RF
 Tester: David Huang
 Port: Line
 Note: M3 Light on+Airpods Wireless Charging+Type C Charging+USB Charging

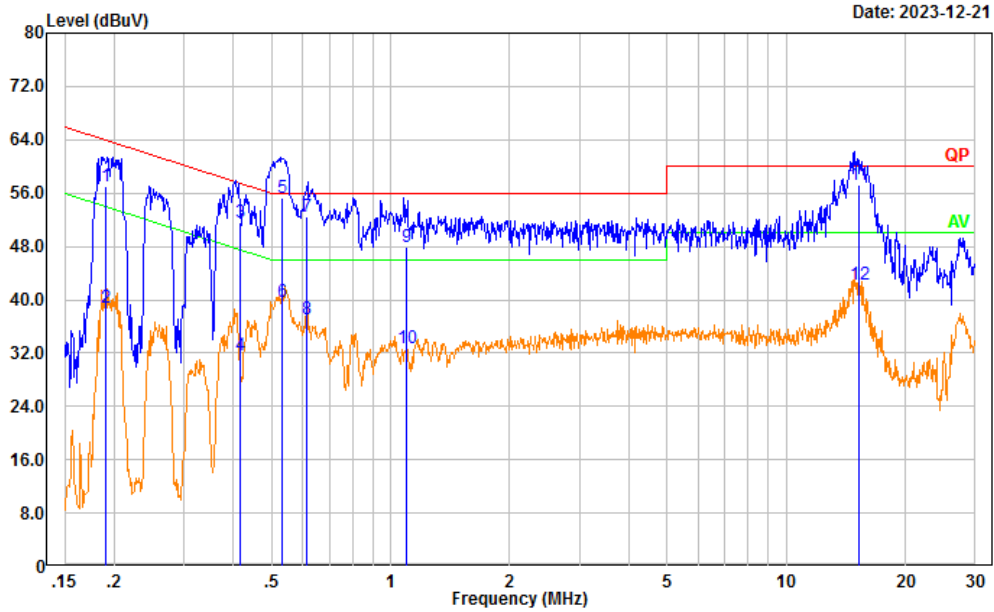

No.	Frequency (MHz)	Reading (dBμV)	Factor (dB)	Result (dBμV)	Limit (dBμV)	Margin (dB)	Detector
1	0.190	47.34	9.61	56.95	64.03	7.08	QP
2	0.190	29.18	9.61	38.79	54.03	15.24	Average
3	0.416	42.08	9.61	51.69	57.53	5.84	QP
4	0.416	22.13	9.61	31.74	47.53	15.79	Average
5	0.532	45.65	9.61	55.26	56.00	0.74	QP
6	0.532	30.13	9.61	39.74	46.00	6.26	Average
7	0.613	42.74	9.62	52.36	56.00	3.64	QP
8	0.613	27.39	9.62	37.01	46.00	8.99	Average
9	1.095	38.19	9.62	47.81	56.00	8.19	QP
10	1.095	23.02	9.62	32.64	46.00	13.36	Average
11	15.233	47.58	9.69	57.27	60.00	2.73	QP
12	15.233	32.56	9.69	42.25	50.00	7.75	Average

M3:

Project No.: CR230953507-RF
 Tester: David Huang
 Port: neutral
 Note: M3 Light on+Airpods Wireless Charging+Type C Charging+USB Charging

Date: 2023-12-21

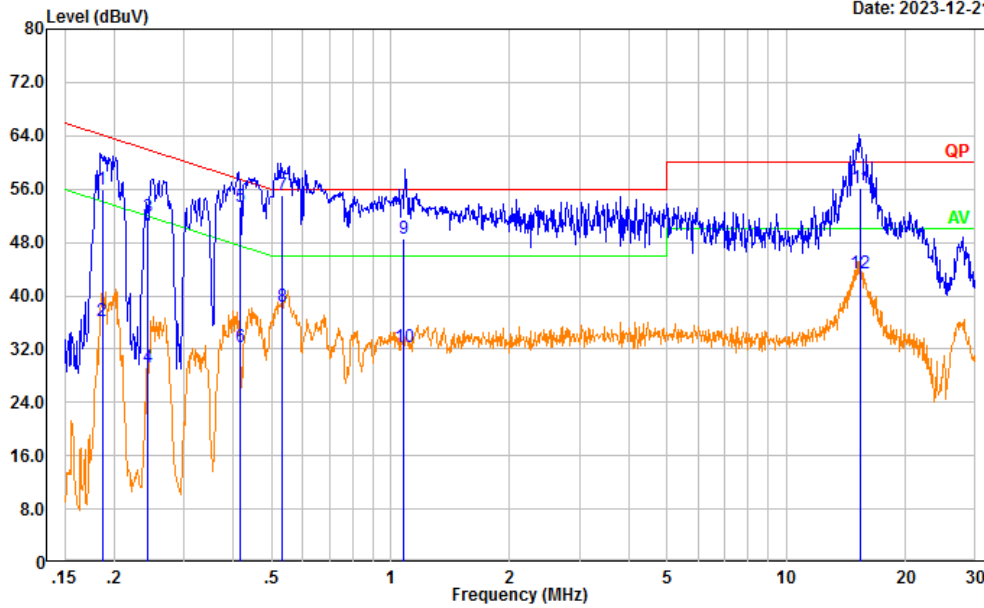

No.	Frequency (MHz)	Reading (dBμV)	Factor (dB)	Result (dBμV)	Limit (dBμV)	Margin (dB)	Detector
1	0.187	46.42	9.61	56.03	64.19	8.16	QP
2	0.187	26.70	9.61	36.31	54.19	17.88	Average
3	0.244	42.12	9.61	51.73	61.96	10.23	QP
4	0.244	19.68	9.61	29.29	51.96	22.67	Average
5	0.415	43.73	9.61	53.34	57.54	4.20	QP
6	0.415	22.76	9.61	32.37	47.54	15.17	Average
7	0.531	45.40	9.61	55.01	56.00	0.99	QP
8	0.531	28.76	9.61	38.37	46.00	7.63	Average
9	1.082	38.98	9.62	48.60	56.00	7.40	QP
10	1.082	22.79	9.62	32.41	46.00	13.59	Average
11	15.320	46.44	9.69	56.13	60.00	3.87	QP
12	15.320	33.62	9.69	43.31	50.00	6.69	Average

M4:

Project No.: CR230953507-RF
 Tester: David Huang
 Port: Line
 Note: M4 Wireless Charging (Phone horizontal) +Type C Charging

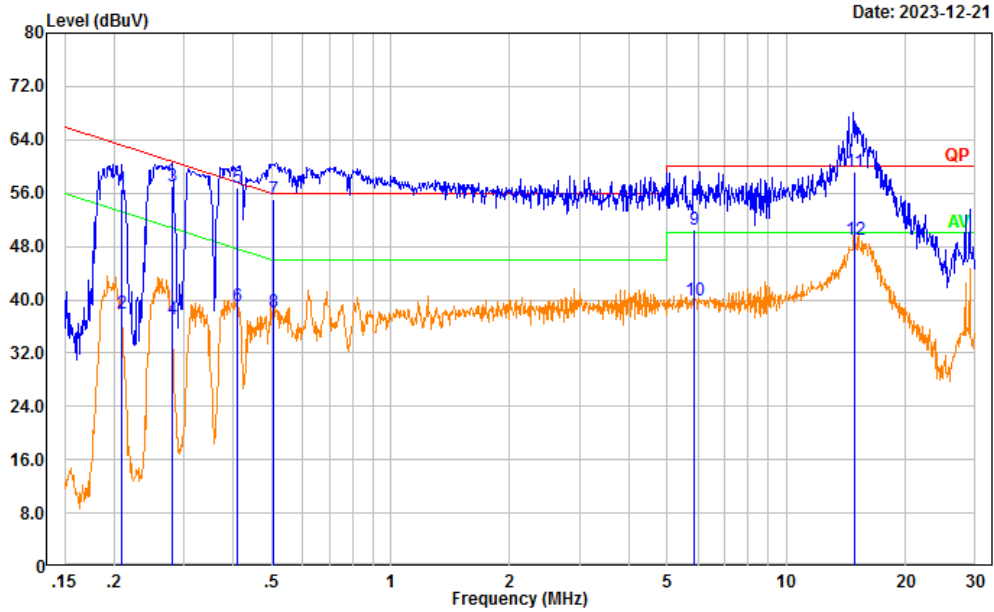

No.	Frequency (MHz)	Reading (dBμV)	Factor (dB)	Result (dBμV)	Limit (dBμV)	Margin (dB)	Detector
1	0.209	46.91	9.61	56.52	63.26	6.74	QP
2	0.209	28.31	9.61	37.92	53.26	15.34	Average
3	0.280	47.41	9.61	57.02	60.83	3.81	QP
4	0.280	27.46	9.61	37.07	50.83	13.76	Average
5	0.411	47.22	9.61	56.83	57.63	0.80	QP
6	0.411	29.38	9.61	38.99	47.63	8.64	Average
7	0.506	45.54	9.61	55.15	56.00	0.85	QP
8	0.506	28.58	9.61	38.19	46.00	7.81	Average
9	5.860	40.86	9.66	50.52	60.00	9.48	QP
10	5.860	30.14	9.66	39.80	50.00	10.20	Average
11	14.866	49.60	9.69	59.29	60.00	0.71	QP
12	14.866	39.28	9.69	48.97	50.00	1.03	Average

Project No.: CR230953507-RF
 Tester: David Huang
 Port: neutral
 Note: M4 Wireless Charging (Phone horizontal) +Type C Charging

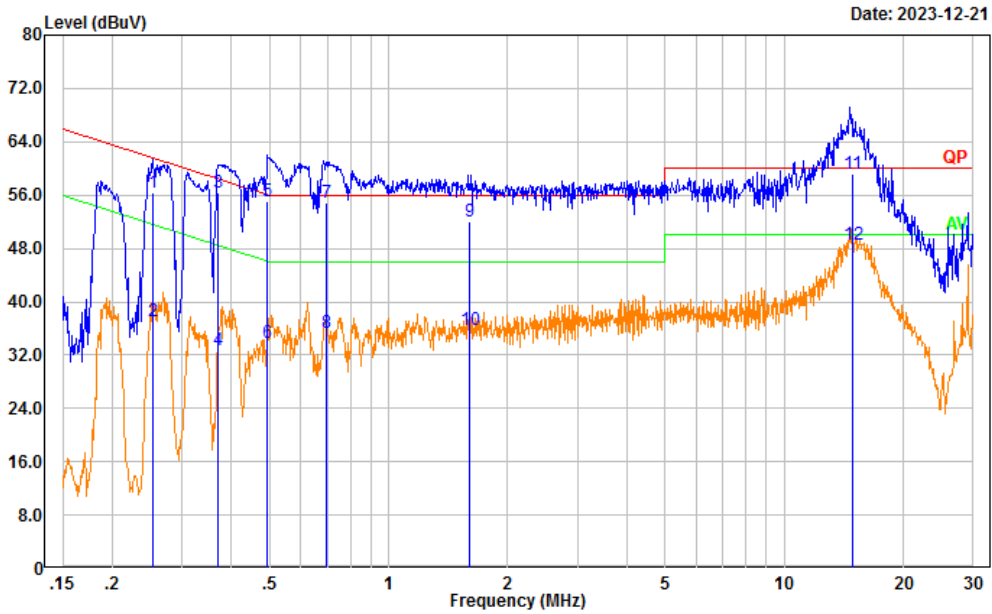

Date: 2023-12-21

No.	Frequency (MHz)	Reading (dBμV)	Factor (dB)	Result (dBμV)	Limit (dBμV)	Margin (dB)	Detector
1	0.253	46.66	9.61	56.27	61.65	5.38	QP
2	0.253	27.41	9.61	37.02	51.65	14.63	Average
3	0.371	46.81	9.61	56.42	58.48	2.06	QP
4	0.371	23.13	9.61	32.74	48.48	15.74	Average
5	0.495	45.46	9.61	55.07	56.09	1.02	QP
6	0.495	24.27	9.61	33.88	46.09	12.21	Average
7	0.695	45.24	9.62	54.86	56.00	1.14	QP
8	0.695	25.79	9.62	35.41	46.00	10.59	Average
9	1.604	42.47	9.63	52.10	56.00	3.90	QP
10	1.604	26.06	9.63	35.69	46.00	10.31	Average
11	14.857	49.55	9.69	59.24	60.00	0.76	QP
12	14.857	38.83	9.69	48.52	50.00	1.48	Average

M5:

Project No.: CR230953507-RF
 Tester: David Huang
 Port: Line
 Note: M5 Wireless Charging (Phone horizontal) + USB Charging

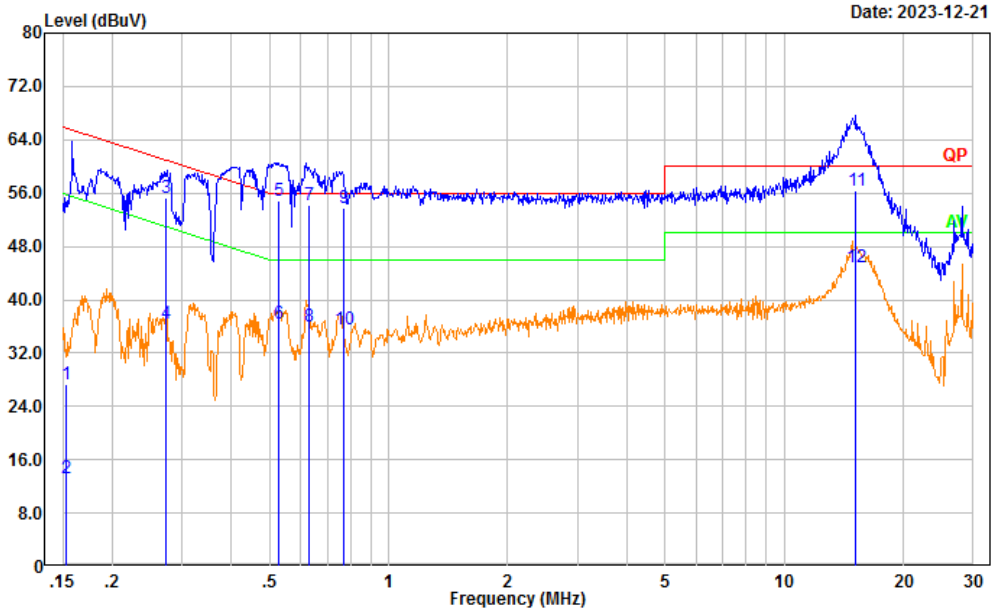

No.	Frequency (MHz)	Reading (dBμV)	Factor (dB)	Result (dBμV)	Limit (dBμV)	Margin (dB)	Detector
1	0.154	17.73	9.61	27.34	65.80	38.46	QP
2	0.154	3.62	9.61	13.23	55.80	42.57	Average
3	0.274	45.72	9.61	55.33	61.01	5.68	QP
4	0.274	26.79	9.61	36.40	51.01	14.61	Average
5	0.526	45.17	9.61	54.78	56.00	1.22	QP
6	0.526	26.81	9.61	36.42	46.00	9.58	Average
7	0.631	44.59	9.62	54.21	56.00	1.79	QP
8	0.631	26.43	9.62	36.05	46.00	9.95	Average
9	0.767	44.08	9.62	53.70	56.00	2.30	QP
10	0.767	25.96	9.62	35.58	46.00	10.42	Average
11	15.155	46.70	9.69	56.39	60.00	3.61	QP
12	15.155	35.23	9.69	44.92	50.00	5.08	Average

Project No.: CR230953507-RF
 Tester: David Huang
 Port: Neutral
 Note: M5 Wireless Charging (Phone horizontal) + USB Charging

Date: 2023-12-21

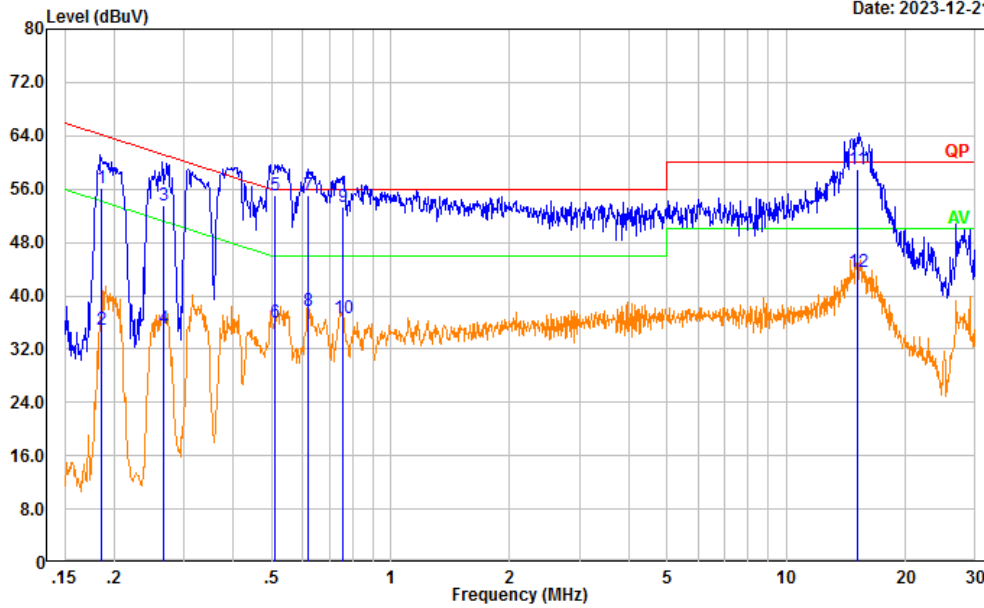

No.	Frequency (MHz)	Reading (dBμV)	Factor (dB)	Result (dBμV)	Limit (dBμV)	Margin (dB)	Detector
1	0.185	46.50	9.61	56.11	64.25	8.14	QP
2	0.185	25.22	9.61	34.83	54.25	19.42	Average
3	0.268	43.91	9.61	53.52	61.19	7.67	QP
4	0.268	25.48	9.61	35.09	51.19	16.10	Average
5	0.508	45.46	9.61	55.07	56.00	0.93	QP
6	0.508	26.32	9.61	35.93	46.00	10.07	Average
7	0.619	45.53	9.62	55.15	56.00	0.85	QP
8	0.619	28.05	9.62	37.67	46.00	8.33	Average
9	0.755	43.70	9.62	53.32	56.00	2.68	QP
10	0.755	27.00	9.62	36.62	46.00	9.38	Average
11	15.079	49.19	9.69	58.88	60.00	1.12	QP
12	15.079	33.90	9.69	43.59	50.00	6.41	Average

M6:

Project No.: CR230953507-RF
 Tester: David Huang
 Port: Line
 Note: M6 Wireless Charging (Phone vertical) +Type C Charging

Date: 2024-01-09

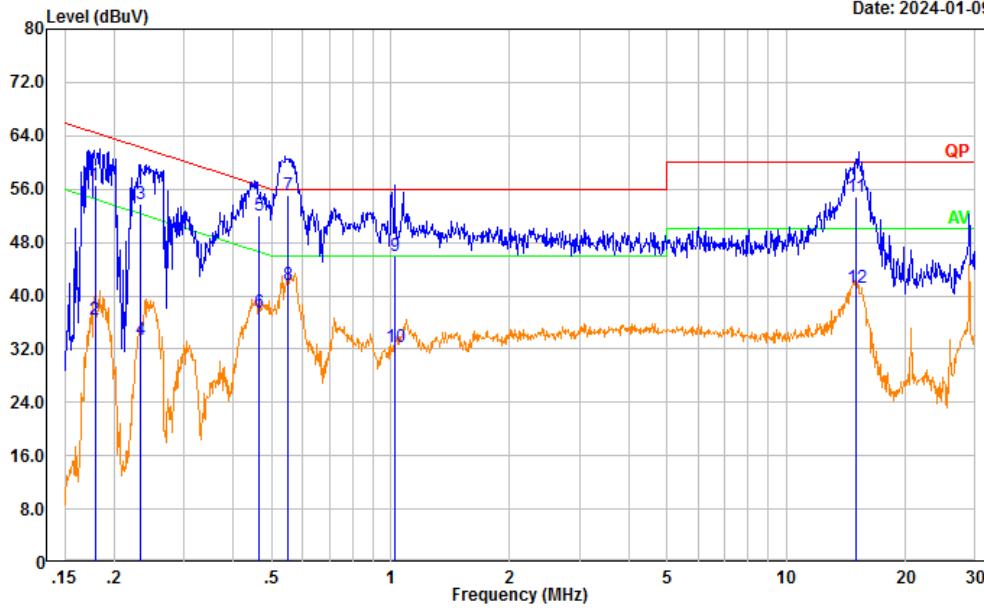

No.	Frequency (MHz)	Reading (dBμV)	Factor (dB)	Result (dBμV)	Limit (dBμV)	Margin (dB)	Detector
1	0.179	46.87	9.61	56.48	64.54	8.06	QP
2	0.179	26.90	9.61	36.51	54.54	18.03	Average
3	0.233	44.10	9.61	53.71	62.35	8.64	QP
4	0.233	23.88	9.61	33.49	52.35	18.86	Average
5	0.465	42.43	9.61	52.04	56.61	4.57	QP
6	0.465	27.95	9.61	37.56	46.61	9.05	Average
7	0.550	45.52	9.61	55.13	56.00	0.87	QP
8	0.550	32.01	9.61	41.62	46.00	4.38	Average
9	1.022	36.26	9.62	45.88	56.00	10.12	QP
10	1.022	22.67	9.62	32.29	46.00	13.71	Average
11	15.011	45.18	9.69	54.87	60.00	5.13	QP
12	15.011	31.41	9.69	41.10	50.00	8.90	Average

Project No.: CR230953507-RF
 Tester: David Huang
 Port: neutral
 Note: M6 Wireless Charging (Phone vertical) +Type C Charging

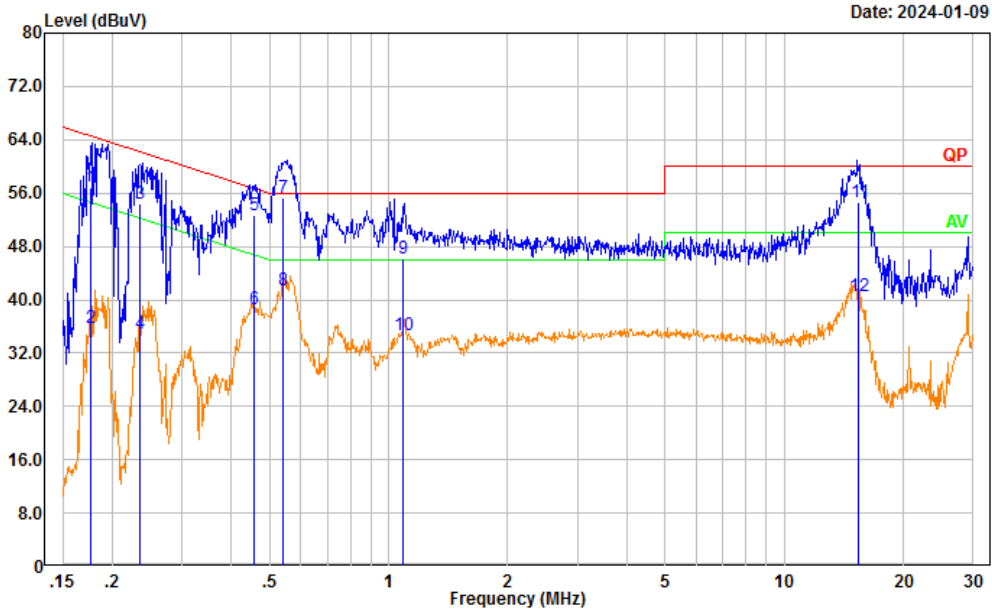

No.	Frequency (MHz)	Reading (dBμV)	Factor (dB)	Result (dBμV)	Limit (dBμV)	Margin (dB)	Detector
1	0.177	47.16	9.61	56.77	64.63	7.86	QP
2	0.177	26.21	9.61	35.82	54.63	18.81	Average
3	0.234	44.86	9.61	54.47	62.29	7.82	QP
4	0.234	25.25	9.61	34.86	52.29	17.43	Average
5	0.456	43.00	9.61	52.61	56.77	4.16	QP
6	0.456	28.96	9.61	38.57	46.77	8.20	Average
7	0.540	45.65	9.61	55.26	56.00	0.74	QP
8	0.540	31.74	9.61	41.35	46.00	4.65	Average
9	1.086	36.54	9.62	46.16	56.00	9.84	QP
10	1.086	25.01	9.62	34.63	46.00	11.37	Average
11	15.423	44.99	9.69	54.68	60.00	5.32	QP
12	15.423	30.77	9.69	40.46	50.00	9.54	Average

4.2 Radiation Spurious Emissions

Serial Number:	2B5B-2	Test Date:	2023/12/8-2023/12/9
Test Site:	966-2	Test Mode:	M1-M6
Tester:	Carl Xue	Test Result:	Pass

Environmental Conditions:

Temperature: (°C)	25.3-26.3	Relative Humidity: (%)	45-47	ATM Pressure: (kPa)	100.9-101.1
----------------------	-----------	------------------------------	-------	------------------------	-------------

Test Equipment List and Details:

Manufacturer	Description	Model	Serial Number	Calibration Date	Calibration Due Date
BACL	Loop Antenna	1313-1P	3092721	2023/10/20	2026/10/19
Sunol Sciences	Antenna	JB6	A082520-5	2023/12/1	2026/11/30
R&S	EMI Test Receiver	ESR3	102724	2023/3/31	2024/3/30
TIMES MICROWAVE	Coaxial Cable	LMR-600-UltraFlex	C-0470-02	2023/7/16	2024/7/15
TIMES MICROWAVE	Coaxial Cable	LMR-600-UltraFlex	C-0780-01	2023/7/16	2024/7/15
Sonoma	Amplifier	310N	186165	2023/7/16	2024/7/15
Audix	Test Software	E3	201021 (V9)	N/A	N/A

* Statement of Traceability: China Certification ICT Co., Ltd (Dongguan) attests that all calibrations have been performed, traceable to National Primary Standards and International System of Units (SI).

M1:
1)9k-30MHz
Parallel

Project No.: CR230953507-RF
 Tester: Carl Xue
 Polarization: Parallel
 Note:

Date: 2023-12-08

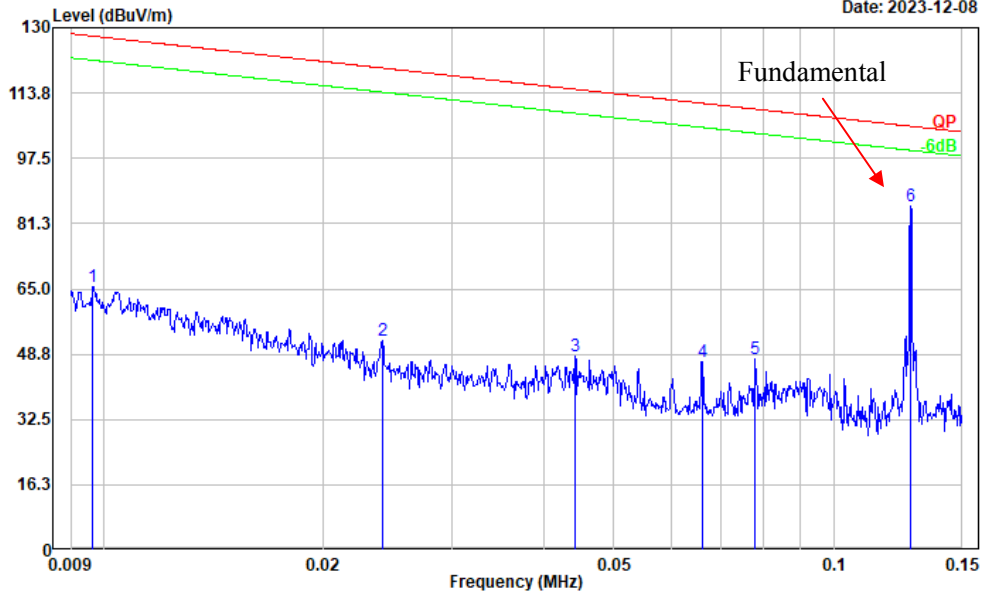

No.	Frequency (MHz)	Reading (dBμV)	Factor (dB/m)	Result (dBμV/m)	Limit (dBμV/m)	Margin (dB)	Detector
1	0.010	6.80	58.89	65.69	127.91	62.22	Peak
2	0.024	1.85	50.31	52.16	119.97	67.81	Peak
3	0.044	4.18	44.03	48.21	114.69	66.48	Peak
4	0.066	6.29	40.50	46.79	111.19	64.40	Peak
5	0.078	8.83	38.86	47.69	109.75	62.06	Peak
6	0.127	50.36	35.30	85.66	105.50	19.84	Peak

Project No.: CR230953507-RF
 Tester: Carl Xue
 Polarization: Parallel
 Note:

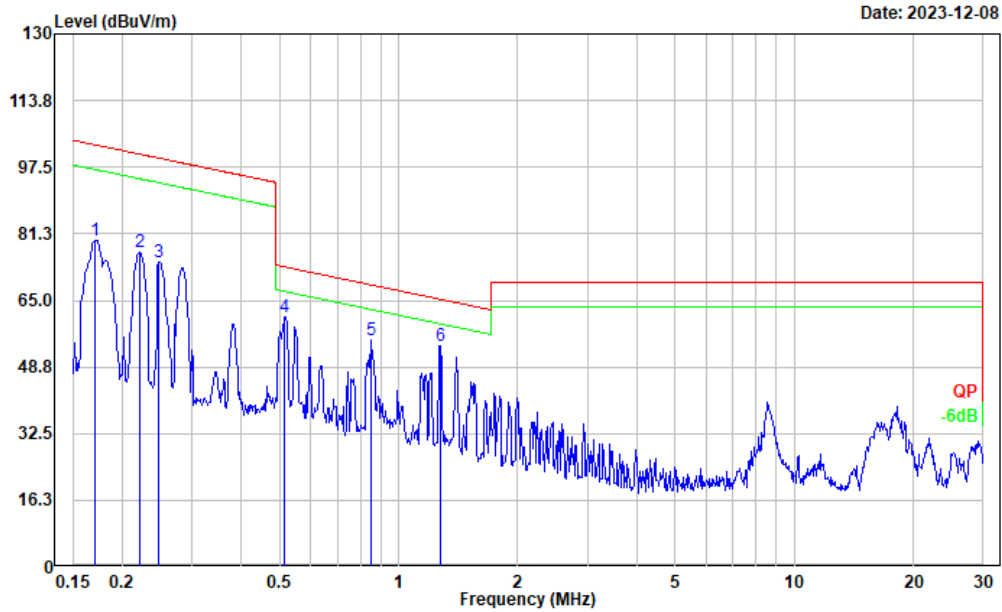

No.	Frequency (MHz)	Reading (dBμV)	Factor (dB/m)	Result (dBμV/m)	Limit (dBμV/m)	Margin (dB)	Detector
1	0.171	46.50	33.23	79.73	102.93	23.20	Peak
2	0.221	45.96	30.88	76.84	100.72	23.88	Peak
3	0.247	44.75	29.65	74.40	99.76	25.36	Peak
4	0.516	38.47	22.56	61.03	73.35	12.32	Peak
5	0.848	36.83	18.34	55.17	68.93	13.76	Peak
6	1.276	38.41	15.36	53.77	65.31	11.54	Peak

Perpendicular

Project No.: CR230953507-RF
 Tester: Carl Xue
 Polarization: Perpendicular
 Note:

Date: 2023-12-08

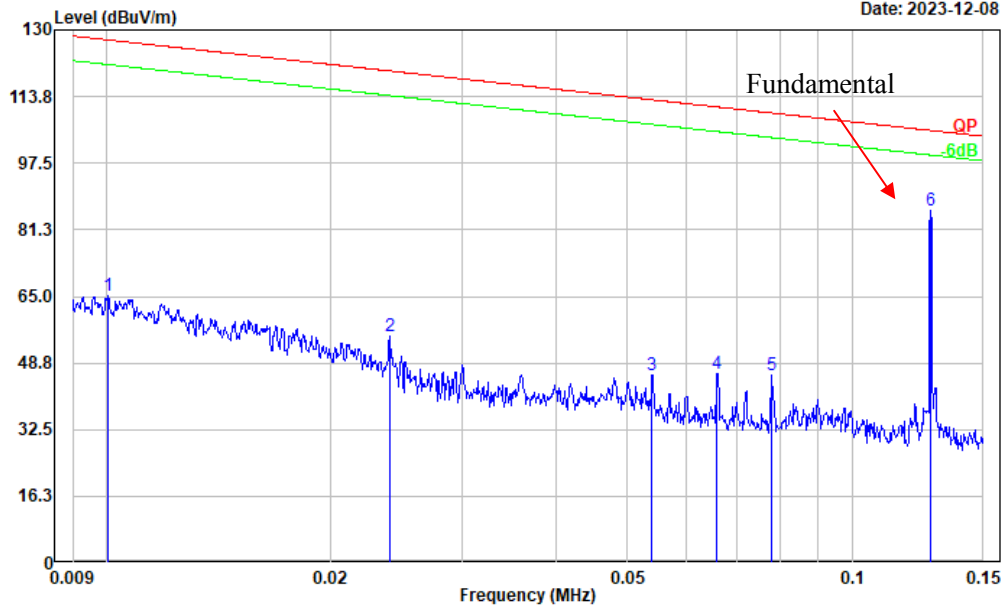

No.	Frequency (MHz)	Reading (dBμV)	Factor (dB/m)	Result (dBμV/m)	Limit (dBμV/m)	Margin (dB)	Detector
1	0.010	6.73	58.44	65.17	127.57	62.40	Peak
2	0.024	4.80	50.38	55.18	120.02	64.84	Peak
3	0.054	3.60	42.20	45.80	112.98	67.18	Peak
4	0.066	5.64	40.53	46.17	111.22	65.05	Peak
5	0.078	6.81	38.86	45.67	109.75	64.08	Peak
6	0.127	50.69	35.30	85.99	105.50	19.51	Peak

Project No.: CR230953507-RF
 Tester: Carl Xue
 Polarization: Perpendicular
 Note:

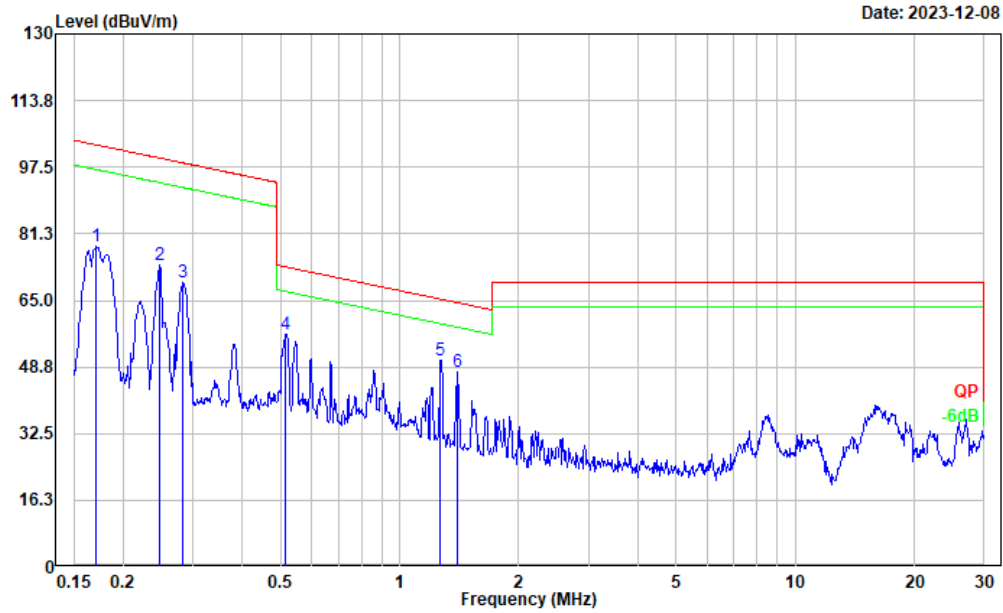

No.	Frequency (MHz)	Reading (dBμV)	Factor (dB/m)	Result (dBμV/m)	Limit (dBμV/m)	Margin (dB)	Detector
1	0.171	44.85	33.23	78.08	102.93	24.85	Peak
2	0.248	43.94	29.58	73.52	99.71	26.19	Peak
3	0.283	41.44	27.93	69.37	98.56	29.19	Peak
4	0.516	34.29	22.56	56.85	73.35	16.50	Peak
5	1.269	34.87	15.40	50.27	65.36	15.09	Peak
6	1.396	32.80	14.70	47.50	64.51	17.01	Peak

Ground-parallel

Project No.: CR230953507-RF
 Tester: Carl Xue
 Polarization: Ground-parallel
 Note:

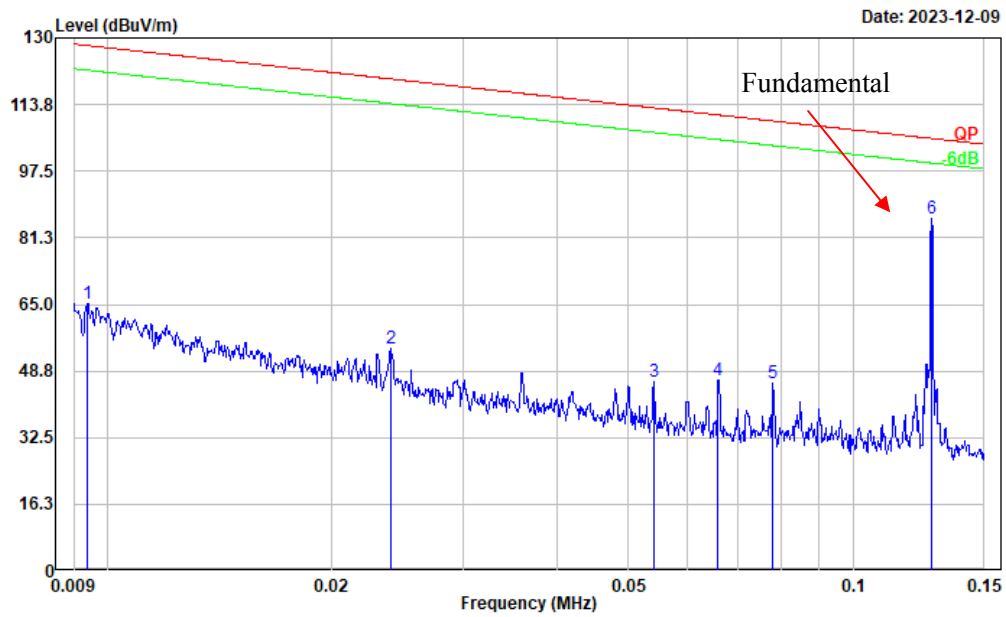

No.	Frequency (MHz)	Reading (dBμV)	Factor (dB/m)	Result (dBμV/m)	Limit (dBμV/m)	Margin (dB)	Detector
1	0.009	6.11	59.22	65.33	128.15	62.82	Peak
2	0.024	3.91	50.38	54.29	120.02	65.73	Peak
3	0.054	4.04	42.18	46.22	112.95	66.73	Peak
4	0.066	6.14	40.53	46.67	111.22	64.55	Peak
5	0.078	6.85	38.86	45.71	109.75	64.04	Peak
6	0.127	50.53	35.30	85.83	105.50	19.67	Peak

Project No.: CR230953507-RF
 Tester: Carl Xue
 Polarization: Ground-parallel
 Note:

Date: 2023-12-09

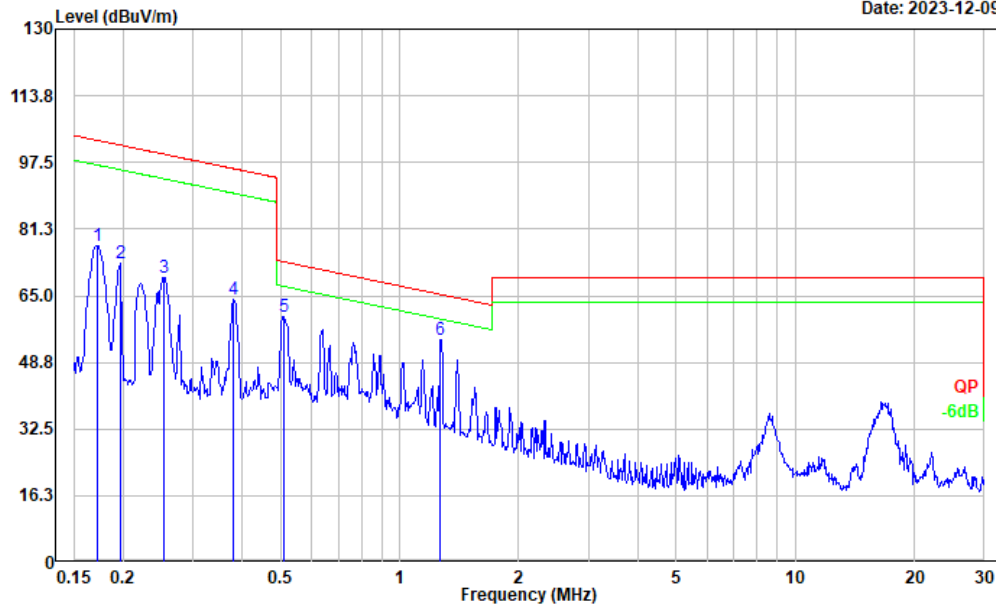

No.	Frequency (MHz)	Reading (dBμV)	Factor (dB/m)	Result (dBμV/m)	Limit (dBμV/m)	Margin (dB)	Detector
1	0.172	44.07	33.18	77.25	102.89	25.64	Peak
2	0.197	40.94	32.03	72.97	101.74	28.77	Peak
3	0.253	40.13	29.35	69.48	99.53	30.05	Peak
4	0.381	38.76	25.37	64.13	95.98	31.85	Peak
5	0.510	37.34	22.64	59.98	73.44	13.46	Peak
6	1.269	38.92	15.40	54.32	65.36	11.04	Peak

2)30MHz- 1GHz

Project No.: CR230953507-RF
 Tester: Carl Xue
 Polarization: Horizontal
 Note: Light on+Wireless Charging(Phone horizontal)

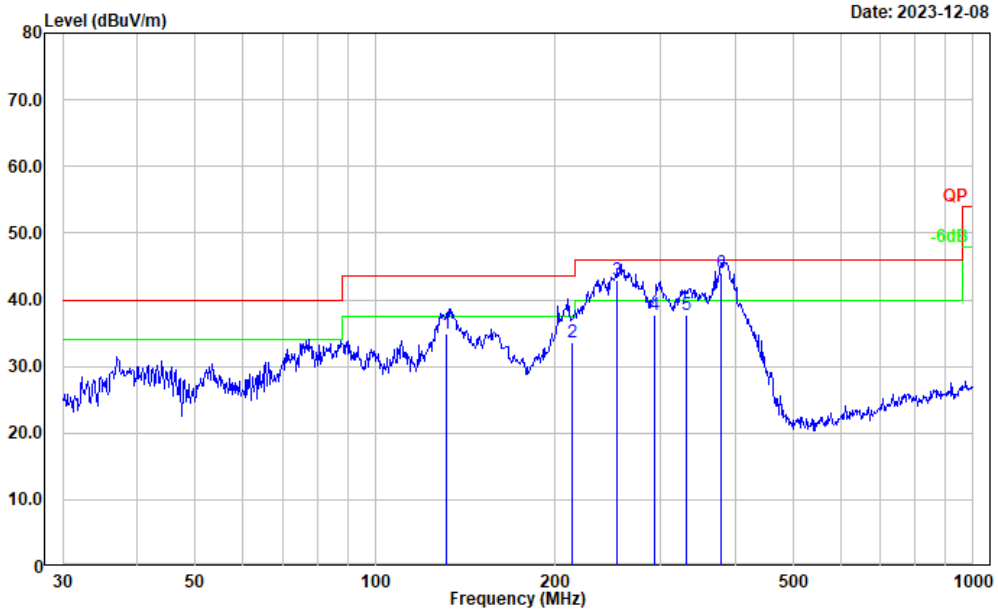

No.	Frequency (MHz)	Reading (dBμV)	Factor (dB/m)	Result (dBμV/m)	Limit (dBμV/m)	Margin (dB)	Detector
1	131.593	46.43	-11.56	34.87	43.50	8.63	QP
2	212.893	46.58	-12.88	33.70	43.50	9.80	QP
3	253.730	56.14	-13.28	42.86	46.00	3.14	QP
4	293.599	49.01	-11.20	37.81	46.00	8.19	QP
5	330.681	48.18	-10.51	37.67	46.00	8.33	QP
6	378.842	53.44	-9.49	43.95	46.00	2.05	QP

Project No.: CR230953507-RF
 Tester: Carl Xue
 Polarization: vertical
 Note: Light on+Wireless Charging(Phone horizontal)

Date: 2023-12-08

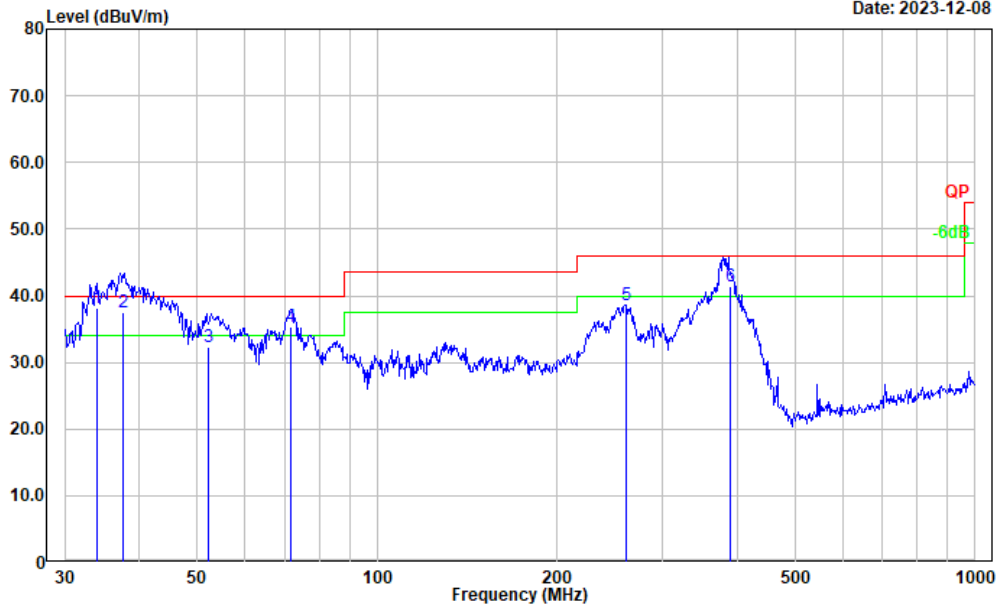

No.	Frequency (MHz)	Reading (dBμV)	Factor (dB/m)	Result (dBμV/m)	Limit (dBμV/m)	Margin (dB)	Detector
1	34.024	45.02	-6.97	38.05	40.00	1.95	QP
2	37.614	47.09	-9.67	37.42	40.00	2.58	QP
3	52.286	49.59	-17.27	32.32	40.00	7.68	QP
4	71.714	52.16	-16.90	35.26	40.00	4.74	QP
5	260.144	51.42	-12.83	38.59	46.00	7.41	Peak
6	388.719	50.69	-9.24	41.45	46.00	4.55	QP

M2:
1)9k-30MHz
Parallel

Project No.: CR230953507-RF
 Tester: Carl Xue
 Polarization: Parallel
 Note:

Date: 2023-12-08

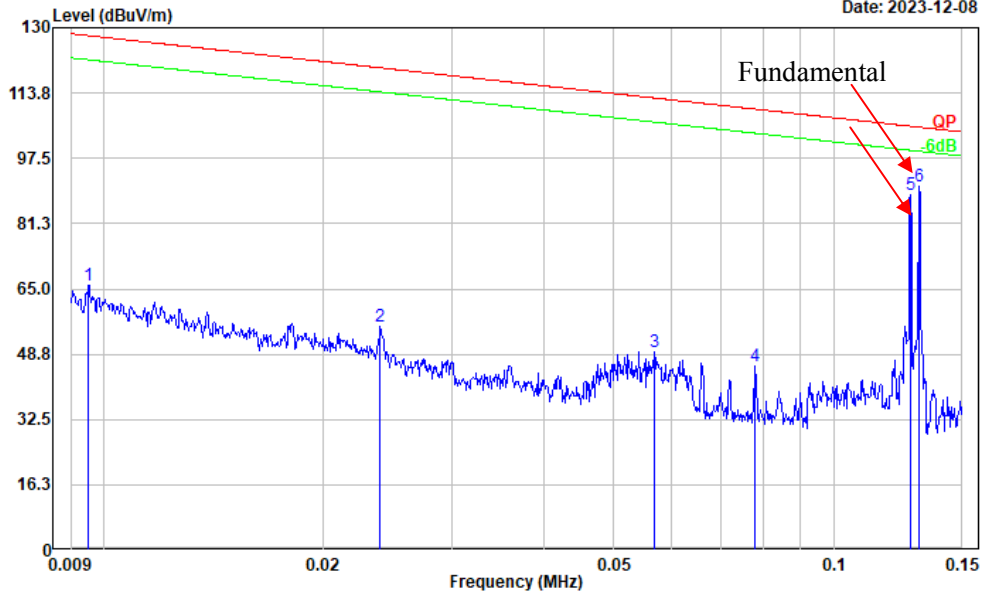

No.	Frequency (MHz)	Reading (dBμV)	Factor (dB/m)	Result (dBμV/m)	Limit (dBμV/m)	Margin (dB)	Detector
1	0.010	6.85	59.05	65.90	128.03	62.13	Peak
2	0.024	5.21	50.41	55.62	120.04	64.42	Peak
3	0.057	7.53	41.80	49.33	112.51	63.18	Peak
4	0.078	6.94	38.86	45.80	109.75	63.95	Peak
5	0.127	53.30	35.30	88.60	105.50	16.90	Peak
6	0.131	55.43	35.13	90.56	105.26	14.70	Peak

Project No.: CR230953507-RF
 Tester: Carl Xue
 Polarization: Parallel
 Note:

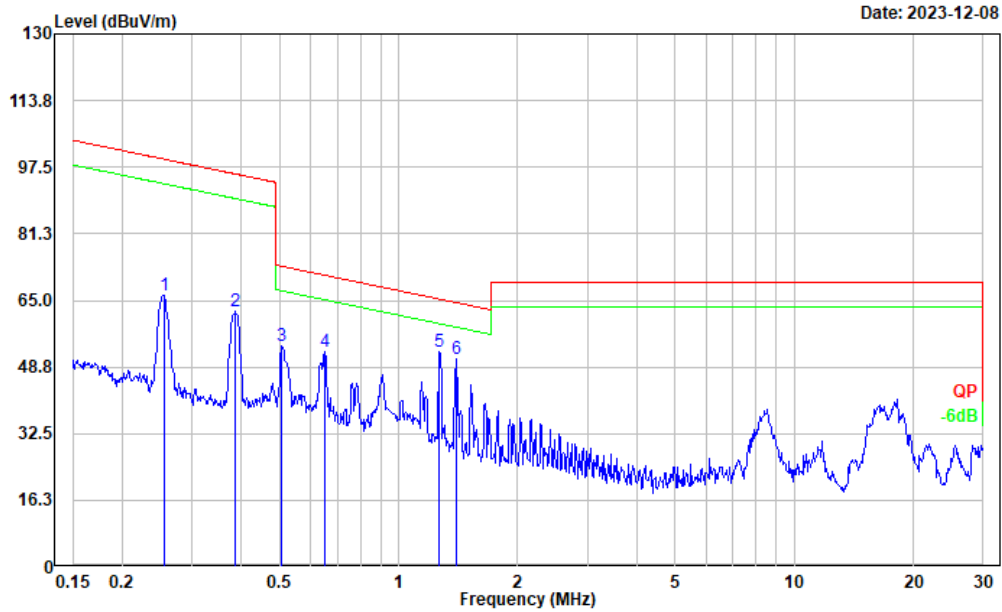

No.	Frequency (MHz)	Reading (dBμV)	Factor (dB/m)	Result (dBμV/m)	Limit (dBμV/m)	Margin (dB)	Detector
1	0.255	37.10	29.29	66.39	99.48	33.09	Peak
2	0.387	36.96	25.23	62.19	95.84	33.65	Peak
3	0.507	31.25	22.67	53.92	73.49	19.57	Peak
4	0.651	31.73	20.77	52.50	71.28	18.78	Peak
5	1.269	37.14	15.40	52.54	65.36	12.82	Peak
6	1.396	35.86	14.70	50.56	64.51	13.95	Peak

Perpendicular

Project No.: CR230953507-RF
 Tester: Carl Xue
 Polarization: Perpendicular
 Note:

Date: 2023-12-08

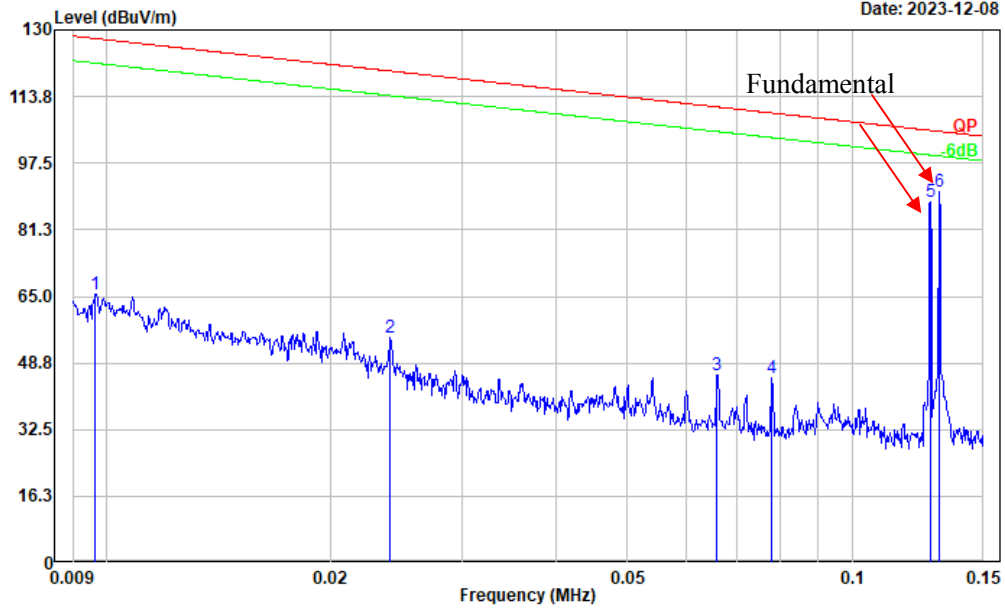

No.	Frequency (MHz)	Reading (dBμV)	Factor (dB/m)	Result (dBμV/m)	Limit (dBμV/m)	Margin (dB)	Detector
1	0.010	6.57	58.89	65.46	127.91	62.45	Peak
2	0.024	4.49	50.35	54.84	119.99	65.15	Peak
3	0.066	5.31	40.53	45.84	111.22	65.38	Peak
4	0.078	6.13	38.86	44.99	109.75	64.76	Peak
5	0.127	52.82	35.30	88.12	105.50	17.38	Peak
6	0.131	55.54	35.13	90.67	105.26	14.59	Peak

Project No.: CR230953507-RF
 Tester: Carl Xue
 Polarization: Perpendicular
 Note:

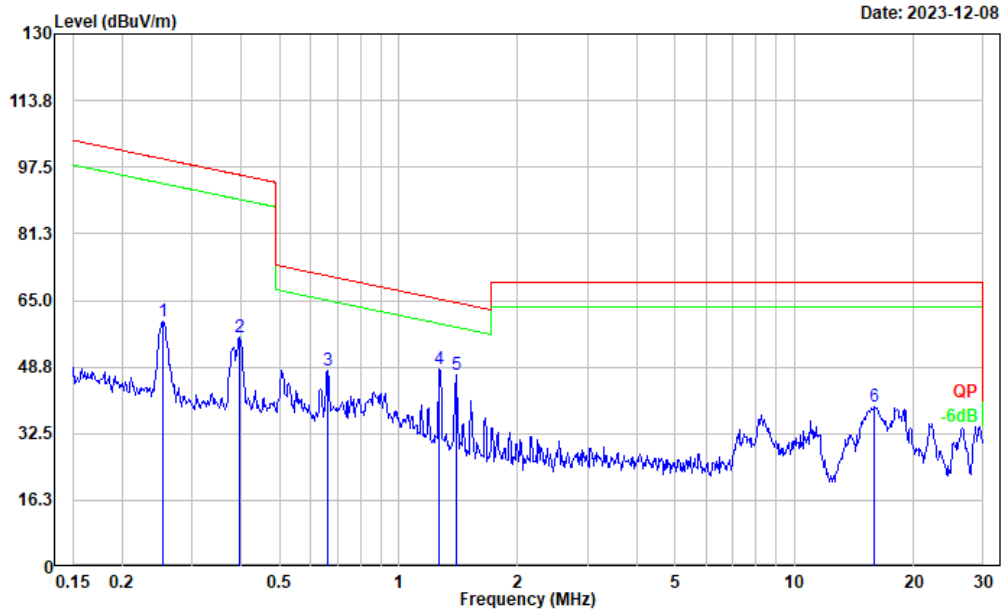

No.	Frequency (MHz)	Reading (dB μ V)	Factor (dB/m)	Result (dB μ V/m)	Limit (dB μ V/m)	Margin (dB)	Detector
1	0.253	30.42	29.35	59.77	99.53	39.76	Peak
2	0.396	30.89	25.05	55.94	95.66	39.72	Peak
3	0.661	27.17	20.63	47.80	71.14	23.34	Peak
4	1.269	32.98	15.40	48.38	65.36	16.98	Peak
5	1.396	32.06	14.70	46.76	64.51	17.75	Peak
6	15.970	36.84	2.11	38.95	69.54	30.59	Peak

Ground-parallel

Project No.: CR230953507-RF
 Tester: Carl Xue
 Polarization: Ground-parallel
 Note:

Date: 2023-12-09

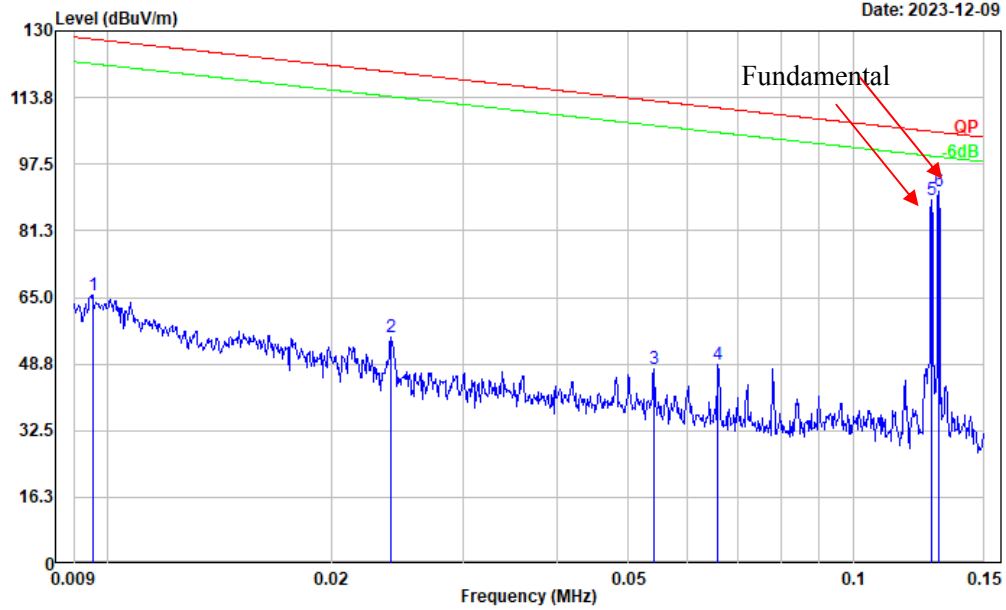

No.	Frequency (MHz)	Reading (dBμV)	Factor (dB/m)	Result (dBμV/m)	Limit (dBμV/m)	Margin (dB)	Detector
1	0.010	6.50	59.02	65.52	128.01	62.49	Peak
2	0.024	4.84	50.35	55.19	119.99	64.80	Peak
3	0.054	5.43	42.18	47.61	112.95	65.34	Peak
4	0.066	8.12	40.53	48.65	111.22	62.57	Peak
5	0.127	53.59	35.30	88.89	105.50	16.61	Peak
6	0.130	55.61	35.16	90.77	105.30	14.53	Peak

Project No.: CR230953507-RF
 Tester: Carl Xue
 Polarization: Ground-parallel
 Note:

Date: 2023-12-09

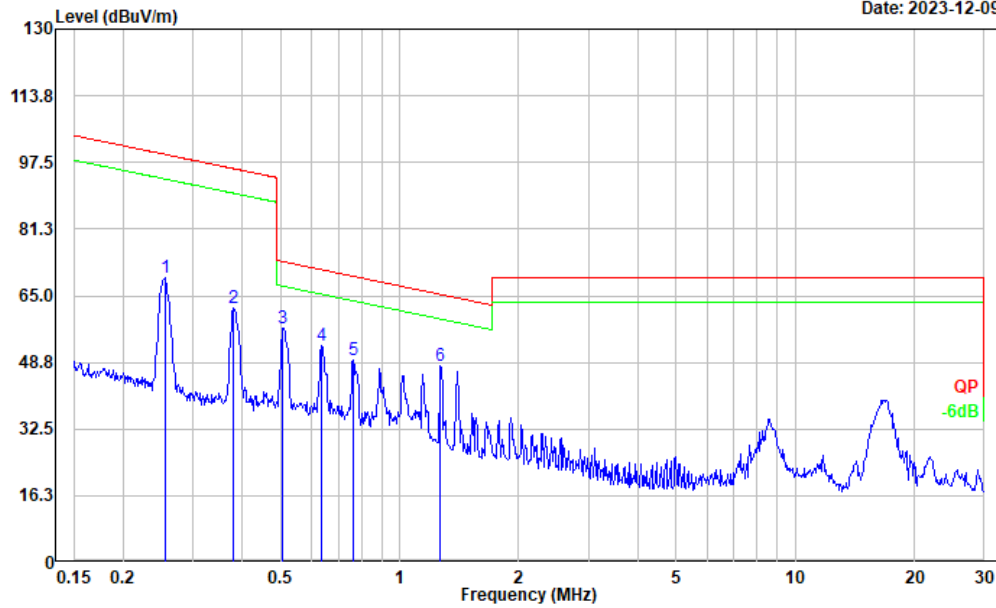

No.	Frequency (MHz)	Reading (dBμV)	Factor (dB/m)	Result (dBμV/m)	Limit (dBμV/m)	Margin (dB)	Detector
1	0.255	40.13	29.29	69.42	99.48	30.06	Peak
2	0.381	36.59	25.37	61.96	95.98	34.02	Peak
3	0.507	34.43	22.67	57.10	73.49	16.39	Peak
4	0.634	31.77	20.99	52.76	71.52	18.76	Peak
5	0.763	30.12	19.28	49.40	69.87	20.47	Peak
6	1.269	32.36	15.40	47.76	65.36	17.60	Peak

4)30MHz- 1GHz

Project No.: CR230953507-RF
 Tester: Carl Xue
 Polarization: horizontal
 Note: Wireless Charging (Phone horizontal) +Airpods Wireless

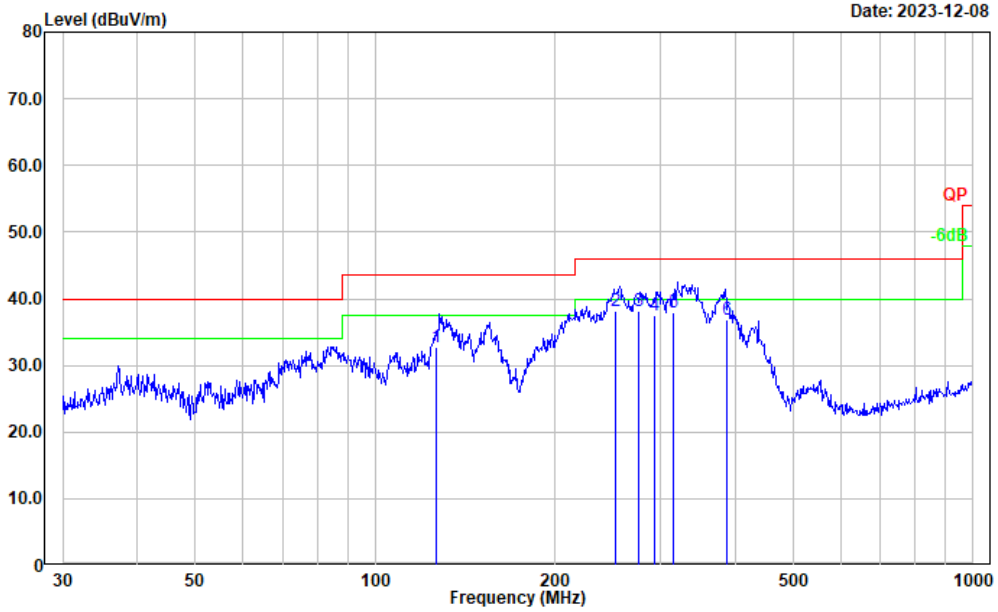

No.	Frequency (MHz)	Reading (dBμV)	Factor (dB/m)	Result (dBμV/m)	Limit (dBμV/m)	Margin (dB)	Detector
1	126.408	44.39	-11.56	32.83	43.50	10.67	QP
2	252.431	51.46	-13.35	38.11	46.00	7.89	QP
3	275.444	50.32	-12.24	38.08	46.00	7.92	QP
4	293.914	48.63	-11.19	37.44	46.00	8.56	QP
5	314.542	48.99	-10.94	38.05	46.00	7.95	QP
6	386.497	46.10	-9.30	36.80	46.00	9.20	QP

Project No.: CR230953507-RF
 Tester: Carl Xue
 Polarization: vertical
 Note: Wireless Charging (Phone horizontal) +Airpods Wireless

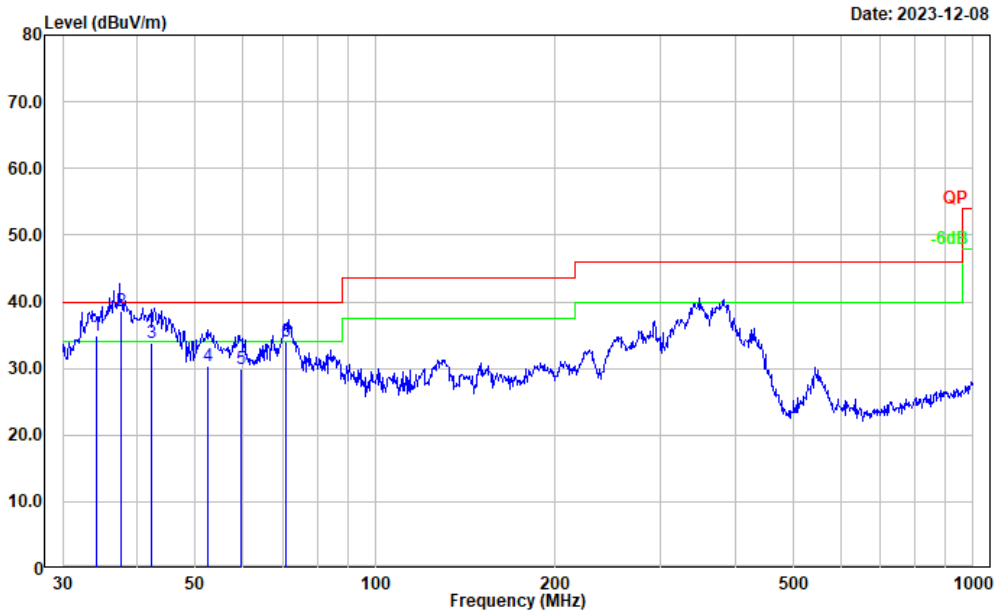

No.	Frequency (MHz)	Reading (dBμV)	Factor (dB/m)	Result (dBμV/m)	Limit (dBμV/m)	Margin (dB)	Detector
1	34.153	42.00	-7.07	34.93	40.00	5.07	QP
2	37.671	48.28	-9.72	38.56	40.00	1.44	QP
3	42.277	46.62	-12.82	33.80	40.00	6.20	QP
4	52.412	47.52	-17.27	30.25	40.00	9.75	QP
5	59.631	47.45	-17.46	29.99	40.00	10.01	QP
6	70.945	50.77	-16.83	33.94	40.00	6.06	QP

M3
1)9k-30MHz:
Parallel

Project No.: CR230953507-RF
 Tester: Carl Xue
 Polarization: Parallel
 Note:

Date: 2023-12-08

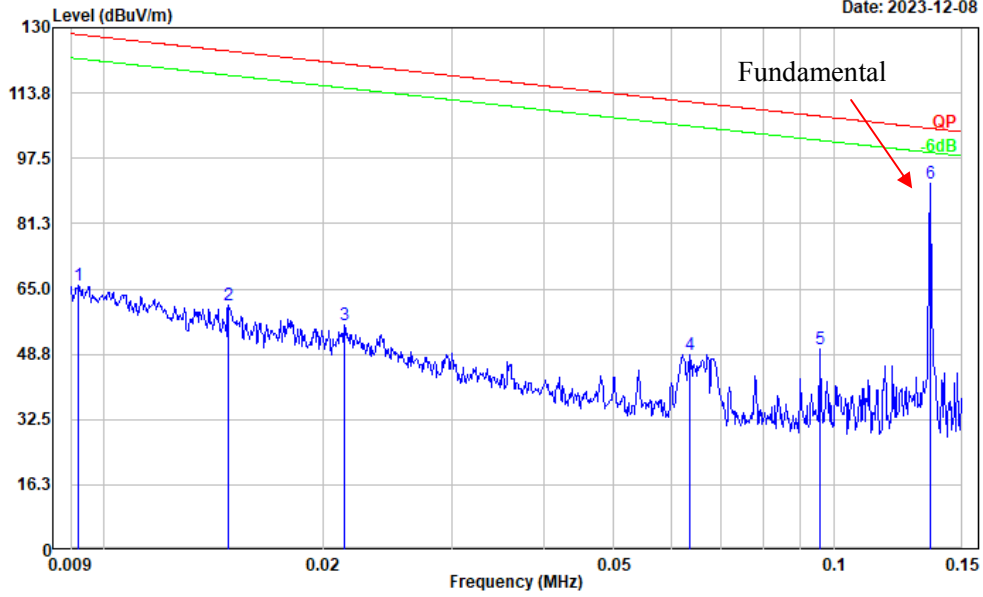

No.	Frequency (MHz)	Reading (dBuV)	Factor (dB/m)	Result (dBuV/m)	Limit (dBuV/m)	Margin (dB)	Detector
1	0.009	6.41	59.41	65.82	128.30	62.48	Peak
2	0.015	5.46	55.56	61.02	124.19	63.17	Peak
3	0.021	4.19	51.72	55.91	121.02	65.11	Peak
4	0.064	7.92	40.85	48.77	111.54	62.77	Peak
5	0.096	12.88	37.03	49.91	107.99	58.08	Peak
6	0.136	56.22	34.91	91.13	104.96	13.83	Peak

Project No.: CR230953507-RF
 Tester: Carl Xue
 Polarization: Parallel
 Note:

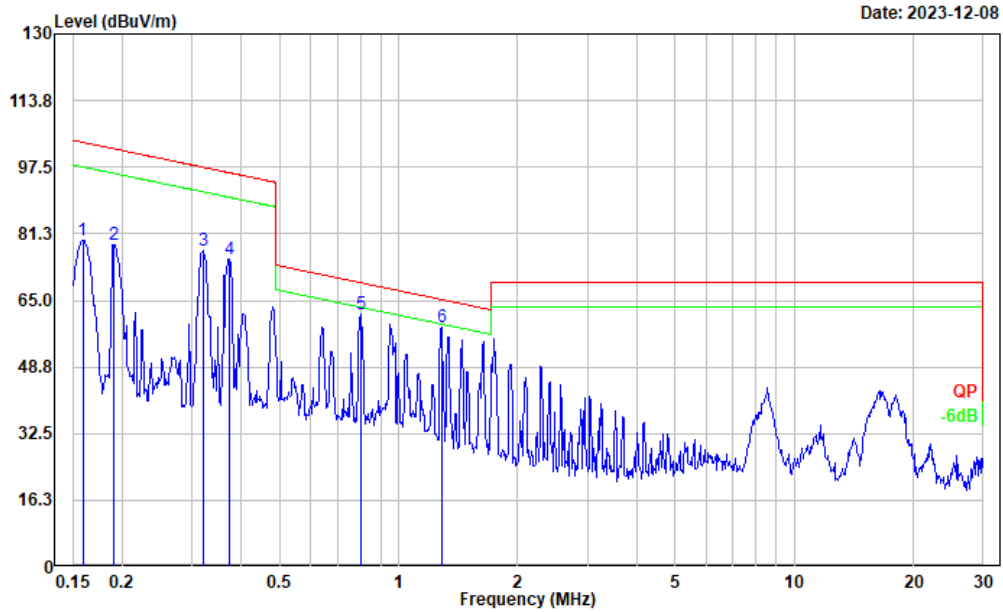

No.	Frequency (MHz)	Reading (dBμV)	Factor (dB/m)	Result (dBμV/m)	Limit (dBμV/m)	Margin (dB)	Detector
1	0.159	45.82	33.81	79.63	103.58	23.95	Peak
2	0.190	46.40	32.33	78.73	102.01	23.28	Peak
3	0.320	50.34	26.70	77.04	97.50	20.46	Peak
4	0.373	49.44	25.54	74.98	96.17	21.19	Peak
5	0.800	42.96	18.80	61.76	69.45	7.69	Peak
6	1.282	43.20	15.33	58.53	65.27	6.74	Peak

Perpendicular

Project No.: CR230953507-RF
 Tester: Carl Xue
 Polarization: Perpendicular
 Note:

Date: 2023-12-08

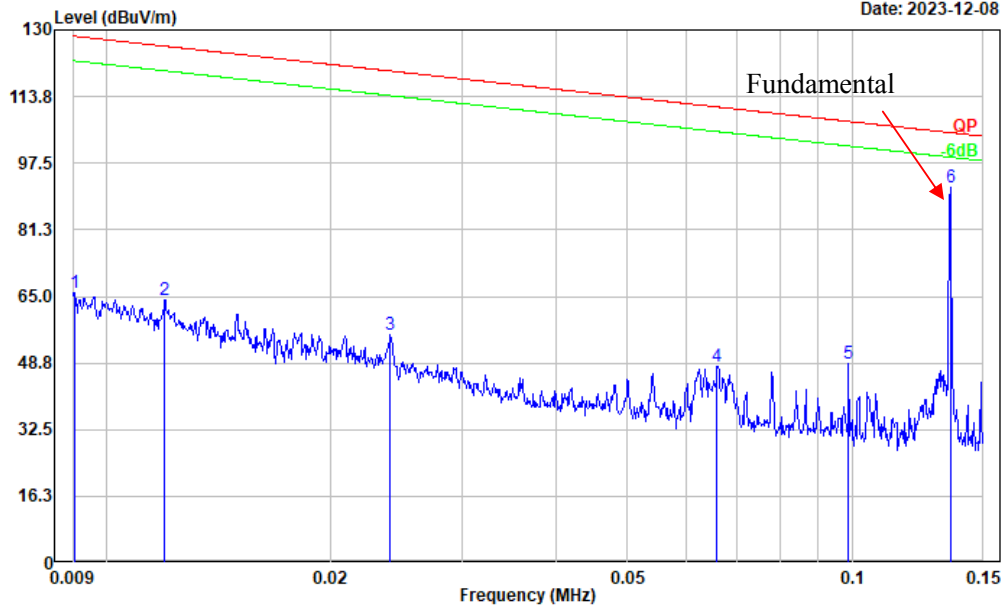

No.	Frequency (MHz)	Reading (dBμV)	Factor (dB/m)	Result (dBμV/m)	Limit (dBμV/m)	Margin (dB)	Detector
1	0.009	6.23	59.62	65.85	128.47	62.62	Peak
2	0.012	6.73	57.28	64.01	126.05	62.04	Peak
3	0.024	5.16	50.35	55.51	119.99	64.48	Peak
4	0.066	7.54	40.53	48.07	111.22	63.15	Peak
5	0.099	11.92	36.70	48.62	107.70	59.08	Peak
6	0.136	56.57	34.91	91.48	104.96	13.48	Peak

Project No.: CR230953507-RF
 Tester: Carl Xue
 Polarization: Perpendicular
 Note:

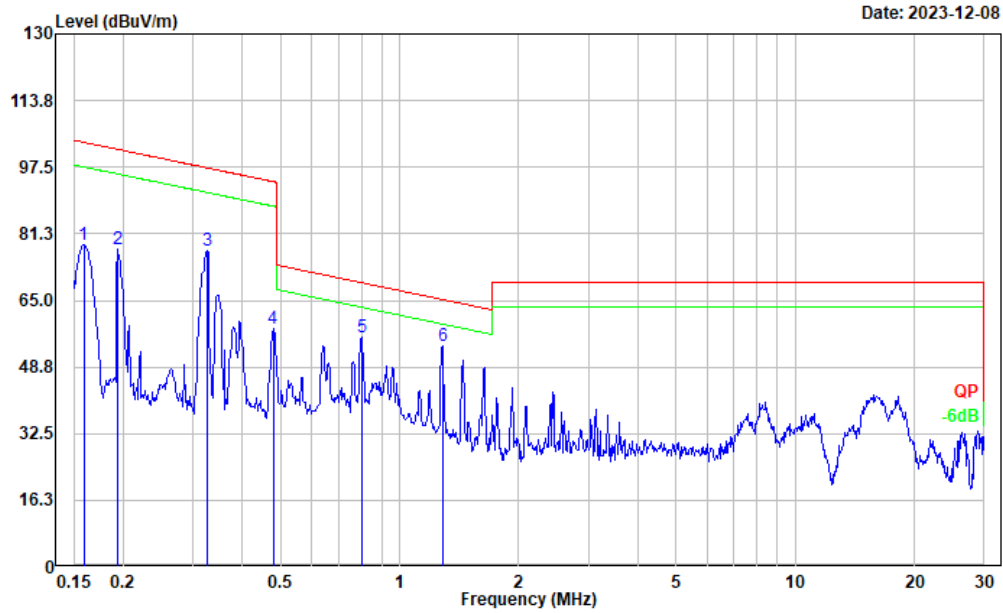

No.	Frequency (MHz)	Reading (dBμV)	Factor (dB/m)	Result (dBμV/m)	Limit (dBμV/m)	Margin (dB)	Detector
1	0.159	44.71	33.81	78.52	103.58	25.06	Peak
2	0.193	45.22	32.18	77.40	101.87	24.47	Peak
3	0.325	50.54	26.59	77.13	97.36	20.23	Peak
4	0.479	34.85	23.24	58.09	94.00	35.91	Peak
5	0.800	37.18	18.80	55.98	69.45	13.47	Peak
6	1.282	38.52	15.33	53.85	65.27	11.42	Peak

Ground-parallel

Project No.: CR230953507-RF
 Tester: Carl Xue
 Polarization: Ground-parallel
 Note:

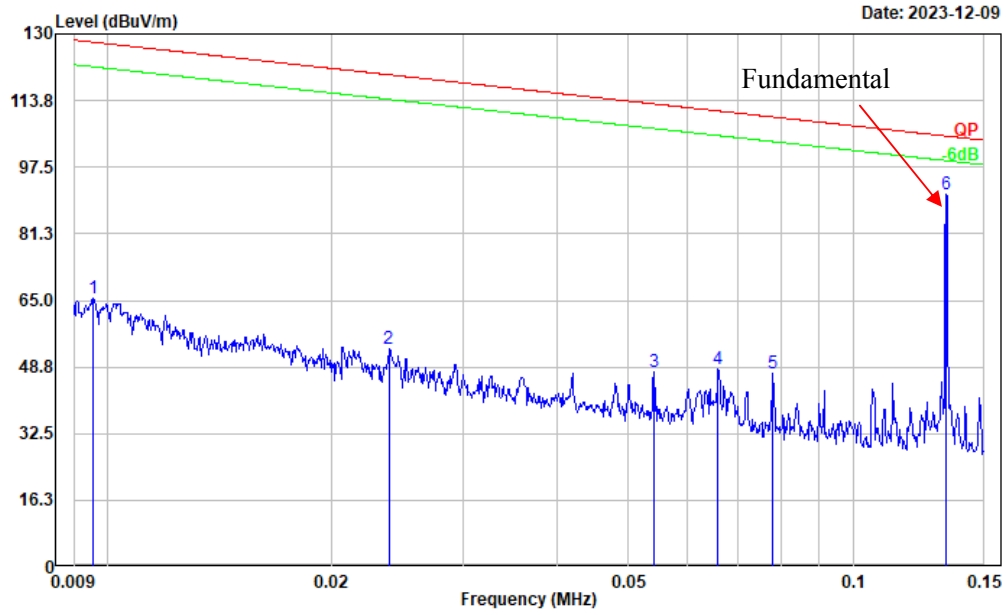

No.	Frequency (MHz)	Reading (dBμV)	Factor (dB/m)	Result (dBμV/m)	Limit (dBμV/m)	Margin (dB)	Detector
1	0.010	6.41	59.02	65.43	128.01	62.58	Peak
2	0.024	2.77	50.45	53.22	120.06	66.84	Peak
3	0.054	5.37	42.18	47.55	112.95	65.40	Peak
4	0.066	7.63	40.53	48.16	111.22	63.06	Peak
5	0.078	8.48	38.86	47.34	109.75	62.41	Peak
6	0.133	55.86	35.02	90.88	105.11	14.23	Peak

Project No.: CR230953507-RF
 Tester: Carl Xue
 Polarization: Ground-parallel
 Note:

Date: 2023-12-09

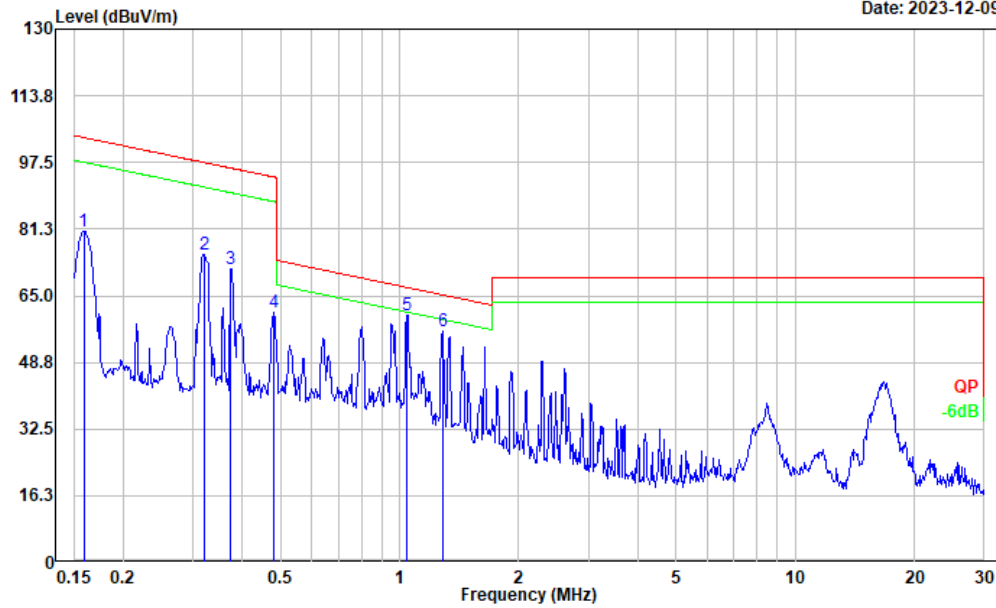

No.	Frequency (MHz)	Reading (dBμV)	Factor (dB/m)	Result (dBμV/m)	Limit (dBμV/m)	Margin (dB)	Detector
1	0.159	46.85	33.81	80.66	103.58	22.92	Peak
2	0.320	48.39	26.70	75.09	97.50	22.41	Peak
3	0.373	46.06	25.54	71.60	96.17	24.57	Peak
4	0.481	37.90	23.18	61.08	93.96	32.88	Peak
5	1.043	43.68	16.66	60.34	67.10	6.76	Peak
6	1.282	40.88	15.33	56.21	65.27	9.06	Peak

2)30MHz- 1GHz

Project No.: CR230953507-RF
 Tester: Carl Xue
 Polarization: horizontal
 Note: Light on+Airpods Wireless Charging+Type C Charging+USB Charging

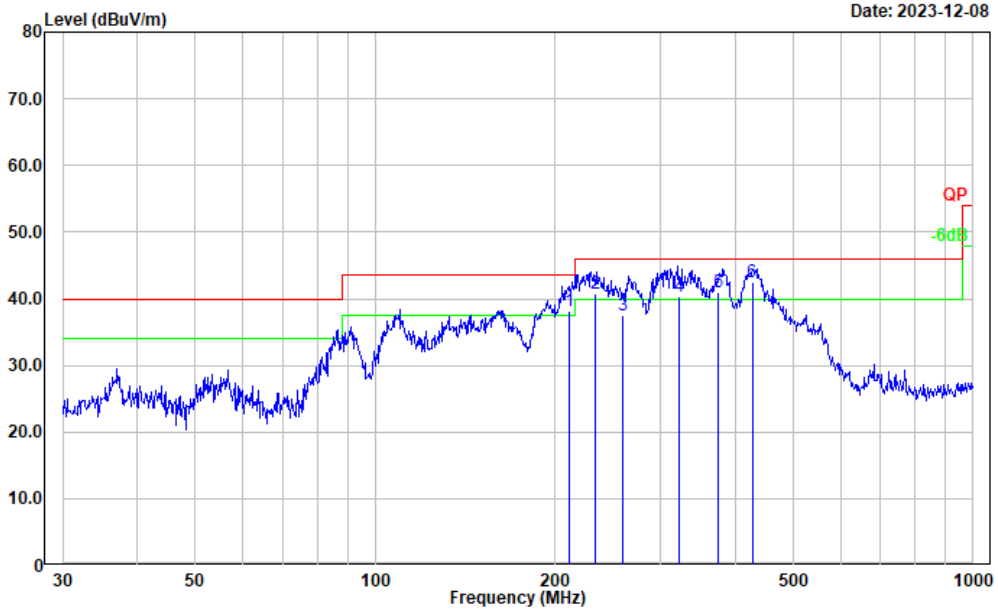

No.	Frequency (MHz)	Reading (dBμV)	Factor (dB/m)	Result (dBμV/m)	Limit (dBμV/m)	Margin (dB)	Detector
1	211.055	50.88	-12.82	38.06	43.50	5.44	QP
2	233.880	54.19	-13.40	40.79	46.00	5.21	QP
3	259.520	50.35	-12.88	37.47	46.00	8.53	QP
4	323.114	51.20	-10.78	40.42	46.00	5.58	QP
5	375.247	50.74	-9.66	41.08	46.00	4.92	QP
6	426.884	50.38	-7.92	42.46	46.00	3.54	QP

Project No.: CR230953507-RF
 Tester: Carl Xue
 Polarization: vertical
 Note: Light on+Airpods Wireless Charging+Type C Charging+USB Charging

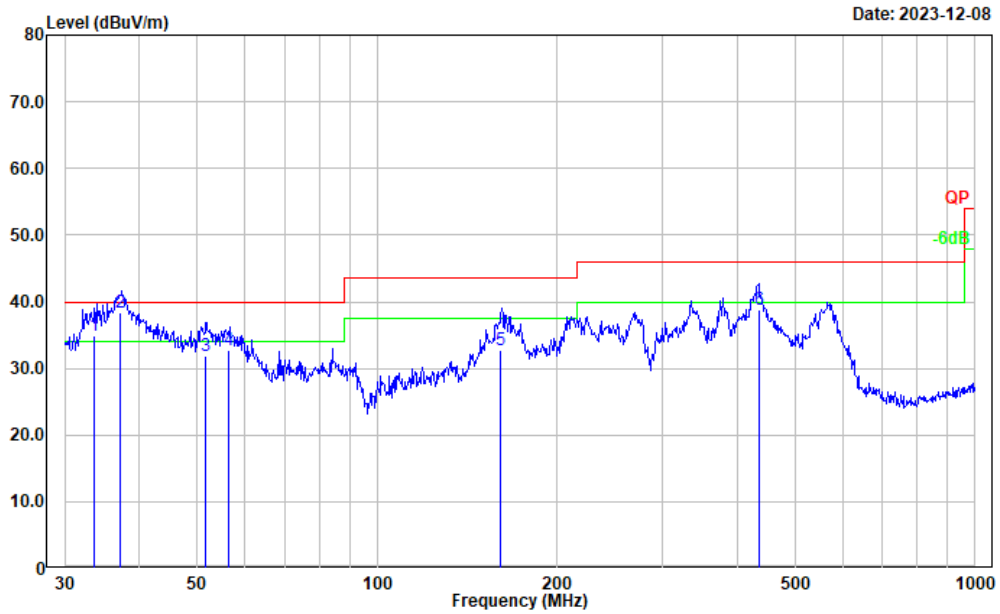

No.	Frequency (MHz)	Reading (dBμV)	Factor (dB/m)	Result (dBμV/m)	Limit (dBμV/m)	Margin (dB)	Detector
1	33.657	41.65	-6.70	34.95	40.00	5.05	QP
2	37.234	47.71	-9.42	38.29	40.00	1.71	QP
3	51.569	49.15	-17.26	31.89	40.00	8.11	QP
4	56.523	50.18	-17.37	32.81	40.00	7.19	QP
5	161.081	45.05	-12.30	32.75	43.50	10.75	QP
6	435.887	46.51	-7.65	38.86	46.00	7.14	QP

M4:
1)9k-30MHz:
Parallel

Project No.: CR230953507-RF
 Tester: Carl Xue
 Polarization: Parallel
 Note:

Date: 2023-12-08

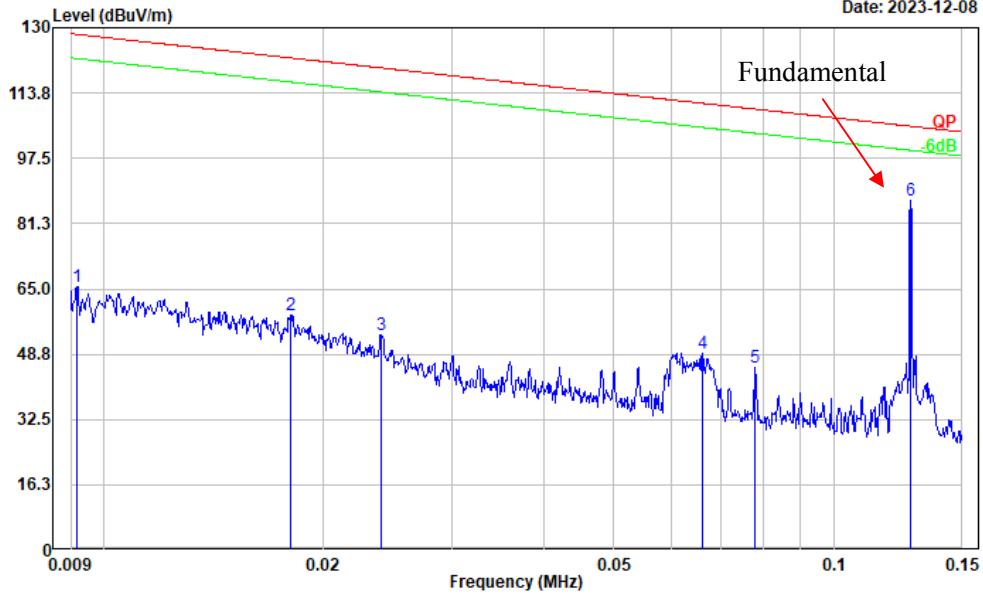

No.	Frequency (MHz)	Reading (dBμV)	Factor (dB/m)	Result (dBμV/m)	Limit (dBμV/m)	Margin (dB)	Detector
1	0.009	6.18	59.47	65.65	128.35	62.70	Peak
2	0.018	4.82	53.60	58.42	122.48	64.06	Peak
3	0.024	3.15	50.38	53.53	120.02	66.49	Peak
4	0.066	8.37	40.50	48.87	111.19	62.32	Peak
5	0.078	6.48	38.86	45.34	109.75	64.41	Peak
6	0.127	51.56	35.30	86.86	105.50	18.64	Peak

Project No.: CR230953507-RF
 Tester: Carl Xue
 Polarization: Parallel
 Note:

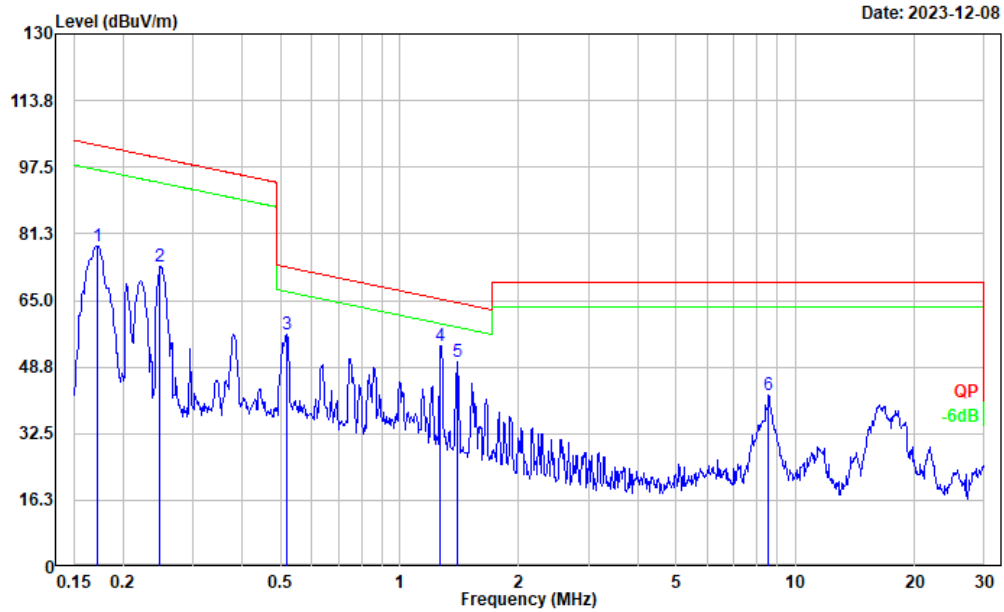

No.	Frequency (MHz)	Reading (dB μ V)	Factor (dB/m)	Result (dB μ V/m)	Limit (dB μ V/m)	Margin (dB)	Detector
1	0.172	45.17	33.18	78.35	102.89	24.54	Peak
2	0.248	43.64	29.58	73.22	99.71	26.49	Peak
3	0.518	34.09	22.53	56.62	73.30	16.68	Peak
4	1.269	38.61	15.40	54.01	65.36	11.35	Peak
5	1.396	35.39	14.70	50.09	64.51	14.42	Peak
6	8.546	38.53	3.27	41.80	69.54	27.74	Peak

Perpendicular

Project No.: CR230953507-RF
 Tester: Carl Xue
 Polarization: Perpendicular
 Note:

Date: 2023-12-08

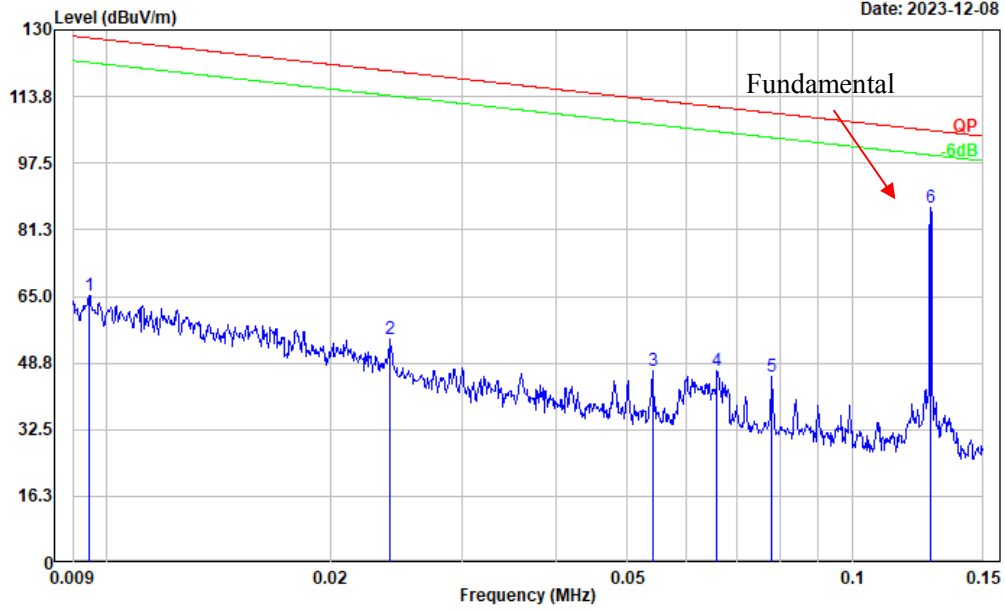

No.	Frequency (MHz)	Reading (dBμV)	Factor (dB/m)	Result (dBμV/m)	Limit (dBμV/m)	Margin (dB)	Detector
1	0.009	6.12	59.12	65.24	128.08	62.84	Peak
2	0.024	4.17	50.35	54.52	119.99	65.47	Peak
3	0.054	4.76	42.18	46.94	112.95	66.01	Peak
4	0.066	6.38	40.53	46.91	111.22	64.31	Peak
5	0.078	6.50	38.86	45.36	109.75	64.39	Peak
6	0.127	51.43	35.30	86.73	105.50	18.77	Peak

Project No.: CR230953507-RF
 Tester: Carl Xue
 Polarization: Perpendicular
 Note:

Date: 2023-12-08

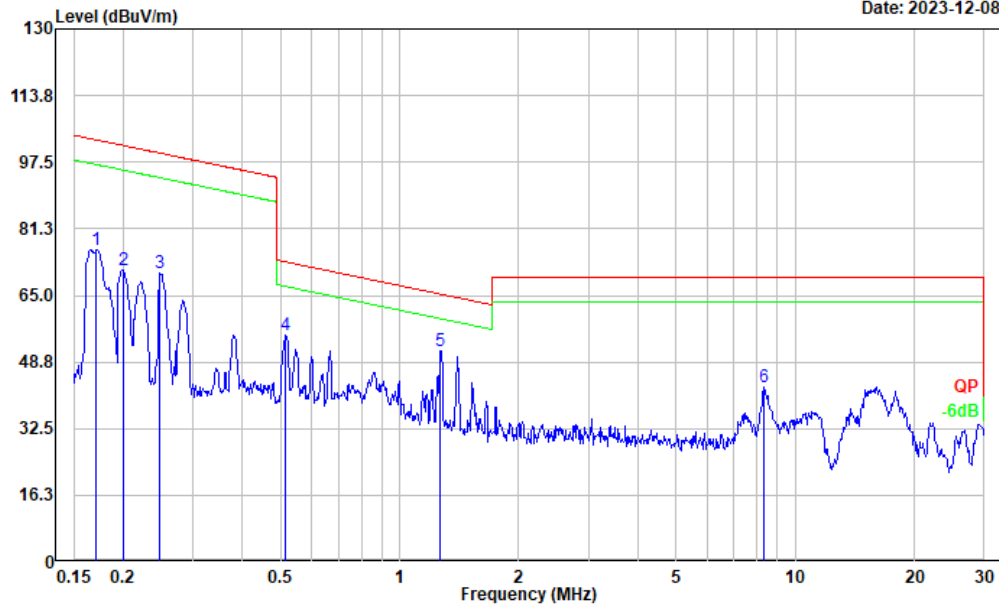

No.	Frequency (MHz)	Reading (dBμV)	Factor (dB/m)	Result (dBμV/m)	Limit (dBμV/m)	Margin (dB)	Detector
1	0.171	42.77	33.23	76.00	102.93	26.93	Peak
2	0.200	39.14	31.88	71.02	101.60	30.58	Peak
3	0.248	40.72	29.58	70.30	99.71	29.41	Peak
4	0.516	32.63	22.56	55.19	73.35	18.16	Peak
5	1.269	36.01	15.40	51.41	65.36	13.95	Peak
6	8.323	39.37	3.32	42.69	69.54	26.85	Peak

Ground-parallel

Project No.: CR230953507-RF
 Tester: Carl Xue
 Polarization: Ground-parallel
 Note:

Date: 2023-12-09

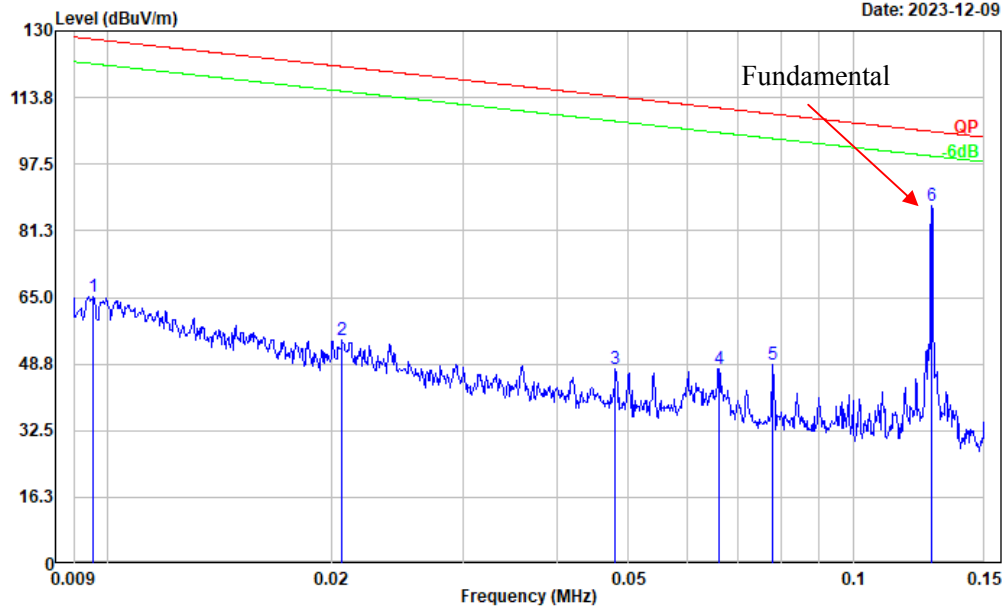

No.	Frequency (MHz)	Reading (dBμV)	Factor (dB/m)	Result (dBμV/m)	Limit (dBμV/m)	Margin (dB)	Detector
1	0.010	6.31	59.00	65.31	127.99	62.68	Peak
2	0.021	2.40	52.08	54.48	121.31	66.83	Peak
3	0.048	4.22	43.19	47.41	113.98	66.57	Peak
4	0.066	7.20	40.50	47.70	111.19	63.49	Peak
5	0.078	9.85	38.86	48.71	109.75	61.04	Peak
6	0.127	52.07	35.30	87.37	105.50	18.13	Peak

Project No.: CR230953507-RF
 Tester: Carl Xue
 Polarization: Ground-parallel
 Note:

Date: 2023-12-09

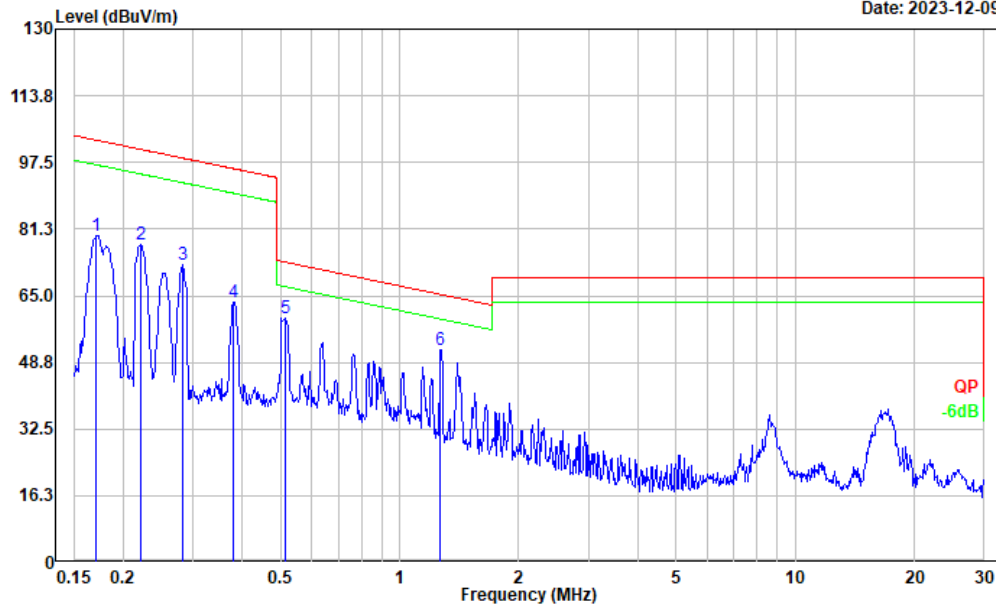

No.	Frequency (MHz)	Reading (dBμV)	Factor (dB/m)	Result (dBμV/m)	Limit (dBμV/m)	Margin (dB)	Detector
1	0.171	46.44	33.23	79.67	102.93	23.26	Peak
2	0.221	46.58	30.88	77.46	100.72	23.26	Peak
3	0.283	44.56	27.93	72.49	98.56	26.07	Peak
4	0.381	38.06	25.37	63.43	95.98	32.55	Peak
5	0.513	37.00	22.60	59.60	73.40	13.80	Peak
6	1.269	36.46	15.40	51.86	65.36	13.50	Peak

2)30MHz- 1GHz

Project No.: CR230953507-RF
 Tester: Carl Xue
 Polarization: horizontal
 Note: Wireless Charging (Phone horizontal) +Type C Charging

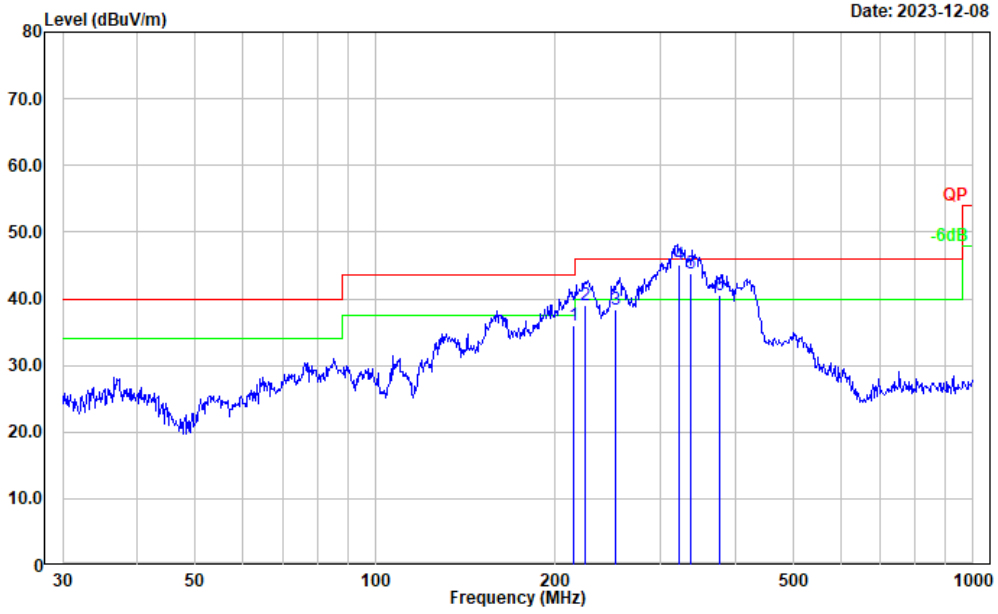

No.	Frequency (MHz)	Reading (dBμV)	Factor (dB/m)	Result (dBμV/m)	Limit (dBμV/m)	Margin (dB)	Detector
1	214.812	48.94	-12.95	35.99	43.50	7.51	QP
2	224.935	52.24	-13.21	39.03	46.00	6.97	QP
3	252.913	51.64	-13.31	38.33	46.00	7.67	QP
4	321.854	55.83	-10.81	45.02	46.00	0.98	QP
5	337.703	54.25	-10.42	43.83	46.00	2.17	QP
6	376.665	50.18	-9.58	40.60	46.00	5.40	QP

Project No.: CR230953507-RF
 Tester: Carl Xue
 Polarization: vertical
 Note: Wireless Charging (Phone horizontal) +Type C Charging

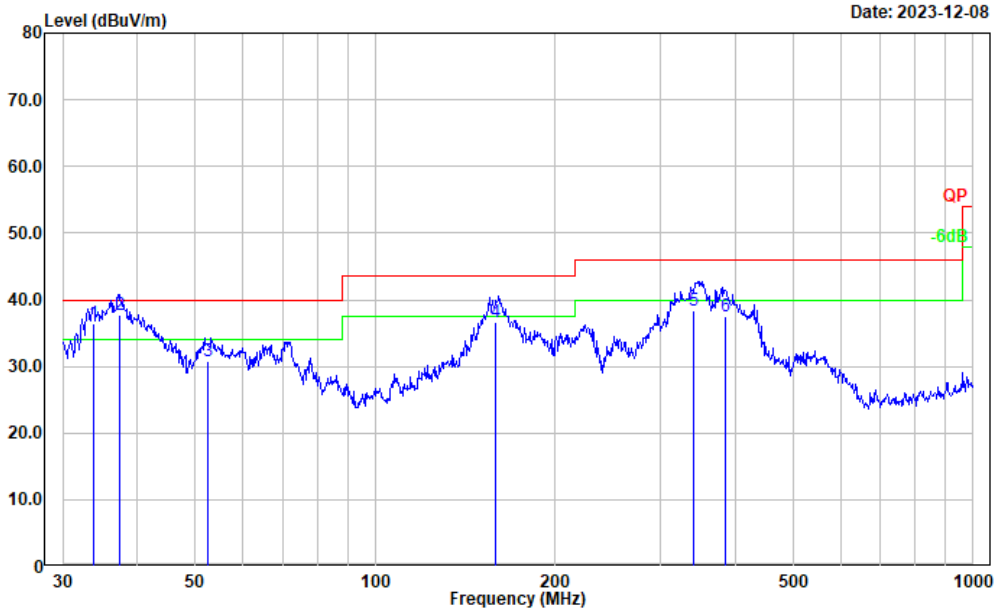

No.	Frequency (MHz)	Reading (dBμV)	Factor (dB/m)	Result (dBμV/m)	Limit (dBμV/m)	Margin (dB)	Detector
1	33.762	43.11	-6.78	36.33	40.00	3.67	QP
2	37.320	47.23	-9.48	37.75	40.00	2.25	QP
3	52.605	47.96	-17.28	30.68	40.00	9.32	QP
4	158.575	48.72	-12.17	36.55	43.50	6.95	QP
5	341.241	48.71	-10.37	38.34	46.00	7.66	QP
6	384.120	46.90	-9.34	37.56	46.00	8.44	QP

M5
1)9k-30MHz:
Parallel

Project No.: CR230953507-RF
 Tester: Carl Xue
 Polarization: Parallel
 Note:

Date: 2023-12-08

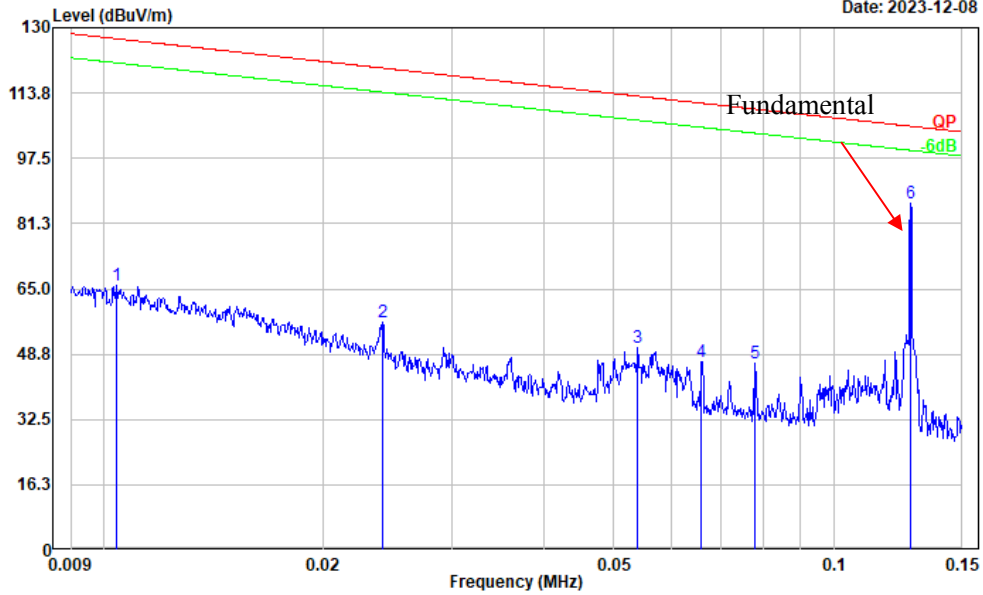

No.	Frequency (MHz)	Reading (dB μ V)	Factor (dB/m)	Result (dB μ V/m)	Limit (dB μ V/m)	Margin (dB)	Detector
1	0.010	7.50	58.23	65.73	127.27	61.54	Peak
2	0.024	6.58	50.31	56.89	119.97	63.08	Peak
3	0.054	8.11	42.20	50.31	112.98	62.67	Peak
4	0.066	6.31	40.53	46.84	111.22	64.38	Peak
5	0.078	7.59	38.86	46.45	109.75	63.30	Peak
6	0.127	51.08	35.30	86.38	105.50	19.12	Peak

Project No.: CR230953507-RF
 Tester: Carl Xue
 Polarization: Parallel
 Note:

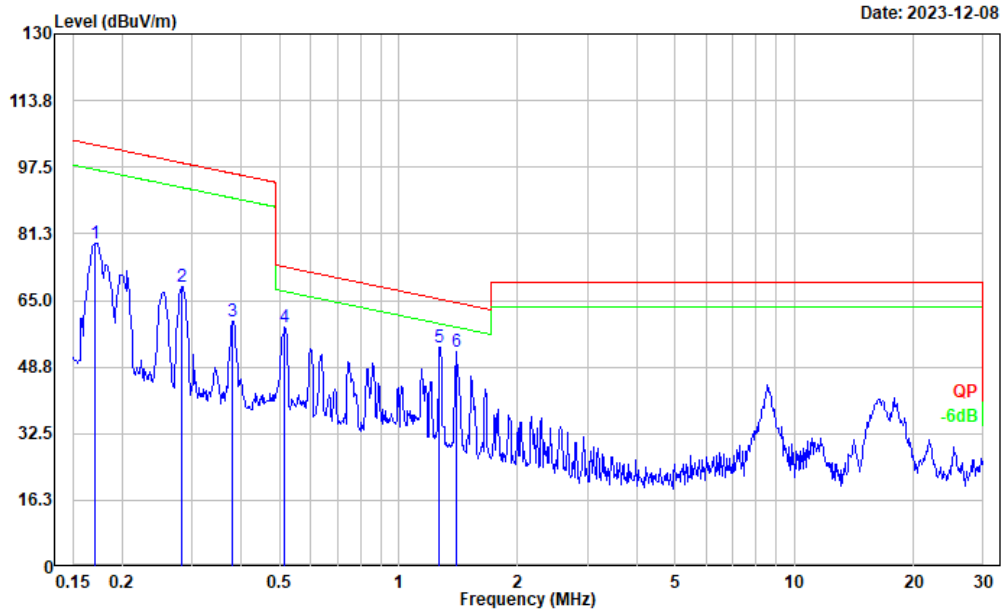

No.	Frequency (MHz)	Reading (dBμV)	Factor (dB/m)	Result (dBμV/m)	Limit (dBμV/m)	Margin (dB)	Detector
1	0.171	45.78	33.23	79.01	102.93	23.92	Peak
2	0.283	40.55	27.93	68.48	98.56	30.08	Peak
3	0.381	34.61	25.37	59.98	95.98	36.00	Peak
4	0.516	35.81	22.56	58.37	73.35	14.98	Peak
5	1.269	38.21	15.40	53.61	65.36	11.75	Peak
6	1.396	37.68	14.70	52.38	64.51	12.13	Peak

Perpendicular

Project No.: CR230953507-RF
 Tester: Carl Xue
 Polarization: Perpendicular
 Note:

Date: 2023-12-08

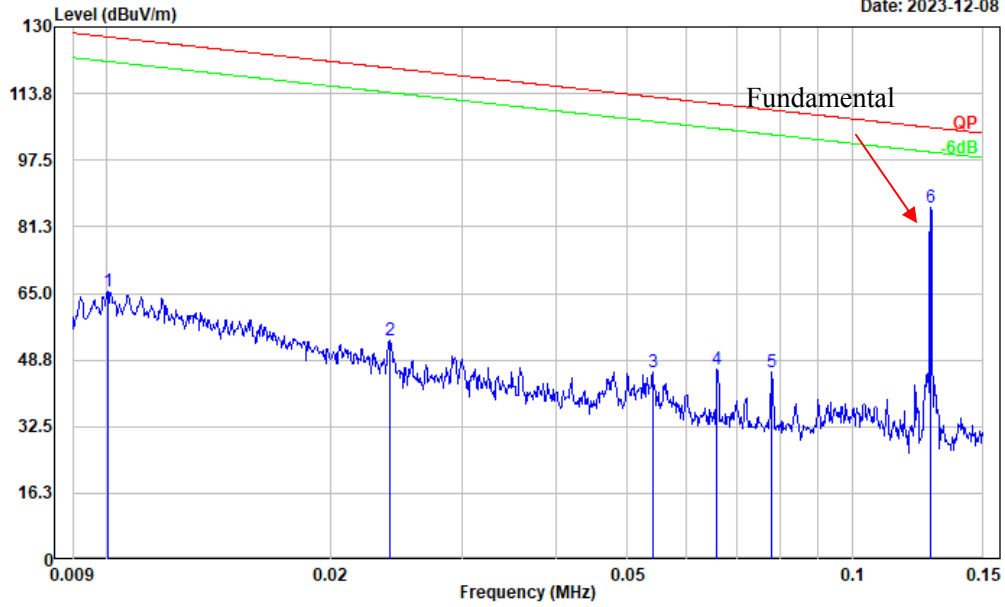

No.	Frequency (MHz)	Reading (dBμV)	Factor (dB/m)	Result (dBμV/m)	Limit (dBμV/m)	Margin (dB)	Detector
1	0.010	7.00	58.46	65.46	127.59	62.13	Peak
2	0.024	3.29	50.35	53.64	119.99	66.35	Peak
3	0.054	3.74	42.18	45.92	112.95	67.03	Peak
4	0.066	6.04	40.53	46.57	111.22	64.65	Peak
5	0.078	6.84	38.86	45.70	109.75	64.05	Peak
6	0.127	50.75	35.30	86.05	105.50	19.45	Peak

Project No.: CR230953507-RF
 Tester: Carl Xue
 Polarization: Perpendicular
 Note:

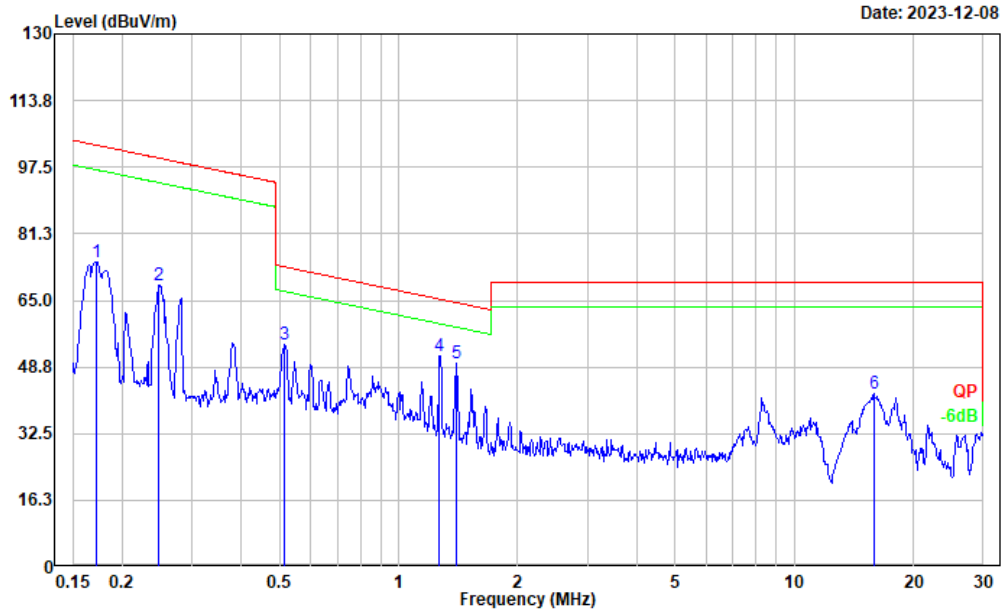

No.	Frequency (MHz)	Reading (dBμV)	Factor (dB/m)	Result (dBμV/m)	Limit (dBμV/m)	Margin (dB)	Detector
1	0.172	41.22	33.18	74.40	102.89	28.49	Peak
2	0.248	39.13	29.58	68.71	99.71	31.00	Peak
3	0.516	31.65	22.56	54.21	73.35	19.14	Peak
4	1.269	36.11	15.40	51.51	65.36	13.85	Peak
5	1.403	35.13	14.66	49.79	64.47	14.68	Peak
6	15.885	40.25	2.12	42.37	69.54	27.17	Peak

Ground-parallel

Project No.: CR230953507-RF
 Tester: Carl Xue
 Polarization: Ground-parallel
 Note:

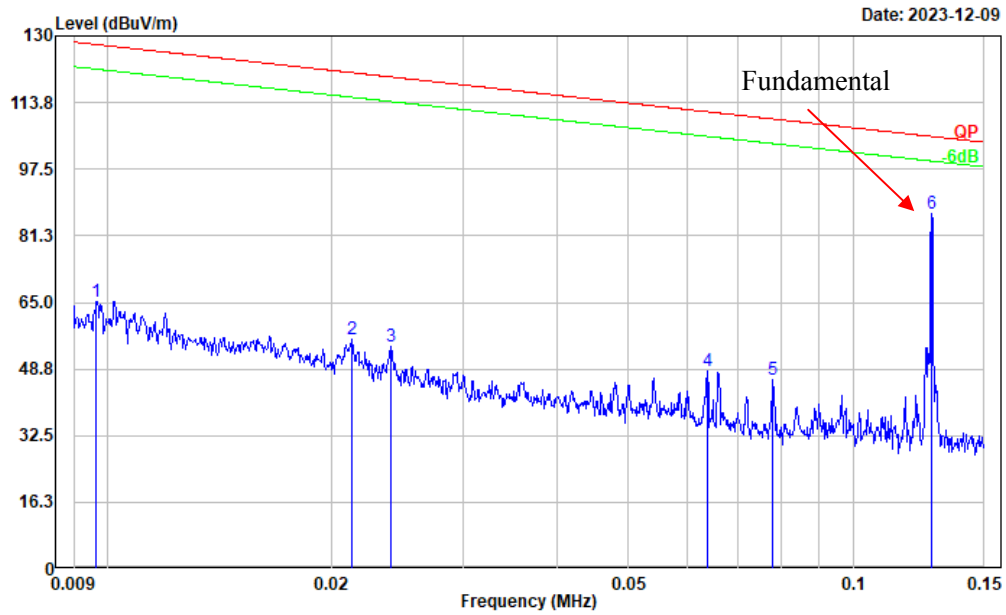

No.	Frequency (MHz)	Reading (dBμV)	Factor (dB/m)	Result (dBμV/m)	Limit (dBμV/m)	Margin (dB)	Detector
1	0.010	6.42	58.89	65.31	127.91	62.60	Peak
2	0.021	4.12	51.75	55.87	121.04	65.17	Peak
3	0.024	3.92	50.35	54.27	119.99	65.72	Peak
4	0.064	7.33	40.83	48.16	111.51	63.35	Peak
5	0.078	7.41	38.86	46.27	109.75	63.48	Peak
6	0.127	51.21	35.30	86.51	105.50	18.99	Peak

Project No.: CR230953507-RF
 Tester: Carl Xue
 Polarization: Ground-parallel
 Note:

Date: 2023-12-09

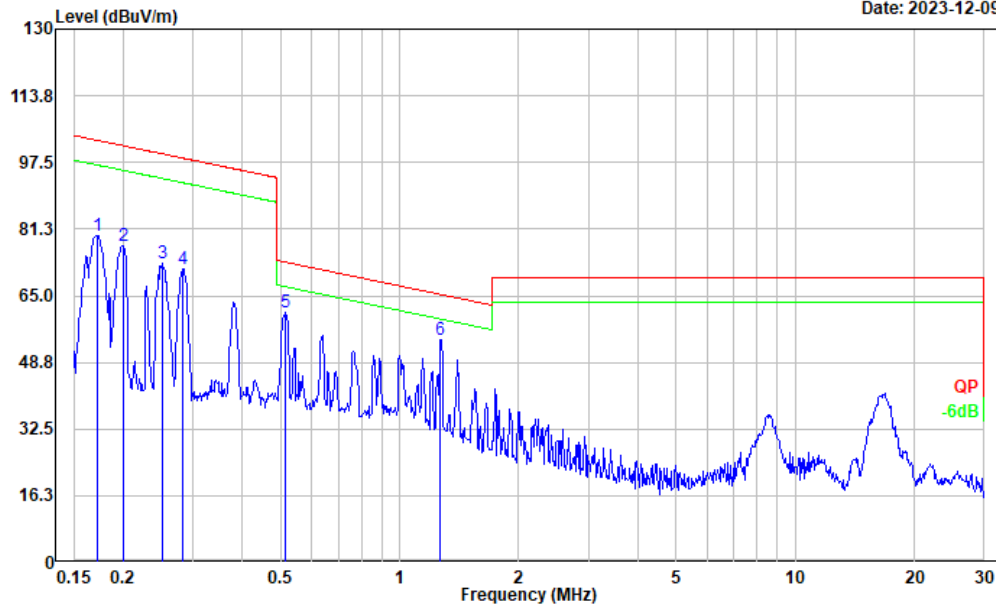

No.	Frequency (MHz)	Reading (dBμV)	Factor (dB/m)	Result (dBμV/m)	Limit (dBμV/m)	Margin (dB)	Detector
1	0.172	46.54	33.18	79.72	102.89	23.17	Peak
2	0.200	45.17	31.88	77.05	101.60	24.55	Peak
3	0.251	43.47	29.48	72.95	99.62	26.67	Peak
4	0.283	43.58	27.93	71.51	98.56	27.05	Peak
5	0.516	38.22	22.56	60.78	73.35	12.57	Peak
6	1.269	38.88	15.40	54.28	65.36	11.08	Peak

2)30MHz- 1GHz

Project No.: CR230953507-RF
 Tester: Carl Xue
 Polarization: horizontal
 Note: Wireless Charging (Phone horizontal) + USB Charging

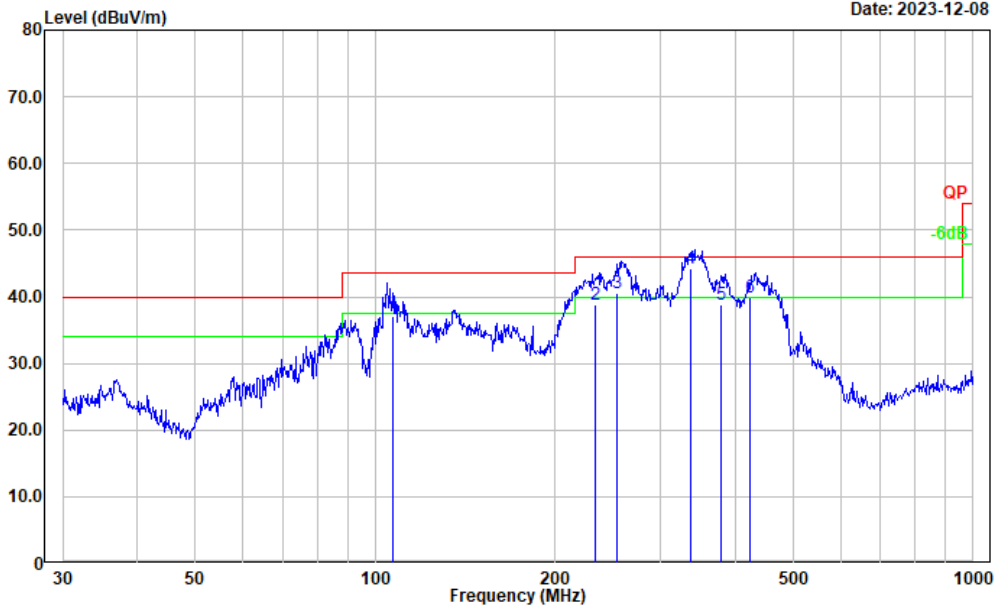

No.	Frequency (MHz)	Reading (dBμV)	Factor (dB/m)	Result (dBμV/m)	Limit (dBμV/m)	Margin (dB)	Detector
1	106.903	50.19	-13.13	37.06	43.50	6.44	QP
2	233.099	52.19	-13.38	38.81	46.00	7.19	QP
3	253.939	53.71	-13.26	40.45	46.00	5.55	QP
4	336.936	54.70	-10.44	44.26	46.00	1.74	QP
5	378.707	48.31	-9.51	38.80	46.00	7.20	QP
6	424.388	47.83	-8.01	39.82	46.00	6.18	QP

Project No.: CR230953507-RF
 Tester: Carl Xue
 Polarization: vertical
 Note: Wireless Charging (Phone horizontal) + USB Charging

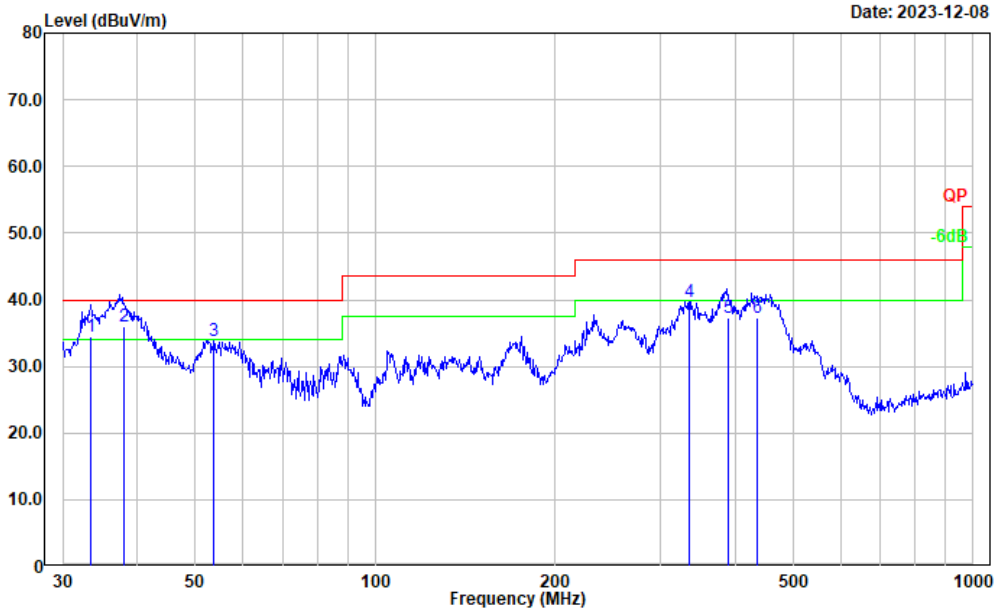

No.	Frequency (MHz)	Reading (dBμV)	Factor (dB/m)	Result (dBμV/m)	Limit (dBμV/m)	Margin (dB)	Detector
1	33.448	40.97	-6.55	34.42	40.00	5.58	QP
2	37.932	45.95	-9.90	36.05	40.00	3.95	QP
3	53.693	51.21	-17.31	33.90	40.00	6.10	Peak
4	334.859	50.14	-10.48	39.66	46.00	6.34	Peak
5	388.828	46.65	-9.26	37.39	46.00	8.61	QP
6	434.515	45.00	-7.69	37.31	46.00	8.69	QP

M6:
1)9k-30MHz:
Parallel

Project No.: CR230953507-RF
 Tester: Carl Xue
 Polarization: Parallel
 Note:

Date: 2023-12-09

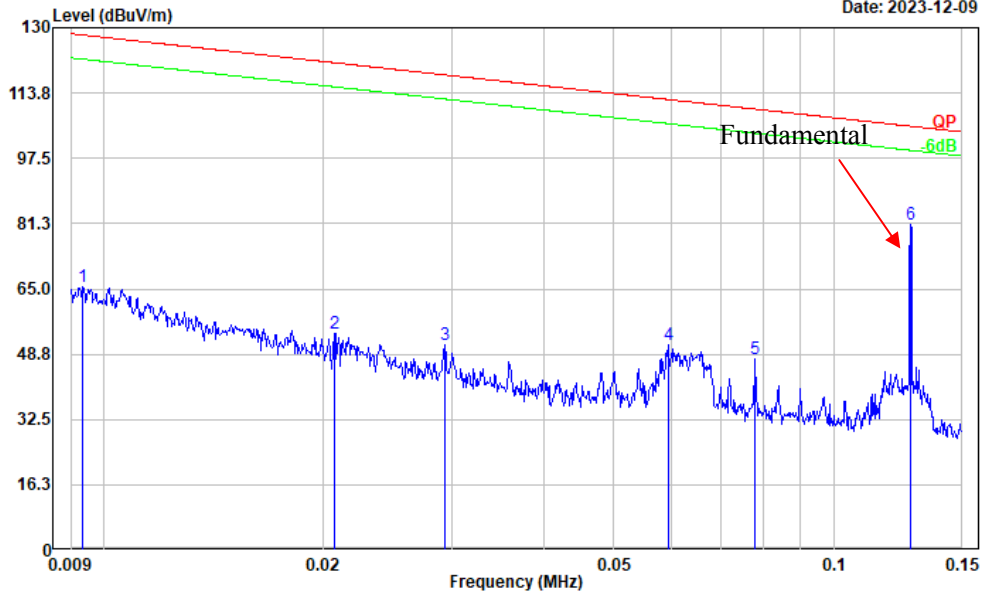

No.	Frequency (MHz)	Reading (dBμV)	Factor (dB/m)	Result (dBμV/m)	Limit (dBμV/m)	Margin (dB)	Detector
1	0.009	6.29	59.24	65.53	128.18	62.65	Peak
2	0.021	1.95	52.05	54.00	121.29	67.29	Peak
3	0.029	3.47	47.62	51.09	118.26	67.17	Peak
4	0.059	9.62	41.45	51.07	112.15	61.08	Peak
5	0.078	8.59	38.86	47.45	109.75	62.30	Peak
6	0.127	45.59	35.30	80.89	105.50	24.61	Peak

Project No.: CR230953507-RF
 Tester: Carl Xue
 Polarization: Parallel
 Note:

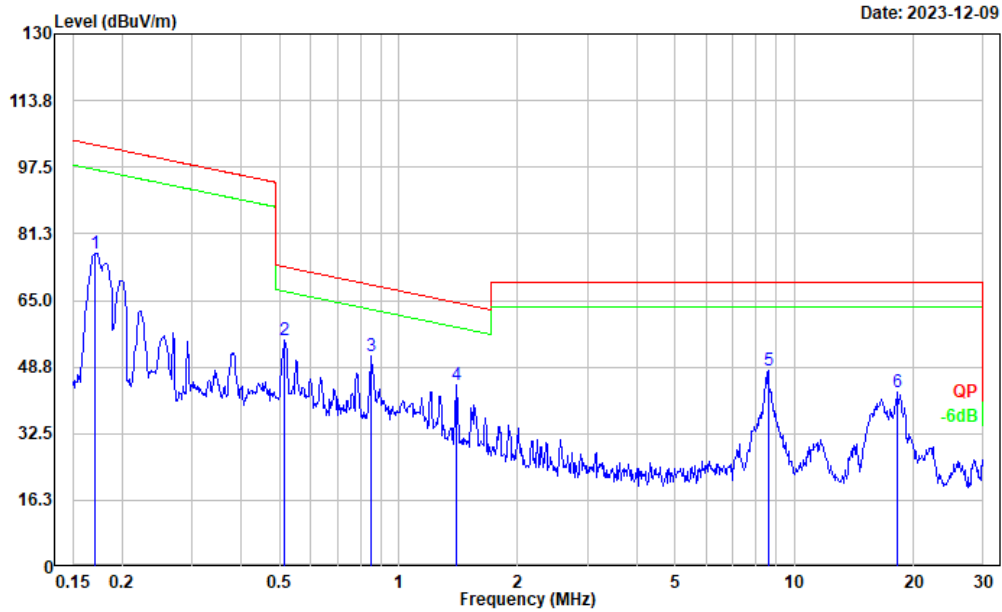

No.	Frequency (MHz)	Reading (dBμV)	Factor (dB/m)	Result (dBμV/m)	Limit (dBμV/m)	Margin (dB)	Detector
1	0.171	43.34	33.23	76.57	102.93	26.36	Peak
2	0.516	32.76	22.56	55.32	73.35	18.03	Peak
3	0.853	33.21	18.30	51.51	68.89	17.38	Peak
4	1.403	29.85	14.66	44.51	64.47	19.96	Peak
5	8.592	44.64	3.25	47.89	69.54	21.65	Peak
6	18.135	40.70	2.01	42.71	69.54	26.83	Peak

Perpendicular

Project No.: CR230953507-RF
 Tester: Carl Xue
 Polarization: Perpendicular
 Note:

Date: 2023-12-09

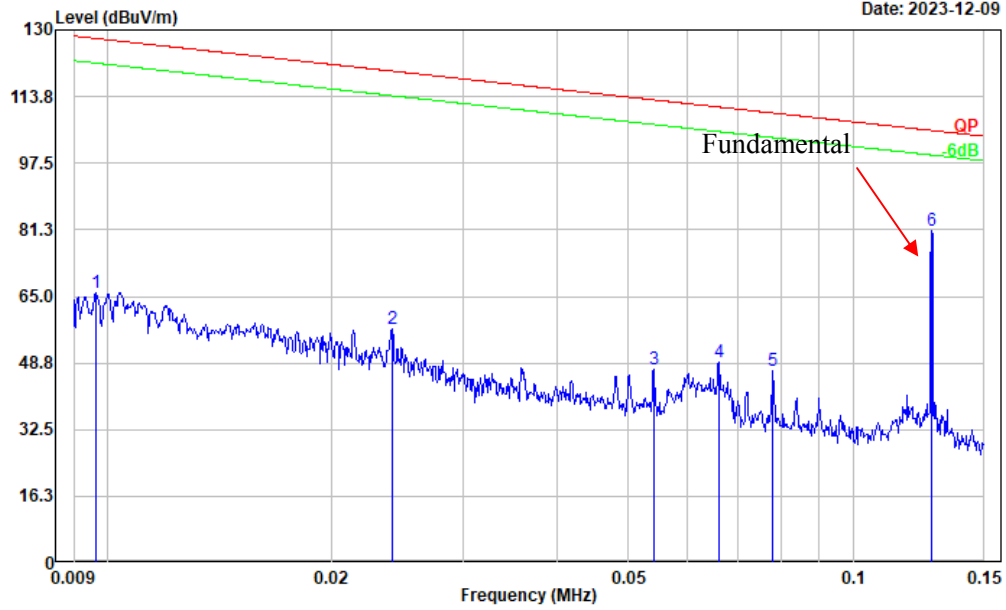

No.	Frequency (MHz)	Reading (dBμV)	Factor (dB/m)	Result (dBμV/m)	Limit (dBμV/m)	Margin (dB)	Detector
1	0.010	7.11	58.92	66.03	127.93	61.90	Peak
2	0.024	6.88	50.31	57.19	119.97	62.78	Peak
3	0.054	5.09	42.18	47.27	112.95	65.68	Peak
4	0.066	8.50	40.50	49.00	111.19	62.19	Peak
5	0.078	8.03	38.86	46.89	109.75	62.86	Peak
6	0.127	45.66	35.30	80.96	105.50	24.54	Peak

Project No.: CR230953507-RF
 Tester: Carl Xue
 Polarization: Perpendicular
 Note:

Date: 2023-12-09

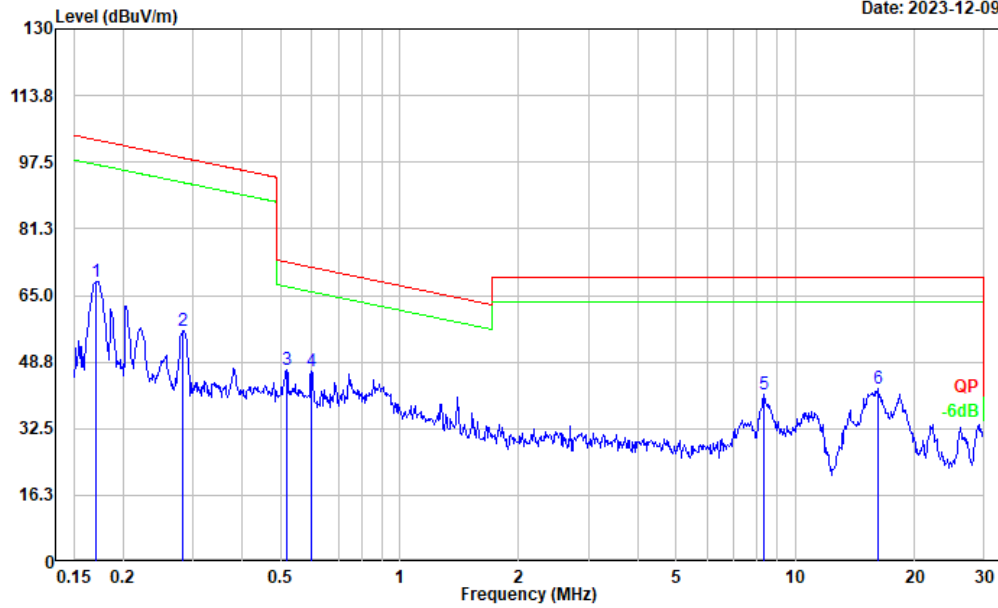

No.	Frequency (MHz)	Reading (dBμV)	Factor (dB/m)	Result (dBμV/m)	Limit (dBμV/m)	Margin (dB)	Detector
1	0.171	35.11	33.23	68.34	102.93	34.59	Peak
2	0.283	28.61	27.93	56.54	98.56	42.02	Peak
3	0.518	24.49	22.53	47.02	73.30	26.28	Peak
4	0.598	24.88	21.46	46.34	72.03	25.69	Peak
5	8.323	37.69	3.32	41.01	69.54	28.53	Peak
6	16.140	40.03	2.10	42.13	69.54	27.41	Peak

Ground-parallel

Project No.: CR230953507-RF
 Tester: Carl Xue
 Polarization: Ground-parallel
 Note:

Date: 2023-12-09

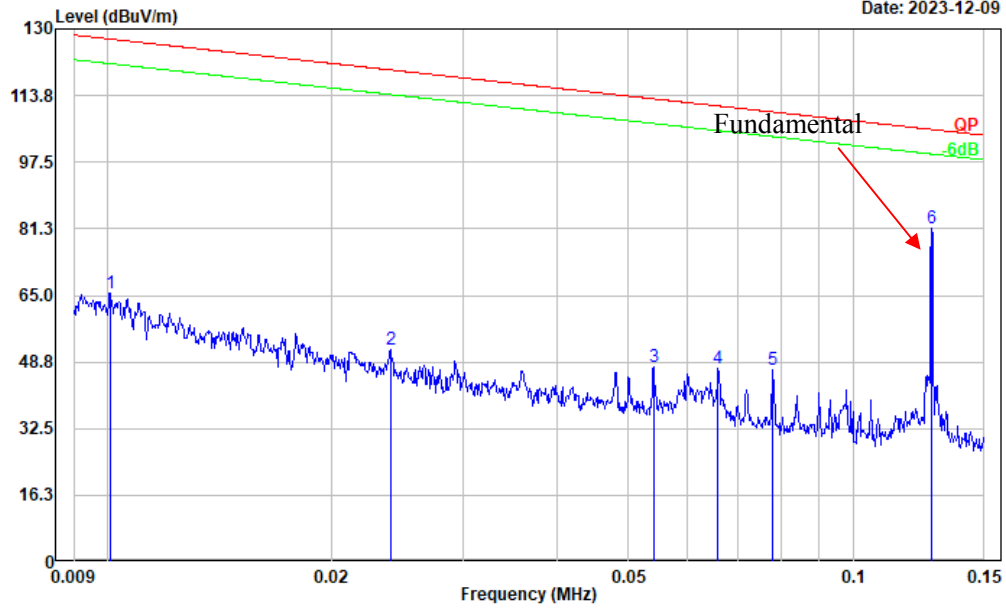

No.	Frequency (MHz)	Reading (dBμV)	Factor (dB/m)	Result (dBμV/m)	Limit (dBμV/m)	Margin (dB)	Detector
1	0.010	7.24	58.43	65.67	127.54	61.87	Peak
2	0.024	1.34	50.38	51.72	120.02	68.30	Peak
3	0.054	5.51	42.18	47.69	112.95	65.26	Peak
4	0.066	6.64	40.53	47.17	111.22	64.05	Peak
5	0.078	7.87	38.86	46.73	109.75	63.02	Peak
6	0.127	46.08	35.30	81.38	105.50	24.12	Peak

Project No.: CR230953507-RF
 Tester: Carl Xue
 Polarization: Ground-parallel
 Note:

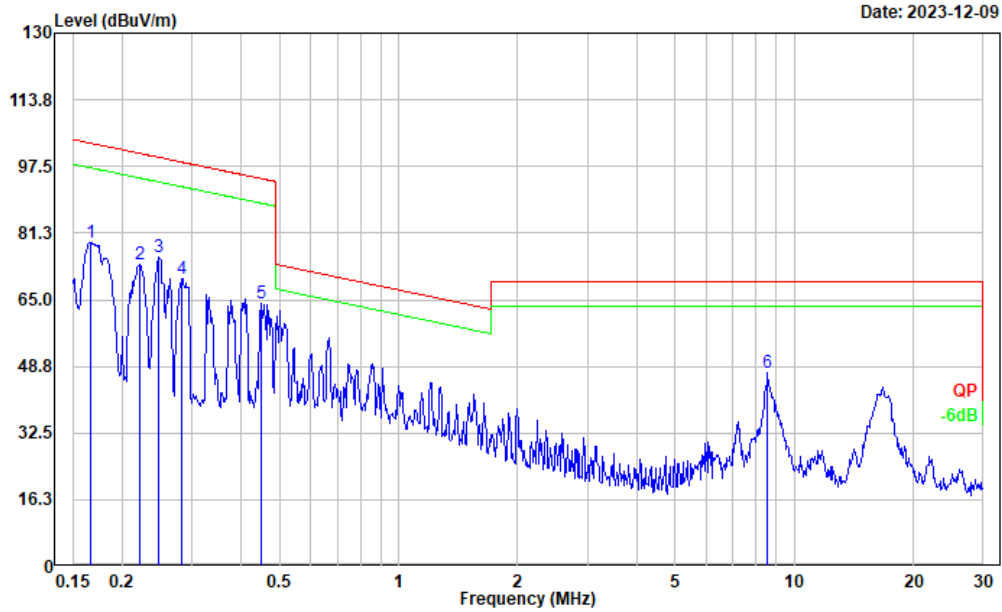

No.	Frequency (MHz)	Reading (dBμV)	Factor (dB/m)	Result (dBμV/m)	Limit (dBμV/m)	Margin (dB)	Detector
1	0.166	45.52	33.48	79.00	103.21	24.21	Peak
2	0.221	42.59	30.88	73.47	100.72	27.25	Peak
3	0.247	45.74	29.65	75.39	99.76	24.37	Peak
4	0.283	42.11	27.93	70.04	98.56	28.52	Peak
5	0.449	40.14	23.87	64.01	94.56	30.55	Peak
6	8.546	43.95	3.27	47.22	69.54	22.32	Peak

2)30MHz- 1GHz

Project No.: CR230953507-RF
 Tester: Carl Xue
 Polarization: horizontal
 Note: Wireless Charging (Phone vertical) +Type C Charging

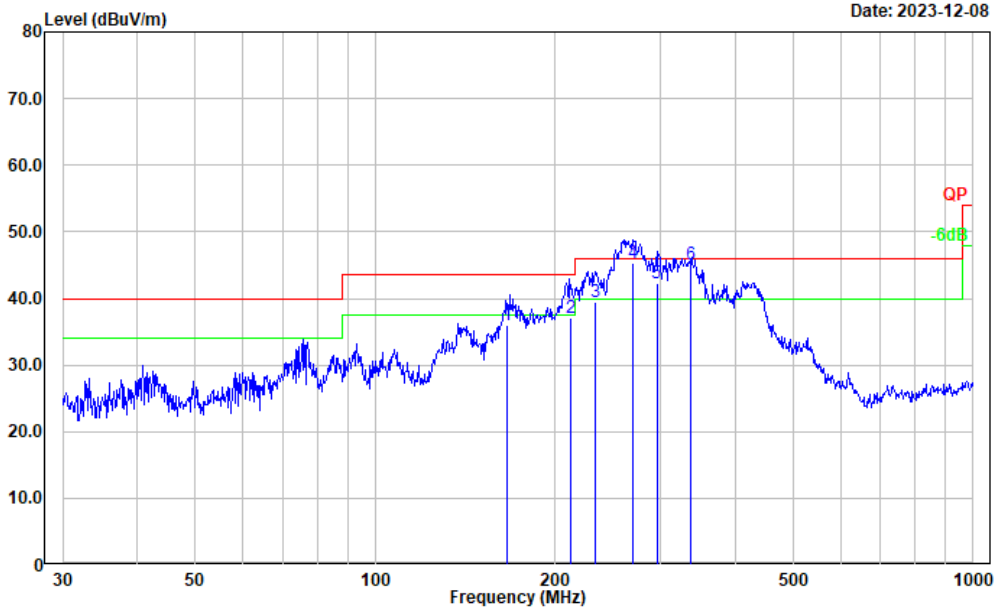

No.	Frequency (MHz)	Reading (dBμV)	Factor (dB/m)	Result (dBμV/m)	Limit (dBμV/m)	Margin (dB)	Detector
1	166.490	48.77	-12.71	36.06	43.50	7.44	QP
2	211.983	49.97	-12.86	37.11	43.50	6.39	QP
3	233.479	52.83	-13.39	39.44	46.00	6.56	QP
4	270.375	57.79	-12.47	45.32	46.00	0.68	QP
5	295.609	53.29	-11.11	42.18	46.00	3.82	QP
6	336.061	55.65	-10.46	45.19	46.00	0.81	QP

Project No.: CR230953507-RF
 Tester: Carl Xue
 Polarization: vertical
 Note: Wireless Charging (Phone vertical) +Type C Charging

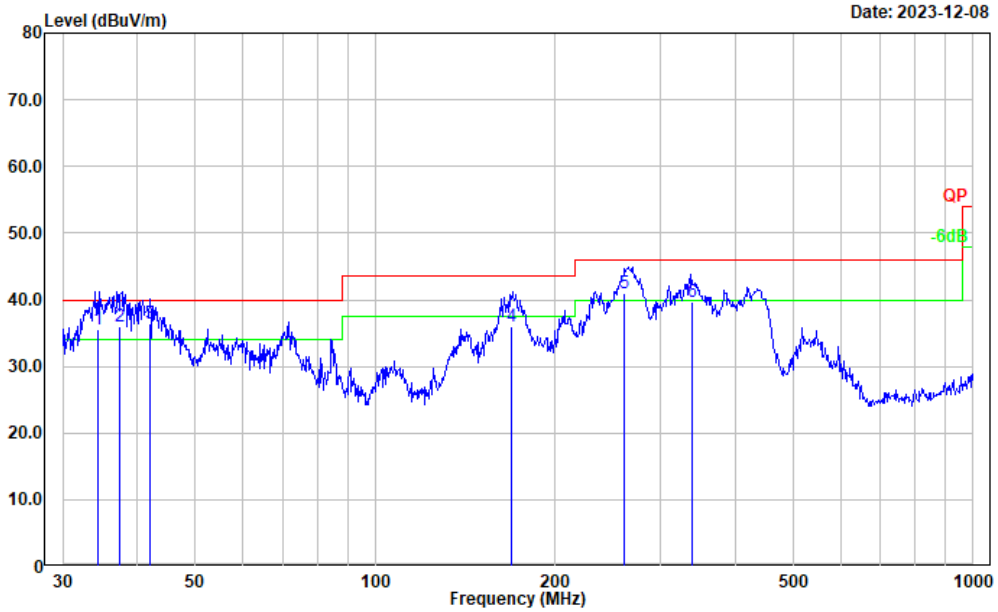

No.	Frequency (MHz)	Reading (dBμV)	Factor (dB/m)	Result (dBμV/m)	Limit (dBμV/m)	Margin (dB)	Detector
1	34.357	42.72	-7.23	35.49	40.00	4.51	QP
2	37.374	45.41	-9.52	35.89	40.00	4.11	QP
3	42.059	49.15	-12.68	36.47	40.00	3.53	QP
4	169.382	48.91	-13.00	35.91	43.50	7.59	QP
5	260.570	53.77	-12.82	40.95	46.00	5.05	QP
6	339.574	50.14	-10.38	39.76	46.00	6.24	QP

4.3 20 dB Emission Bandwidth

Serial Number:	2B5B-2	Test Date:	2023/12/8-2023/12/9
Test Site:	966-2	Test Mode:	Transmitting
Tester:	Carl Xue	Test Result:	Pass

Environmental Conditions:

Temperature: (°C)	25.3-26.3	Relative Humidity: (%)	45-47	ATM Pressure: (kPa)	100.9-101.1
----------------------	-----------	------------------------------	-------	------------------------	-------------

Test Equipment List and Details:

Manufacturer	Description	Model	Serial Number	Calibration Date	Calibration Due Date
BACL	Loop Antenna	1313-1P	3092721	2023/2/15	2026/2/14
R&S	EMI Test Receiver	ESR3	102724	2023/3/31	2024/3/30
TIMES MICROWAVE	Coaxial Cable	LMR-600-UltraFlex	C-0470-02	2023/7/16	2024/7/15
TIMES MICROWAVE	Coaxial Cable	LMR-600-UltraFlex	C-0780-01	2023/7/16	2024/7/15

* Statement of Traceability: China Certification ICT Co., Ltd (Dongguan) attests that all calibrations have been performed, traceable to National Primary Standards and International System of Units (SI).

Test Data:

Antenna	Test Frequency (kHz)	20 dB Emission Bandwidth (Hz)
Phone horizontal	127.33	834
Phone vertical	127.35	874
Airpods	131.32	859

20 dB Bandwidth

Phone horizontal

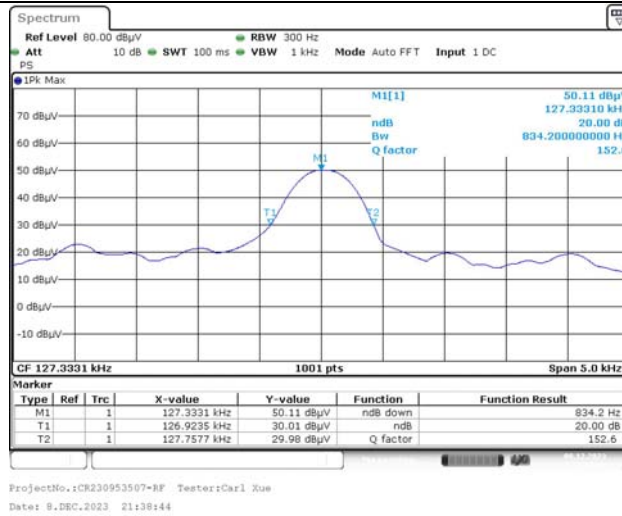

Phone vertical

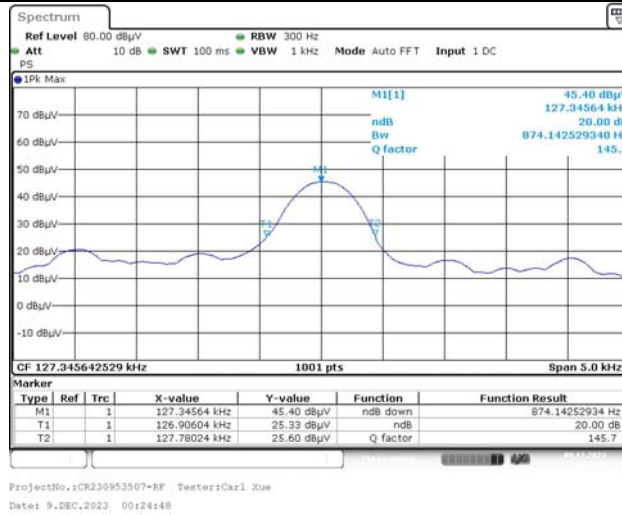

Airpods

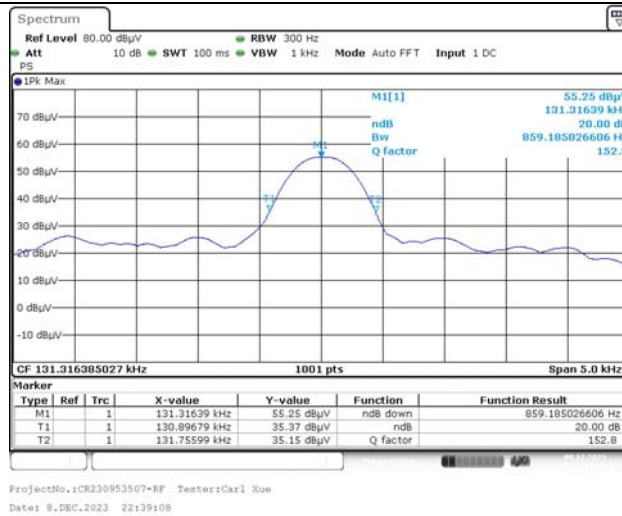

5 MAXIMUM PERMISSIBLE EXPOSURE (MPE)

5.1 Applicable Standard

According to subpart §1.1310, systems operating under the provisions of this section shall be operated in a manner that ensures that the public is not exposed to radio frequency energy level in excess of the Commission's guidelines.

Limits for Maximum Permissible Exposure (MPE) (§1.1310, §2.1091)

(B) Limits for General Population/Uncontrolled Exposure				
Frequency Range (MHz)	Electric Field Strength (V/m)	Magnetic Field Strength (A/m)	Power Density (mW/cm²)	Averaging Time (minutes)
0.3–1.34	614	1.63	*(100)	30
1.34–30	824/f	2.19/f	*(180/f ²)	30
30–300	27.5	0.073	0.2	30
300–1500	/	/	f/1500	30
1500–100,000	/	/	1.0	30

f = frequency in MHz; * = Plane-wave equivalent power density;

According with 680106 D01 Wireless Power Transfer v04 clause 3.2

Accordingly, for § 2.1091-Mobile devices, the MPE limits between 100 kHz to 300 kHz are to be considered the same as those at 300 kHz in Table 1 of § 1.1310, that is, 614 V/m and 1.63 A/m, for the electric field and magnetic field, respectively. For § 2.1093-Portable devices below 4 MHz and down to 100 kHz, the MPE limits in § 1.1310 (with the 300 kHz limit applicable all the way down to 100 kHz) can be used for the purpose of equipment authorization in lieu of SAR evaluations.

According to 680106 D01 Wireless Power Transfer v04 clause 5.2

There might be situations where the WPT RF emissions are limited enough that even operations in a “crowded” environment, where many similar WPT devices are present, do not pose significant EMC and RF exposure concerns. In this scenario, and for devices operating within a one-meter distance from the receiver, as defined above, a manufacturer will not have to submit an “Equipment Compliance Review” KDB, and receive FCC concurrence before proceeding with equipment authorization. This exception to the requirement of submitting the ECR to obtain FCC concurrence only applies when all the following criteria (1) through (6) are met:

- (1) The power transfer frequency is below 1 MHz.
- (2) The output power from each transmitting element (e.g., coil) is less than or equal to 15 watts.
- (3) A client device providing the maximum permitted load is placed in physical contact with the transmitter (i.e., the surfaces of the transmitter and client device enclosures need to be in physical contact)
- (4) Only § 2.1091-Mobile exposure conditions apply (i.e., this provision does not cover § 2.1093-Portable exposure conditions).

(5) The E-field and H-field strengths, at and beyond 20 cm surrounding the device surface, are demonstrated to be less than 50% of the applicable MPE limit, per KDB 447498, Table 1. These measurements shall be taken along the principal axes of the device, with one axis oriented along the direction of the estimated maximum field strength, and for three points per axis or until a $1/d$ (inverse distance from the emitter structure) field strength decay is observed. Symmetry considerations may be used for test reduction purposes. The device shall be operated in documented worst-case compliance scenarios (i.e., the ones that lead to the maximum field components), and while all the radiating structures (e.g., coils or antennas) that by design can simultaneously transmit are energized at their nominal maximum power.

(6) For systems with more than one radiating structure, the conditions specified in (5) must be met when the system is fully loaded (i.e., clients absorbing maximum power available), and with all the radiating structures operating at maximum power at the same time, as per design conditions. If the design allows one or more radiating structures to be powered at a higher level while other radiating structures are not powered, then those cases must be tested as well. For instance, a device may use three RF coils powered at 5 W, or one coil powered at 15 W: in this case, both scenarios shall be tested.

5.2 Block Diagram of Test Setup

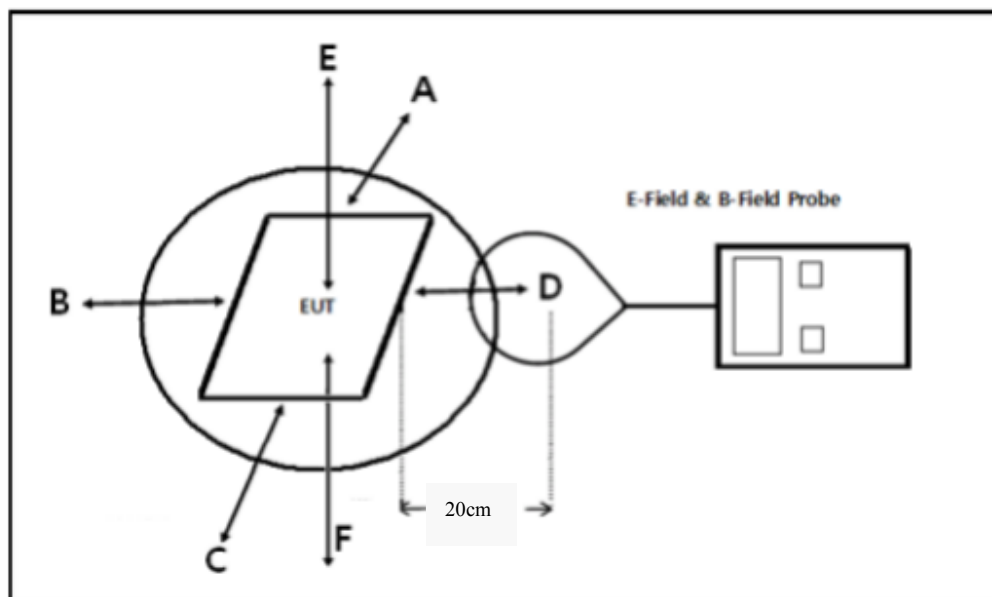

5.3 Test Procedures

- 1) Perform H-field and E-field measurements for each all sides of the EUT at 20cm, along all the principal axes defined with respect to the orientation of the transmitting element(e.g., coil or antenna).
- 2) The highest emission level was recorded and compared with limit.
- 3) The EUT was measured according to 680106 D01 Wireless Power Transfer v04

5.4 Test Data:

Serial Number:	2B5B-2	Test Date:	2023/12/25
Test Site:	RF	Test Mode:	M1-M6
Tester:	David Huang	Test Result:	Pass

Environmental Conditions:

Temperature: (°C)	22.5	Relative Humidity: (%)	27	ATM Pressure: (kPa)	102.4
----------------------	------	---------------------------	----	------------------------	-------

Test Equipment List and Details:

Manufacturer	Description	Model	Serial Number	Calibration Date	Calibration Due Date
Narda	Electric and Magnetic Field Probe-Analyzer	EHP-200AC	180ZX10204	2021/6/7	2024/6/6

* Statement of Traceability: China Certification ICT Co., Ltd (Dongguan) attests that all calibrations have been performed, traceable to National Primary Standards and International System of Units (SI).

Test Data:**M1:****H-Field Strength:**

Frequency Range (kHz)	Position A (A/m)	Position B (A/m)	Position C (A/m)	Position D (A/m)	Position E (A/m)	50% Limit (A/m)	Limit (A/m)
127.33	0.0385	0.0569	0.0518	0.0422	0.0439	0.815	1.63

E-Field Strength:

Frequency Range (kHz)	Position A (V/m)	Position B (V/m)	Position C (V/m)	Position D (V/m)	Position E (V/m)	50% Limit (V/m)	Limit (V/m)
127.33	0.6563	0.75	1.0469	0.6183	0.3978	307	614

M2**H-Field Strength:**

Frequency Range (kHz)	Position A (A/m)	Position B (A/m)	Position C (A/m)	Position D (A/m)	Position E (A/m)	50% Limit (A/m)	Limit (A/m)
127.33	0.0319	0.0516	0.0647	0.0528	0.0197	0.815	1.63
131.32	0.0318	0.0119	0.0336	0.0273	0.0531	0.815	1.63

The Multiple Frequency Summation (worst case at Position C)

$$H_{\text{Phone horizontal}}/H_{\text{Limit}} + H_{\text{Airpods}}/H_{\text{Limit}} = 0.0647/0.815 + 0.0336/0.815 = 0.121 < 1$$

E-Field Strength:

Frequency Range (kHz)	Position A (V/m)	Position B (V/m)	Position C (V/m)	Position D (V/m)	Position E (V/m)	50% Limit (V/m)	Limit (V/m)
127.33	0.5336	0.8207	0.7813	0.937	0.5924	307	614
131.32	0.2954	0.9438	0.8117	0.6357	0.8036	307	614

The Multiple Frequency Summation (worst case at Position B)

$$E_{\text{Phone horizontal}}/E_{\text{Limit}} + E_{\text{Airpods}}/E_{\text{Limit}} = 0.8207/307 + 0.9438/307 = 0.006 < 1$$

M3**H-Field Strength:**

Frequency Range (kHz)	Position A (A/m)	Position B (A/m)	Position C (A/m)	Position D (A/m)	Position E (A/m)	50% Limit (A/m)	Limit (A/m)
131.32	0.0315	0.0117	0.0356	0.02756	0.0545	0.815	1.63

E-Field Strength:

Frequency Range (kHz)	Position A (V/m)	Position B (V/m)	Position C (V/m)	Position D (V/m)	Position E (V/m)	50% Limit (V/m)	Limit (V/m)
131.32	0.2969	0.9504	0.8073	0.6524	0.8111	307	614

M4**H-Field Strength:**

Frequency Range (kHz)	Position A (A/m)	Position B (A/m)	Position C (A/m)	Position D (A/m)	Position E (A/m)	50% Limit (A/m)	Limit (A/m)
127.33	0.045	0.0647	0.0853	0.0967	0.035	0.815	1.63

E-Field Strength:

Frequency Range (kHz)	Position A (V/m)	Position B (V/m)	Position C (V/m)	Position D (V/m)	Position E (V/m)	50% Limit (V/m)	Limit (V/m)
127.33	0.5489	0.5547	0.4051	0.5223	0.4083	307	614

M5**H-Field Strength:**

Frequency Range (kHz)	Position A (A/m)	Position B (A/m)	Position C (A/m)	Position D (A/m)	Position E (A/m)	50% Limit (A/m)	Limit (A/m)
127.33	0.0525	0.0713	0.0512	0.0953	0.0506	0.815	1.63

E-Field Strength:

Frequency Range (kHz)	Position A (V/m)	Position B (V/m)	Position C (V/m)	Position D (V/m)	Position E (V/m)	50% Limit (V/m)	Limit (V/m)
127.33	0.6025	0.5767	0.5492	0.5055	0.5288	307	614

M6**H-Field Strength:**

Frequency Range (kHz)	Position A (A/m)	Position B (A/m)	Position C (A/m)	Position D (A/m)	Position E (A/m)	50% Limit (A/m)	Limit (A/m)
127.35	0.0422	0.0544	0.0497	0.0736	0.0184	0.815	1.63

E-Field Strength:

Frequency Range (kHz)	Position A (V/m)	Position B (V/m)	Position C (V/m)	Position D (V/m)	Position E (V/m)	50% Limit (V/m)	Limit (V/m)
127.35	0.6040	0.9846	0.3196	0.9947	0.3021	307	614

Note: Test with 20cm distance from the center of the probe(s) to the edge of the device.

Considerations of compliance 680106 D01 Wireless Power Transfer v04 clause 5.2:

(1) Power transfer frequency is less than 1 MHz

Yes, the operation frequency is AirPods: 131.32kHz, Phone horizontal: 127.33kHz, Phone vertical: 127.35kHz.

(2) The output power from each transmitting element (e.g., coil) is less than or equal to 15 watts.

Yes, the maximum output power of primary coil is **10 Watts**.

(3) A client device providing the maximum permitted load is placed in physical contact with the transmitter (i.e., the surfaces of the transmitter and client device enclosures need to be in physical contact)

Yes, client device is placed directly in contact with the transmitter

(4) Only § 2.1091-Mobile exposure conditions apply (i.e., this provision does not cover § 2.1093-Portable exposure conditions).

Yes, mobile exposure conditions only.

(5) The E-field and H-field strengths, at and beyond 20 cm surrounding the device surface, are demonstrated to be less than 50% of the applicable MPE limit, per KDB 447498, Table 1. These measurements shall be taken along the principal axes of the device, with one axis oriented along the direction of the estimated maximum field strength, and for three points per axis or until a 1/d (inverse distance from the emitter structure) field strength decay is observed. Symmetry considerations may be used for test reduction purposes. The device shall be operated in documented worst-case compliance scenarios (i.e., the ones that lead to the maximum field components), and while all the radiating structures (e.g., coils or antennas) that by design can simultaneously transmit are energized at their nominal maximum power.

Yes, the test result for H and E-field strength less than 50% of the MPE limit.

(6) For systems with more than one radiating structure, the conditions specified in (5) must be met when the system is fully loaded (i.e., clients absorbing maximum power available), and with all the radiating structures operating at maximum power at the same time, as per design conditions. If the design allows one or more radiating structures to be powered at a higher level while other radiating structures are not powered, then those cases must be tested as well. For instance, a device may use three RF coils powered at 5 W, or one coil powered at 15 W: in this case, both scenarios shall be tested.

Yes, all the radiating structures operating at maximum power at the same time.

6. EUT PHOTOGRAPHS

Please refer to the attachment CR230953507-EXP EUT EXTERNAL PHOTOGRAPHS and CR230953507-INP EUT INTERNAL PHOTOGRAPHS

7. TEST SETUP PHOTOGRAPHS

Please refer to the attachment CR230953507-00-TSP TEST SETUP PHOTOGRAPHS.

******* END OF REPORT *******