

FCC TEST REPORT

For

8BITDO TECHNOLOGY HK LIMITED

8Bitdo Retro Receiver

Model No.: NES Classic, NES Mini

Prepared For : 8BITDO TECHNOLOGY HK LIMITED
Address : Rooms 1318-19, 13/F, Hollywood Plaza, 610 Nathan Road, Mongkok,
Kowloon, Hong Kong

Prepared For : Shenzhen Anbotek Compliance Laboratory Limited
Address : 1/F., Building 1, SEC Industrial Park, No.0409 Qianhai Road, Nanshan
District, Shenzhen, Guangdong, China
Tel: (86) 755-26066544 Fax: (86) 755-26014772

Report Number : R011612258I
Date of Test : Dec. 15, 2016~Jan. 24, 2017
Date of Report : Jan. 24, 2017

Contents

1. General Information.....	5
1.1. Client Information.....	5
1.2. Description of Device (EUT).....	5
1.3. Auxiliary Equipment Used During Test.....	6
1.4. Description of Test Modes.....	6
1.5. List of channels.....	8
1.6. Description Of Test Setup.....	9
1.7. Test Equipment List.....	10
1.8. Measurement Uncertainty.....	10
1.9. Description of Test Facility.....	11
2. Summary of Test Results.....	12
3. Conducted Emission Test.....	13
3.1. Test Standard and Limit.....	13
3.2. Test Setup.....	13
3.3. Test Procedure.....	13
3.4. Test Data.....	13
4. Radiation Spurious Emission and Band Edge.....	14
4.1. Test Standard and Limit.....	14
4.2. Test Setup.....	14
4.3. Test Procedure.....	15
4.4. Test Data.....	16
5. Maximum Peak Output Power Test.....	23
5.1. Test Standard and Limit.....	23
5.2. Test Setup.....	23
5.3. Test Procedure.....	23
5.4. Test Data.....	23
6. 20DB Occupy Bandwidth Test.....	27
6.1. Test Standard.....	27
6.2. Test Setup.....	27
6.3. Test Procedure.....	27
6.4. Test Data.....	27
7. Carrier Frequency Separation Test.....	31
7.1. Test Standard and Limit.....	31
7.2. Test Setup.....	31
7.3. Test Procedure.....	31
7.4. Test Data.....	31
8. Number of Hopping Channel Test.....	35
8.1. Test Standard and Limit.....	35
8.2. Test Setup.....	35
8.3. Test Procedure.....	35
8.4. Test Data.....	35
9. Dwell Time Test.....	37

9.1. Test Standard and Limit..... 37
9.2. Test Setup..... 37
9.3. Test Procedure..... 37
9.4. Test Data..... 37
10. 100kHz Bandwidth of Frequency Band Edge Requirement..... 41
10.1. Test Standard and Limit..... 41
10.2. Test Setup..... 41
10.3. Test Procedure..... 41
10.4. Test Data..... 41
11. Antenna Requirement..... 45
11.1. Test Standard and Requirement..... 45
11.2. Antenna Connected Construction..... 45
APPENDIX I -- TEST SETUP PHOTOGRAPH..... 46
APPENDIX II -- EXTERNAL PHOTOGRAPH..... 47
APPENDIX III -- INTERNAL PHOTOGRAPH..... 51

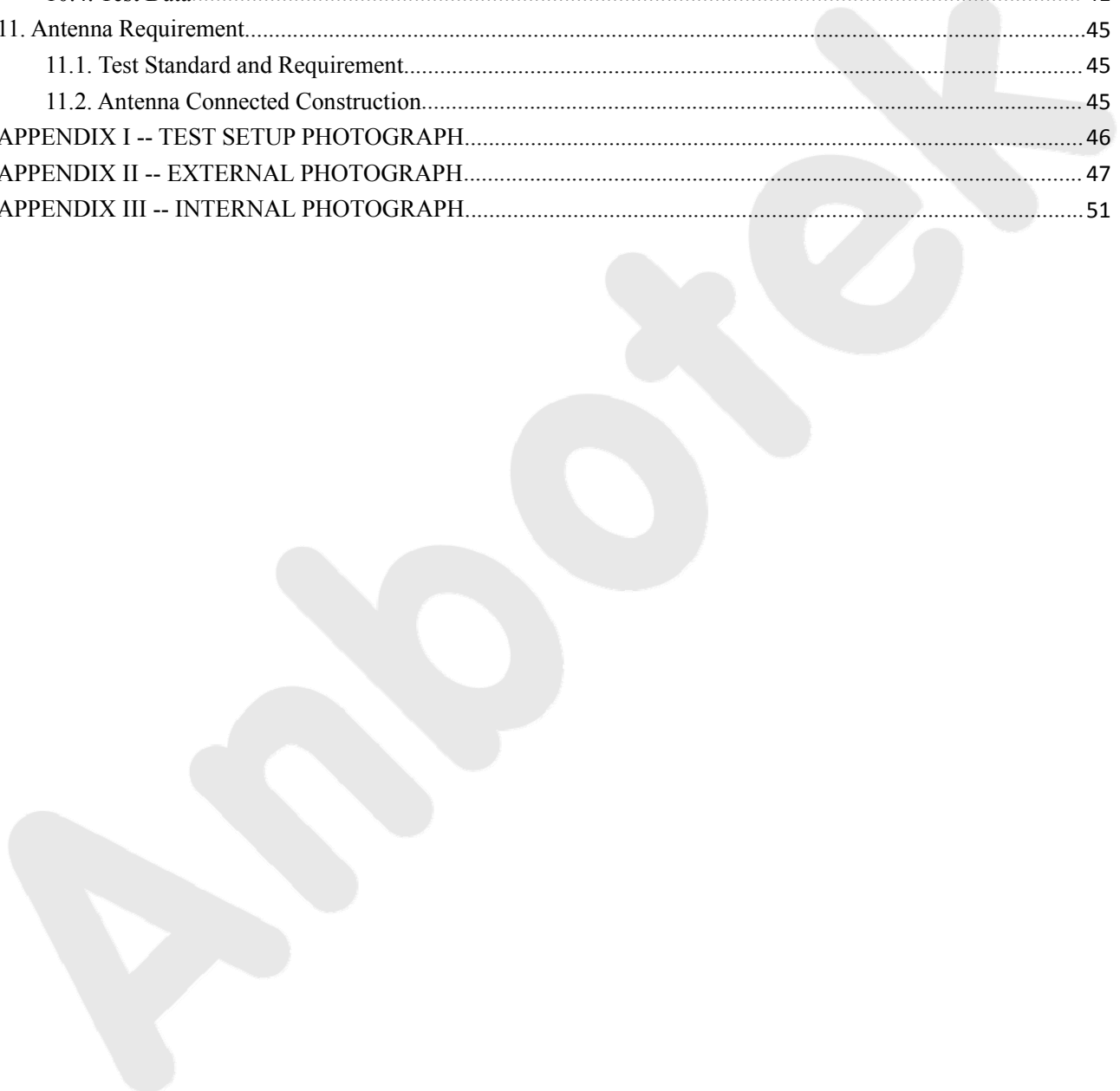

TEST REPORT

Applicant : 8BITDO TECHNOLOGY HK LIMITED
Manufacturer : SHENZHEN BESTODO TECH CO., LTD.
Product Name : 8Bitdo Retro Receiver
Model No. : NES Classic, NES Mini
Trade Mark : 8BITDO
Rating(s) : DC 5V, 500mA or DC 3.3V, 100mA

Test Standard(s) : FCC Part15 Subpart C 2016, Section 15.247

Test Method(s) : ANSI C63.10: 2013

The device described above is tested by Shenzhen Anbotek Compliance Laboratory Limited to determine the maximum emission levels emanating from the device and the severe levels of the device can endure and its performance criterion. The measurement results are contained in this test report and Shenzhen Anbotek Compliance Laboratory Limited is assumed full of responsibility for the accuracy and completeness of these measurements. Also, this report shows that the EUT (Equipment Under Test) is technically compliant with the FCC Part 15 Subpart C requirements.

This report applies to above tested sample only and shall not be reproduced in part without written approval of Shenzhen Anbotek Compliance Laboratory Limited.

Date of Test : Dec. 15, 2016~Jan. 24, 2017

Prepared by :



(Tested Engineer / Baron Wen)

Reviewer :



(Project Manager / Dolly Mo)

Approved & Authorized Signer :

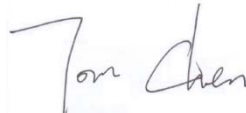

(Manager / Tom Chen)

1. General Information

1.1. Client Information

Applicant	:	8BITDO TECHNOLOGY HK LIMITED
Address	:	Rooms 1318-19, 13/F, Hollywood Plaza, 610 Nathan Road, Mongkok, Kowloon, Hong Kong
Manufacturer	:	SHENZHEN BESTODO TECH CO., LTD.
Address	:	Rooms 310, 3/F, 13 Bldg, Zhongxing Industrial Town, 13 Nanguang Road, Nanshan District, Shenzhen, China
Factory	:	Shenzhen Zhongxingda Electronic Co., Ltd.
Address	:	3-4/F,Bldg 10, Tongfuyu Industrial Zone, Lezhujiao Village, Xixiang, Baoan District, Shenzhen, China

1.2. Description of Device (EUT)

Product Name	:	8Bitdo Retro Receiver	
Model No.	:	NES Classic, NES Mini (Note: All samples are the same except the model number and colour, so we prepare “NES Classic” for test only.)	
Trade Mark	:	8BITDO	
Test Power Supply	:	AC 120V, 60Hz/AC 240V, 60Hz	
Product Description	:	Operation Frequency:	2402MHz~2480MHz
		Transfer Rate:	1/2/3 Mbits/s
		Number of Channel:	79 Channels
		Modulation Type:	GFSK, $\pi/4$ -DQPSK, 8-DPSK
		Antenna Type:	PCB Antenna
		Antenna Gain(Peak):	2 dBi
Remark: 1) For a more detailed features description, please refer to the manufacturer’s specifications or the User’s Manual.			

1.3. Auxiliary Equipment Used During Test

Adapter	:	Manufacturer: ZTE M/N: STC-A2050I1000USBA-C S/N: 201202102100876 Input: 100-240V~50/60Hz 0.3A Output: DC 5V, 1000mA
TV	:	Manufacturer: SONY M/N: KDL-26EX550 S/N: 1012240 CE , FCC, DOC
Entertainment system	:	Manufacturer: NINTENDO M/N: CLV-001 S/N: CEE103302278 CE , FCC, DOC
USB Cable	:	Length: 0.8m Shielded Type: No Shielded Ferrite Core: None
HDMI Cable	:	Length: 1.5m Shielded Type: Shielded Ferrite Core: Two Core With

1.4. Description of Test Modes

To investigate the maximum EMI emission characteristics generates from EUT, the test system was pre-scanning tested base on the consideration of following EUT operation mode or test configuration mode which possible have effect on EMI emission level. Each of these EUT operation mode(s) or test configuration mode(s) mentioned above was evaluated respectively.

Pretest Mode	Description
Mode 1	CH00
Mode 2	CH39
Mode 3	CH78
Mode 4	Keeping TX mode

For Conducted Emission	
Final Test Mode	Description
Mode 4	Keeping TX mode

For Radiated Emission	
Final Test Mode	Description
Mode 1	CH00
Mode 2	CH39
Mode 3	CH78

Note:

- (1) The measurements are performed at the highest, middle, lowest available channels.
- (2) The data rate was set in 1Mbps for radiated emission due to the highest RF output power.

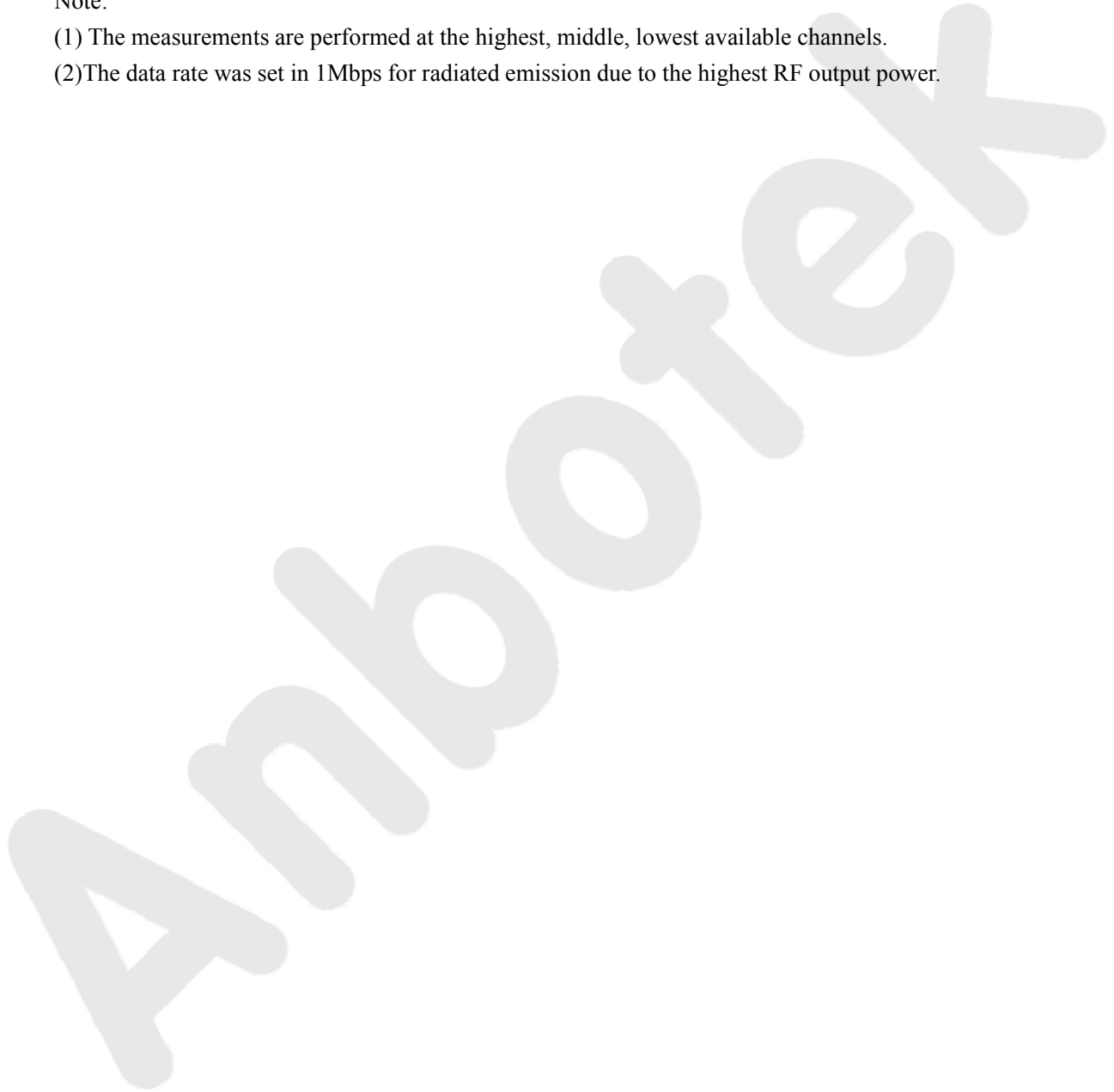

1.5. List of channels

Channel	Freq. (MHz)	Channel	Freq. (MHz)	Channel	Freq. (MHz)	Channel	Freq. (MHz)	Channel	Freq. (MHz)
00	2402	17	2419	34	2436	51	2453	68	2470
01	2403	18	2420	35	2437	52	2454	69	2471
02	2404	19	2421	36	2438	53	2455	70	2472
03	2405	20	2422	37	2439	54	2456	71	2473
04	2406	21	2423	38	2440	55	2457	72	2474
05	2407	22	2424	39	2441	56	2458	73	2475
05	2408	23	2425	40	2442	57	2459	74	2476
07	2409	24	2426	41	2443	58	2460	75	2477
08	2410	25	2427	42	2444	59	2461	76	2478
09	2411	26	2428	43	2445	60	2462	77	2479
10	2412	27	2429	44	2446	61	2463	78	2480
11	2413	28	2430	45	2447	62	2464		
12	2414	29	2431	46	2448	63	2465		
13	2415	30	2432	47	2449	64	2466		
14	2416	31	2433	48	2450	65	2467		
15	2417	32	2434	49	2451	66	2468		
16	2418	33	2435	50	2452	67	2469		

1.6. Description Of Test Setup

RE

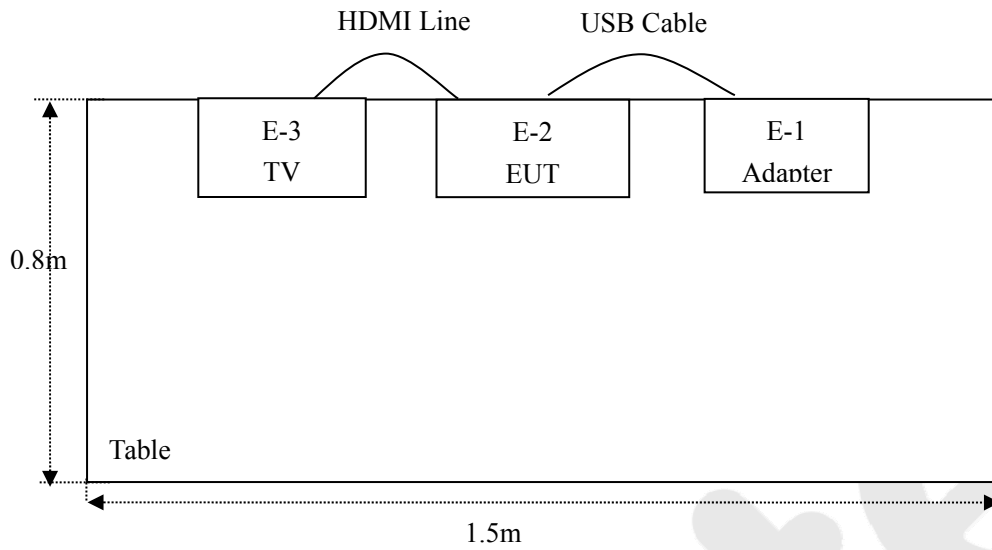

1.7. Test Equipment List

Item	Equipment	Manufacturer	Model No.	Serial No.	Last Cal.	Cal. Interval
1.	Two-Line V-network	Rohde & Schwarz	ENV216	100055	Jul. 19, 2016	1 Year
2.	EMI Test Receiver	Rohde & Schwarz	ESCI	100627	Jun. 17, 2016	1 Year
3.	RF Switching Unit	Compliance Direction	RSU-M2	38303	Jun. 17, 2016	1 Year
4.	Spectrum Analysis	Agilent	E4407B	US39390582	Jul. 12, 2016	1 Year
5	Preamplifier	Instruments corporation	EMC011830	980100	Jun. 17, 2016	1 Year
6.	EMI Test Receiver	Rohde & Schwarz	ESPI	101604	Jun. 17, 2016	1 Year
7	Double Ridged Horn Antenna	Instruments corporation	GTH-0118	351600	May 06, 2016	1 Year
8	Bilog Broadband Antenna	Schwarzbeck	VULB9163	VULB 9163-289	May 06, 2016	1 Year
9	Loop Antenna	Schwarzbeck	FMZB 1519	012	May 11, 2016	1 Year
10.	Pre-amplifier	SONOMA	310N	186860	Jun. 17, 2016	1 Year
11	EMI Test Software EZ-EMC	SHURPLE	N/A	N/A	N/A	N/A
12	Power Sensor	Agilent	KFSW150502	15I00041SN045	Jun. 17, 2016	1 Year
13	MXA Spectrum Analysis	Agilent	N9020A	MY51170037	Jun. 17, 2016	1 Year
14	MXG RF Vector Signal Generator	Agilent	N5182A	MY48180656	Jun. 17, 2016	1 Year
15	Signal Generator	Agilent	E4421B	MY41000743	Jun. 17, 2016	1 Year
16	DC Power supply	IV	IV-8080	YQSB0096	Jun. 17, 2016	1 Year
17	TEMP&HUMI PROGRAMMABLE CHAMBER	Bell Group	BE-THK-150 M8	SE-0137	Jun. 17, 2016	1 Year

1.8. Measurement Uncertainty

Radiation Uncertainty	:	Ur = 4.1 dB (Horizontal)
		Ur = 4.3 dB (Vertical)
Conduction Uncertainty	:	Uc = 3.4dB

1.9. Description of Test Facility

The test facility is recognized, certified, or accredited by the following organizations:

FCC-Registration No.: 752021

Shenzhen Anbotek Compliance Laboratory Limited, EMC Laboratory has been registered and fully described in a report filed with the (FCC) Federal Communications Commission. The acceptance letter from the FCC is maintained in our files. Registration 752021, July 06, 2016.

IC-Registration No.: 8058A-1

Shenzhen Anbotek Compliance Laboratory Limited., EMC Laboratory has been registered and fully described in a report filed with the (IC) Industry Canada. The acceptance letter from the IC is maintained in our files. Registration 8058A, June 13, 2016.

Test Location

All Emissions tests were performed at

Shenzhen Anbotek Compliance Laboratory Limited. at 1/F., Building 1, SEC Industrial Park, No.0409 Qianhai Road, Nanshan District, Shenzhen, Guangdong, China

2. Summary of Test Results

Standard Section	Test Item	Result
15.203/15.247(c)	Antenna Requirement	PASS
15.207	Conducted Emission	N/A
15.205/15.209	Spurious Emission	PASS
15.247(b)(1)	Conducted Peak Output Power	PASS
15.247(a)(1)	20dB Occupied Bandwidth	PASS
15.247(a)(1)	Carrier Frequencies Separation	PASS
15.247(a)(1)	Hopping Channel Number	PASS
15.247(a)(1)	Dwell Time	PASS
15.247(d)	Band Edge	PASS
Remark: "N/A" is an abbreviation for Not Applicable.		

3. Conducted Emission Test

3.1. Test Standard and Limit

Test Standard	FCC Part15 Section 15.207		
Test Limit	Frequency	Maximum RF Line Voltage (dBuV)	
		Quasi-peak Level	Average Level
	150kHz~500kHz	66 ~ 56 *	56 ~ 46 *
	500kHz~5MHz	56	46
	5MHz~30MHz	60	50
Remark: (1) *Decreasing linearly with logarithm of the frequency. (2) The lower limit shall apply at the transition frequency.			

3.2. Test Setup

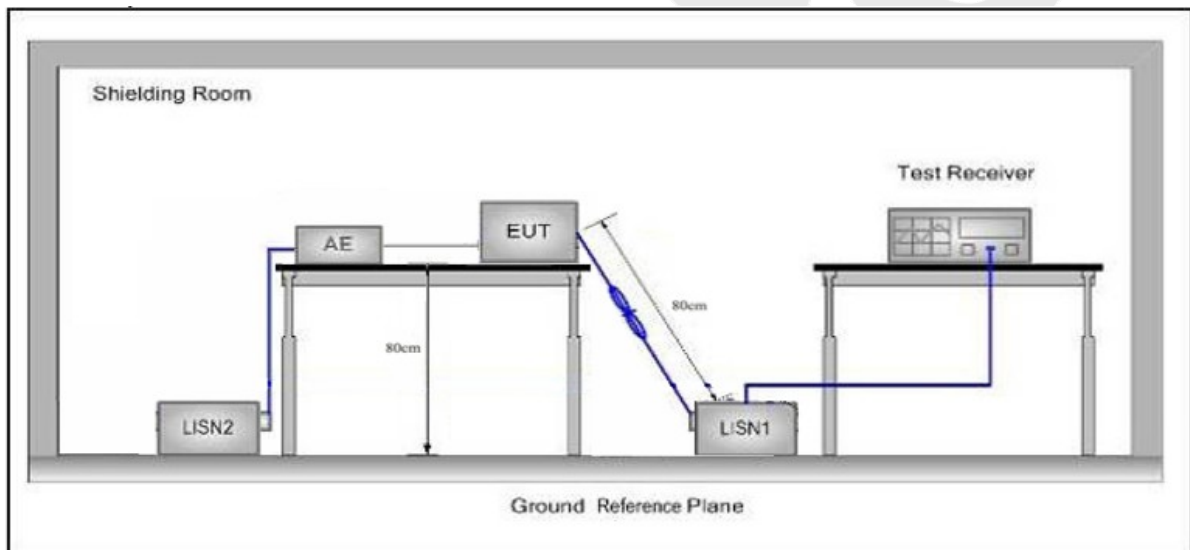

3.3. Test Procedure

The EUT system is connected to the power mains through a line impedance stabilization network (L.I.S.N.). This provides a 50ohm coupling impedance for the EUT system. Please refer the block diagram of the test setup and photographs. Both sides of AC line are checked to find out the maximum conducted emission. In order to find the maximum emission levels, the relative positions of equipment and all of the interface cables shall be changed according to FCC ANSI C63.10-2013 on Conducted Emission Measurement.

The bandwidth of test receiver (ESCI) set at 9kHz.

The frequency range from 150kHz to 30MHz is checked.

3.4. Test Data

N/A

The EUT's power supply was only by dry battery, so the test item is not need.

4. Radiation Spurious Emission and Band Edge

4.1. Test Standard and Limit

Test Standard	FCC Part15 C Section 15.209 and 15.205				
Test Limit	Frequency (MHz)	Field strength (microvolt/meter)	Limit (dBuV/m)	Remark	Measurement distance (m)
	0.009MHz~0.490MHz	2400/F(kHz)	-	-	300
	0.490MHz-1.705MHz	24000/F(kHz)	-	-	30
	1.705MHz-30MHz	30	-	-	30
	30MHz~88MHz	100	40.0	Quasi-peak	3
	88MHz~216MHz	150	43.5	Quasi-peak	3
	216MHz~960MHz	200	46.0	Quasi-peak	3
	Above 1000MHz	500	54.0	Average	3
		-	74.0	Peak	3

Remark:

- (1)The lower limit shall apply at the transition frequency.
- (2) 15.35(b), Unless otherwise specified, the limit on peak radio frequency emissions is 20dB above the maximum permitted average emission limit applicable to the equipment under test. This peak limit applies to the total peak emission level radiated by the device.

4.2. Test Setup

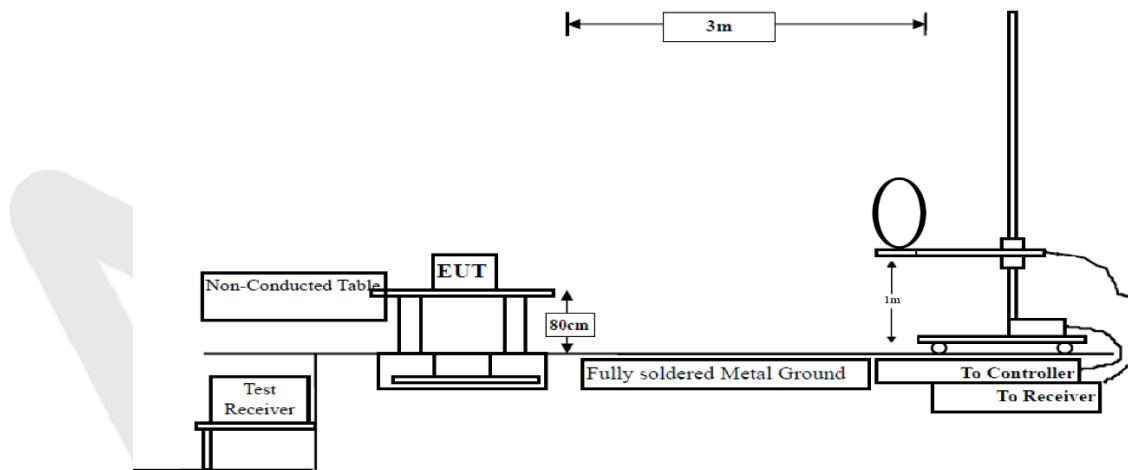

Figure 1. Below 30MHz

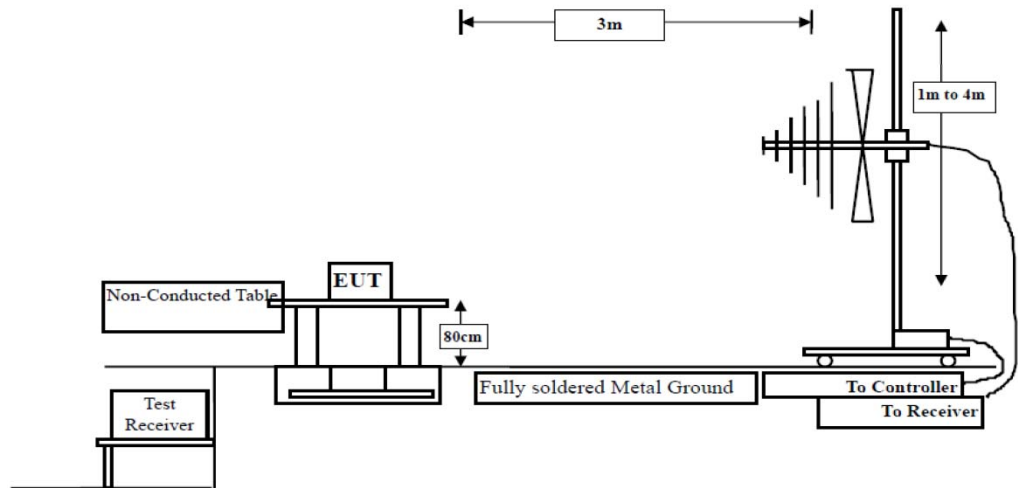

Figure 2. 30MHz to 1GHz

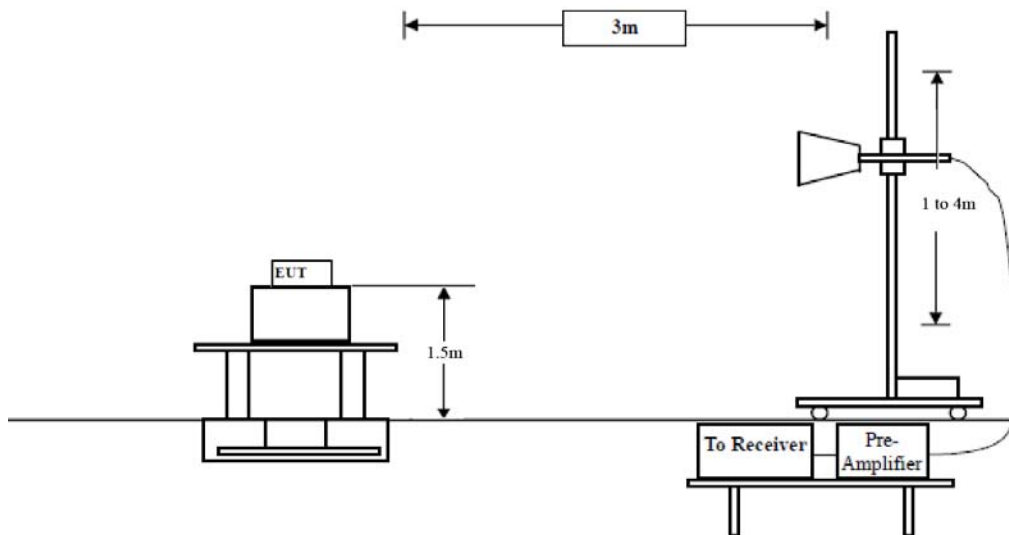

Figure 3. Above 1 GHz

4.3. Test Procedure

For below 1GHz: The EUT is placed on a turntable, which is 0.8m above the ground plane.

For above 1GHz: The EUT is placed on a turntable, which is 1.5m above the ground plane.

The turn table can rotate 360 degrees to determine the position of the maximum emission level. The EUT is set 3 meters away from the receiving antenna which is mounted on a antenna tower. The antenna can be moved up and down from 1 to 4 meters to find out the maximum emission level. Rotated the EUT through three orthogonal axes to determine the maximum emissions, both horizontal and vertical polarization of the antenna are set on test. The EUT is tested in 9*6*6 Chamber. The device is evaluated in xyz orientation.

For 9kHz to 150kHz, Set the spectrum analyzer as:

RBW = 200Hz, VBW =1kHz, Detector= Quasi-Peak, Trace mode= Max hold, Sweep- auto couple.

For 150kHz to 30MHz, Set the spectrum analyzer as:

RBW = 9KHz, VBW =30kHz, Detector= Quasi-Peak, Trace mode= Max hold, Sweep- auto couple.

For above 1GHz,Set the spectrum analyzer as:

RBW =1MHz, VBW =10Hz, Detector= Average, Trace mode= Max hold, Sweep- auto couple.

4.4. Test Data

PASS

During the test, pre-scan the GFSK, $\pi/4$ QPSK, 8DPSK modulation, and found the GFSK modulation which it is worse case.

The test results of 9kHz-30MHz and above 18000MHz are attenuated more than 20dB below the permissible limits, so the results don't record in the report.

Anbotek

Test Results (30~1000MHz)

Job No.: 011612258I Temp.(°C)/Hum.(%RH): 24.3°C/55%RH
 Standard: FCC PART 15C Power Source: AC 120V, 60Hz
 Test Mode: TX Mode Polarization: Horizontal

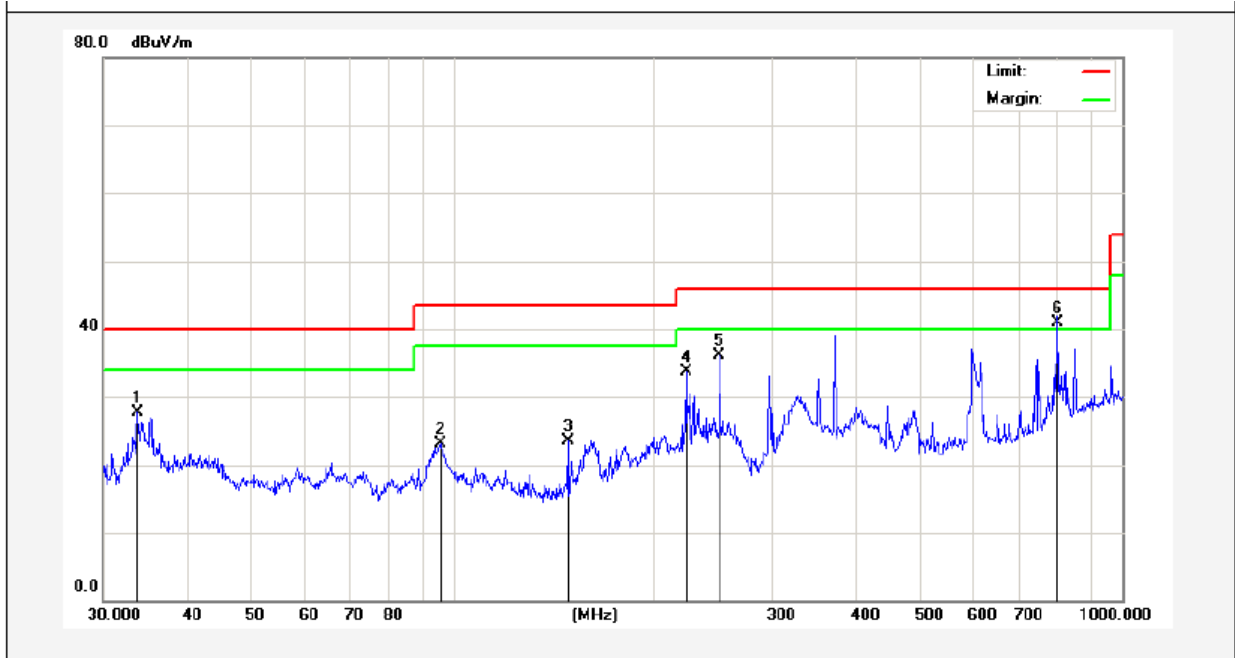

No.	Freq. (MHz)	Reading (dBuV/m)	Factor (dB/m)	Result (dBuV/m)	Limit (dBuV/)	Over Limit (dB)	Detector	Height (cm)	degree (deg)	Remark
1	33.7986	42.64	-14.92	27.72	40.00	-12.28	peak			
2	95.7622	44.00	-20.98	23.02	43.50	-20.48	peak			
3	148.4410	46.84	-23.36	23.48	43.50	-20.02	peak			
4	222.9502	53.51	-19.82	33.69	46.00	-12.31	peak			
5	250.3012	54.62	-18.56	36.06	46.00	-9.94	peak			
6	801.7863	47.52	-6.54	40.98	46.00	-5.02	QP	300	0	



Test Results (30~1000MHz)

Job No.: 011612258I Temp.(°C)/Hum.(%RH): 24.3°C/55%RH
 Standard: FCC PART 15C Power Source: AC 120V, 60Hz
 Test Mode: TX Mode Polarization: Vertical

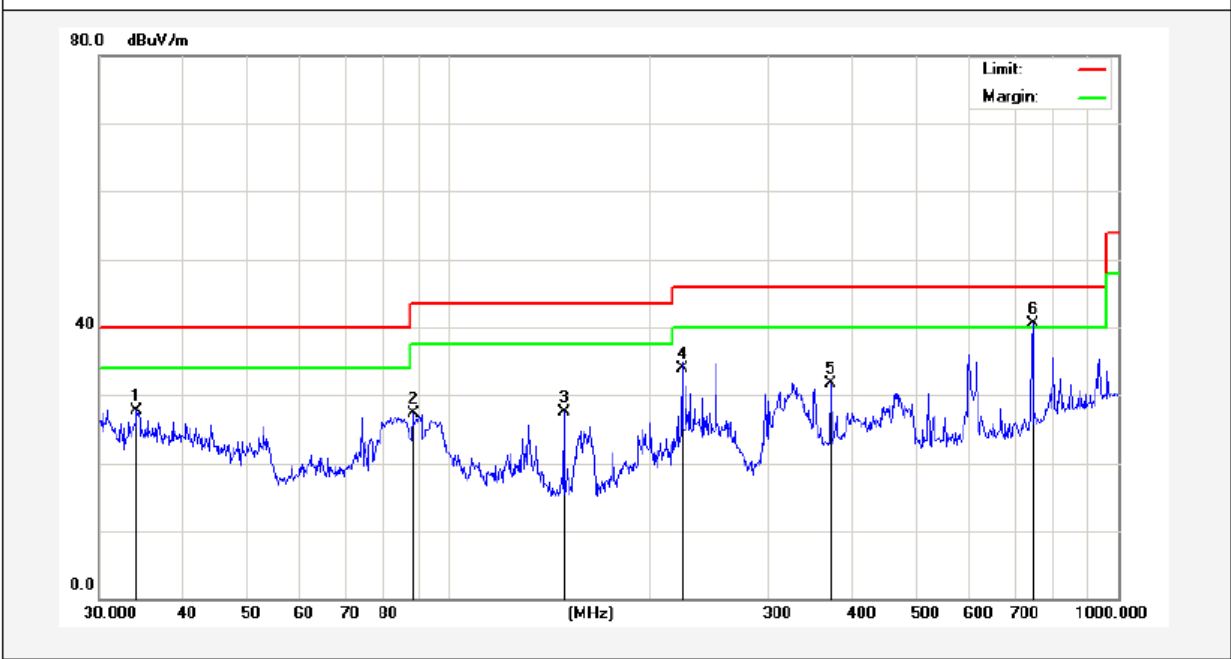

No.	Freq. (MHz)	Reading (dBuV/m)	Factor (dB/m)	Result (dBuV/m)	Limit (dBuV/)	Over Limit (dB)	Detector	Height (cm)	degree (deg)	Remark
1	34.1561	42.42	-14.74	27.68	40.00	-12.32	peak			
2	88.3421	45.37	-18.04	27.33	43.50	-16.17	peak			
3	148.4410	45.83	-18.36	27.47	43.50	-16.03	peak			
4	222.9502	48.94	-14.97	33.97	46.00	-12.03	QP	100	0	
5	372.0045	44.11	-12.43	31.68	46.00	-14.32	peak			
6	744.8661	47.73	-7.15	40.58	46.00	-5.42	peak			



Test Results (Above 1000MHz)

Test Mode: GFSK					Test channel: Lowest			
Peak Value								
Frequency (MHz)	Read Level (dBuV)	Antenna Factor (dB/m)	Cable Loss (dB)	Preamp Factor (dB)	Level (dBuV/m)	Limit (dBuV/m)	Over Limit (dB)	Pol.
4804.00	38.53	34.04	6.58	34.09	45.06	74.00	-28.94	V
7206.00	32.64	37.11	7.73	34.50	42.98	74.00	-31.02	V
9608.00	32.19	39.31	9.23	34.79	45.94	74.00	-28.06	V
12010.00	*					74.00		V
14412.00	*					74.00		V
4804.00	43.06	34.04	6.58	34.09	49.59	74.00	-24.41	H
7206.00	34.50	37.11	7.73	34.50	44.84	74.00	-29.16	H
9608.00	31.73	39.31	9.23	34.79	45.48	74.00	-28.52	H
12010.00	*					74.00		H
14412.00	*					74.00		H
Average Value								
Frequency (MHz)	Read Level (dBuV)	Antenna Factor (dB/m)	Cable Loss (dB)	Preamp Factor (dB)	Level (dBuV/m)	Limit (dBuV/m)	Over Limit (dB)	Pol.
4804.00	27.11	34.04	6.58	34.09	33.64	54.00	-20.36	V
7206.00	21.19	37.11	7.73	34.50	31.53	54.00	-22.47	V
9608.00	20.19	39.31	9.23	34.79	33.94	54.00	-20.06	V
12010.00	*					54.00		V
14412.00	*					54.00		V
4804.00	31.47	34.04	6.58	34.09	38.00	54.00	-16.00	H
7206.00	23.44	37.11	7.73	34.50	33.78	54.00	-20.22	H
9608.00	20.02	39.31	9.23	34.79	33.77	54.00	-20.23	H
12010.00	*					54.00		H
14412.00	*					54.00		H

Test Results (Above 1000MHz)

Test Mode: GFSK					Test channel: Middle			
Peak Value								
Frequency (MHz)	Read Level (dBuV)	Antenna Factor (dB/m)	Cable Loss (dB)	Preamp Factor (dB)	Level (dBuV/m)	Limit (dBuV/m)	Over Limit (dB)	Pol.
4882.00	37.67	34.38	6.69	34.09	44.65	74.00	-29.35	V
7323.00	32.07	37.22	7.78	34.53	42.54	74.00	-31.46	V
9764.00	31.69	39.46	9.35	34.80	45.70	74.00	-28.30	V
12205.00	*					74.00		V
14646.00	*					74.00		V
4882.00	42.03	34.38	6.69	34.09	49.01	74.00	-24.99	H
7323.00	33.86	37.22	7.78	34.53	44.33	74.00	-29.67	H
9764.00	31.14	39.46	9.35	34.80	45.15	74.00	-28.85	H
12205.00	*					74.00		H
14646.00	*					74.00		H
Average Value								
Frequency (MHz)	Read Level (dBuV)	Antenna Factor (dB/m)	Cable Loss (dB)	Preamp Factor (dB)	Level (dBuV/m)	Limit (dBuV/m)	Over Limit (dB)	Pol.
4882.00	26.43	34.38	6.69	34.09	33.41	54.00	-20.59	V
7323.00	20.73	37.22	7.78	34.53	31.20	54.00	-22.80	V
9764.00	19.78	39.46	9.35	34.80	33.79	54.00	-20.21	V
12205.00	*					54.00		V
14646.00	*					54.00		V
4882.00	30.70	34.38	6.69	34.09	37.68	54.00	-16.32	H
7323.00	22.93	37.22	7.78	34.53	33.40	54.00	-20.60	H
9764.00	19.54	39.46	9.35	34.80	33.55	54.00	-20.45	H
12205.00	*					54.00		H
14646.00	*					54.00		H

Test Results (Above 1000MHz)

Test Mode: GFSK					Test channel: Highest			
Peak Value								
Frequency (MHz)	Read Level (dBuV)	Antenna Factor (dB/m)	Cable Loss (dB)	Preamp Factor (dB)	Level (dBuV/m)	Limit (dBuV/m)	Over Limit (dB)	Pol.
4960.00	36.64	34.72	6.79	34.09	44.06	74.00	-29.94	V
7440.00	31.39	37.34	7.82	34.57	41.98	74.00	-32.02	V
9920.00	31.08	39.62	9.46	34.81	45.35	74.00	-28.65	V
12400.00	*					74.00		V
14880.00	*					74.00		V
4960.00	40.80	34.72	6.79	34.09	48.22	74.00	-25.78	H
7440.00	33.09	37.34	7.82	34.57	43.68	74.00	-30.32	H
9920.00	30.44	39.62	9.46	34.81	44.71	74.00	-29.29	H
12400.00	*					74.00		H
14880.00	*					74.00		H
Average Value								
Frequency (MHz)	Read Level (dBuV)	Antenna Factor (dB/m)	Cable Loss (dB)	Preamp Factor (dB)	Level (dBuV/m)	Limit (dBuV/m)	Over Limit (dB)	Pol.
4960.00	25.65	34.72	6.79	34.09	33.07	54.00	-20.93	V
7440.00	20.20	37.34	7.82	34.57	30.79	54.00	-23.21	V
9920.00	19.31	39.62	9.46	34.81	33.58	54.00	-20.42	V
12400.00	*					54.00		V
14880.00	*					54.00		V
4960.00	29.81	34.72	6.79	34.09	37.23	54.00	-16.77	H
7440.00	22.33	37.34	7.82	34.57	32.92	54.00	-21.08	H
9920.00	18.99	39.62	9.46	34.81	33.26	54.00	-20.74	H
12400.00	*					54.00		H
14880.00	*					54.00		H

Remark:

1. During the test, pre-scan the GFSK, $\pi/4$ QPSK, 8DPSK modulation, and found the GFSK modulation is worse case, the report only record this mode.
2. Level =Receiver Read level + Antenna Factor + Cable Loss – Preamplifier Factor
3. “*”, means this data is the too weak instrument of signal is unable to test.

Radiated Band Edge:

Test Mode: GFSK					Test channel: Lowest			
Peak Value								
Frequency (MHz)	Read Level (dBuV)	Antenna Factor (dB/m)	Cable Loss (dB)	Preamp Factor (dB)	Level (dBuV/m)	Limit (dBuV/m)	Over Limit (dB)	Pol.
2390.00	45.96	29.15	3.41	34.01	44.51	74.00	-29.49	H
2400.00	63.19	29.16	3.43	34.01	61.77	74.00	-12.23	H
2390.00	46.81	29.15	3.41	34.01	45.36	74.00	-28.64	V
2400.00	65.56	29.16	3.43	34.01	64.14	74.00	-9.86	V
Average Value								
Frequency (MHz)	Read Level (dBuV)	Antenna Factor (dB/m)	Cable Loss (dB)	Preamp Factor (dB)	Level (dBuV/m)	Limit (dBuV/m)	Over Limit (dB)	Pol.
2390.00	35.82	29.15	3.41	34.01	34.37	54.00	-19.63	H
2400.00	47.24	29.16	3.43	34.01	45.82	54.00	-8.18	H
2390.00	35.98	29.15	3.41	34.01	34.53	54.00	-19.47	V
2400.00	49.18	29.16	3.43	34.01	47.76	54.00	-6.24	V

Test Mode: GFSK					Test channel: Highest			
Peak Value								
Frequency (MHz)	Read Level (dBuV)	Antenna Factor (dB/m)	Cable Loss (dB)	Preamp Factor (dB)	Level (dBuV/m)	Limit (dBuV/m)	Over Limit (dB)	Pol.
2483.50	48.44	29.28	3.53	34.03	47.22	74.00	-26.78	H
2500.00	47.02	29.30	3.56	34.03	45.85	74.00	-28.15	H
2483.50	49.79	29.28	3.53	34.03	48.57	74.00	-25.43	V
2500.00	48.31	29.30	3.56	34.03	47.14	74.00	-26.86	V
Average Value								
Frequency (MHz)	Read Level (dBuV)	Antenna Factor (dB/m)	Cable Loss (dB)	Preamp Factor (dB)	Level (dBuV/m)	Limit (dBuV/m)	Over Limit (dB)	Pol.
2483.50	38.68	29.28	3.53	34.03	37.46	54.00	-16.54	H
2500.00	36.24	29.30	3.56	34.03	35.07	54.00	-18.93	H
2483.50	40.15	29.28	3.53	34.03	38.93	54.00	-15.07	V
2500.00	36.42	29.30	3.56	34.03	35.25	54.00	-18.75	V

Remark:

1. During the test, pre-scan the GFSK, $\pi/4$ QPSK, 8DPSK modulation, and found the GFSK modulation is worse case, the report only record this mode.
2. Level = Receiver Read level + Antenna Factor + Cable Loss – Pre-amplifier Factor

5. Maximum Peak Output Power Test

5.1. Test Standard and Limit

Test Standard	FCC Part15 C Section 15.247 (b)(3)
Test Limit	1W or 125 mW

5.2. Test Setup

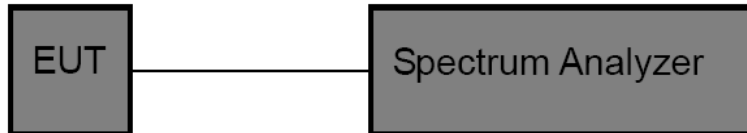

5.3. Test Procedure

- The EUT was directly connected to the spectrum analyzer and antenna output port as show in the block diagram above,
- Spectrum Setting:
 - RBW > the 20 dB bandwidth of the emission being measured
 - Span = approximately 5 times the 20 dB bandwidth, centered on a hopping channel
 - VBW ≥ RBW
 - Sweep = auto
 - Detector function = peak
 - Trace = max hold

5.4. Test Data

Test Item	: Max. peak output power	Test Mode	: CH Low ~ CH High
Test Voltage	: AC 120V, 60Hz	Temperature	: 24°C
Test Result	: PASS	Humidity	: 55%RH

Channel Frequency (MHz)	Peak Power output (dBm)	Limit (dBm)	Results	Modulation
2402	-0.413	30	PASS	BDR
2441	0.087	30	PASS	BDR
2480	0.778	30	PASS	BDR
2402	-0.673	20.96	PASS	EDR
2441	-0.250	20.96	PASS	EDR
2480	0.506	20.96	PASS	EDR

Remark: The EDR was tested on ($\pi/4$ DQPSK, 8DPSK) modes, only the worst data of (8DPSK) is attached in the following pages.

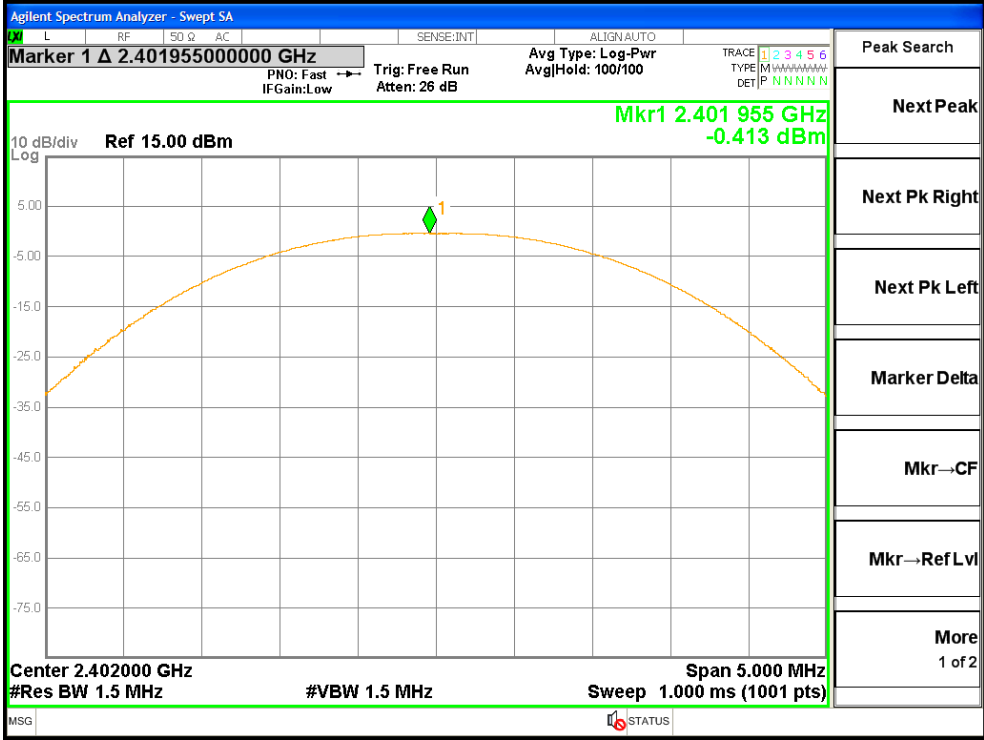

Test Mode: BDR---Low

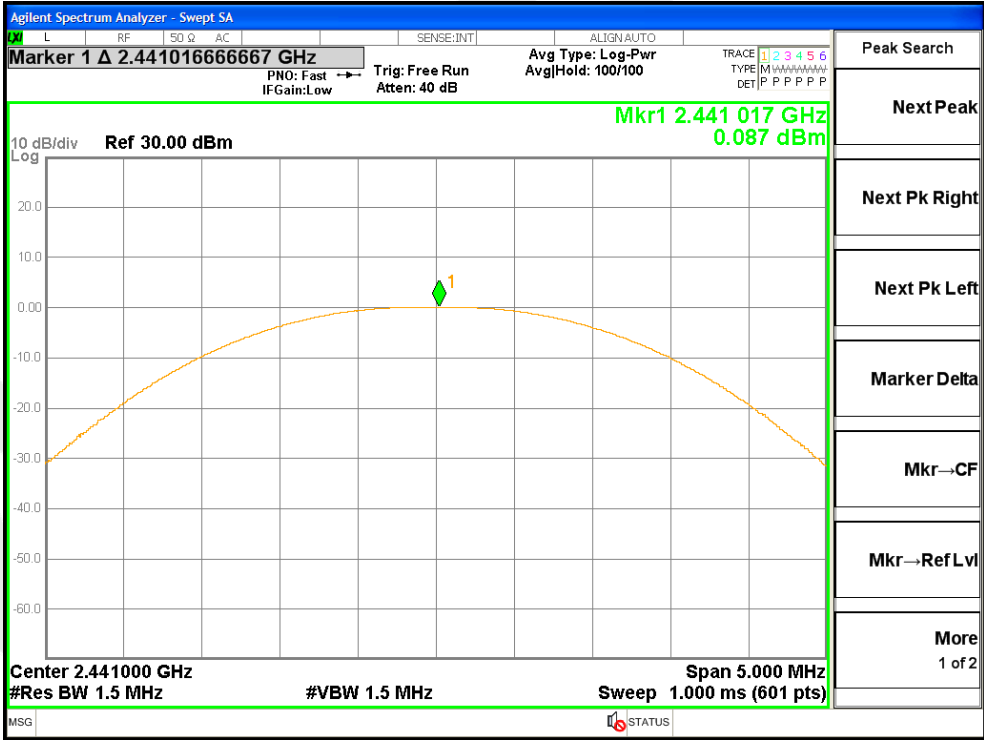

Test Mode: BDR---Middle

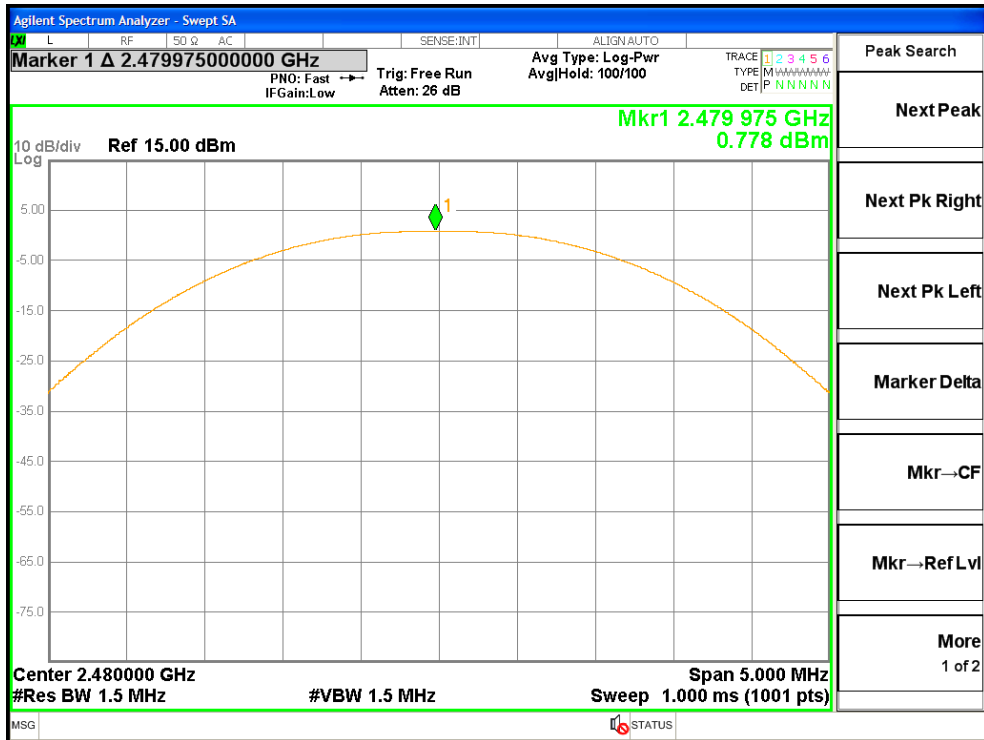

Test Mode: BDR---High

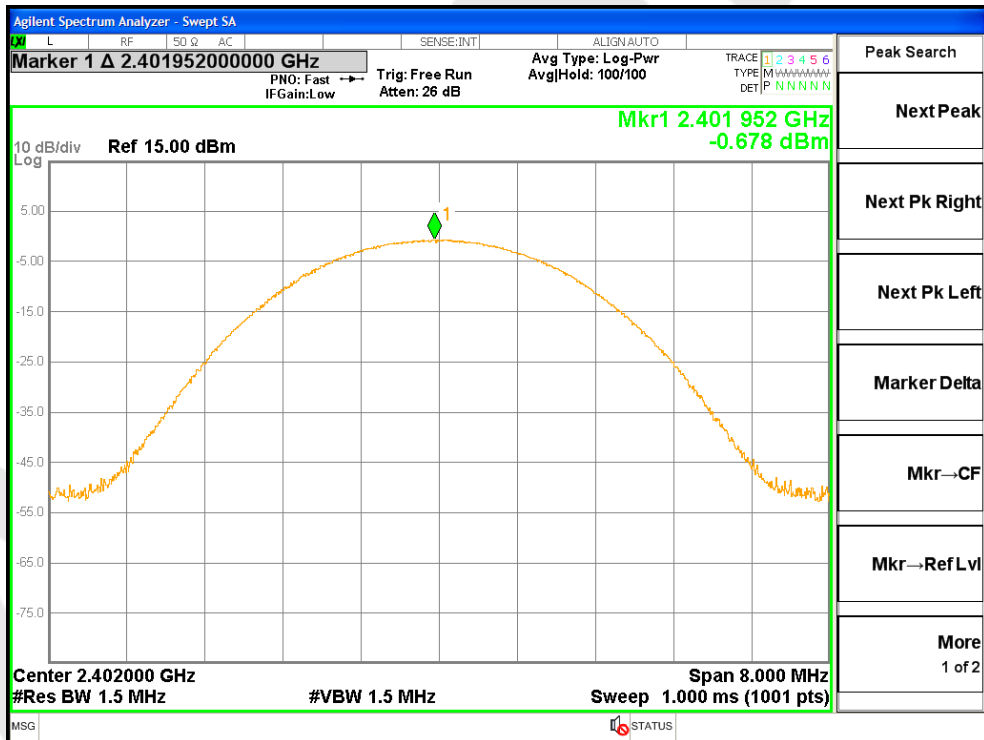

Test Mode: EDR---Low

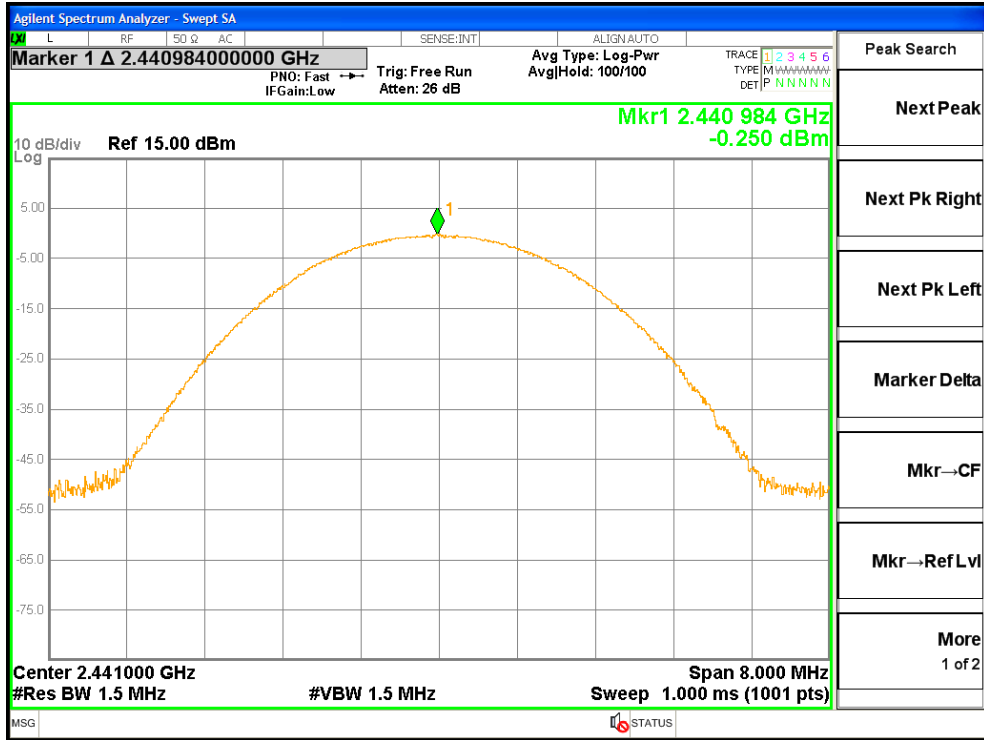

Test Mode: EDR---Middle

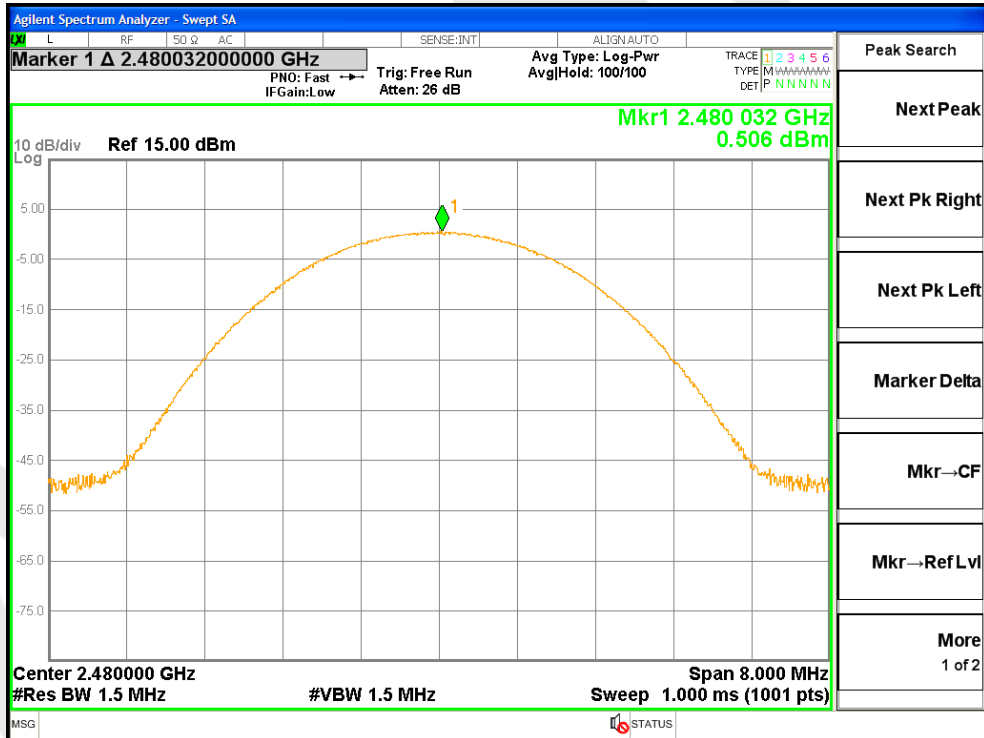

Test Mode: EDR---High

6. 20DB Occupy Bandwidth Test

6.1. Test Standard

Test Standard	FCC Part15 C Section 15.247 (a)(1)
---------------	------------------------------------

6.2. Test Setup

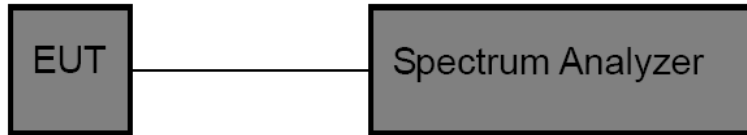

6.3. Test Procedure

Using the following spectrum analyzer settings:

1. Span= approximately 2 to 3 times the 20dB bandwidth, centered on a hopping channel.
2. Set the RBW = 30 kHz.
3. Set the VBW = 100 kHz.
4. Sweep time = auto couple.
5. Detector function = peak.
6. Trace mode = max hold.
7. Allow trace to fully stabilize.

6.4. Test Data

Test Item	: 20dB BW	Test Mode	: CH Low ~ CH High
Test Voltage	: AC 120V, 60Hz	Temperature	: 24°C
Test Result	: PASS	Humidity	: 55%RH

Channel	Frequency(MHz)	20dB Down BW(kHz)	Modulation Mode
Low	2402	926.1	BDR
Middle	2441	912.6	BDR
High	2480	919.0	BDR
Low	2402	1266.0	EDR
Middle	2441	1260.0	EDR
High	2480	1256.0	EDR

Remark: The EDR was tested on (π /4DQPSK, 8DPSK) modes, only the worst data of (8DPSK) is attached in the following pages.

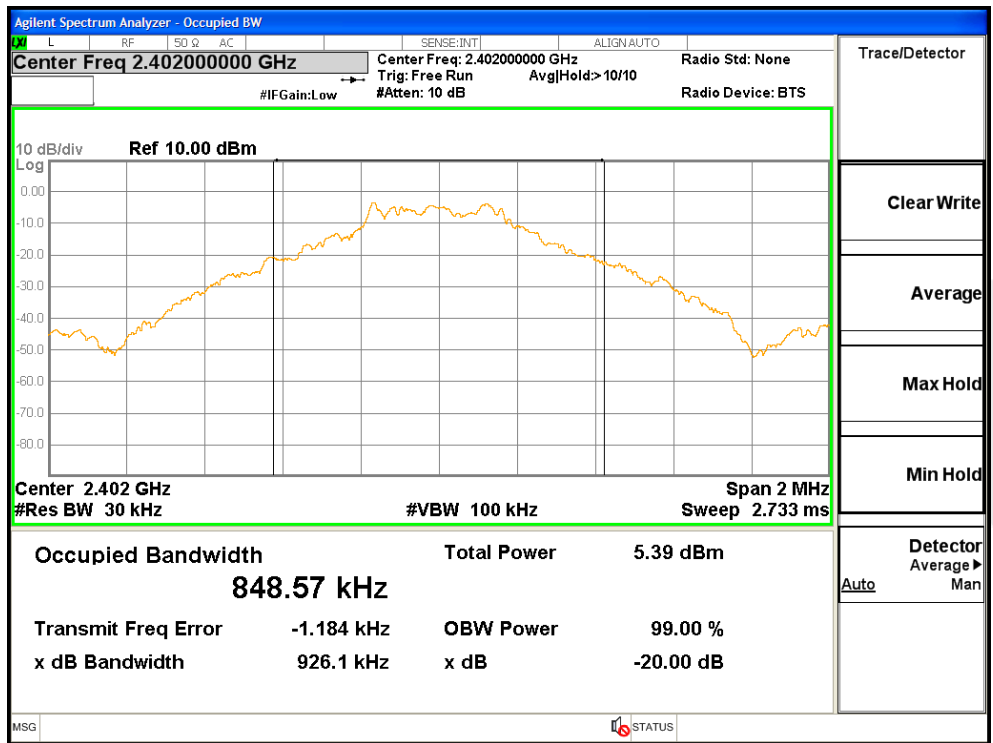

Test Mode: BDR---Low

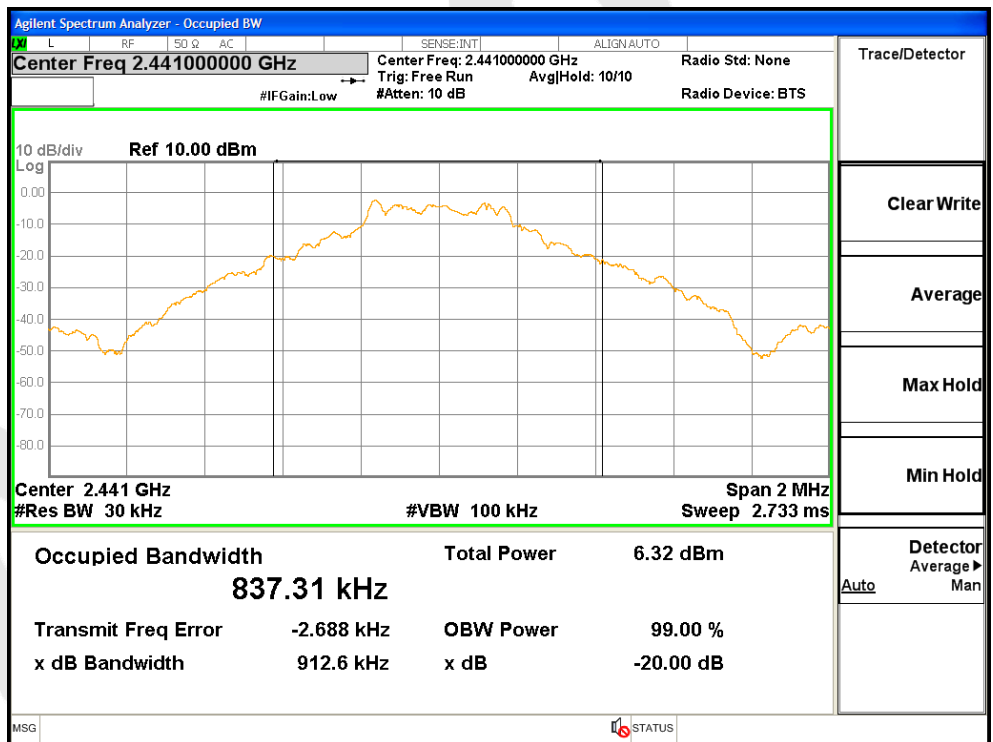

Test Mode: BDR---Middle

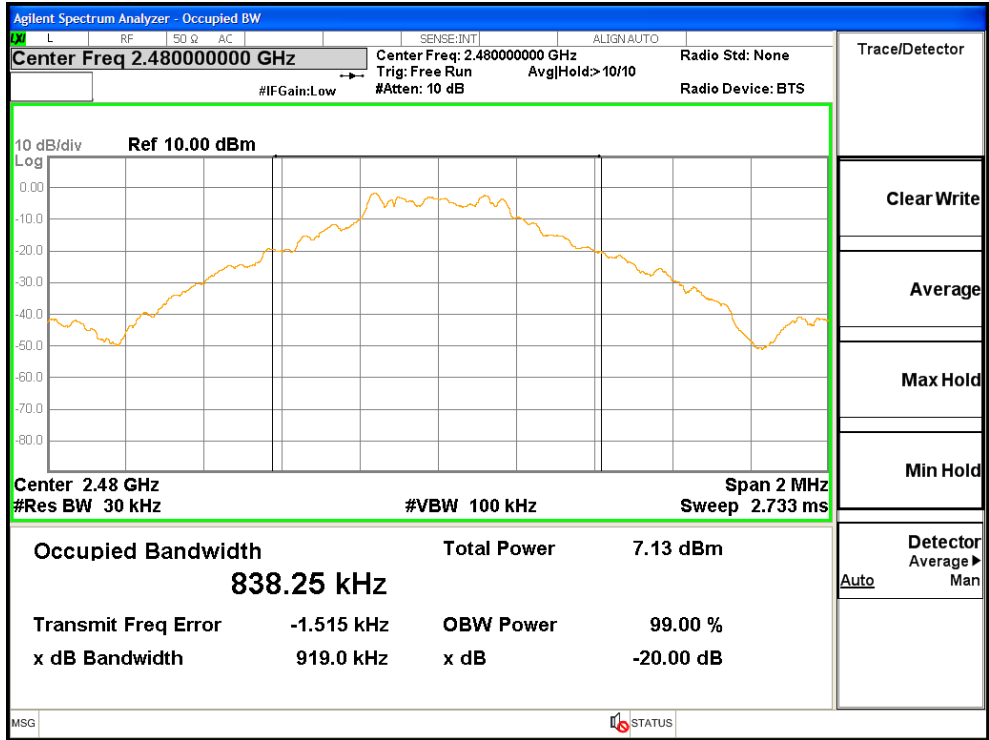

Test Mode: BDR---High

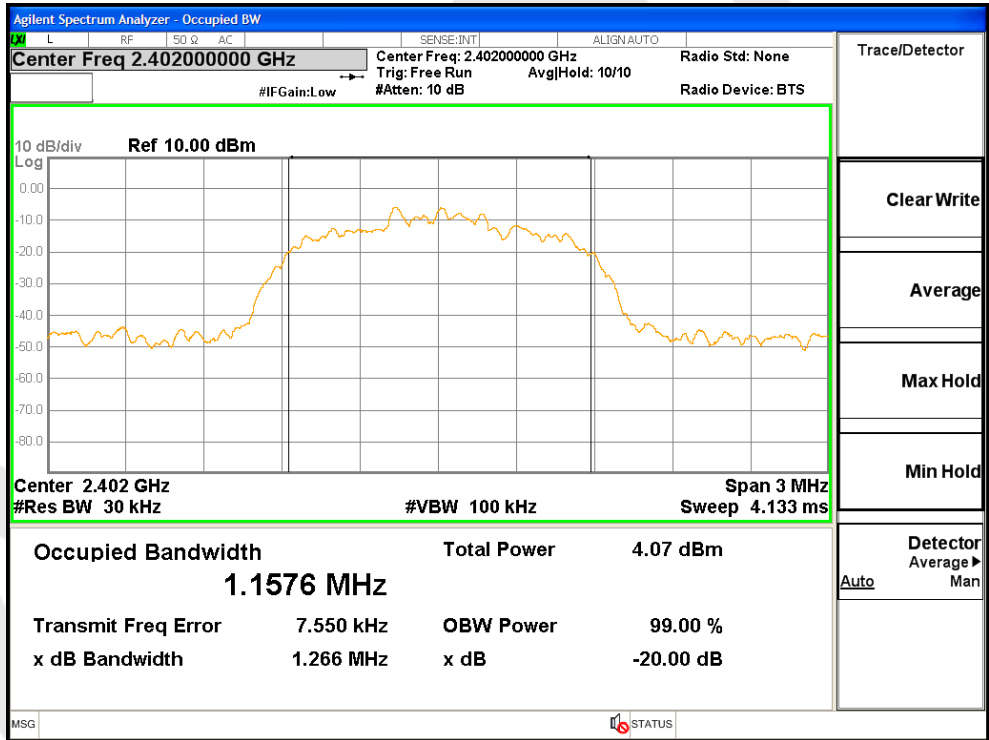

Test Mode: EDR---Low

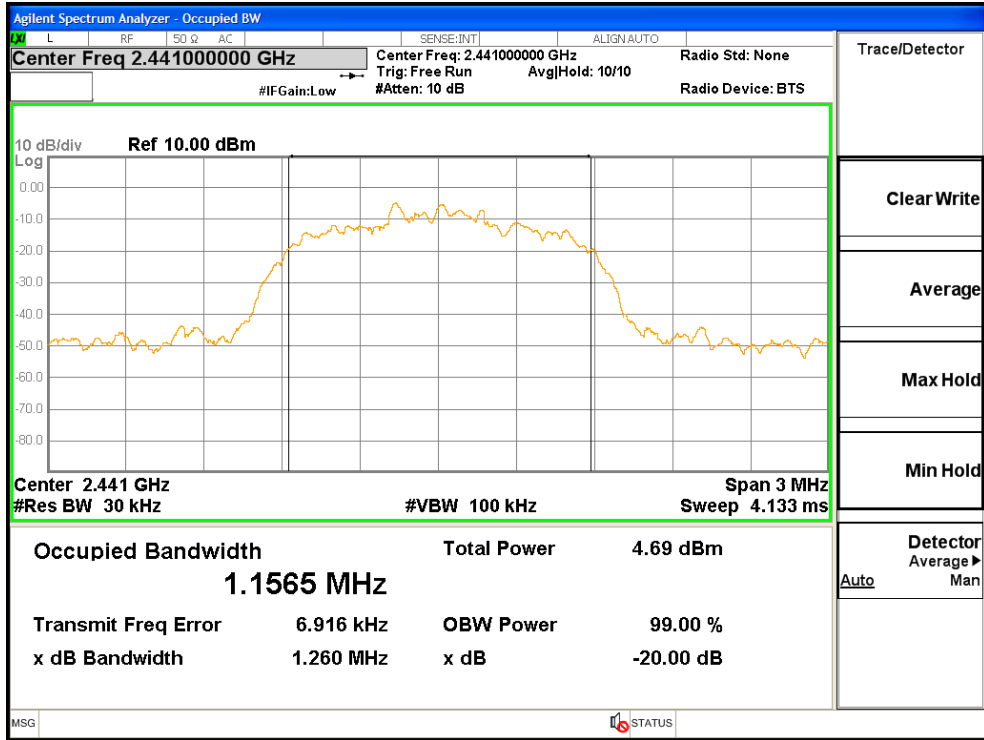

Test Mode: EDR---Middle

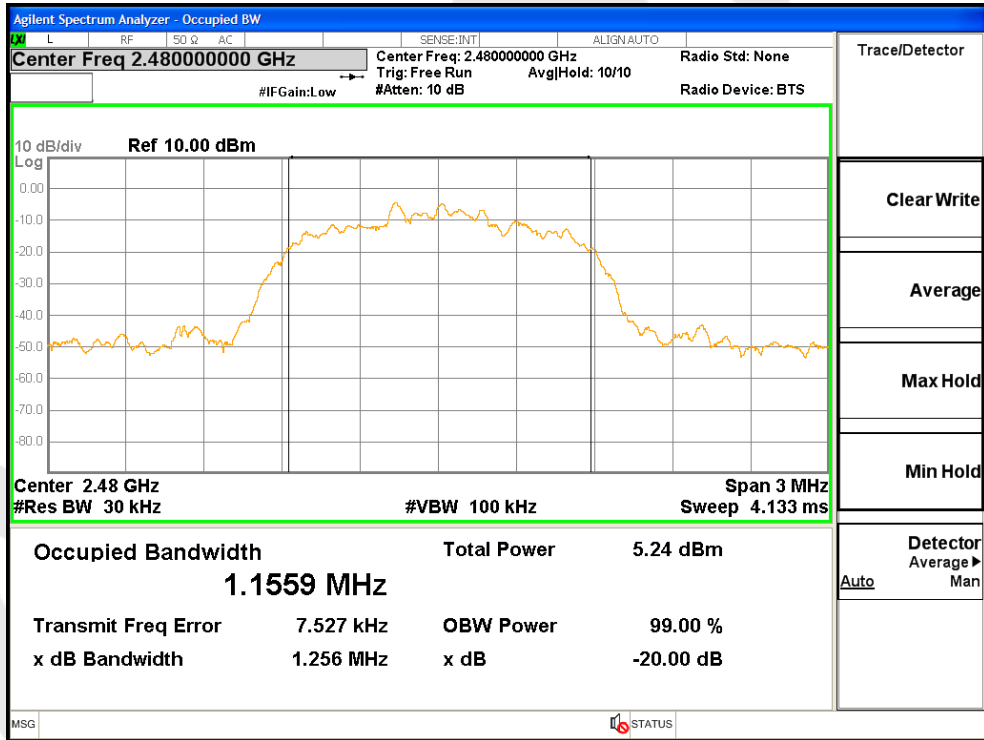

Test Mode: EDR---High

7. Carrier Frequency Separation Test

7.1. Test Standard and Limit

Test Standard	FCC Part15 C Section 15.247 (a)(1)
Test Limit	>25KHz or >two-thirds of the 20 dB bandwidth

7.2. Test Setup

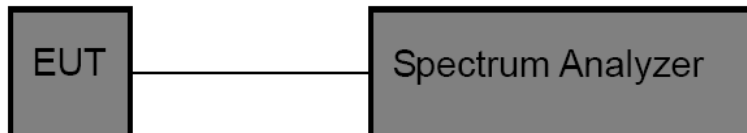

7.3. Test Procedure

The EUT must have its hopping function enabled. Using the following spectrum analyzer settings:

1. Span= Wide enough to capture the peaks of two adjacent channels
2. Set the RBW = 30 kHz.
3. Set the VBW = 100 kHz.
4. Sweep time = auto couple.
5. Detector function = peak.
6. Trace mode = max hold.
7. Allow trace to fully stabilize.

7.4. Test Data

Test Item	: Frequency Separation	Test Mode	: CH Low ~ CH High
Test Voltage	: AC 120V, 60Hz	Temperature	: 24°C
Test Result	: PASS	Humidity	: 55%RH

Channel	Frequency (MHz)	Separation Read Value (kHz)	Limit (kHz)	Modulation Mode
Low	2402	999	926.1	BDR
Middle	2441	1002	912.6	BDR
High	2480	999	919.0	BDR
Low	2402	999	844.0	EDR
Middle	2441	993	840.0	EDR
High	2480	996	837.3	EDR

Remark:

1. The limit of mode (EDR) is 2/3 of 20dB BW;
2. The EDR was tested on ($\pi/4$ DQPSK, 8DPSK) modes, only the worst data of (8DPSK) is attached in the following pages.

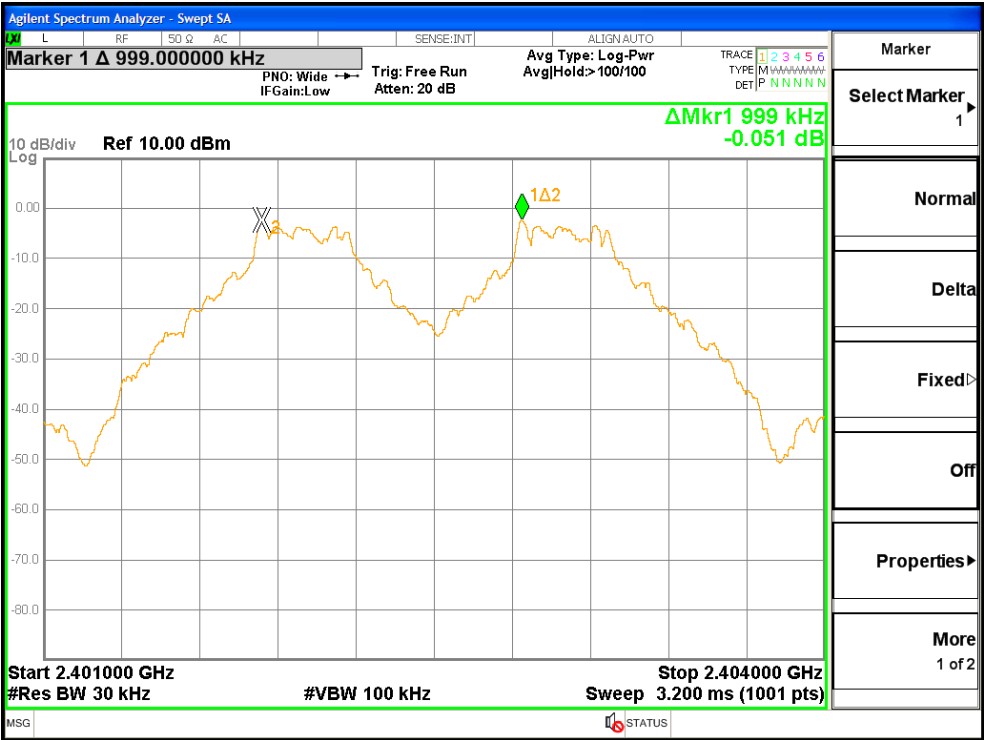

Test Mode: BDR---Low

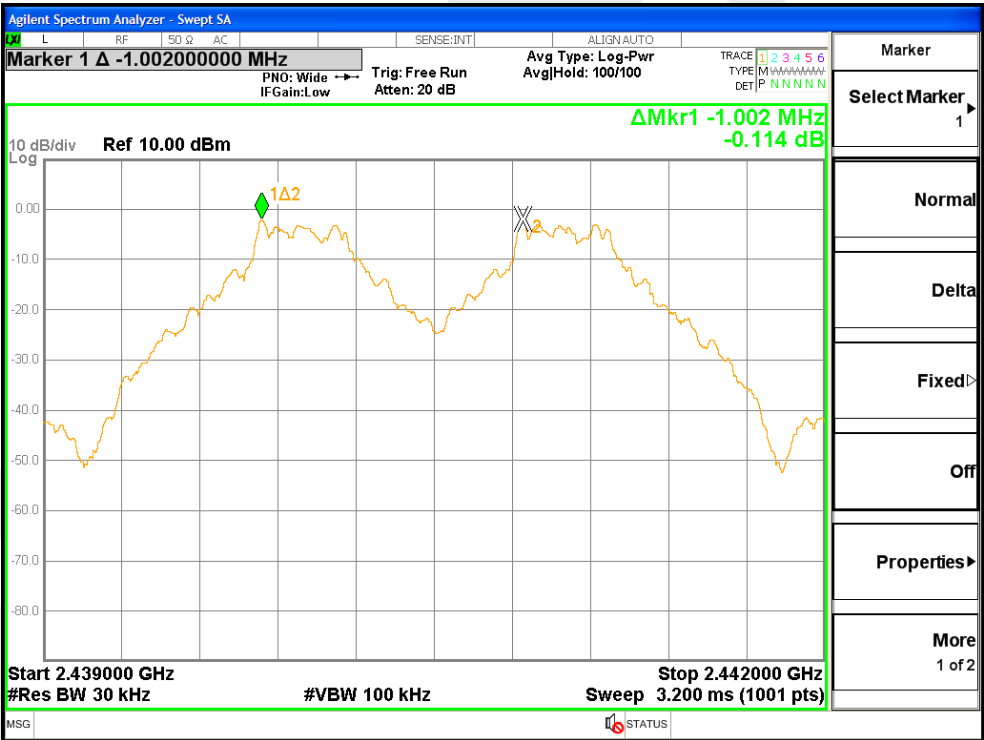

Test Mode: BDR---Middle

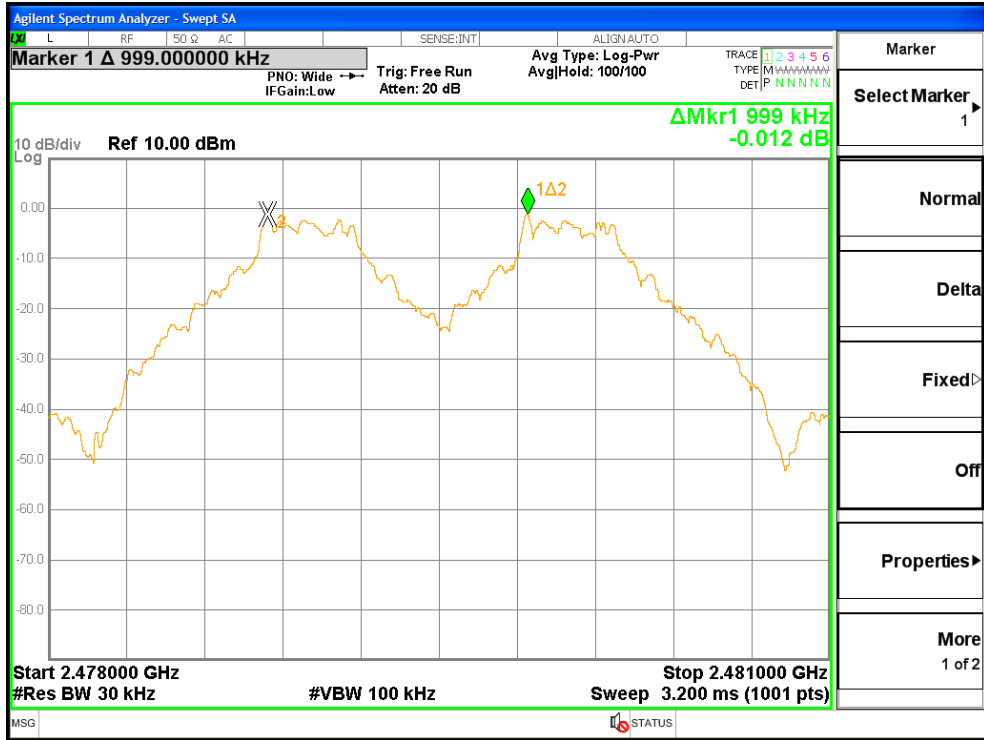

Test Mode: BDR---High

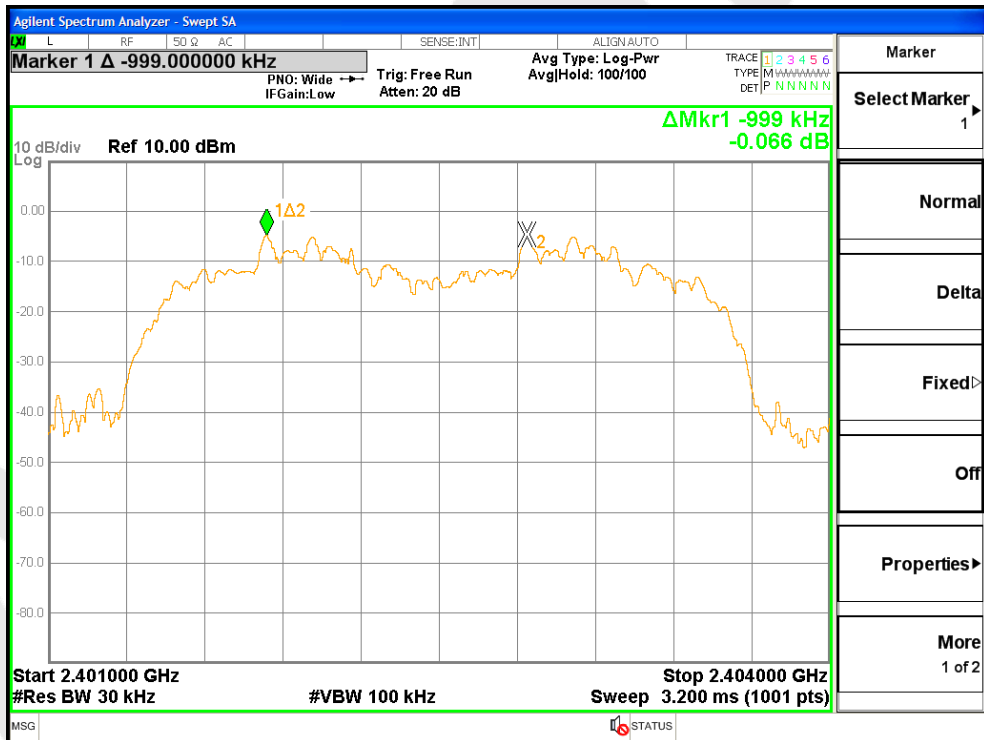

Test Mode: EDR---Low

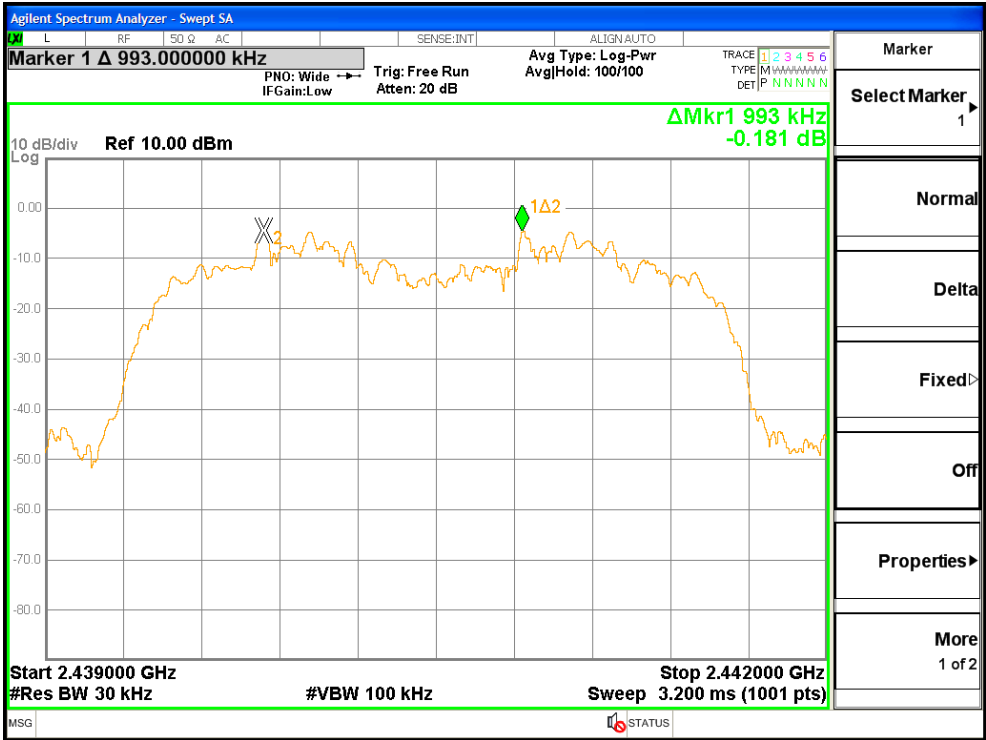

Test Mode: EDR---Middle

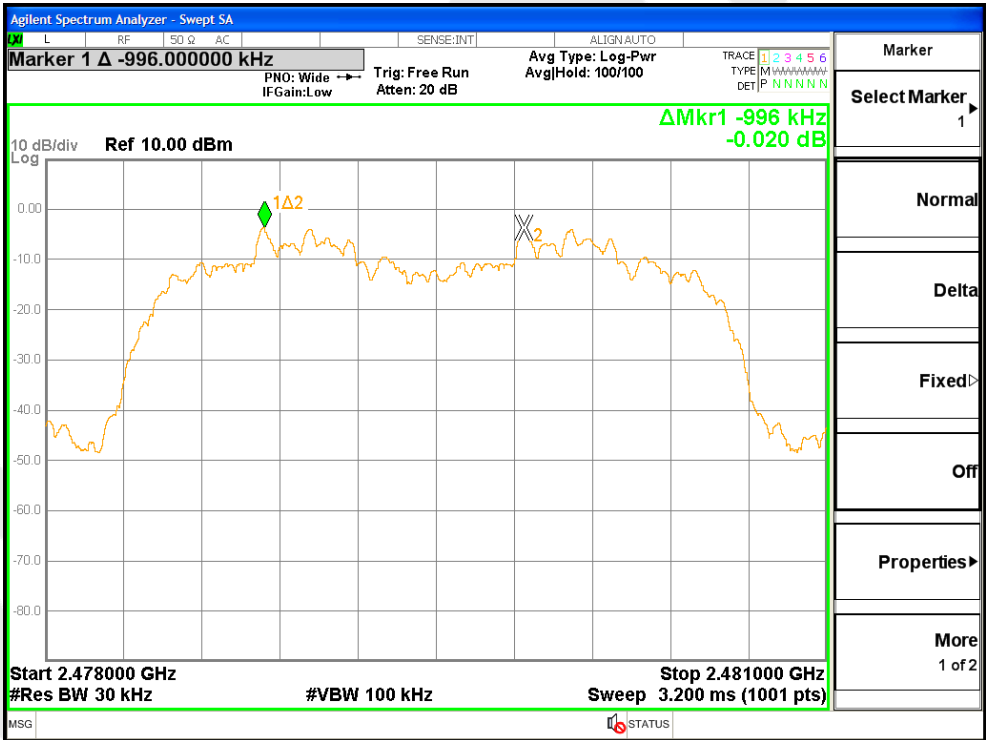

Test Mode: EDR---High

8. Number of Hopping Channel Test

8.1. Test Standard and Limit

Test Standard	FCC Part15 C Section 15.247 (a)(1)
Test Limit	>15 channels

8.2. Test Setup

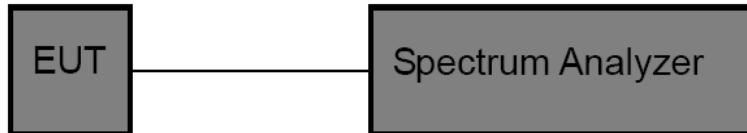

8.3. Test Procedure

The EUT must have its hopping function enabled. Using the following spectrum analyzer setting:

1. Span= the frequency band of operation
2. Set the RBW = 100kHz.
3. Set the VBW = 300kHz.
4. Sweep time = auto couple.
5. Detector function = peak.
6. Trace mode = max hold.
7. Allow trace to fully stabilize.

8.4. Test Data

Test Item : Number of Hopping Frequency
 Test Voltage : AC 120V, 60Hz
 Test Result : PASS

Test Mode : CH Low ~ CH High
 Temperature : 24°C
 Humidity : 55%RH

Hopping Channel Frequency Range	Quantity of Hopping Channel	Quantity of Hopping Channel
2402-2480MHz	79	> 15

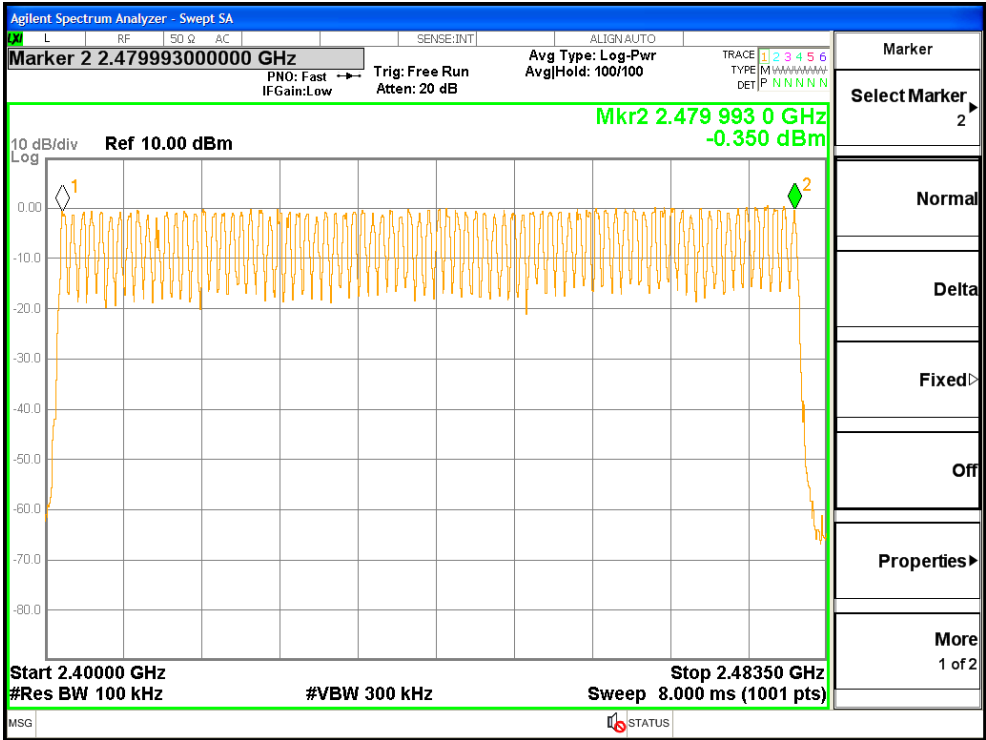

BDR Mode

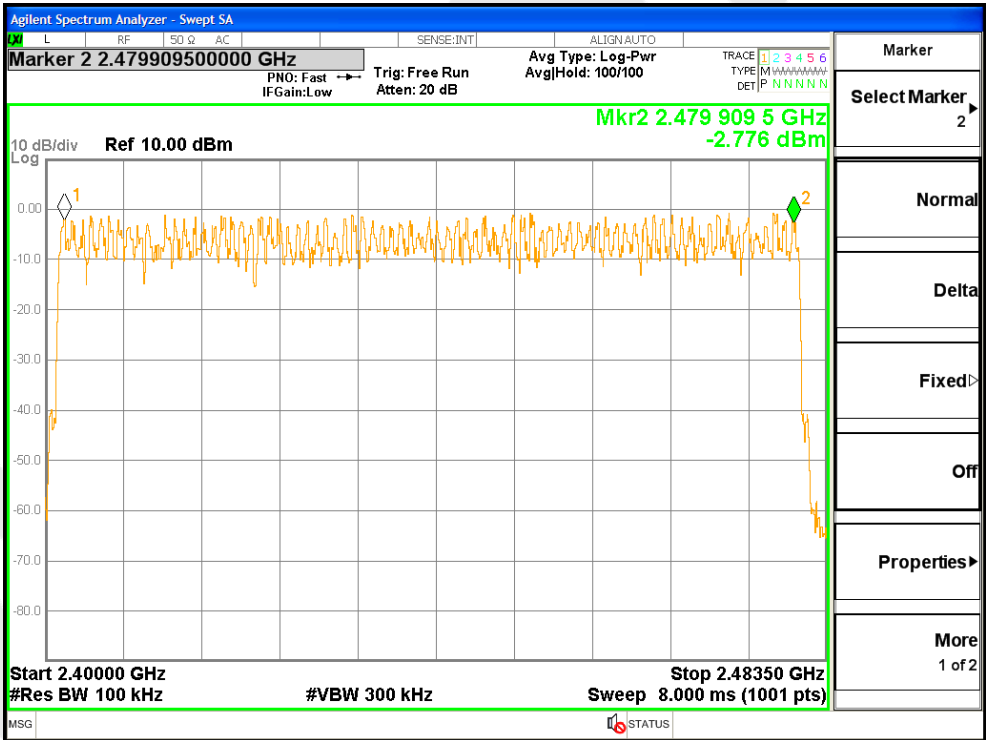

EDR Mode

9. Dwell Time Test

9.1. Test Standard and Limit

Test Standard	FCC Part15 C Section 15.247 (a)(1)
Test Limit	0.4 sec

9.2. Test Setup

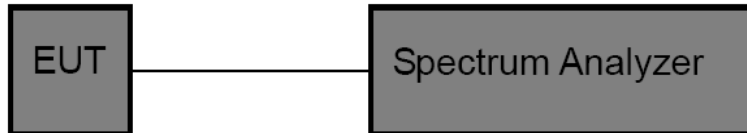

9.3. Test Procedure

The EUT must have its hopping function enabled. Use the following spectrum analyzer settings:

1. Span= zero span, centered on a hopping channel
2. Set the RBW = 1 MHz.
3. Set the VBW = 1 MHz.
4. Sweep time = as necessary to capture the entire dwell time per hopping channel.
5. Detector function = peak.
6. Trace mode = max hold.
7. Allow trace to fully stabilize.

9.4. Test Data

Test Item : Time of Occupancy
 Test Voltage : AC 120V, 60Hz
 Test Result : PASS

Test Mode : CH Low ~ CH High
 Temperature : 24°C
 Humidity : 55%RH

Package Type	Pulse width (ms)	Time slot length(ms)	Dwell time (ms)	Limit (s)	Modulation
DH1	0.366	time slot length *1600/2 /79 * 31.6	117.12	0.4	BDR
DH3	1.615	time slot length *1600/4 /79 * 31.6	258.40	0.4	BDR
DH5	2.863	time slot length *1600/6 /79 * 31.6	305.39	0.4	BDR
3DH1	0.374	time slot length *1600/2 /79 * 31.6	119.68	0.4	EDR
3DH3	1.610	time slot length *1600/4 /79 * 31.6	257.60	0.4	EDR
3DH5	2.863	time slot length *1600/6 /79 * 31.6	305.39	0.4	EDR

Remark: The EDR was tested on ($\pi/4$ DQPSK, 8DPSK) modes, only the worst data of (8DPSK) is attached in the following pages.

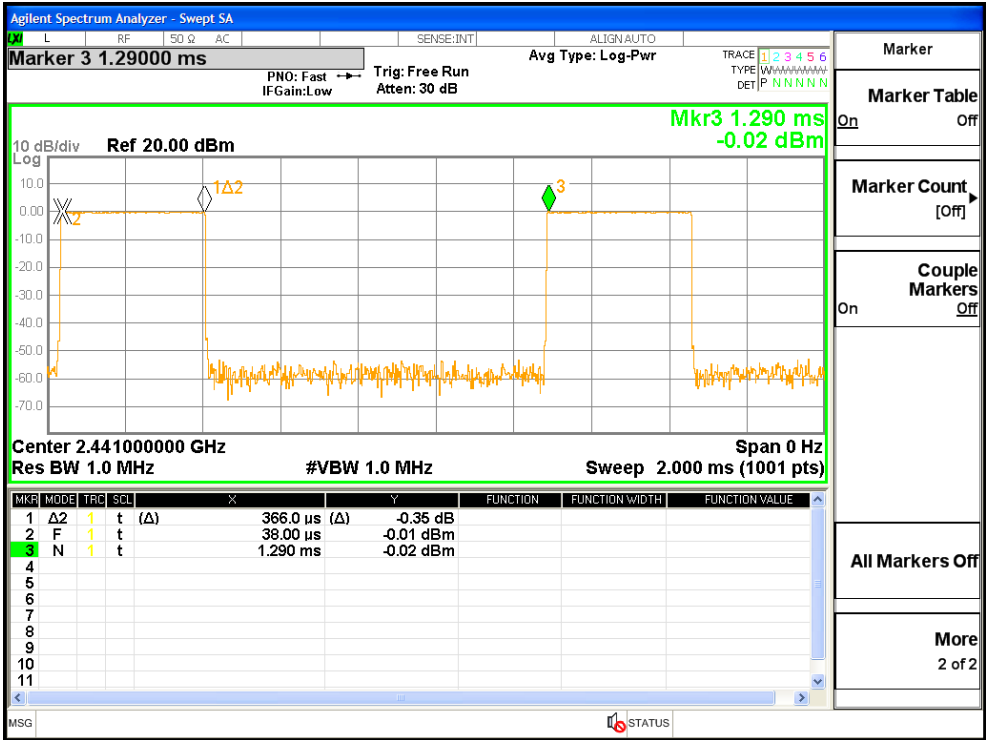

Test Mode: BDR---DH1

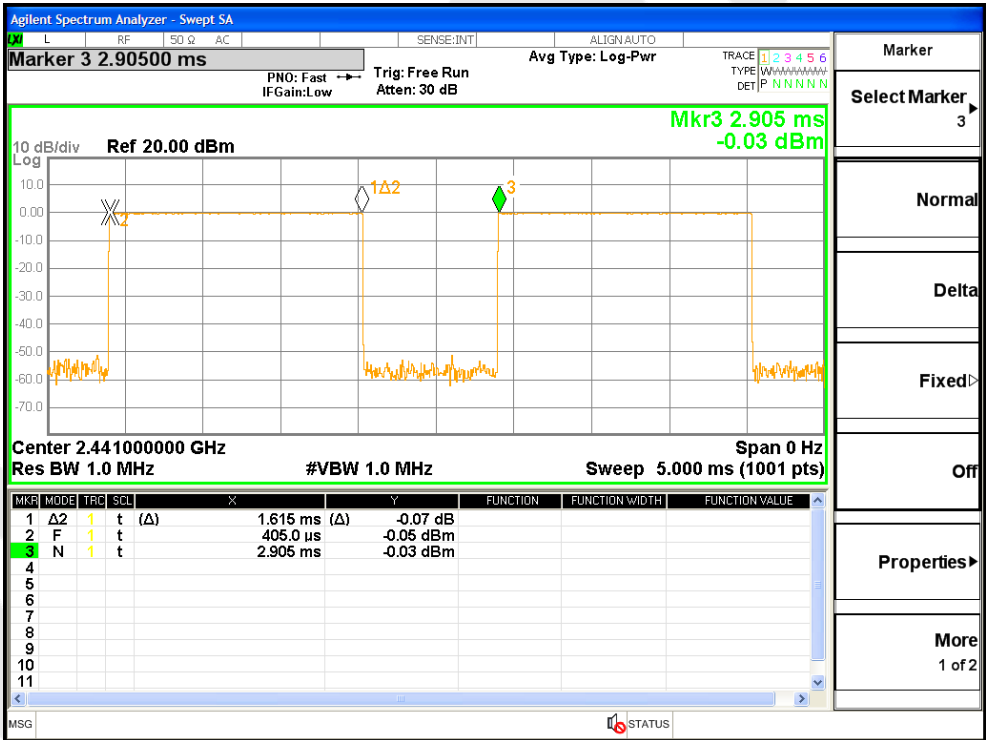

Test Mode: BDR---DH3

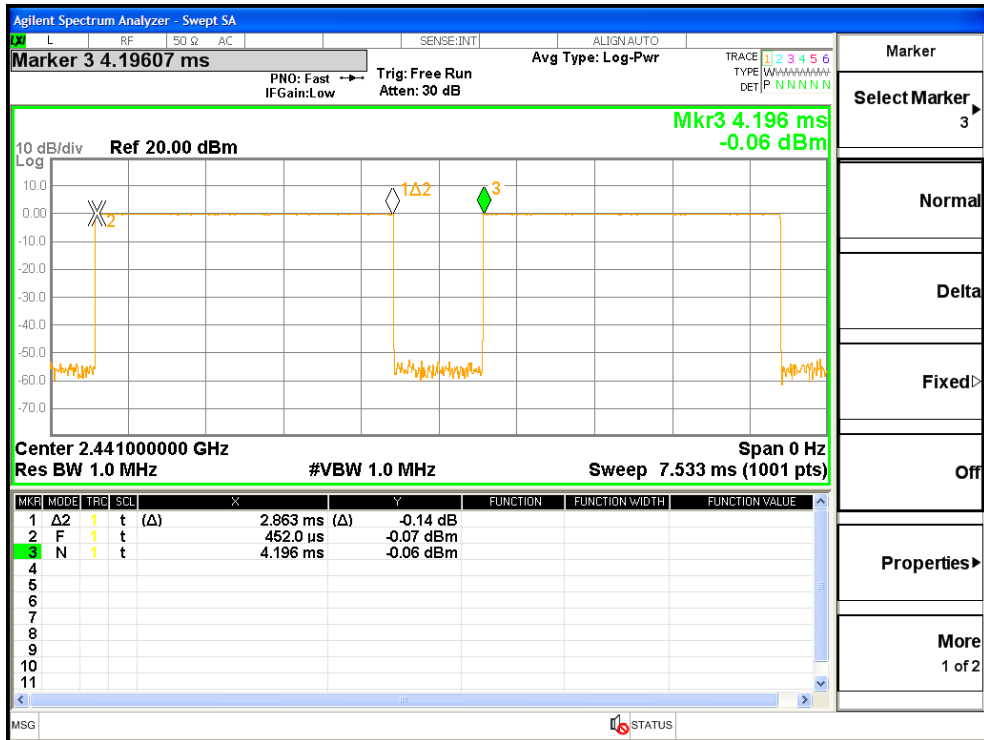

Test Mode: BDR—DH5

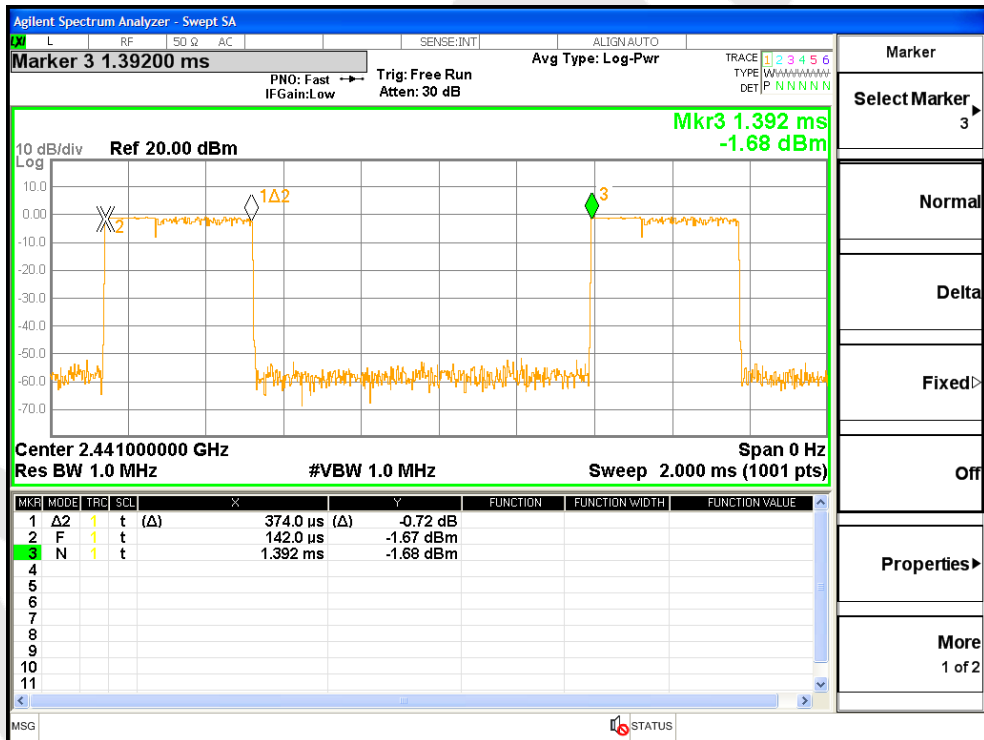

Test Mode: EDR---3DH1

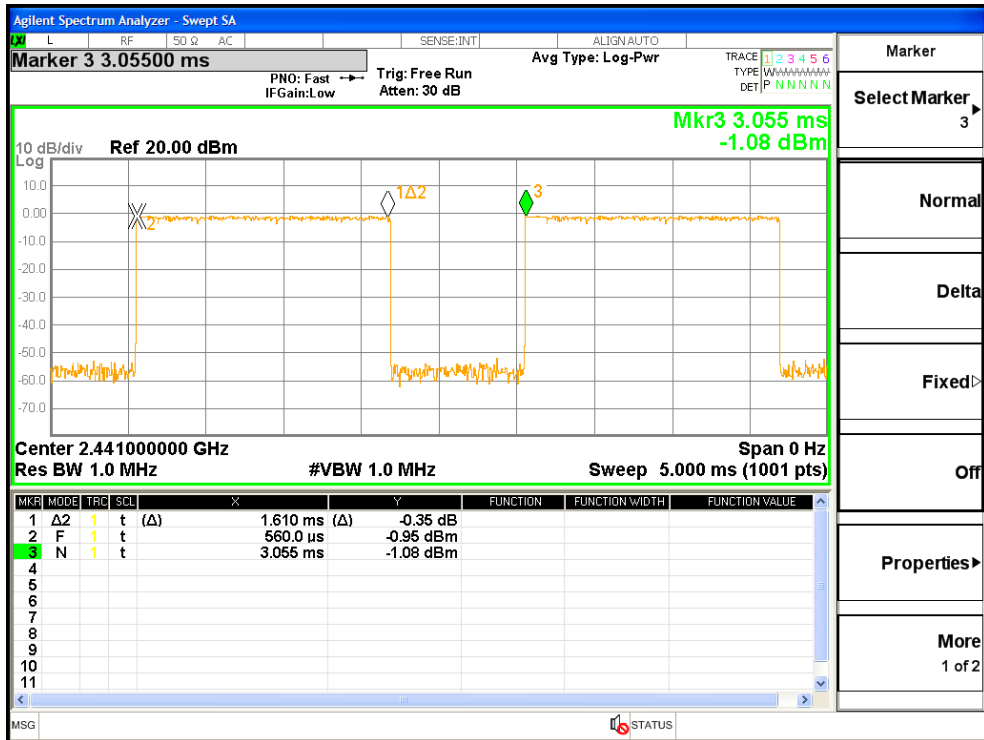

Test Mode: EDR---3DH3

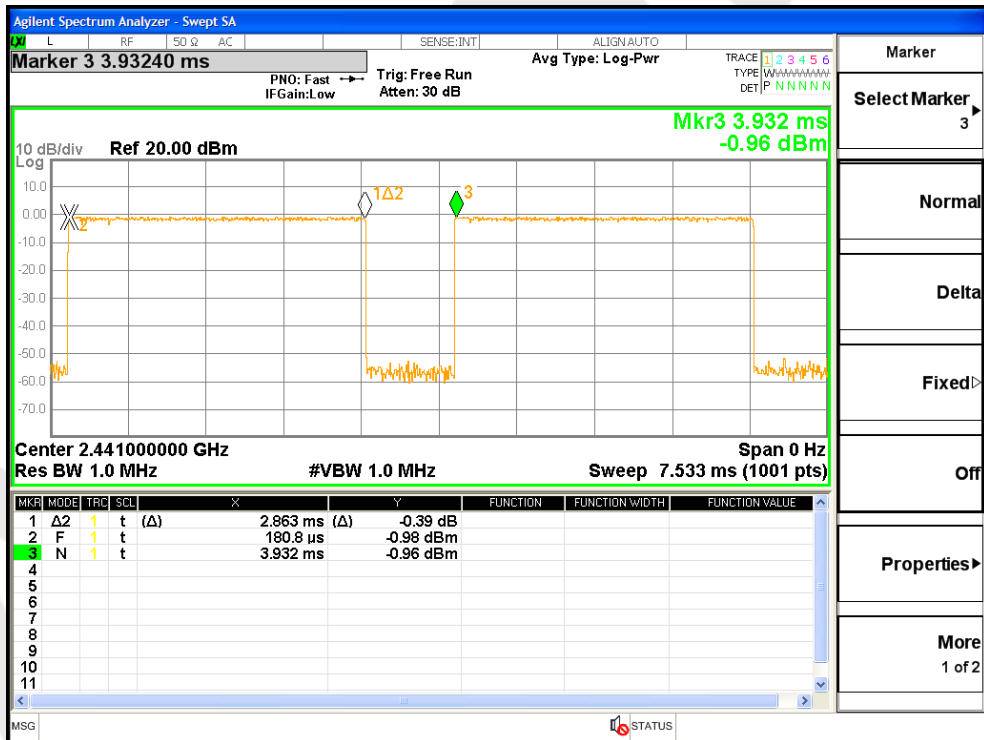

Test Mode: EDR—3DH5

10. 100kHz Bandwidth of Frequency Band Edge Requirement

10.1. Test Standard and Limit

Test Standard	FCC Part15 C Section 15.247 (d)
Test Limit	in any 100 kHz bandwidth outside the frequency bands in which the spread spectrum intentional radiator in operating, the radio frequency power that is produced by the intentional radiator shall be at least 20dB below that in the 100kHz bandwidth within the band that contains the highest level of the desired power, In addition, radiated emissions which fall in the restricted bands, as defined in §15.205(a), must also comply with the radiated emission limits specified in 15.209(a).

10.2. Test Setup

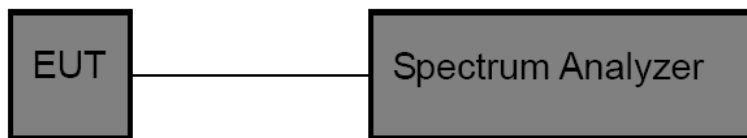

10.3. Test Procedure

The EUT must have its hopping/Non-hopping function enabled. Using the following spectrum analyzer setting:

1. Set the RBW = 1MHz.
2. Set the VBW = 3MHz.
3. Sweep time = auto couple.
4. Detector function = peak.
5. Trace mode = max hold.
6. Allow trace to fully stabilize.

10.4. Test Data

Test Item	: Band edge	Test Mode	: CH Low ~ CH High
Test Voltage	: AC 120V, 60Hz	Temperature	: 24°C
Test Result	: PASS	Humidity	: 55%RH

Remark: The EDR was tested on (GFSK, $\pi/4$ DQPSK, 8DPSK) modes, only the worst data of ($\pi/4$ DQPSK) is attached in the following pages.

For Hopping Mode

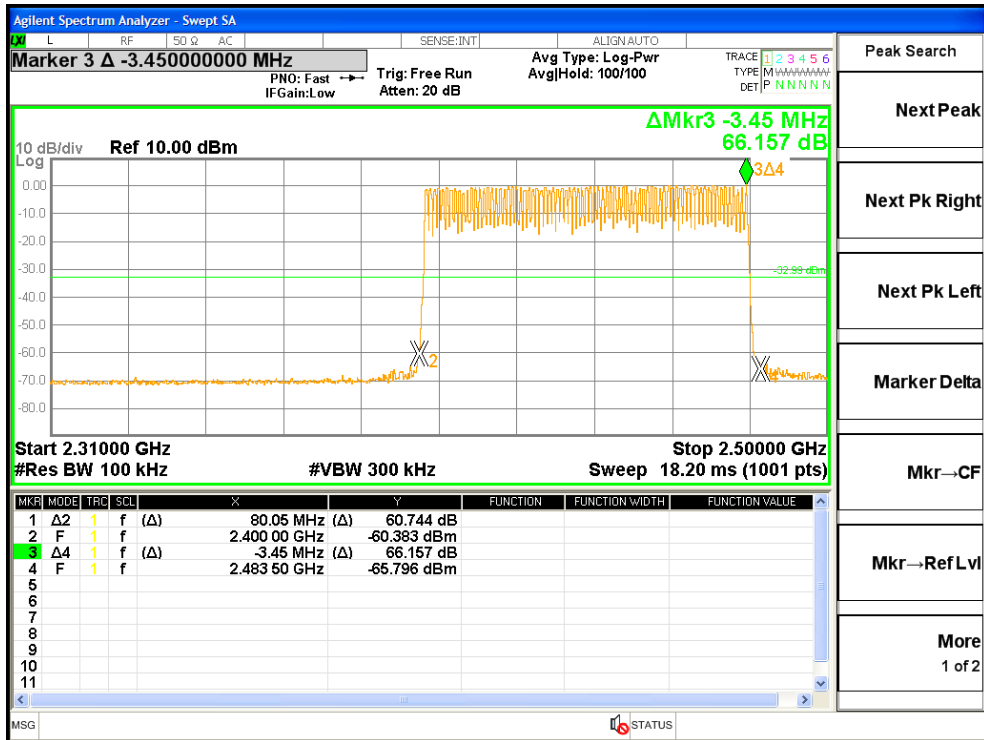

BDR mode

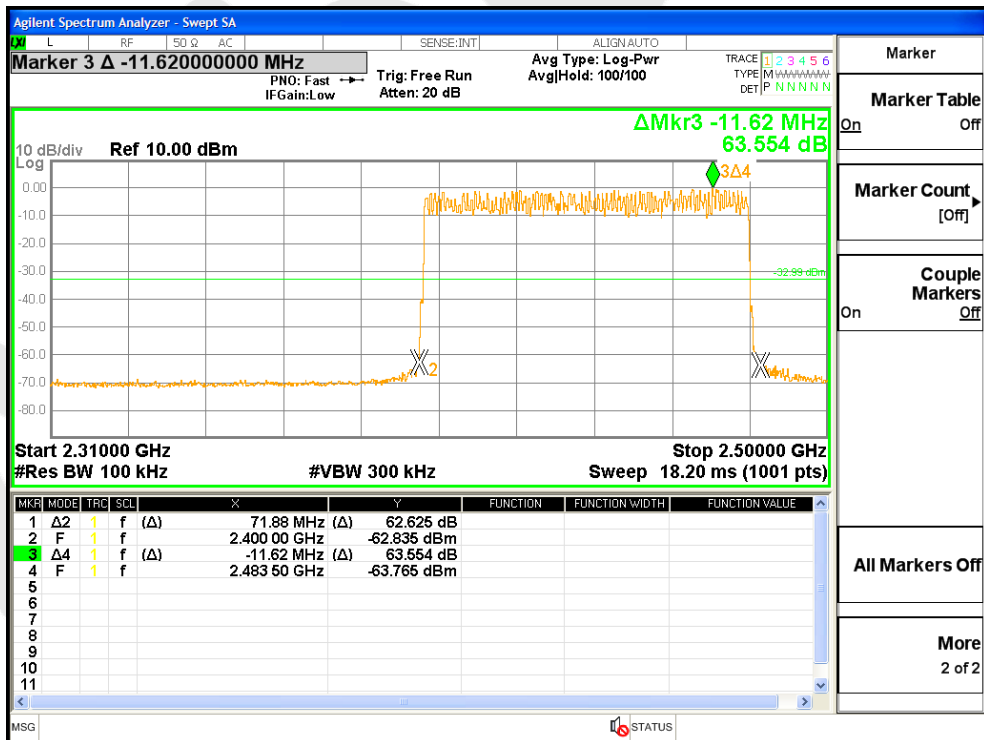

EDR mode

For Non-Hopping Mode

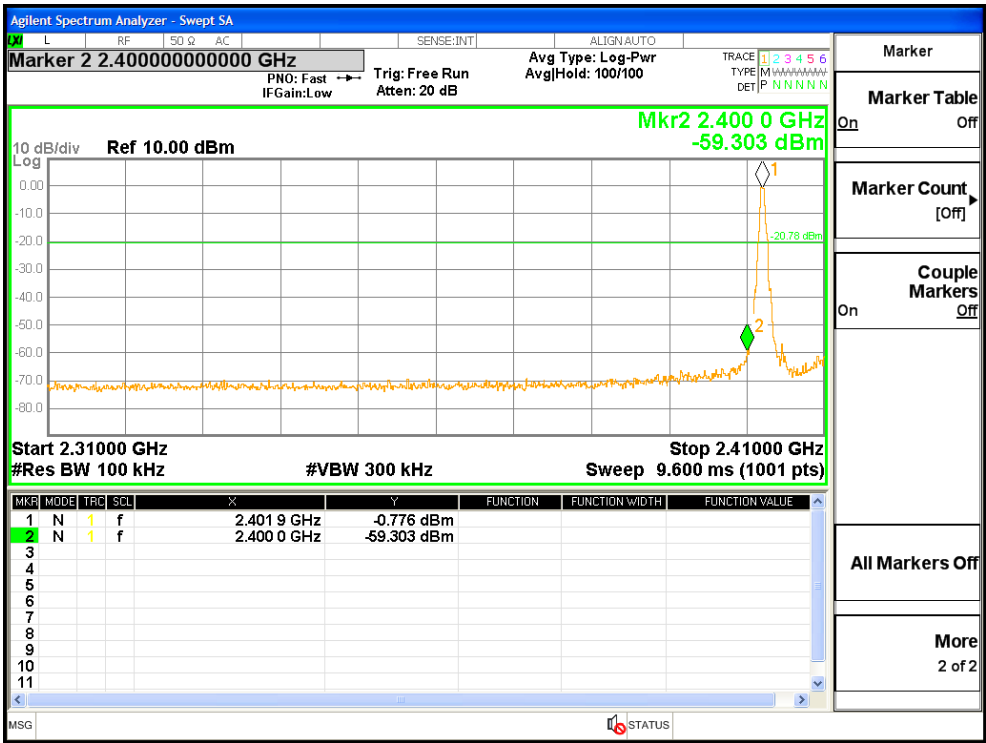

BDR mode -- Lowest

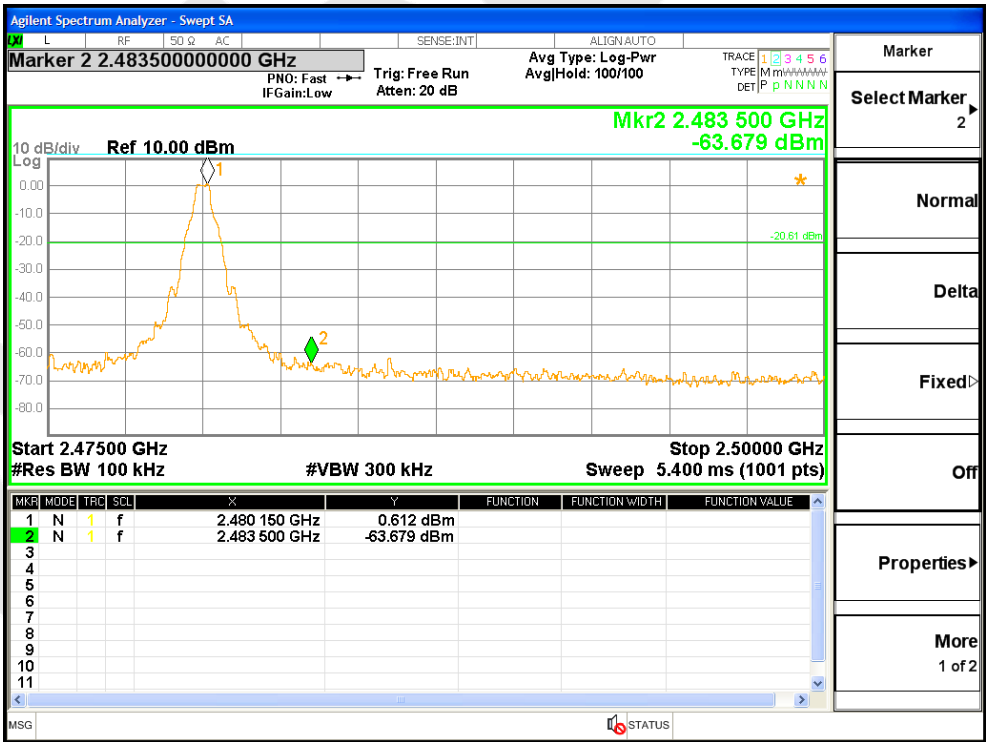

BDR mode -- Highest

For Non-Hopping Mode

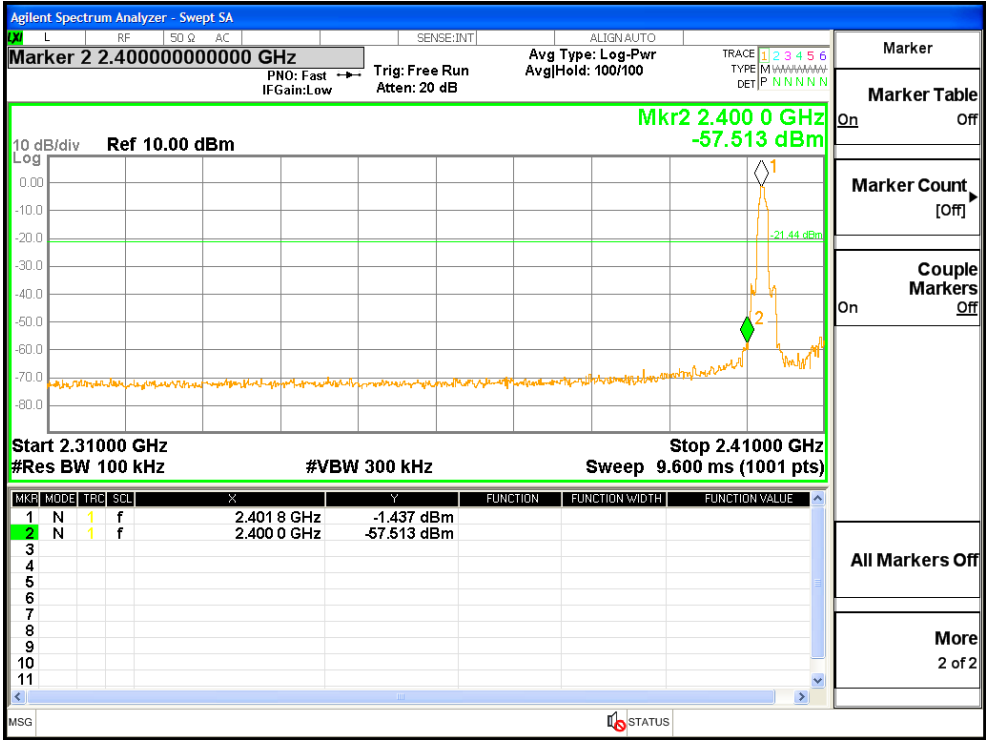

EDR mode -- Lowest

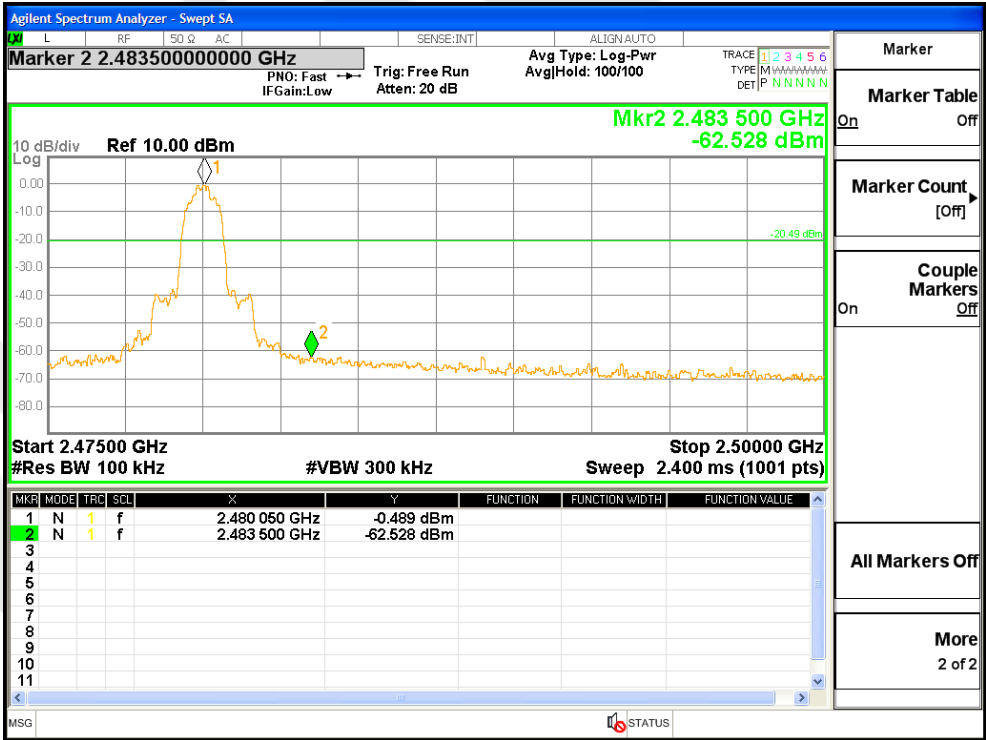

EDR mode -- Highest

11. Antenna Requirement

11.1. Test Standard and Requirement

Test Standard	FCC Part15 Section 15.203 /247(c)
Requirement	<p>1) 15.203 requirement: An intentional radiator shall be designed to ensure that no antenna other than that furnished by the responsible party shall be used with the device. The use of a permanently attached antenna or of an antenna that uses a unique coupling to the intentional radiator, the manufacturer may design the unit so that a broken antenna can be replaced by the user, but the use of a standard antenna jack or electrical connector is prohibited.</p> <p>2) 15.247(c) (1)(i) requirement: Systems operating in the 2400-2483.5 MHz band that is used exclusively for fixed. Point-to-point operations may employ transmitting antennas with directional gain greater than 6dBi provided the maximum conducted output power of the intentional radiator is reduced by 1 dB for every 3 dB that the directional gain of the antenna exceeds 6 dBi.</p>

11.2. Antenna Connected Construction

The bluetooth antenna is PCB antenna which permanently attached, and the best case gain of the antenna is 2dBi. It complies with the standard requirement.

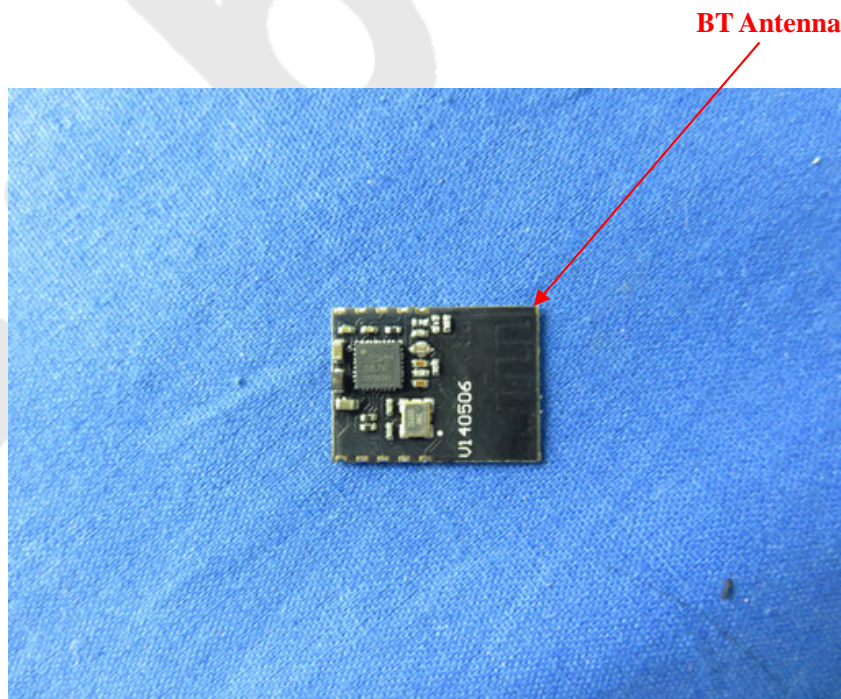

APPENDIX I -- TEST SETUP PHOTOGRAPH

Photo of Radiation Emission Test

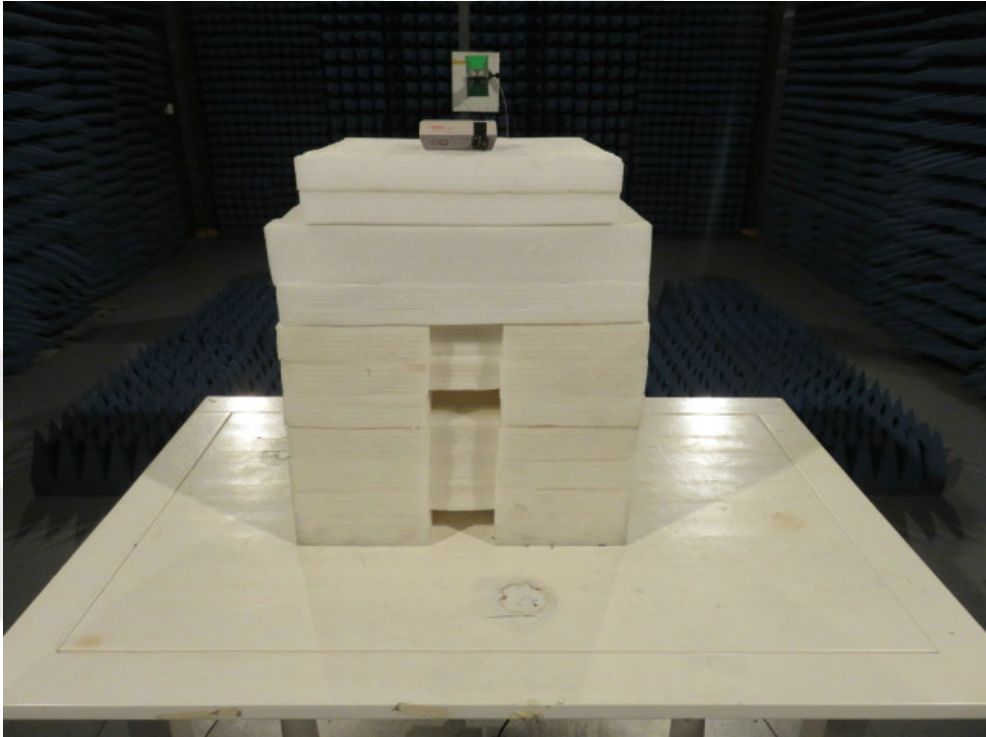
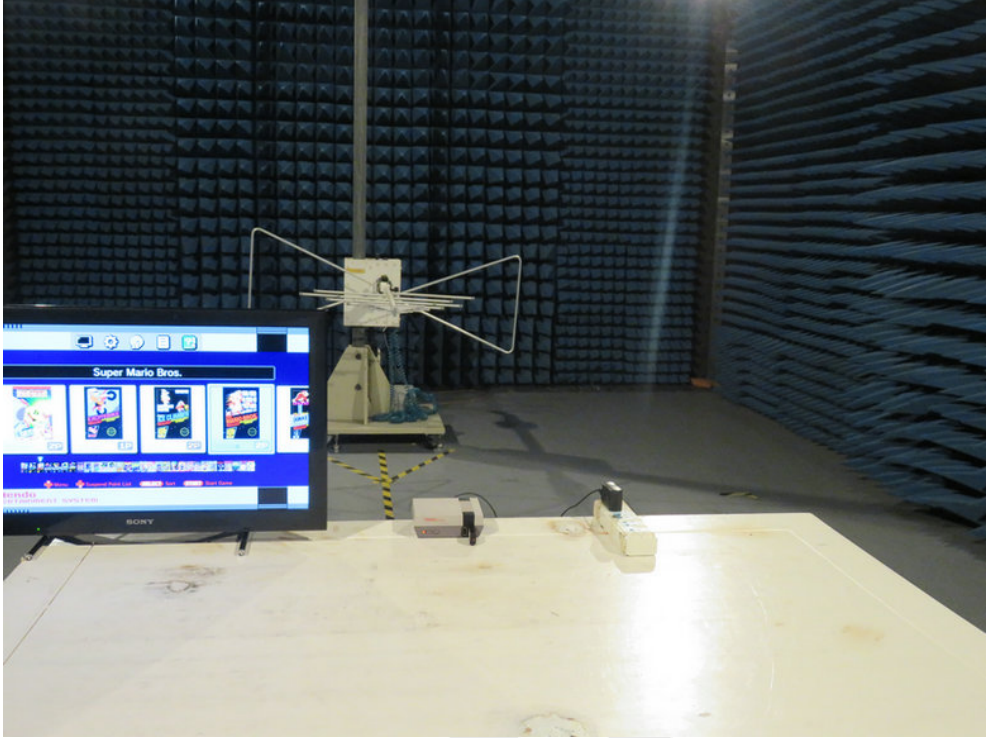

APPENDIX II -- EXTERNAL PHOTOGRAPH

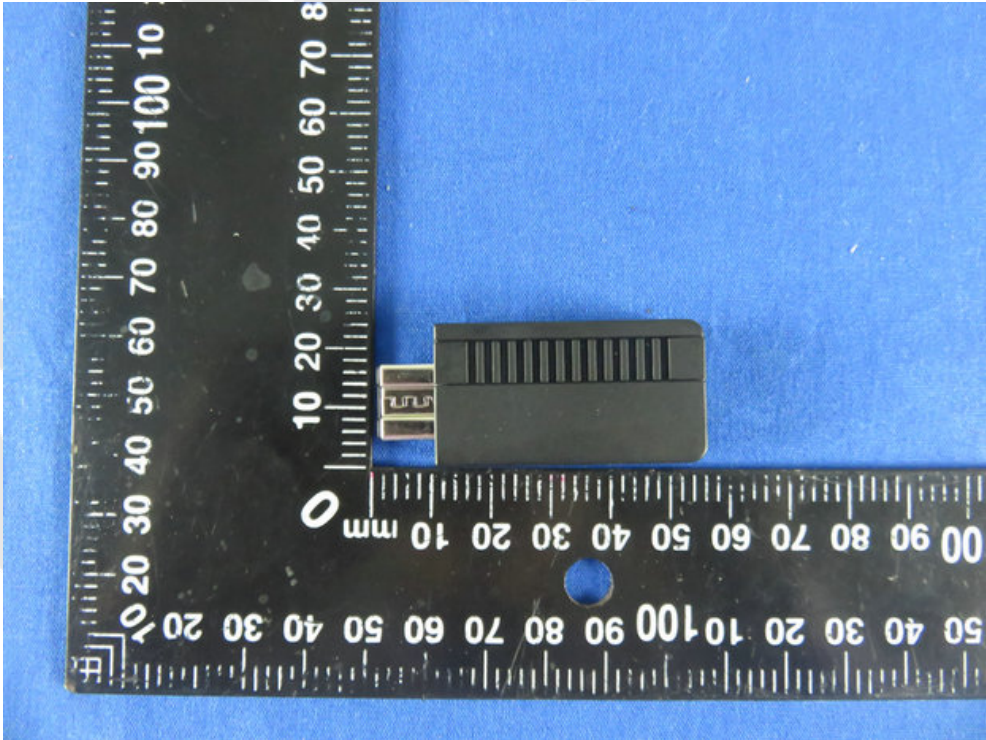
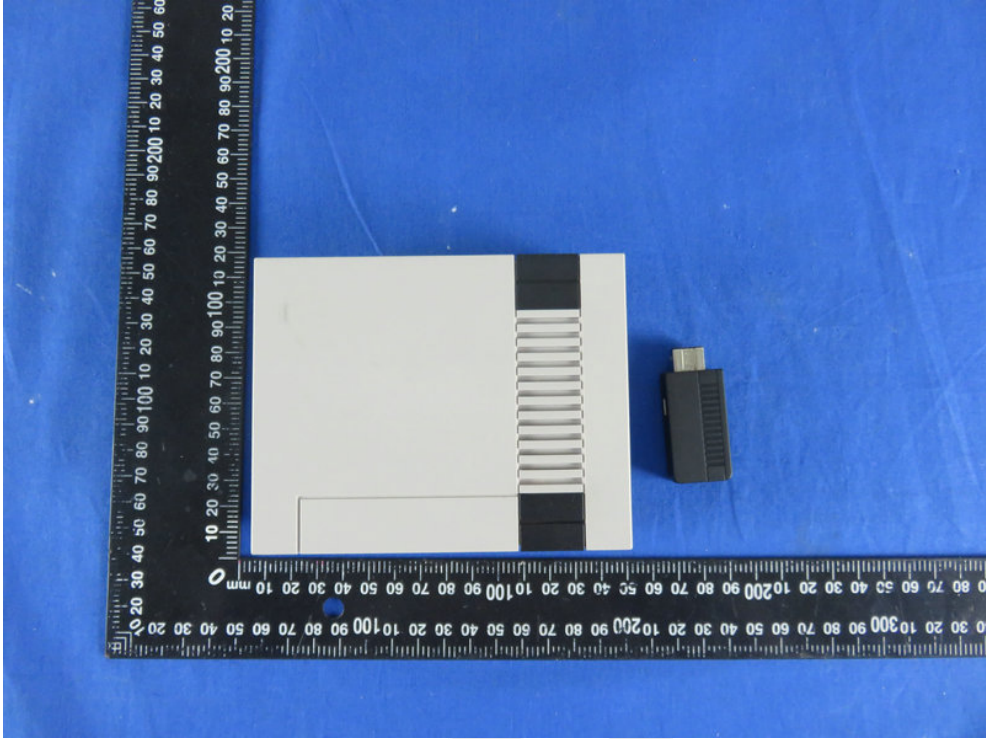

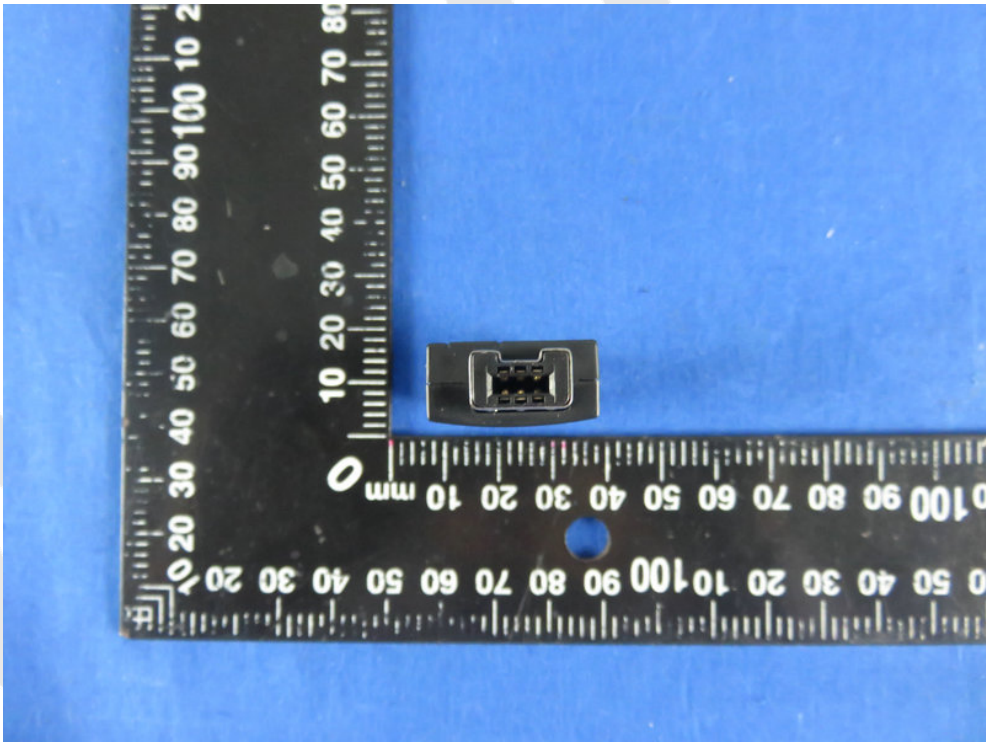
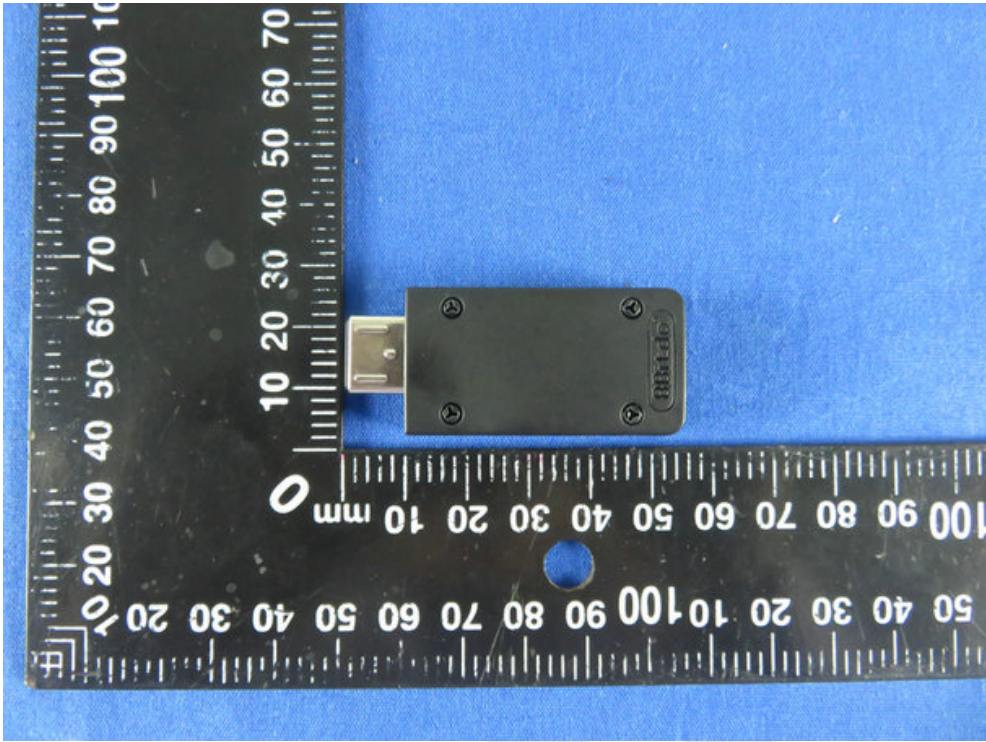

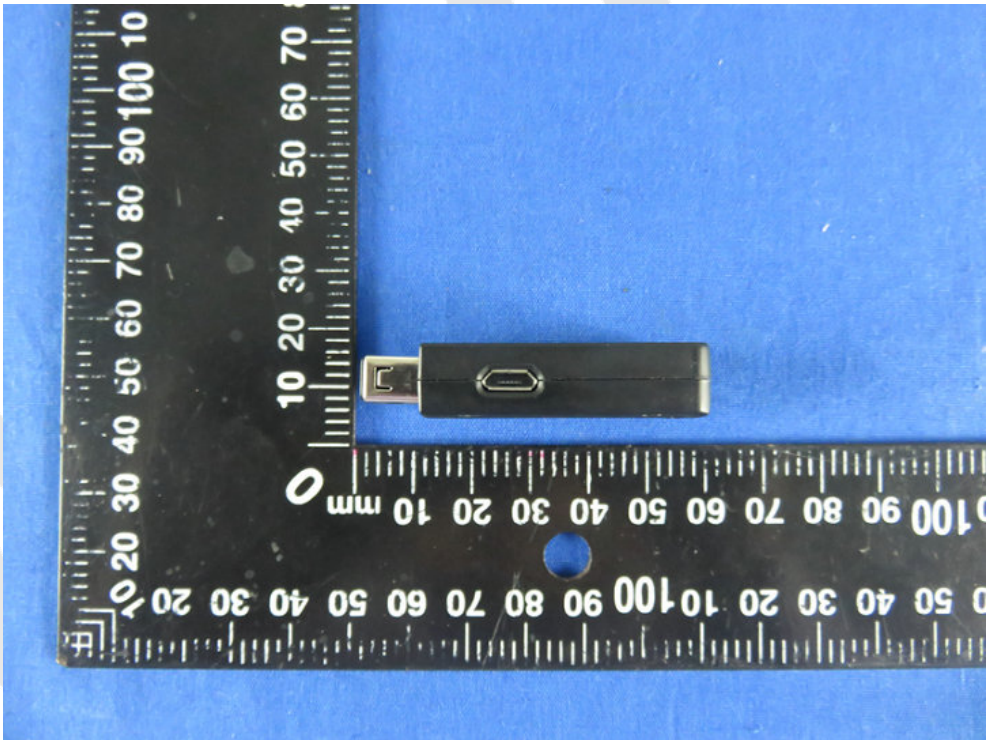
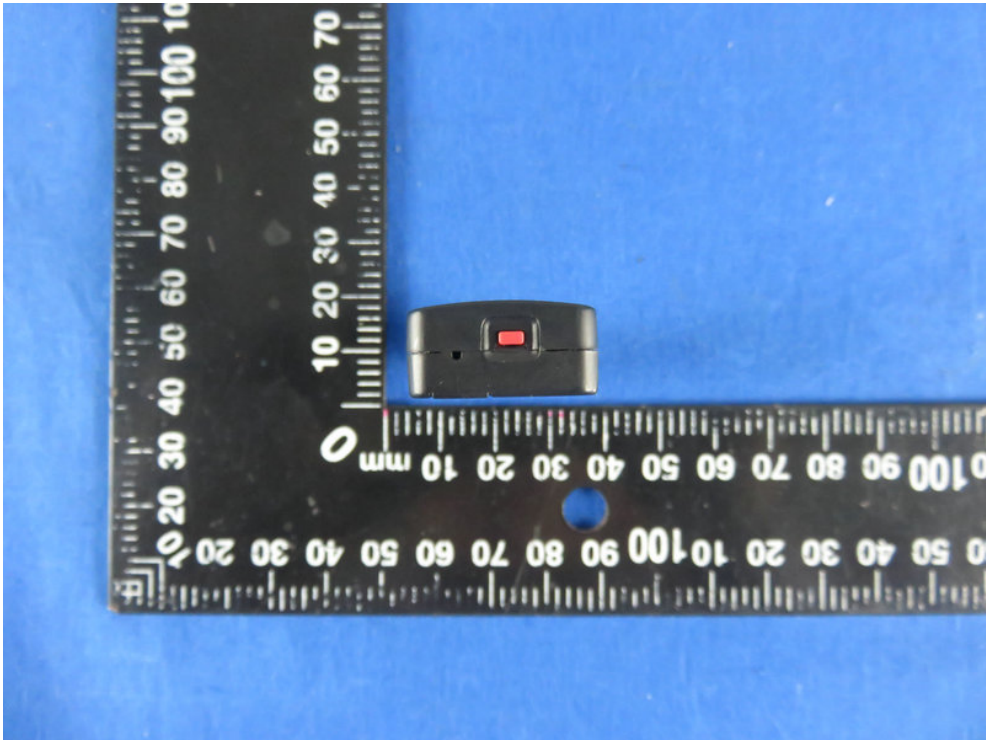

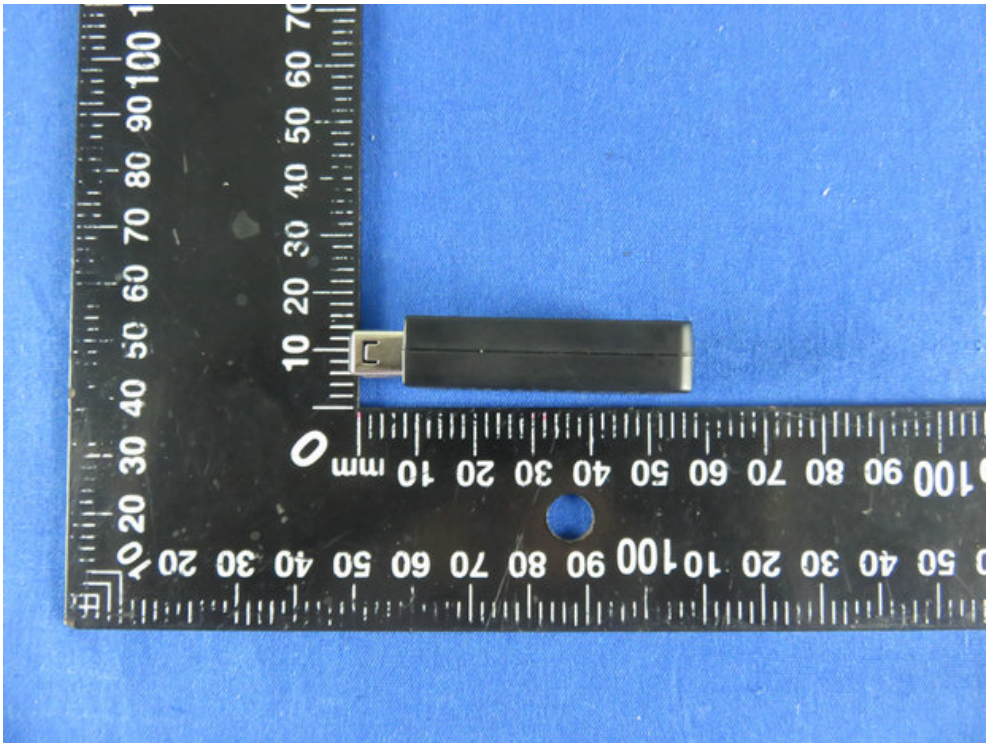

APPENDIX III -- INTERNAL PHOTOGRAPH

