

# Antenna Datasheet of 2111400100

**Antenna Type :** Monopole

**Antenna Brand :** Molex

**Antenna Model :** 2111400100

**Peak Gain :** 1.00 dBi (902 - 928MHz)

**Antenna Manufacturer and Manufacturer Address :** 2222 Wellington Court,

Lisle, IL 60532, USA

**Antenna Patterns(2D or 3D) :**

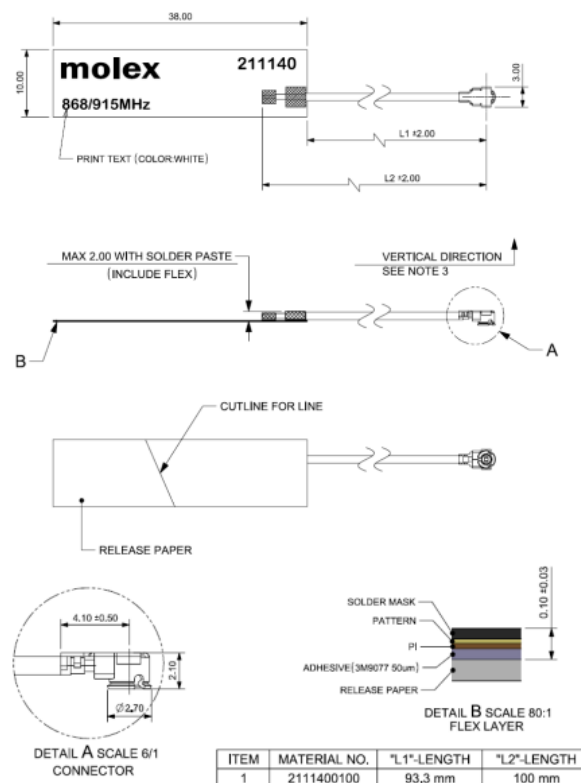



# APPLICATION SPECIFICATION

## 868/915MHZ FLEXIBLE ANTENNA

### TABLE OF CONTENTS

- 1.0 SCOPE
- 2.0 PRODUCT DESCRIPTION
- 3.0 APPLICABLE DOCUMENTS
- 4.0 ANTENNA PERFORMANCE
- 5.0 ASSEMBLY GUIDELINE
- 6.0 RF PERFORMANCE AS A FUNCTION OF IMPLEMENTATION

Address: 2222 Wellington Court, Lisle, IL 60532, USA

REVISION: <b>A</b>	ECR/ECN INFORMATION: EC No: 608264 DATE: 2018/12/03	TITLE: <b>868/915MHz Flexible Antenna Application Specification</b>	SHEET No. <b>1 of 20</b>
DOCUMENT NUMBER: <b>AS-2111400100</b>	CREATED / REVISED BY: Liu Hai 2018/11/29	CHECKED BY: Cheng Kang 2018/11/29	APPROVED BY: Chris Zhong 2018/11/29

## 868/915MHZ FLEXIBLE ANTENNA

### 1.0 SCOPE

This specification describes the antenna application and surrounding. The information in this document is for reference and benchmark purposes only. The user is responsible for validating antenna rf performance based on the user's actual implementation.

Antenna illustrations in this document are generic representations. They are not intended to be an image of any antenna listed in the scope.

### 2.0 PRODUCT DESCRIPTION

#### 2.1 PRODUCT NAME AND SERIES NUMBER (S)

Product name: 868/915MHz Flexible Antenna

Series Number: 211140

#### 2.2 DESCRIPTION

211140 is a monopole flexible antenna for ISM 868/915MHz dual band. Antenna size 38x10x0.1mm is made from flexible polymer material, cable standard length 100mm. It can be easily installed by simply "peel and stick" on non-metal surface.

#### 2.3 PRODUCT STRUCTURE INFORMATION

Please refer to PS-2111400100 for full information.

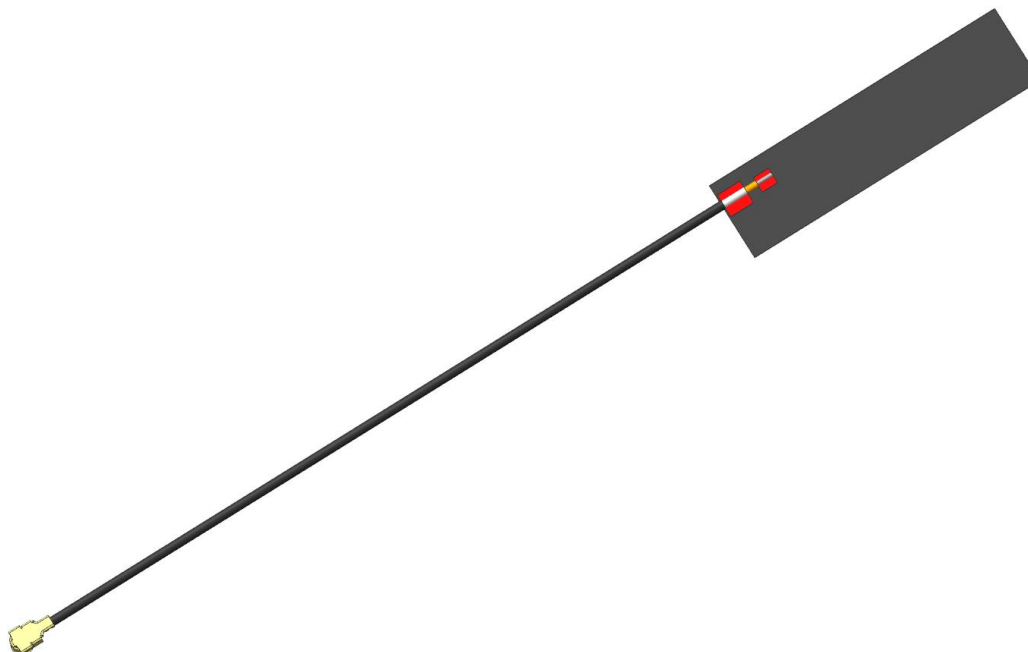

Molex 2111400100 868/915MHz Flexible Antenna 3D View

REVISION: <b>A</b>	ECR/ECN INFORMATION: EC No: 608264 DATE: 2018/12/03	TITLE: <b>868/915MHz Flexible Antenna Application Specification</b>	SHEET No. <b>2 of 20</b>
DOCUMENT NUMBER: <b>AS-2111400100</b>	CREATED / REVISED BY: Liu Hai 2018/11/29	CHECKED BY: Cheng Kang 2018/11/29	APPROVED BY: Chris Zhong 2018/11/29

### 3.0 APPLICABLE DOCUMENTS

DOCUMENT	NUMBER	DESCRIPTION
Sale Drawing(SD)	SD-2111400100	Mechanical Dimension of the product
Product Specification (PS)	PS-2111400100	Product Specification
Packing Drawing(PK)	PK-2111400100	Product packaging specifications

### 4.0 ANTENNA PERFORMANCE

#### 4.1 RF TEST CONDITIONS

All measurements are done of the antenna mounted on a PC/ABS material block of 1.5mm thickness with VNA Agilent 5071C and Over-The-Air (OTA) chamber. All measurements in this document are done with the part no.2111400100 with a cable length of 100mm.

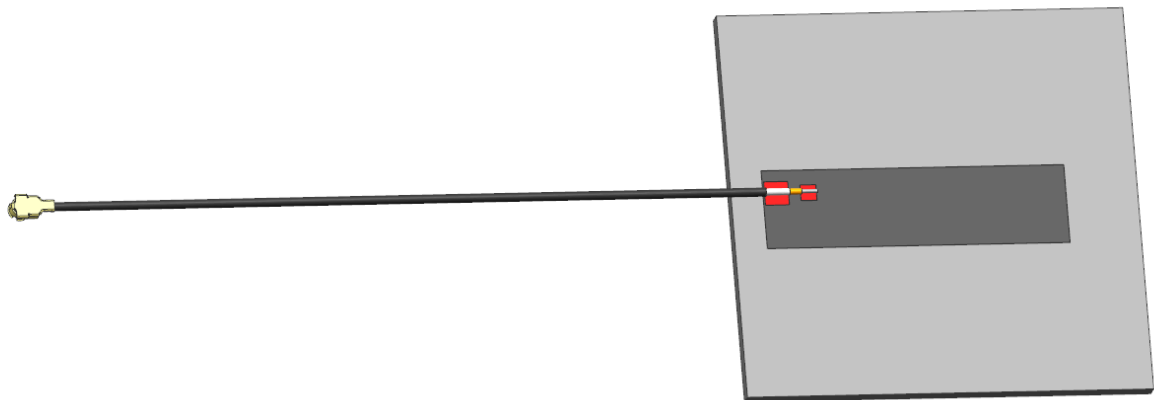

**FIGURE4.1.1 ANTENNA LOADED WITH PC/ABS BLOCK OF 1.5 MM THICKNESS**

REVISION: <b>A</b>	ECR/ECN INFORMATION: EC No: 608264 DATE: 2018/12/03	TITLE: <b>868/915MHz Flexible Antenna Application Specification</b>	SHEET No. <b>3 of 20</b>
DOCUMENT NUMBER: <b>AS-2111400100</b>	CREATED / REVISED BY: Liu Hai 2018/11/29	CHECKED BY: Cheng Kang 2018/11/29	APPROVED BY: Chris Zhong 2018/11/29

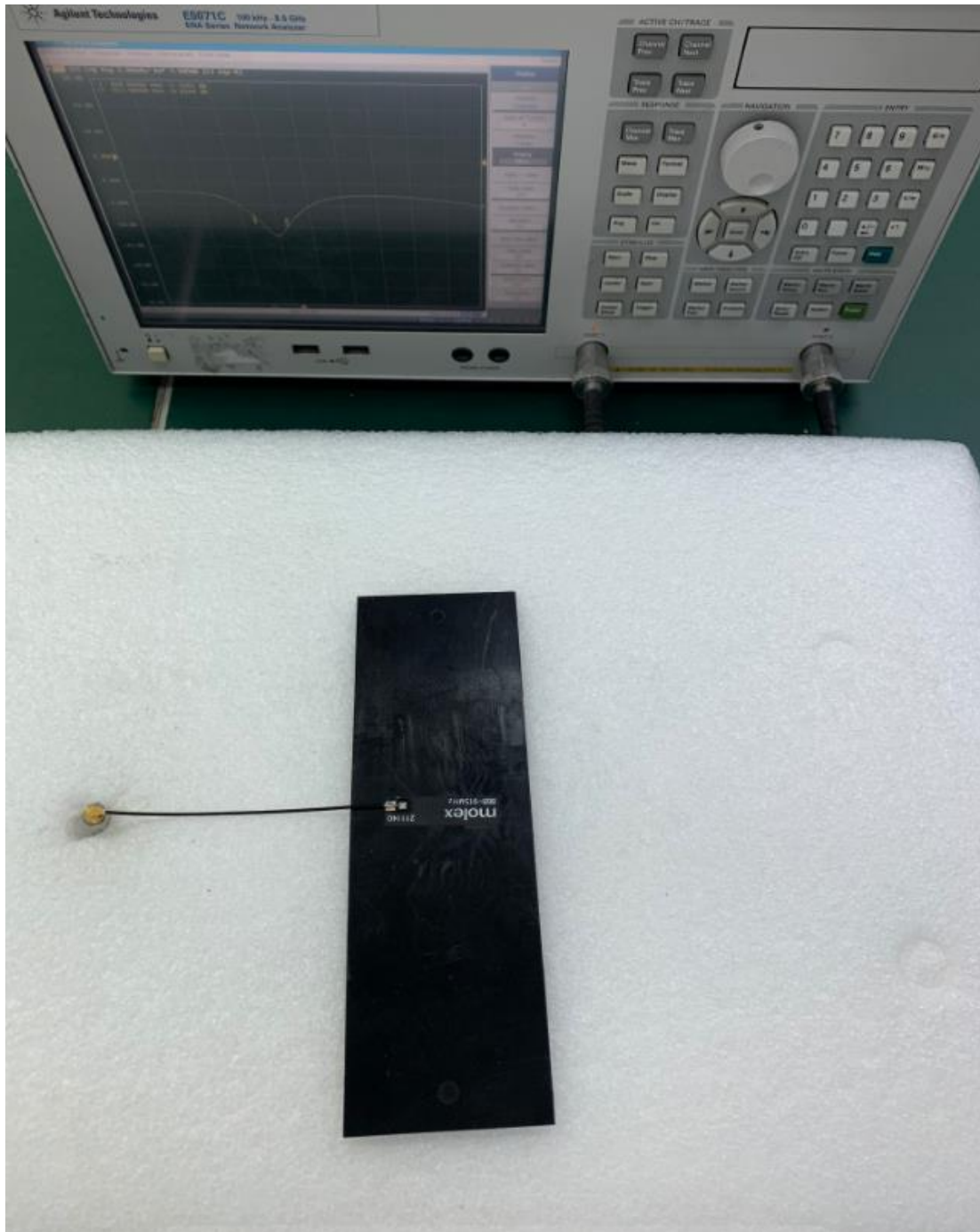

**FIGURE 4.1.2 ANTENNA LOADED WITH PC/ABS BLOCK OF 1.5 MM THICKNESS WITH VNA**

REVISION:  <b>A</b>	ECR/ECN INFORMATION: EC No: 608264 DATE: 2018/12/03	TITLE:  <b>868/915MHz Flexible Antenna Application Specification</b>	SHEET No.  <b>4 of 20</b>
DOCUMENT NUMBER: <b>AS-2111400100</b>	CREATED / REVISED BY: Liu Hai 2018/11/29	CHECKED BY: Cheng Kang 2018/11/29	APPROVED BY: Chris Zhong 2018/11/29



**FIGURE4.1.3 ANTENNA LOADED WITH PC/ABS BLOCK OF 1.5 MM THICKNESS WITH OTA CHAMBER**

<u>REVISION:</u>  <b>A</b>	<u>ECR/ECN INFORMATION:</u> <u>EC No:</u> 608264 <u>DATE:</u> 2018/12/03	<u>TITLE:</u>  <b>868/915MHz Flexible Antenna Application Specification</b>		<u>SHEET No.</u>  <b>5 of 20</b>
<u>DOCUMENT NUMBER:</u> <b>AS-2111400100</b>		<u>CREATED / REVISED BY:</u> Liu Hai 2018/11/29	<u>CHECKED BY:</u> Cheng Kang 2018/11/29	<u>APPROVED BY:</u> Chris Zhong 2018/11/29



# APPLICATION SPECIFICATION

## 4.2 ANTENNA PERFORMANCE

DESCRIPTION	EQUIPMENT	REQUIREMENT	
Frequency Range	VNA E5071C	868-870MHz	902-928MHz
Return Loss	VNA E5071C	<- 5dB	
Peak Gain (Max)	OTA Chamber	0.3dBi	1.0dBi
Average Total Efficiency	OTA Chamber	>55%	>60%
Polarization	OTA Chamber	Linear	
Input Impedance	VNA E5071C	50 ohms	

Note that the above antenna performance is measured with just the antenna mounted on a PC/ABS block to similar a free-space condition. When implement into the system, the frequency resonant might be off-tune due to the loading of surrounding components especially metal plane. This off-tune can be compensated through matching. Although module manufacturers specify a peak gain limit, it is based on free-space conditions. The peak gain will be degraded by 1 to 2dBi in the actual implementation as the radiation pattern will change due to the surround components. As such, during selection of antenna, you can select one with high peak gain to compensate for the loss. Molex can offer assistant to choose the best location and best tuning in-order to meet this peak gain requirement.

REVISION: <b>A</b>	ECR/ECN INFORMATION: EC No: 608264 DATE: 2018/12/03	TITLE: <b>868/915MHz Flexible Antenna Application Specification</b>	SHEET No. <b>6 of 20</b>
DOCUMENT NUMBER: <b>AS-2111400100</b>	CREATED / REVISED BY: Liu Hai 2018/11/29	CHECKED BY: Cheng Kang 2018/11/29	APPROVED BY: Chris Zhong 2018/11/29

## 4.3 RETURN LOSS PLOT

All measurements in this document are done with a cable length of 100mm.

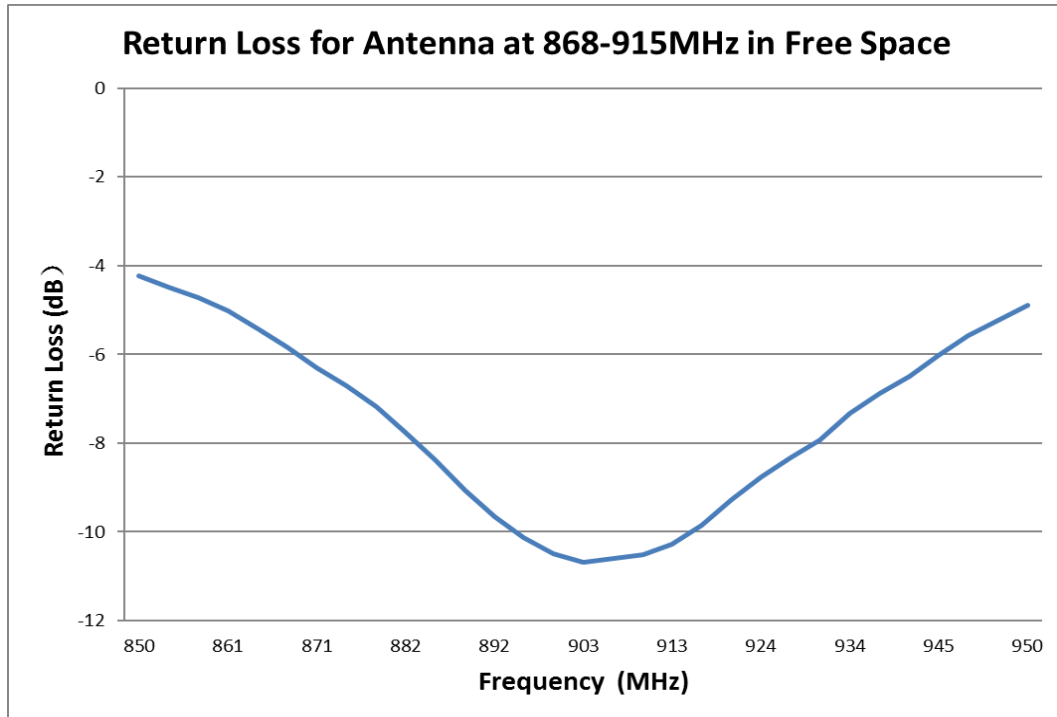

**FIGURE 4.3.1 RETURN LOSS OF ANTENNA AT 868/915MHZ IN FREE SPACE**

REVISION: <b>A</b>	ECR/ECN INFORMATION: EC No: 608264 DATE: 2018/12/03	TITLE: <b>868/915MHz Flexible Antenna Application Specification</b>	SHEET No. <b>7 of 20</b>
DOCUMENT NUMBER: <b>AS-2111400100</b>	CREATED / REVISED BY: Liu Hai 2018/11/29	CHECKED BY: Cheng Kang 2018/11/29	APPROVED BY: Chris Zhong 2018/11/29



## 4.4 EFFICIENCY PLOT

All measurements in this document are done with a cable length of 100mm.

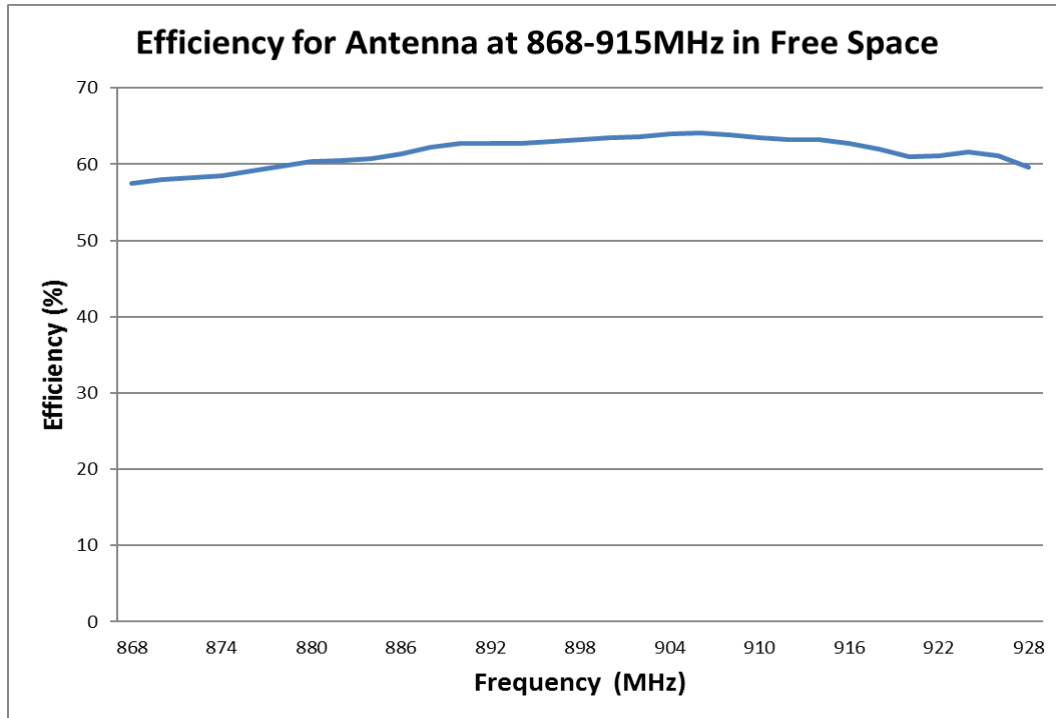
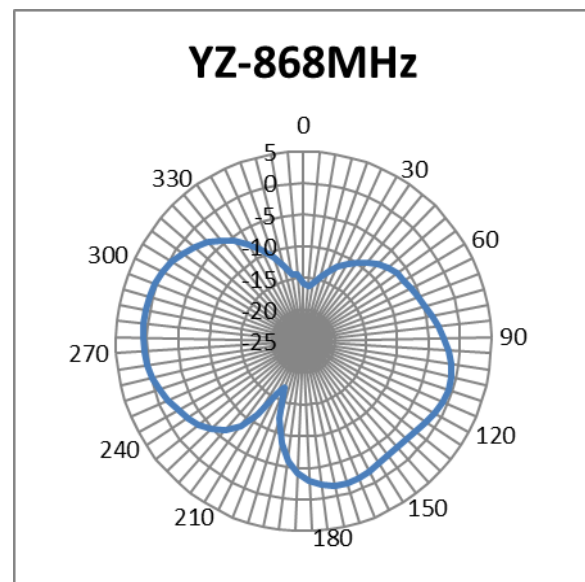
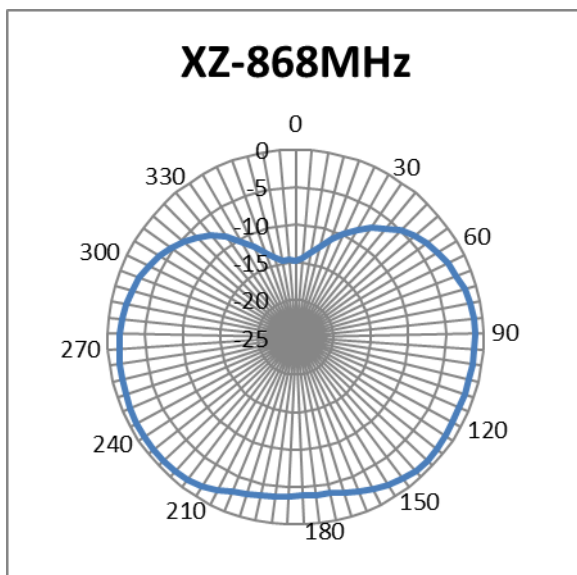
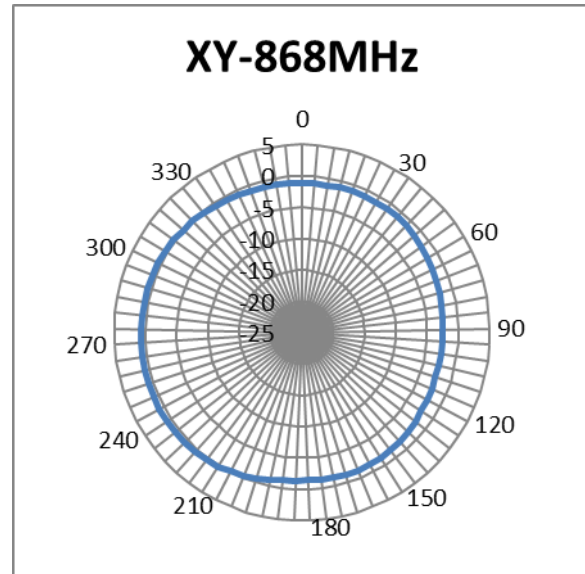
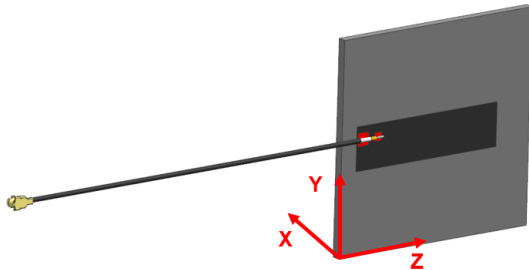

**FIGURE 4.4.1 EFFICIENCY OF ANTENNA AT 868/915MHZ IN FREE SPACE**

<u>REVISION:</u>  <b>A</b>	<u>ECR/ECN INFORMATION:</u> <u>EC No:</u> 608264 <u>DATE:</u> 2018/12/03	<u>TITLE:</u>  <b>868/915MHz Flexible Antenna Application Specification</b>		<u>SHEET No.</u>  <b>8 of 20</b>
<u>DOCUMENT NUMBER:</u> <b>AS-2111400100</b>		<u>CREATED / REVISED BY:</u> Liu Hai 2018/11/29	<u>CHECKED BY:</u> Cheng Kang 2018/11/29	<u>APPROVED BY:</u> Chris Zhong 2018/11/29

## 4.5 RADIATION PATTERN

All measurements in this document are done with a cable length of 100mm.



**FIGURE 4.5.1 2D RADIATION PATTERN OF ANTENNA AT 868MHz IN FREE SPACE**

REVISION: <b>A</b>	ECR/ECN INFORMATION: EC No: 608264 DATE: 2018/12/03	TITLE: <b>868/915MHz Flexible Antenna Application Specification</b>	SHEET No. <b>9 of 20</b>
DOCUMENT NUMBER: <b>AS-2111400100</b>	CREATED / REVISED BY: Liu Hai 2018/11/29	CHECKED BY: Cheng Kang 2018/11/29	APPROVED BY: Chris Zhong 2018/11/29

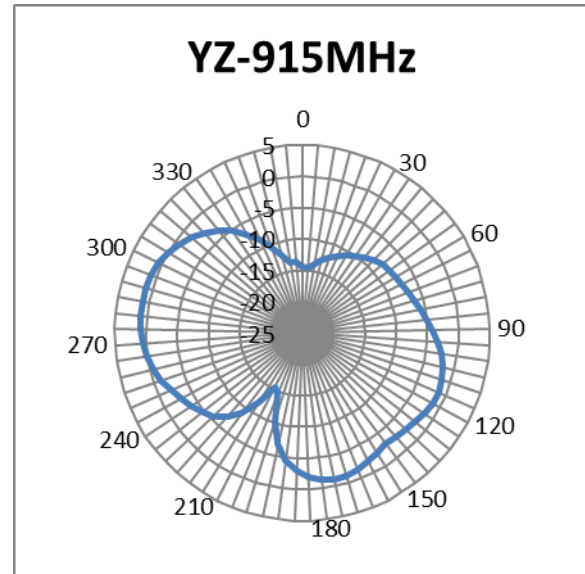
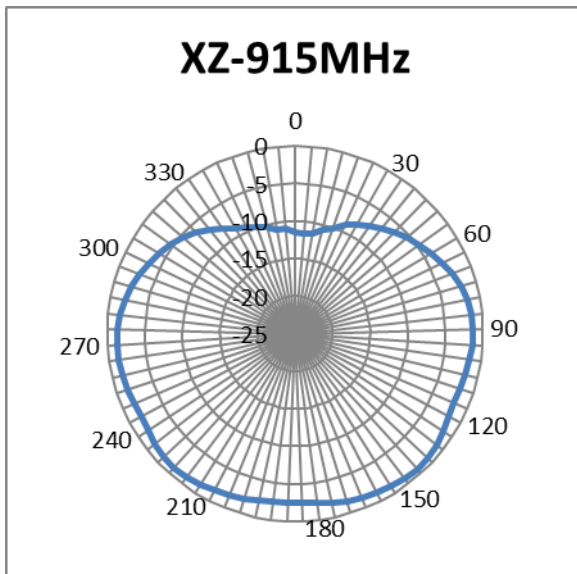
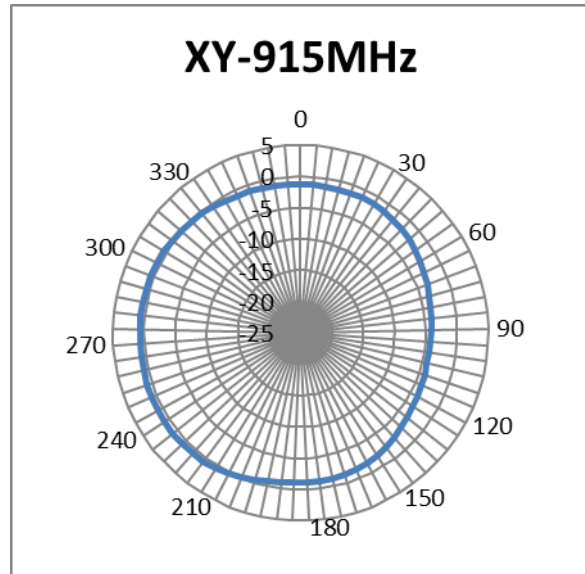
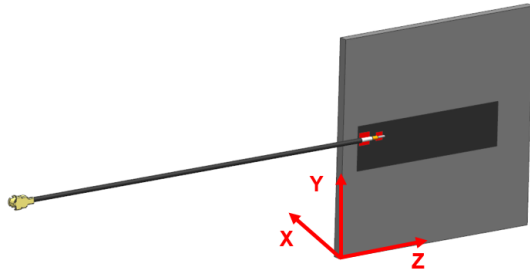

**FIGURE 4.5.2 2D RADIATION PATTERN OF ANTENNA AT 915MHZ IN FREE SPACE**

REVISION: <b>A</b>	ECR/ECN INFORMATION: EC No: 608264 DATE: 2018/12/03	TITLE: <b>868/915MHz Flexible Antenna Application Specification</b>	SHEET No. <b>10 of 20</b>
DOCUMENT NUMBER: <b>AS-2111400100</b>	CREATED / REVISED BY: Liu Hai 2018/11/29	CHECKED BY: Cheng Kang 2018/11/29	APPROVED BY: Chris Zhong 2018/11/29

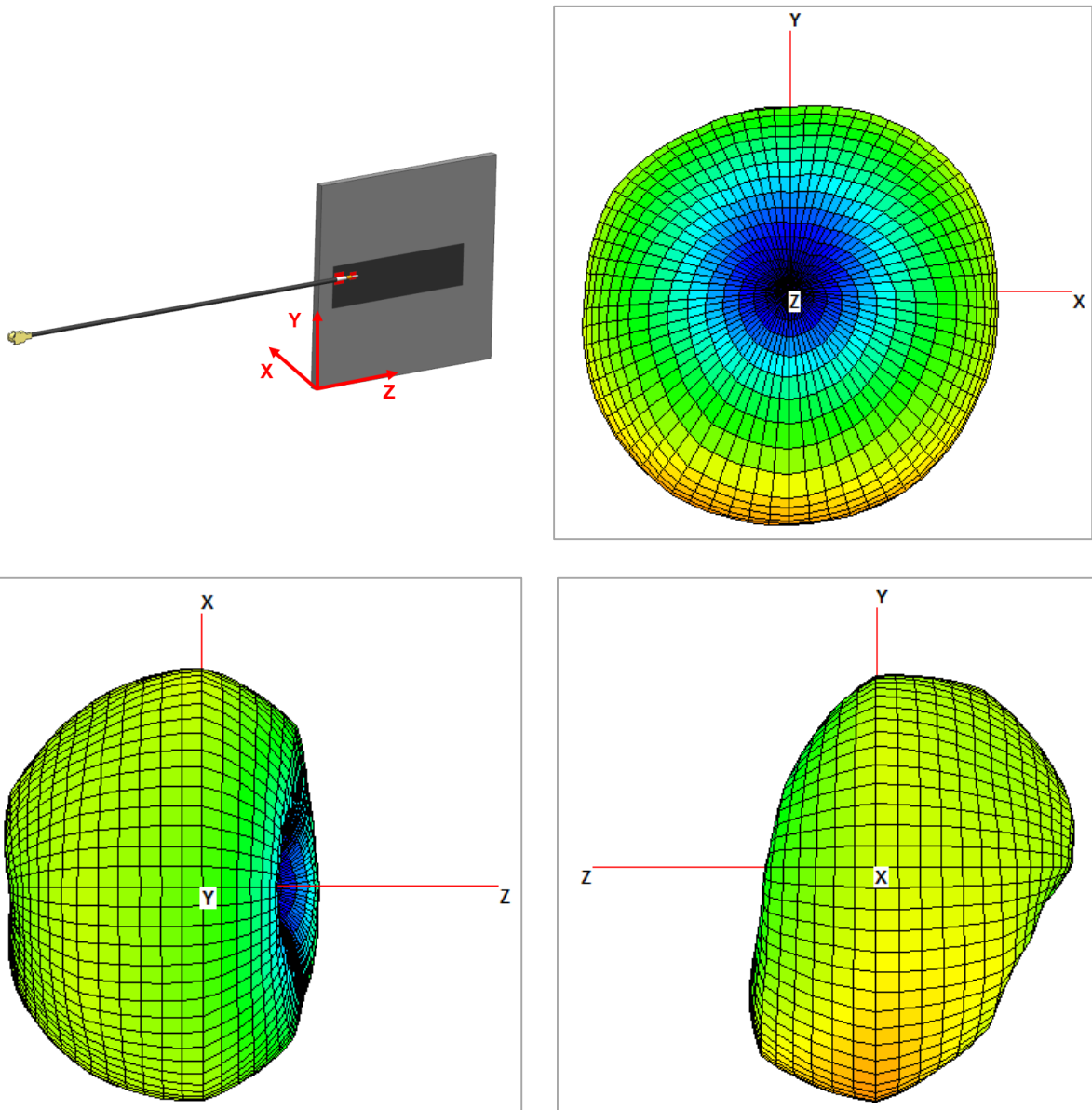

**FIGURE 4.5.3 3D RADIATION PATTERN OF ANTENNA AT 868MHZ IN FREE SPACE**

REVISION:  <b>A</b>	ECR/ECN INFORMATION: EC No: 608264 DATE: 2018/12/03	TITLE:  <b>868/915MHz Flexible Antenna Application Specification</b>	SHEET No.  <b>11 of 20</b>
DOCUMENT NUMBER:  <b>AS-2111400100</b>	CREATED / REVISED BY: Liu Hai 2018/11/29	CHECKED BY: Cheng Kang 2018/11/29	APPROVED BY: Chris Zhong 2018/11/29

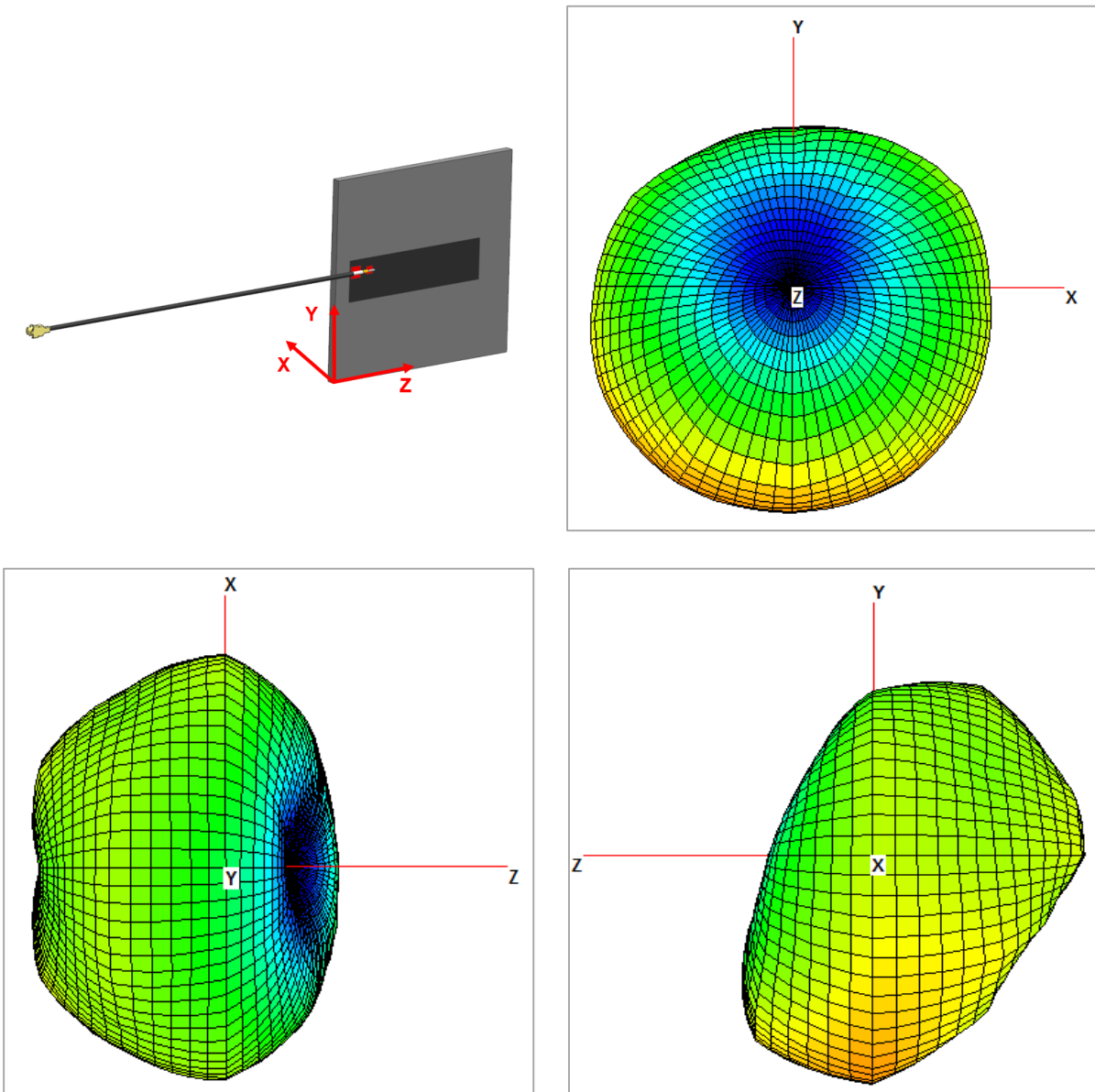

**FIGURE 4.5.4 3D RADIATION PATTERN OF ANTENNA AT 915MHZ IN FREE SPACE**

REVISION:  <b>A</b>	ECR/ECN INFORMATION: EC No: 608264 DATE: 2018/12/03	TITLE:  <b>868/915MHz Flexible Antenna Application Specification</b>	SHEET No.  <b>12 of 20</b>
DOCUMENT NUMBER:  <b>AS-2111400100</b>	CREATED / REVISED BY: Liu Hai 2018/11/29	CHECKED BY: Cheng Kang 2018/11/29	APPROVED BY: Chris Zhong 2018/11/29

## 5.0 ASSEMBLY GUIDELINE

The flex antenna comes with an adhesive 3m9077 for assemble onto the plastic wall of the system. The surface should be smooth with  $ra < 1.6\mu m$  and need to clean the surface before sticking this product. The antenna cannot be placed on a metallic surface.

### 5.1 HOW TO TEAR FLEX RELEASE PAPER



1. Find cut line on flex back side



2. Bend flex slight along cut line

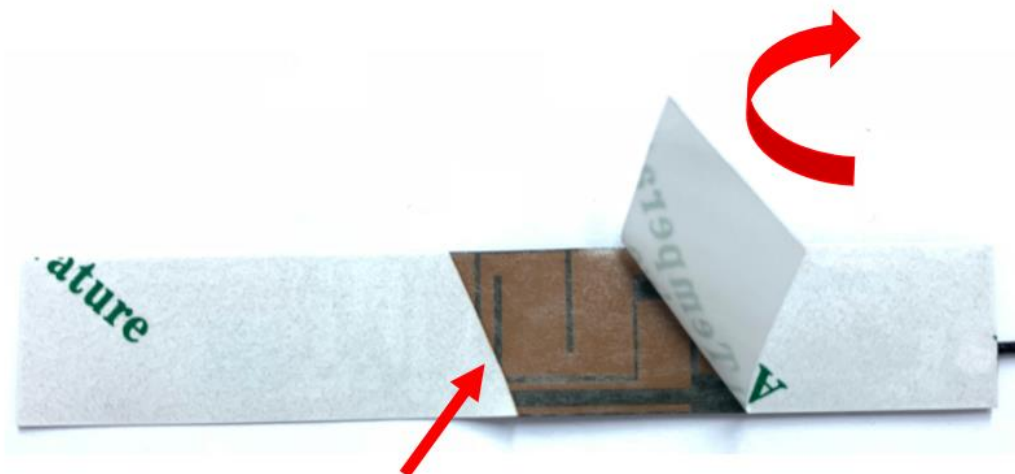

3. Tear release paper

REVISION: <b>A</b>	ECR/ECN INFORMATION: EC No: 608264 DATE: 2018/12/03	TITLE: <b>868/915MHz Flexible Antenna Application Specification</b>	SHEET No. <b>13 of 20</b>
DOCUMENT NUMBER: <b>AS-2111400100</b>	CREATED / REVISED BY: Liu Hai 2018/11/29	CHECKED BY: Cheng Kang 2018/11/29	APPROVED BY: Chris Zhong 2018/11/29

## 5.2 CABLE BENDING

During the assembly of the antenna in a device, the cable needs to be positioned away from the antenna flex to achieve best performance. The cable must be away from the Flex edge at least 5mm as shown in figure 5.2.1. If the cable bends into the antenna flex, the antenna performance will be degraded.



FIGURE 5.2.1 CABLE BENDING

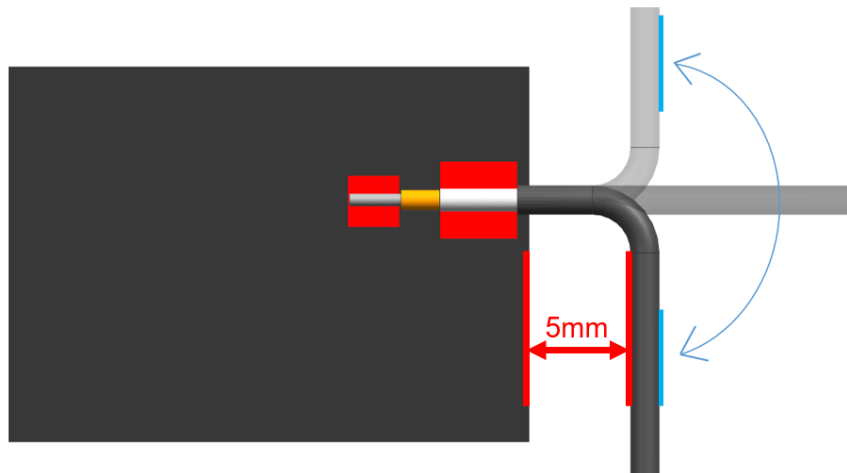

FIGURE 5.2.2 CABLE ACTIVITY RANGE

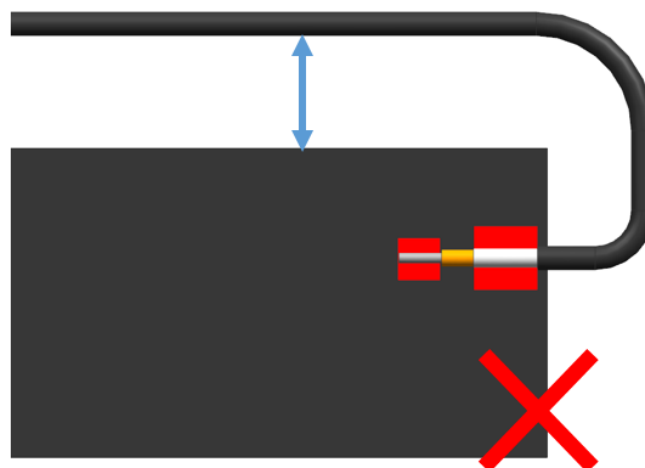

FIGURE 5.2.3 CABLE BENDING

REVISION: <b>A</b>	ECR/ECN INFORMATION: EC No: 608264 DATE: 2018/12/03	TITLE: <b>868/915MHz Flexible Antenna Application Specification</b>	SHEET No. <b>14 of 20</b>
DOCUMENT NUMBER: <b>AS-2111400100</b>	CREATED / REVISED BY: Liu Hai 2018/11/29	CHECKED BY: Cheng Kang 2018/11/29	APPROVED BY: Chris Zhong 2018/11/29

## 6.0 RF PERFORMANCE AS A FUNCTION OF IMPLEMENTATION

### 6.1 ANTENNA RF PERFORMANCE AS A FUNCTION OF DIFFERENT LOCATIONS WITH PARALLEL PLANE GROUND

Four locations with parallel plane ground have been evaluated and these locations are shown in figure 6.1.1. The plane ground size is 90mm\*90mm and we move the plane ground to four locations for each test. The antenna performance is better with larger distance between antenna and parallel plane ground. The minimum distance between antenna and plane ground is recommended to be 5mm to achieve acceptable RF performance.

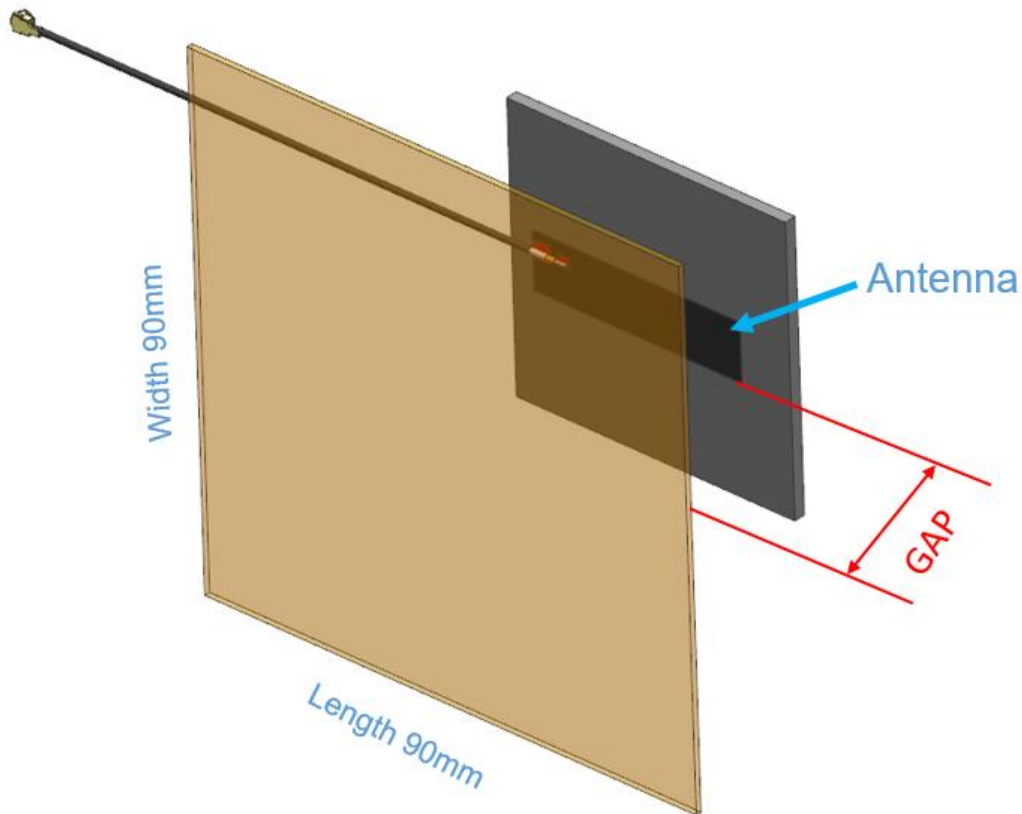

**FIGURE 6.1.1 FOUR LOCATIONS WITH PARALLEL PLANE GROUND**

Ground Size: 90mm\*90mm;

- Location 1: Distance between antenna and plane (GAP) ground is about 5mm;
- Location 2: Distance between antenna and plane (GAP) ground is about 10mm;
- Location 3: Distance between antenna and plane (GAP) ground is about 15mm;
- Location 4: Distance between antenna and plane (GAP) ground is about 20mm.

REVISION: <b>A</b>	ECR/ECN INFORMATION: EC No: 608264 DATE: 2018/12/03	TITLE: <b>868/915MHz Flexible Antenna Application Specification</b>	SHEET No. <b>15 of 20</b>
DOCUMENT NUMBER: <b>AS-2111400100</b>	CREATED / REVISED BY: Liu Hai 2018/11/29	CHECKED BY: Cheng Kang 2018/11/29	APPROVED BY: Chris Zhong 2018/11/29



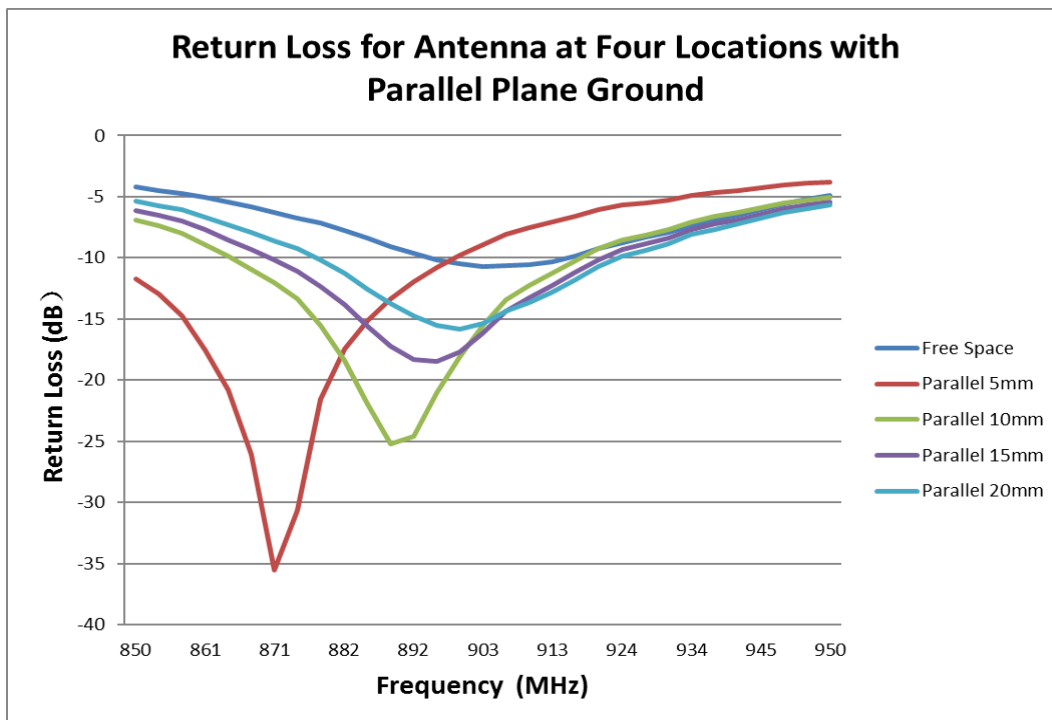

**FIGURE 6.1.2 RETURN LOSS OF ANTENNA AT 868/915MHZ AT FOUR LOCATIONS WITH PARALLEL PLANE GROUND**

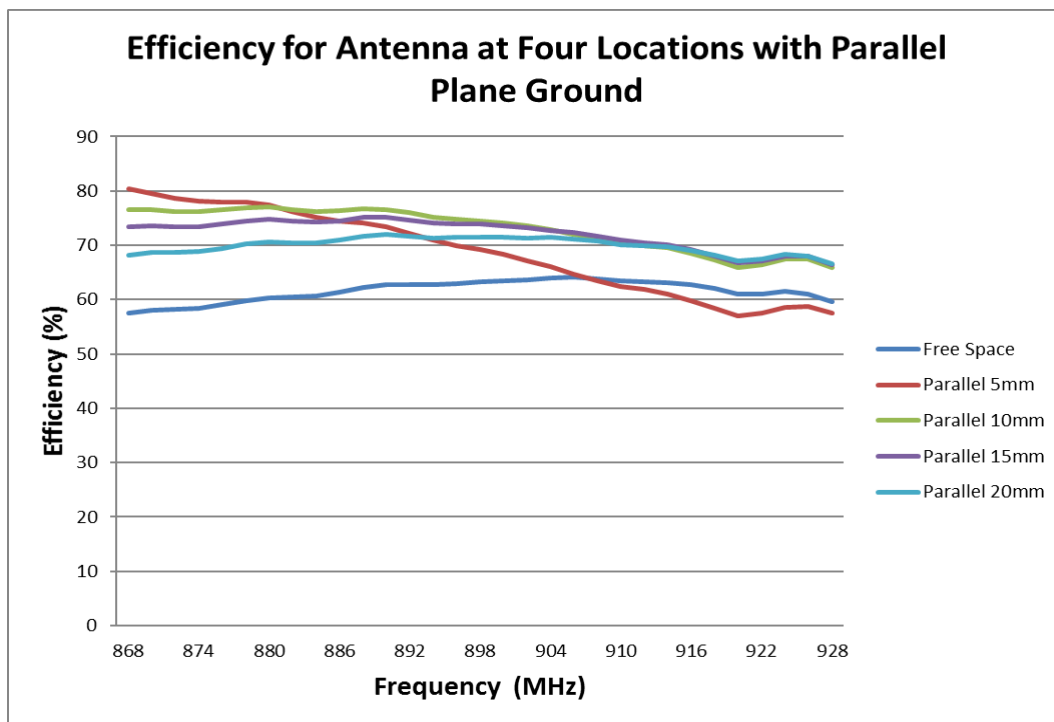
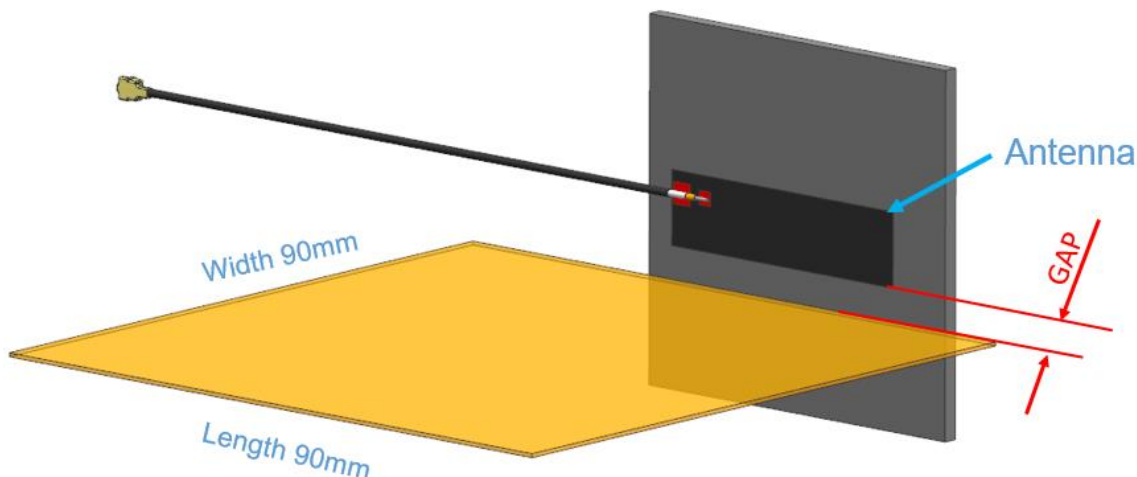

**FIGURE 6.1.3 EFFICIENCY OF ANTENNA AT 868/915MHZ AT FOUR LOCATIONS WITH PARALLEL PLANE GROUND**

REVISION: <b>A</b>	ECR/ECN INFORMATION: EC No: 608264 DATE: 2018/12/03	TITLE: <b>868/915MHz Flexible Antenna Application Specification</b>	SHEET No. <b>16 of 20</b>
DOCUMENT NUMBER: <b>AS-2111400100</b>	CREATED / REVISED BY: Liu Hai 2018/11/29	CHECKED BY: Cheng Kang 2018/11/29	APPROVED BY: Chris Zhong 2018/11/29

## 6.2 ANTENNA RF PERFORMANCE AS A FUNCTION OF DIFFERENT LOCATIONS WITH VERTICAL PLANE GROUND

Four locations with vertical plane ground have been evaluated and these locations are shown in figure 6.2.1. The plane ground size is 90mm\*90mm and we move the plane ground to four locations for each test. The antenna performance is better with larger distance between antenna and vertical plane ground. The minimum distance between antenna and plane ground is recommended to be 5mm to achieve acceptable RF performance.

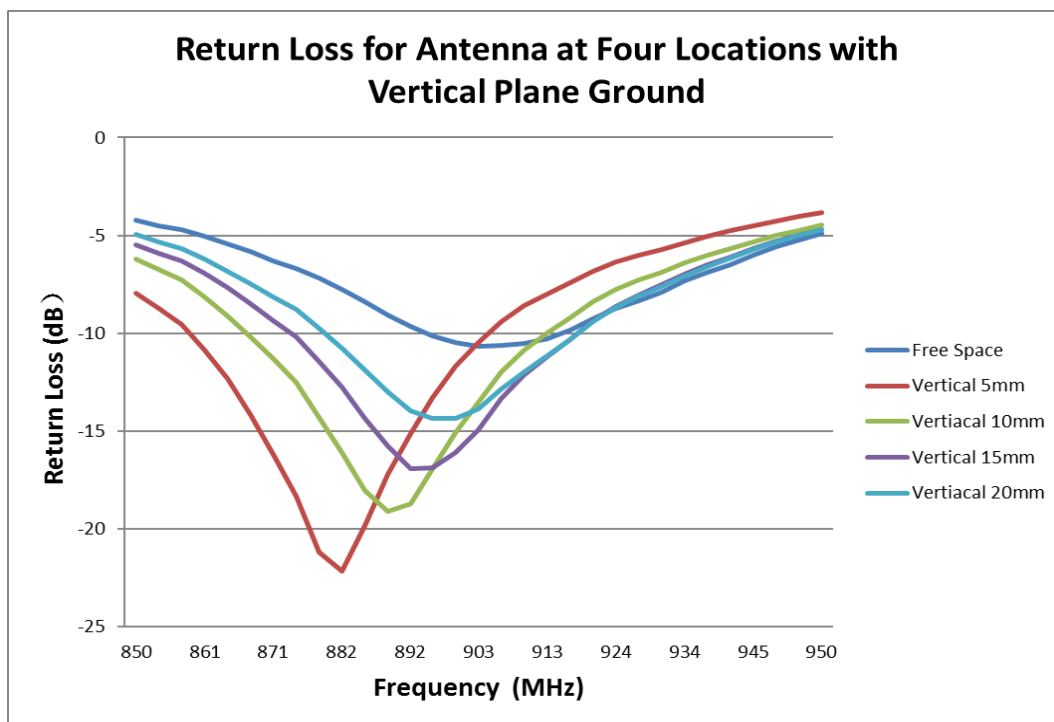

**FIGURE 6.2.1 FOUR LOCATIONS WITH VERTICAL PLANE GROUND**

Ground Size: 90mm\*90mm;

- Location 1: Distance between antenna and plane (GAP) ground is about 5mm;
- Location 2: Distance between antenna and plane (GAP) ground is about 10mm;
- Location 3: Distance between antenna and plane (GAP) ground is about 15mm;
- Location 4: Distance between antenna and plane (GAP) ground is about 20mm.

REVISION: <b>A</b>	ECR/ECN INFORMATION: EC No: 608264 DATE: 2018/12/03	TITLE: <b>868/915MHz Flexible Antenna Application Specification</b>	SHEET No. <b>17 of 20</b>
DOCUMENT NUMBER: <b>AS-2111400100</b>	CREATED / REVISED BY: Liu Hai 2018/11/29	CHECKED BY: Cheng Kang 2018/11/29	APPROVED BY: Chris Zhong 2018/11/29



**FIGURE 6.2.2 RETURN LOSS OF ANTENNA AT 868/915MHZ AT FOUR LOCATIONS WITH VERTICAL PLANE GROUND**

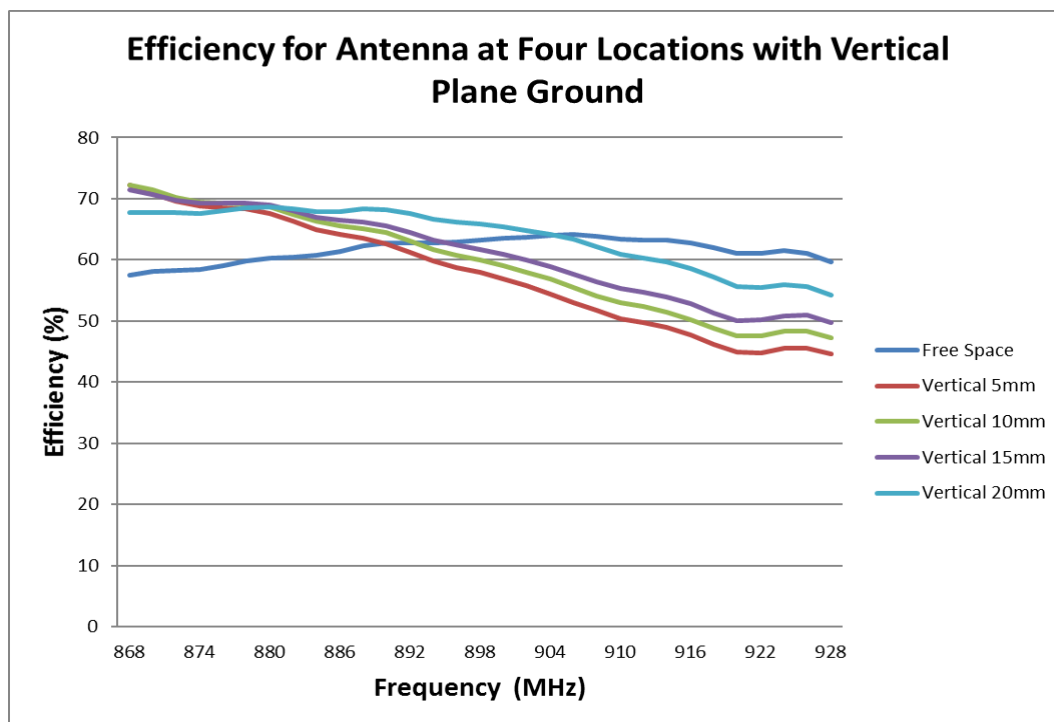
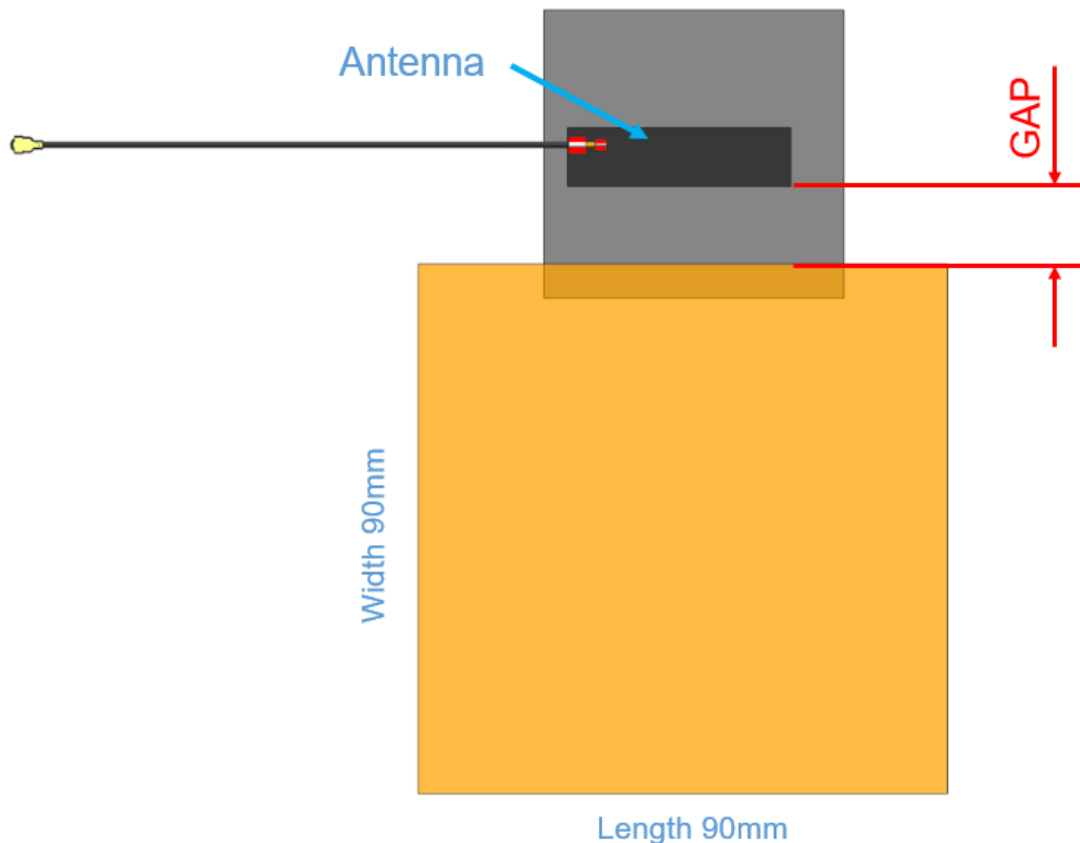

**FIGURE 6.2.3 EFFICIENCY OF ANTENNA AT 868/915MHZ AT FOUR LOCATIONS WITH VERTICAL PLANE GROUND**

REVISION: <b>A</b>	ECR/ECN INFORMATION: EC No: 608264 DATE: 2018/12/03	TITLE: <b>868/915MHz Flexible Antenna Application Specification</b>	SHEET No. <b>18 of 20</b>
DOCUMENT NUMBER: <b>AS-2111400100</b>	CREATED / REVISED BY: Liu Hai 2018/11/29	CHECKED BY: Cheng Kang 2018/11/29	APPROVED BY: Chris Zhong 2018/11/29

## 6.3 ANTENNA RF PERFORMANCE AS A FUNCTION OF DIFFERENT DISTANCES WITH PARALLEL PLANE GROUND

Four locations with the parallel plane ground have been evaluated and these locations are shown in figure 6.3.1. The plane ground size is 90mm\*90mm and we move the plane ground to four locations for each test. The antenna performance is better with larger distance between the antenna and the parallel plane ground. The minimum distance between the antenna and the plane ground is recommended to be 5mm to achieve acceptable RF performance.

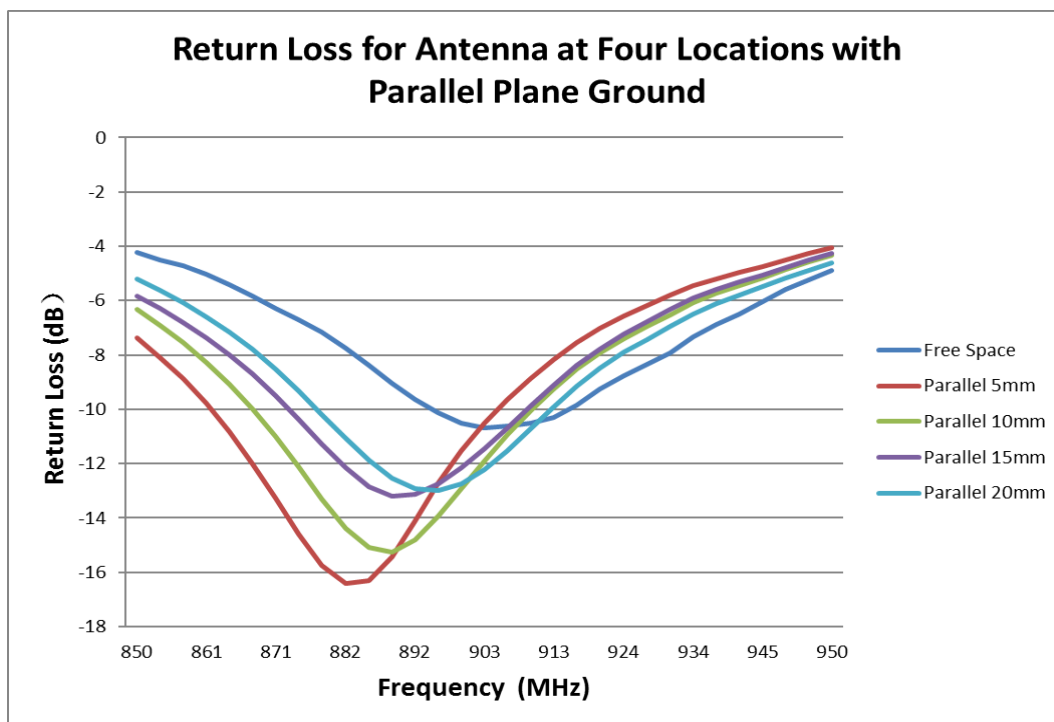

**FIGURE 6.3.1 FOUR LOCATIONS WITH PARALLEL PLANE GROUND**

Ground Size: 90mm\*90mm;

- Location 1: Distance between antenna and plane (GAP) ground is about 5mm;
- Location 2: Distance between antenna and plane (GAP) ground is about 10mm;
- Location 3: Distance between antenna and plane (GAP) ground is about 15mm;
- Location 4: Distance between antenna and plane (GAP) ground is about 20mm.

REVISION: <b>A</b>	ECR/ECN INFORMATION: EC No: 608264 DATE: 2018/12/03	TITLE: <b>868/915MHz Flexible Antenna Application Specification</b>	SHEET No. <b>19 of 20</b>
DOCUMENT NUMBER: <b>AS-2111400100</b>	CREATED / REVISED BY: Liu Hai 2018/11/29	CHECKED BY: Cheng Kang 2018/11/29	APPROVED BY: Chris Zhong 2018/11/29



**FIGURE 6.3.2 RETURN LOSS OF ANTENNA AT 868/915MHZ AT FOUR LOCATIONS WITH PARALLEL PLANE GROUND**

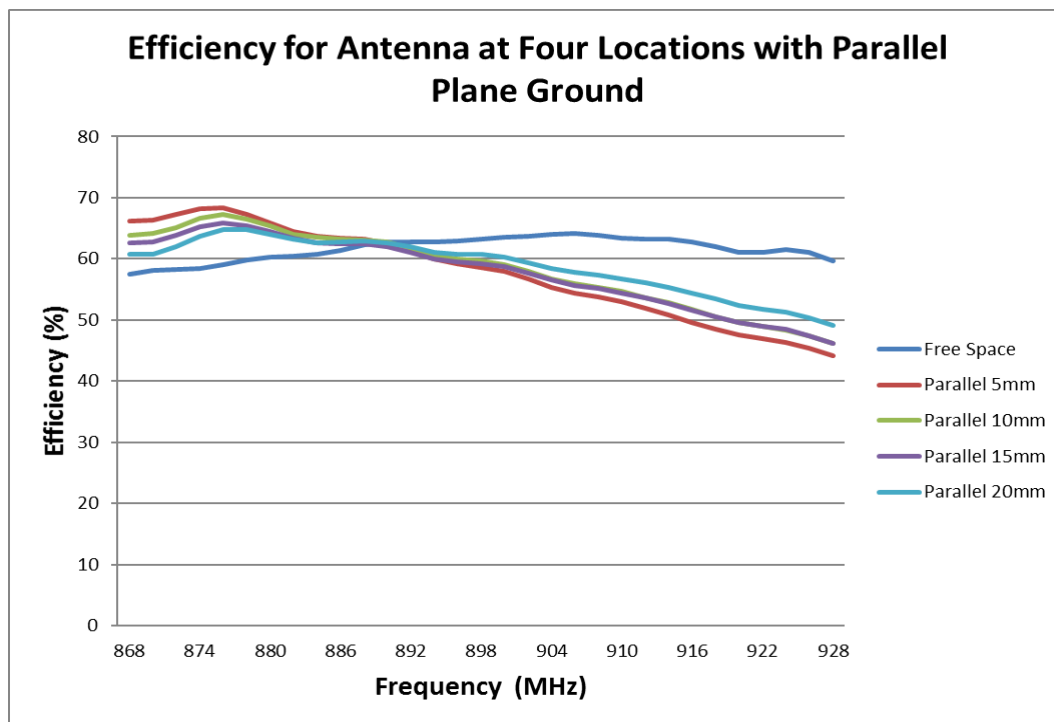

**FIGURE 6.3.3 EFFICIENCY OF ANTENNA AT 868/915MHZ AT FOUR LOCATIONS WITH PARALLEL PLANE GROUND**

REVISION: <b>A</b>	ECR/ECN INFORMATION: EC No: 608264 DATE: 2018/12/03	TITLE: <b>868/915MHz Flexible Antenna Application Specification</b>	SHEET No. <b>20 of 20</b>
DOCUMENT NUMBER: <b>AS-2111400100</b>	CREATED / REVISED BY: Liu Hai 2018/11/29	CHECKED BY: Cheng Kang 2018/11/29	APPROVED BY: Chris Zhong 2018/11/29