

CH78
Hopping mode

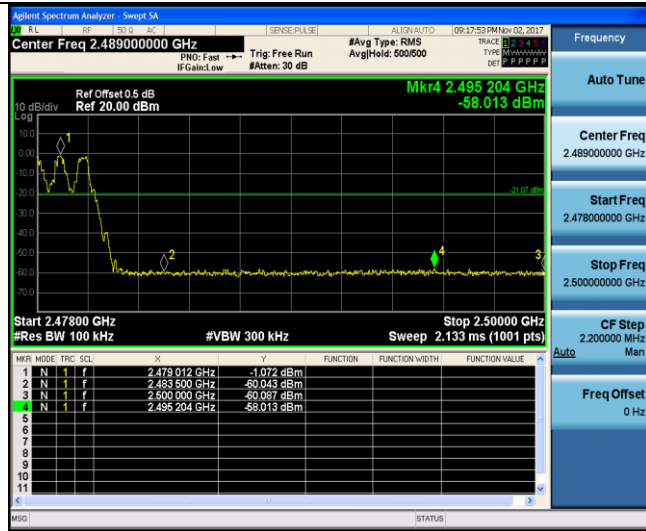

Test Item:	Band edge	Modulation type:	$\pi/4$ DQPSK
<p>CH00</p> <p>No hopping mode</p>		<p>Center Freq 2.357500000 GHz</p> <p>Start Freq 2.310000000 GHz</p> <p>Stop Freq 2.405000000 GHz</p> <p>CF Step 9.500000 MHz</p> <p>Freq Offset 0 Hz</p>	<p>Frequency</p> <p>Auto Tune</p> <p>Center Freq 2.357500000 GHz</p> <p>Start Freq 2.310000000 GHz</p> <p>Stop Freq 2.405000000 GHz</p> <p>CF Step 9.500000 MHz</p> <p>Freq Offset 0 Hz</p>
<p>CH00</p> <p>Hopping mode</p>		<p>Center Freq 2.357500000 GHz</p> <p>Start Freq 2.310000000 GHz</p> <p>Stop Freq 2.405000000 GHz</p> <p>CF Step 9.500000 MHz</p> <p>Freq Offset 0 Hz</p>	<p>Frequency</p> <p>Auto Tune</p> <p>Center Freq 2.357500000 GHz</p> <p>Start Freq 2.310000000 GHz</p> <p>Stop Freq 2.405000000 GHz</p> <p>CF Step 9.500000 MHz</p> <p>Freq Offset 0 Hz</p>
<p>CH78</p> <p>No hopping mode</p>		<p>Center Freq 2.489000000 GHz</p> <p>Start Freq 2.478000000 GHz</p> <p>Stop Freq 2.500000000 GHz</p> <p>CF Step 2.200000 MHz</p> <p>Freq Offset 0 Hz</p>	<p>Frequency</p> <p>Auto Tune</p> <p>Center Freq 2.489000000 GHz</p> <p>Start Freq 2.478000000 GHz</p> <p>Stop Freq 2.500000000 GHz</p> <p>CF Step 2.200000 MHz</p> <p>Freq Offset 0 Hz</p>

CH78
Hopping mode

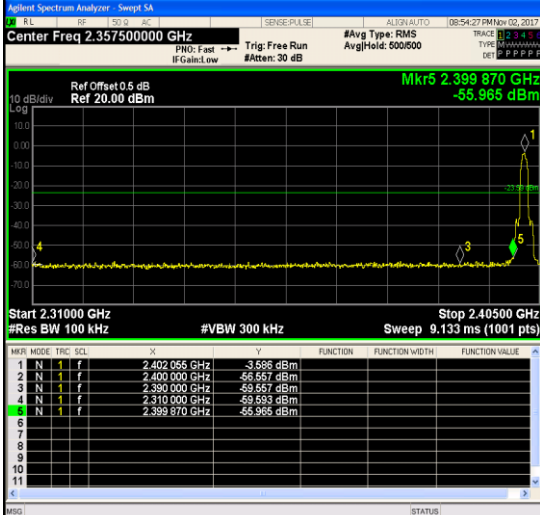
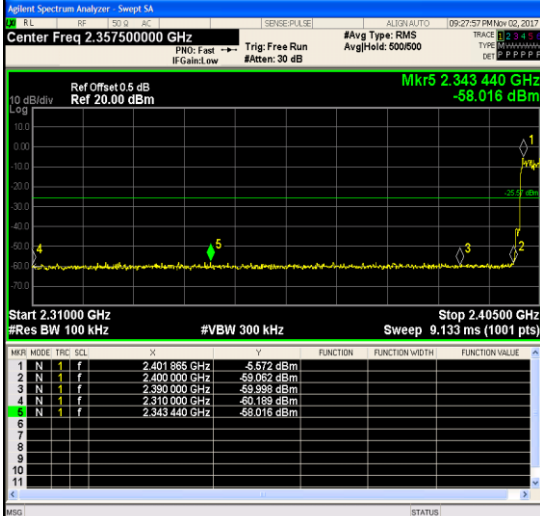
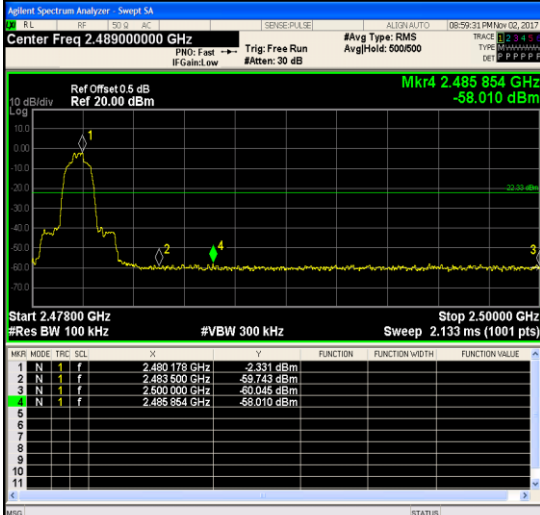
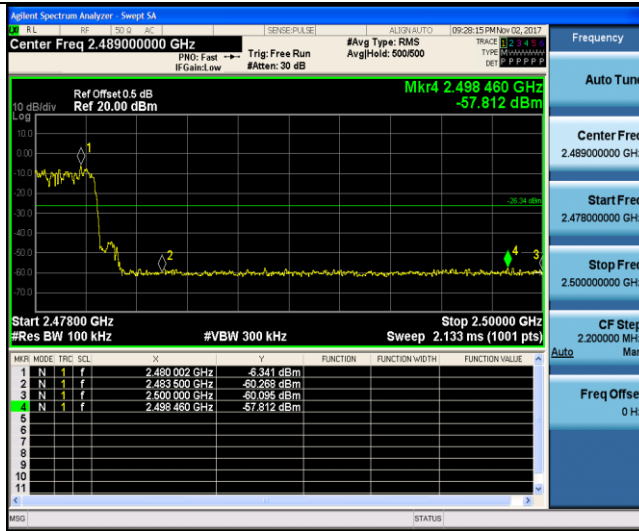

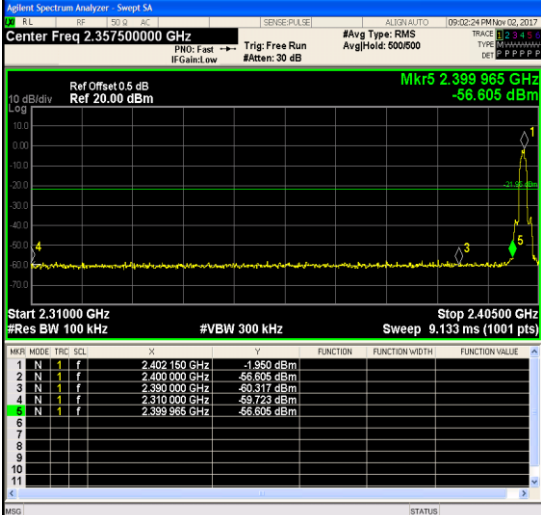
Test Item:	Band edge	Modulation type:	8DPSK																																																
<p>CH00</p> <p>No hopping mode</p>	 <table border="1" data-bbox="687 571 1230 728"> <thead> <tr> <th>MNR</th> <th>MODE</th> <th>TRC</th> <th>SCL</th> <th>F</th> <th>FUNCTION</th> <th>FUNCTION WIDTH</th> <th>FUNCTION VALUE</th> </tr> </thead> <tbody> <tr> <td>1</td> <td>N</td> <td>1</td> <td>f</td> <td>2.402160 GHz</td> <td></td> <td></td> <td>-1.960 dBm</td> </tr> <tr> <td>2</td> <td>N</td> <td>1</td> <td>f</td> <td>2.400000 GHz</td> <td></td> <td></td> <td>-56.605 dBm</td> </tr> <tr> <td>3</td> <td>N</td> <td>1</td> <td>f</td> <td>2.390000 GHz</td> <td></td> <td></td> <td>-60.317 dBm</td> </tr> <tr> <td>4</td> <td>N</td> <td>1</td> <td>f</td> <td>2.310000 GHz</td> <td></td> <td></td> <td>-59.723 dBm</td> </tr> <tr> <td>5</td> <td>N</td> <td>1</td> <td>f</td> <td>2.399965 GHz</td> <td></td> <td></td> <td>-56.605 dBm</td> </tr> </tbody> </table>	MNR	MODE	TRC	SCL	F	FUNCTION	FUNCTION WIDTH	FUNCTION VALUE	1	N	1	f	2.402160 GHz			-1.960 dBm	2	N	1	f	2.400000 GHz			-56.605 dBm	3	N	1	f	2.390000 GHz			-60.317 dBm	4	N	1	f	2.310000 GHz			-59.723 dBm	5	N	1	f	2.399965 GHz			-56.605 dBm	<p>Center Freq 2.357500000 GHz</p> <p>Start Freq 2.310000000 GHz</p> <p>Stop Freq 2.405000000 GHz</p> <p>CF Step 9.500000 MHz</p> <p>Freq Offset 0 Hz</p>	<p>Agilent Spectrum Analyzer - Sweep SA</p> <p>Center Freq 2.357500000 GHz</p> <p>Ref Offset 0.5 dB</p> <p>Ref 20.00 dBm</p> <p>Mkr5 2.399 965 GHz</p> <p>-56.605 dBm</p> <p>Start 2.31000 GHz</p> <p>Stop 2.40500 GHz</p> <p>#Res BW 100 kHz</p> <p>#VBW 300 kHz</p> <p>Sweep 9.133 ms (1001 pts)</p> <p>Auto Tune</p> <p>Frequency</p> <p>Center Freq 2.357500000 GHz</p> <p>Start Freq 2.310000000 GHz</p> <p>Stop Freq 2.405000000 GHz</p> <p>CF Step 9.500000 MHz</p> <p>Freq Offset 0 Hz</p>
MNR	MODE	TRC	SCL	F	FUNCTION	FUNCTION WIDTH	FUNCTION VALUE																																												
1	N	1	f	2.402160 GHz			-1.960 dBm																																												
2	N	1	f	2.400000 GHz			-56.605 dBm																																												
3	N	1	f	2.390000 GHz			-60.317 dBm																																												
4	N	1	f	2.310000 GHz			-59.723 dBm																																												
5	N	1	f	2.399965 GHz			-56.605 dBm																																												
<p>CH00</p> <p>Hopping mode</p>	 <table border="1" data-bbox="687 1097 1230 1254"> <thead> <tr> <th>MNR</th> <th>MODE</th> <th>TRC</th> <th>SCL</th> <th>F</th> <th>FUNCTION</th> <th>FUNCTION WIDTH</th> <th>FUNCTION VALUE</th> </tr> </thead> <tbody> <tr> <td>1</td> <td>N</td> <td>1</td> <td>f</td> <td>2.403005 GHz</td> <td></td> <td></td> <td>-4.534 dBm</td> </tr> <tr> <td>2</td> <td>N</td> <td>1</td> <td>f</td> <td>2.400000 GHz</td> <td></td> <td></td> <td>-57.223 dBm</td> </tr> <tr> <td>3</td> <td>N</td> <td>1</td> <td>f</td> <td>2.390000 GHz</td> <td></td> <td></td> <td>-60.537 dBm</td> </tr> <tr> <td>4</td> <td>N</td> <td>1</td> <td>f</td> <td>2.310000 GHz</td> <td></td> <td></td> <td>-60.003 dBm</td> </tr> <tr> <td>5</td> <td>N</td> <td>1</td> <td>f</td> <td>2.399965 GHz</td> <td></td> <td></td> <td>-57.223 dBm</td> </tr> </tbody> </table>	MNR	MODE	TRC	SCL	F	FUNCTION	FUNCTION WIDTH	FUNCTION VALUE	1	N	1	f	2.403005 GHz			-4.534 dBm	2	N	1	f	2.400000 GHz			-57.223 dBm	3	N	1	f	2.390000 GHz			-60.537 dBm	4	N	1	f	2.310000 GHz			-60.003 dBm	5	N	1	f	2.399965 GHz			-57.223 dBm	<p>Center Freq 2.357500000 GHz</p> <p>Start Freq 2.310000000 GHz</p> <p>Stop Freq 2.405000000 GHz</p> <p>CF Step 9.500000 MHz</p> <p>Freq Offset 0 Hz</p>	<p>Agilent Spectrum Analyzer - Sweep SA</p> <p>Center Freq 2.357500000 GHz</p> <p>Ref Offset 0.5 dB</p> <p>Ref 20.00 dBm</p> <p>Mkr5 2.399 965 GHz</p> <p>-57.223 dBm</p> <p>Start 2.31000 GHz</p> <p>Stop 2.40500 GHz</p> <p>#Res BW 100 kHz</p> <p>#VBW 300 kHz</p> <p>Sweep 9.133 ms (1001 pts)</p> <p>Auto Tune</p> <p>Frequency</p> <p>Center Freq 2.357500000 GHz</p> <p>Start Freq 2.310000000 GHz</p> <p>Stop Freq 2.405000000 GHz</p> <p>CF Step 9.500000 MHz</p> <p>Freq Offset 0 Hz</p>
MNR	MODE	TRC	SCL	F	FUNCTION	FUNCTION WIDTH	FUNCTION VALUE																																												
1	N	1	f	2.403005 GHz			-4.534 dBm																																												
2	N	1	f	2.400000 GHz			-57.223 dBm																																												
3	N	1	f	2.390000 GHz			-60.537 dBm																																												
4	N	1	f	2.310000 GHz			-60.003 dBm																																												
5	N	1	f	2.399965 GHz			-57.223 dBm																																												
<p>CH78</p> <p>No hopping mode</p>	 <table border="1" data-bbox="687 1624 1230 1780"> <thead> <tr> <th>MNR</th> <th>MODE</th> <th>TRC</th> <th>SCL</th> <th>F</th> <th>FUNCTION</th> <th>FUNCTION WIDTH</th> <th>FUNCTION VALUE</th> </tr> </thead> <tbody> <tr> <td>1</td> <td>N</td> <td>1</td> <td>f</td> <td>2.490046 GHz</td> <td></td> <td></td> <td>-2.464 dBm</td> </tr> <tr> <td>2</td> <td>N</td> <td>1</td> <td>f</td> <td>2.483500 GHz</td> <td></td> <td></td> <td>-60.981 dBm</td> </tr> <tr> <td>3</td> <td>N</td> <td>1</td> <td>f</td> <td>2.500000 GHz</td> <td></td> <td></td> <td>-60.195 dBm</td> </tr> <tr> <td>4</td> <td>N</td> <td>1</td> <td>f</td> <td>2.491442 GHz</td> <td></td> <td></td> <td>-56.252 dBm</td> </tr> </tbody> </table>	MNR	MODE	TRC	SCL	F	FUNCTION	FUNCTION WIDTH	FUNCTION VALUE	1	N	1	f	2.490046 GHz			-2.464 dBm	2	N	1	f	2.483500 GHz			-60.981 dBm	3	N	1	f	2.500000 GHz			-60.195 dBm	4	N	1	f	2.491442 GHz			-56.252 dBm	<p>Center Freq 2.489000000 GHz</p> <p>Start Freq 2.478000000 GHz</p> <p>Stop Freq 2.500000000 GHz</p> <p>CF Step 2.200000 MHz</p> <p>Freq Offset 0 Hz</p>	<p>Agilent Spectrum Analyzer - Sweep SA</p> <p>Center Freq 2.489000000 GHz</p> <p>Ref Offset 0.5 dB</p> <p>Ref 20.00 dBm</p> <p>Mkr4 2.491 442 GHz</p> <p>-56.252 dBm</p> <p>Start 2.47800 GHz</p> <p>Stop 2.50000 GHz</p> <p>#Res BW 100 kHz</p> <p>#VBW 300 kHz</p> <p>Sweep 2.133 ms (1001 pts)</p> <p>Auto Tune</p> <p>Frequency</p> <p>Center Freq 2.489000000 GHz</p> <p>Start Freq 2.478000000 GHz</p> <p>Stop Freq 2.500000000 GHz</p> <p>CF Step 2.200000 MHz</p> <p>Freq Offset 0 Hz</p>								
MNR	MODE	TRC	SCL	F	FUNCTION	FUNCTION WIDTH	FUNCTION VALUE																																												
1	N	1	f	2.490046 GHz			-2.464 dBm																																												
2	N	1	f	2.483500 GHz			-60.981 dBm																																												
3	N	1	f	2.500000 GHz			-60.195 dBm																																												
4	N	1	f	2.491442 GHz			-56.252 dBm																																												

CH78
Hoppig mode

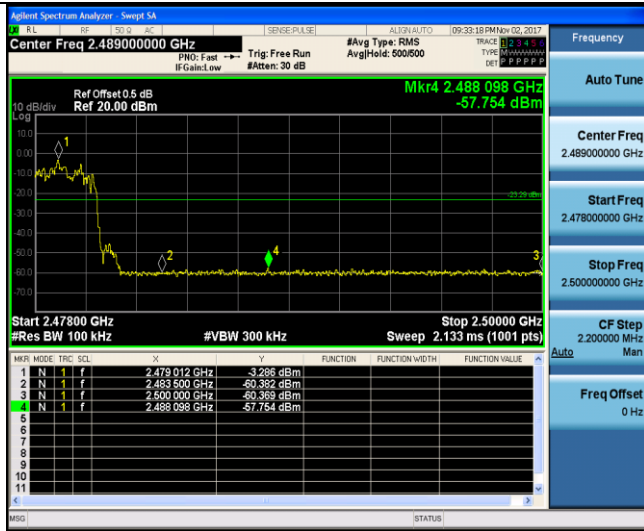

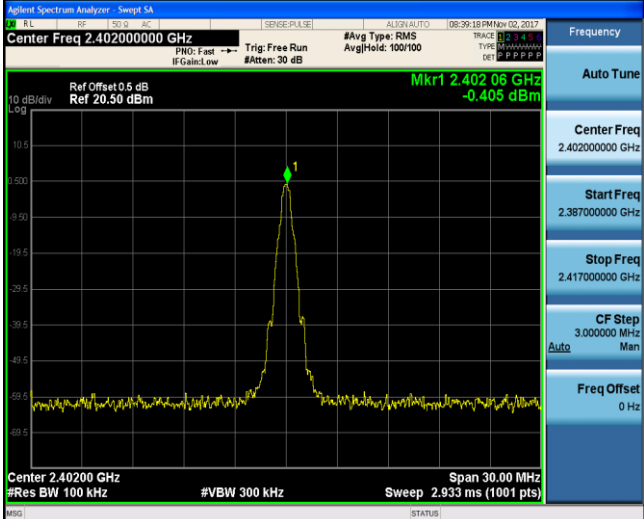
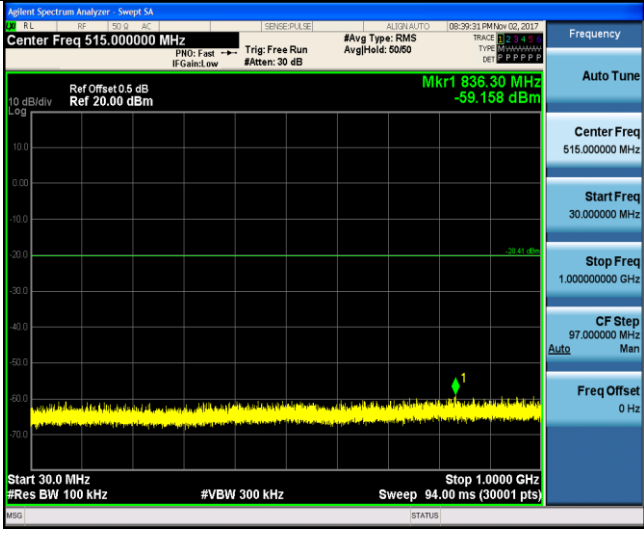
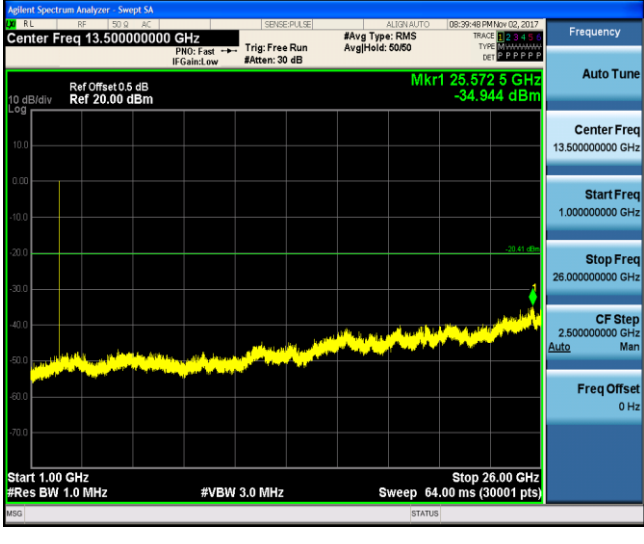
Test Item:	SE	Modulation type:	GFSK
reference level CH00			
CH00			
			

reference level CH39

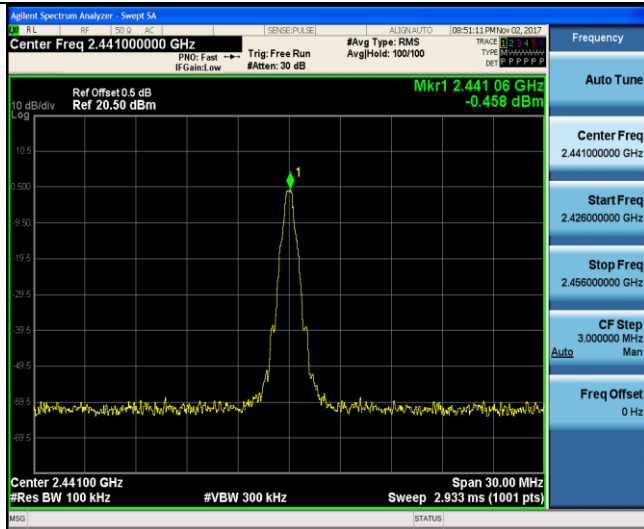

CH39

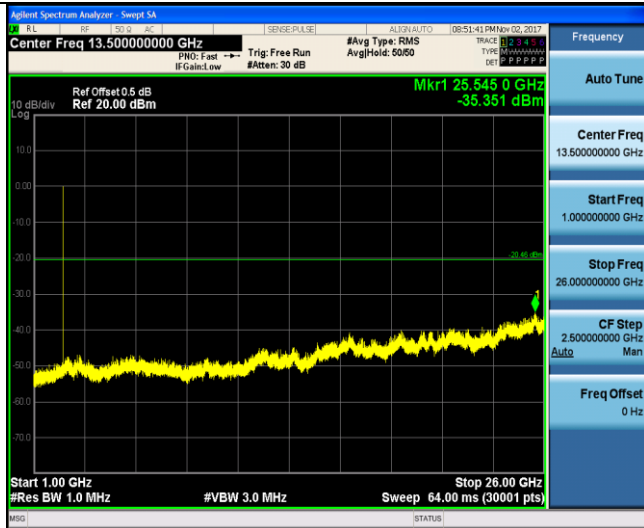
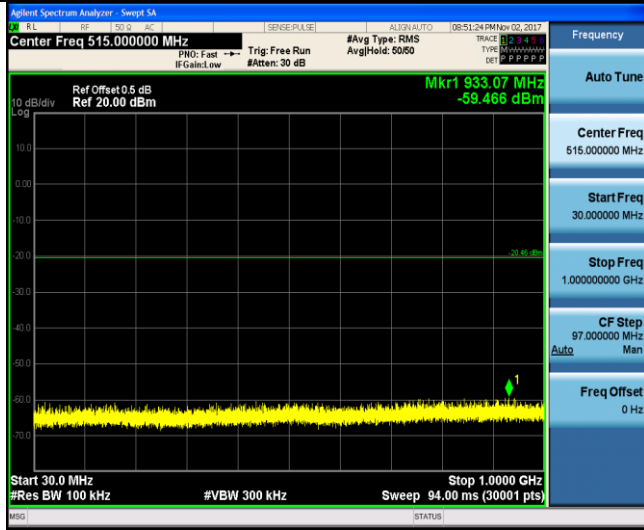

reference level CH78

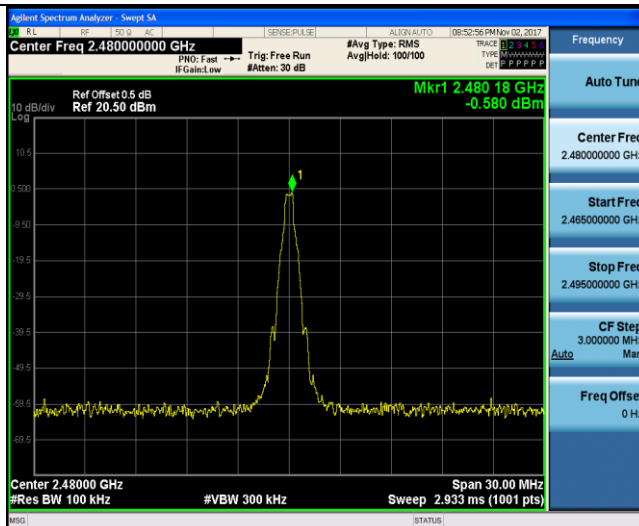

CH78

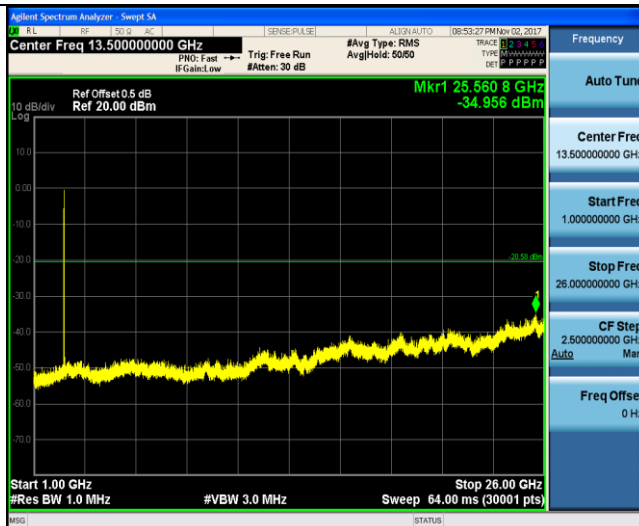
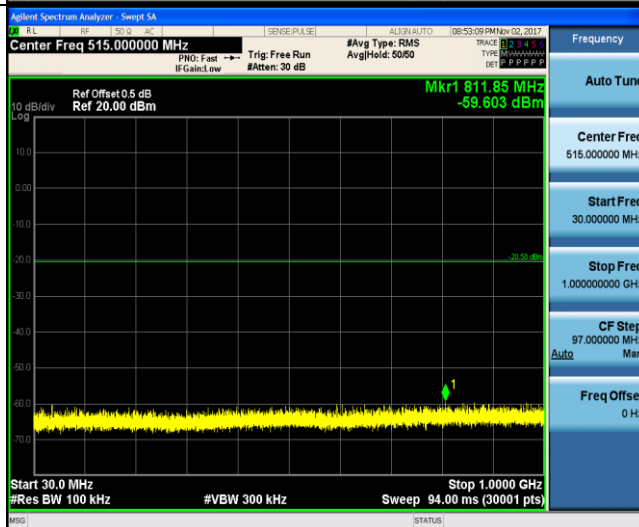

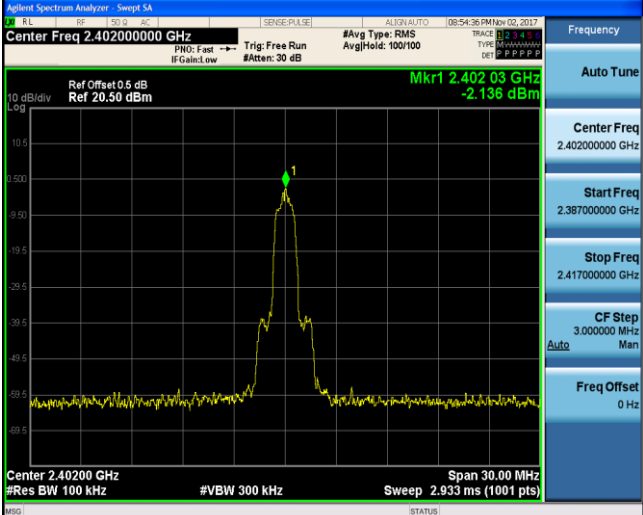
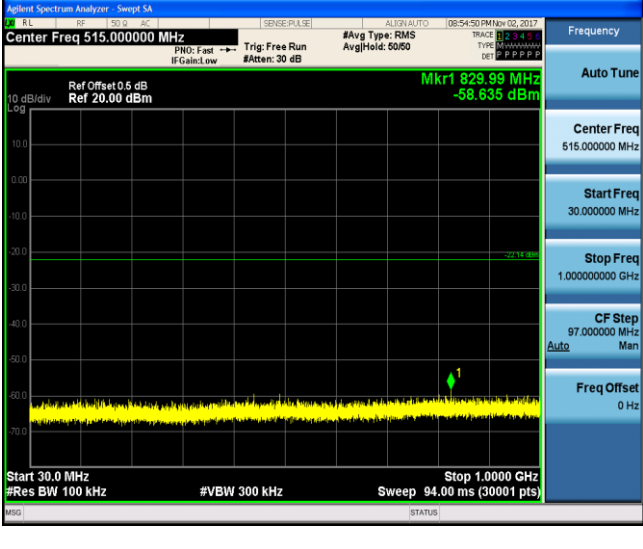
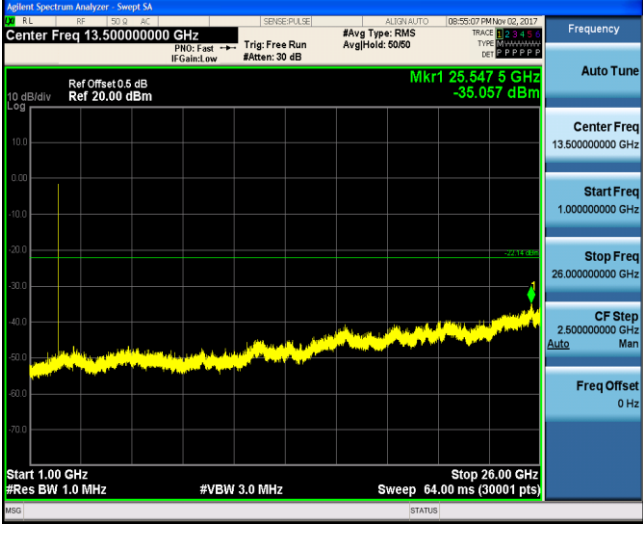
Test Item:	SE	Modulation type:	$\pi/4$ DQPSK
reference level CH00			
CH00			
			

reference level CH39

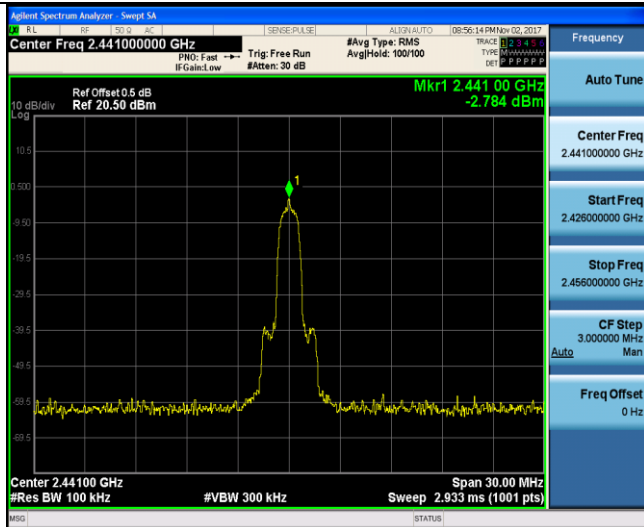

CH39

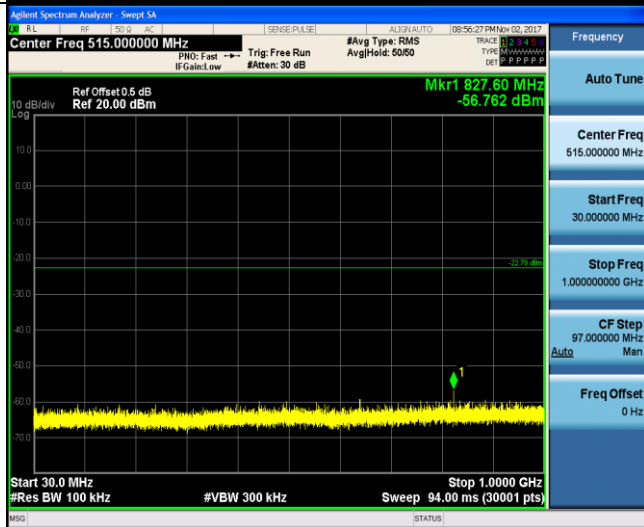

reference level CH78

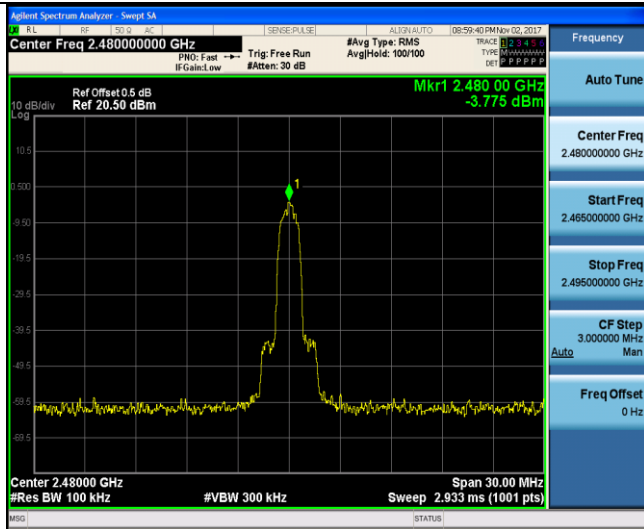

CH78

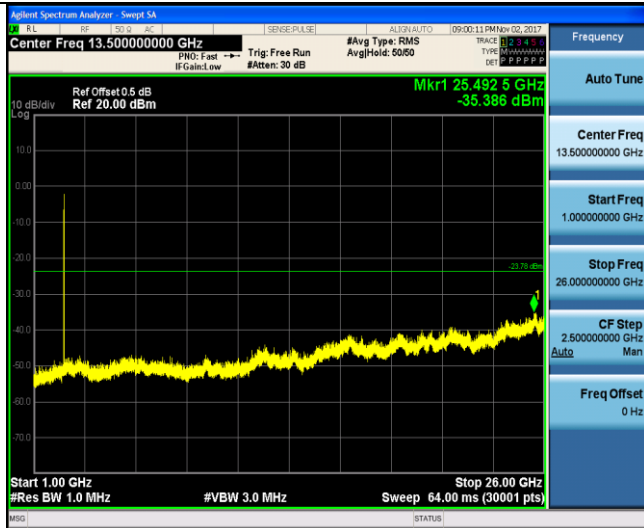
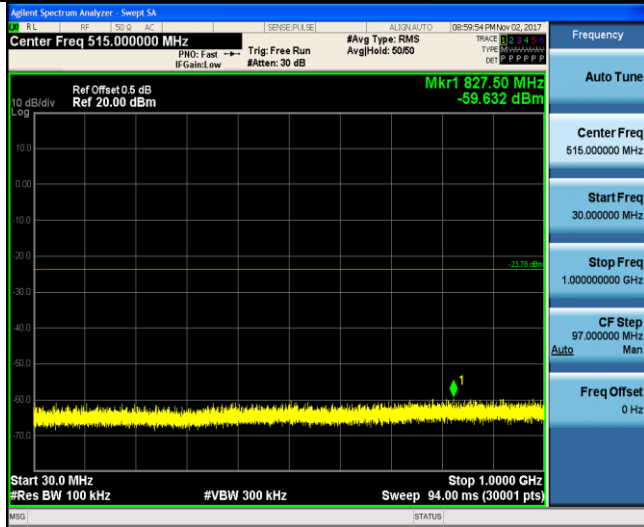

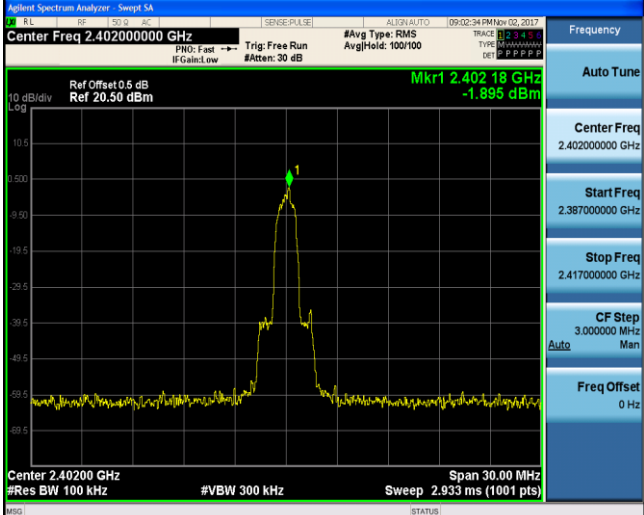
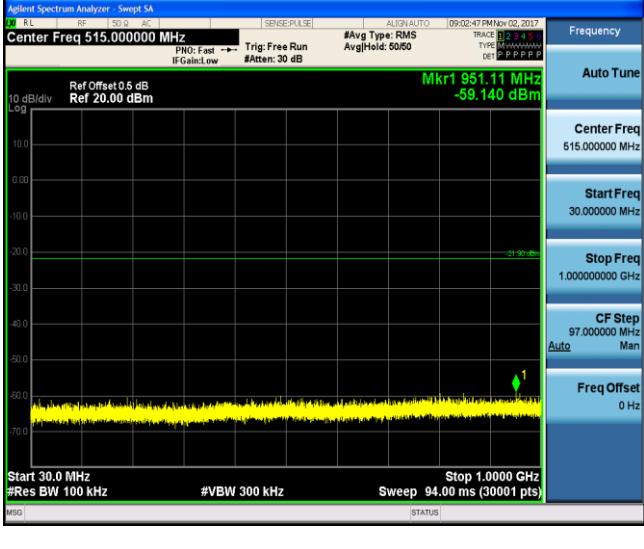
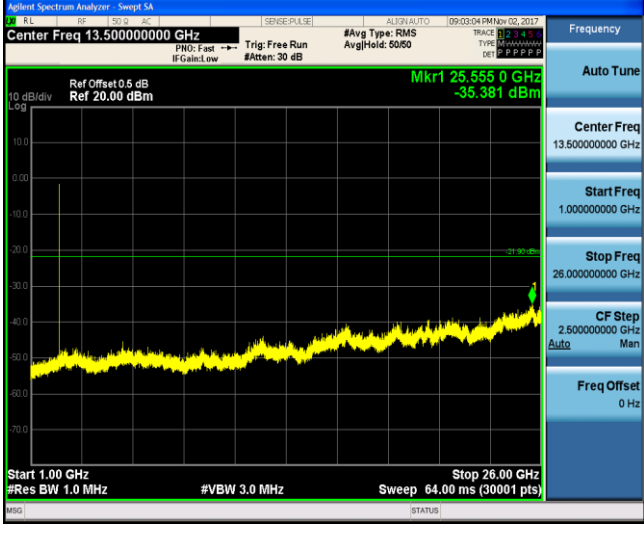
Test Item:	SE	Modulation type:	8DPSK
reference level CH00			
CH00			
			

reference level CH39

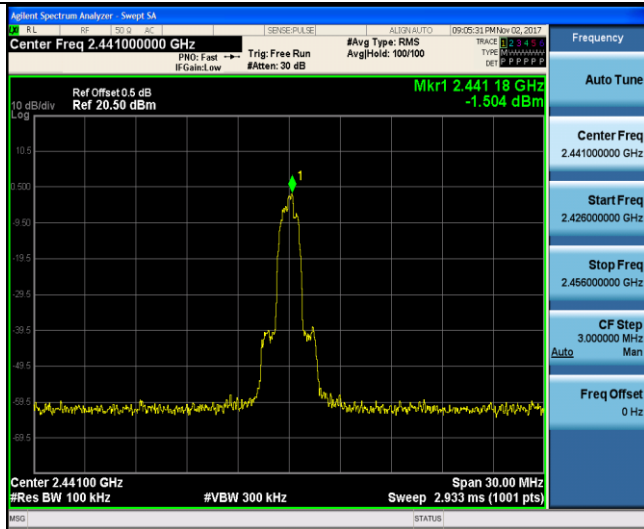

CH39

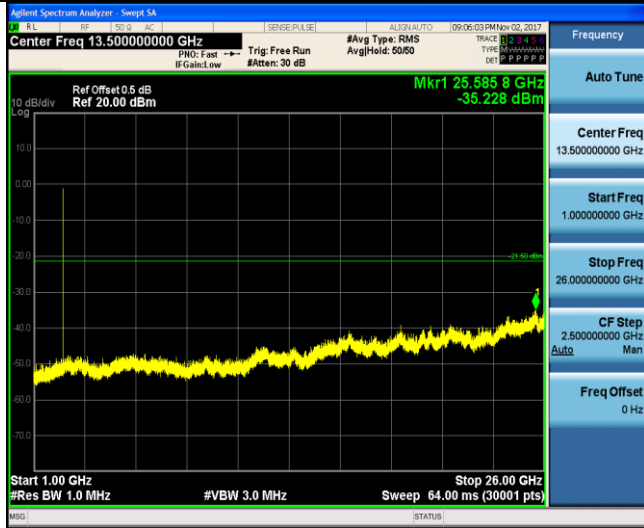
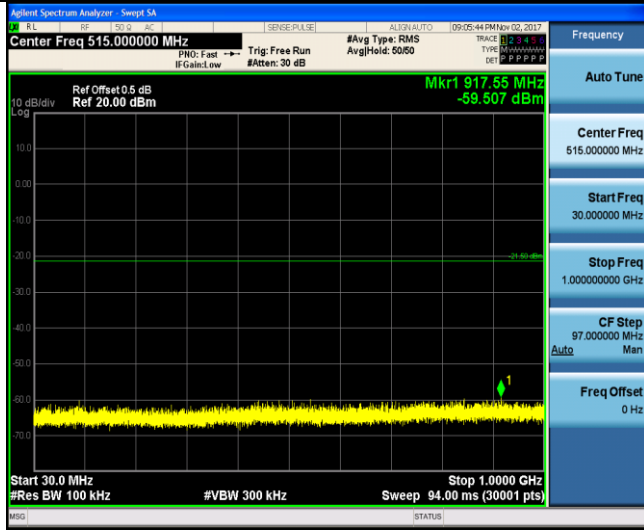

reference level CH78

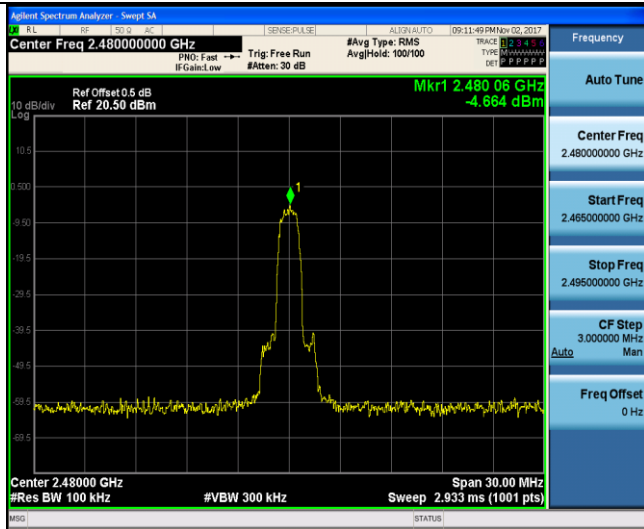

CH78

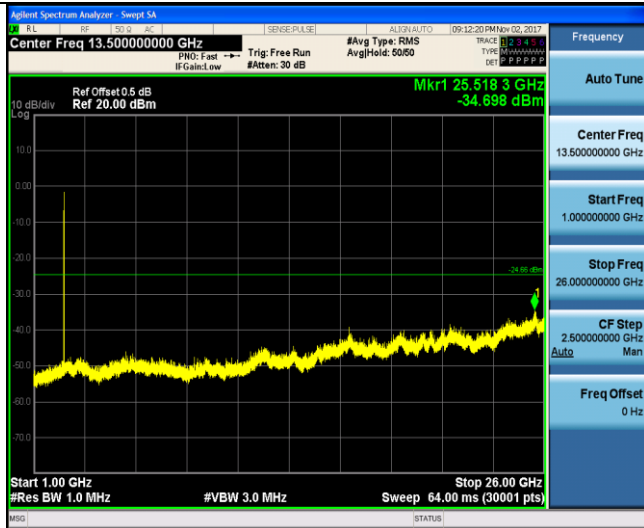
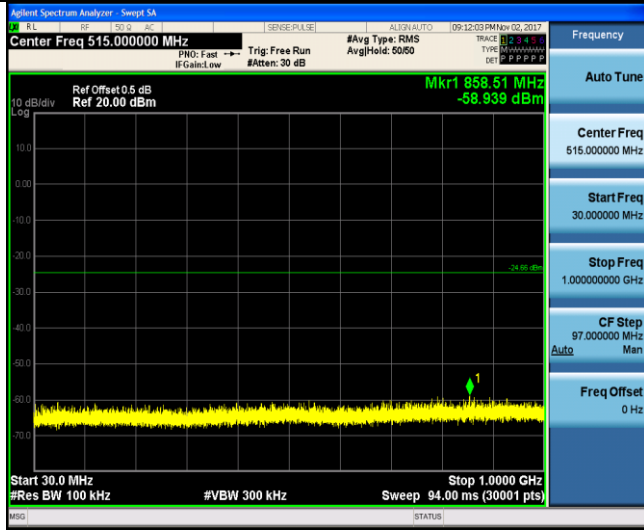

5.11. Spurious Emissions (radiated)

LIMIT

FCC CFR Title 47 Part 15 Subpart C Section 15.209

Frequency	Limit (dBuV/m @3m)	Value
30 MHz ~ 88 MHz	40.00	Quasi-peak
88 MHz ~ 216 MHz	43.50	Quasi-peak
216 MHz ~ 960 MHz	46.00	Quasi-peak
960 MHz ~ 1 GHz	54.00	Quasi-peak
Above 1 GHz	54.00	Average
	74.00	Peak

TEST CONFIGURATION

- Below 30 MHz

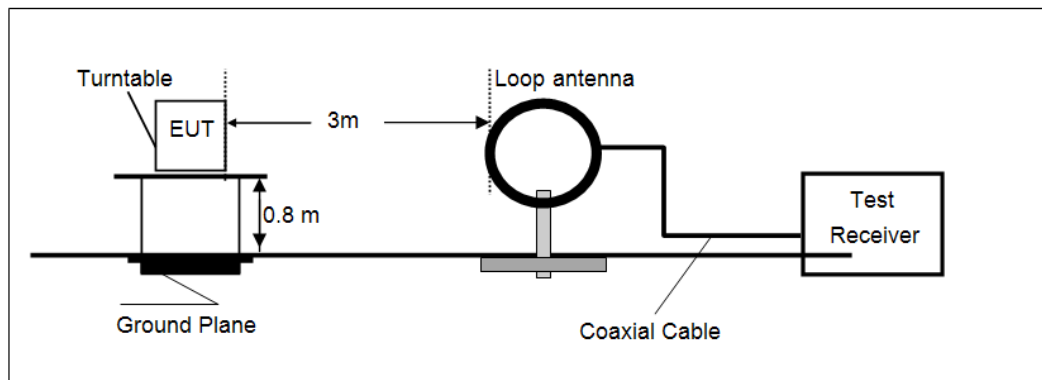

- 30 MHz ~1000 MHz

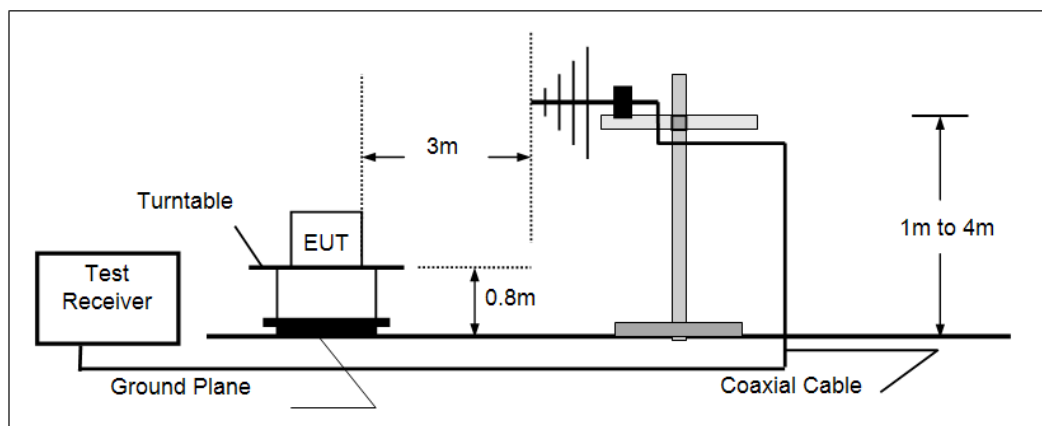

- Above 1 GHz

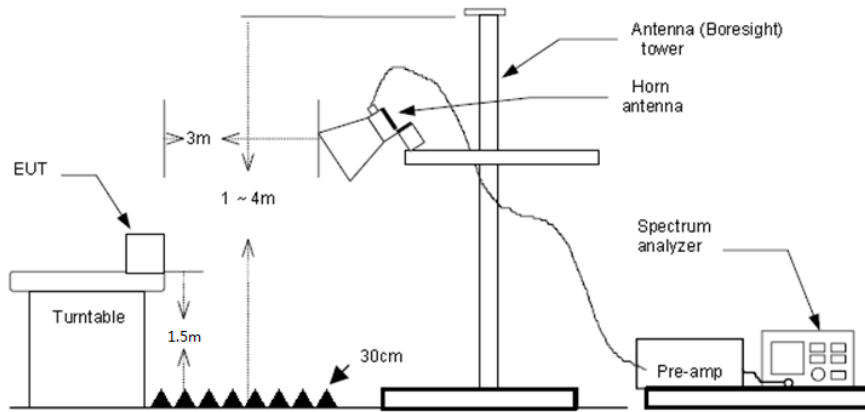

TEST PROCEDURE

1. The EUT was tested according to ANSI C63.10:2013.
2. The EUT is placed on a turn table which is 0.8 meter above ground. The turn table is rotated 360 degrees to determine the position of the maximum emission level.
3. The EUT was positioned such that the distance from antenna to the EUT was 3 meters.
4. The antenna is scanned from 1 meter to 4 meters to find out the maximum emission level. This is repeated for both horizontal and vertical polarization of the antenna.
5. Use the following spectrum analyzer settings
 - (1) Span shall wide enough to fully capture the emission being measured;
 - (2) Below 1 GHz, RBW=120 kHz, VBW=300 kHz, Sweep=auto, Detector function=peak, Trace=max hold; If the emission level of the EUT measured by the peak detector is 3 dB lower than the applicable limit, the peak emission level will be reported. Otherwise, the emission measurement will be repeated using the quasi-peak detector and reported.
 - (3) Above 1 GHz, RBW=1 MHz, VBW=3 MHz Peak detector for Peak value
RBW=1 MHz, VBW=10 Hz Peak detector for Average value.

TEST MODE:

Please refer to the clause 3.3

TEST RESULTS

Passed Not Applicable

Note:

- 1) Final Level = Receiver Read level + Antenna Factor + Cable Loss – Preamplifier Factor
- 2) The emission levels of other frequencies are very lower than the limit and not show in test report.
- 3) Below 1 GHz, Have pre-scan all modulation mode, found the GFSK modulation High channel which it was worst case, so only the worst case's data on the test report.
- 4) Above 1 GHz, Have pre-scan all modulation mode, found the GFSK modulation which it was worst case, so only the worst case's data on the test report
- 5) The peak level is lower than average limit(54 dBuV/m), this data is the too weak instrument of signal is unable to test.

➤ 9 kHz ~ 30 MHz

The low frequency, which started from 9 kHz to 30 MHz, was pre-scanned and the result which was 20 dB lower than the limit line per 15.31(o) was not reported.

➤ 30 MHz ~ 1 GHz

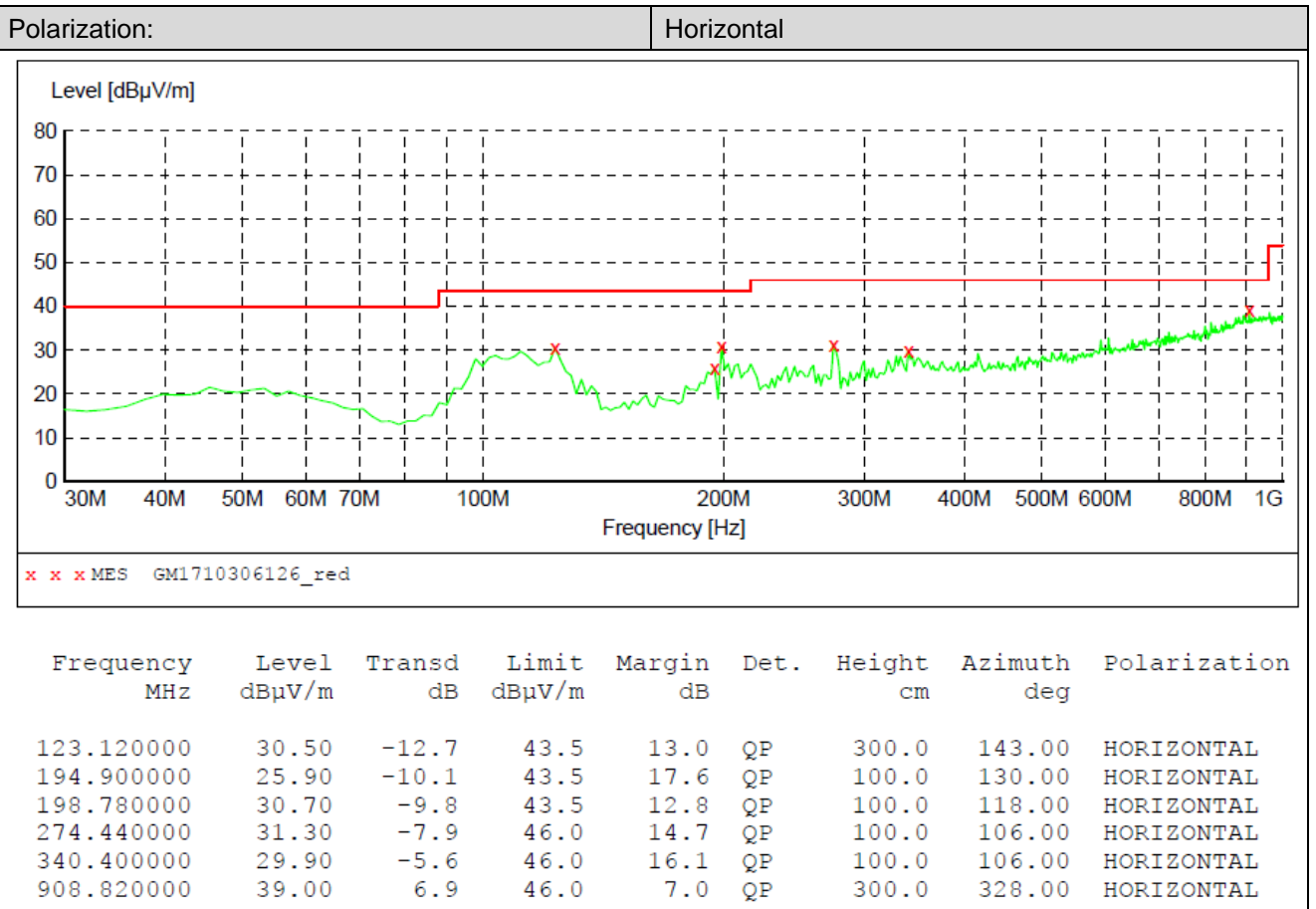
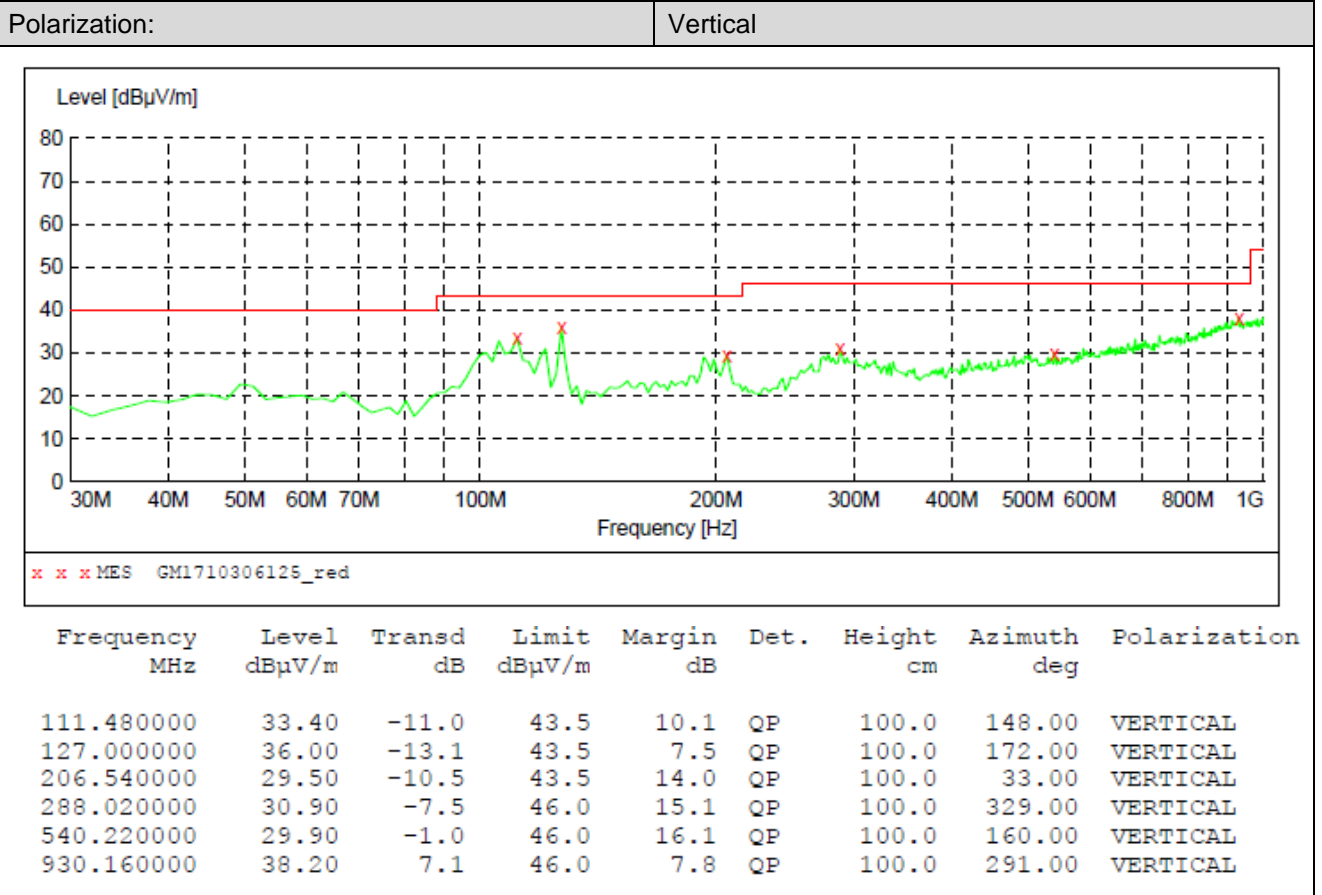

➤ 1 GHz ~ 25 GHz

CH00									
Frequency (MHz)	Read Level (dBuV)	Antenna Factor (dB/m)	Cable Loss (dB)	Preamp Factor (dB)	Level (dBuV/m)	Limit Line (dBuV/m)	Over Limit (dB)	Polarization	Test value
1948.25	42.61	25.79	6.19	37.26	37.33	74.00	-36.67	Vertical	Peak
3844.28	34.46	29.64	8.56	38.20	34.46	74.00	-39.54	Vertical	Peak
4809.50	43.91	31.58	9.55	36.93	48.11	74.00	-25.89	Vertical	Peak
6764.54	33.47	34.07	11.56	35.06	44.04	74.00	-29.96	Vertical	Peak
1413.67	37.56	25.89	5.04	36.48	32.01	74.00	-41.99	Horizontal	Peak
3096.33	35.62	28.79	7.60	38.22	33.79	74.00	-40.21	Horizontal	Peak
4809.50	45.34	31.58	9.55	36.93	49.54	74.00	-24.46	Horizontal	Peak
7338.62	31.80	36.30	12.01	34.90	45.21	74.00	-28.79	Horizontal	Peak

CH39									
Frequency (MHz)	Read Level (dBuV)	Antenna Factor (dB/m)	Cable Loss (dB)	Preamp Factor (dB)	Level (dBuV/m)	Limit Line (dBuV/m)	Over Limit (dB)	Polarization	Test value
1431.78	37.37	25.87	5.09	36.50	31.83	74.00	-42.17	Vertical	Peak
3018.50	37.61	28.64	7.50	38.23	35.52	74.00	-38.48	Vertical	Peak
4883.52	43.22	31.43	9.59	36.73	47.51	74.00	-26.49	Vertical	Peak
6511.12	32.69	34.02	11.20	35.34	42.57	74.00	-31.43	Vertical	Peak
1283.34	36.69	26.22	4.80	36.52	31.19	74.00	-42.81	Horizontal	Peak
1943.29	43.69	25.74	6.18	37.25	38.36	74.00	-35.64	Horizontal	Peak
3184.25	36.23	28.80	7.70	38.20	34.53	74.00	-39.47	Horizontal	Peak
4883.52	41.09	31.43	9.59	36.73	45.38	74.00	-28.62	Horizontal	Peak

CH78									
Frequency (MHz)	Read Level (dBuV)	Antenna Factor (dB/m)	Cable Loss (dB)	Preamp Factor (dB)	Level (dBuV/m)	Limit Line (dBuV/m)	Over Limit (dB)	Polarization	Test value
1491.30	35.66	25.81	5.26	36.58	30.15	74.00	-43.85	Vertical	Peak
3233.26	35.62	28.60	7.76	38.26	33.72	74.00	-40.28	Vertical	Peak
4958.68	45.50	31.46	9.64	36.52	50.08	74.00	-23.92	Vertical	Peak
7135.98	31.67	35.82	11.86	34.99	44.36	74.00	-29.64	Vertical	Peak
1953.21	44.25	25.84	6.20	37.26	39.03	74.00	-34.97	Horizontal	Peak
3598.09	34.44	29.29	8.27	38.27	33.73	74.00	-40.27	Horizontal	Peak
4958.68	41.85	31.46	9.64	36.52	46.43	74.00	-27.57	Horizontal	Peak
7117.84	31.95	35.71	11.86	34.96	44.56	74.00	-29.44	Horizontal	Peak

Remark:

1. Final Level = Receiver Read level + Antenna Factor + Cable Loss – Preamplifier Factor
2. The peak level is lower than average limit(54 dBuV/m), this data is the too weak instrument of signal is unable to test.
3. The emission levels of other frequencies(test frequency band is 1GHz to 25GHz) are very lower than the limit and not show in test report.

6. TEST SETUP PHOTOS

Conducted Emissions (AC Mains)



Radiated Emissions

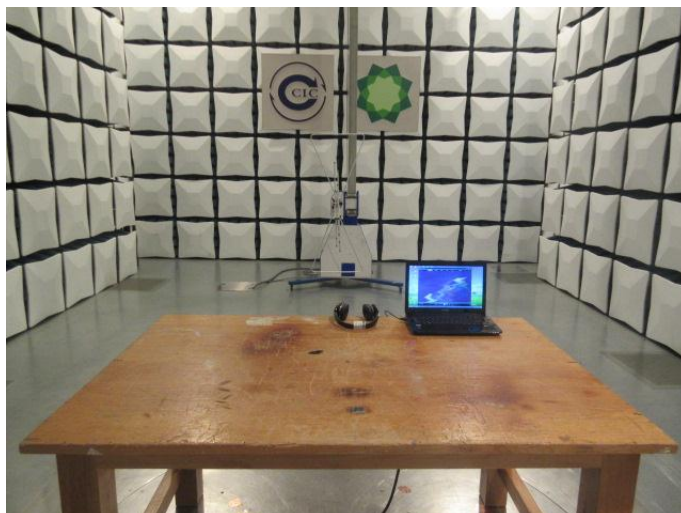

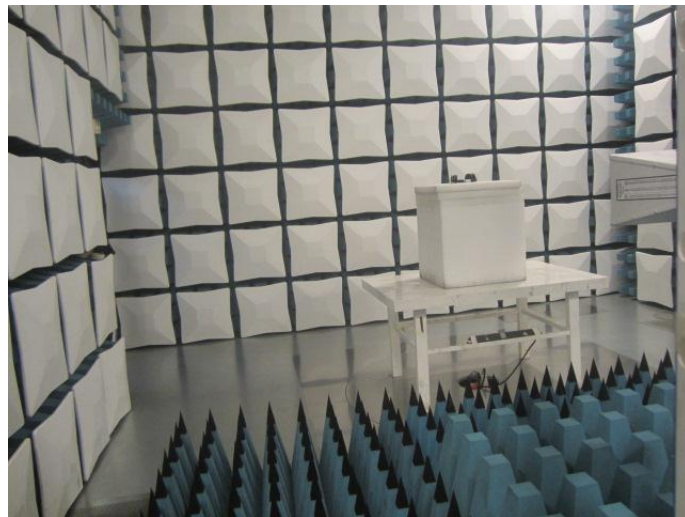
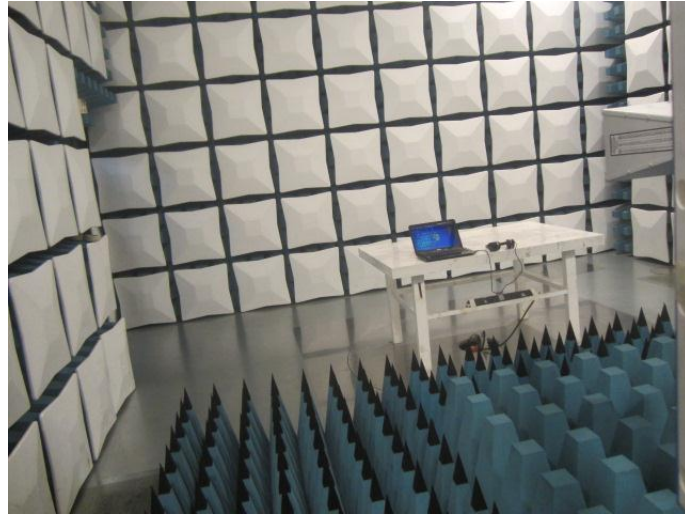

7. EXTERANAL AND INTERNAL PHOTOS

EXTERANAL PHOTOS



INTERNAL PHOTOS

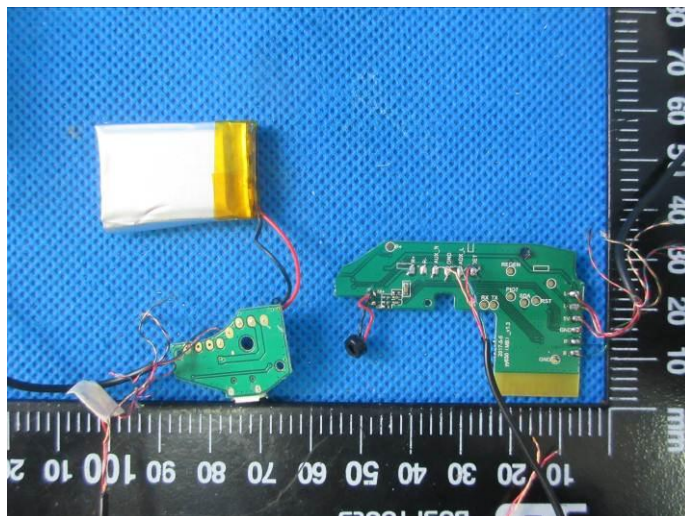
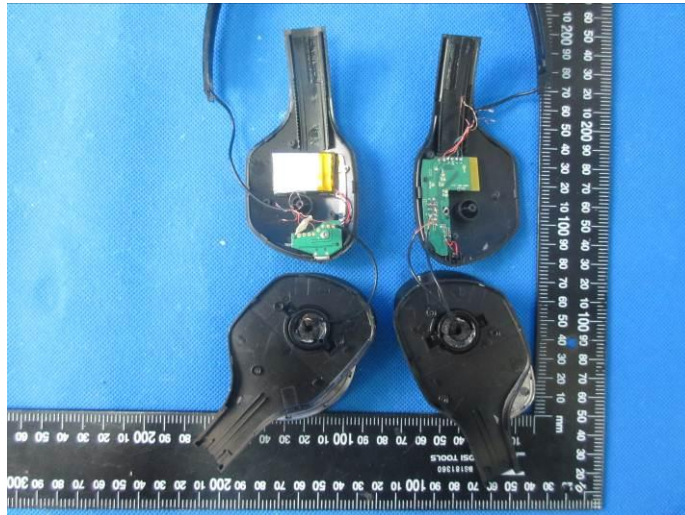

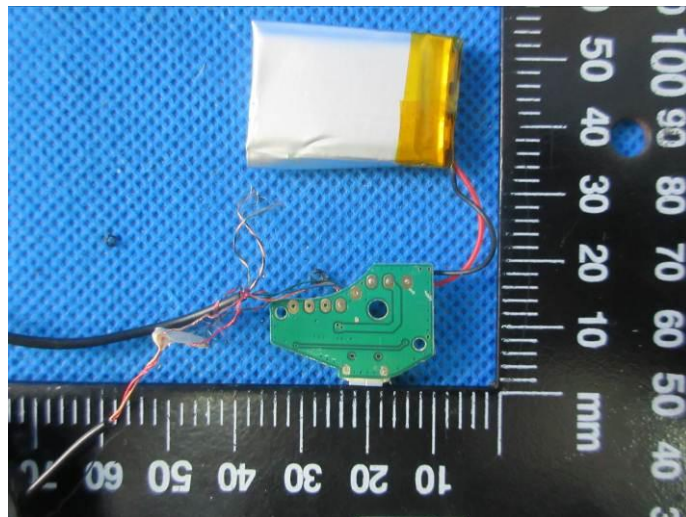
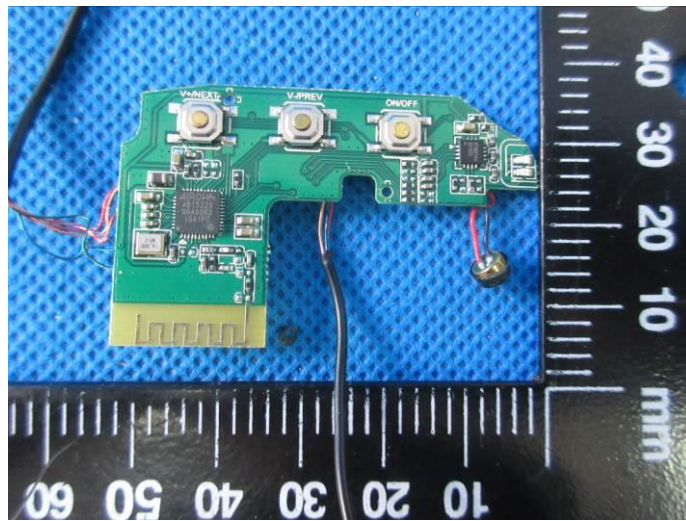
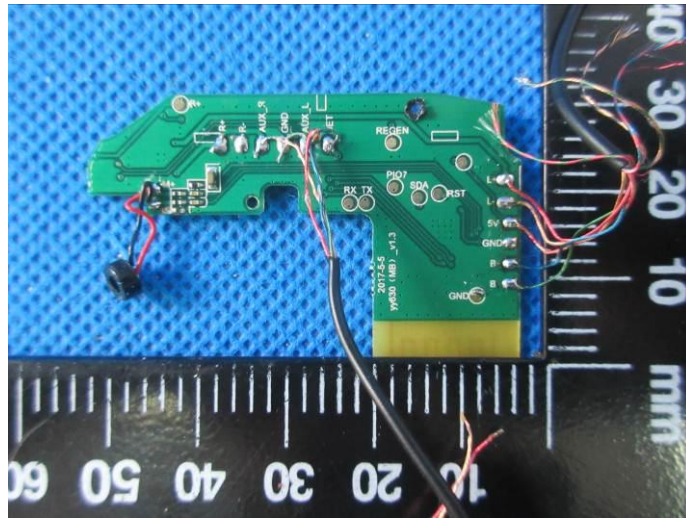

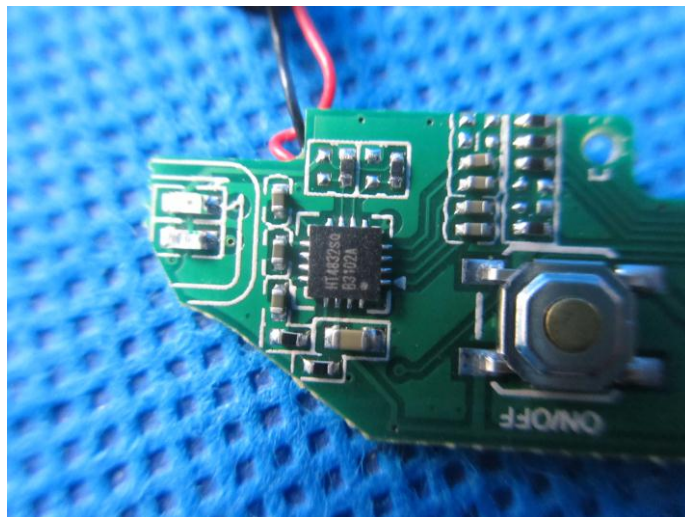
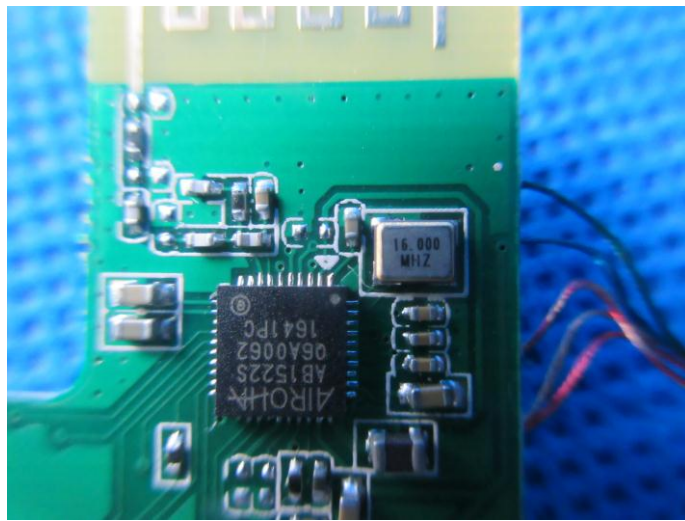
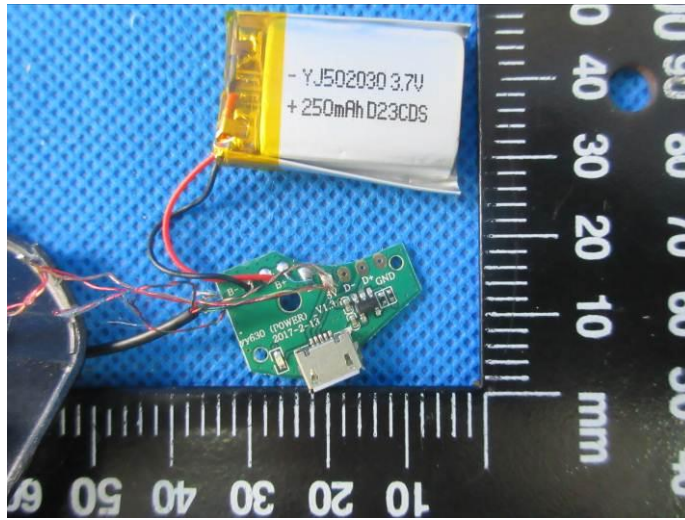

.....End of Report.....