

Report on the Radio Testing
For
Advanced Diagnostics Ltd
on
Smart Aerial
Report no. TRA-029243-45-01A
10th December 2015

Report Number: TRA-029243-45-01A
Issue: A

REPORT ON THE RADIO TESTING OF A
Advanced Diagnostics Ltd
Smart Aerial
WITH RESPECT TO SPECIFICATION
FCC 47CFR 15 C 15.209 & IC RSS-210 Annex 2.9

TEST DATE: 25/11/12

Written by: K Anderson

K J Anderson
Radio, Senior Test Engineer

Approved by:

J Charters
Department Manager - Radio

Date: 10th December 2015

Disclaimers:

- [1] THIS DOCUMENT MAY BE REPRODUCED ONLY IN ITS ENTIRETY AND WITHOUT CHANGE
- [2] THE RESULTS CONTAINED IN THIS DOCUMENT RELATE ONLY TO THE ITEM(S) TESTED

RF922 2.0

1 Revision Record

<i>Issue Number</i>	<i>Issue Date</i>	<i>Revision History</i>
A	10th December 2015	Original

2 Summary

TEST REPORT NUMBER: TRA-029243-45-01A

WORKS ORDER NUMBER: TRA-029243-03

PURPOSE OF TEST: USA: Testing of radio frequency equipment per the relevant authorization procedure of chapter 47 of CFR (code of federal regulations) Part 2, subpart J.

Canada: Testing of radio apparatus for TAC (technical acceptance certificate) per subsections 4(2) of the Radio communication Act and 21(1) of the Radio communication Regulations.

TEST SPECIFICATION(S): 47CFR15C 15.209 & RSS-210 Annex 2.9

EQUIPMENT UNDER TEST (EUT): Smart Aerial

FCC IDENTIFIER: 2AGRI242

EUT SERIAL NUMBER: 1002

MANUFACTURER/AGENT: Advanced Diagnostics Ltd

ADDRESS: Unit 6
Eastboro Fields
Hemdale
Nuneaton
CV11 6GL
United Kingdom

CLIENT CONTACT: Robert Collier

 rob.collier@advanced-diagnostics.com

ORDER NUMBER: N/A

TEST DATE: 25/11/12

TESTED BY: K J Anderson
Element

2.1 Test Summary

Test Method and Description	Requirement Clause		Applicable to this equipment	Result / Note
	RSS	47CFR15		
Radiated spurious emissions	210, A2.9(b)	15.209	☒	Pass
AC power line conducted emissions	Gen, 8.8	15.207	☒	N/A
Occupied bandwidth	Gen, 6.6	15.215(c)	☒	Pass
Field strength of fundamental	210, A2.9(a)	15.209	☒	Pass
Calculation of duty correction ¹	-	15.35(c)	☒	N/A

Notes:

The results contained in this report relate only to the items tested, in the condition at time of test, and were obtained in the period between the date of initial receipt of samples and the date of issue of the report.

The apparatus was set up and exercised using the configurations, modes of operation and arrangements defined in this report only. Any modifications made are identified in Section 8 of this report.

Particular operating modes, apparatus monitoring methods and performance criteria required by the standards tested to have been performed except where identified in Section 5.2 of this test report (Deviations from Test Standards).

3 Contents

1	Revision Record.....	3
2	Summary.....	4
2.1	Test Summary.....	5
3	Contents.....	6
4	Introduction	7
5	Test Specifications.....	8
5.1	Normative References	8
5.2	Deviations from Test Standards	8
6	Glossary of Terms.....	9
7	Equipment Under Test	10
7.1	EUT Identification.....	10
7.2	System Equipment.....	10
7.3	EUT Mode of Operation	10
7.3.1	Transmission.....	10
7.3.2	Reception.....	10
7.4	EUT Radio Parameters	11
7.4.1	General	11
7.4.2	Antennas.....	11
7.5	EUT Description	11
8	Modifications	12
9	EUT Test Setup	13
9.1	Block Diagram.....	13
9.2	General Set-up Photograph	14
10	General Technical Parameters.....	15
10.1	Normal Conditions.....	15
10.2	Varying Test Conditions	15
11	Radiated emissions.....	16
11.1	Definitions	16
11.2	Test Parameters.....	16
11.3	Test Limit.....	17
11.4	Test Method	18
11.5	Test Set-up Photograph	19
11.6	Test Equipment.....	21
11.7	Test Results	22
12	AC power-line conducted emissions	25
13	Occupied Bandwidth	26
13.1	Definitions	26
13.2	Test Parameters.....	26
13.3	Test Limit.....	26
13.4	Test Method	27
13.5	Test Equipment.....	27
13.6	Test Results	28
14	Transmitter output power (fundamental radiated emission)	30
14.1	Definition	30
14.2	Test Parameters.....	30
14.3	Test Limit.....	30
14.4	Test Method	31
14.5	Test Equipment.....	31
14.6	Test Results	32
15	Duty Cycle.....	33
16	Measurement Uncertainty	34
17	RF Exposure	35

4 Introduction

This report TRA-029243-45-01A presents the results of the Radio testing on a Advanced Diagnostics Ltd, Smart Aerial to specification 47CFR15 Radio Frequency Devices and RSS-210 Licence-exempt Radio Apparatus (All Frequency Bands): Category I Equipment.

The testing was carried out for Advanced Diagnostics Ltd by Element, at the address(es) detailed below.

<input checked="" type="checkbox"/>	Element Hull Unit E South Orbital Trading Park Hedon Road Hull HU9 1NJ UK	<input type="checkbox"/>	Element North West Unit 1 Pendle Place Skemersdale West Lancashire WN8 9PN UK
-------------------------------------	---	--------------------------	---

This report details the configuration of the equipment, the test methods used and any relevant modifications where appropriate.

All test and measurement equipment under the control of the laboratory and requiring calibration is subject to an established programme and procedures to control and maintain measurement standards. The quality management system meets the principles of ISO 9001, and has quality control procedures for monitoring the validity of tests undertaken. Records and sufficient detail are retained to establish an audit trail of calibration records relating to its test results for a defined period. Under control of the established calibration programme, key quantities or values of the test & measurement instrumentation are within specification and comply with the relevant traceable internationally recognised and appropriate standard specifications, which are UKAS calibrated as such where these properties have a significant effect on results. Participation in inter-laboratory comparisons and proficiency testing ensures satisfactory correlation of results conform to Elements own procedures, as well as statistical techniques for analysis of test data providing the appropriate confidence in measurements.

Throughout this report EUT denotes equipment under test.

FCC Site Listing:

Element is accredited for the above sites under the US-EU MRA, Designation number UK0009.

IC Registration Number(s):

Element Hull 3483A

The test site requirements of ANSI C63.4-2014 are met up to 1 GHz.

The test site SVSWR requirements of CISPR 16-1-4:2010 are met over the frequency range 1 GHz to 18 GHz.

5 Test Specifications

5.1 Normative References

- FCC 47 CFR Ch. I – Part 15 – Radio Frequency Devices.
- ANSI C63.10-2013 – American National Standard of Procedures for Compliance Testing of Unlicensed Wireless Devices.
- ANSI C63.4-2014 – American National Standard for Methods of Measurement of Radio-Noise Emissions from Low-Voltage Electrical and Electronic Equipment in the Range of 9 kHz to 40 GHz.
- Industry Canada RSS-210, Issue 8, December 2010 – Licence-exempt Radio Apparatus (All Frequency Bands): Category I Equipment.
- Industry Canada RSS-Gen, Issue 4, November 2014 – General Requirements for Compliance of Radio Apparatus.

5.2 Deviations from Test Standards

There were no deviations from the test standard.

6 Glossary of Terms

§	denotes a section reference from the standard, not this document
AC	Alternating Current
ANSI	American National Standards Institute
BW	bandwidth
C	Celsius
CFR	Code of Federal Regulations
CW	Continuous Wave
dB	decibel
dBm	dB relative to 1 milliwatt
DC	Direct Current
DSSS	Direct Sequence Spread Spectrum
EIRP	Equivalent Isotropically Radiated Power
ERP	Effective Radiated Power
EUT	Equipment Under Test
FCC	Federal Communications Commission
FHSS	Frequency Hopping Spread Spectrum
Hz	hertz
IC	Industry Canada
ITU	International Telecommunication Union
LBT	Listen Before Talk
m	metre
max	maximum
MIMO	Multiple Input and Multiple Output
min	minimum
MRA	Mutual Recognition Agreement
N/A	Not Applicable
PCB	Printed Circuit Board
PDF	Portable Document Format
Pt-mpt	Point-to-multipoint
Pt-pt	Point-to-point
RF	Radio Frequency
RH	Relative Humidity
RMS	Root Mean Square
Rx	receiver
s	second
SVSWR	Site Voltage Standing Wave Ratio
Tx	transmitter
UKAS	United Kingdom Accreditation Service
V	volt
W	watt
Ω	ohm

7 Equipment Under Test

7.1 EUT Identification

- Name: Smart Aerial
- Serial Number: 1002
- Model Number: ADC242
- Software Revision: Not Applicable
- Build Level / Revision Number: Not Applicable

7.2 System Equipment

Equipment listed below forms part of the overall test setup and is required for equipment functionality and/or monitoring during testing. The compliance levels achieved in this report relate only to the EUT and not items given in the following list.

Laptop, interface board and PSU.

7.3 EUT Mode of Operation

7.3.1 Transmission

The mode of operation for Tx tests was as follows:

EUT transmitting at 125 kHz using ASK Modulation

7.3.2 Reception

The mode of operation for Rx tests was as follows...

As the EUT incorporates a co-located transmitter, no separate RX mode was available.

7.4 EUT Radio Parameters

7.4.1 General

Frequency of operation:	125 kHz
Modulation type(s):	ASK
Occupied channel bandwidth(s):	N/A
Channel spacing:	N/A
ITU emission designator(s):	10K0A1D
Declared output power(s):	N/A, (output below spurious limit)
Warning against use of alternative antennas in user manual (yes/no):	N/A integral loop antenna
Nominal Supply Voltage:	12 V Vehicle supply
Frequency stability:	N/A integral loop antenna
Location of notice for license exempt use:	Label
Method of prevention of use on non-US / non-Canadian frequencies:	N/A, (output below spurious limit)
Duty cycle:	N/A, (output below spurious limit)

7.4.2 Antennas

Type:	Integral loop
Frequency range:	125 kHz
Impedance:	N/A
SWR:	N/A
Gain:	N/A
Length:	N/A
Weight:	N/A
Environmental limits:	N/A
Mounting:	Integral

7.5 EUT Description

The EUT is a programming unit for car key fobs and contains a 125 kHz ASK transmitter.

8 Modifications

No modifications were performed during this assessment.

9 EUT Test Setup

9.1 Block Diagram

The following diagram shows basic EUT interconnections with cable type and cable lengths identified:

Notes:- Keyfob is support equipment.

The PSU, laptop and interface board are supplied to support the testing only. The EUT is powered in use from the vehicle supply.

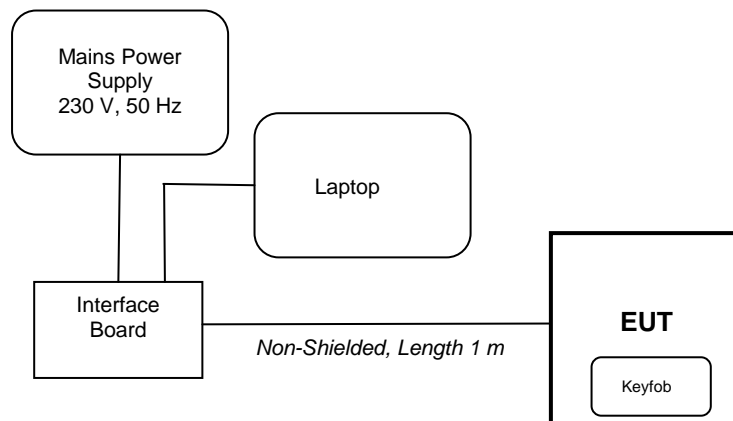

9.2 General Set-up Photograph

The following photograph shows basic EUT set-up:

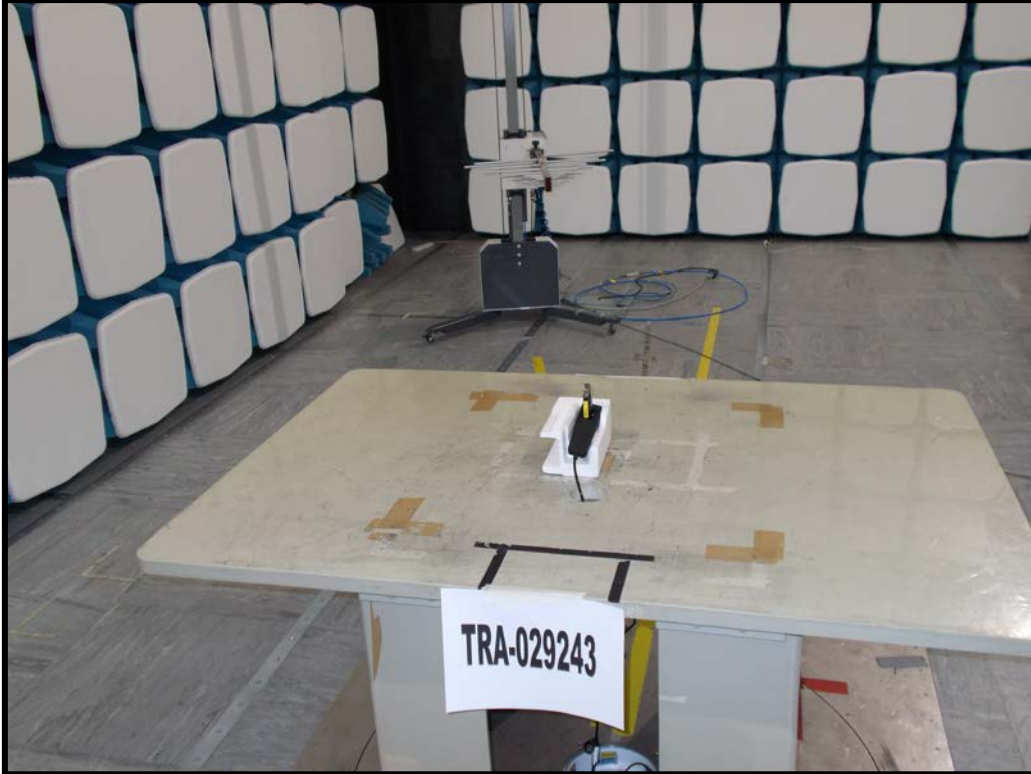

10 General Technical Parameters

10.1 Normal Conditions

The E U T was tested under the normal environmental conditions of the test laboratory, except where otherwise stated. The 12V dc power supply was used to simulate the vehicle supply.

10.2 Varying Test Conditions

There are no specific frequency stability requirements for the type of device. The results contained in this report demonstrate that the occupied bandwidth is contained within the authorised band and the manufacturer has declared sufficient frequency stability (refer to section 7.4).

11 Radiated emissions

11.1 Definitions

Out-of-band emissions

Emissions on a frequency or frequencies immediately outside the necessary bandwidth which result from the modulation process, but exclude spurious emissions.

Spurious emissions

Emissions on a frequency or frequencies which are outside the necessary bandwidth and the level of which may be reduced without affecting the corresponding transmission of information. Spurious emissions include harmonic emissions, parasitic emissions, intermodulation products and frequency conversion products, but exclude out-of-band emissions.

Restricted bands

A frequency band in which intentional radiators are permitted to radiate only spurious emissions but not fundamental signals.

11.2 Test Parameters

Test Location:	Element Hull
Test Chamber:	Lab 16
Test Standard and Clause:	ANSI C63.10-2013, Clause 6.5 and 6.6
EUT Channels / Frequencies Measured:	125kHz
EUT Channel Bandwidths:	N/A
Deviations From Standard:	None
Measurement BW:	9 kHz to 150 kHz: 200 Hz 150 kHz to 30 MHz: 9 kHz 30 MHz to 1 GHz: 120 kHz
Measurement Detector:	Below 30 MHz: RMS average and Peak 30 MHz to 1 GHz: quasi-peak

Environmental Conditions (Normal Environment)

Temperature: 21 °C	+15 °C to +35 °C (as declared)
Humidity: 48 % RH	20 % RH to 75 % RH (as declared)

11.3 Test Limit

Out-of-band emissions shall be below or to the general field strength limits listed in FCC 47CFR15.209 / RSS-Gen {see table below}

General Field Strength Limits for Licence-Exempt Transmitters

<i>Frequency (MHz)</i>	<i>Field Strength (μV/m)</i>	<i>Measurement distance (meters)</i>
0.009–0.490	2400/F(kHz)	300
0.490–1.705	24000/F(kHz)	30
1.705–30.0	30	30
30 to 88	100	3
88 to 216	150	3
216 to 960	200	3
Above 960	500	3

n.b. per FCC 47CFR15.35(b) / RSS-Gen 8.1, peak limit is 20 dB above average.

11.4 Test Method

With the EUT setup as per section 9 of this report and connected as per Figure i, the emissions from the EUT were measured on a spectrum analyzer / EMI receiver.

Radiated electromagnetic emissions from the EUT are checked first by preview scans. Preview scans for all spectrum and modulation characteristics are checked, using a peak detector and where applicable worst-case determined for function, operation, orientation, etc. for both vertical and horizontal polarisations. Pre-scan plots are shown with a peak detector and 100 kHz RBW.

If the EUT connects to auxiliary equipment and is table or floor standing, the configurations prescribed in ANSI C63.10 are followed. Alternatively, a layout closest to normal use (as declared by the provider) is employed, (see EUT setup photographs for more detail).

Emissions between 30 MHz and 1 GHz are measured using calibrated broadband antennas. Emissions below 30 MHz are characterized using a calibrated loop antenna. Pre-amplifiers and filters are used where required. Care is taken to ensure that test receiver resolution bandwidth, video bandwidth and detector type(s) meet the regulatory requirements.

For both horizontal and vertical polarizations, the EUT is then rotated through 360 degrees in azimuth until the highest emission is detected. At the previously determined azimuth the test antenna is raised and lowered from 1 to 4 m in height until a maximum emission level is detected, this maximum value is recorded.

Power values measured on the test receiver / analyzer are converted to field strength, FS, in dB μ V/m at the regulatory distance, using:

$$FS = PR + CL + AF - PA + DC - CF$$

Where,

PR is the power recorded on the receiver / spectrum analyzer in dB μ V;

CL is the cable loss in dB;

AF is the test antenna factor in dB/m;

PA is the pre-amplifier gain in dB (where used);

DC is the duty correction factor in dB (where used, e.g. harmonics of pulsed fundamental);

CF is the distance factor in dB (where measurement distance different to limit distance);

This field strength value is then compared with the regulatory limit.

Figure i Test Setup

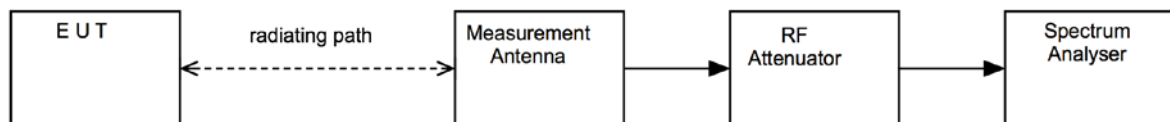

11.5 Test Set-up Photograph



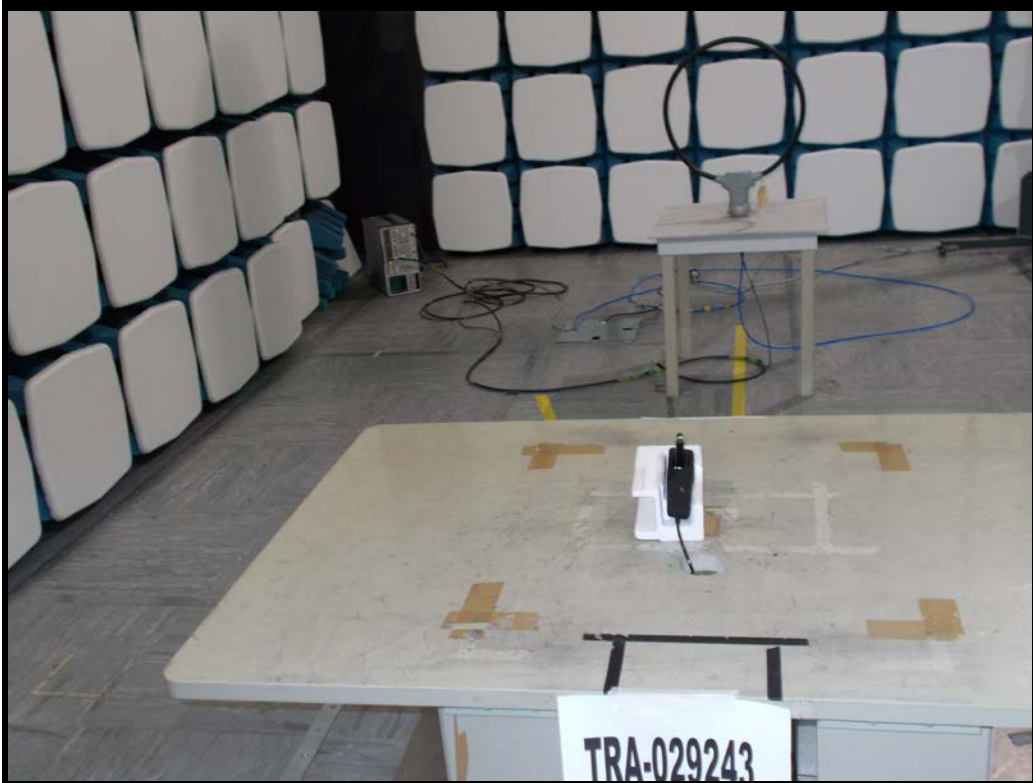
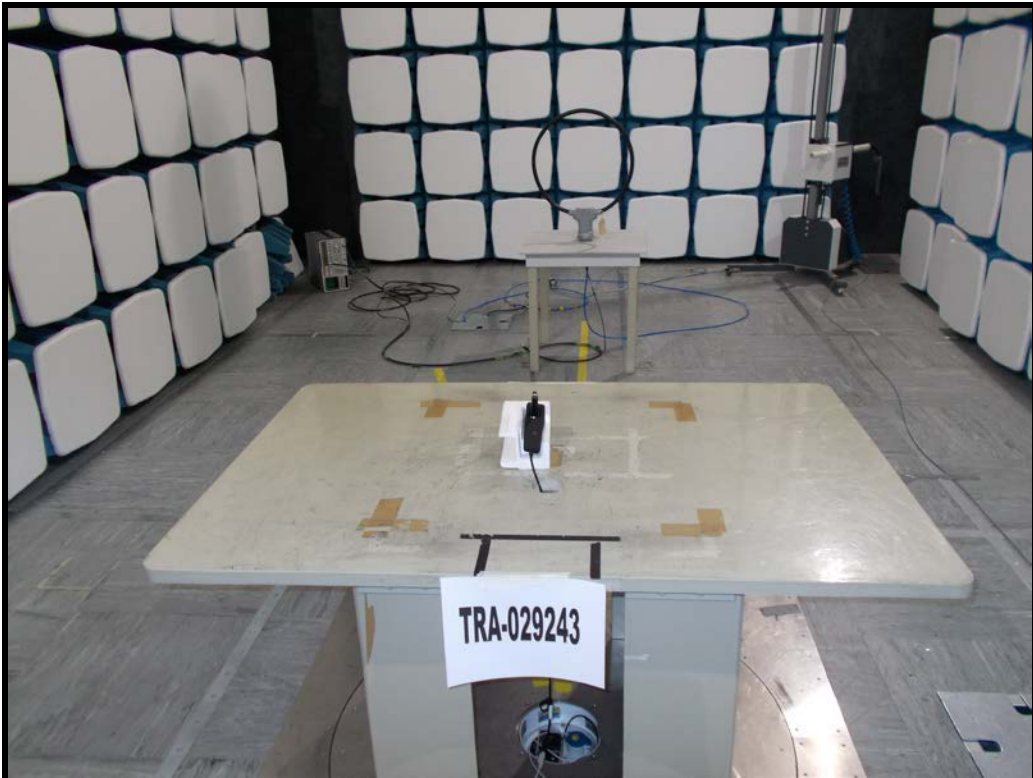

11.6 Test Equipment

Equipment		Equipment	Element	Due For
Type	Manufacturer	Description	No	Calibration
3109	EMCO	Biconical Antenna	RFG095	09/05/2016
3146	EMCO	Log Periodic Antenna	RFG191	09/05/2016
HFH2-Z2	R & S	Active Loop Antenna	RFG023	01/12/2017
		N-Type RF coaxial cable	REF881	06/10/2015
		N-Type RF coaxial cable	REF882	06/10/2015
		N-Type RF coaxial cable	REF884	06/10/2015
		N-Type RF coaxial cable	REF885	06/10/2015
ATS	Rainford	Ferrite Lined Chamber	REF886	21/07/2016
FSU46	R&S	Spectrum Analyser	REF910	28/05/2016

11.7 Test Results

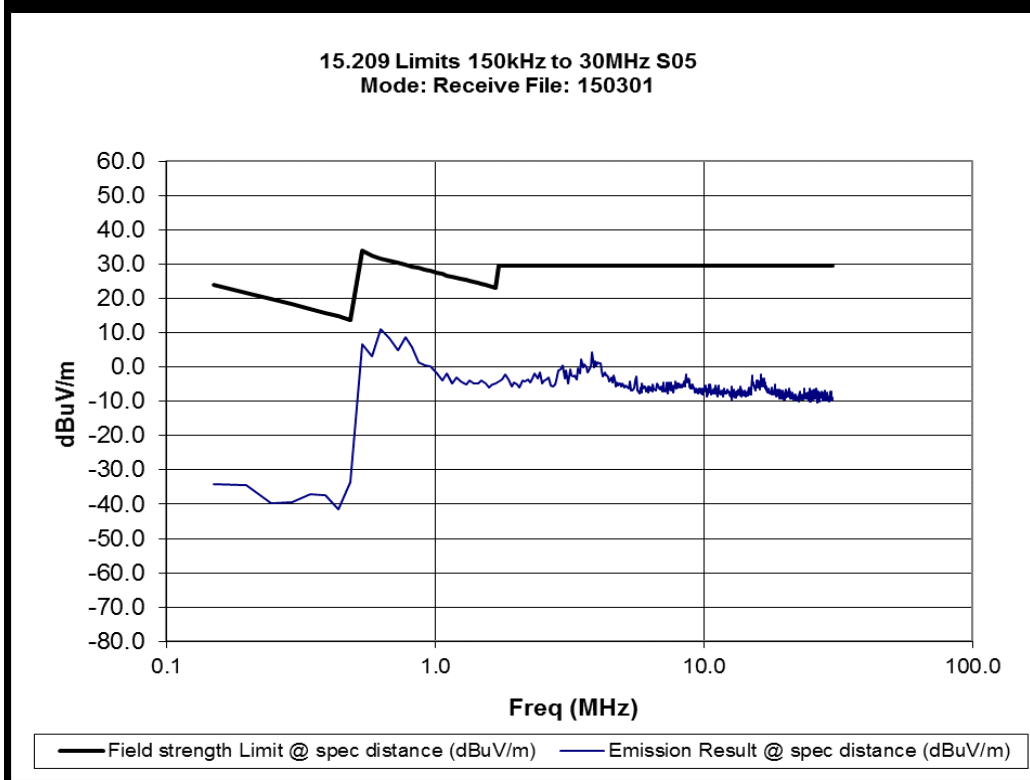
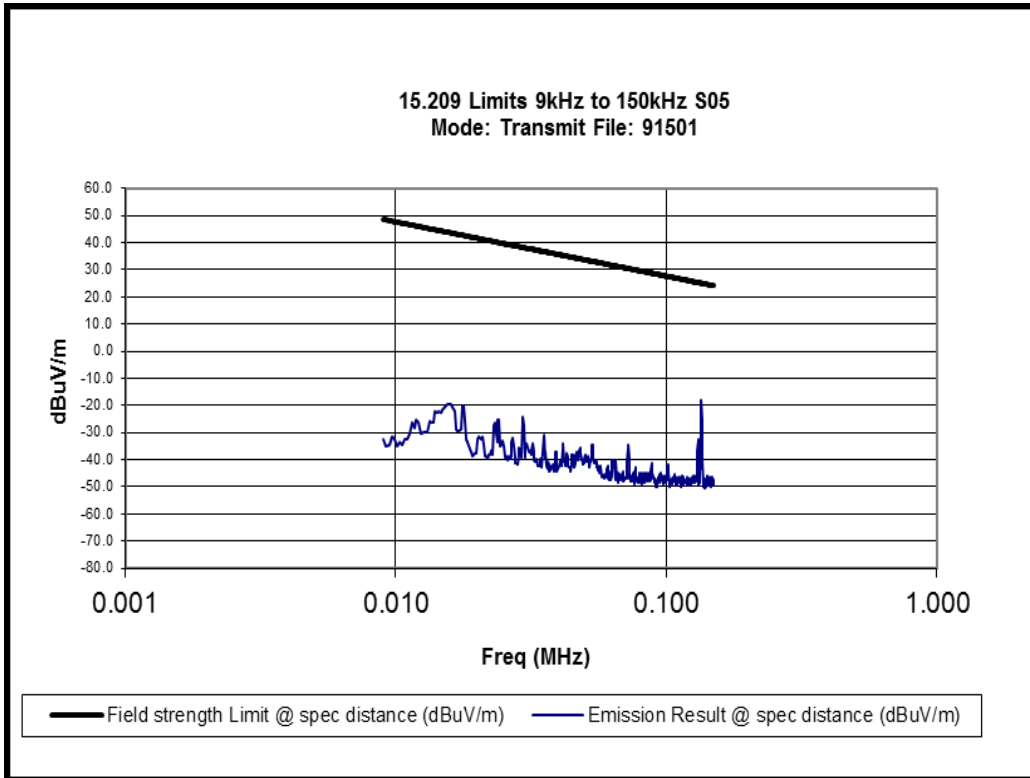

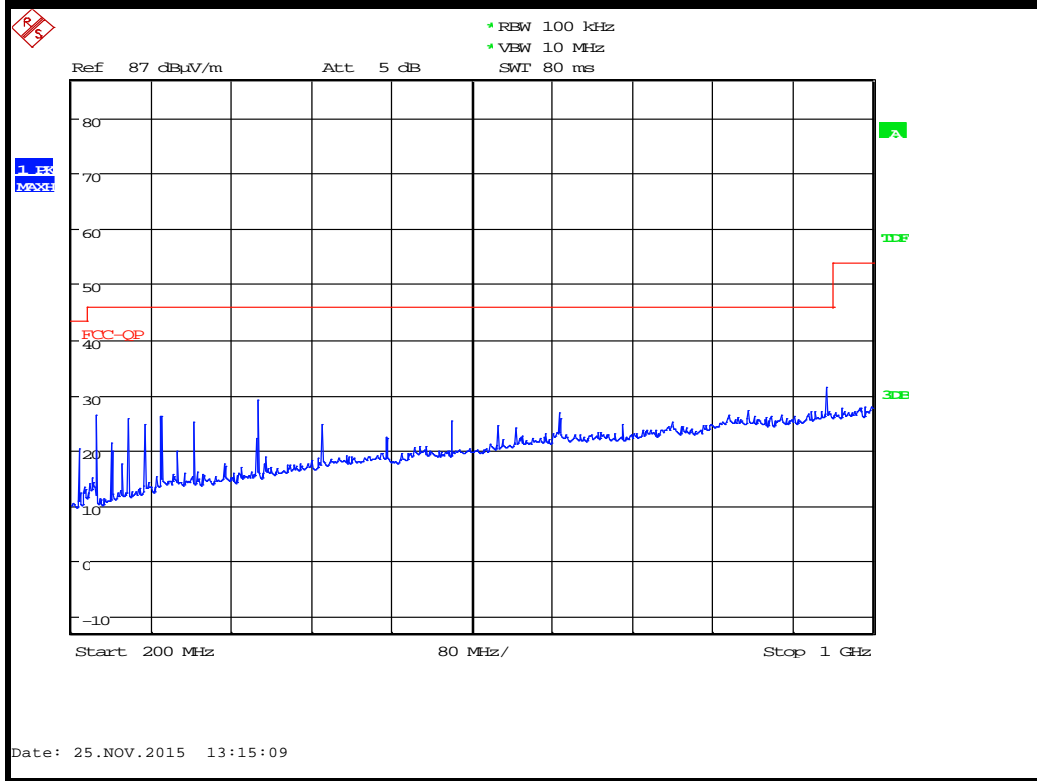
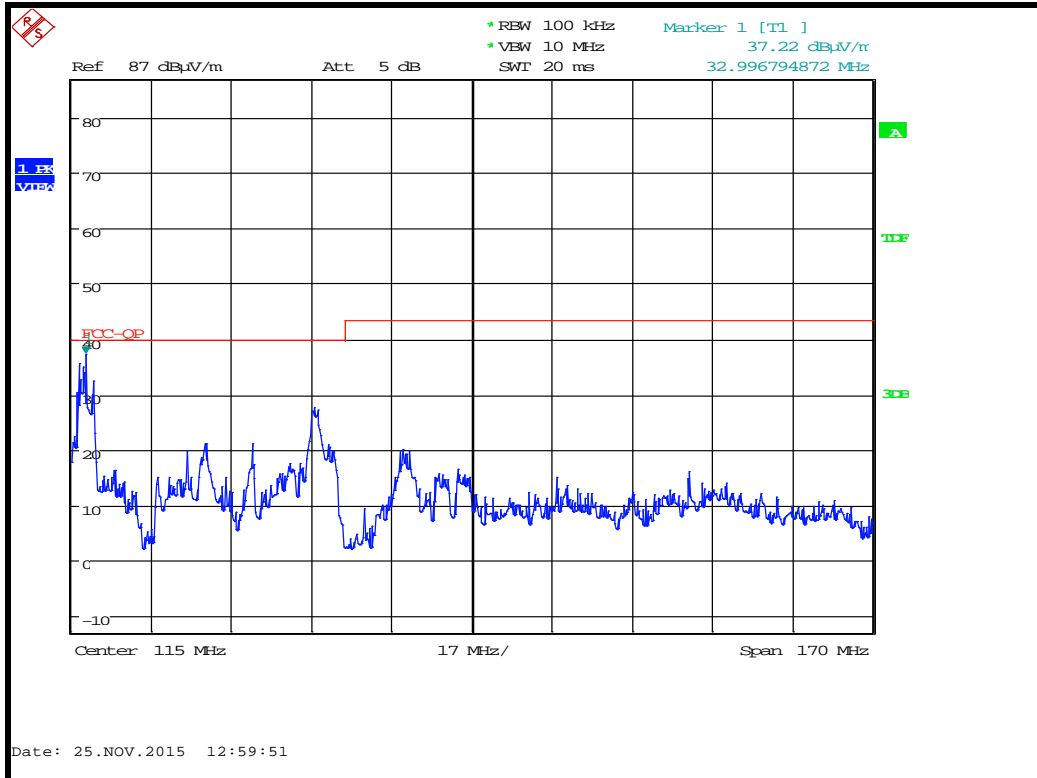

Channel: 0.125 MHz										
Detector	Freq. (MHz)	Meas'd Emission (dBμV)	Cable Loss (dB)	Antenna Factor (dB/m)	Pre-amp Gain (dB)	Duty Cycle Corr'n (dB)	Distance Extrap'n Factor (dB)	Field Strength (dBμV/m)	Field Strength (μV/m)	Limit (μV/m)
All emissions were a minimum of 20 dB below the test limit.										

12 AC power-line conducted emissions

There are no requirements for ac power line conducted emissions as the EUT is nominally powered by a vehicle supply and does not connect directly or indirectly to a public ac power supply.

13 Occupied Bandwidth

13.1 Definitions

Occupied bandwidth

The width of a frequency band such that, below the lower and above the upper frequency limits, the mean powers emitted are each equal to 0.5 % of the emitted power. This is also known as the *99 % emission bandwidth*. For transmitters in which there are multiple carriers, contiguous or non-contiguous in frequency, the occupied bandwidth is to be the sum of the occupied bandwidths of the individual carriers.

20 dB bandwidth

The emission bandwidth (20 dB) is defined as the frequency range between two points, one above and one below the carrier frequency, at which the spectral density of the emission is attenuated 20 dB below the maximum in-band spectral density of the modulated signal.

13.2 Test Parameters

Test Location:	Element Hull
Test Chamber:	Lab 4
Test Standard and Clause:	ANSI C63.10-2013, Clause 6.9
EUT Channels / Frequencies Measured:	125 kHz (Single Frequency)
EUT Channel Bandwidths:	N/A
EUT Test Modulations:	ASK
Deviations From Standard:	None
Measurement BW: (requirement: 1 % to 5 % OBW)	1 kHz
Spectrum Analyzer Video BW: (requirement at least 3x RBW)	3 kHz
Measurement Span: (requirement 2 to 5 times OBW)	50 kHz
Measurement Detector:	Peak

Environmental Conditions (Normal Environment)

Temperature: 22 °C	+15 °C to +35 °C (as declared)
Humidity: 44 % RH	20 % RH to 75 % RH (as declared)

13.3 Test Limit

Industry Canada:

If the frequency stability of the license-exempt radio apparatus is not specified in the applicable standard (RSS), measurement of the frequency stability is not required provided that the occupied bandwidth of the license-exempt radio apparatus lies entirely outside the restricted bands and the prohibited TV bands of 54 to 72 MHz, 76 to 88 MHz, 174 to 216 MHz, 470 to 608 MHz and 614 to 806 MHz.

Federal Communications Commission:

Intentional radiators operating under the alternative provisions to the general emission limits, as contained in §§ 15.217 through 15.257 and in subpart E of this part, must be designed to ensure that the 20 dB bandwidth of the emission, or whatever bandwidth may otherwise be specified in the specific rule section under which the equipment operates, is contained within the frequency band designated in the rule section under which the equipment is operated.

13.4 Test Method

With the EUT setup as per section 9 of this report and connected as per Figure iii, the bandwidth of the EUT was measured on a spectrum analyser.

The measurements were performed with EUT set at its maximum duty. All modulation schemes, data rates and power settings were used to observe the worst-case configuration in each bandwidth.

Figure iii Test Setup

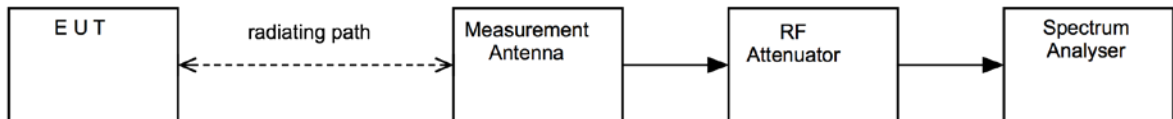

13.5 Test Equipment

Equipment		Equipment	Element	Due For
Type	Manufacturer	Description	No	Calibration
FSU46	R&S	Spectrum Analyser	REF910	28/05/2016
E4440A	Agilent	Spectrum Analyser	REF837	20/05/2016

13.6 Test Results

Modulation: ASK; Power setting: Max.				
Channel Frequency (MHz)	F_L (kHz)	F_H (kHz)	20 dB Bandwidth (kHz)	Result
125	130.528	139.743	9.215	PASS

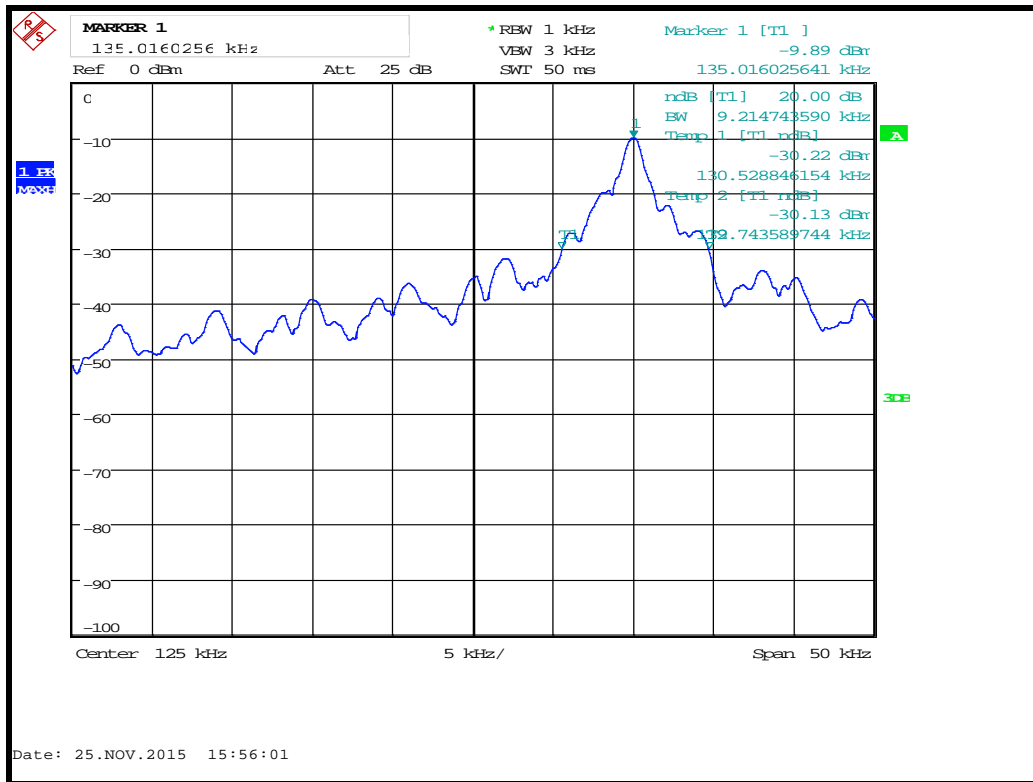

20 dB Bandwidth

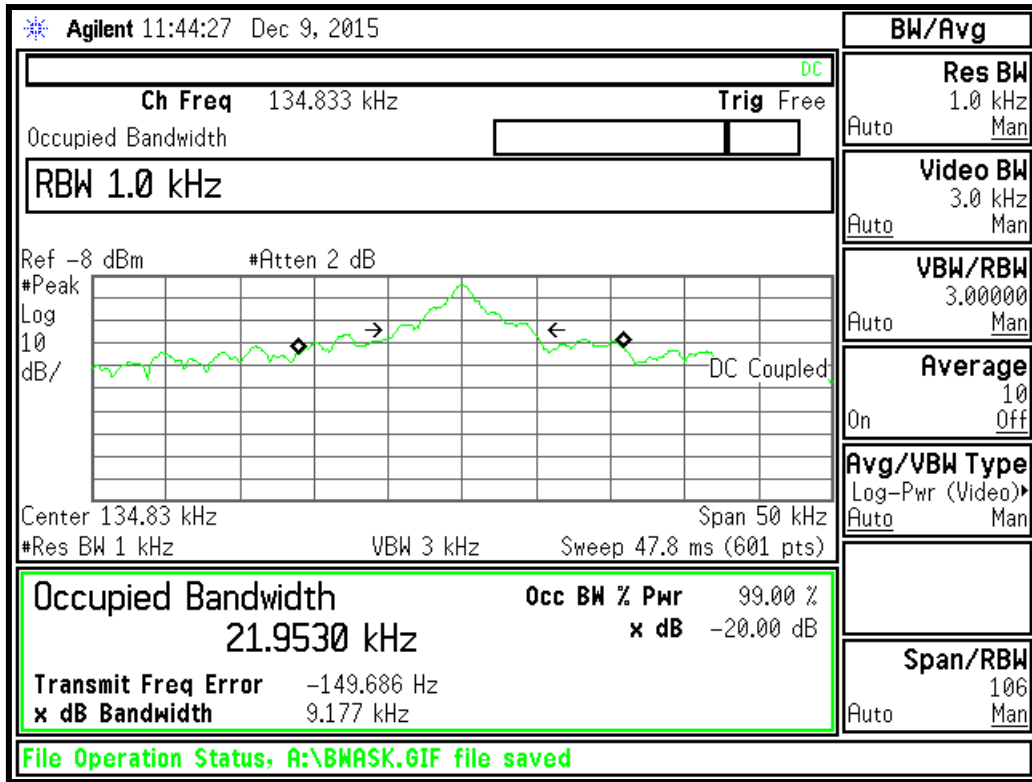

99% Bandwidth

14 Transmitter output power (fundamental radiated emission)

14.1 Definition

The RF power dissipated in the standard output termination when operating under the rated duty cycle selected by the applicant for approval.

14.2 Test Parameters

Test Location:	Element Hull
Test Chamber:	Lab 16
Test Standard and Clause:	ANSI C63.10-2013, Clause 6.5 / 6.6
EUT Channels / Frequencies Measured:	Low / Mid / High
EUT Channel Bandwidths:	N/A
Deviations From Standard:	None
Measurement BW:	200 Hz
Spectrum Analyzer Video BW: (requirement at least 3x RBW)	
Measurement Detector:	Up to 1 GHz: Quasi-peak Above 1 GHz: Average RMS and Peak
Voltage Extreme Environment Test Range:	Mains Power = 85 % and 115 % of Nominal (FCC only requirement); Battery Power = new battery.

Environmental Conditions (Normal Environment)

Temperature: 21 °C	+15 °C to +35 °C (as declared)
Humidity: 48 % RH	20 % RH to 75 % RH (as declared)

14.3 Test Limit

The field strength measured at 3 metres shall not exceed the limits in the following table:

Field Strength Limits for License-Exempt Transmitters for Any Application

<i>Fundamental frequency (MHz)</i>	<i>Field strength (µV/m at 3 m)</i>	<i>Detector</i>
0.125	19.3	Average RMS

n.b. per FCC 47CFR15C 15.209 / RSS-Gen spurious emissions limit.

14.4 Test Method

With the EUT setup as per section 9 of this report and connected as per Figure iv, the resolution bandwidth of the spectrum analyser was increased above the EUT occupied bandwidth and the peak emission data noted.

The measurements were performed with EUT set at its maximum duty. All modulation schemes, data rates and power settings were used to observe the worst-case configuration in each bandwidth.

Figure iv Test Setup

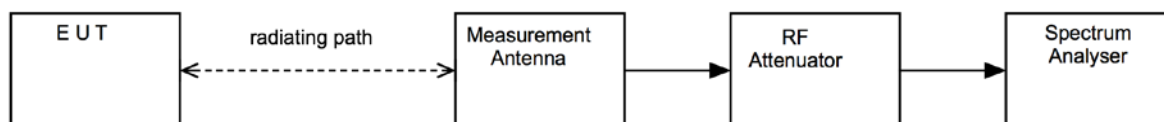

14.5 Test Equipment

Equipment		Equipment	Element	Due For
Type	Manufacturer	Description	No	Calibration
HFH2-Z2	R & S	Active Loop Antenna	RFG023	01/12/2017
		N-Type RF coaxial cable	REF881	06/10/2015
		N-Type RF coaxial cable	REF882	06/10/2015
		N-Type RF coaxial cable	REF884	06/10/2015
		N-Type RF coaxial cable	REF885	06/10/2015
ATS	Rainford	Ferrite Lined Chamber	REF886	21/07/2016
FSU46	R&S	Spectrum Analyser	REF910	28/05/2016

14.6 Test Results

Modulation: ASK							
Channel Frequency (MHz)	Meas'd Emission (dBμV)	Cable Loss (dB)	Antenna Factor (dB/m)	Pre-amp Gain (dB)	Field Strength (dBμV/m)	Distance Extrap'n Factor (dB)	Field Strength (μV/m)
0.125	41.9	0.5	20.0	0.0	62.4	-80.0	0.02

15 Duty Cycle

No duty cycle correction was used as the fundamental carrier level was greater than 20 dB below the average spurious limit when measured with a peak detector.

16 Measurement Uncertainty

Calculated Measurement Uncertainties

All statements of uncertainty are expanded standard uncertainty using a coverage factor of 1.96 to give a 95 % confidence:

[1] Carrier power

Uncertainty in test result (Power Meter) = **1.08 dB**

Uncertainty in test result (Spectrum Analyser) = **2.48 dB**

[2] Spurious emissions

Uncertainty in test result (30 MHz to 1 GHz) = **4.6 dB**

Uncertainty in test result (1 GHz to 18 GHz) = **4.7 dB**

[3] AC power line conducted emissions

Uncertainty in test result = **3.4 dB**

[4] Occupied bandwidth

Uncertainty in test result = **15.5 %**

[5] Maximum frequency error

Uncertainty in test result (Power Meter) = **0.113 ppm**

Uncertainty in test result (Spectrum Analyser) = **0.265 ppm**

[6] Duty cycle

Uncertainty in test result = **7.98 %**

17 RF Exposure

No RF exposure calculation is required due to the fundamental frequency of operation and the fact the carrier power was greater than 20 dB below the spurious limit.