



FCC RADIO TEST REPORT

FCC ID: 2AGOV-ASD116

Product:	PS3 Bluetooth Headset
Trade Name:	I-CON, Biogenik
Model Number:	ASD116, WL009
Report No.:	POCE15072231NRRF

Prepared for

ShenZhen Sen Mai Technology Limited
6/F, Bldg A, HuiDong Industry Zone, JiuWei, XiXiang Town, BaoAn Dist., ShenZhen, GuangDong, 518126, China

Prepared by

Shenzhen POCE Technology Co.,Ltd.
Room 502, Bldg. 1, Xinghua Garden, Baoan Road Xixiang, Baoan District, Shenzhen, China

TEST RESULT CERTIFICATION	
Applicant's name	ShenZhen Sen Mai Technology Limited
Address.....	6/F, Bldg A, HuiDong Industry Zone, JiuWei, XiXiang Town, BaoAn Dist., ShenZhen, Gu angDong, 518126, China
Manufacture's Name	ShenZhen Sen Mai Technology Limited
Address.....	6/F, Bldg A, HuiDong Industry Zone, JiuWei, XiXiang Town, BaoAn Dist., ShenZhen, Gu angDong, 518126, China
Product description	
Product name	PS3 Bluetooth Headset
Model and/or type reference	ASD116, WL009
Ratings	DC 3.7V from battery
Standards	FCC Part15.249
Test procedure.....	ANSI C63.10-2010
<p>This device described above has been tested by POCE, and the test results show that the equipment under test (EUT) is in compliance with the FCC requirements. And it is applicable only to the tested sample identified in the report.</p> <p>This report shall not be reproduced except in full, without the written approval of POCE, this document may be altered or revised by POCE, personal only, and shall be noted in the revision of the document.</p>	
Date of Test	
Date (s) of performance of tests.....	Nov..12, 2015 ~ Nov. 23, 2015
Date of Issue	Nov..23, 2015
Test Result	Pass...

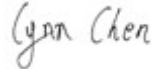
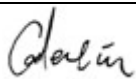
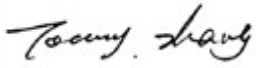
Testing Engineer	:	
		(Lynn Chen)
Technical Manager	:	
		(Carlen Liu)
Authorized Signatory	:	
		(Tommy zhang)

The test report merely corresponds to the test sample.
 It is not permitted to copy extracts of these test result without the written permission of the test laboratory.

Contents

1.	<u>TEST STANDARDS</u>	<u>4</u>
2.	<u>SUMMARY</u>	<u>5</u>
2.1.	Equipment Under Test	5
2.2.	Description of the Equipment under Test (EUT)	5
2.3.	EUT operation mode	6
2.4.	EUT configuration	6
2.5.	Related Submittal(s) / Grant (s)	6
2.6.	Modifications	6
3.	<u>TEST ENVIRONMENT</u>	<u>7</u>
3.1.	Address of the test laboratory	7
3.2.	Test Facility	7
3.3.	Environmental conditions	7
3.4.	Configuration of Tested System	7
3.5.	Statement of the measurement uncertainty	8
3.6.	Equipments Used during the Test	9
4.	<u>TEST CONDITIONS AND RESULTS</u>	<u>10</u>
4.1.	Conducted Emissions Test	10
4.2.	Transmitter Radiated Unwanted Emissions and Bandedge	14
4.3.	Occupied Bandwidth Measurement	20
5.	<u>ANTENNA REQUIREMENT</u>	<u>24</u>
6.	<u>TEST SETUP PHOTOS OF THE EUT</u>	<u>25</u>
7.	<u>EXTERNAL AND INTERNAL PHOTOS OF THE EUT</u>	<u>26</u>

1. TEST STANDARDS

The tests were performed according to following standards:

[FCC Rules Part 15.249](#): Operation within the bands 902 - 928 MHz, 2400 - 2483.5 MHz, 5725 - 5875 MHz, and 24.0 - 24.25 GHz.

[ANSI C63.10-2013](#)

[ANSI C63.4-2014](#)

2. SUMMARY

2.1. Equipment Under Test

Power supply system utilised

Power supply voltage : 120V / 60 Hz 115V / 60Hz
 12 V DC 24 V DC
 Other (specified in blank below)

DC 3.7V from battery

2.2. Description of the Equipment under Test (EUT)

The EUT (PS3 Bluetooth Headset) support Bluetooth function.

Name of EUT	PS3 Bluetooth Headset
Model Number	ASD116
Antenna Type	Internal
BT CE Operation frequency	2402MHz-2480MHz
BT Modulation Type	GFSK,8DPSK, π /4DQPSK(BT V2.1+EDR)
Bluetooth	BT V2.1+EDR
Antenna Gain	0dBi

Channel List:

Channel	Frequency (MHz)	Channel	Frequency (MHz)	Channel	Frequency (MHz)
00	2402	27	2429	54	2456
01	2403	28	2430	55	2457
02	2404	29	2431	56	2458
03	2405	30	2432	57	2459
04	2406	31	2433	58	2460
05	2407	32	2434	59	2461
06	2408	33	2435	60	2462
07	2409	34	2436	61	2463
08	2410	35	2437	62	2464
09	2411	36	2438	63	2465
10	2412	37	2439	64	2466
11	2413	38	2440	65	2467
12	2414	39	2441	66	2468
13	2415	40	2442	67	2469
14	2416	41	2443	68	2470
15	2417	42	2444	69	2471
16	2418	43	2445	70	2472
17	2419	44	2446	71	2473
18	2420	45	2447	72	2474
19	2421	46	2448	73	2475
20	2422	47	2449	74	2476
21	2423	48	2450	75	2477
22	2424	49	2451	76	2478
23	2425	50	2452	77	2479
24	2426	51	2453	78	2480
25	2427	52	2454		
26	2428	53	2455		

For more details, refer to the user's manual of the EUT.

Serial number: Prototype

2.3. EUT operation mode

Test Mode(TM)	Description	Remark
TM1	Bottom Channel Transmitting	/
TM2	Middle Channel Transmitting	/
TM3	Top Channel Transmitting	/
TM4	Charging and keeping TX	power by USB

The field strength of radiation emission was measured in the following position: EUT stand-up position (Y axis), lie-down position (X, Z axis).

The following data show only with the worst case setup.

The worst case of Y axis was reported.

Based on client request, all normal using modes of the normal function were tested but only the worst test data(GFSK) of the worst mode is reported by this report.

Remark: The worst case mode is TM1(1Mbps) reported for unwanted emission and band edge test.

2.4. EUT configuration

The following peripheral devices and interface cables were connected during the measurement:

○ - supplied by the manufacturer

● - supplied by the lab

● Notebook PC

Manufacturer: ACER

Model: V3-572G-59TB

2.5. Related Submittal(s) / Grant (s)

This submittal(s) (test report) is intended for FCC ID: 2AGOV-ASD116 filing to comply with Section 15.249 of the FCC Part 15, Subpart C Rules.

2.6. Modifications

No modifications were implemented to meet testing criteria.

3. TEST ENVIRONMENT

3.1. Address of the test laboratory

Shenzhen POCE Technology Co.,Ltd.

Room 502, Bldg. 1, Xinghua Garden, Baoan Road Xixiang, Baoan District, Shenzhen, China

There is one 3m semi-anechoic chamber and two line conducted labs for final test. The Test Sites meet the requirements in documents ANSI C63.10 and CISPR 22/EN 55022 requirements

3.2. Test Facility

The test facility is recognized, certified, or accredited by the following organizations:

FCC-Registration No.: 222278

Shenzhen POCE Technology Co.,Ltd. EMC Laboratory has been registered and fully described in a report filed with the (FCC) Federal Communications Commission. The acceptance letter from the FCC is maintained in our files. Registration 222278.

3.3. Environmental conditions

During the measurement the environmental conditions were within the listed ranges:

Temperature: 15-35 ° C

Humidity: 30-60 %

Atmospheric pressure: 950-1050mbar

3.4. Configuration of Tested System

Fig. 2-1 Configuration of Tested System

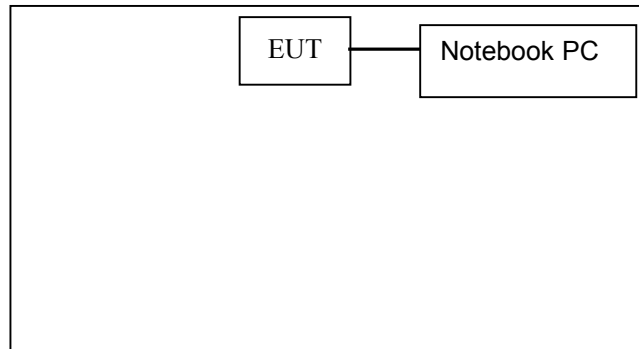

3.5. Statement of the measurement uncertainty

The reported uncertainty of measurement $y \pm U$, where expanded uncertainty U is based on a standard uncertainty multiplied by a coverage factor of $k=2$, providing a level of confidence of approximately **95 %**.

No.	Item	Uncertainty
1	Conducted Emission Test	$\pm 1.38\text{dB}$
2	RF power,conducted	$\pm 0.16\text{dB}$
3	Spurious emissions,conducted	$\pm 0.21\text{dB}$
4	All emissions,radiated(<1G)	$\pm 4.68\text{dB}$
5	All emissions,radiated(>1G)	$\pm 4.89\text{dB}$
6	Temperature	$\pm 0.5^{\circ}\text{C}$
7	Humidity	$\pm 2\%$

3.6. Equipments Used during the Test

Item	Kind of Equipment	Manufacturer	Type No.	Serial No.	Calibration Date
1	Spectrum Analyzer	Agilent	E4407B	160400005	Jul. 12. 2015
2	Test Receiver	R&S	ESPI	101318	Jul. 12. 2015
3	Bilog Antenna	TESEQ	CBL6111D	31216	Oct. 16. 2015
4	50Ω Coaxial Switch	Anritsu	MP59B	6200264416	Jul. 06. 2015
5	Spectrum Analyzer	ADVANTEST	R3132	150900201	Jul. 06. 2015
6	Horn Antenna	EM	EM-AH-10180	2011071402	Oct. 16. 2015
7	Horn Ant	Schwarzbeck	BBHA 9170	9170-181	Oct. 16. 2015
8	Amplifier	EM	EM-30180	060538	Jul. 12. 2015
9	Loop Antenna	ARA	PLA-1030/B	1029	Oct. 16. 2015
10	Power Meter	R&S	NRVS	100696	Jul. 06. 2015
11	Test Receiver	R&S	ESCI	101160	Jul. 12. 2015
12	LISN	R&S	ENV216	101313	Jul. 06. 2015
13	LISN	EMCO	3816/2	00042990	Jul. 06. 2015
14	50Ω Coaxial Switch	Anritsu	MP59B	6200264417	Jul. 06. 2015
15	Passive Voltage Probe	R&S	ESH2-Z3	100196	Jul. 06. 2015
16	Absorbing clamp	R&S	MOS-21	100423	Jul. 06. 2015
17	The temporary antenna connector	MMCX - SMA	1547	23657478	Jul. 06. 2015
18	RF Cable(1-25GHz)	HUBER+SUHNER	RG214	N/A	Jul. 06. 2015
19	RF Cable(0-1GHz)	HUBER+SUHNER	RG174	N/A	Jul. 06. 2015

Note:1.The temporary antenna connector is soldered on the PCB board in order to perform conducted tests and this temporary antenna connector is listed in the equipment list.
2. The Cal. Due is 1 year.

4. TEST CONDITIONS AND RESULTS

4.1. Conducted Emissions Test

TEST CONFIGURATION

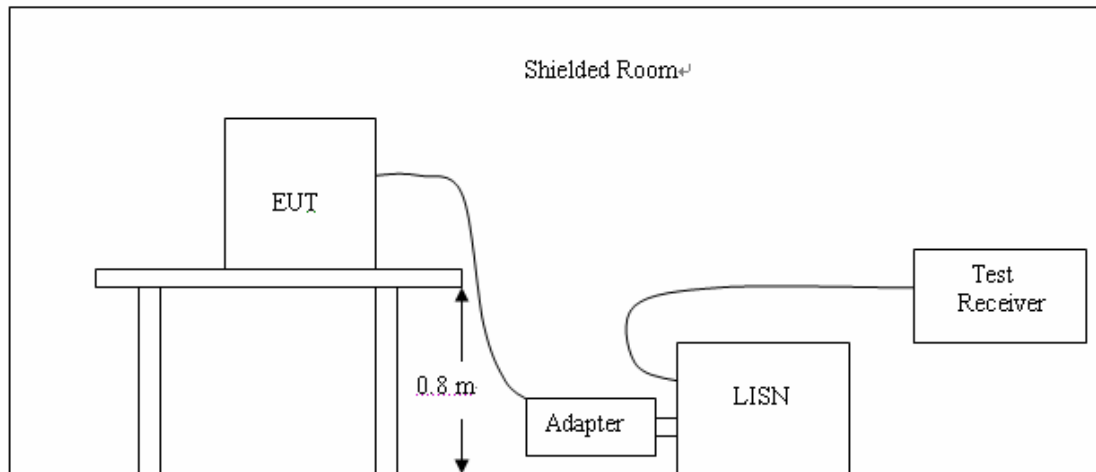

TEST PROCEDURE

1 The equipment was set up as per the test configuration to simulate typical actual usage per the user's manual. The EUT is a tabletop system, a wooden table with a height of 0.8 meters is used and is placed on the ground plane as per ANSI C63.10.

2 Support equipment, if needed, was placed as per ANSI C63.10.

3 All I/O cables were positioned to simulate typical actual usage as per ANSI C63.10.

4 If a EUT received DC power from the USB Port of Notebook PC, the PC's adapter received AC120V/60Hz power through a Line Impedance Stabilization Network (LISN) which supplied power source and was grounded to the ground plane.

5 All support equipments received AC power from a second LISN, if any.

6 The EUT test program was started. Emissions were measured on each current carrying line of the EUT using a spectrum Analyzer / Receiver connected to the LISN powering the EUT. The LISN has two monitoring points: Line 1 (Hot Side) and Line 2 (Neutral Side). Two scans were taken: one with Line 1 connected to Analyzer / Receiver and Line 2 connected to a 50 ohm load; the second scan had Line 1 connected to a 50 ohm load and Line 2 connected to the Analyzer / Receiver.

7 Analyzer / Receiver scanned from 150 KHz to 30MHz for emissions in each of the test modes.

8 During the above scans, the emissions were maximized by cable manipulation.

The RBW/VBW for 150KHz to 30MHz: 9KHz

CONDUCTED POWER LINE EMISSION LIMIT

For unintentional device, according to § 15.207(a) Line Conducted Emission Limits is as following :

Frequency (MHz)	Maximum RF Line Voltage (dB μ V)			
	CLASS A		CLASS B	
	Q.P.	Ave.	Q.P.	Ave.
0.15 - 0.50	79	66	66-56*	56-46*
0.50 - 5.00	73	60	56	46
5.00 - 30.0	73	60	60	50

* Decreasing linearly with the logarithm of the frequency

For intentional device, according to §15.207(a) Line Conducted Emission Limit is same as above table.

TEST RESULTS

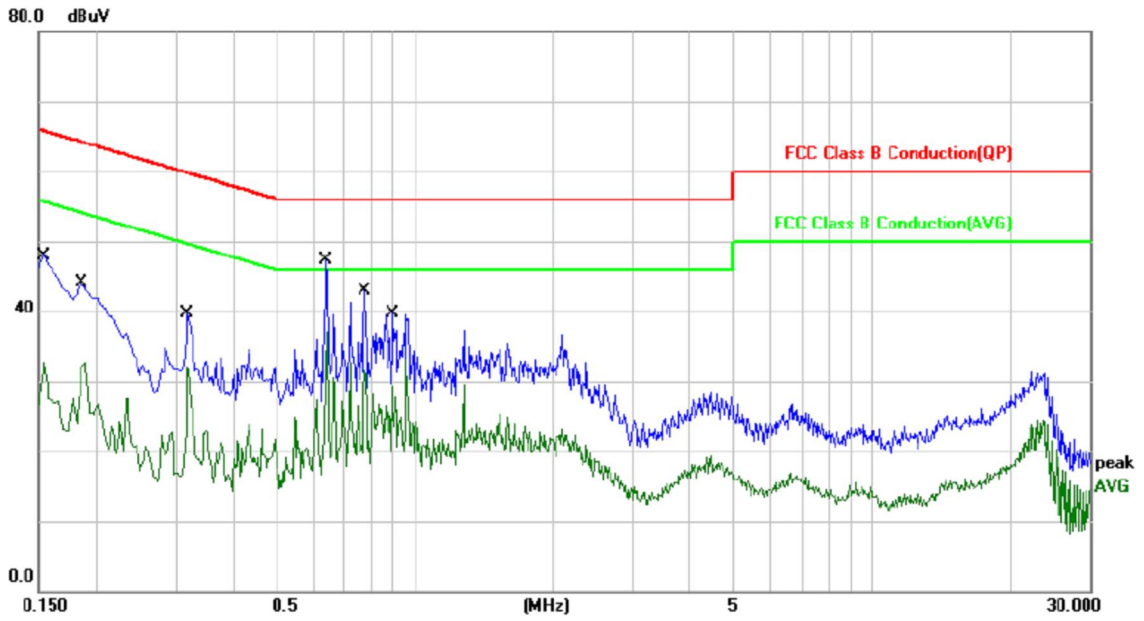

Site Chamber #1 Phase: **L1** Temperature: 25
 Limit: FCC Class B Conduction(QP) Power: DC 3.7V Humidity: 41 %
 EUT: PS3 Bluetooth
 M/N: ASD116
 Mode: charging
 Note:

No.	Mk.	Freq. MHz	Reading Level dBuV	Correct Factor dB	Measure- ment dBuV	Limit dBuV	Over dB	Detector	Comment
1		0.1501	42.33	9.87	52.20	65.99	-13.79	QP	
2		0.1501	26.32	9.87	36.19	55.99	-19.80	AVG	
3		0.1829	33.40	9.87	43.27	64.35	-21.08	QP	
4		0.1829	20.51	9.87	30.38	54.35	-23.97	AVG	
5		0.3186	28.49	9.99	38.48	59.74	-21.26	QP	
6		0.3186	20.09	9.99	30.08	49.74	-19.66	AVG	
7	*	0.6394	36.20	9.95	46.15	56.00	-9.85	QP	
8		0.6394	25.55	9.95	35.50	46.00	-10.50	AVG	
9		0.7768	30.04	9.93	39.97	56.00	-16.03	QP	
10		0.7768	20.36	9.93	30.29	46.00	-15.71	AVG	
11		0.8945	23.51	9.90	33.41	56.00	-22.59	QP	
12		0.8945	17.11	9.90	27.01	46.00	-18.99	AVG	

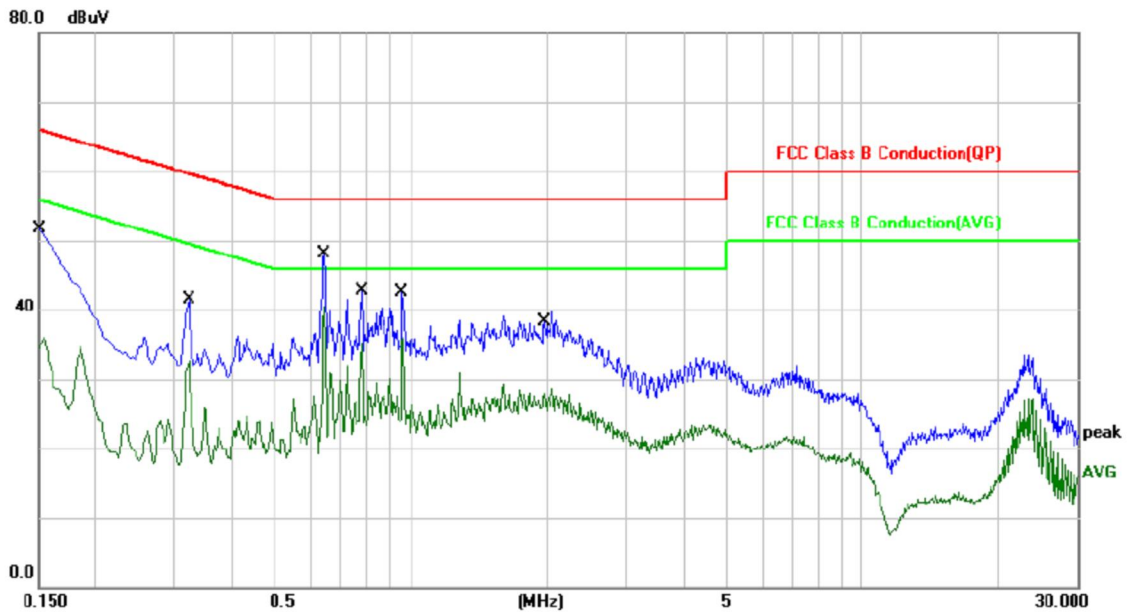

Site Chamber #1 Phase: **N** Temperature: 25
 Limit: FCC Class B Conduction(QP) Power: DC 3.7V Humidity: 41 %
 EUT: PS3 Bluetooth
 M/N: ASD116
 Mode: charging
 Note:

No.	Mk.	Freq. MHz	Reading Level dBuV	Correct Factor dB	Measure- ment dBuV	Limit dBuV	Over dB	Detector	Comment
1		0.1477	45.35	10.17	55.52	66.12	-10.60	QP	
2		0.1477	25.33	10.17	35.50	56.12	-20.62	AVG	
3		0.3215	28.14	10.31	38.45	59.67	-21.22	QP	
4		0.3215	20.04	10.31	30.35	49.67	-19.32	AVG	
5	*	0.6418	35.61	10.33	45.94	56.00	-10.06	QP	
6		0.6418	25.10	10.33	35.43	46.00	-10.57	AVG	
7		0.7783	31.17	10.32	41.49	56.00	-14.51	QP	
8		0.7783	21.54	10.32	31.86	46.00	-14.14	AVG	
9		0.9581	28.94	10.29	39.23	56.00	-16.77	QP	
10		0.9581	21.14	10.29	31.43	46.00	-14.57	AVG	
11		1.9805	23.28	10.16	33.44	56.00	-22.56	QP	
12		1.9805	14.55	10.16	24.71	46.00	-21.29	AVG	

4.2. Transmitter Radiated Unwanted Emissions and Bandedge

TEST CONFIGURATION

(A) Radiated Emission Test Set-Up, Frequency Below 30MHz

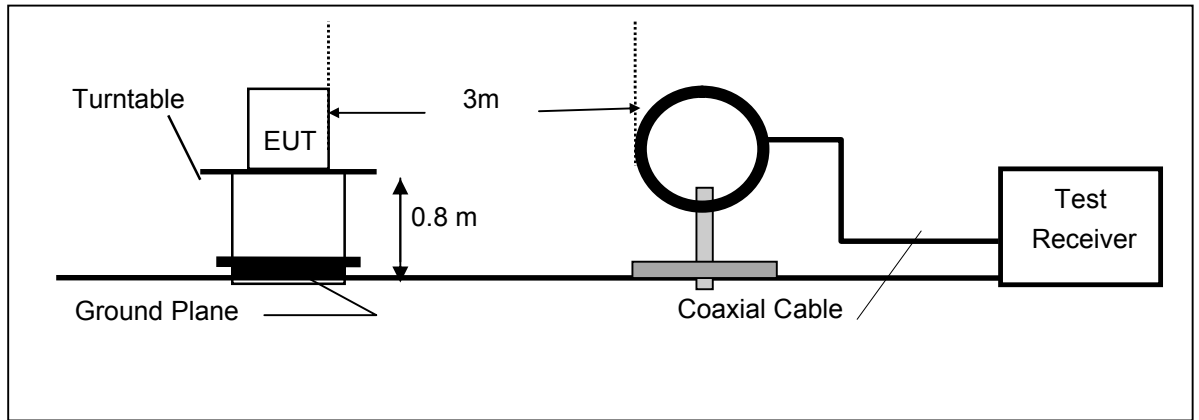

(B) Radiated Emission Test Set-Up, Frequency below 1000MHz

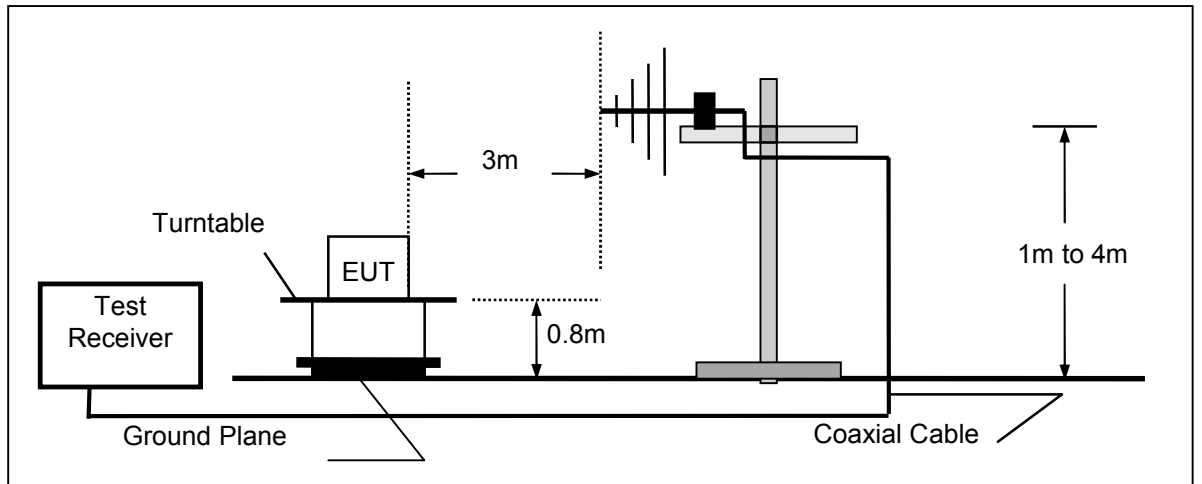

(C) Radiated Emission Test Set-Up, Frequency above 1000MHz

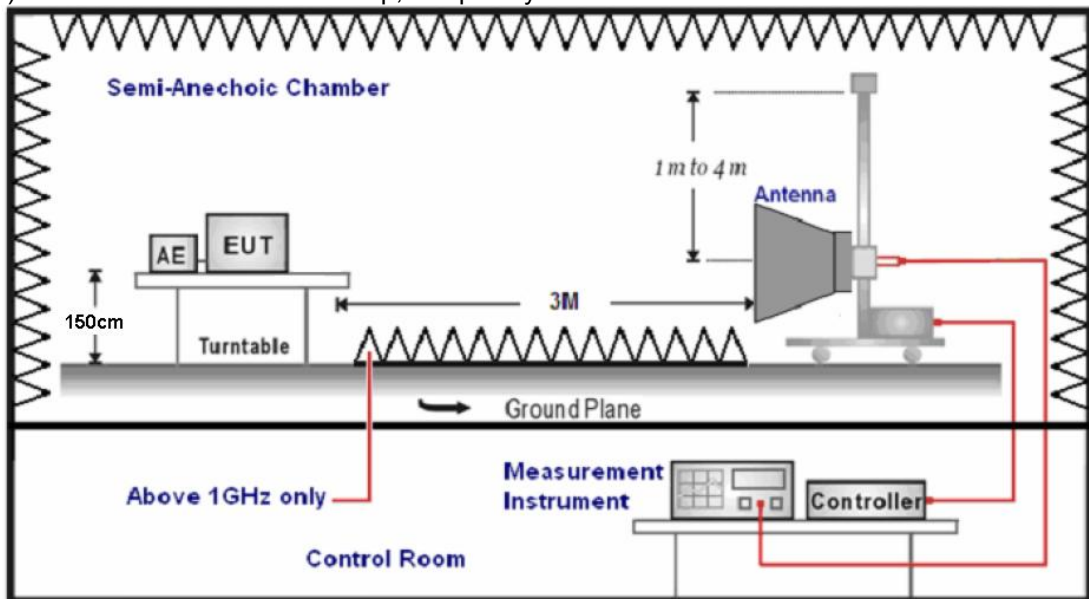

FIELD STRENGTH CALCULATION

The field strength is calculated by adding the Antenna Factor and Cable Factor and subtracting the Amplifier Gain and Duty Cycle Correction Factor(if any) from the measured reading. The basic equation with a sample calculation is as follows:

$$FS = RA + AF + CL - AG$$

Where FS = Field Strength	CL = Cable Attenuation Factor (Cable Loss)
RA = Reading Amplitude	AG = Amplifier Gain
AF = Antenna Factor	

RADIATION LIMIT

For unintentional device, according to § 15.209(a), except for Class A digital devices, the field strength of radiated emissions from unintentional radiators at a distance of 3 meters shall not exceed the following values:

Frequency (MHz)	Distance (Meters)	Radiated (dBµV/m)	Radiated (µV/m)
30-88	3	40.0	100
88-216	3	43.5	150
216-960	3	46.0	200
Above 960	3	54.0	500

For intentional device, according to § 15.209(a), the general requirement of field strength of radiated emissions from intentional radiators at a distance of 3 meters shall not exceed the above table.

TEST PROCEDURE

1. The EUT is placed on a turntable, which is 0.8m above ground plane below 1GHz and 1.5m above ground plane above 1GHz .
2. The turntable shall be rotated for 360 degrees to determine the position of maximum emission level.
3. EUT is set 3m away from the receiving antenna, which is varied from 1m to 4m to find out the highest emissions.
4. For the radiated emission test above 1GHz: Place the measurement antenna away from each area of the EUT determined to be a source of emissions at the specified measurement distance, while keeping the measurement antenna aimed at the source of emissions at each frequency of significant emissions, with polarization oriented for maximum response. The measurement antenna may have to be higher or lower than the EUT, depending on the radiation pattern of the emission and staying aimed at the emission source for receiving the maximum signal. The final measurement antenna elevation shall be that which maximizes the emissions. The measurement antenna elevation for maximum emissions shall be restricted to a range of heights of from 1 m to 4 m above the ground or reference ground plane.
5. Maximum procedure was performed on the six highest emissions to ensure EUT compliance.
6. And also, each emission was to be maximized by changing the polarization of receiving antenna both horizontal and vertical.
7. Repeat above procedures until the measurements for all frequencies are complete.
8. Based on the Frequency Generator in the device include 16MHz. The test frequency range from 9KHz to 25GHz per FCC PART 15.33(a).

Note:

Three axes are chosen for pretest, the Y axis is the worst mode for final test.

For battery operated equipment, the equipment tests shall be performed using a fully-charged battery.

TEST RESULTS

All the test modes (TM1, TM2, TM3) completed for test. The worst case of Radiated Emission is TM1; the test data of this mode was reported.

9KHz-30MHz:

Freq. (MHz)	Level (dBuV)	Over Limit (dB)	Limit Line (dBuV)	Remark
-	-	-	-	See Note

Note: The amplitude of spurious emissions that are attenuated by more than 20dB below the permissible value has no need to be reported.

Distance extrapolation factor= 40 log (specific distance/ test distance) (dB);
 Limit line= specific limits (dBuV) + distance extrapolation factor.

30-1000MHz:

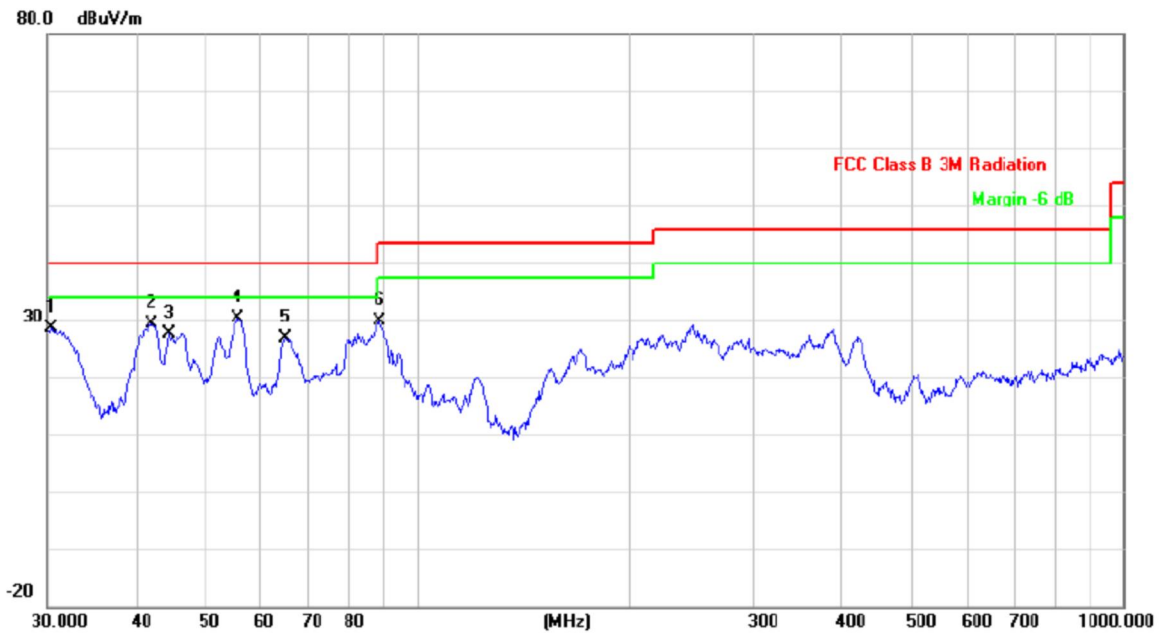

Site Chamber #1	Polarization: Vertical	Temperature:
Limit: FCC Class B 3M Radiation	Power:	Humidity: %
EUT:	Distance: 3m	
M/N:		
Mode:		
Note:		

No.	Mk.	Freq. MHz	Reading Level dBuV	Correct Factor dB/m	Measurement dBuV/m	Limit dBuV/m	Over dB	Detector	Antenna Height cm	Table Degree	Comment
1		30.3172	36.39	-7.77	28.62	40.00	-11.38	peak			
2		42.1542	44.75	-15.39	29.36	40.00	-10.64	peak			
3		44.5867	44.83	-17.15	27.68	40.00	-12.32	peak			
4	*	55.6094	51.27	-20.91	30.36	40.00	-9.64	peak			
5		65.1145	47.63	-20.64	26.99	40.00	-13.01	peak			
6		88.3421	50.79	-20.94	29.85	43.50	-13.65	peak			

Remark:

- (1) Measuring frequencies from 9 KHz to the 1 GHz, Radiated emission test from 9KHz to 30MHz was verified, and no any emission was found except system noise floor.
- (2) * denotes emission frequency which appearing within the Restricted Bands specified in provision of 15.205, then the general radiated emission limits in 15.209 apply.

- (3) The IF bandwidth of EMI Test Receiver between 30MHz to 1GHz was 120KHz, 1 MHz for measuring above 1 GHz, below 30MHz was 10KHz.



Site Chamber #1 Polarization: *Horizontal* Temperature:
 Limit: FCC Class B 3M Radiation Power: Humidity: %
 EUT: Distance: 3m
 M/N:
 Mode:
 Note:

No.	Mk.	Freq.	Reading Level	Correct Factor	Measurement	Limit	Over	Antenna Height	Table Degree	
		MHz	dBuV	dB/m	dBuV/m	dBuV/m	dB	cm	degree	Comment
1	*	84.7019	49.47	-20.95	28.52	40.00	-11.48			peak
2		120.6991	38.81	-16.03	22.78	43.50	-20.72			peak
3		147.9214	33.81	-13.56	20.25	43.50	-23.25			peak
4		209.3129	44.08	-16.43	27.65	43.50	-15.85			peak
5		385.2805	40.48	-11.24	29.24	46.00	-16.76			peak
6		419.1081	38.23	-10.12	28.11	46.00	-17.89			peak

Remark:

- (1) Measuring frequencies from 9 KHz to the 1 GHz, Radiated emission test from 9KHz to 30MHz was verified, and no any emission was found except system noise floor.
- (2) * denotes emission frequency which appearing within the Restricted Bands specified in provision of 15.205, then the general radiated emission limits in 15.209 apply.
- (3) The IF bandwidth of EMI Test Receiver between 30MHz to 1GHz was 120KHz, 1 MHz for measuring above 1 GHz, below 30MHz was 10KHz.

Above 1 GHz Test Results:

Note: Measurement worst emissions of receive antenna polarization: Vertical.

Frequency	Emission		Limit	Margin	Raw	Antenna Factor	Cable	Pre-amplifier	Correction
(MHz)	Level		(dBuV/m)	(dB)	Value	(dB/m)	Factor	(dB)	Factor
	(dBuV/m)				(dBuV)		(dB)		(dB/m)
2402.00	94.12	PK	114	19.88	96.08	28.78	4.61	35.36	-1.96
2402.00	85.05	AV	94	8.95	87.01	28.78	4.61	35.36	-1.96
2390.00	68.45	PK	74	5.55	70.49	28.72	4.60	35.36	-2.04
2390.00	47.22	AV	54	6.78	49.26	28.72	4.60	35.36	-2.04
2400.00	70.05	PK	74	3.95	72.02	28.78	4.61	35.36	-1.97
2400.00	49.17	AV	54	4.83	51.14	28.78	4.61	35.36	-1.97
4804.00	66.24	PK	74	7.76	61.73	33.49	6.91	35.89	4.51
4804.00	45.57	AV	54	8.43	41.06	33.49	6.91	35.89	4.51
6228.00	63.95	PK	74	10.05	55.52	35.19	7.94	34.70	8.43
6228.00	44.13	AV	54	9.87	35.70	35.19	7.94	34.70	8.43
7206.00	64.47	PK	74	9.53	53.36	36.95	9.18	35.03	11.11
7206.00	46.09	AV	54	7.91	34.98	36.95	9.18	35.03	11.11

Frequency	Emission		Limit	Margin	Raw	Antenna Factor	Cable	Pre-amplifier	Correction
(MHz)	Level		(dBuV/m)	(dB)	Value	(dB/m)	Factor	(dB)	Factor
	(dBuV/m)				(dBuV)		(dB)		(dB/m)
2441.00	93.92	PK	114	20.08	95.78	28.85	4.66	35.37	-1.86
2441.00	85.57	AV	94	8.43	87.43	28.85	4.66	35.37	-1.86
3200.00	64.42	PK	74	9.58	63.06	31.24	5.47	35.35	1.36
3200.00	43.31	AV	54	10.69	41.95	31.24	5.47	35.35	1.36
4051.00	62.99	PK	74	11.01	58.37	32.96	6.43	34.76	4.62
4051.00	43.38	AV	54	10.62	38.76	32.96	6.43	34.76	4.62
4882.00	66.71	PK	74	7.29	60.45	33.60	6.95	34.30	6.26
4882.00	47.14	AV	54	6.86	40.88	33.60	6.95	34.30	6.26
6001.00	64.31	PK	74	9.69	56.19	35.12	7.59	34.59	8.12
6001.00	46.58	AV	54	7.42	38.46	35.12	7.59	34.59	8.12
7323.00	67.93	PK	74	6.07	56.23	37.46	9.23	35.00	11.70
7323.00	46.25	AV	54	7.75	34.55	37.46	9.23	35.00	11.70

Frequency	Emission		Limit	Margin	Raw	Antenna Factor	Cable	Pre-amplifier	Correction
(MHz)	Level		(dBuV/m)	(dB)	Value	(dB/m)	Factor	(dB)	Factor
	(dBuV/m)				(dBuV)		(dB)		(dB/m)
2480.00	95.53	PK	114	18.47	97.28	28.92	4.70	35.38	-1.75
2480.00	84.26	AV	94	9.74	86.01	28.92	4.70	35.38	-1.75
2483.50	65.52	PK	74	8.48	67.26	28.93	4.70	35.38	-1.74
2483.50	44.32	AV	54	9.68	46.06	28.93	4.70	35.38	-1.74
3625.00	60.51	PK	74	13.49	57.99	32.18	5.97	35.63	2.52
3625.00	44.71	AV	54	9.29	42.19	32.18	5.97	35.63	2.52
4960.00	68.04	PK	74	5.96	61.34	33.84	7.00	34.14	6.70
4960.00	48.33	AV	54	5.67	41.63	33.84	7.00	34.14	6.70
6233.00	61.56	PK	74	12.44	53.12	35.19	7.95	34.70	8.44
6233.00	45.12	AV	54	8.88	36.68	35.19	7.95	34.70	8.44
7440.00	65.67	PK	74	8.33	53.72	37.64	9.28	34.97	11.95
7440.00	46.05	AV	54	7.95	34.10	37.64	9.28	34.97	11.95

Note: above 8GHz up to 25GHz was verified, and no any emission was found except system noise floor.

4.3. Occupied Bandwidth Measurement

Measurement Procedure

1. Set EUT as normal operation.
2. $RBW \geq 1\%$ of the 20 dB bandwidth, $VBW \geq RBW$.
3. The useful conducted emission from the EUT was detected by the spectrum analyser with peak detector.

Measurement Results

GFSK:

2402MHz

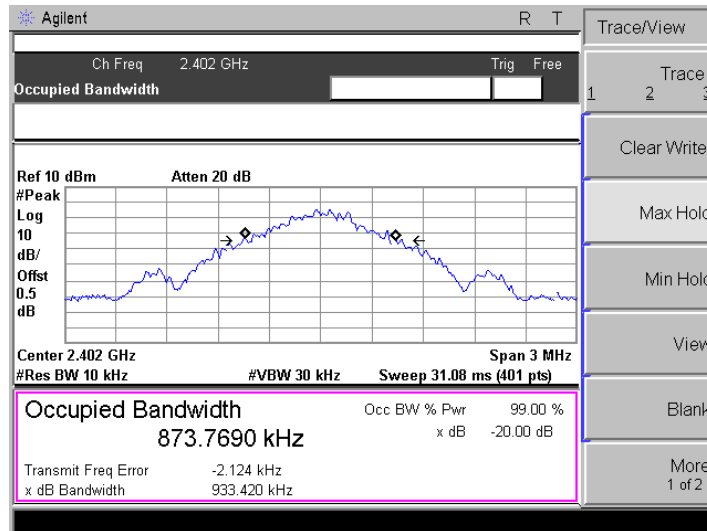

20dB Bandwidth: 933.420 KHz

2441MHz

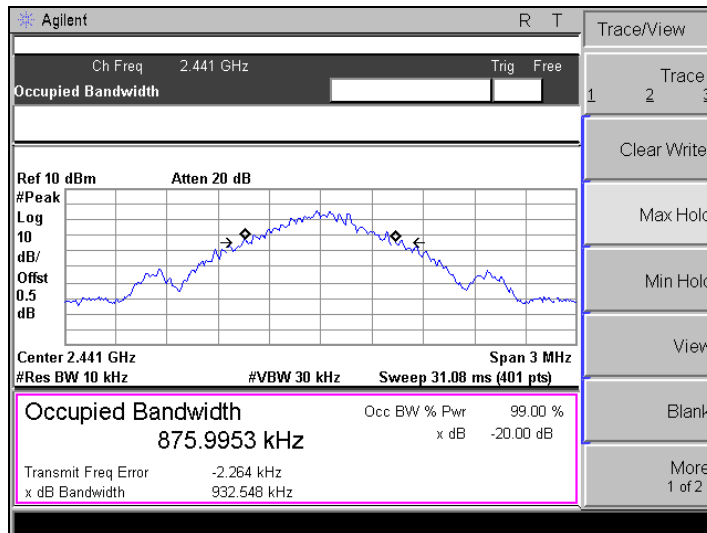

20dB Bandwidth: 932.548 KHz

2480MHz

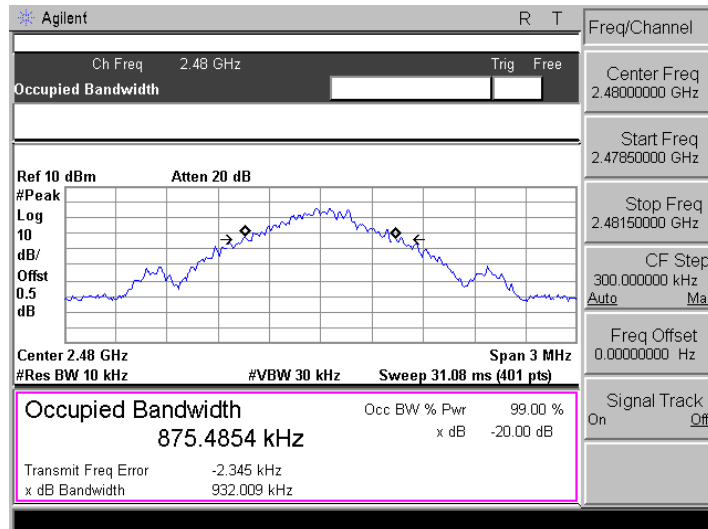

20dB Bandwidth: 932.009 KHz

π /4DQPSK mode:

2402MHz

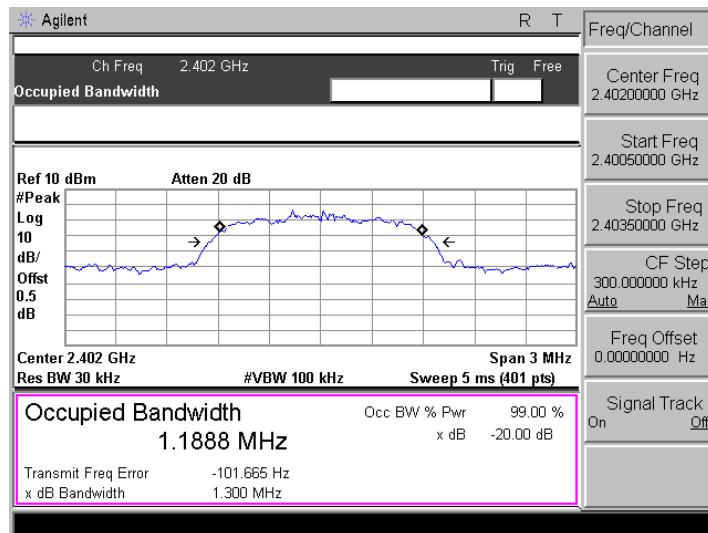

20dB Bandwidth: 1300 KHz

2441MHz

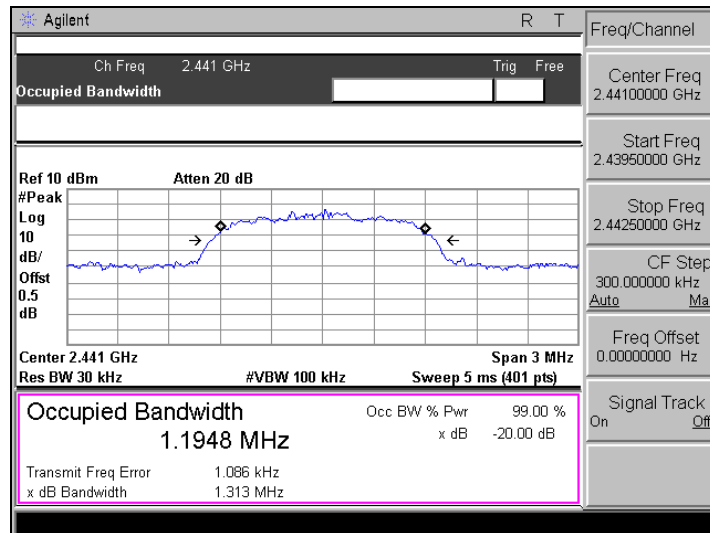

20dB Bandwidth: 1313 KHz

2480MHz

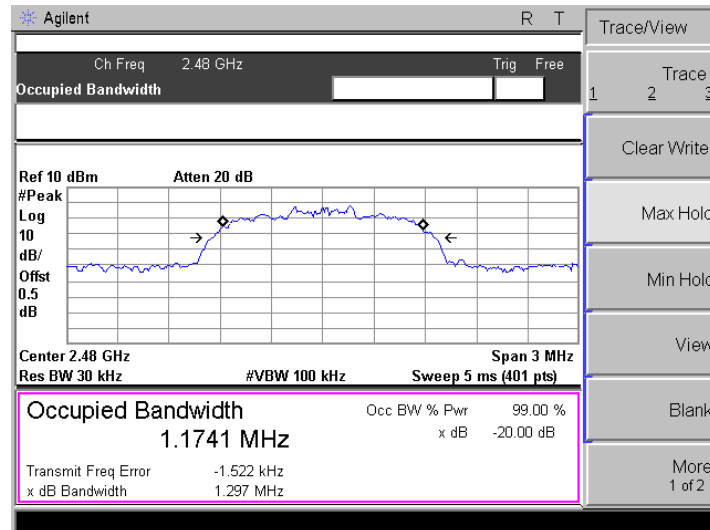

20dB Bandwidth: 1297 KHz

8DPSK mode:

2402MHz

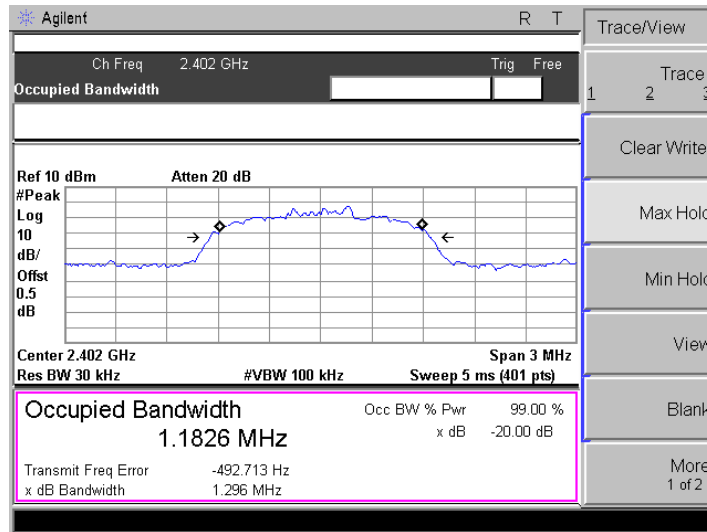

20dB Bandwidth: 1296 KHz

2441MHz

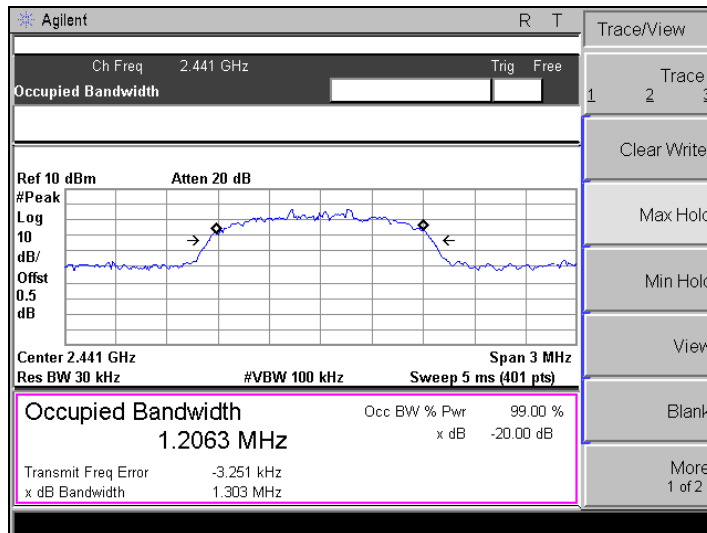

20dB Bandwidth: 1303 KHz

2480MHz

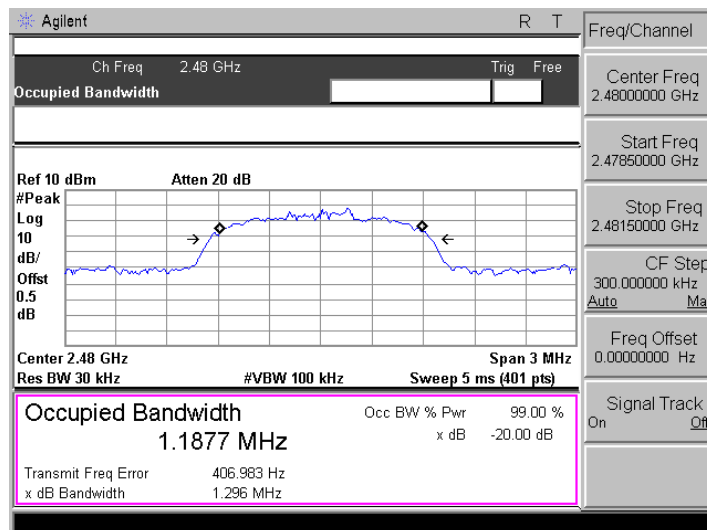

20dB Bandwidth: 1296 KHz

5. Antenna Requirement

Standard Applicable

For intentional device, according to FCC 47 CFR Section 15.203, an intentional radiator shall be designed to ensure that no antenna other than that furnished by the responsible party shall be used with the device.

And according to FCC 47 CFR Section 15.247 (c), if transmitting antennas of directional gain greater than 6dBi are used, the power shall be reduced by the amount in dB that the directional gain of the antenna exceeds 6dBi.

Refer to statement below for compliance.

The manufacturer may design the unit so that the user can replace a broken antenna, but the use of a standard antenna jack or electrical connector is prohibited. Further, this requirement does not apply to intentional radiators that must be professionally installed.

Antenna Connected Construction

The antenna used in this product is a PCB Antenna, The directional gains of antenna used for transmitting is 0 dBi.

6. Test Setup Photos of the EUT

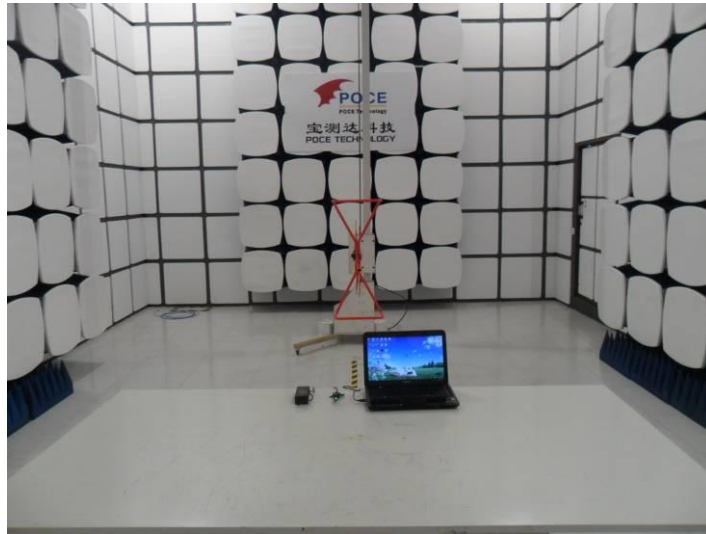

7. External and Internal Photos of the EUT

External Photos of EUT





Internal Photos of EUT

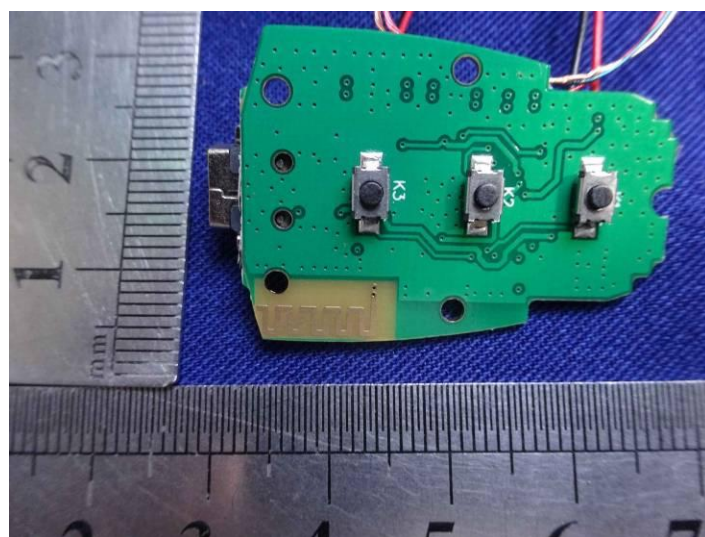
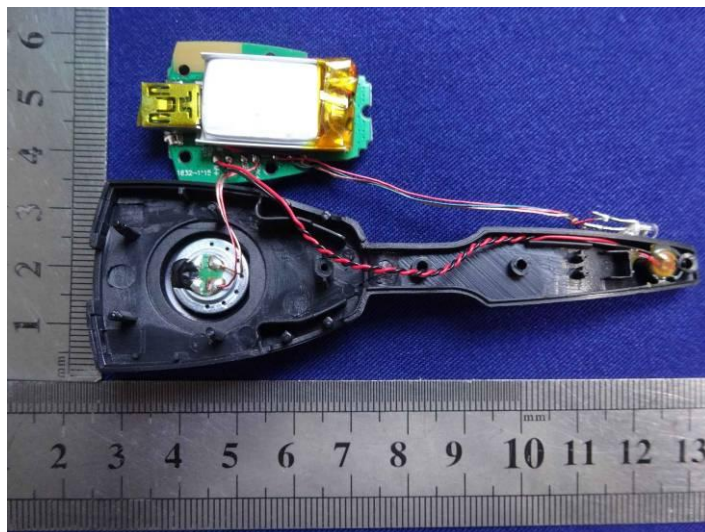
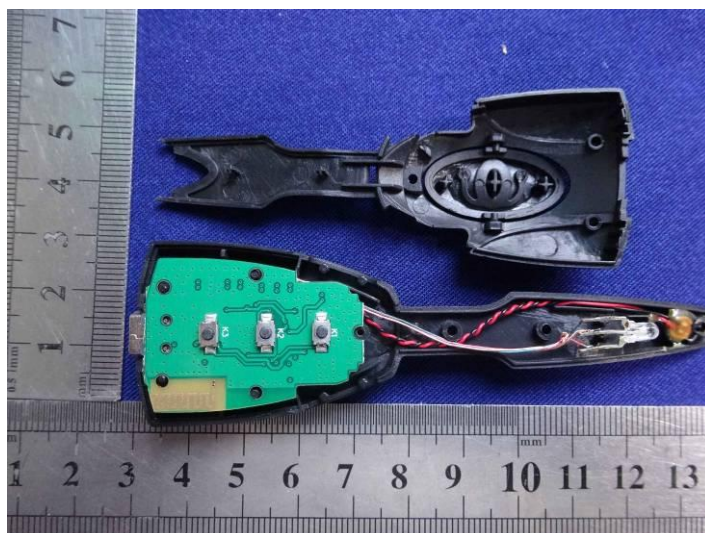

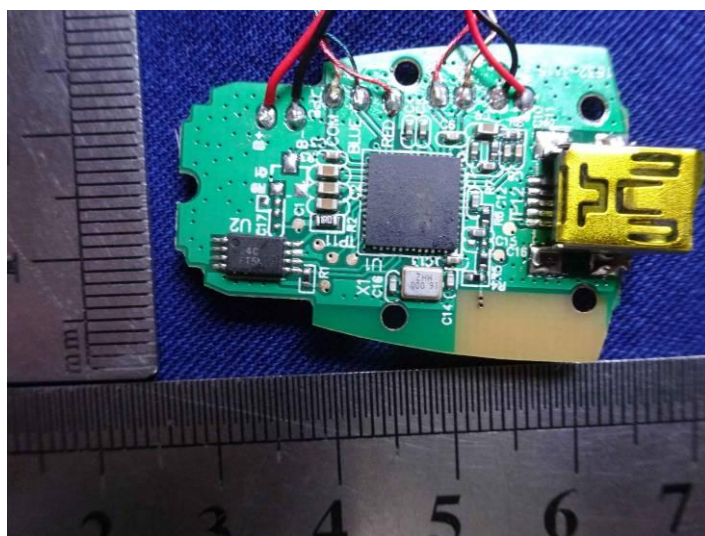
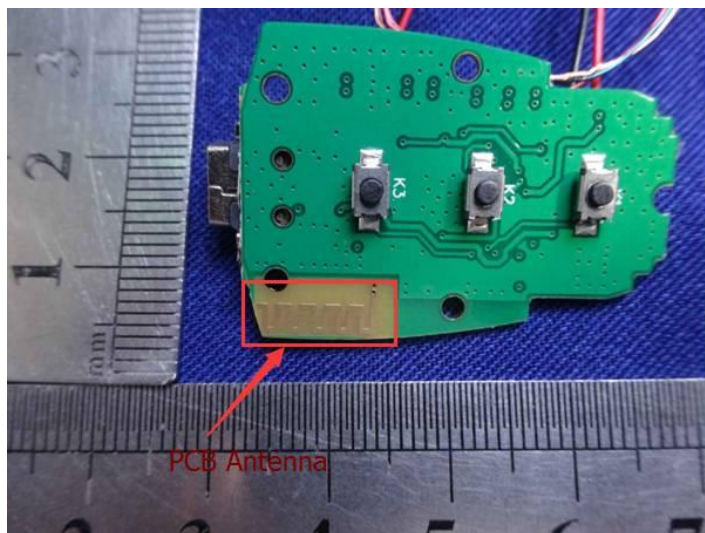

.....End of Report.....