

Model No.: SIMEON SPREK R

# Sprek

Digital Wireless Speaker & Microphone

# Table of Contents

---

Must Read Before Use-----	2
Certification-----	2
General Information-----	3
Introduction-----	3
Product Components (Accessories)-----	3
Product Overview	
Speaker-----	5
Microphone-----	6
Speaker ON / OFF-----	6
Microphone ON / OFF-----	7
Battery Level-----	8
Volume Setting-----	9
Microphone Number Setting (For using two mics) -----	10
How to pair two Mics with one speaker (For using two mics)-----	11
Channel Setting-----	12
How to use a head-microphone-----	13
Re-Booting (When Sprek is not responsive)-----	14
How to charge-----	15
Specification-----	16
Warranty-----	17
Warranty Coverage -----	18
Memo-----	19

# Must Read before Use

## I Note I

- \* Do not put metallic or sharp material like a pin or a needle into the speaker when using M6.
- \* Do not try to put apart this product or fix it yourself
- \* Do not leave Sprek inside a vehicle in hot summer or cold winter.
- \* If you leave Sprek inside a closed car for long time, it could result in deformation, malfunction or product damage.
- \* Please use only Bicom's charger or cable when using or charging Sprek. If you use a third party's charger or cable, it could result in explosion, burning or product damage.
- \* Stop using Sprek immediately if you find smoke out of it or smell burning.
- \* Please do not use any third party components other than the included components.
- \* Using a third party component may cause breakdown or technical issues.
- \* Try not to put strong physical shock to Sprek. It may cause breakdown or malfunction of the product.
- \* If dust gets in Sprek, the quality of the product will decline. So clean the product with soft cloth regularly .
- \* If Sprek is submerged in water, try not to put it apart or fix it yourself. Call our service center.

- English: "

This device complies with Industry Canada licence-exempt RSS standard(s). Operation is subject to the following two conditions:

- (1) this device may not cause interference, and
- (2) this device must accept any interference, including interference that may cause undesired operation of the device."

- French:"

Le présent appareil est conforme aux CNR d'Industrie Canada applicables aux appareils radio exempts de licence. L'exploitation est autorisée aux deux conditions suivantes :

- (1) l'appareil n' doit pas produire de brouillage, et
- (2) l'utilisateur de l'appareil doit accepter tout brouillage radioélectrique subi, même si le brouillage est susceptible d'en compromettre le fonctionnement."

### FCC STATEMENT :

This device complies with Part 15 of the FCC Rules. Operation is subject to the following two conditions:

- (1) This device may not cause harmful interference, and
- (2) This device must accept any interference received, including interference that may cause undesired operation.

Warning: Changes or modifications not expressly approved by the party responsible for compliance could void the user's authority to operate the equipment.

NOTE: This equipment has been tested and found to comply with the limits for a Class B digital device, pursuant to Part 15 of the FCC Rules.

These limits are designed to provide reasonable protection against harmful interference in a residential installation. This equipment generates uses and can radiate radio frequency energy and, if not installed and used in accordance with the instructions, may cause harmful interference to radio communications. However, there is no guarantee that interference will not occur in a particular installation. If this equipment does cause harmful interference to radio or television reception, which can be determined by turning the equipment off and on, the user is encouraged to try to correct the interference by one or more of the following measures:

Reorient or relocate the receiving antenna.

Increase the separation between the equipment and receiver.

Connect the equipment into an outlet on a circuit different from that to which the receiver is connected.

Consult the dealer or an experienced radio/TV technician for help.

RF warning statement:

The device has been evaluated to meet general RF exposure requirement. The device can be used in portable exposure condition without restriction.

# General Information

<b>Wireless Microphone</b>	<ul style="list-style-type: none"><li>* Check there are all product components before using it.</li><li>* Read through this manual to learn how to use it</li><li>* If the microphone is facing the speaker, feedback could occur, so try not to face it toward the speaker.</li><li>* If you set volume high at a narrow space, feedback could occur, so please check if you set the volume right before using it.</li><li>* Check the battery level often when using it. We recommend charging it when battery level bar level is below " 2 ".</li><li>* When the battery level is low, re-charge it using the included charger and cable.</li><li>* We recommend keeping your microphone within 5cm away from your mouth. Otherwise, the voice may sound weak.</li><li>* When using a wired microphone by directly putting it to the speaker, make sure to turn off the wireless microphone.</li></ul>
<b>Wired Head Microphone</b>	<ul style="list-style-type: none"><li>* Before using it, try to fit it around your head.</li><li>* Put your mouth a little closer or further from it until you find the best vocal tone</li><li>* Firmly insert the earphone jack (3.5 pi) into the wireless microphone or the speaker.</li></ul>
<b>Wireless Speaker</b>	<ul style="list-style-type: none"><li>* Check there are all components before using it.</li><li>* Read through this manual to learn how to use it</li><li>* Check the battery level often when using it. We recommend charging it when battery level bar level is below " 2 ".</li><li>* If the distance between the microphone and the speaker is close, feedback may occur.</li><li>* Try to adjust the distance between the microphone and the speaker, volume and direction for best performance.</li></ul>
<b>Input and output Terminals</b>	<ul style="list-style-type: none"><li>* Use only the Bicom-provided charger and cable for charging.</li><li>* You can connect the Bicom-provided microphone to 'AUX IN' for use.</li><li>* If you connect a third party audio product to AUX IN', check if it works normally.</li><li>* If you use a third party product with 'AUX IN', try not to turn up the volume to the point where it may damage the speaker.</li><li>* "AUX IN" doesn't support a regular smartphone earphone or a headset.</li><li>* For the information on a AMP speaker or power that can be used with 'AUX OUT', please check with us first before using them.</li></ul>

# Introduction

**Sprek** is a wireless speaker & microphone.

Sprek is designed to amplify your voice so crowd can hear your voice clearly from distance.

Sprek works the best as a teacher's portable amplifier.

Also, using **900MHz** which is usually not overcrowded, Sprek has no risk of 2.4GHz interference. It offers remarkably good sound performance with a **compact and light body**.

So, it helps distribute your voice evenly across broad area.

## Product Components (Accessories)



1 Speaker  
(Sprek R)

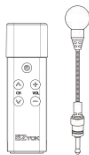

2 Wireless Microphone  
(Sprek T)



3 Microphone  
Holder

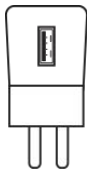

4 Charger



5 Y Type Charging Cable

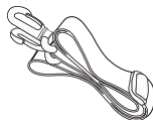

6 Shoulder Strap



7 User Manual

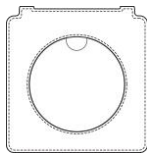

8 Pouch



9 Pouch Case

# Image

Main Device

LED

Power / Battery Level

Power On.Off / Volume Level

Shoulder Strap

Pairing Button

AUX/Wired MIC Terminal

Charging Terminal

RESET Button

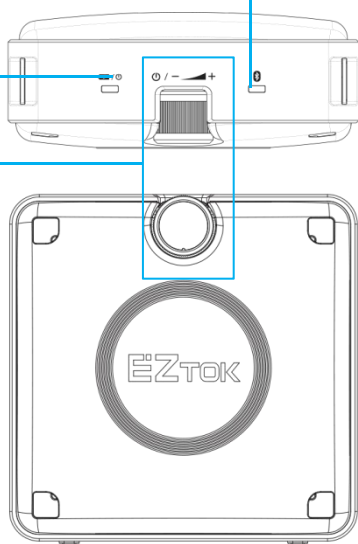

How to Use Shoulder Strap

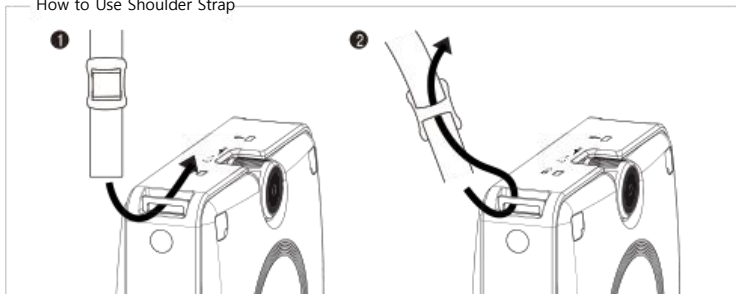

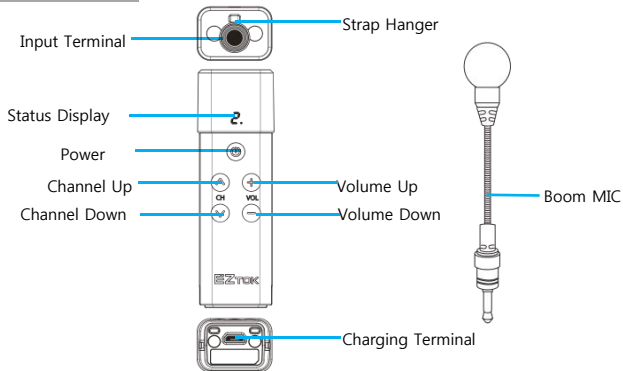

### I How to Use Boom MIC I

- 1 Insert the Boom MIC into the terminal
- 2 Insert a head-microphone into the terminal

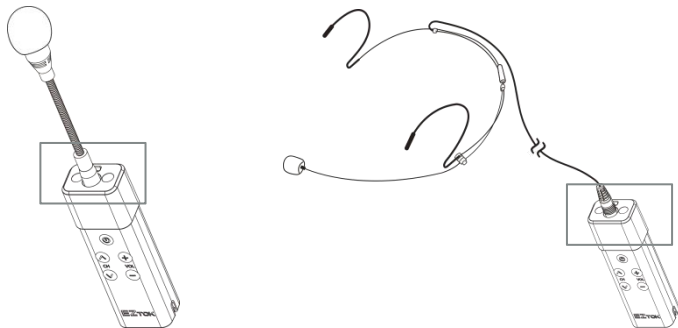

# Speaker Power ON / OFF

Turn as shown below until you hear sound

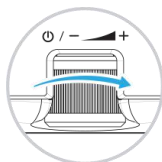
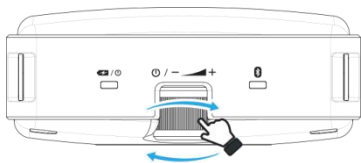

Power on

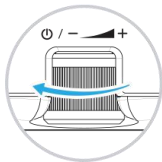

Power off

- Power is on if you turn the switch to the "+" direction
- Power is off if you turn the switch to the "-" direction

## ※ Note

If left not used for an half hour, the speaker automatically goes to power-saving mode.

## I Speaker LED I

LED blinks differently depending on wireless microphone connection

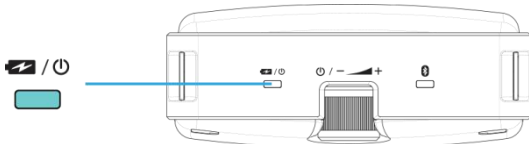

When a microphone is connected, LED blinks twice quick.

When a microphone is not connected, LED blinks slowly..

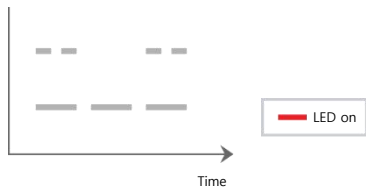



## Microphone ON / OFF

---

Microphone is turned on, if you press & hold the power button for two seconds.  
Microphone is turned off, if you press & hold the power button for two seconds again.

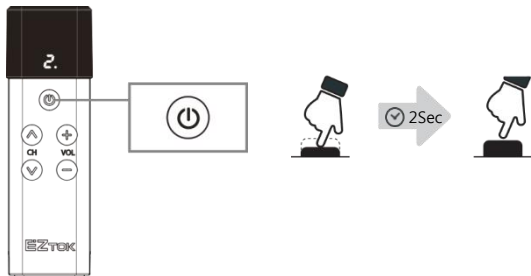

# Remaining Battery Level

Battery LED below indicates the current remaining battery level.

When battery is running low, battery low audio comes out apart from the battery LED. Recharge the battery when battery is running low.

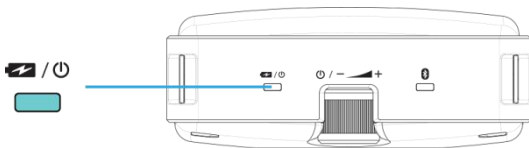

LED blinks three times with 80% of battery



LED blinks twice with 50% of battery



LED blinks one time with 20% of battery



Time



## I Microphone Battery Level (Three levels) I

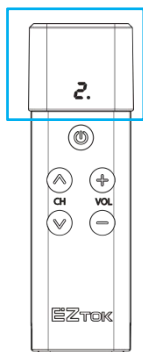

20% Left

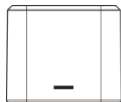

50% Left

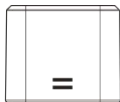

More than 80% Left

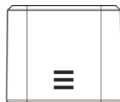

# Volume

## I How to Set Volume I

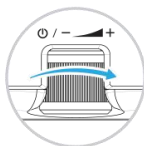
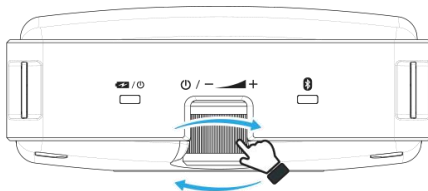

Volume Up



Volume Down

Total Volume = Speaker Volume x MIC Volume

## I Microphone Volume I

### How to Set Volume from Microphone

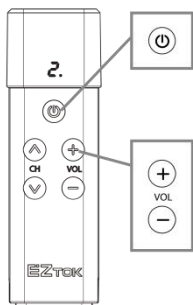

Mute on / off



✓ 0.5 Sec

Volume Up or Down



✓ 0.5 Sec

## Microphone Number Setting [ for Two MICs ]

There is no need to do microphone number setting when using one microphone.  
However, to use two wireless microphones, each microphone needs to be given its own number to prevent interference with one another.

I Set the second microphone to number 2 for two microphone use I

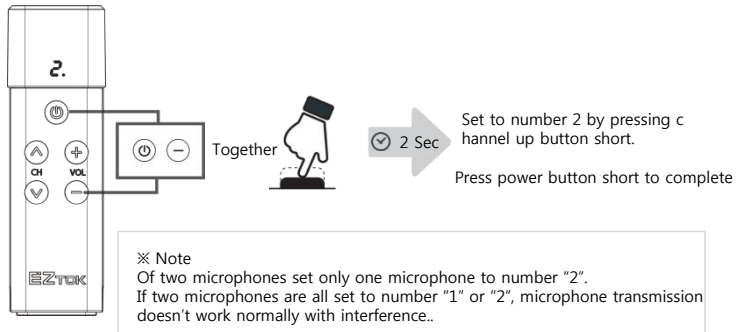

I Microphone Number Display I

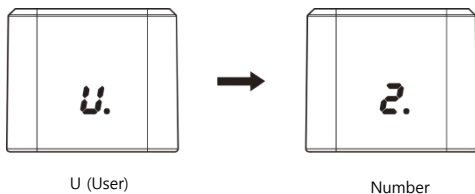

# Pairing between Speaker and Microphone [ for two MICs ]

For two microphone transmission, two microphones need to be paired with a speaker.

## 1 Go to Microphone Pairing Mode

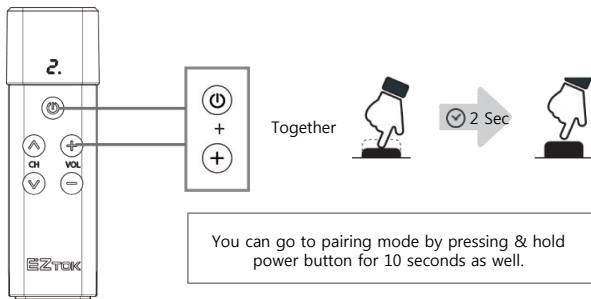

### I First MIC I

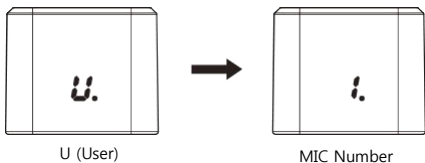

### I Second MIC I

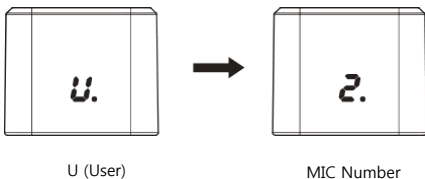

## 2 Go to Speaker Pairing Mode

Turn on the speaker while pressing&hold pairing button.  
Press&hold the pairing button until the sound of "Pairing" comes out.



Power On

+

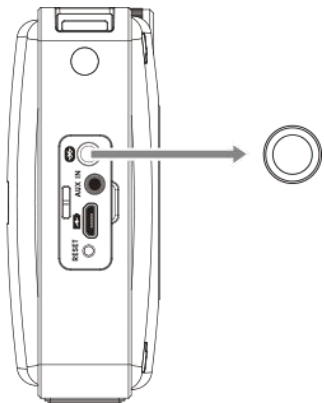

## 3 Once pairing is done, the red LED below is slowly turned off.

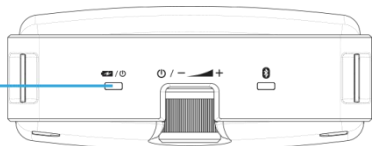

# Channel Setting

You can change channel number between 0 and 9 to avoid frequency interference.

When using two microphones, you need to set them to same channel number.

## I Microphone Channel Setting I

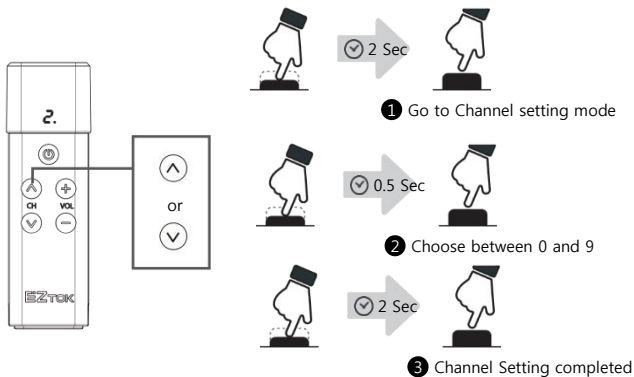

## Reset

### (in case the speaker is unresponsive or malfunctions)

---

\* Press "RESET" button when power is on.  
Then speaker re-boots.

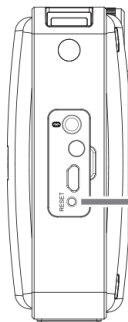

RESET 

"RESET" button stays inside so use something sharp to press it.



# Microphone Reset

- 1 Press Channel down and Volume Up together

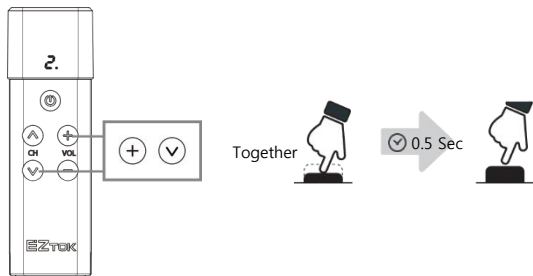

- 2 Press&hold "Power" button for two seconds.

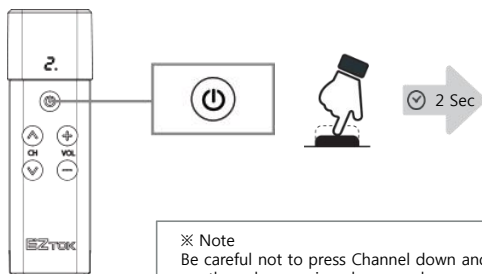

# How to Charge Speaker and MIC Together

Speaker: Battery LED turns orange while being charged and turns green once charging is complete.  
Microphone : Blue and red appears together while being charged and turns blue once charging is complete

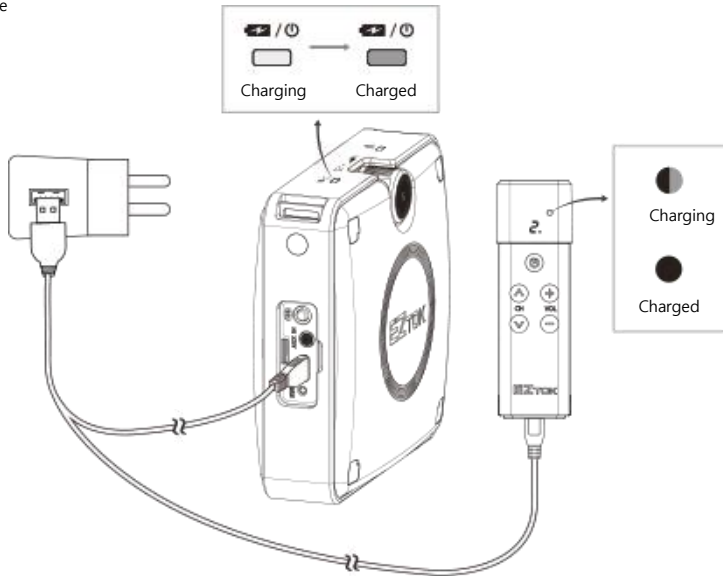

## ※ Note

- Please use only the included-charging adapter.
- When using a smartphone's charger, make sure to use a 5V/2A charger
- We do not recommend charging it with the power on.  
If charged with the power on for more than a day, the product may self-discharge. In this case, please re-charge the product. To get it fully charged, please make sure to turn it off before starting charging it.

# Specifications

Frequency	903 MHz~927 MHz
Transmission Method	TDMA
Modulation System	FSK
Battery	Rechargeable Li-ion 3.7V /3,400mAh Battery for Speaker Rechargeable Li-ion 3.7V / 650mAh Battery for Microphone
Battery Life Time	24 hours for speaker at stand-by or 10 hours at constant use 9 hours for microphone at constant use
Charging Time	6 Hours for Speaker / 2 hours for microphone
Working Temperature	-10/+50°C
Size	Speaker : 105mm(W) / 105mm(H) / 40.7mm(D) Microphone : 28.0mm(W) / 93mm(H) / 20.0mm(D)
Weight	Speaker : 340 g Microphone : 60 g
Frequency Response	100 Hz ~ 20 kHz
Speaker Output	30W

- ※ The function may change without any notice for product improvement purpose.
- ※ The life time of battery may differ depending on product age.
- ※ The battery life time for speaker above is measured at volume 2.

## About After Service

Please let us know the model name, description of technical issue, and contact number for service matter.

Number to Call : 82 - 70 - 7725 - 1103  
Website : [www.ez-tok.co.kr](http://www.ez-tok.co.kr)

# Product Warranty

---

Thank you for purchasing our product.

Product Name	Simeon Sprek
Model Name	Transmitter : Simeon Sprek T Speaker : Simeon Sprek R
Serial Number	
Warranty Period	2 Year
Purchase Date	

Make sure you fill in all the blanks. This product has passed the strict quality test and in case of breakdown, the warranty will cover product repair as stated in the Product Warranty. You may request product repair to agency or headquarters from which you purchased this device. This Product Warranty is not reissued, so make sure you do not lose it.

## Warranty Details

---

- Free repair is guaranteed in case of failure by the Manufacturer or natural defect during the warranty period.
- Free repair is NOT guaranteed in case of the following cases.
  1. Failure due to your carelessness in operating the device
  2. Failure due to repair or remodeling by an unauthorized person
  3. Failure due to natural disasters such as fire, earthquake and flood
  4. Failure due to user's intended or accident mistakes.
  5. Failure due to use of non-genuine components and accessories

---

BiCom Corp.

