

FCC SAR Test Report

Product : Mobile Phone
Trade mark : MI
Model/Type reference : 2016117
Report Number : 1608310293SAR-1
Date of Issue : Oct. 17, 2016
FCC ID : 2AFZZ-RM6117
Test Standards : FCC 47 CFR §2.1093
ANSI/IEEE C95.1-1992
IEEE Std 1528-2013
Test result : PASS

Prepared for:

Xiaomi Communications Co., Ltd.
The Rainbow City of China Resources, NO.68, Qinghe Middle Street, Haidian
District, Beijing, China

Prepared by:

Shenzhen UnionTrust Quality and Technology Co., Ltd.
16/F, Block A, Building 6, Baoneng Science and Technology Park,
Qingxiang Road No.1, Longhua New District, Shenzhen, China
TEL: +86-755-2823 0888
FAX: +86-755-2823 0886

Tested by:

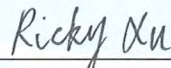

Ricky Xu

Supervisor

Reviewed by:

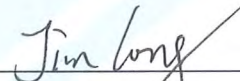

Jim Long

Senior Supervisor

Approved by:

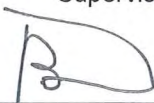

Billy Li

Technical Director

Date:

Oct. 17, 2016

Shenzhen UnionTrust Quality and Technology Co., Ltd.

Address: 16/F, Block A, Building 6, Baoneng Science and Technology Park, Qingxiang Road No.1, Longhua New District, Shenzhen, China
Tel: +86-755-28230888 Fax: +86-755-28230886 E-mail: info@uttlab.com [Http://www.uttlab.com](http://www.uttlab.com)

Version

Version No.	Date	Description
V1.0	Oct. 17, 2016	Original

**Shenzhen UnionTrust Quality and Technology Co., Ltd.**

Address: 16/F, Block A, Building 6, Baoneng Science and Technology Park, Qingxiang Road No.1, Longhua New District, Shenzhen, China
Tel: +86-755-28230888 Fax: +86-755-28230886 E-mail: info@uttlab.com [Http://www.uttlab.com](http://www.uttlab.com)

Contents

	Page
1 GENERAL INFORMATION	4
1.1 STATEMENT OF COMPLIANCE	4
1.2 EUT DESCRIPTION	5
1.2.1 General Description	5
1.2.2 Wireless Technologies	6
1.2.3 List of Accessory	7
1.3 MAXIMUM CONDUCTED POWER	8
1.4 OTHER INFORMATION	9
1.5 TESTING LOCATION.....	9
1.6 TEST FACILITY.....	9
1.7 GUIDANCE STANDARD.....	9
2 SPECIFIC ABSORPTION RATE (SAR).....	10
2.1 INTRODUCTION	10
2.2 SAR DEFINITION	10
2.3 SAR LIMITS.....	10
3 SAR MEASUREMENT SYSTEM.....	11
3.1 SATIMO MEASUREMENT SYSTEM.....	11
3.1.1 Phantoms.....	11
3.1.2 Probe Specification	12
3.1.3 Device Holder	13
3.2 SAR MEASUREMENT PROCEDURE.....	14
3.2.1 Area & Zoom Scan Procedure.....	14
3.2.2 Power Drift Monitoring	14
3.3 TEST EQUIPMENT	15
3.4 MEASUREMENT UNCERTAINTY	16
3.5 TISSUE DIELECTRIC PARAMETER MEASUREMENT & SYSTEM VERIFICATION	17
3.5.1 Tissue Simulating Liquids	17
3.5.2 System Check Description.....	20
3.5.3 Tissue Verification.....	21
3.5.4 System Verification	21
4 SAR MEASUREMENT EVALUATION	22
4.1 EUT CONFIGURATION AND SETTING.....	22
4.2 EUT TESTING POSITION.....	28
4.2.1 Head Exposure Conditions.....	28
4.2.2 Body-worn Accessory Exposure Conditions.....	30
4.2.3 Hotspot Mode Exposure Conditions	31
4.3 MEASURED CONDUCTED POWER RESULT	32
4.4 SAR TEST EXCLUSION EVALUATIONS.....	40
4.5 SAR TESTING RESULTS	41
4.5.1 SAR Test Reduction Considerations	41
4.5.2 SAR Results for Head Exposure Condition.....	43
4.5.3 SAR Results for Body-worn Exposure Condition (Separation Distance is 1.0 cm).....	46
4.5.4 SAR Results for Hotspot Exposure Condition (Separation Distance is 1.0 cm).....	47
4.6 SAR MEASUREMENT VARIABILITY.....	49
4.7 SMULTANEOUS MULTI-BAND TRANSMISSION EVALUATION	50

- Appendix A. SAR Plots of System Verification
- Appendix B. SAR Plots of SAR Measurement
- Appendix C. Calibration Certificate for Probe and Dipole
- Appendix D. Photographs of EUT and Setup

Shenzhen UnionTrust Quality and Technology Co., Ltd.

1 General Information

1.1 Statement of Compliance

The maximum results of Specific Absorption Rate (SAR) found during testing for the EUT are as follows:

Equipment Class	Mode	Highest Reported Head SAR _{1g} (W/kg)	Highest Reported Body-worn SAR _{1g} (1.0 cm Gap) (W/kg)	Highest Reported Hotspot SAR _{1g} (1.0 cm Gap) (W/kg)
PCE	GSM850	0.33	0.45	0.52
	GSM1900	0.30	0.47	0.69
	WCDMA II	0.24	0.64	0.64
	WCDMA V	0.29	0.45	0.45
	LTE 4	0.26	0.65	0.65
	LTE 5	0.19	0.28	0.28
	LTE 7	0.26	0.82	0.82
	LTE 41	0.18	0.51	0.51
DTS	2.4G WLAN	0.54	0.40	0.47
DSS	Bluetooth	0.22	N/A	N/A
Highest Simultaneous Transmission SAR		Head (W/kg)	Body-worn (W/kg)	Hotspot (W/kg)
PCE + DTS		0.81	1.22	1.22
PCE + DSS		0.51	1.10	N/A

1.2 EUT Description

1.2.1 General Description

Product Name	Mobile Phone
Trade mark	MI
Model No.(EUT)	2016117
FCC ID	2AFZZ-RM6117
Device Dimension	Overall (Length × Width) : 140mm × 70mm Overall Diagonal : 150mm Display Diagonal : 127mm
HW Version	P3
SW Version	MIUI8
Tx Frequency Bands (Unit: MHz)	GSM850 : 824.2 ~ 848.8 GSM1900 : 1850.2 ~ 1909.8 WCDMA Band II : 1852.4 ~ 1907.6 WCDMA Band V : 826.4 ~ 846.6 LTE Band 4 : 1710.7 ~ 1754.3 (1.4M), 1711.5 ~ 1753.5 (3M), 1712.5 ~ 1752.5 (5M), 1715 ~ 1750 (10M), 1717.5 ~ 1747.5 (15M), 1720 ~ 1745 (20M) LTE Band 5 : 824.7 ~ 848.3 (1.4M), 825.5 ~ 847.5 (3M), 826.5 ~ 846.5 (5M), 829 ~ 844 (10M) LTE Band 7 : 2502.5 ~ 2567.5 (5M), 2505 ~ 2565 (10M), 2507.5 ~ 2562.5 (15M), 2510 ~ 2560 (20M) LTE Band 41 : 2557.5 ~ 2652.5 (5M), 2560 ~ 2650 (10M), 2562.5 ~ 2647.5 (15M), 2565 ~ 2645 (20M) WLAN : 2412 ~ 2462 Bluetooth : 2402 ~ 2480
Device Class	B
Antenna Type	Fixed Internal Antenna
EUT Stage	Identical Prototype

1.2.2 Wireless Technologies

GSM	Voice
	GPRS (Multi-Slot Class : 33-4UP)
	EDGE (Multi-Slot Class : 33-4UP)
WCDMA	RMC
	HSDPA
	HSUPA
	DC-HSDPA
	HSPA+
LTE	QPSK
	16QAM
2.4G WLAN	802.11b
	802.11g
	802.11n (HT20)
Bluetooth	GFSK
	$\pi/4$ -DQPSK
	8-DPSK
	LE
Wireless Router(Hotspot)	Support
Dual SIM	SIM 1 : GSM + WCDMA + LTE
	SIM 2 : GSM + WCDMA + LTE
	Note : This device support dual SIM but they share the same antenna. Since these two SIM are used for subscriber identification only and it is not related to RF identity, only SIM1 was used for SAR testing.

1.2.3 List of Accessory

Battery 1	Brand Name	MI
	Model Name	BN30
	Power Rating	3.84Vdc, 3030mAh
	Type	Li-ion
	Manufacturer	Sunwoda
Battery 2	Brand Name	MI
	Model Name	BN30
	Power Rating	3.84Vdc, 3030mAh
	Type	Li-ion
	Manufacturer	SCUD

1.3 Maximum Conducted Power

The maximum conducted average power (Unit: dBm) including tune-up tolerance is shown as below.

Mode	GSM850	GSM1900
GSM (GMSK, 1Tx-slot)	33.0	30.0
GPRS (GMSK, 1Tx-slot)	33.0	30.0
GPRS (GMSK, 2Tx-slot)	30.5	28.0
GPRS (GMSK, 3Tx-slot)	28.5	26.5
GPRS (GMSK, 4Tx-slot)	27.5	25.0
EDGE (8PSK, 1Tx-slot)	25.5	25.0
EDGE (8PSK, 2Tx-slot)	24.5	24.0
EDGE (8PSK, 3Tx-slot)	23.0	23.0
EDGE (8PSK, 4Tx-slot)	22.0	22.0

Mode	WCDMA Band II	WCDMA Band V
RMC 12.2K	23.0	23.0
HSDPA	22.0	22.0
DC-HSDPA	22.0	22.0
HSUPA	21.5	21.5
HSPA+	21.0	21.0

Mode	LTE 4	LTE 5	LTE 7	LTE 41
QPSK / 16QAM	23.0	23.0	23.0	23.5

Mode	2.4G WLAN
802.11b	15.0
802.11g	14.0
802.11n HT20	13.0

Mode	2.4G Bluetooth
Bluetooth DH	11.2
Bluetooth 2DH	10.5
Bluetooth 3DH	10.5
Bluetooth LE	2.0

1.4 Other Information

Sample Received Date:	Sep. 09, 2016
Sample tested Date:	Sep. 19, 2016 to Sep. 28, 2016

1.5 Testing Location

Sub-contract lab:

CCIC Southern Electronic Product Testing (Shenzhen) Co., Ltd.

Address: Electronic Testing Building, Shahe Road, Xili, Nanshan District, Shenzhen, 518055, P. R. China

Telephone: +86 (0) 755 2662 7338

Fax: +86 (0) 755 2662 7238

Mail: manager@ccic-set.com

Website: <http://www.ccic-set.com>

1.6 Test Facility

The test facility is recognized, certified, or accredited by the following organizations:

CNAS-Lab Code: L1659

The measuring equipment utilized to perform the tests documented in this report has been calibrated once a year or in accordance with the manufacturer's recommendations, and is traceable under the ISO/IEC/EN 17025 to international or national standards. Equipment has been calibrated by accredited calibration laboratories.

1.7 Guidance Standard

The tests documented in this report were performed in accordance with FCC 47 CFR §2.1093, IEEE Std 1528-2013, ANSI/IEEE C95.1-1992, the following FCC Published RF exposure KDB procedures:

KDB 865664 D01 v01r04

KDB 865664 D02 v01r02

KDB 248227 D01 v02r02

KDB 447498 D01 v06

KDB 648474 D04 v01r03

KDB 941225 D01 v03r01

KDB 941225 D05 v02r05

KDB 941225 D06 v02r01

The equipment have been tested by **CCIC Southern Electronic Product Testing (Shenzhen) Co., Ltd.**, and found compliance with the requirement of the above standards.

2 Specific Absorption Rate (SAR)

2.1 Introduction

SAR is related to the rate at which energy is absorbed per unit mass in an object exposed to a radio field. The SAR distribution in a biological body is complicated and is usually carried out by experimental techniques or numerical modeling, by appropriate techniques, to produce specific absorption rates (SARs) as averaged over the whole-body, any 1 g or any 10 g of tissue (defined as a tissue volume in the shape of a cube). All SAR values are to be averaged over any six-minute period. When portable device was used within 20 cm of the user's body, SAR evaluation of the device will be required. The SAR limit in chapter 2.3.

2.2 SAR Definition

The SAR definition is the time derivative (rate) of the incremental energy (dW) absorbed by (dissipated in) an incremental mass (dm) contained in a volume element (dv) of a given density (ρ). The equation description is as below:

$$SAR = \frac{d}{dt} \left(\frac{dW}{dm} \right) = \frac{d}{dt} \left(\frac{dW}{\rho dv} \right)$$

SAR is expressed in units of Watts per kilogram (W/kg)

SAR measurement can be related to the electrical field in the tissue by

$$SAR = \frac{\sigma |E|^2}{\rho}$$

Where: σ is the conductivity of the tissue, ρ is the mass density of the tissue and E is the RMS electrical field strength.

2.3 SAR Limits

(A) Limits for Occupational/Controlled Exposure (W/kg)

Whole-Body	Partial-Body	Hands, Wrists, Feet and Ankles
0.4	8.0	20.0

(B) Limits for General Population/Uncontrolled Exposure (W/kg)

Whole-Body	Partial-Body	Hands, Wrists, Feet and Ankles
0.08	1.6	4.0

Note:

1. Whole-Body SAR is averaged over the entire body, partial-body SAR is averaged over any 1 gram of tissue defined as a tissue volume in the shape of a cube. SAR for hands, wrists, feet and ankles is averaged over any 10 grams of tissue defined as a tissue volume in the shape of a cube.
2. At frequencies above 6.0 GHz, SAR limits are not applicable and MPE limits for power density should be applied at 5 cm or more from the transmitting device.
3. The SAR limit is specified in FCC 47 CFR §2.1093 and ANSI/IEEE C95.1-1992.

3 SAR Measurement System

3.1 SATIMO Measurement System



Fig-3.1 SATIMO Measurement System

3.1.1 Phantoms

The phantom used for all tests i.e. for both system checks and device testing, was the twin-headed "SAM Phantom", manufactured by SATIMO. The SAM twin phantom is a fiberglass shell phantom with 2mm shell thickness (except the ear region, where shell thickness increases to 6mm).

System checking was performed using the flat section, whilst Head SAR tests used the left and right head profile sections. Body SAR testing also used the flat section between the head profiles.

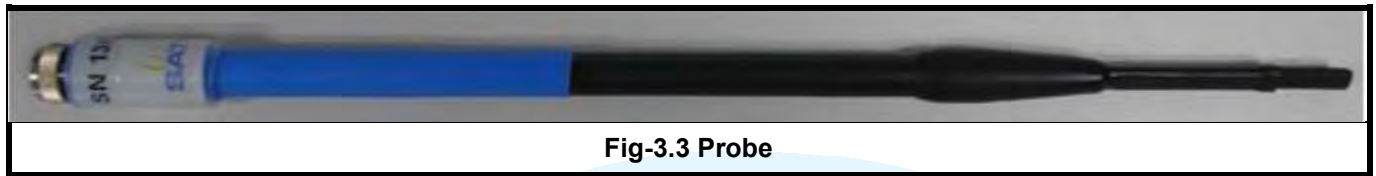

Fig-3.2 SAM Twin Phantom

Shenzhen UnionTrust Quality and Technology Co., Ltd.

Address: 16/F, Block A, Building 6, Baoneng Science and Technology Park, Qingxiang Road No.1, Longhua New District, Shenzhen, China
Tel: +86-755-28230888 Fax: +86-755-28230888 E-mail: info@uttlab.com [Http://www.uttlab.com](http://www.uttlab.com)

3.1.2 Probe Specification



Construction	Symmetrical design with triangular core Interleaved sensors Built-in shielding against static charges PEEK enclosure material (resistant to organic solvents, e.g., DGBE)
Calibration	ISO/IEC 17025 calibration service available.
Frequency	700 MHz to 3 GHz; Linearity: ± 0.5 dB (700 MHz to 3 GHz)
Directivity	± 0.25 dB in HSL (rotation around probe axis) ± 0.5 dB in tissue material (rotation normal to probe axis)
Dynamic Range	1.5 μ W/g to 100 mW/g; Linearity: ± 0.5 dB
Dimensions	Overall length: 330 mm (Tip: 20 mm) Tip diameter: 5 mm Distance from probe tip to dipole centers: <2.7 mm
Application	General dosimetry up to 3 GHz Dosimetry in strong gradient fields Compliance tests of mobile phones
Frequency	5GHz to 6 GHz; Linearity: ± 0.5 dB (5GHz to 6 GHz)
Directivity	± 0.2 dB in HSL (rotation around probe axis) ± 0.5 dB in tissue material (rotation normal to probe axis)
Dynamic Range	1.5 μ W/g to 100 mW/g; Linearity: ± 0.8 dB
Dimensions	Overall length: 330 mm Tip diameter: 2.5 mm Distance from probe tip to dipole centers: 1 mm
Application	General dosimetry from 5GHz up to 6 GHz Dosimetry in strong gradient fields Compliance tests of mobile phones
Compatibility	COMOSAR

Isotropic E-Field Probe

The isotropic E-Field probe has been fully calibrated and assessed for isotropicity, and boundary effect within a controlled environment. Depending on the frequency for which the probe is calibrated the method utilized for calibration will change.

The E-Field probe utilizes a triangular sensor arrangement as detailed in the diagram below:

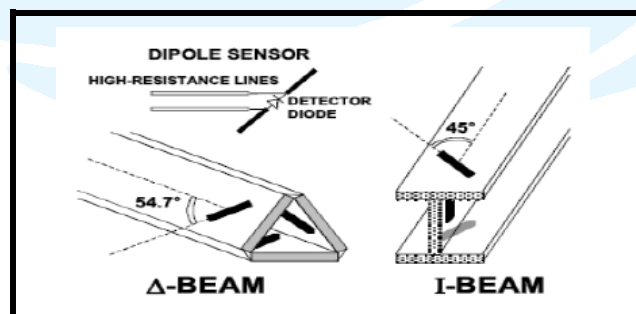

Fig-3.4 Probe

3.1.3 Device Holder

The device was placed in the device holder (illustrated below) that is supplied by SATIMO as an integral part of the COMOSAR test system.

The device holder is designed to cope with the different positions given in the standard. It has two scales for device rotation (with respect to the body axis) and device inclination (with respect to the line between the ear reference points). The rotation centers for both scales is the ear reference point (ERP). Thus the device needs no repositioning when changing the angles.

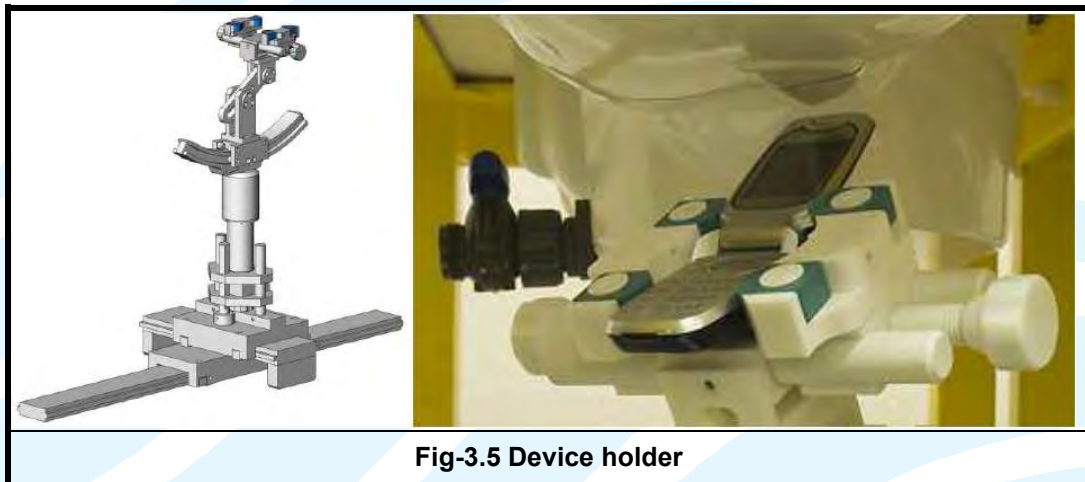

Fig-3.5 Device holder

3.2 SAR Measurement Procedure

According to the SAR test standard, the recommended procedure for assessing the peak spatial-average SAR value consists of the following steps:

- (a) Power reference measurement
- (b) Area scan
- (c) Zoom scan
- (d) Power drift measurement

3.2.1 Area & Zoom Scan Procedure

First Area Scan is used to locate the approximate location(s) of the local peak SAR value(s). The measurement grid within an Area Scan is defined by the grid extent, grid step size and grid offset. Next, in order to determine the EM field distribution in a three-dimensional spatial extension, Zoom Scan is required. The Zoom Scan is performed around the highest E-field value to determine the averaged SAR-distribution over 10 g. According to KDB 865664 D01, the resolution for Area and Zoom scan is specified in the table below.

Items	<= 2 GHz	2-3 GHz	3-4 GHz	4-5 GHz	5-6 GHz
Area Scan ($\Delta x, \Delta y$)	<= 15 mm	<= 12 mm	<= 12 mm	<= 10 mm	<= 10 mm
Zoom Scan ($\Delta x, \Delta y$)	<= 8 mm	<= 5 mm	<= 5 mm	<= 4 mm	<= 4 mm
Zoom Scan (Δz)	<= 5 mm	<= 5 mm	<= 4 mm	<= 3 mm	<= 2 mm
Zoom Scan Volume	>= 30 mm	>= 30 mm	>= 28 mm	>= 25 mm	>= 22 mm

Note:

When zoom scan is required and report SAR is <= 1.4 W/kg, the zoom scan resolution of $\Delta x / \Delta y$ (2-3GHz: <= 8 mm, 3-4GHz: <= 7 mm, 4-6GHz: <= 5 mm) may be applied.

3.2.2 Power Drift Monitoring

All SAR testing is under the EUT install full charged battery and transmit maximum output power. In SATIMO measurement software, the power reference measurement and power drift measurement procedures are used for monitoring the power drift of EUT during SAR test. Both these procedures measure the field at a specified reference position before and after the SAR testing. The software will calculate the field difference in dB. If the power drift more than 5%, the SAR will be retested.

3.3 Test Equipment

Equipment	Type	SN	Cal. Date	Cal. Interval
System Simulator	CMW500	130805	Aug. 10, 2016	1 Year
SAR Probe	SATIMO	SN43/15 EP276	Dec. 09, 2015	1 Year
Dipole	SID835	SN09/13 DIP0G835-217	Aug. 28, 2014	3 Year
Dipole	SID1800	SN09/13 DIP1G800-216	Aug. 28, 2014	3 Year
Dipole	SID1900	SN09/13 DIP1G900-218	Aug. 28, 2014	3 Year
Dipole	SID2450	SN09/13 DIP2G450-220	Aug. 28, 2014	3 Year
Dipole	SID2600	SN32/14 DIP2G600-338	Aug. 12, 2014	3 Year
Vector Network Analyzer	ZVB8	A0802530	Jun. 07, 2016	1 Year
Signal Generator	SMR27	A0304219	Jun. 07, 2016	1 Year
Power Meter	NRP2	A140401673	Mar. 09, 2016	1 Year
Power Sensor	NPR-Z11	1138.3004.02-114072-nq	Mar. 09, 2016	1 Year
Amplifier	Nucletudes	143060	Mar. 09, 2016	1 Year
Directional Coupler	DC6180A	305827	Mar. 09, 2016	1 Year
Power Meter	NRVS	A0802531	Mar. 09, 2016	1 Year
Power Sensor	NRV-Z4	100069	Mar. 09, 2016	1 Year
Multimeter	Keithley-2000	4014020	Mar. 09, 2016	1 Year

3.4 Measurement Uncertainty

Per KDB 865664 D01 SAR Measurement 100 MHz to 6 GHz, when the highest measured 1-g SAR within a frequency band is < 1.5 W/kg, the extensive SAR measurement uncertainty analysis described in IEEE Std 1528-2013 is not required in SAR reports submitted for equipment approval.



3.5 Tissue Dielectric Parameter Measurement & System Verification

3.5.1 Tissue Simulating Liquids

The temperature of the tissue-equivalent medium used during measurement must also be within 18°C to 25°C and within $\pm 2^\circ\text{C}$ of the temperature when the tissue parameters are characterized. The dielectric parameters must be measured before the tissue-equivalent medium is used in a series of SAR measurements. The parameters should be re-measured after each 3 – 4 days of use; or earlier if the dielectric parameters can become out of tolerance; The depth of tissue-equivalent liquid in a phantom must be ≥ 15.0 cm with $\leq \pm 0.5$ cm variation for SAR measurements ≤ 3 GHz and ≥ 10.0 cm with $\leq \pm 0.5$ cm variation for measurements > 3 GHz. The nominal dielectric values of the tissue simulating liquids in the phantom and the tolerance of 5% are listed in Table-3.1.

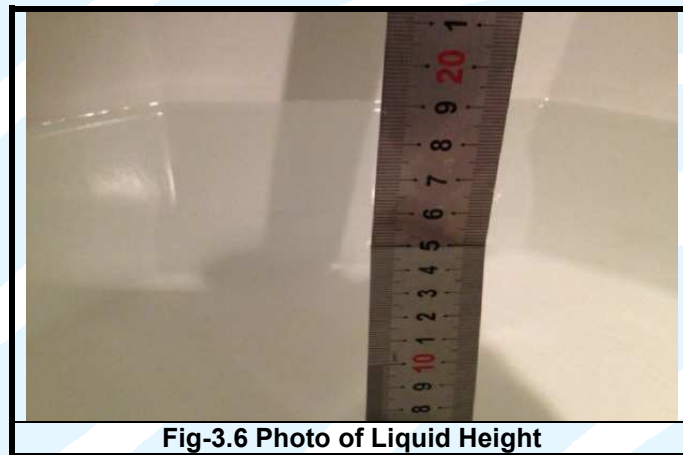

Fig-3.6 Photo of Liquid Height

Table-3.1 Targets of Tissue Simulating Liquid

Frequency (MHz)	Target Permittivity	Range of $\pm 5\%$	Target Conductivity	Range of $\pm 5\%$
For Head				
750	41.9	39.8 ~ 44.0	0.89	0.85 ~ 0.93
835	41.5	39.4 ~ 43.6	0.90	0.86 ~ 0.95
900	41.5	39.4 ~ 43.6	0.97	0.92 ~ 1.02
1450	40.5	38.5 ~ 42.5	1.20	1.14 ~ 1.26
1640	40.3	38.3 ~ 42.3	1.29	1.23 ~ 1.35
1750	40.1	38.1 ~ 42.1	1.37	1.30 ~ 1.44
1800	40.0	38.0 ~ 42.0	1.40	1.33 ~ 1.47
1900	40.0	38.0 ~ 42.0	1.40	1.33 ~ 1.47
2000	40.0	38.0 ~ 42.0	1.40	1.33 ~ 1.47
2300	39.5	37.5 ~ 41.5	1.67	1.59 ~ 1.75
2450	39.2	37.2 ~ 41.2	1.80	1.71 ~ 1.89
2600	39.0	37.1 ~ 41.0	1.96	1.86 ~ 2.06
3500	37.9	36.0 ~ 39.8	2.91	2.76 ~ 3.06
5200	36.0	34.2 ~ 37.8	4.66	4.43 ~ 4.89
5300	35.9	34.1 ~ 37.7	4.76	4.52 ~ 5.00
5500	35.6	33.8 ~ 37.4	4.96	4.71 ~ 5.21
5600	35.5	33.7 ~ 37.3	5.07	4.82 ~ 5.32
5800	35.3	33.5 ~ 37.1	5.27	5.01 ~ 5.53
For Body				
750	55.5	52.7 ~ 58.3	0.96	0.91 ~ 1.01
835	55.2	52.4 ~ 58.0	0.97	0.92 ~ 1.02
900	55.0	52.3 ~ 57.8	1.05	1.00 ~ 1.10
1450	54.0	51.3 ~ 56.7	1.30	1.24 ~ 1.37
1640	53.8	51.1 ~ 56.5	1.40	1.33 ~ 1.47
1750	53.4	50.7 ~ 56.1	1.49	1.42 ~ 1.56
1800	53.3	50.6 ~ 56.0	1.52	1.44 ~ 1.60
1900	53.3	50.6 ~ 56.0	1.52	1.44 ~ 1.60
2000	53.3	50.6 ~ 56.0	1.52	1.44 ~ 1.60
2300	52.9	50.3 ~ 55.5	1.81	1.72 ~ 1.90
2450	52.7	50.1 ~ 55.3	1.95	1.85 ~ 2.05
2600	52.5	49.9 ~ 55.1	2.16	2.05 ~ 2.27
3500	51.3	48.7 ~ 53.9	3.31	3.14 ~ 3.48
5200	49.0	46.6 ~ 51.5	5.30	5.04 ~ 5.57
5300	48.9	46.5 ~ 51.3	5.42	5.15 ~ 5.69
5500	48.6	46.2 ~ 51.0	5.65	5.37 ~ 5.93
5600	48.5	46.1 ~ 50.9	5.77	5.48 ~ 6.06
5800	48.2	45.8 ~ 50.6	6.00	5.70 ~ 6.30

The following table gives the recipes for tissue simulating liquids.

Table-3.2 Recipes of Tissue Simulating Liquid

Tissue Type	Bactericide	DGBE	HEC	NaCl	Sucrose	Triton X-100	Water	Diethylene Glycol Mono-hexylether
H750	0.2	-	0.2	1.4	57.0	-	41.1	-
H835	0.1	-	1.0	1.4	57.0	-	40.5	-
H900	0.1	-	1.0	1.5	56.5	-	40.9	-
H1450	-	45.5	-	0.7	-	-	53.8	-
H1640	-	45.8	-	0.5	-	-	53.7	-
H1750	-	44.5	-	0.3	-	-	55.2	-
H1800	-	44.9	-	0.2	-	-	54.9	-
H1900	-	44.9	-	0.2	-	-	54.9	-
H2000	-	50	-	-	-	-	50	-
H2300	-	44.9	-	0.1	-	-	55.0	-
H2450	-	45.0	-	0.1	-	-	54.9	-
H2600	-	45.1	-	0.1	-	-	54.8	-
H3500	-	8.0	-	0.2	-	20.0	71.8	-
H5G	-	-	-	-	-	17.2	65.52	17.3
B750	0.2	-	0.2	0.8	48.8	-	50.0	-
B835	0.2	-	0.2	0.9	48.5	-	50.2	-
B900	0.2	-	0.2	0.9	48.2	-	50.5	-
B1450	-	34.0	-	0.3	-	-	65.7	-
B1640	-	32.5	-	0.3	-	-	67.2	-
B1750	-	29.4	-	0.4	-	-	70.2	-
B1800	-	29.5	-	0.4	-	-	70.1	-
B1900	-	29.5	-	0.3	-	-	70.2	-
B2000	-	30.0	-	0.2	-	-	69.8	-
B2300	-	31.0	-	0.1	-	-	68.9	-
B2450	-	31.4	-	0.1	-	-	68.5	-
B2600	-	31.8	-	0.1	-	-	68.1	-
B3500	-	28.8	-	0.1	-	-	71.1	-
B5G	-	-	-	-	-	10.7	78.6	10.7

3.5.2 System Check Description

The system check verifies that the system operates within its specifications. It is performed daily or before every SAR measurement. The system check uses normal SAR measurements in the flat section of the phantom with a matched dipole at a specified distance. The system verification setup is shown as below.

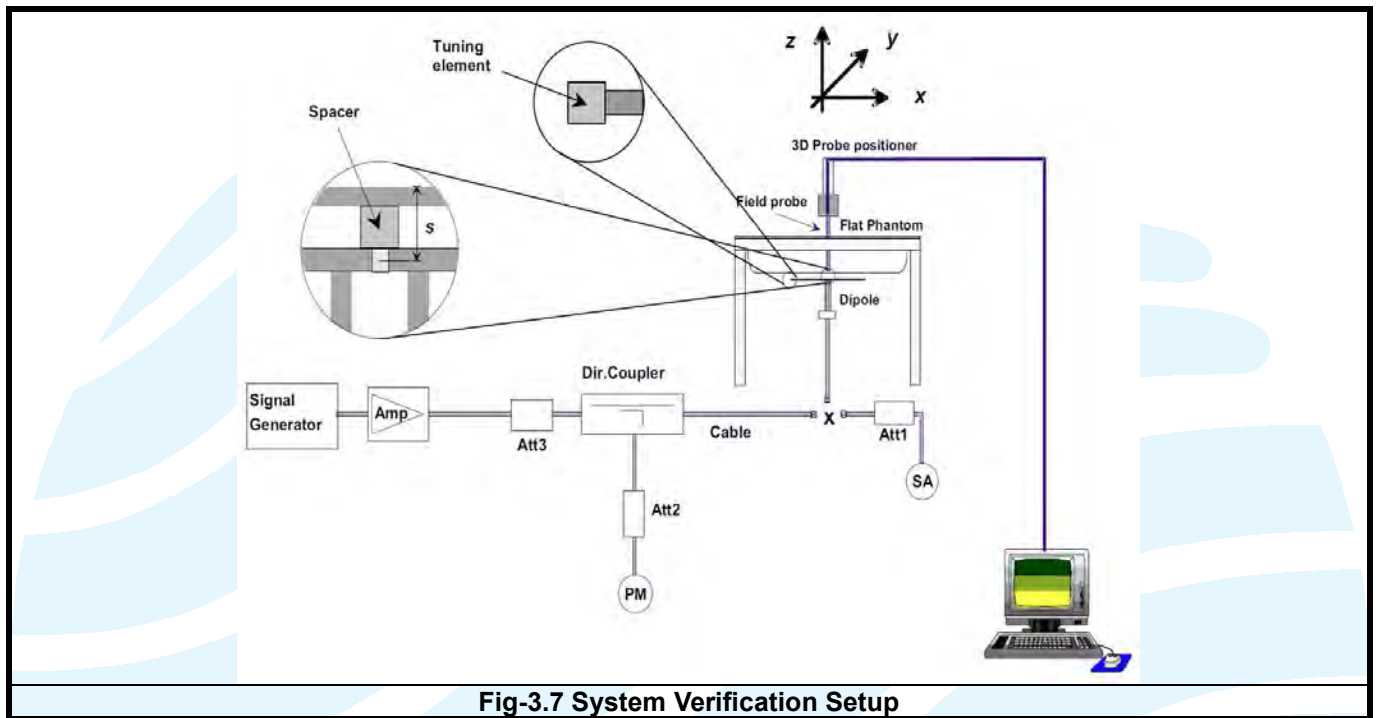

Fig-3.7 System Verification Setup

The validation dipole is placed beneath the flat phantom with the specific spacer in place. The distance spacer is touch the phantom surface with a light pressure at the reference marking and be oriented parallel to the long side of the phantom. The spectrum analyzer measures the forward power at the location of the system check dipole connector. The signal generator is adjusted for the desired forward power (10 mW is used for 700 MHz to 3 GHz, 10 mW is used for 3.5 GHz to 6 GHz) at the dipole connector and the power meter is read at that level. After connecting the cable to the dipole, the signal generator is readjusted for the same reading at power meter.

After system check testing, the SAR result will be normalized to 1W forward input power and compared with the reference SAR value derived from validation dipole certificate report. The deviation of system check should be within 10 %.

3.5.3 Tissue Verification

The measuring results for tissue simulating liquid are shown as below.

Test Date	Tissue Type	Frequency (MHz)	Liquid Temp. (°C)	Measured Conductivity (σ)	Measured Permittivity (ϵ_r)	Target Conductivity (σ)	Target Permittivity (ϵ_r)	Conductivity Deviation (%)	Permittivity Deviation (%)
Sep. 26, 2016	H850	835	21.5	0.890	41.890	0.90	41.50	-1.11	0.94
Sep. 27, 2016	H1800	1800	21.5	1.420	41.730	1.37	40.10	3.65	4.06
Sep. 28, 2016	H1900	1900	21.5	1.410	38.420	1.40	40.00	0.71	-3.95
Sep. 23, 2016	H2450	2450	21.5	1.800	39.200	1.80	39.20	0.00	0.00
Sep. 23, 2016	H2600	2600	21.5	1.960	39.000	1.96	39.00	0.00	0.00
Sep. 19, 2016	B850	835	21.5	0.980	55.230	0.97	55.20	1.03	0.05
Sep. 20, 2016	B1800	1800	21.5	1.560	53.340	1.49	53.40	4.70	-0.11
Sep. 20, 2016	B1900	1900	21.5	1.500	53.260	1.52	53.30	-1.32	-0.08
Sep. 21, 2016	B2450	2450	21.5	1.900	54.660	1.95	52.70	-2.56	3.72
Sep. 21, 2016	B2600	2600	21.5	2.080	54.230	2.16	52.50	-3.70	3.30

Note:

The dielectric properties of the tissue simulating liquid must be measured within 24 hours before the SAR testing and within $\pm 5\%$ of the target values. The variation of the liquid temperature must be within $\pm 2^\circ\text{C}$ during the test..

3.5.4 System Verification

The measuring result for system verification is tabulated as below.

Test Date	Mode	Frequency (MHz)	1W Target SAR-1g (W/kg)	Measured SAR-1g (W/kg)	Normalized to 1W SAR-1g (W/kg)	Deviation (%)	Dipole S/N	Probe S/N
Sep. 26, 2016	Head	835	9.77	0.0993	9.93	1.64	SN09/13 DIP0G835-217	SN 43/15 EP276
Sep. 27, 2016	Head	1800	38.67	0.3815	38.15	-1.34	SN09/13 DIP1G800-216	SN 43/15 EP276
Sep. 28, 2016	Head	1900	40.37	0.4060	40.60	0.57	SN09/13 DIP1G900-218	SN 43/15 EP276
Sep. 23, 2016	Head	2450	53.60	0.5239	52.39	-2.26	SN09/13 DIP2G450-220	SN 43/15 EP276
Sep. 23, 2016	Head	2600	56.19	0.5750	57.50	2.33	SN32/14 DIP2G600-338	SN 43/15 EP276
Sep. 19, 2016	Body	835	10.31	0.1031	10.31	0.00	SN09/13 DIP0G835-217	SN 43/15 EP276
Sep. 20, 2016	Body	1800	40.07	0.4065	40.65	1.45	SN09/13 DIP1G800-216	SN 43/15 EP276
Sep. 20, 2016	Body	1900	40.81	0.4074	40.74	-0.17	SN09/13 DIP1G900-218	SN 43/15 EP276
Sep. 21, 2016	Body	2450	52.66	0.5359	53.59	1.77	SN09/13 DIP2G450-220	SN 43/15 EP276
Sep. 21, 2016	Body	2600	57.55	0.5758	57.58	0.05	SN32/14 DIP2G600-338	SN 43/15 EP276

Note:

Comparing to the reference SAR value provided by SPEAG, the validation data should be within its specification of 10 %. The result indicates the system check can meet the variation criterion and the plots can be referred to Appendix A of this report.

4 SAR Measurement Evaluation

4.1 EUT Configuration and Setting

<Connections between EUT and System Simulator>

For WWAN SAR testing, the EUT was linked and controlled by base station emulator (Agilent E5515C is used for GSM/WCDMA/CDMA, and Anritsu MT8820C is used for LTE). Communication between the EUT and the emulator was established by air link. The distance between the EUT and the communicating antenna of the emulator is larger than 50 cm and the output power radiated from the emulator antenna is at least 30 dB smaller than the output power of EUT. The EUT was set from the emulator to radiate maximum output power during SAR testing.

<Considerations Related to GSM / GPRS / EDGE for Setup and Testing>

For GSM850 frequency band, the power control level is set to 5 for GSM mode and GPRS (GMSK: CS1), and set to 8 for EDGE (GMSK: MCS1, 8PSK: MCS9). For GSM1900 frequency band, the power control level is set to 0 for GSM mode and GPRS (GMSK: CS1), and set to 2 for EDGE (GMSK: MCS1, 8PSK: MCS9).

SAR test reduction for GPRS and EDGE modes is determined by the source-based time-averaged output power specified for production units, including tune-up tolerance. The data mode with highest specified time-averaged output power should be tested for SAR compliance in the applicable exposure conditions. For modes with the same specified maximum output power and tolerance, the higher number time-slot configuration should be tested.

<Considerations Related to WCDMA for Setup and Testing>

WCDMA Handsets Head SAR

SAR for next to the ear head exposure is measured using a 12.2 kbps RMC with TPC bits configured to all "1's". The 3G SAR test reduction procedure is applied to AMR configurations with 12.2 kbps RMC as the primary mode.

WCDMA Handsets Body-worn SAR

SAR for body-worn configurations is measured using a 12.2 kbps RMC with TPC bits configured to all "1's". The 3G SAR test reduction procedure is applied to other spreading codes and multiple DPDCH_n configurations supported by the handset with 12.2 kbps RMC as the primary mode.

Handsets with Release 5 HSDPA

The 3G SAR test reduction procedure is applied to HSDPA body-worn configurations with 12.2 kbps RMC as the primary mode. Otherwise, SAR is measured for HSDPA using the HSDPA body SAR procedures in the "Release 5 HSDPA Data Devices", for the highest reported SAR body-worn exposure configuration in 12.2 kbps RMC. Handsets with both HSDPA and HSUPA are tested according to Release 6 HSPA test procedures.

Handsets with Release 6 HSUPA

The 3G SAR test reduction procedure is applied to HSPA (HSUPA/HSDPA with RMC) body-worn configurations with 12.2 kbps RMC as the primary mode. Otherwise, SAR is measured for HSPA using the HSPA body SAR procedures in the "Release 6 HSPA Data Devices", for the highest reported body-worn exposure SAR configuration in 12.2 kbps RMC. When VOIP is applicable for next to the ear head exposure in HSPA, the 3G SAR test reduction procedure is applied to HSPA with 12.2 kbps RMC as the primary mode; otherwise, the same HSPA configuration used for body-worn measurements is tested for next to the ear head exposure.

Shenzhen UnionTrust Quality and Technology Co., Ltd.

Release 5 HSDPA Data Devices

The 3G SAR test reduction procedure is applied to body SAR with 12.2 kbps RMC as the primary mode. Otherwise, body SAR for HSDPA is measured using an FRC with H-Set 1 in Sub-test 1 and a 12.2 kbps RMC configured in Test Loop Mode 1, for the highest reported SAR configuration in 12.2 kbps RMC without HSDPA. HSDPA is configured according to the applicable UE category of a test device. The number of HS-DSCH / HS-PDSCHs, HARQ processes, minimum inter-TTI interval, transport block sizes and RV coding sequence are defined by the H-set. To maintain a consistent test configuration and stable transmission conditions, QPSK is used in the H-set for SAR testing. HS-DPCCH should be configured with a CQI feedback cycle of 4 ms and a CQI repetition factor of 2 to maintain a constant rate of active CQI slots. DPCCH and DPDCH gain factors (β_c , β_d), and HS-DPCCH power offset parameters (Δ_{ACK} , Δ_{NACK} , Δ_{CQI}) are set according to values indicated in below. The CQI value is determined by the UE category, transport block size, number of HS-PDSCHs and modulation used in the H-set.

Sub-test	β_c	β_d	β_d (SF)	β_c / β_d	$\beta_{hs}^{(1)}$	CM (dB) ⁽²⁾	MPR
1	2 / 15	15 / 15	64	2 / 15	4 / 15	0.0	0
2	12 / 15 ⁽³⁾	15 / 15 ⁽³⁾	64	12 / 15 ⁽³⁾	24 / 15	1.0	0
3	15 / 15	8 / 15	64	15 / 8	30 / 15	1.5	0.5
4	15 / 15	4 / 15	64	15 / 4	30 / 15	1.5	0.5

Note 1: Δ_{ACK} , Δ_{NACK} and $\Delta_{CQI} = 8 \Leftrightarrow A_{hs} = \beta_{hs} / \beta_c = 30 / 15 \Leftrightarrow \beta_{hs} = 30 / 15 * \beta_c$.
 Note 2: CM = 1 for $\beta_c / \beta_d = 12 / 15$, $\beta_{hs} / \beta_c = 24 / 15$.
 Note 3: For subtest 2 the β_c / β_d ratio of 12 / 15 for the TFC during the measurement period (TF1, TF0) is achieved by setting the signaled gain factors for the reference TFC (TF1, TF1) to $\beta_c = 11 / 15$ and $\beta_d = 15 / 15$.

Release 6 HSPA Data Devices

The 3G SAR test reduction procedure is applied to body SAR with 12.2 kbps RMC as the primary mode. Otherwise, body SAR for HSPA is measured with E-DCH Sub-test 5, using H-Set 1 and QPSK for FRC and a 12.2 kbps RMC configured in Test Loop Mode 1 and power control algorithm 2, according to the highest reported body SAR configuration in 12.2 kbps RMC without HSPA. When VOIP applies to head exposure, the 3G SAR test reduction procedure is applied with 12.2 kbps RMC as the primary mode. Otherwise, the same HSPA configuration used for body SAR measurements are applied to head exposure testing. Due to inner loop power control requirements in HSPA, a communication test set is required for output power and SAR tests. The 12.2 kbps RMC, FRC H-set 1 and E-DCH configurations for HSPA are configured according to the β values indicated in below.

Sub-test	β_c	β_d	β_d (SF)	β_c / β_d	$\beta_{hs}^{(1)}$	β_{ec}	β_{ed}	β_{ed} (SF)	β_{ed} (codes)	CM ⁽²⁾ (dB)	MPR (dB)	AG ⁽⁴⁾ Index	E-TFCI
1	11 / 15 ⁽³⁾	15 / 15 ⁽³⁾	64	11 / 15 ⁽³⁾	22 / 15	209 / 225	1039 / 225	4	1	1.0	0.0	20	75
2	6 / 15	15 / 15	64	6 / 15	12 / 15	12 / 15	94 / 75	4	1	3.0	2.0	12	67
3	15 / 15	9 / 15	64	15 / 9	30 / 15	30 / 15	$\beta_{ed1}: 47/15$ $\beta_{ed2}: 47/15$	4	2	2.0	1.0	15	92
4	2 / 15	15 / 15	64	2 / 15	4 / 15	2 / 15	56 / 75	4	1	3.0	2.0	17	71
5	15 / 15 ⁽⁴⁾	15 / 15 ⁽⁴⁾	64	15 / 15 ⁽⁴⁾	30 / 15	24 / 15	134 / 15	4	1	1.0	0.0	21	81

Note 1: Δ_{ACK} , Δ_{NACK} and $\Delta_{CQI} = 8 \Leftrightarrow A_{hs} = \beta_{hs} / \beta_c = 30 / 15 \Leftrightarrow \beta_{hs} = 30 / 15 * \beta_c$.
 Note 2: CM = 1 for $\beta_c / \beta_d = 12 / 15$, $\beta_{hs} / \beta_c = 24 / 15$. For all other combinations of DPDCH, DPCCH, HS-DPCCH, E-DPDCH and E-DPCCH the MPR is based on the relative CM difference.
 Note 3: For subtest 1 the β_c / β_d ratio of 11 / 15 for the TFC during the measurement period (TF1, TF0) is achieved by setting the signaled gain factors for the reference TFC (TF1, TF1) to $\beta_c = 10 / 15$ and $\beta_d = 15 / 15$.
 Note 4: For subtest 5 the β_c / β_d ratio of 15 / 15 for the TFC during the measurement period (TF1, TF0) is achieved by setting the signaled gain factors for the reference TFC (TF1, TF1) to $\beta_c = 14 / 15$ and $\beta_d = 15 / 15$.
 Note 5: Testing UE using E-DPDCH Physical Layer category 1 Sub-test 3 is not required according to TS 25.306 Table 5.1g.
 Note 6: β_{ed} cannot be set directly; it is set by Absolute Grant Value.

Shenzhen UnionTrust Quality and Technology Co., Ltd.

HSPA+ SAR Guidance

The 3G SAR test reduction procedure is applied to HSPA+ (uplink) with 12.2 kbps RMC as the primary mode. Otherwise, when SAR is required for Rel. 6 HSPA, SAR is required for Rel. 7 HSPA+. Power is measured for HSPA+ that supports uplink 16QAM according to configurations in Table C.11.1.4 of 3GPP TS 34.121-1 to determine SAR test reduction.

DC-HSDPA SAR Guidance

The 3G SAR test reduction procedure is applied to DC-HSDPA with 12.2 kbps RMC as the primary mode. Otherwise, when SAR is required for Rel. 5 HSDPA, SAR is required for Rel. 8 DC-HSDPA. Power is measured for DC-HSDPA according to the H-Set 12, FRC configuration in Table C.8.1.12 of 3GPP TS 34.121-1 to determine SAR test reduction. A primary and a secondary serving HS-DSCH Cell are required to perform the power measurement and for the results to be acceptable.

<Considerations Related to LTE for Setup and Testing>

This device contains LTE transmitter which follows 3GPP standards, is category 3, supports both QPSK and 16QAM modulations, and supported LTE band and channel bandwidth is listed in below. The output power was tested per 3GPP TS 36.521-1 maximum transmit procedures for both QPSK and 16QAM modulation. The results please refer to section 4.4 of this report.

EUT Supported LTE Band and Channel Bandwidth						
LTE Band	BW 1.4 MHz	BW 3 MHz	BW 5 MHz	BW 10 MHz	BW 15 MHz	BW 20 MHz
4	V	V	V	V	V	V
5	V	V	V	V		
7			V	V	V	V
41			V	V	V	V

The LTE maximum power reduction (MPR) in accordance with 3GPP TS 36.101 is active all times during LTE operation. The allowed MPR for the maximum output power is specified in below.

Modulation	Channel Bandwidth / RB Configurations						LTE MPR Setting (dB)
	BW 1.4 MHz	BW 3 MHz	BW 5 MHz	BW 10 MHz	BW 15 MHz	BW 20 MHz	
QPSK	> 5	> 4	> 8	> 12	> 16	> 18	1
16QAM	<= 5	<= 4	<= 8	<= 12	<= 16	<= 18	1
16QAM	> 5	> 4	> 8	> 12	> 16	> 18	2

Note: MPR is according to the standard and implemented in the circuit (mandatory).

In addition, the device is compliant with additional maximum power reduction (A-MPR) requirements defined in 3GPP TS 36.101 section 6.2.4 that was disabled for all FCC compliance testing.

During LTE SAR testing, the related parameters of operating band, channel bandwidth, uplink channel number, modulation type, and RB was set in base station simulator. When the EUT has registered and communicated to base station simulator, the simulator set to make EUT transmitting the maximum radiated power.

TDD-LTE Setup Configurations

According to KDB 941225 D05, SAR testing for TDD-LTE device must be tested using a fixed periodic duty factor according to the highest transmission duty factor implemented for the device and supported by the defined 3GPP TDD-LTE configurations. The TDD-LTE of this device supports frame structure type 2 defined in 3GPP TS 36.211 section 4.2, and the frame structure configuration can be referred to below.

Shenzhen UnionTrust Quality and Technology Co., Ltd.

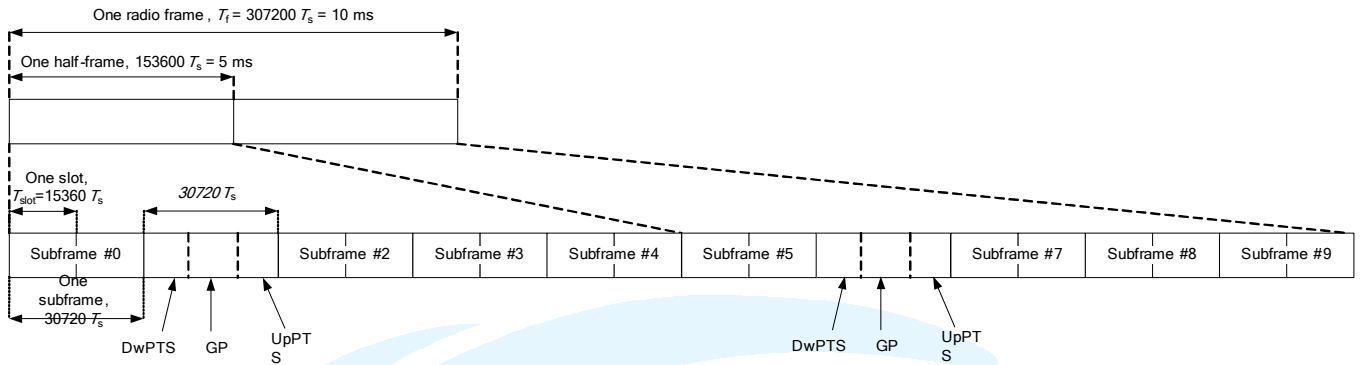

3GPP TS 36.211 Figure 4.2-1: Frame Structure Type 2

Special Subframe Configuration	Normal Cyclic Prefix in Downlink			Extended Cyclic Prefix in Downlink		
	DwPTS	UpPTS		DwPTS	UpPTS	
		Normal Cyclic Prefix in Uplink	Extended Cyclic Prefix in Uplink		Normal Cyclic Prefix in Uplink	Extended Cyclic Prefix in Uplink
0	6592·Ts	2192·Ts	2560·Ts	7680·Ts	2192·Ts	2560·Ts
1	19760·Ts			20480·Ts		
2	21952·Ts			23040·Ts		
3	24144·Ts			25600·Ts		
4	26336·Ts			7680·Ts		
5	6592·Ts	4384·Ts	5120·Ts	20480·Ts	4384·Ts	5120·Ts
6	19760·Ts			23040·Ts		
7	21952·Ts			12800·Ts		
8	24144·Ts			-		
9	13168·Ts			-		

3GPP TS 36.211 Table 4.2-1: Configuration of Special Subframe

Uplink-Downlink Configuration	Downlink-to-Uplink Switch-Point Periodicity	Subframe Number										
		0	1	2	3	4	5	6	7	8	9	
0	5 ms	D	S	U	U	U	D	S	U	U	U	
1	5 ms	D	S	U	U	D	D	S	U	U	D	
2	5 ms	D	S	U	D	D	D	S	U	D	D	
3	10 ms	D	S	U	U	U	D	D	D	D	D	
4	10 ms	D	S	U	U	D	D	D	D	D	D	
5	10 ms	D	S	U	D	D	D	D	D	D	D	
6	5 ms	D	S	U	U	U	D	S	U	U	D	

3GPP TS 36.211 Table 4.2-2: Uplink-Downlink Configurations

The variety of different TD-LTE uplink-downlink configurations allows a network operator to allocate the network's capacity between uplink and downlink traffic to meet the needs of the network. The uplink duty cycle of these seven configurations can readily be computed and shown in below.

UL-DL Configuration	0	1	2	3	4	5	6
Highest Duty-Cycle	63.33%	43.33%	23.33%	31.67%	21.67%	11.67%	53.33%

Considering the highest transmission duty cycle, TDD-LTE was tested using Uplink-Downlink Configuration 0 with 6 uplink subframe and 2 special subframe. The special subframe was set to special subframe configuration 7 using extended cyclic prefix uplink. Therefore, SAR testing for TDD-LTE was performed at the maximum output power with highest transmission duty cycle of 63.33%.

Shenzhen UnionTrust Quality and Technology Co., Ltd.

<Considerations Related to WLAN for Setup and Testing>

In general, various vendor specific external test software and chipset based internal test modes are typically used for SAR measurement. These chipset based test mode utilities are generally hardware and manufacturer dependent, and often include substantial flexibility to reconfigure or reprogram a device. A Wi-Fi device must be configured to transmit continuously at the required data rate, channel bandwidth and signal modulation, using the highest transmission duty factor supported by the test mode tools for SAR measurement. The test frequencies established using test mode must correspond to the actual channel frequencies. When 802.11 frame gaps are accounted for in the transmission, a maximum transmission duty factor of 92 - 96% is typically achievable in most test mode configurations. A minimum transmission duty factor of 85% is required to avoid certain hardware and device implementation issues related to wide range SAR scaling. In addition, a periodic transmission duty factor is required for current generation SAR systems to measure SAR correctly. The reported SAR must be scaled to 100% transmission duty factor to determine compliance at the maximum tune-up tolerance limit.

According to KDB 248227 D01, this device has installed WLAN engineering testing software which can provide continuous transmitting RF signal. During WLAN SAR testing, this device was operated to transmit continuously at the maximum transmission duty with specified transmission mode, operating frequency, lowest data rate, and maximum output power.

Initial Test Configuration

An initial test configuration is determined for OFDM transmission modes in 2.4 GHz and 5 GHz bands according to the channel bandwidth, modulation and data rate combination(s) with the highest maximum output power specified for production units in each standalone and aggregated frequency band. When the same maximum power is specified for multiple transmission modes in a frequency band, the largest channel bandwidth, lowest order modulation, lowest data rate and lowest order 802.11a/g/n/ac mode is used for SAR measurement, on the highest measured output power channel in the initial test configuration, for each frequency band.

Subsequent Test Configuration

SAR measurement requirements for the remaining 802.11 transmission mode configurations that have not been tested in the initial test configuration are determined separately for each standalone and aggregated frequency band, in each exposure condition, according to the maximum output power specified for production units. Additional power measurements may be required to determine if SAR measurements are required for subsequent highest output power channels in a subsequent test configuration. When the highest reported SAR for the initial test configuration according to the initial test position or fixed exposure position requirements, is adjusted by the ratio of the subsequent test configuration to initial test configuration specified maximum output power and the adjusted SAR is ≤ 1.2 W/kg, SAR is not required for that subsequent test configuration.

SAR Test Configuration and Channel Selection

When multiple channel bandwidth configurations in a frequency band have the same specified maximum output power, the initial test configuration is using largest channel bandwidth, lowest order modulation, lowest data rate, and lowest order 802.11 mode (i.e., 802.11a is chosen over 802.11n then 802.11ac or 802.11g is chosen over 802.11n). After an initial test configuration is determined, if multiple test channels have the same measured maximum output power, the channel chosen for SAR measurement is determined according to the following.

- 1) The channel closest to mid-band frequency is selected for SAR measurement.
- 2) For channels with equal separation from mid-band frequency; for example, high and low channels or two mid-band channels, the higher frequency (number) channel is selected for SAR measurement.

Shenzhen UnionTrust Quality and Technology Co., Ltd.

<Considerations Related to Bluetooth for Setup and Testing>

This device has installed Bluetooth engineering testing software which can provide continuous transmitting RF signal. During Bluetooth SAR testing, this device was operated to transmit continuously at the maximum transmission duty with specified transmission mode, operating frequency, lowest data rate, and maximum output power.



4.2 EUT Testing Position

According to KDB 648474 D04, handsets are tested for SAR compliance in head, body-worn accessory and other use configurations described in the following subsections.

4.2.1 Head Exposure Conditions

Head exposure is limited to next to the ear voice mode operations. Head SAR compliance is tested according to the test positions defined in IEEE Std 1528-2013 using the SAM phantom illustrated as below.

1. Define two imaginary lines on the handset
 - (a) The vertical centerline passes through two points on the front side of the handset - the midpoint of the width w_t of the handset at the level of the acoustic output, and the midpoint of the width w_b of the bottom of the handset.
 - (b) The horizontal line is perpendicular to the vertical centerline and passes through the center of the acoustic output. The horizontal line is also tangential to the face of the handset at point A.
 - (c) The two lines intersect at point A. Note that for many handsets, point A coincides with the center of the acoustic output; however, the acoustic output may be located elsewhere on the horizontal line. Also note that the vertical centerline is not necessarily parallel to the front face of the handset, especially for clamshell handsets, handsets with flip covers, and other irregularly shaped handsets.

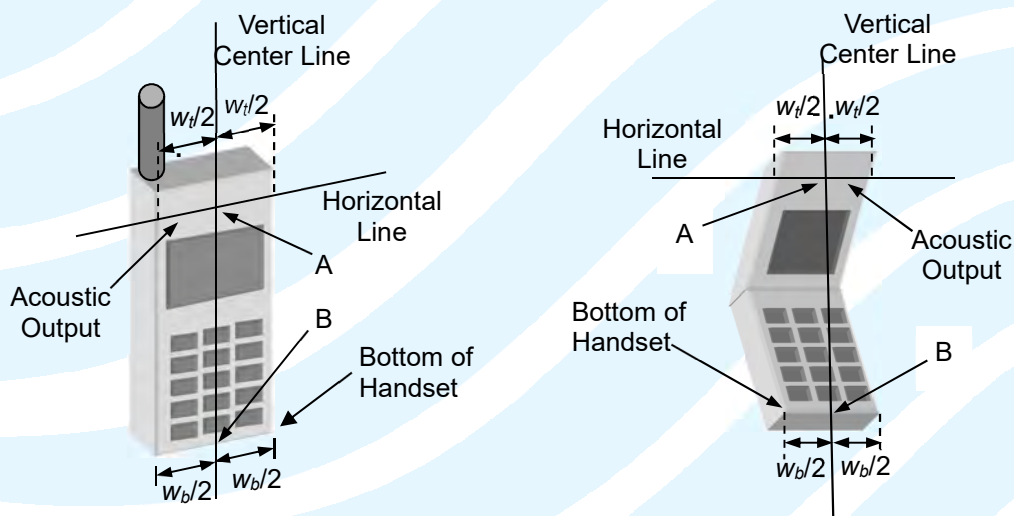

Fig-4.1 Illustration for Handset Vertical and Horizontal Reference Lines

2. Cheek Position

- (a) To position the device with the vertical center line of the body of the device and the horizontal line crossing the center piece in a plane parallel to the sagittal plane of the phantom. While maintaining the device in this plane, align the vertical center line with the reference plane containing the three ear and mouth reference point (M: Mouth, RE: Right Ear, and LE: Left Ear) and align the center of the ear piece with the line RE-LE.
- (b) To move the device towards the phantom with the ear piece aligned with the line LE-RE until the phone touched the ear. While maintaining the device in the reference plane and maintaining the phone contact with the ear, move the bottom of the phone until any point on the front side is in contact with the cheek of the phantom or until contact with the ear is lost (see Fig-4.2).

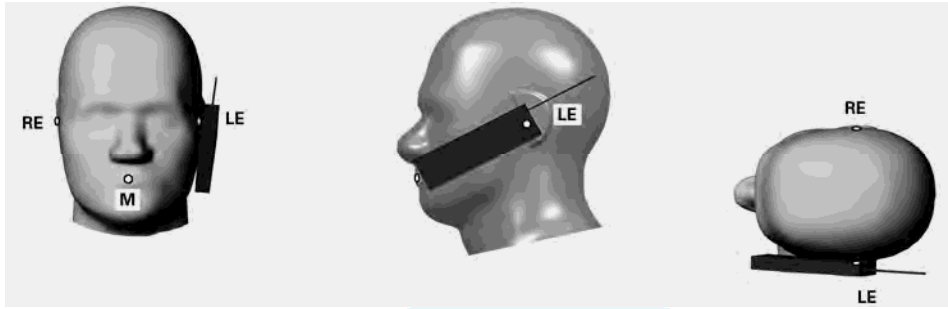

Fig-4.2 Illustration for Cheek Position

3. Tilted Position

- (a) To position the device in the “cheek” position described above.
- (b) While maintaining the device the reference plane described above and pivoting against the ear, moves it outward away from the mouth by an angle of 15 degrees or until contact with the ear is lost (see Fig-4.3).

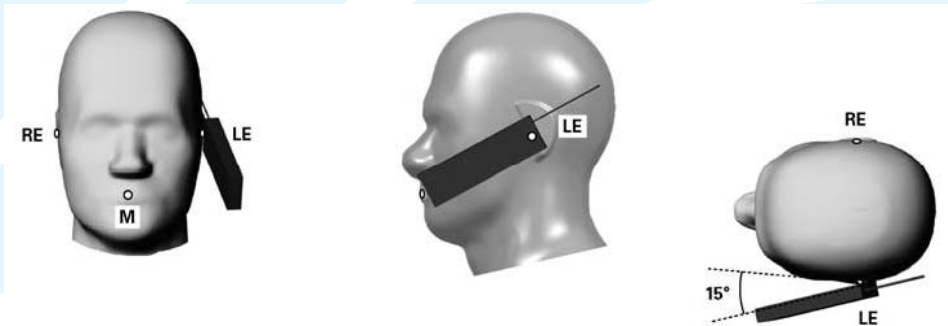

Fig-4.3 Illustration for Tilted Position

4.2.2 Body-worn Accessory Exposure Conditions

Body-worn accessory exposure is typically related to voice mode operations when handsets are carried in body-worn accessories. The body-worn accessory procedures in KDB 447498 D01 are used to test for body-worn accessory SAR compliance, without a headset connected to it. This enables the test results for such configuration to be compatible with that required for hotspot mode when the body-worn accessory test separation distance is greater than or equal to that required for hotspot mode. When the reported SAR for a body-worn accessory, measured without a headset connected to the handset, is $> 1.2 \text{ W/kg}$, the highest reported SAR configuration for that wireless mode and frequency band should be repeated for that body-worn accessory with a headset attached to the handset.

Body-worn accessories that do not contain metallic or conductive components may be tested according to worst-case exposure configurations, typically according to the smallest test separation distance required for the group of body-worn accessories with similar operating and exposure characteristics. All body-worn accessories containing metallic components are tested in conjunction with the host device.

Body-worn accessory SAR compliance is based on a single minimum test separation distance for all wireless and operating modes applicable to each body-worn accessory used by the host, and according to the relevant voice and/or data mode transmissions and operations. If a body-worn accessory supports voice only operations in its normal and expected use conditions, testing of data mode for body-worn compliance is not required.

A conservative minimum test separation distance for supporting off-the-shelf body-worn accessories that may be acquired by users of consumer handsets is used to test for body-worn accessory SAR compliance. This distance is determined by the handset manufacturer, according to the requirements of Supplement C 01-01. Devices that are designed to operate on the body of users using lanyards and straps, or without requiring additional body-worn accessories, will be tested using a conservative minimum test separation distance $\leq 5 \text{ mm}$ to support compliance.

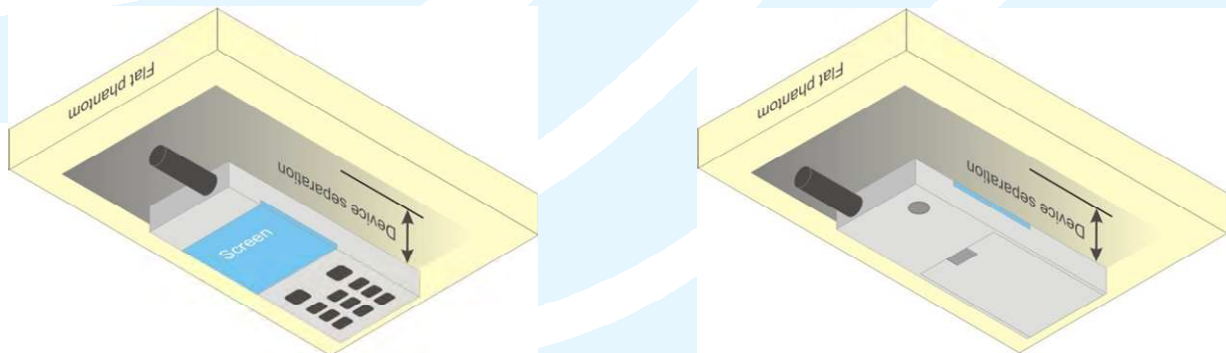
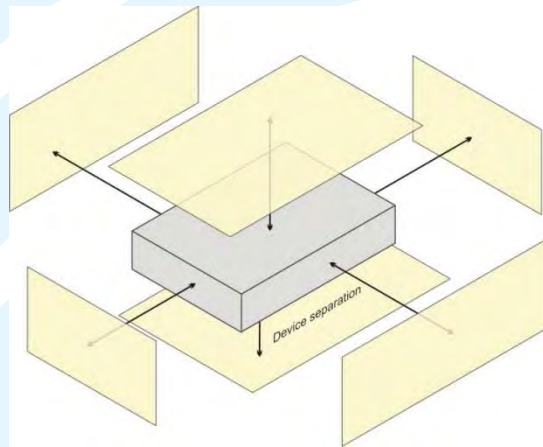

Fig-4.4 Illustration for Body Worn Position

4.2.3 Hotspot Mode Exposure Conditions

For handsets that support hotspot mode operations, with wireless router capabilities and various web browsing functions, the relevant hand and body exposure conditions are tested according to the hotspot SAR procedures in KDB 941225 D06. A test separation distance of 10 mm is required between the phantom and all surfaces and edges with a transmitting antenna located within 25 mm from that surface or edge. When the form factor of a handset is smaller than 9 cm x 5 cm, a test separation distance of 5 mm (instead of 10 mm) is required for testing hotspot mode. When the separation distance required for body-worn accessory testing is larger than or equal to that tested for hotspot mode, in the same wireless mode and for the same surface of the phone, the hotspot mode SAR data may be used to support body-worn accessory SAR compliance for that particular configuration (surface).



Based on the antenna location shown on appendix D of this report, the SAR testing required for hotspot mode is listed as below.

Antenna	Face upward	Back upward	Edge A	Edge B	Edge C	Edge D
WWAN Ant	Yes	Yes	N/A	Yes	Yes	Yes
WLAN / BT	Yes	Yes	Yes	Yes	N/A	Yes

4.3 Measured Conducted Power Result

The measuring conducted average power (Unit: dBm) is shown as below.

Band	GSM850			GSM1900		
Channel	128	190	251	512	661	810
Frequency (MHz)	824.2	836.6	848.8	1850.2	1880.0	1909.8
Maximum Burst-Averaged Output Power						
GSM (GMSK, 1Tx-slot)	32.39	32.46	32.51	29.17	29.41	29.19
GPRS (GMSK, 1Tx-slot)	32.44	32.49	32.50	29.19	29.40	29.21
GPRS (GMSK, 2Tx-slot)	30.13	30.15	30.19	27.45	27.53	27.37
GPRS (GMSK, 3Tx-slot)	28.20	28.25	28.25	25.89	25.82	25.91
GPRS (GMSK, 4Tx-slot)	27.10	27.16	27.07	24.71	24.78	24.76
EDGE (8PSK, 1Tx-slot)	24.93	24.87	24.77	24.83	24.88	24.71
EDGE (8PSK, 2Tx-slot)	23.83	23.97	23.76	23.75	23.82	23.77
EDGE (8PSK, 3Tx-slot)	22.76	22.79	22.84	22.67	22.72	22.71
EDGE (8PSK, 4Tx-slot)	21.71	21.80	21.75	21.62	21.57	21.60
Maximum Frame-Averaged Output Power						
GSM (GMSK, 1Tx-slot)	23.39	23.46	23.51	20.17	20.41	20.19
GPRS (GMSK, 1Tx-slot)	23.44	23.51	23.56	20.19	20.43	20.21
GPRS (GMSK, 2Tx-slot)	24.13	24.15	24.19	21.45	21.53	21.37
GPRS (GMSK, 3Tx-slot)	23.94	23.99	23.99	21.63	21.56	21.65
GPRS (GMSK, 4Tx-slot)	24.10	24.16	24.07	21.71	21.78	21.76
EDGE (8PSK, 1Tx-slot)	15.93	15.87	15.77	15.83	15.88	15.71
EDGE (8PSK, 2Tx-slot)	17.83	17.97	17.76	17.75	17.82	17.77
EDGE (8PSK, 3Tx-slot)	18.50	18.53	18.58	18.41	18.46	18.45
EDGE (8PSK, 4Tx-slot)	18.71	18.80	18.75	18.62	18.57	18.60

Note:

- SAR testing was performed on the maximum frame-averaged power mode.
- The frame-averaged power is linearly proportion to the slot number configured and it is linearly scaled the maximum burst-averaged power based on time slots. The calculated method is shown as below:

$$\text{Frame-averaged power} = 10 \times \log (\text{Burst-averaged power mW} \times \text{Slot used} / 8)$$

Band Channel	WCDMA Band II			WCDMA Band V			3GPP MPR (dB)
	9262	9400	9538	4132	4183	4233	
Frequency (MHz)	1852.4	1880.0	1907.6	826.4	836.6	846.6	
RMC 12.2K	22.76	22.63	22.80	22.83	22.76	22.68	-
HSDPA Subtest-1	21.38	21.33	21.36	21.45	21.41	21.38	0
HSDPA Subtest-2	21.29	21.23	21.37	21.35	21.40	21.31	0
HSDPA Subtest-3	20.78	20.81	20.75	20.92	20.87	20.81	0.5
HSDPA Subtest-4	20.57	20.61	20.58	20.81	20.82	20.79	0.5
DC-HSDPA Subtest-1	21.34	21.31	21.32	21.42	21.40	21.35	0
DC-HSDPA Subtest-2	21.26	21.25	21.34	21.37	21.37	21.33	0
DC-HSDPA Subtest-3	20.75	20.80	20.77	20.95	20.88	20.83	0.5
DC-HSDPA Subtest-4	20.54	20.63	20.55	20.86	20.84	20.77	0.5
HSUPA Subtest-1	20.15	20.09	20.11	20.29	20.18	20.17	0
HSUPA Subtest-2	19.14	19.21	19.18	19.31	19.37	19.24	2
HSUPA Subtest-3	19.45	19.37	19.41	19.51	19.45	19.53	1
HSUPA Subtest-4	19.32	19.25	19.31	19.36	19.38	19.40	2
HSUPA Subtest-5	20.51	20.47	20.58	20.67	20.68	20.72	0
HSPA+ Subtest-1	20.48	20.52	20.55	20.59	20.65	20.67	2.5

Shenzhen UnionTrust Quality and Technology Co., Ltd.

Address: 16/F, Block A, Building 6, Baoneng Science and Technology Park, Qingxiang Road No.1, Longhua New District, Shenzhen, China
 Tel: +86-755-28230888 Fax: +86-755-28230886 E-mail: info@uttlab.com [Http://www.uttlab.com](http://www.uttlab.com)

LTE Band / BW	RB Size	RB Offset	QPSK			3GPP MPR (dB)	16QAM			3GPP MPR (dB)
			Low CH 19957	Mid CH 20175	High CH 20393		Low CH 19957	Mid CH 20175	High CH 20393	
			1710.7 MHz	1732.5 MHz	1754.3 MHz		1710.7 MHz	1732.5 MHz	1754.3 MHz	
4 / 1.4M	1	0	22.25	22.27	22.13	0	20.89	20.94	20.97	1
	1	2	22.30	22.31	22.39	0	21.09	21.05	21.11	1
	1	5	22.13	22.10	22.22	0	20.72	20.82	20.95	1
	3	0	22.23	22.25	22.11	0	20.88	20.93	20.96	1
	3	1	22.28	22.29	22.37	0	21.08	21.04	21.10	1
	3	3	22.11	22.08	22.20	0	20.71	20.81	20.94	1
	6	0	21.20	21.21	21.34	1	20.32	20.13	20.34	2

LTE Band / BW	RB Size	RB Offset	QPSK			3GPP MPR (dB)	16QAM			3GPP MPR (dB)
			Low CH 19965	Mid CH 20175	High CH 20385		Low CH 19965	Mid CH 20175	High CH 20385	
			1711.5 MHz	1732.5 MHz	1753.5 MHz		1711.5 MHz	1732.5 MHz	1753.5 MHz	
4 / 3M	1	0	22.26	22.28	22.14	0	20.90	20.95	20.98	1
	1	7	22.31	22.32	22.40	0	21.10	21.06	21.12	1
	1	14	22.14	22.11	22.23	0	20.73	20.83	20.96	1
	8	0	21.24	21.18	21.39	1	20.11	20.27	20.39	2
	8	3	21.10	21.19	21.38	1	20.21	20.30	20.48	2
	8	7	21.29	21.30	21.45	1	20.19	20.28	20.44	2
	15	0	21.21	21.22	21.35	1	20.33	20.14	20.35	2

LTE Band / BW	RB Size	RB Offset	QPSK			3GPP MPR (dB)	16QAM			3GPP MPR (dB)
			Low CH 19975	Mid CH 20175	High CH 20375		Low CH 19975	Mid CH 20175	High CH 20375	
			1712.5 MHz	1732.5 MHz	1752.5 MHz		1712.5 MHz	1732.5 MHz	1752.5 MHz	
4 / 5M	1	0	22.29	22.31	22.17	0	20.93	20.98	21.01	1
	1	12	22.34	22.35	22.43	0	21.13	21.09	21.15	1
	1	24	22.17	22.14	22.26	0	20.76	20.86	20.99	1
	12	0	21.27	21.21	21.42	1	20.14	20.30	20.42	2
	12	6	21.13	21.22	21.41	1	20.24	20.33	20.51	2
	12	13	21.32	21.33	21.48	1	20.22	20.31	20.47	2
	25	0	21.24	21.25	21.38	1	20.36	20.17	20.38	2

LTE Band / BW	RB Size	RB Offset	QPSK			3GPP MPR (dB)	16QAM			3GPP MPR (dB)
			Low CH 20000	Mid CH 20175	High CH 20350		Low CH 20000	Mid CH 20175	High CH 20350	
			1715.0 MHz	1732.5 MHz	1750.0 MHz		1715.0 MHz	1732.5 MHz	1750.0 MHz	
4 / 10M	1	0	22.33	22.35	22.21	0	20.97	21.02	21.05	1
	1	24	22.38	22.39	22.47	0	21.17	21.13	21.19	1
	1	49	22.21	22.18	22.30	0	20.80	20.90	21.03	1
	25	0	21.31	21.25	21.46	1	20.18	20.34	20.46	2
	25	12	21.17	21.26	21.45	1	20.28	20.37	20.55	2
	25	25	21.36	21.37	21.52	1	20.26	20.35	20.51	2
	50	0	21.28	21.29	21.42	1	20.40	20.21	20.42	2

Shenzhen UnionTrust Quality and Technology Co., Ltd.

LTE Band / BW	RB Size	RB Offset	QPSK			3GPP MPR (dB)	16QAM			3GPP MPR (dB)
			Low CH 20025	Mid CH 20175	High CH 20325		Low CH 20025	Mid CH 20175	High CH 20325	
			1717.5 MHz	1732.5 MHz	1747.5 MHz		1717.5 MHz	1732.5 MHz	1747.5 MHz	
4 / 15M	1	0	22.39	22.41	22.27	0	21.03	21.08	21.11	1
	1	37	22.44	22.45	22.53	0	21.23	21.19	21.25	1
	1	74	22.27	22.24	22.36	0	20.86	20.96	21.09	1
	36	0	21.37	21.31	21.52	1	20.24	20.40	20.52	2
	36	19	21.23	21.32	21.51	1	20.34	20.43	20.61	2
	36	39	21.42	21.43	21.58	1	20.32	20.41	20.57	2
	75	0	21.34	21.35	21.48	1	20.46	20.27	20.48	2

LTE Band / BW	RB Size	RB Offset	QPSK			3GPP MPR (dB)	16QAM			3GPP MPR (dB)
			Low CH 20050	Mid CH 20175	High CH 20300		Low CH 20050	Mid CH 20175	High CH 20300	
			1720.0 MHz	1732.5 MHz	1745.0 MHz		1720.0 MHz	1732.5 MHz	1745.0 MHz	
4 / 20M	1	0	22.42	22.44	22.30	0	21.06	21.11	21.14	1
	1	50	22.47	22.48	22.56	0	21.26	21.22	21.28	1
	1	99	22.30	22.27	22.39	0	20.89	20.99	21.12	1
	50	0	21.40	21.34	21.55	1	20.27	20.43	20.55	2
	50	25	21.26	21.35	21.54	1	20.37	20.46	20.64	2
	50	50	21.45	21.46	21.61	1	20.35	20.44	20.60	2
	100	0	21.37	21.38	21.51	1	20.49	20.30	20.51	2

Shenzhen UnionTrust Quality and Technology Co., Ltd.

LTE Band / BW	RB Size	RB Offset	QPSK			3GPP MPR (dB)	16QAM			3GPP MPR (dB)
			Low CH 20407	Mid CH 20525	High CH 20643		Low CH 20407	Mid CH 20525	High CH 20643	
			824.7 MHz	836.5 MHz	848.3 MHz		824.7 MHz	836.5 MHz	848.3 MHz	
5 / 1.4M	1	0	22.52	22.58	22.49	0	21.10	21.49	21.14	1
	1	2	22.51	22.52	22.48	0	21.08	21.44	21.06	1
	1	5	22.41	22.52	22.26	0	20.96	21.12	20.68	1
	3	0	22.50	22.56	22.47	0	21.09	21.48	21.13	1
	3	1	22.49	22.50	22.46	0	21.07	21.43	21.05	1
	3	3	22.39	22.50	22.24	0	20.95	21.11	20.67	1
	6	0	21.61	21.47	21.45	1	20.69	20.67	20.56	2

LTE Band / BW	RB Size	RB Offset	QPSK			3GPP MPR (dB)	16QAM			3GPP MPR (dB)
			Low CH 20415	Mid CH 20525	High CH 20635		Low CH 20415	Mid CH 20525	High CH 20635	
			825.5 MHz	836.5 MHz	847.5 MHz		825.5 MHz	836.5 MHz	847.5 MHz	
5 / 3M	1	0	22.56	22.62	22.53	0	21.14	21.53	21.18	1
	1	7	22.55	22.56	22.52	0	21.12	21.48	21.10	1
	1	14	22.45	22.56	22.30	0	21.00	21.16	20.72	1
	8	0	21.56	21.54	21.50	1	20.75	20.66	20.63	2
	8	3	21.61	21.60	21.52	1	20.79	20.72	20.53	2
	8	7	21.57	21.58	21.47	1	20.68	20.52	20.49	2
	15	0	21.65	21.51	21.49	1	20.73	20.71	20.60	2

LTE Band / BW	RB Size	RB Offset	QPSK			3GPP MPR (dB)	16QAM			3GPP MPR (dB)
			Low CH 20425	Mid CH 20525	High CH 20625		Low CH 20425	Mid CH 20525	High CH 20625	
			826.5 MHz	836.5 MHz	846.5 MHz		826.5 MHz	836.5 MHz	846.5 MHz	
5 / 5M	1	0	22.62	22.68	22.59	0	21.20	21.59	21.24	1
	1	12	22.61	22.62	22.58	0	21.18	21.54	21.16	1
	1	24	22.51	22.62	22.36	0	21.06	21.22	20.78	1
	12	0	21.62	21.60	21.56	1	20.81	20.72	20.69	2
	12	6	21.67	21.66	21.58	1	20.85	20.78	20.59	2
	12	13	21.63	21.64	21.53	1	20.74	20.58	20.55	2
	25	0	21.71	21.57	21.55	1	20.79	20.77	20.66	2

LTE Band / BW	RB Size	RB Offset	QPSK			3GPP MPR (dB)	16QAM			3GPP MPR (dB)
			Low CH 20450	Mid CH 20525	High CH 20600		Low CH 20450	Mid CH 20525	High CH 20600	
			829.0 MHz	836.5 MHz	844.0 MHz		829.0 MHz	836.5 MHz	844.0 MHz	
5 / 10M	1	0	22.65	22.71	22.62	0	21.23	21.62	21.27	1
	1	24	22.64	22.65	22.61	0	21.21	21.57	21.19	1
	1	49	22.54	22.65	22.39	0	21.09	21.25	20.81	1
	25	0	21.65	21.63	21.59	1	20.84	20.75	20.72	2
	25	12	21.70	21.69	21.61	1	20.88	20.81	20.62	2
	25	25	21.66	21.67	21.56	1	20.77	20.61	20.58	2
	50	0	21.74	21.60	21.58	1	20.82	20.80	20.69	2

Shenzhen UnionTrust Quality and Technology Co., Ltd.

LTE Band / BW	RB Size	RB Offset	QPSK			3GPP MPR (dB)	16QAM			3GPP MPR (dB)
			Low CH 20775	Mid CH 21100	High CH 21425		Low CH 20775	Mid CH 21100	High CH 21425	
			2502.5 MHz	2535.0 MHz	2567.5 MHz		2502.5 MHz	2535.0 MHz	2567.5 MHz	
7 / 5M	1	0	22.76	22.55	22.49	0	21.38	21.33	20.99	1
	1	12	22.75	22.54	22.40	0	21.27	21.47	21.28	1
	1	24	22.67	22.38	22.32	0	21.40	21.05	21.18	1
	12	0	21.68	21.73	21.34	1	20.69	20.73	20.31	2
	12	6	21.76	21.78	21.56	1	20.76	20.77	20.55	2
	12	13	21.74	21.61	21.55	1	20.75	20.57	20.57	2
	25	0	21.67	21.74	21.37	1	20.75	20.76	20.41	2

LTE Band / BW	RB Size	RB Offset	QPSK			3GPP MPR (dB)	16QAM			3GPP MPR (dB)
			Low CH 20800	Mid CH 21100	High CH 21400		Low CH 20800	Mid CH 21100	High CH 21400	
			2505.0 MHz	2535.0 MHz	2565.0 MHz		2505.0 MHz	2535.0 MHz	2565.0 MHz	
7 / 10M	1	0	22.80	22.59	22.53	0	21.42	21.37	21.03	1
	1	24	22.79	22.58	22.44	0	21.31	21.51	21.32	1
	1	49	22.71	22.42	22.36	0	21.44	21.09	21.22	1
	25	0	21.72	21.77	21.38	1	20.73	20.77	20.35	2
	25	12	21.80	21.82	21.60	1	20.80	20.81	20.59	2
	25	25	21.78	21.65	21.59	1	20.79	20.61	20.61	2
	50	0	21.71	21.78	21.41	1	20.79	20.80	20.45	2

LTE Band / BW	RB Size	RB Offset	QPSK			3GPP MPR (dB)	16QAM			3GPP MPR (dB)
			Low CH 20825	Mid CH 21100	High CH 21375		Low CH 20825	Mid CH 21100	High CH 21375	
			2507.5 MHz	2535.0 MHz	2562.5 MHz		2507.5 MHz	2535.0 MHz	2562.5 MHz	
7 / 15M	1	0	22.86	22.65	22.59	0	21.48	21.43	21.09	1
	1	37	22.85	22.64	22.50	0	21.37	21.57	21.38	1
	1	74	22.77	22.48	22.42	0	21.50	21.15	21.28	1
	36	0	21.78	21.83	21.44	1	20.79	20.83	20.41	2
	36	19	21.86	21.88	21.66	1	20.86	20.87	20.65	2
	36	39	21.84	21.71	21.65	1	20.85	20.67	20.67	2
	75	0	21.77	21.84	21.47	1	20.85	20.86	20.51	2

LTE Band / BW	RB Size	RB Offset	QPSK			3GPP MPR (dB)	16QAM			3GPP MPR (dB)
			Low CH 20850	Mid CH 21100	High CH 21350		Low CH 20850	Mid CH 21100	High CH 21350	
			2510.0 MHz	2535.0 MHz	2560.0 MHz		2510.0 MHz	2535.0 MHz	2560.0 MHz	
7 / 20M	1	0	22.89	22.68	22.62	0	21.51	21.46	21.12	1
	1	50	22.88	22.67	22.53	0	21.40	21.60	21.41	1
	1	99	22.80	22.51	22.45	0	21.53	21.18	21.31	1
	50	0	21.81	21.86	21.47	1	20.82	20.86	20.44	2
	50	25	21.89	21.91	21.69	1	20.89	20.90	20.68	2
	50	50	21.87	21.74	21.68	1	20.88	20.70	20.70	2
	100	0	21.80	21.87	21.50	1	20.88	20.89	20.54	2

Shenzhen UnionTrust Quality and Technology Co., Ltd.

LTE Band / BW	RB Size	RB Offset	QPSK			3GPP MPR (dB)	16QAM			3GPP MPR (dB)
			Low CH 40265	Mid CH 40740	High CH 41215		Low CH 40265	Mid CH 40740	High CH 41215	
			2557.5 MHz	2605 MHz	2652.5 MHz		2557.5 MHz	2605 MHz	2652.5 MHz	
41 / 5M	1	0	22.28	22.43	22.47	0	20.99	20.70	21.17	1
	1	12	22.77	22.71	22.88	0	21.13	21.18	21.27	1
	1	24	22.34	22.54	22.78	0	20.94	21.05	21.28	1
	12	0	21.56	21.55	21.64	1	20.36	20.30	20.53	2
	12	6	21.49	21.47	21.58	1	20.47	20.35	20.38	2
	12	13	21.48	21.54	21.62	1	20.45	20.41	20.51	2
	25	0	21.41	21.57	21.62	1	20.49	20.40	20.55	2

LTE Band / BW	RB Size	RB Offset	QPSK			3GPP MPR (dB)	16QAM			3GPP MPR (dB)
			Low CH 40290	Mid CH 40740	High CH 41190		Low CH 40290	Mid CH 40740	High CH 41190	
			2560 MHz	2605 MHz	2650 MHz		2560 MHz	2605 MHz	2650 MHz	
41 / 10M	1	0	22.31	22.46	22.50	0	21.02	20.73	21.20	1
	1	24	22.80	22.74	22.91	0	21.16	21.21	21.30	1
	1	49	22.37	22.57	22.81	0	20.97	21.08	21.31	1
	25	0	21.59	21.58	21.67	1	20.39	20.33	20.56	2
	25	12	21.52	21.50	21.61	1	20.50	20.38	20.41	2
	25	25	21.51	21.57	21.65	1	20.48	20.44	20.54	2
	50	0	21.44	21.60	21.65	1	20.52	20.43	20.58	2

LTE Band / BW	RB Size	RB Offset	QPSK			3GPP MPR (dB)	16QAM			3GPP MPR (dB)
			Low CH 40315	Mid CH 40740	High CH 41165		Low CH 40315	Mid CH 40740	High CH 41165	
			2562.5 MHz	2605 MHz	2647.5 MHz		2562.5 MHz	2605 MHz	2647.5 MHz	
41 / 15M	1	0	22.35	22.50	22.54	0	21.06	20.77	21.24	1
	1	37	22.84	22.78	22.95	0	21.20	21.25	21.34	1
	1	74	22.41	22.61	22.85	0	21.01	21.12	21.35	1
	36	0	21.63	21.62	21.71	1	20.43	20.37	20.60	2
	36	19	21.56	21.54	21.65	1	20.54	20.42	20.45	2
	36	39	21.55	21.61	21.69	1	20.52	20.48	20.58	2
	75	0	21.48	21.64	21.69	1	20.56	20.47	20.62	2

LTE Band / BW	RB Size	RB Offset	QPSK			3GPP MPR (dB)	16QAM			3GPP MPR (dB)
			Low CH 40340	Mid CH 40740	High CH 41140		Low CH 40340	Mid CH 40740	High CH 41140	
			2565 MHz	2605 MHz	2645 MHz		2565 MHz	2605 MHz	2645 MHz	
41 / 20M	1	0	22.41	22.56	22.60	0	21.12	20.83	21.30	1
	1	50	22.90	22.84	23.01	0	21.26	21.31	21.40	1
	1	99	22.47	22.67	22.91	0	21.07	21.18	21.41	1
	50	0	21.69	21.68	21.77	1	20.49	20.43	20.66	2
	50	25	21.62	21.60	21.71	1	20.60	20.48	20.51	2
	50	50	21.61	21.67	21.75	1	20.58	20.54	20.64	2
	100	0	21.54	21.70	21.75	1	20.62	20.53	20.68	2

Shenzhen UnionTrust Quality and Technology Co., Ltd.

<WLAN 2.4G>

Mode		802.11b		
Channel / Frequency (MHz)	1 (2412)	6 (2437)	11 (2462)	
Average Power	14.98	14.17	14.40	
Mode		802.11g		
Channel / Frequency (MHz)	1 (2412)	6 (2437)	11 (2462)	
Average Power	13.52	13.43	13.95	
Mode		802.11n (HT20)		
Channel / Frequency (MHz)	1 (2412)	6 (2437)	11 (2462)	
Average Power	12.48	12.42	12.97	

<Bluetooth>

Mode		Bluetooth GFSK		
Channel / Frequency (MHz)	0 (2402)	39 (2441)	78 (2480)	
Average Power	10.13	11.15	8.46	
Mode		Bluetooth $\pi/4$ -DQPSK		
Channel / Frequency (MHz)	0 (2402)	39 (2441)	78 (2480)	
Average Power	9.34	10.24	7.56	
Mode		Bluetooth 8-DPSK		
Channel / Frequency (MHz)	0 (2402)	39 (2441)	78 (2480)	
Average Power	9.31	10.26	7.58	
Mode		Bluetooth LE		
Channel / Frequency (MHz)	0 (2402)	19 (2440)	39 (2480)	
Average Power	0.75	1.66	-0.79	

4.4 SAR Test Exclusion Evaluations

According to KDB 447498 D01, the SAR test exclusion condition is based on source-based time-averaged maximum conducted output power, adjusted for tune-up tolerance, and the minimum test separation distance required for the exposure conditions. The SAR exclusion threshold is determined by the following formula.

$$\frac{\text{Max. Tune up Power}_{(mW)}}{\text{Min. Test Separation Distance}_{(mm)}} \times \sqrt{f_{(GHz)}} \leq 3.0 \text{ for SAR-1g, } \leq 7.5 \text{ for SAR-10g}$$

When the minimum test separation distance is < 5 mm, a distance of 5 mm is applied to determine SAR test exclusion.

Mode	Max. Tune-up Power (dBm)	Max. Tune-up Power (mW)	Body-Worn		
			Ant. to Surface (mm)	Calculated Result	Require SAR Testing?
BT (2.48 GHz)	11.2	13.18	10	2.1	No

Note:

1. When separation distance <= 50 mm and the calculated result shown in above table is <= 3.0 for SAR-1g exposure condition, or <= 7.5 for SAR-10g exposure condition, the SAR testing exclusion is applied.

<Estimated SAR Calculation>

According to KDB 447498 D01, when standalone SAR test exclusion applies to an antenna that transmits simultaneously with other antennas, the standalone SAR was estimated according to following formula to result in substantially conservative SAR values of <= 0.4 W/kg to determine simultaneous transmission SAR test exclusion.

$$\text{Estimated SAR} = \frac{\text{Max. Tune up Power}_{(mW)}}{\text{Min. Test Separation Distance}_{(mm)}} \times \frac{\sqrt{f_{(GHz)}}}{7.5}$$

If the minimum test separation distance is < 5 mm, a distance of 5 mm is used for estimated SAR calculation. When the test separation distance is > 50 mm, the 0.4 W/kg is used for SAR-1g.

Mode / Band	Frequency (GHz)	Max. Tune-up Power (dBm)	Test Position	Separation Distance (mm)	Estimated SAR (W/kg)
BT (DSS)	2.48	11.2	Body-worn	10	0.28

Note:

1. The separation distance is determined from the outer housing of the EUT to the user.
2. When standalone SAR testing is not required, an estimated SAR can be applied to determine simultaneous transmission SAR test exclusion.

4.5 SAR Testing Results

4.5.1 SAR Test Reduction Considerations

<KDB 447498 D01, General RF Exposure Guidance>

Testing of other required channels within the operating mode of a frequency band is not required when the reported SAR for the mid-band or highest output power channel is:

- (1) ≤ 0.8 W/kg or 2.0 W/kg, for 1-g or 10-g respectively, when the transmission band is ≤ 100 MHz
- (2) ≤ 0.6 W/kg or 1.5 W/kg, for 1-g or 10-g respectively, when the transmission band is between 100 MHz and 200 MHz
- (3) ≤ 0.4 W/kg or 1.0 W/kg, for 1-g or 10-g respectively, when the transmission band is ≥ 200 MHz

<KDB 941225 D01, 3G SAR Measurement Procedures>

The mode tested for SAR is referred to as the primary mode. The equivalent modes considered for SAR test reduction are denoted as secondary modes. Both primary and secondary modes must be in the same frequency band. When the maximum output power and tune-up tolerance specified for production units in a secondary mode is $\leq 1/4$ dB higher than the primary mode or when the highest reported SAR of the primary mode is scaled by the ratio of specified maximum output power and tune-up tolerance of secondary to primary mode and the adjusted SAR is ≤ 1.2 W/kg, SAR measurement is not required for the secondary mode.

<KDB 941225 D05, SAR Evaluation Considerations for LTE Devices>

- (1) QPSK with 1 RB and 50% RB allocation

Start with the largest channel bandwidth and measure SAR, using the RB offset and required test channel combination with the highest maximum output power among RB offsets at the upper edge, middle and lower edge of each required test channel. When the reported SAR is ≤ 0.8 W/kg, testing of the remaining RB offset configurations and required test channels is not required; otherwise, SAR is required for the remaining required test channels and only for the RB offset configuration with the highest output power for that channel. When the reported SAR of a required test channel is > 1.45 W/kg, SAR is required for all three RB offset configurations for that required test channel.

- (2) QPSK with 100% RB allocation

SAR is not required when the highest maximum output power for 100% RB allocation is less than the highest maximum output power in 50% and 1 RB allocations and the highest reported SAR for 1 RB and 50% RB allocation are ≤ 0.8 W/kg. Otherwise, SAR is measured for the highest output power channel; and if the reported SAR is > 1.45 W/kg, the remaining required test channels must also be tested.

- (3) Higher order modulations

SAR is required only when the highest maximum output power for the configuration in the higher order modulation is $> 1/2$ dB higher than the same configuration in QPSK or when the reported SAR for the QPSK configuration is > 1.45 W/kg.

- (4) Other channel bandwidth

SAR is required when the highest maximum output power of the smaller channel bandwidth is $> 1/2$ dB higher than the equivalent channel configurations in the largest channel bandwidth configuration or the reported SAR of a configuration for the largest channel bandwidth is > 1.45 W/kg.

Shenzhen UnionTrust Quality and Technology Co., Ltd.

<KDB 248227 D01, SAR Guidance for Wi-Fi Transmitters>

- (1) For handsets operating next to ear, hotspot mode or mini-tablet configurations, the initial test position procedures were applied. The test position with the highest extrapolated peak SAR will be used as the initial test position. When the reported SAR of initial test position is ≤ 0.4 W/kg, SAR testing for remaining test positions is not required. Otherwise, SAR is evaluated at the subsequent highest peak SAR positions until the reported SAR result is ≤ 0.8 W/kg or all test positions are measured.
- (2) For WLAN 2.4 GHz, the highest measured maximum output power channel for DSSS was selected for SAR measurement. When the reported SAR is ≤ 0.8 W/kg, no further SAR testing is required. Otherwise, SAR is evaluated at the next highest measured output power channel. When any reported SAR is > 1.2 W/kg, SAR is required for the third channel. For OFDM modes (802.11g/n), SAR is not required when the highest reported SAR for DSSS is adjusted by the ratio of OFDM to DSSS specified maximum output power and it is ≤ 1.2 W/kg.

4.5.2 SAR Results for Head Exposure Condition

Plot No.	Band	Mode	Test Position	Ch.	Battery	Max. Tune-up Power (dBm)	Measured Conducted Power (dBm)	Measured SAR-1g (W/kg)	Scaling Factor	Scaled SAR-1g (W/kg)
1	GSM850	GSM	Right Cheek	190	1	33.0	32.46	0.295	1.13	0.33
	GSM850	GSM	Right Tilted	190	1	33.0	32.46	0.237	1.13	0.27
	GSM850	GSM	Left Cheek	190	1	33.0	32.46	0.272	1.13	0.31
	GSM850	GSM	Left Tilted	190	1	33.0	32.46	0.23	1.13	0.26
	GSM850	GSM	Right Cheek	190	2	33.0	32.46	0.258	1.13	0.29
	GSM1900	GSM	Right Cheek	661	1	30.0	29.41	0.077	1.15	0.09
	GSM1900	GSM	Right Tilted	661	1	30.0	29.41	0.075	1.15	0.09
	GSM1900	GSM	Left Cheek	661	1	30.0	29.41	0.258	1.15	0.30
4	GSM1900	GSM	Left Tilted	661	1	30.0	29.41	0.128	1.15	0.15
	GSM1900	GSM	Left Cheek	661	2	30.0	29.41	0.24	1.15	0.27
	WCDMA II	RMC12.2K	Right Cheek	9400	1	23.0	22.63	0.146	1.09	0.16
	WCDMA II	RMC12.2K	Right Tilted	9400	1	23.0	22.63	0.062	1.09	0.07
	WCDMA II	RMC12.2K	Left Cheek	9400	1	23.0	22.63	0.219	1.09	0.24
7	WCDMA II	RMC12.2K	Left Tilted	9400	1	23.0	22.63	0.113	1.09	0.12
	WCDMA II	RMC12.2K	Left Cheek	9400	2	23.0	22.63	0.185	1.09	0.20
9	WCDMA V	RMC12.2K	Right Cheek	4183	1	23.0	22.76	0.273	1.06	0.29
	WCDMA V	RMC12.2K	Right Tilted	4183	1	23.0	22.76	0.195	1.06	0.21
	WCDMA V	RMC12.2K	Left Cheek	4183	1	23.0	22.76	0.216	1.06	0.23
	WCDMA V	RMC12.2K	Left Tilted	4183	1	23.0	22.76	0.181	1.06	0.19
	WCDMA V	RMC12.2K	Right Cheek	4183	2	23.0	22.76	0.258	1.06	0.27

Plot No.	Band	Mode	Test Position	Ch.	Battery	RB#	RB Offset	Max. Tune-up Power (dBm)	Measured Conducted Power (dBm)	Measured SAR-1g (W/kg)	Scaling Factor	Scaled SAR-1g (W/kg)
	LTE 4	QPSK20M	Right Cheek	20175	1	1	50	23.0	22.48	0.212	1.13	0.24
	LTE 4	QPSK20M	Right Tilted	20175	1	1	50	23.0	22.48	0.108	1.13	0.12
11	LTE 4	QPSK20M	Left Cheek	20175	1	1	50	23.0	22.48	0.229	1.13	0.26
	LTE 4	QPSK20M	Left Tilted	20175	1	1	50	23.0	22.48	0.218	1.13	0.25
	LTE 4	QPSK20M	Right Cheek	20175	1	50	50	22.0	21.46	0.183	1.13	0.21
	LTE 4	QPSK20M	Right Tilted	20175	1	50	50	22.0	21.46	0.09	1.13	0.10
	LTE 4	QPSK20M	Left Cheek	20175	1	50	50	22.0	21.46	0.226	1.13	0.26
	LTE 4	QPSK20M	Left Tilted	20175	1	50	50	22.0	21.46	0.211	1.13	0.24
	LTE 4	QPSK20M	Left Cheek	20175	2	1	50	23.0	22.48	0.21	1.13	0.24
13	LTE 5	QPSK10M	Right Cheek	20525	1	1	0	23.0	22.71	0.182	1.07	0.19
	LTE 5	QPSK10M	Right Tilted	20525	1	1	0	23.0	22.71	0.146	1.07	0.16
	LTE 5	QPSK10M	Left Cheek	20525	1	1	0	23.0	22.71	0.157	1.07	0.17
	LTE 5	QPSK10M	Left Tilted	20525	1	1	0	23.0	22.71	0.146	1.07	0.16
	LTE 5	QPSK10M	Right Cheek	20525	1	25	12	22.0	21.69	0.162	1.07	0.17
	LTE 5	QPSK10M	Right Tilted	20525	1	25	12	22.0	21.69	0.14	1.07	0.15
	LTE 5	QPSK10M	Left Cheek	20525	1	25	12	22.0	21.69	0.154	1.07	0.17
	LTE 5	QPSK10M	Left Tilted	20525	1	25	12	22.0	21.69	0.138	1.07	0.15
	LTE 5	QPSK10M	Right Cheek	20525	2	1	0	23.0	22.71	0.174	1.07	0.19
	LTE 7	QPSK20M	Right Cheek	21100	1	1	0	23.0	22.68	0.137	1.08	0.15
	LTE 7	QPSK20M	Right Tilted	21100	1	1	0	23.0	22.68	0.122	1.08	0.13
15	LTE 7	QPSK20M	Left Cheek	21100	1	1	0	23.0	22.68	0.243	1.08	0.26
	LTE 7	QPSK20M	Left Tilted	21100	1	1	0	23.0	22.68	0.142	1.08	0.15
	LTE 7	QPSK20M	Right Cheek	21100	1	50	25	22.0	21.91	0.108	1.02	0.11
	LTE 7	QPSK20M	Right Tilted	21100	1	50	25	22.0	21.91	0.103	1.02	0.11
	LTE 7	QPSK20M	Left Cheek	21100	1	50	25	22.0	21.91	0.231	1.02	0.24
	LTE 7	QPSK20M	Left Tilted	21100	1	50	25	22.0	21.91	0.124	1.02	0.13
	LTE 7	QPSK20M	Left Cheek	21100	2	1	0	23.0	22.68	0.231	1.08	0.25
	LTE 41	QPSK20M	Right Cheek	40740	1	1	50	23.5	22.84	0.076	1.16	0.09
	LTE 41	QPSK20M	Right Tilted	40740	1	1	50	23.5	22.84	0.049	1.16	0.06
17	LTE 41	QPSK20M	Left Cheek	40740	1	1	50	23.5	22.84	0.153	1.16	0.18
	LTE 41	QPSK20M	Left Tilted	40740	1	1	50	23.5	22.84	0.093	1.16	0.11
	LTE 41	QPSK20M	Right Cheek	40740	1	50	0	22.5	21.68	0.065	1.21	0.08
	LTE 41	QPSK20M	Right Tilted	40740	1	50	0	22.5	21.68	0.04	1.21	0.05
	LTE 41	QPSK20M	Left Cheek	40740	1	50	0	22.5	21.68	0.144	1.21	0.17
	LTE 41	QPSK20M	Left Tilted	40740	1	50	0	22.5	21.68	0.078	1.21	0.09
	LTE 41	QPSK20M	Left Cheek	40740	2	1	50	23.5	22.84	0.14	1.16	0.16

Shenzhen UnionTrust Quality and Technology Co., Ltd.

Address: 16/F, Block A, Building 6, Baoneng Science and Technology Park, Qingxiang Road No.1, Longhua New District, Shenzhen, China
 Tel: +86-755-28230888 Fax: +86-755-28230886 E-mail: info@uttlab.com [Http://www.uttlab.com](http://www.uttlab.com)

Plot No.	Band	Mode	Test Position	Ch.	Battery	Max. Tune-up Power (dBm)	Measured Conducted Power (dBm)	Measured SAR-1g (W/kg)	Scaling Factor	Scaled SAR-1g (W/kg)
	802.11b	-	Right Cheek	1	1	15.0	14.98	0.286	1.00	0.29
19	802.11b	-	Right Tilted	1	1	15.0	14.98	0.533	1.00	0.54
	802.11b	-	Left Cheek	1	1	15.0	14.98	0.245	1.00	0.25
	802.11b	-	Left Tilted	1	1	15.0	14.98	0.447	1.00	0.45
	802.11b	-	Right Tilted	1	2	15.0	14.98	0.485	1.00	0.49
	BT	GFSK	Right Cheek	39	1	11.2	11.15	0.18	1.01	0.18
22	BT	GFSK	Right Tilted	39	1	11.2	11.15	0.218	1.01	0.22
	BT	GFSK	Left Cheek	39	1	11.2	11.15	0.151	1.01	0.15
	BT	GFSK	Left Tilted	39	1	11.2	11.15	0.185	1.01	0.19
	BT	GFSK	Right Tilted	39	2	11.2	11.15	0.173	1.01	0.18

Shenzhen UnionTrust Quality and Technology Co., Ltd.

Address: 16/F, Block A, Building 6, Baoneng Science and Technology Park, Qingxiang Road No.1, Longhua New District, Shenzhen, China
 Tel: +86-755-28230888 Fax: +86-755-28230886 E-mail: info@uttlab.com [Http://www.uttlab.com](http://www.uttlab.com)

4.5.3 SAR Results for Body-worn Exposure Condition (Separation Distance is 1.0 cm)

Plot No.	Band	Mode	Test Position	Ch.	Battery	Max. Tune-up Power (dBm)	Measured Conducted Power (dBm)	Measured SAR-1g (W/kg)	Scaling Factor	Scaled SAR-1g (W/kg)
2	GSM850	GSM	Face upward	190	1	33.0	32.46	0.338	1.13	0.38
	GSM850	GSM	Back upward	190	1	33.0	32.46	0.395	1.13	0.45
	GSM850	GSM	Back upward	190	2	33.0	32.46	0.368	1.13	0.42
5	GSM1900	GSM	Face upward	661	1	30.0	29.41	0.295	1.15	0.34
	GSM1900	GSM	Back upward	661	1	30.0	29.41	0.406	1.15	0.47
	GSM1900	GSM	Back upward	661	2	30.0	29.41	0.311	1.15	0.36
16	WCDMA II	RMC12.2K	Face upward	9400	1	23.0	22.63	0.362	1.09	0.39
	WCDMA II	RMC12.2K	Back upward	9400	1	23.0	22.63	0.586	1.09	0.64
	WCDMA II	RMC12.2K	Back upward	9400	2	23.0	22.63	0.394	1.09	0.43
17	WCDMA V	RMC12.2K	Face upward	4183	1	23.0	22.76	0.294	1.06	0.31
	WCDMA V	RMC12.2K	Back upward	4183	1	23.0	22.76	0.426	1.06	0.45
	WCDMA V	RMC12.2K	Back upward	4183	2	23.0	22.76	0.417	1.06	0.44

Plot No.	Band	Mode	Test Position	Ch.	Battery	RB#	RB Offset	Max. Tune-up Power (dBm)	Measured Conducted Power (dBm)	Measured SAR-1g (W/kg)	Scaling Factor	Scaled SAR-1g (W/kg)
18	LTE 4	QPSK20M	Face upward	20175	1	1	50	23.0	22.48	0.378	1.13	0.43
	LTE 4	QPSK20M	Back upward	20175	1	1	50	23.0	22.48	0.581	1.13	0.65
	LTE 4	QPSK20M	Face upward	20175	1	50	50	22.0	21.46	0.247	1.13	0.28
	LTE 4	QPSK20M	Back upward	20175	1	50	50	22.0	21.46	0.505	1.13	0.57
	LTE 4	QPSK20M	Back upward	20175	2	1	50	23.0	22.48	0.328	1.13	0.37
19	LTE 5	QPSK10M	Face upward	20525	1	1	0	23.0	22.71	0.166	1.07	0.18
	LTE 5	QPSK10M	Back upward	20525	1	1	0	23.0	22.71	0.26	1.07	0.28
	LTE 5	QPSK10M	Face upward	20525	1	25	12	22.0	21.69	0.165	1.07	0.18
	LTE 5	QPSK10M	Back upward	20525	1	25	12	22.0	21.69	0.23	1.07	0.25
	LTE 5	QPSK10M	Back upward	20525	2	1	0	23.0	22.71	0.241	1.07	0.26
20	LTE 7	QPSK20M	Face upward	21100	1	1	0	23.0	22.68	0.682	1.08	0.73
	LTE 7	QPSK20M	Back upward	21100	1	1	0	23.0	22.68	0.76	1.08	0.82
	LTE 7	QPSK20M	Face upward	21100	1	50	25	22.0	21.91	0.311	1.02	0.32
	LTE 7	QPSK20M	Back upward	21100	1	50	25	22.0	21.91	0.428	1.02	0.44
	LTE 7	QPSK20M	Back upward	20850	1	1	0	23.0	22.89	0.573	1.03	0.59
	LTE 7	QPSK20M	Back upward	21350	1	1	0	23.0	22.62	0.689	1.09	0.75
	LTE 7	QPSK20M	Back upward	21100	1	100	0	22.0	21.87	0.398	1.03	0.41
	LTE 7	QPSK20M	Back upward	21100	2	1	0	23.0	22.68	0.737	1.08	0.79
21	LTE 41	QPSK20M	Face upward	40740	1	1	50	23.5	22.84	0.213	1.16	0.25
	LTE 41	QPSK20M	Back upward	40740	1	1	50	23.5	22.84	0.438	1.16	0.51
	LTE 41	QPSK20M	Face upward	40740	1	50	0	22.5	21.68	0.16	1.21	0.19
	LTE 41	QPSK20M	Back upward	40740	1	50	0	22.5	21.68	0.351	1.21	0.42
LTE 41	QPSK20M	Back upward	40740	2	1	50	23.5	22.84	0.318	1.16	0.37	

Plot No.	Band	Mode	Test Position	Ch.	Battery	Max. Tune-up Power (dBm)	Measured Conducted Power (dBm)	Measured SAR-1g (W/kg)	Scaling Factor	Scaled SAR-1g (W/kg)
20	802.11b	-	Face upward	1	1	15.0	14.98	0.148	1.00	0.15
	802.11b	-	Back upward	1	1	15.0	14.98	0.402	1.00	0.40
	802.11b	-	Back upward	1	2	15.0	14.98	0.194	1.00	0.19

4.5.4 SAR Results for Hotspot Exposure Condition (Separation Distance is 1.0 cm)

Plot No.	Band	Mode	Test Position	Ch.	Battery	Max. Tune-up Power (dBm)	Measured Conducted Power (dBm)	Measured SAR-1g (W/kg)	Scaling Factor	Scaled SAR-1g (W/kg)
3	GSM850	GPRS10	Face upward	190	1	30.5	30.15	0.362	1.08	0.39
	GSM850	GPRS10	Back upward	190	1	30.5	30.15	0.48	1.08	0.52
	GSM850	GPRS10	Edge B	190	1	30.5	30.15	0.33	1.08	0.36
	GSM850	GPRS10	Edge C	190	1	30.5	30.15	0.134	1.08	0.15
	GSM850	GPRS10	Edge D	190	1	30.5	30.15	0.282	1.08	0.31
	GSM850	GPRS10	Back upward	190	2	30.5	30.15	0.472	1.08	0.51
6	GSM1900	GPRS12	Face upward	661	1	25.0	24.78	0.436	1.05	0.46
	GSM1900	GPRS12	Back upward	661	1	25.0	24.78	0.657	1.05	0.69
	GSM1900	GPRS12	Edge B	661	1	25.0	24.78	0.116	1.05	0.12
	GSM1900	GPRS12	Edge C	661	1	25.0	24.78	0.509	1.05	0.54
	GSM1900	GPRS12	Edge D	661	1	25.0	24.78	0.197	1.05	0.21
	GSM1900	GPRS12	Back upward	661	2	25.0	24.78	0.511	1.05	0.54
8	WCDMA II	RMC12.2K	Face upward	9400	1	23.0	22.63	0.362	1.09	0.39
	WCDMA II	RMC12.2K	Back upward	9400	1	23.0	22.63	0.586	1.09	0.64
	WCDMA II	RMC12.2K	Edge B	9400	1	23.0	22.63	0.101	1.09	0.11
	WCDMA II	RMC12.2K	Edge C	9400	1	23.0	22.63	0.353	1.09	0.38
	WCDMA II	RMC12.2K	Edge D	9400	1	23.0	22.63	0.072	1.09	0.08
	WCDMA II	RMC12.2K	Back upward	9400	2	23.0	22.63	0.394	1.09	0.43
10	WCDMA V	RMC12.2K	Face upward	4183	1	23.0	22.76	0.294	1.06	0.31
	WCDMA V	RMC12.2K	Back upward	4183	1	23.0	22.76	0.426	1.06	0.45
	WCDMA V	RMC12.2K	Edge B	4183	1	23.0	22.76	0.353	1.06	0.37
	WCDMA V	RMC12.2K	Edge C	4183	1	23.0	22.76	0.153	1.06	0.16
	WCDMA V	RMC12.2K	Edge D	4183	1	23.0	22.76	0.196	1.06	0.21
	WCDMA V	RMC12.2K	Back upward	4183	2	23.0	22.76	0.417	1.06	0.44

Plot No.	Band	Mode	Test Position	Ch.	Battery	RB#	RB Offset	Max. Tune-up Power (dBm)	Measured Conducted Power (dBm)	Measured SAR-1g (W/kg)	Scaling Factor	Scaled SAR-1g (W/kg)
	LTE 4	QPSK20M	Face upward	20175	1	1	50	23.0	22.48	0.378	1.13	0.43
12	LTE 4	QPSK20M	Back upward	20175	1	1	50	23.0	22.48	0.581	1.13	0.65
	LTE 4	QPSK20M	Edge B	20175	1	1	50	23.0	22.48	0.124	1.13	0.14
	LTE 4	QPSK20M	Edge C	20175	1	1	50	23.0	22.48	0.432	1.13	0.49
	LTE 4	QPSK20M	Edge D	20175	1	1	50	23.0	22.48	0.134	1.13	0.15
	LTE 4	QPSK20M	Face upward	20175	1	50	50	22.0	21.46	0.247	1.13	0.28
	LTE 4	QPSK20M	Back upward	20175	1	50	50	22.0	21.46	0.505	1.13	0.57
	LTE 4	QPSK20M	Edge B	20175	1	50	50	22.0	21.46	0.121	1.13	0.14
	LTE 4	QPSK20M	Edge C	20175	1	50	50	22.0	21.46	0.385	1.13	0.44
	LTE 4	QPSK20M	Edge D	20175	1	50	50	22.0	21.46	0.114	1.13	0.13
	LTE 4	QPSK20M	Back upward	20175	2	1	50	23.0	22.48	0.328	1.13	0.37
	LTE 5	QPSK10M	Face upward	20525	1	1	0	23.0	22.71	0.166	1.07	0.18
14	LTE 5	QPSK10M	Back upward	20525	1	1	0	23.0	22.71	0.26	1.07	0.28
	LTE 5	QPSK10M	Edge B	20525	1	1	0	23.0	22.71	0.17	1.07	0.18
	LTE 5	QPSK10M	Edge C	20525	1	1	0	23.0	22.71	0.092	1.07	0.10
	LTE 5	QPSK10M	Edge D	20525	1	1	0	23.0	22.71	0.158	1.07	0.17
	LTE 5	QPSK10M	Face upward	20525	1	25	12	22.0	21.69	0.165	1.07	0.18
	LTE 5	QPSK10M	Back upward	20525	1	25	12	22.0	21.69	0.23	1.07	0.25
	LTE 5	QPSK10M	Edge B	20525	1	25	12	22.0	21.69	0.148	1.07	0.16
	LTE 5	QPSK10M	Edge C	20525	1	25	12	22.0	21.69	0.09	1.07	0.10
	LTE 5	QPSK10M	Edge D	20525	1	25	12	22.0	21.69	0.139	1.07	0.15
	LTE 5	QPSK10M	Back upward	20525	2	1	0	23.0	22.71	0.241	1.07	0.26
	LTE 7	QPSK20M	Face upward	21100	1	1	0	23.0	22.68	0.682	1.08	0.73
16	LTE 7	QPSK20M	Back upward	21100	1	1	0	23.0	22.68	0.76	1.08	0.82
	LTE 7	QPSK20M	Edge B	21100	1	1	0	23.0	22.68	0.024	1.08	0.03
	LTE 7	QPSK20M	Edge C	21100	1	1	0	23.0	22.68	0.738	1.08	0.79
	LTE 7	QPSK20M	Edge D	21100	1	1	0	23.0	22.68	0.156	1.08	0.17
	LTE 7	QPSK20M	Face upward	21100	1	50	25	22.0	21.91	0.311	1.02	0.32
	LTE 7	QPSK20M	Back upward	21100	1	50	25	22.0	21.91	0.428	1.02	0.44
	LTE 7	QPSK20M	Edge B	21100	1	50	25	22.0	21.91	0.015	1.02	0.02
	LTE 7	QPSK20M	Edge C	21100	1	50	25	22.0	21.91	0.524	1.02	0.53
	LTE 7	QPSK20M	Edge D	21100	1	50	25	22.0	21.91	0.139	1.02	0.14
	LTE 7	QPSK20M	Back upward	20850	1	1	0	23.0	22.89	0.573	1.03	0.59
	LTE 7	QPSK20M	Back upward	21350	1	1	0	23.0	22.62	0.689	1.09	0.75
	LTE 7	QPSK20M	Back upward	21100	1	100	0	22.0	21.87	0.398	1.03	0.41
	LTE 7	QPSK20M	Back upward	21100	2	1	0	23.0	22.68	0.737	1.08	0.79
	LTE 41	QPSK20M	Face upward	40740	1	1	50	23.5	22.84	0.213	1.16	0.25
18	LTE 41	QPSK20M	Back upward	40740	1	1	50	23.5	22.84	0.438	1.16	0.51
	LTE 41	QPSK20M	Edge B	40740	1	1	50	23.5	22.84	0.006	1.16	0.01
	LTE 41	QPSK20M	Edge C	40740	1	1	50	23.5	22.84	0.314	1.16	0.37
	LTE 41	QPSK20M	Edge D	40740	1	1	50	23.5	22.84	0.174	1.16	0.20
	LTE 41	QPSK20M	Face upward	40740	1	50	0	22.5	21.68	0.16	1.21	0.19
	LTE 41	QPSK20M	Back upward	40740	1	50	0	22.5	21.68	0.351	1.21	0.42
	LTE 41	QPSK20M	Edge B	40740	1	50	0	22.5	21.68	0.004	1.21	0.00
	LTE 41	QPSK20M	Edge C	40740	1	50	0	22.5	21.68	0.255	1.21	0.31
	LTE 41	QPSK20M	Edge D	40740	1	50	0	22.5	21.68	0.138	1.21	0.17
	LTE 41	QPSK20M	Back upward	40740	2	1	50	23.5	22.84	0.318	1.16	0.37

Plot No.	Band	Mode	Test Position	Ch.	Battery	Max. Tune-up Power (dBm)	Measured Conducted Power (dBm)	Measured SAR-1g (W/kg)	Scaling Factor	Scaled SAR-1g (W/kg)
	802.11b	-	Face upward	1	1	15.0	14.98	0.148	1.00	0.15
	802.11b	-	Back upward	1	1	15.0	14.98	0.402	1.00	0.40
21	802.11b	-	Edge A	1	1	15.0	14.98	0.469	1.00	0.47
	802.11b	-	Edge B	1	1	15.0	14.98	0.009	1.00	0.01
	802.11b	-	Edge D	1	1	15.0	14.98	0.013	1.00	0.01
	802.11b	-	Edge A	1	2	15.0	14.98	0.221	1.00	0.22

Shenzhen UnionTrust Quality and Technology Co., Ltd.

Address: 16/F, Block A, Building 6, Baoneng Science and Technology Park, Qingxiang Road No.1, Longhua New District, Shenzhen, China
 Tel: +86-755-28230888 Fax: +86-755-28230886 E-mail: info@uttlab.com [Http://www.uttlab.com](http://www.uttlab.com)

4.6 SAR Measurement Variability

According to KDB 865664 D01, SAR measurement variability was assessed for each frequency band, which is determined by the SAR probe calibration point and tissue-equivalent medium used for the device measurements. When both head and body tissue-equivalent media are required for SAR measurements in a frequency band, the variability measurement procedures should be applied to the tissue medium with the highest measured SAR, using the highest measured SAR configuration for that tissue-equivalent medium. Alternatively, if the highest measured SAR for both head and body tissue-equivalent media are ≤ 1.45 W/kg and the ratio of these highest SAR values, i.e., largest divided by smallest value, is ≤ 1.10 , the highest SAR configuration for either head or body tissue-equivalent medium may be used to perform the repeated measurement. These additional measurements are repeated after the completion of all measurements requiring the same head or body tissue-equivalent medium in a frequency band. The test device should be returned to ambient conditions (normal room temperature) with the battery fully charged before it is re-mounted on the device holder for the repeated measurement(s) to minimize any unexpected variations in the repeated results.

Since all the measured SAR are less than 0.8 W/kg, the repeated measurement is not required.

SAR repeated measurement procedure:

1. When the highest measured SAR is < 0.80 W/kg, repeated measurement is not required.
2. When the highest measured SAR is ≥ 0.80 W/kg, repeat that measurement once.
3. If the ratio of largest to smallest SAR for the original and first repeated measurements is > 1.20 , or when the original or repeated measurement is ≥ 1.45 W/kg, perform a second repeated measurement.
4. If the ratio of largest to smallest SAR for the original, first and second repeated measurements is > 1.20 , and the original, first or second repeated measurement is ≥ 1.5 W/kg, perform a third repeated measurement.

4.7 Simultaneous Multi-band Transmission Evaluation

<Simultaneous Transmission Possibilities>

The simultaneous transmission possibilities for this device are listed as below.

Simultaneous Transmission Configurations	Head (Voice / VoIP)	Body-worn (Voice / VoIP)	Hotspot (Data)
GSM (Voice / Data) + WLAN (Data)	Yes	Yes	Yes
WCDMA (Voice / Data) + WLAN (Data)	Yes	Yes	Yes
LTE (Data) + WLAN (Data)	Yes	Yes	Yes
GSM (Voice / Data) + BT (Data)	Yes	Yes	No
WCDMA (Voice / Data) + BT (Data)	Yes	Yes	No
LTE (Data) + BT (Data)	Yes	Yes	No

Note :

1. The WLAN and Bluetooth cannot transmit simultaneously, so there is no co-location test requirement for WLAN and Bluetooth.

<SAR Summation Analysis>

Simultaneous transmission SAR test exclusion is determined for each operating configuration and exposure condition according to the reported standalone SAR of each applicable simultaneous transmitting antenna. When the sum of SAR_{1g} of all simultaneously transmitting antennas in an operating mode and exposure condition combination is within the SAR limit (SAR_{1g} 1.6 W/kg), the simultaneous transmission SAR is not required. When the sum of SAR_{1g} is greater than the SAR limit (SAR_{1g} 1.6 W/kg), SAR test exclusion is determined by the SPLSR.

Position		Max. Standalone SAR									
		GSM		WCDMA		LTE				WLAN 2.4G	BT
		850	1900	II	V	4	5	7	41		
Head	Right Cheek	0.33	0.09	0.16	0.29	0.24	0.19	0.15	0.09	0.29	0.18
	Right Tilted	0.27	0.09	0.07	0.21	0.12	0.16	0.13	0.06	0.54	0.22
	Left Cheek	0.31	0.30	0.24	0.23	0.26	0.17	0.26	0.18	0.25	0.15
	Left Tilted	0.26	0.15	0.12	0.19	0.25	0.16	0.15	0.11	0.45	0.19
Body-Worn	Face upward	0.38	0.34	0.39	0.31	0.43	0.18	0.73	0.25	0.15	0.28
	Back upward	0.45	0.47	0.64	0.45	0.65	0.28	0.82	0.51	0.40	0.28
Hotspot	Face upward	0.39	0.46	0.39	0.31	0.43	0.18	0.73	0.25	0.15	N/A
	Back upward	0.52	0.69	0.64	0.45	0.65	0.28	0.82	0.51	0.40	N/A
	Edge A	0.00	0.00	0.00	0.00	0.00	0.00	0.00	0.00	0.47	N/A
	Edge B	0.36	0.12	0.11	0.37	0.14	0.18	0.03	0.01	0.01	N/A
	Edge C	0.15	0.54	0.38	0.16	0.49	0.10	0.79	0.37	0.00	N/A
	Edge D	0.31	0.21	0.08	0.21	0.15	0.17	0.17	0.20	0.01	N/A

Position		Highest Simultaneous Transmission SAR	WWAN+WLAN(DTS)							
			GSM		WCDMA		LTE			
			850	1900	II	V	4	5	7	41
Head	Right Cheek	0.81	0.62	0.38	0.45	0.58	0.53	0.48	0.44	0.38
	Right Tilted		0.81	0.63	0.61	0.75	0.66	0.70	0.67	0.60
	Left Cheek		0.56	0.55	0.49	0.48	0.51	0.42	0.51	0.43
	Left Tilted		0.71	0.60	0.57	0.64	0.70	0.61	0.60	0.56
Body-Worn	Face upward	1.22	0.53	0.49	0.54	0.46	0.58	0.33	0.88	0.40
	Back upward		0.85	0.87	1.04	0.85	1.05	0.68	1.22	0.91
Hotspot	Face upward	1.22	0.54	0.61	0.54	0.46	0.58	0.33	0.88	0.40
	Back upward		0.92	1.09	1.04	0.85	1.05	0.68	1.22	0.91
	Edge A		0.47	0.47	0.47	0.47	0.47	0.47	0.47	0.47
	Edge B		0.37	0.13	0.12	0.38	0.15	0.19	0.04	0.02
	Edge C		0.15	0.54	0.38	0.16	0.49	0.10	0.79	0.37
	Edge D		0.32	0.22	0.09	0.22	0.16	0.18	0.18	0.21

Position		Highest Simultaneous Transmission SAR	WWAN+BT(DSS)							
			GSM		WCDMA		LTE			
			850	1900	II	V	4	5	7	41
Head	Right Cheek	0.51	0.51	0.27	0.34	0.47	0.42	0.37	0.33	0.27
	Right Tilted		0.49	0.31	0.29	0.43	0.34	0.38	0.35	0.28
	Left Cheek		0.46	0.45	0.39	0.38	0.41	0.32	0.41	0.33
	Left Tilted		0.45	0.34	0.31	0.38	0.44	0.35	0.34	0.30
Body-Worn	Face upward	1.10	0.66	0.62	0.67	0.59	0.71	0.46	1.01	0.53
	Back upward		0.73	0.75	0.92	0.73	0.93	0.56	1.10	0.79



*** End of Report ***

The test report is effective only with both signature and specialized stamp. The result(s) shown in this report refer only to the sample(s) tested. Without written approval of UnionTrust, this report can't be reproduced except in full.



Appendix A. SAR Plots of System Verification

The plots for system verification with largest deviation for each SAR system combination are shown as follows.



RESULTS

TYPE	BAND	Liquid	
Validation	CW850	Head	Measurement 1: Validation Plane with Body device position on Middle Channel in CW mode
Validation	CW850	Body	Measurement 2: Validation Plane with Body device position on Middle Channel in CW mode
Validation	CW1800	Head	Measurement 3: Validation Plane with Body device position on Middle Channel in CW mode
Validation	CW1800	Body	Measurement 4: Validation Plane with Body device position on Middle Channel in CW mode
Validation	CW1900	Head	Measurement 5: Validation Plane with Body device position on Middle Channel in CW mode
Validation	CW1900	Body	Measurement 6: Validation Plane with Body device position on Middle Channel in CW mode
Validation	CW2450	Head	Measurement 7: Validation Plane with Body device position on Middle Channel in CW mode
Validation	CW2450	Body	Measurement 8: Validation Plane with Body device position on Middle Channel in CW mode
Validation	CW2600	Head	Measurement 9: Validation Plane with Body device position on Middle Channel in CW mode
Validation	CW2600	Body	Measurement 10: Validation Plane with Body device position on Middle Channel in CW mode

MEASUREMENT 1

Type: Validation measurement

Date of measurement: 26/9/2016

Measurement duration: 21 minutes 14 seconds

Mobile Phone IMEI number: --

A. Experimental conditions.

<u>Area Scan</u>	dx=8mm dy=8mm
<u>ZoomScan</u>	5x5x7,dx=8mm dy=8mm dz=5mm
<u>Phantom</u>	<u>Validation plane</u>
<u>Device Position</u>	<u>Body</u>
<u>Band</u>	<u>CW835</u>
<u>Channels</u>	<u>Middle</u>
<u>Signal</u>	<u>CW (Crest factor: 1.0)</u>

B. SAR Measurement Results:

E-Field Probe	SATIMO SN_43/15_EP276
Frequency (MHz)	835.0
Relative permittivity (real part)	41.894852
Relative permittivity (imaginary)	19.243151
Conductivity (S/m)	0.892668
Variation (%)	-0.220000
Temperature:	21.3°C
ConvF:	6.81

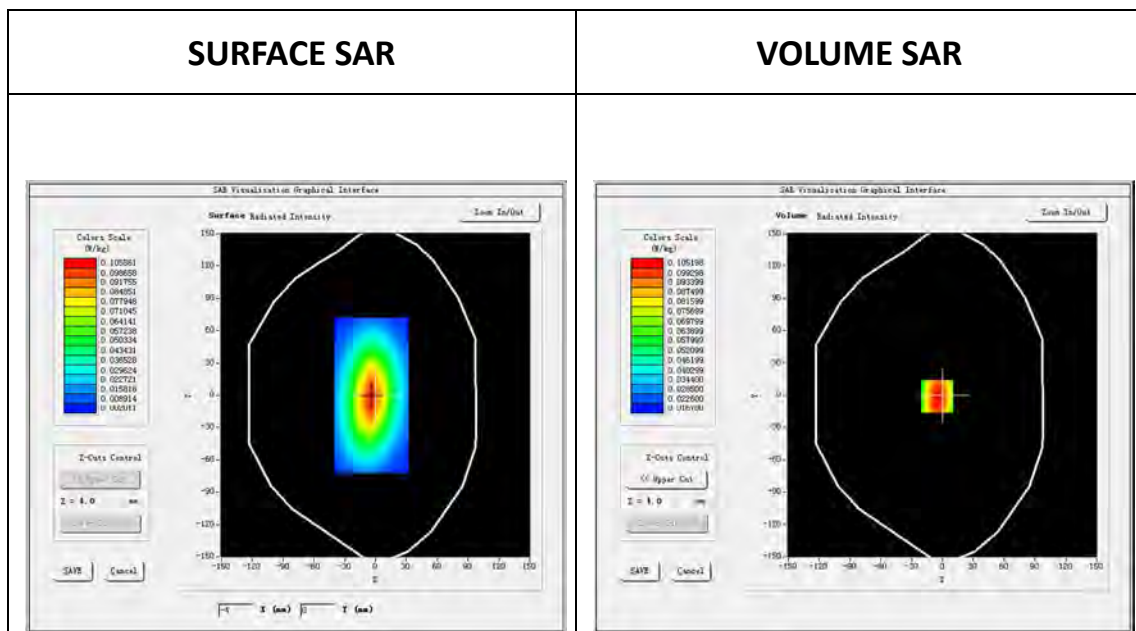

Maximum location: X=-5.00, Y=-1.00

SAR Peak: 0.15 W/kg

SAR 10g (W/Kg)	0.064060
SAR 1g (W/Kg)	0.099340

Z (mm)	0.00	4.00	8.00	12.00	16.00
SAR (W/Kg)	0.1465	0.1052	0.0758	0.0556	0.0418

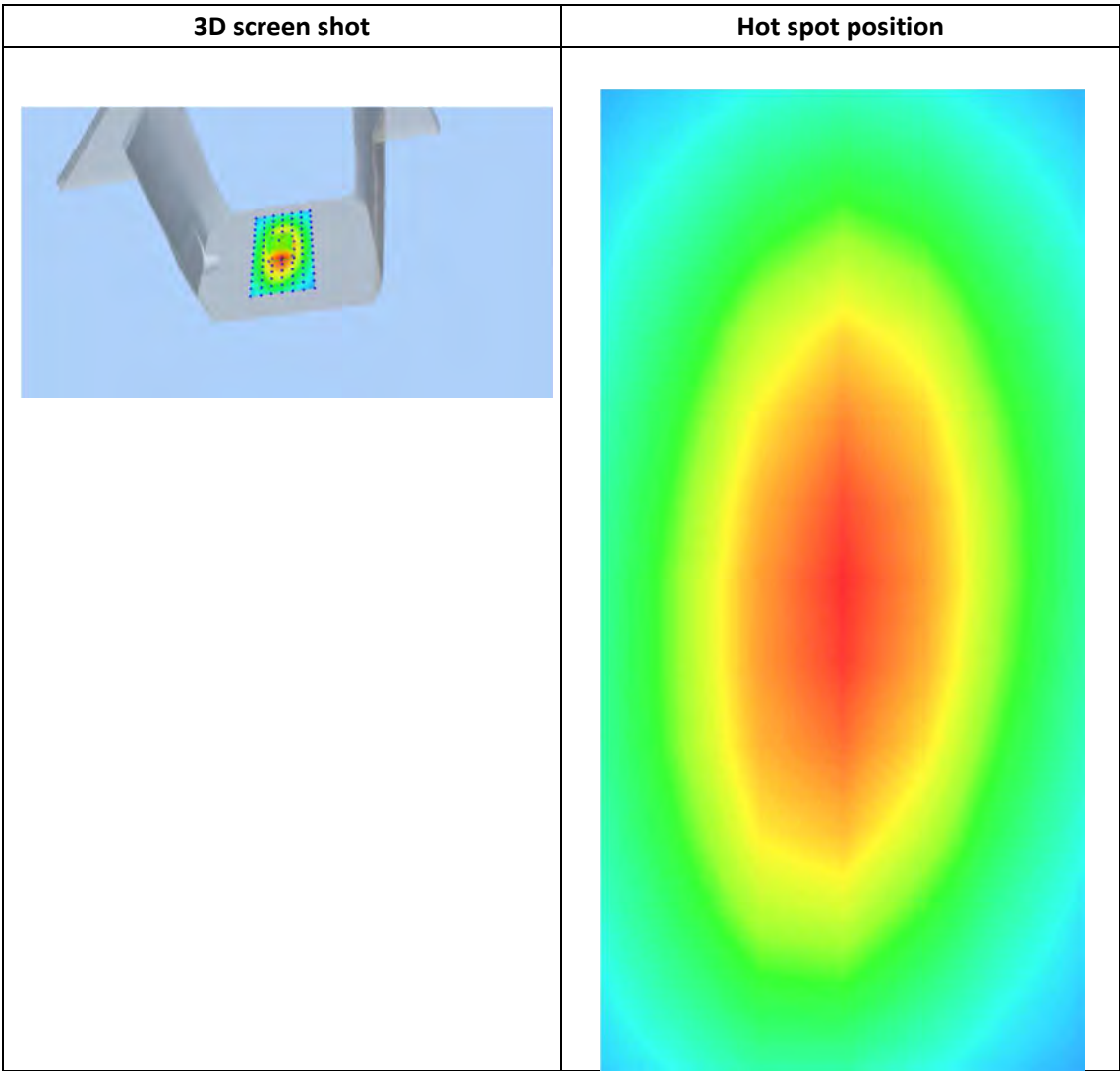
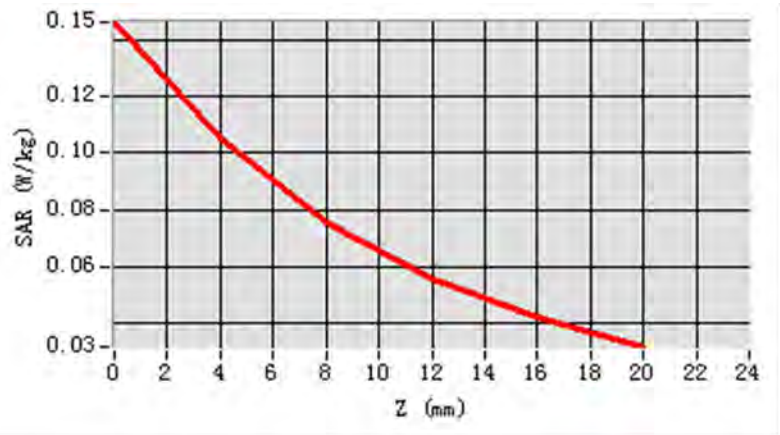

MEASUREMENT 2

Type: Validation measurement

Date of measurement: 19/9/2016

Measurement duration: 21 minutes 11 seconds

Mobile Phone IMEI number: --

A. Experimental conditions.

<u>Area Scan</u>	dx=8mm dy=8mm
<u>ZoomScan</u>	5x5x7,dx=8mm dy=8mm dz=5mm
<u>Phantom</u>	<u>Validation plane</u>
<u>Device Position</u>	<u>Body</u>
<u>Band</u>	<u>CW835</u>
<u>Channels</u>	<u>Middle</u>
<u>Signal</u>	<u>CW (Crest factor: 1.0)</u>

B. SAR Measurement Results

E-Field Probe	SATIMO SN_43/15_EP276
Frequency (MHz)	835.0
Relative permittivity (real part)	55.229698
Relative permittivity (imaginary)	21.130150
Conductivity (S/m)	0.980204
Variation (%)	-0.230000
Temperature:	21.3°C
ConvF:	7.07

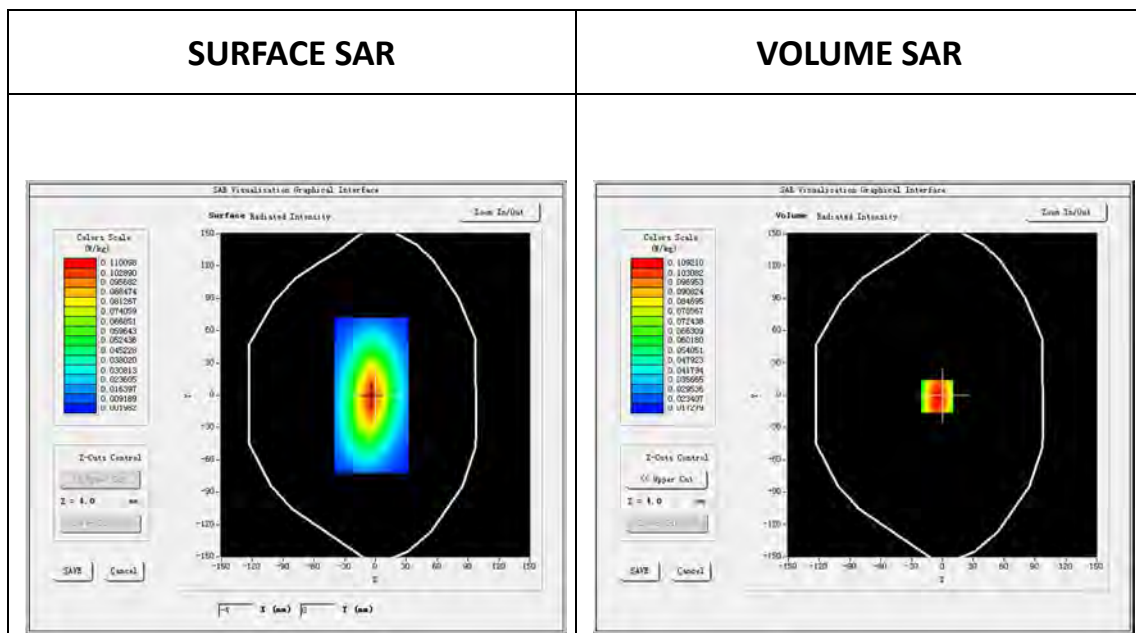

Maximum location: X=-5.00, Y=-1.00

SAR Peak: 0.15 W/kg

SAR 10g (W/Kg)	0.066449
SAR 1g (W/Kg)	0.103121

Z (mm)	0.00	4.00	8.00	12.00	16.00
SAR (W/Kg)	0.1524	0.1092	0.0785	0.0575	0.0432

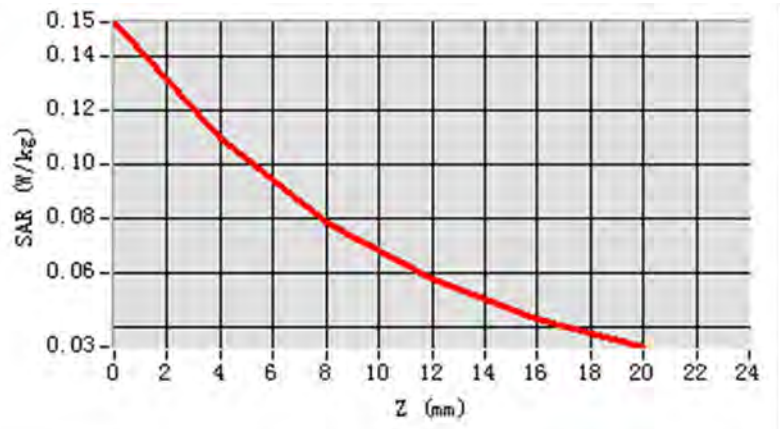

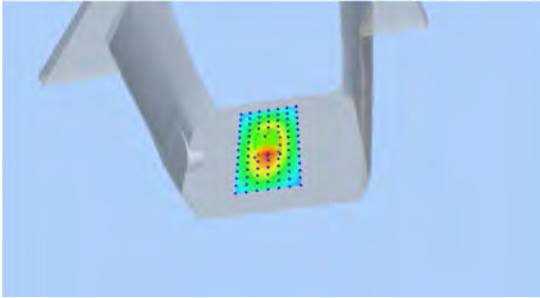
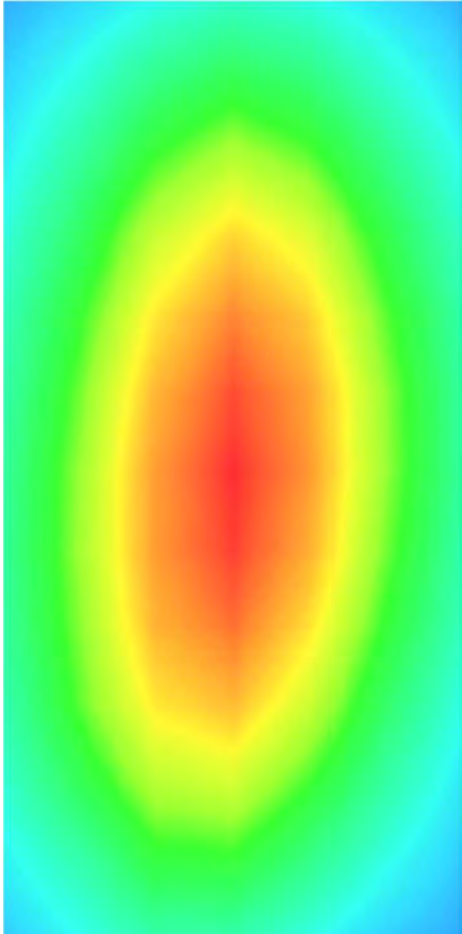
3D screen shot	Hot spot position
	

MEASUREMENT 3

Type: Validation measurement

Date of measurement: 27/9/2016

Measurement duration: 22 minutes 31 seconds

Mobile Phone IMEI number: --

A. Experimental conditions.

<u>Area Scan</u>	dx=8mm dy=8mm
<u>ZoomScan</u>	5x5x7,dx=8mm dy=8mm dz=5mm
<u>Phantom</u>	<u>Validation plane</u>
<u>Device Position</u>	<u>Body</u>
<u>Band</u>	<u>CW1800</u>
<u>Channels</u>	<u>Middle</u>
<u>Signal</u>	<u>CW (Crest factor: 1.0)</u>

B.SAR Measurement Results

E-Field Probe	SATIMO SN_43/15_EP276
Frequency (MHz)	1800.0
Relative permittivity (real part)	41.728500
Relative permittivity (imaginary)	14.156800
Conductivity (S/m)	1.415680
Variation (%)	-0.160000
Temperature:	21.3°C
ConvF:	5.44

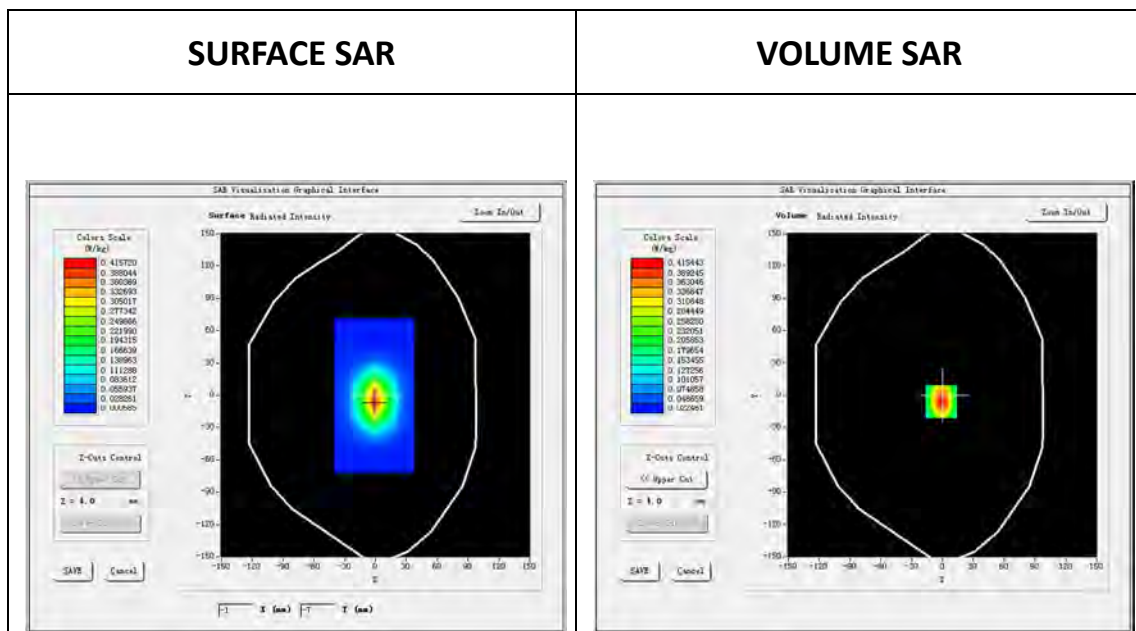

Maximum location: X=-1.00, Y=-6.00

SAR Peak: 0.63 W/kg

SAR 10g (W/Kg)	0.209640
SAR 1g (W/Kg)	0.381522

Z (mm)	0.00	4.00	8.00	12.00	16.00
SAR (W/Kg)	0.6343	0.4154	0.2708	0.1799	0.1238

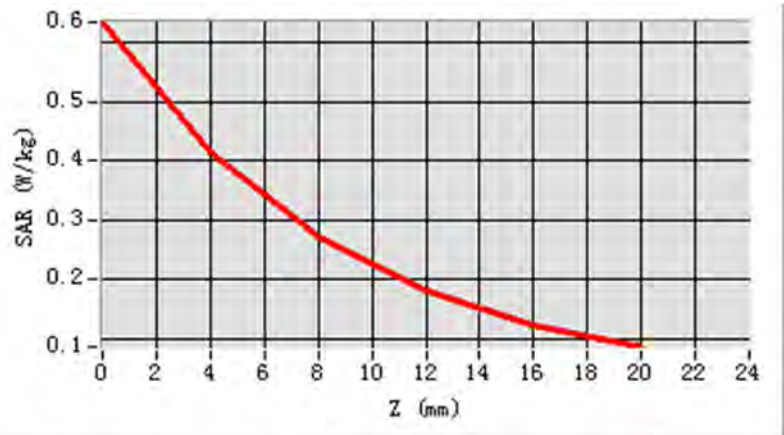

3D screen shot

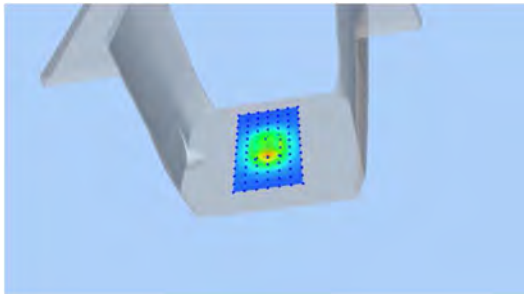

Hot spot position

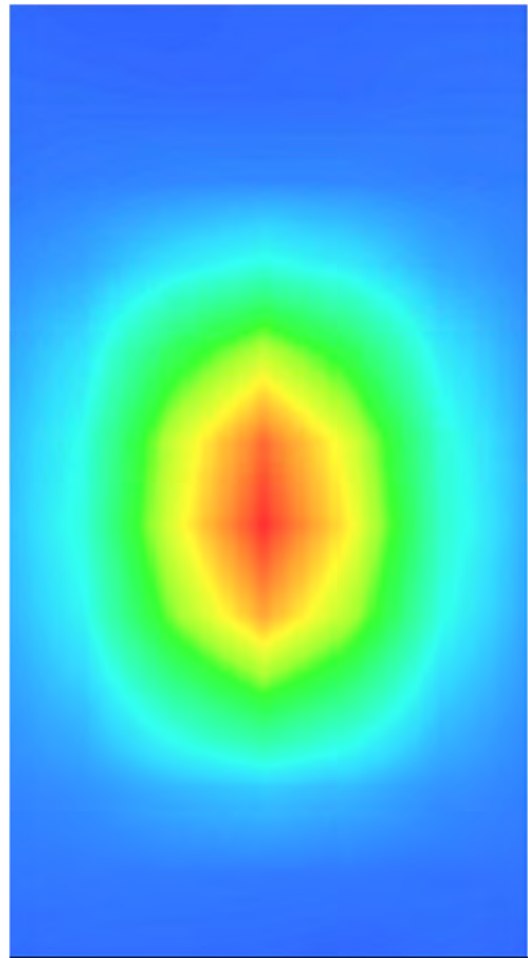

MEASUREMENT 4

Type: Validation measurement

Date of measurement: 20/9/2016

Measurement duration: 22 minutes 32 seconds

Mobile Phone IMEI number: --

A. Experimental conditions.

<u>Area Scan</u>	x=8mm dy=8mm
<u>ZoomScan</u>	5x5x7,dx=8mm dy=8mm dz=5mm
<u>Phantom</u>	<u>Validation plane</u>
<u>Device Position</u>	<u>Body</u>
<u>Band</u>	<u>CW1800</u>
<u>Channels</u>	<u>Middle</u>
<u>Signal</u>	<u>CW (Crest factor: 1.0)</u>

B. SAR Measurement Results

E-Field Probe	SATIMO SN_43/15_EP276
Frequency (MHz)	1800.0
Relative permittivity (real part)	53.338001
Relative permittivity (imaginary)	15.617700
Conductivity (S/m)	1.561770
Variation (%)	-0.280000
Temperature:	21.3°C
ConvF:	5.62

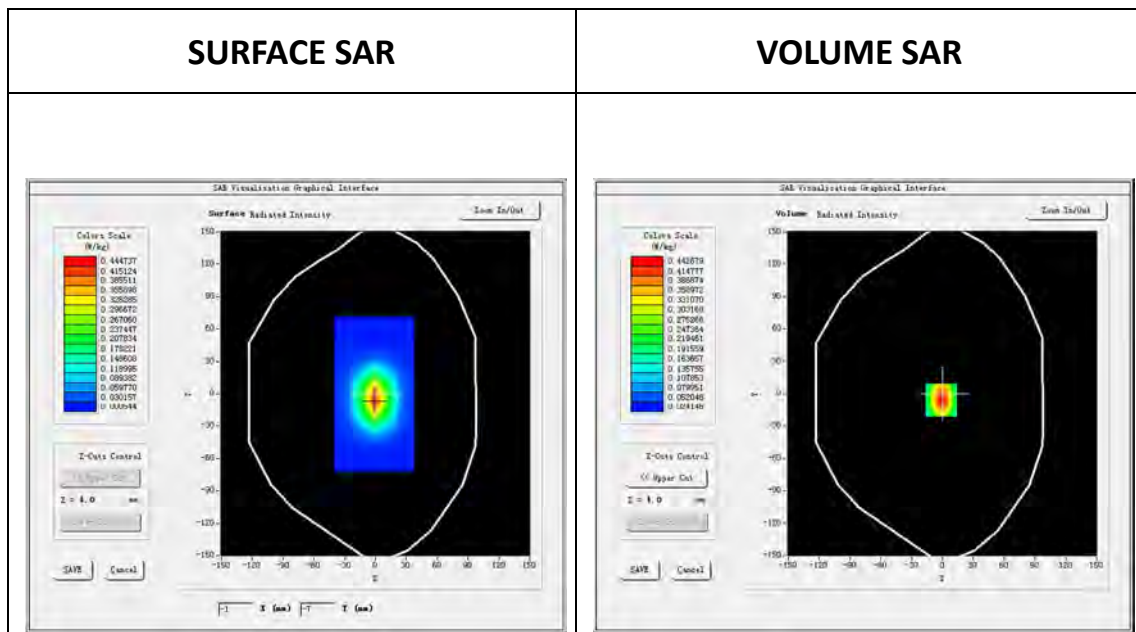

Maximum location: X=-1.00, Y=-6.00

SAR Peak: 0.68 W/kg

SAR 10g (W/Kg)	0.223713
SAR 1g (W/Kg)	0.406599

Z (mm)	0.00	4.00	8.00	12.00	16.00
SAR (W/Kg)	0.6748	0.4427	0.2889	0.1921	0.1321

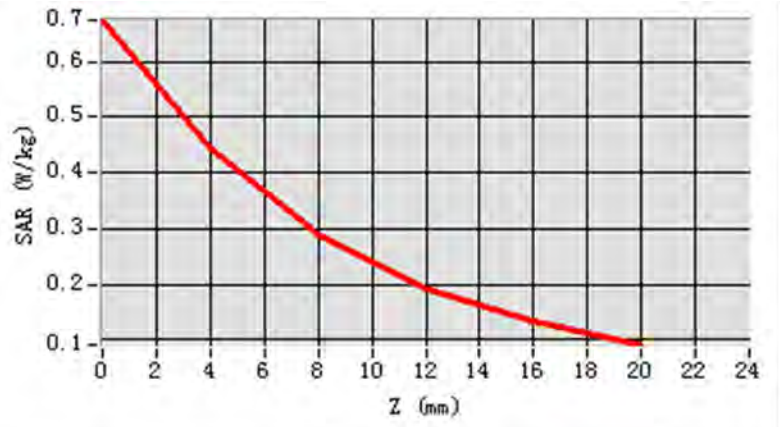

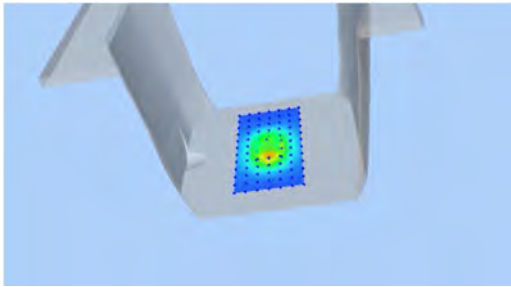
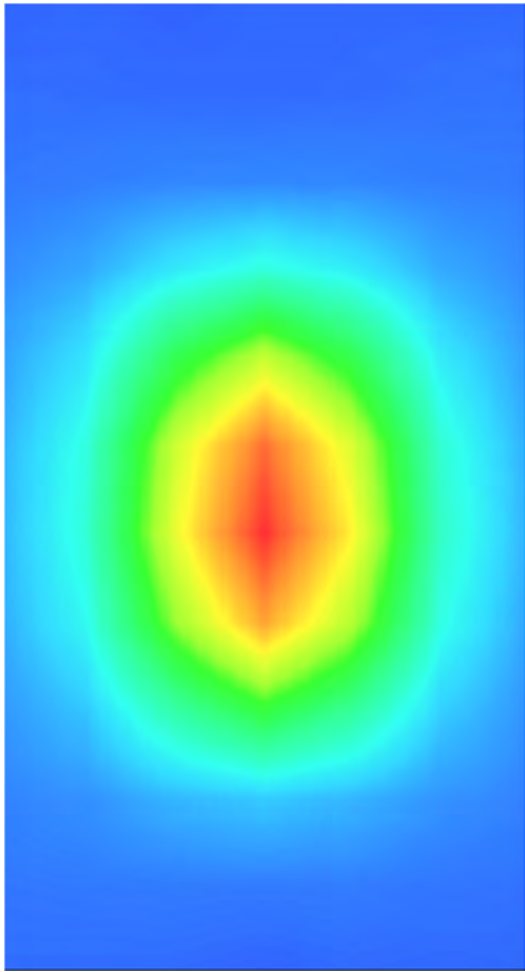
3D screen shot	Hot spot position
	

MEASUREMENT 5

Type: Validation measurement

Date of measurement: 28/9/2016

Measurement duration: 24 minutes 27 seconds

Mobile Phone IMEI number: --

A. Experimental conditions.

<u>Area Scan</u>	dx=8mm dy=8mm
<u>ZoomScan</u>	5x5x7,dx=8mm dy=8mm dz=5mm
<u>Phantom</u>	<u>Validation plane</u>
<u>Device Position</u>	<u>Body</u>
<u>Band</u>	<u>CW1900</u>
<u>Channels</u>	<u>Middle</u>
<u>Signal</u>	<u>CW (Crest factor: 1.0)</u>

B. SAR Measurement Results

E-Field Probe	SATIMO SN_43/15_EP276
Frequency (MHz)	1900.0
Relative permittivity (real part)	38.417198
Relative permittivity (imaginary)	13.337000
Conductivity (S/m)	1.412239
Variation (%)	-0.680000
Temperature:	21.3°C
ConvF:	6.05

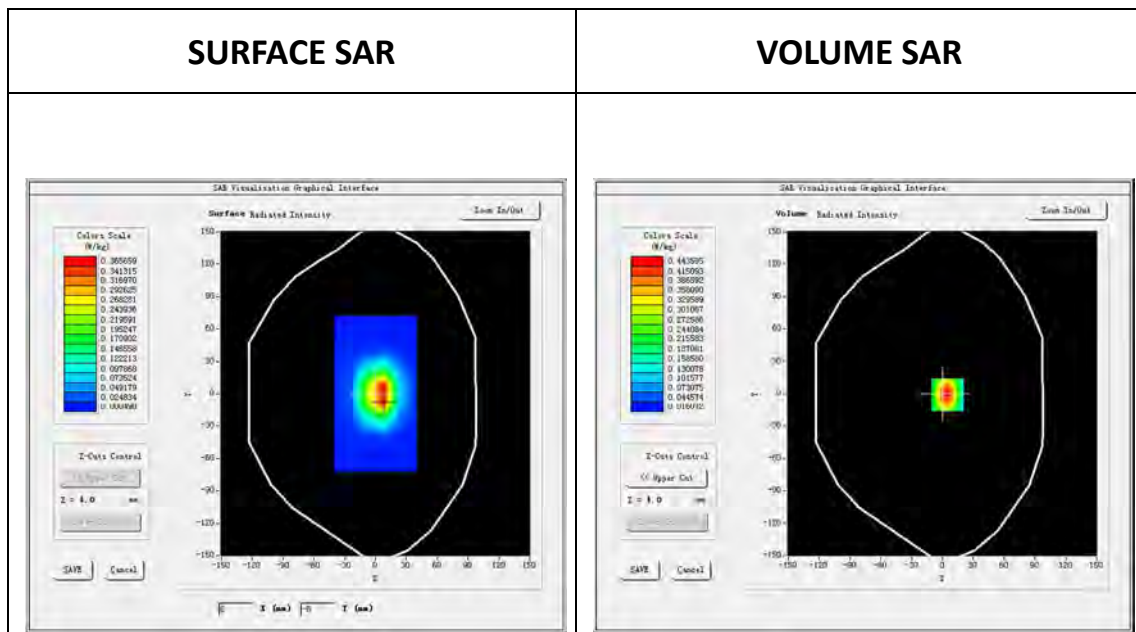

Maximum location: X=5.00, Y=-1.00

SAR Peak: 0.69 W/kg

SAR 10g (W/Kg)	0.215880
SAR 1g (W/Kg)	0.406011

Z (mm)	0.00	4.00	8.00	12.00	16.00
SAR (W/Kg)	0.6927	0.4436	0.2819	0.1826	0.1230

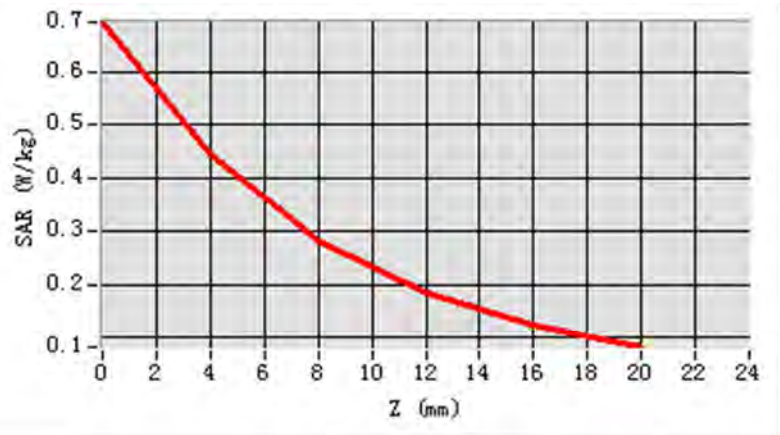

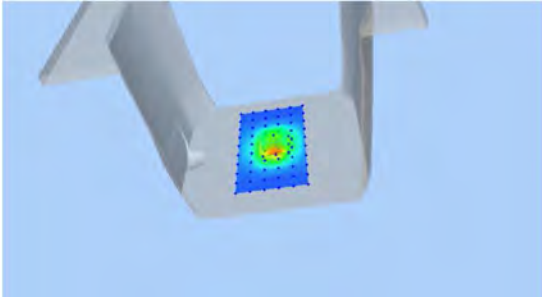
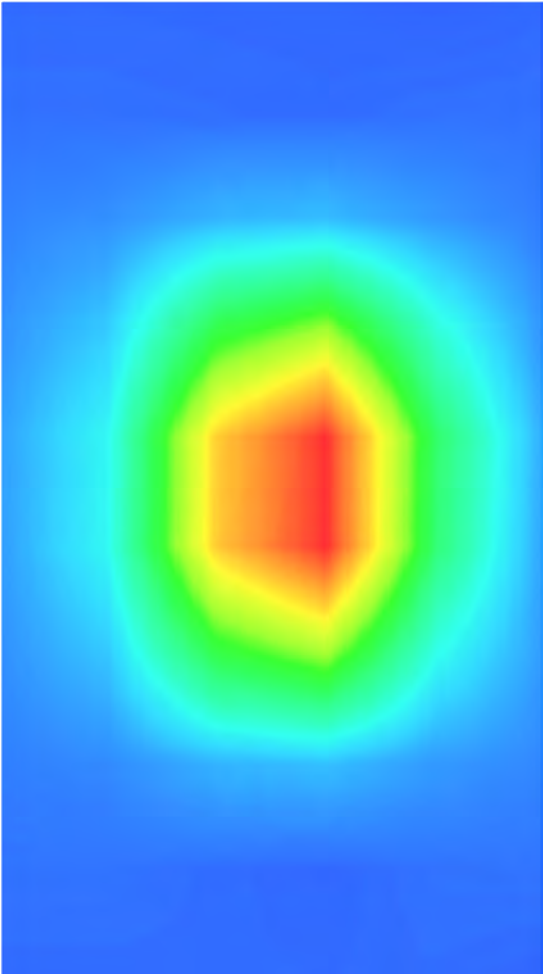
3D screen shot	Hot spot position
	

MEASUREMENT 6

Type: Validation measurement

Date of measurement: 20/9/2016

Measurement duration: 25 minutes 26 seconds

Mobile Phone IMEI number: --

A. Experimental conditions.

<u>Area Scan</u>	dx=8mm dy=8mm
<u>ZoomScan</u>	5x5x7,dx=8mm dy=8mm dz=5mm
<u>Phantom</u>	<u>Validation plane</u>
<u>Device Position</u>	<u>Body</u>
<u>Band</u>	<u>CW1900</u>
<u>Channels</u>	<u>Middle</u>
<u>Signal</u>	<u>CW (Crest factor: 1.0)</u>

B. SAR Measurement Results

E-Field Probe	SATIMO SN_43/15_EP276
Frequency (MHz)	1900.0
Relative permittivity (real part)	53.258598
Relative permittivity (imaginary)	14.210900
Conductivity (S/m)	1.500039
Variation (%)	-0.830000
Temperature:	21.3°C
ConvF:	6.18

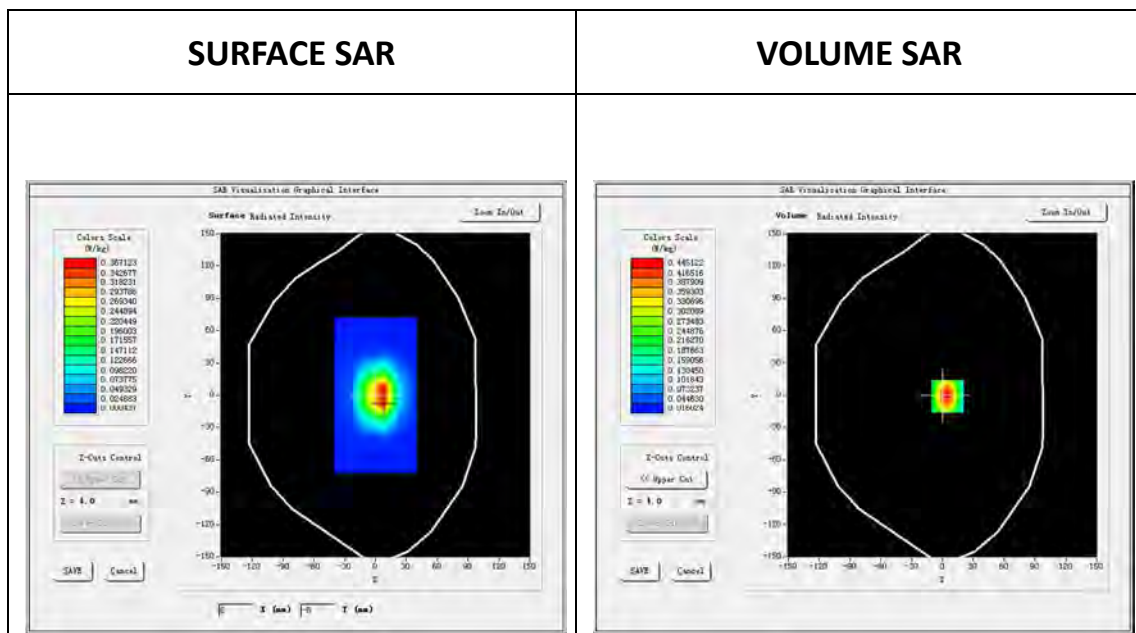

Maximum location: X=5.00, Y=-1.00

SAR Peak: 0.70 W/kg

SAR 10g (W/Kg)	0.216303
SAR 1g (W/Kg)	0.407405

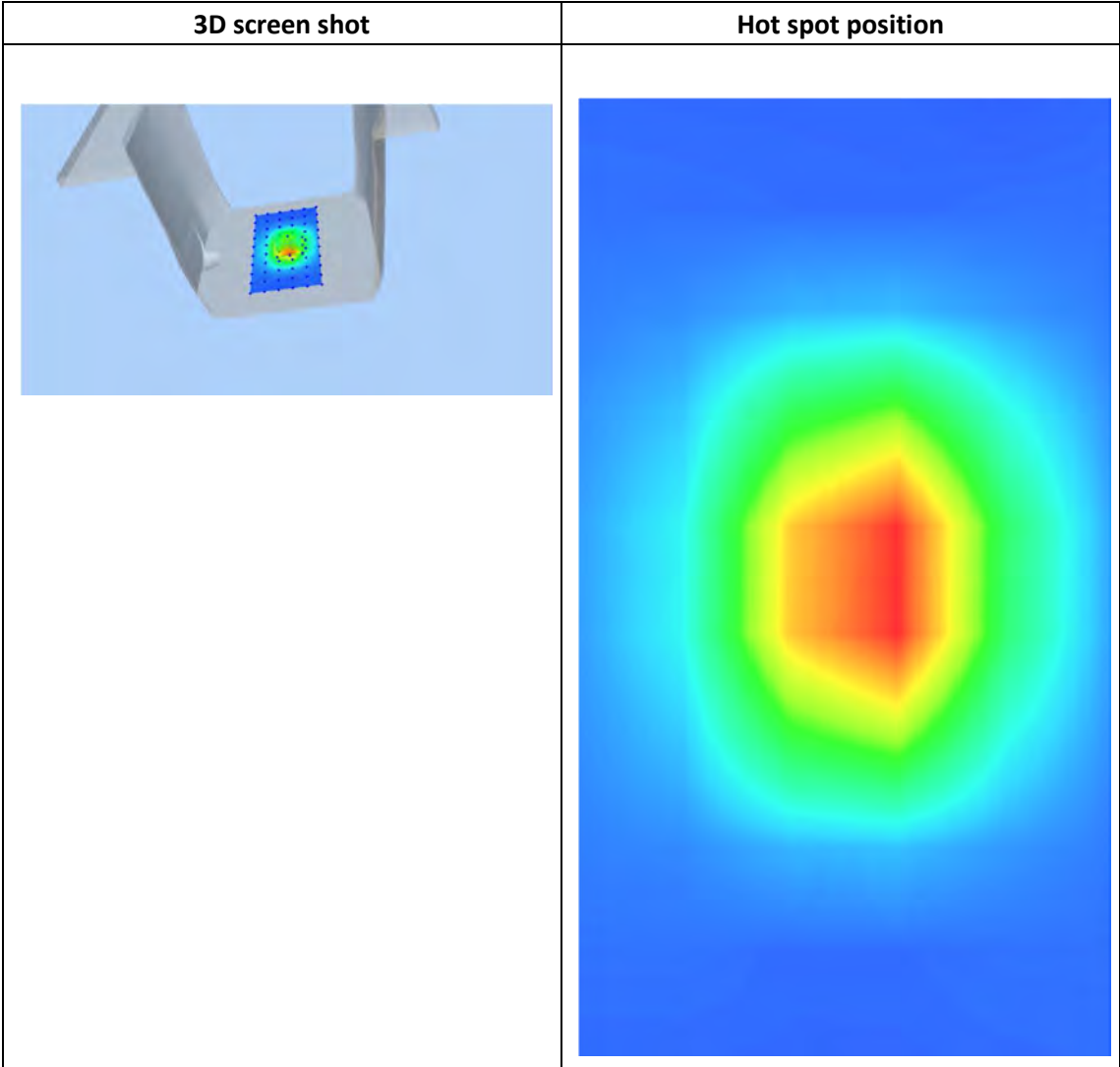
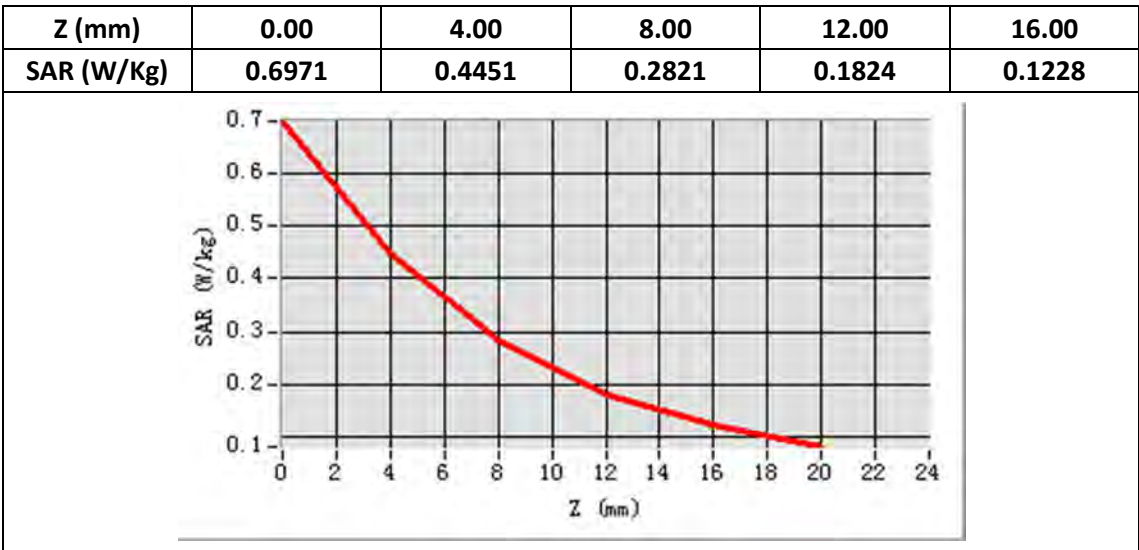

MEASUREMENT 7

Type: Validation measurement

Date of measurement: 23/9/2016

Measurement duration: 22 minutes 28 seconds

Mobile Phone IMEI number: --

A. Experimental conditions.

<u>Area Scan</u>	dx=5mm dy=5mm
<u>ZoomScan</u>	7x7x8,dx=5mm dy=5mm dz=4mm
<u>Phantom</u>	<u>Validation plane</u>
<u>Device Position</u>	<u>Body</u>
<u>Band</u>	<u>CW2450</u>
<u>Channels</u>	<u>Middle</u>
<u>Signal</u>	<u>CW (Crest factor: 1.0)</u>

B. SAR Measurement Results

E-Field Probe	SATIMO SN_43/15_EP276
Frequency (MHz)	2450.0
Relative permittivity (real part)	39.200001
Relative permittivity (imaginary)	13.220000
Conductivity (S/m)	1.799389
Variation (%)	-0.230000
Temperature:	21.3°C
ConvF:	5.52

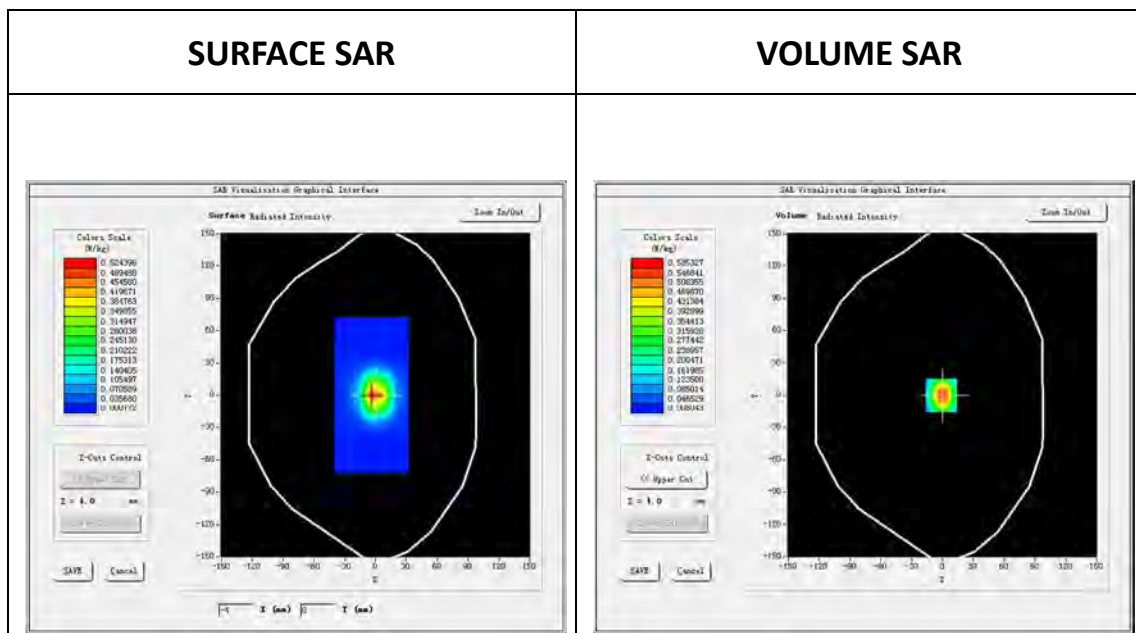

Maximum location: X=-1.00, Y=0.00

SAR Peak: 0.98 W/kg

SAR 10g (W/Kg)	0.246812
SAR 1g (W/Kg)	0.523939

Z (mm)	0.00	4.00	8.00	12.00	16.00
SAR (W/Kg)	0.9759	0.5853	0.3434	0.2030	0.1242

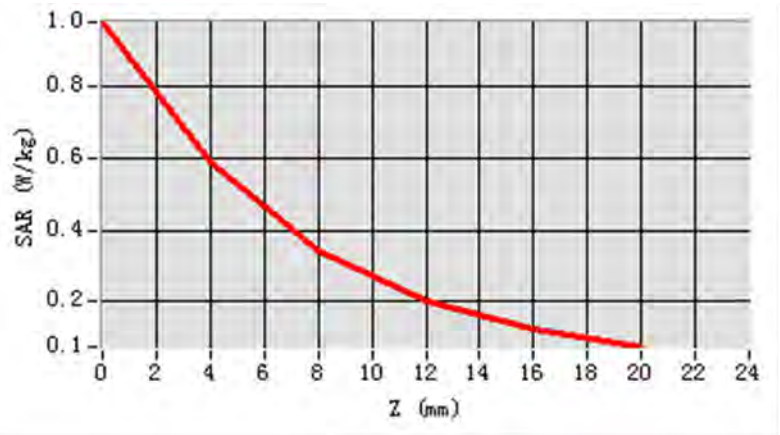

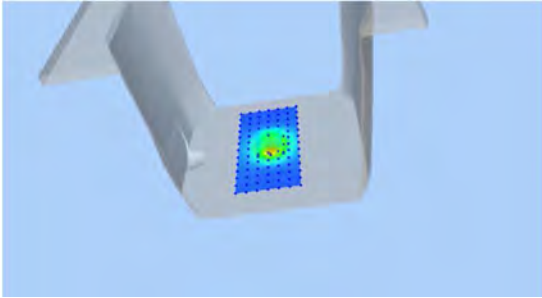
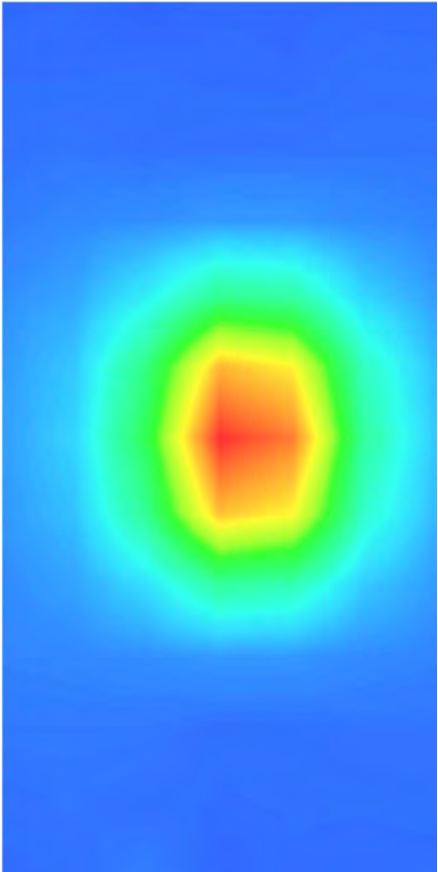
3D screen shot	Hot spot position
	

MEASUREMENT 8

Type: Validation measurement

Date of measurement: 21/9/2016

Measurement duration: 21 minutes 31 seconds

Mobile Phone IMEI number: --

A. Experimental conditions.

<u>Area Scan</u>	dx=5mm dy=5mm
<u>ZoomScan</u>	7x7x8,dx=5mm dy=5mm dz=4mm
<u>Phantom</u>	<u>Validation plane</u>
<u>Device Position</u>	<u>Body</u>
<u>Band</u>	<u>CW2450</u>
<u>Channels</u>	<u>Middle</u>
<u>Signal</u>	<u>CW (Crest factor: 1.0)</u>

B. SAR Measurement Results

E-Field Probe	SATIMO SN_43/15_EP276
Frequency (MHz)	2450.0
Relative permittivity (real part)	54.659199
Relative permittivity (imaginary)	13.974400
Conductivity (S/m)	1.902071
Variation (%)	-0.250000
Temperature:	21.3°C
ConvF:	5.70

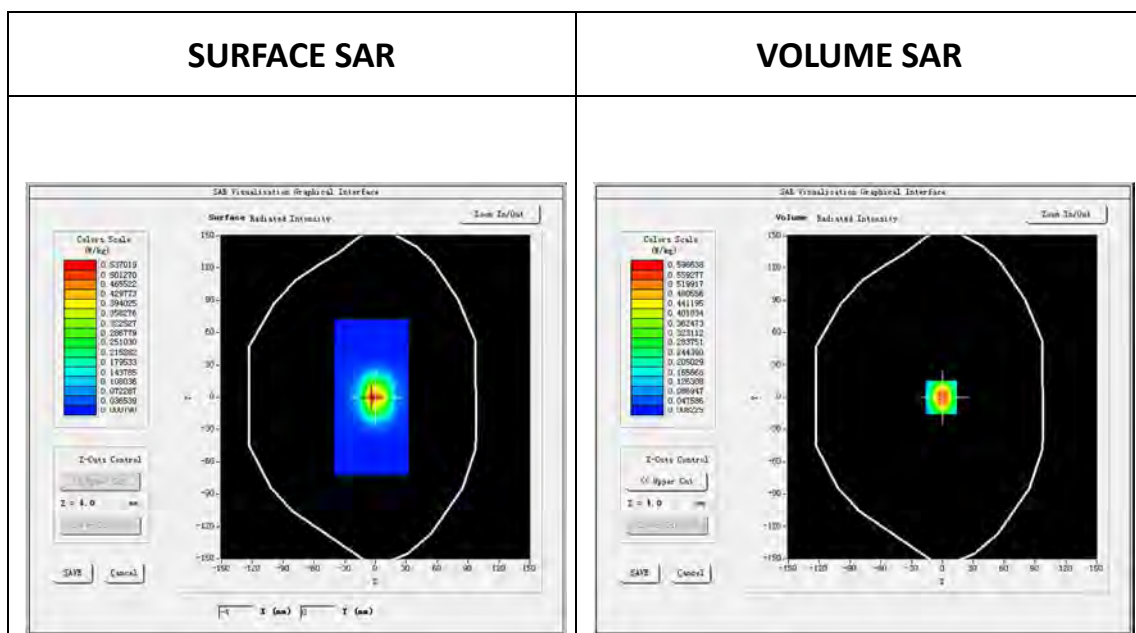

Maximum location: X=-1.00, Y=0.00

SAR Peak: 1.00 W/kg

SAR 10g (W/Kg)	0.252316
SAR 1g (W/Kg)	0.535939

Z (mm)	0.00	4.00	8.00	12.00	16.00
SAR (W/Kg)	0.9998	0.5986	0.3506	0.2069	0.1266

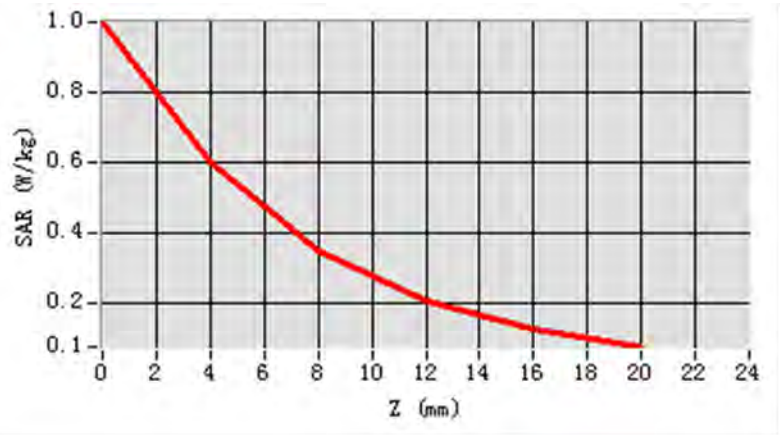

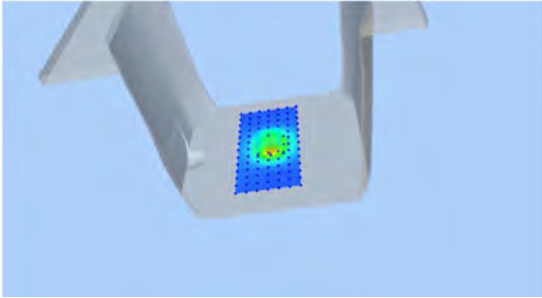
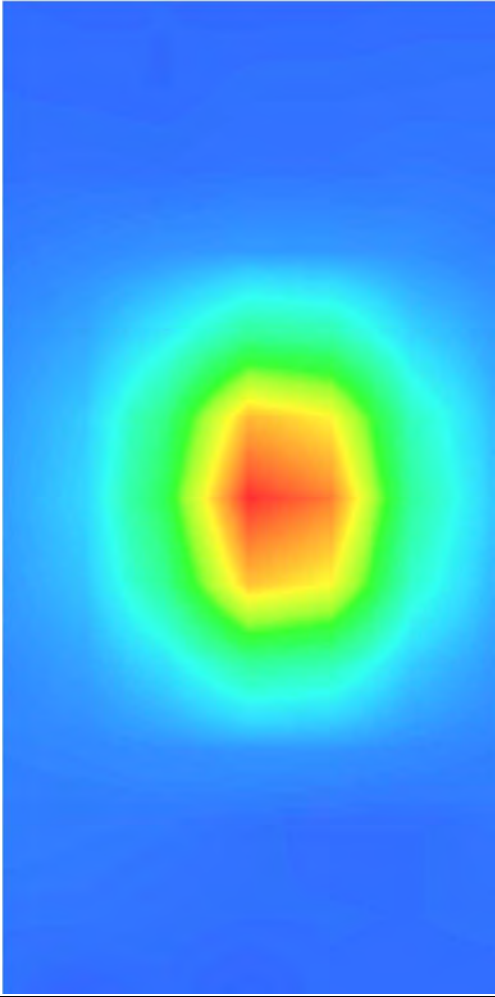
3D screen shot	Hot spot position
	

MEASUREMENT 9

Type: Validation measurement

Date of measurement: 23/9/2016

Measurement duration: 22 minutes 35 seconds

Mobile Phone IMEI number: --

A. Experimental conditions.

<u>Area Scan</u>	dx=5mm dy=5mm
<u>ZoomScan</u>	7x7x8,dx=5mm dy=5mm dz=4mm
<u>Phantom</u>	<u>Validation plane</u>
<u>Device Position</u>	<u>Body</u>
<u>Band</u>	<u>CW2600</u>
<u>Channels</u>	<u>Middle</u>
<u>Signal</u>	<u>CW (Crest factor: 1.0)</u>

B.SAR Measurement Results

E-Field Probe	SATIMO SN_43/15_EP276
Frequency (MHz)	2600.0
Relative permittivity (real part)	39.000000
Relative permittivity (imaginary)	13.570000
Conductivity (S/m)	1.960111
Variation (%)	-0.470000
Temperature:	21.3°C
ConvF:	5.57

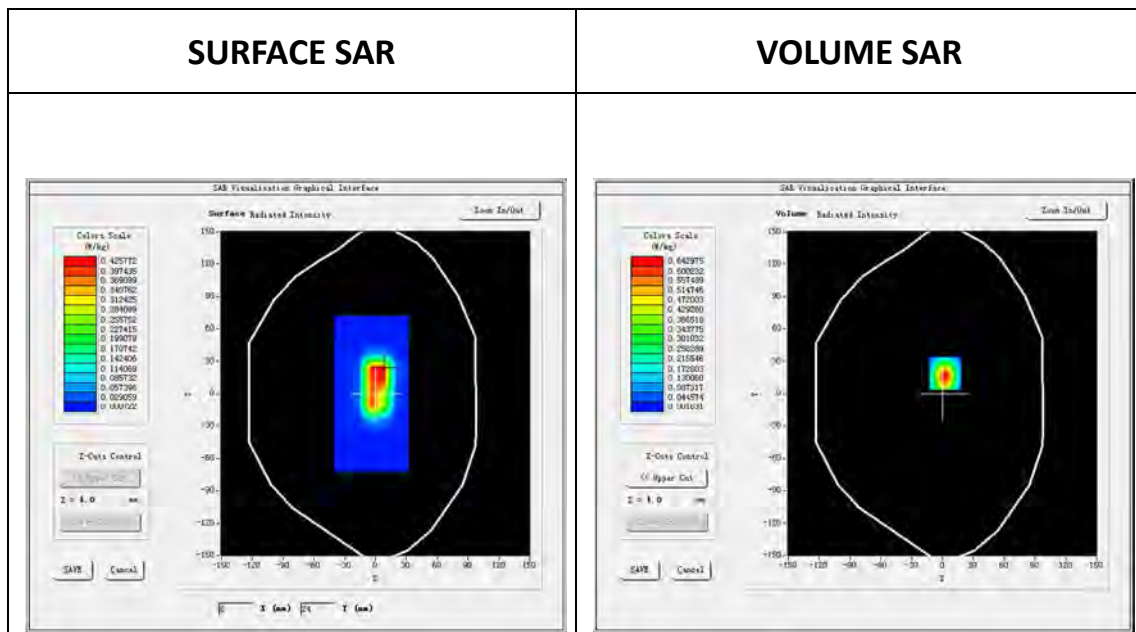

Maximum location: X=3.00, Y=19.00

SAR Peak: 1.18 W/kg

SAR 10g (W/Kg)	0.241573
SAR 1g (W/Kg)	0.575074

Z (mm)	0.00	4.00	8.00	12.00	16.00
SAR (W/Kg)	1.1543	0.6430	0.3444	0.1840	0.1024

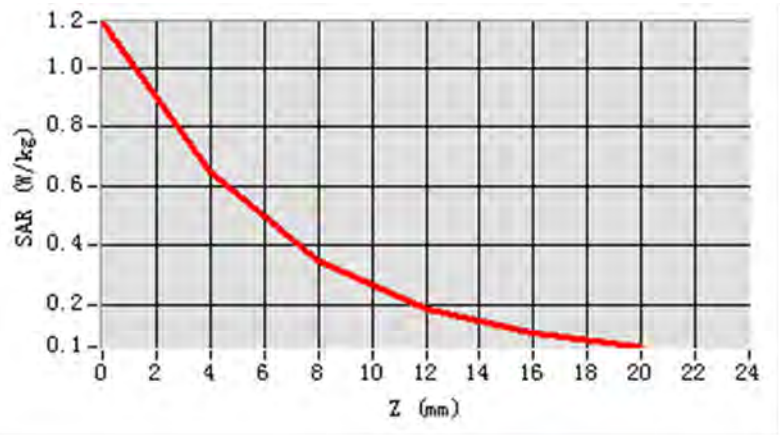

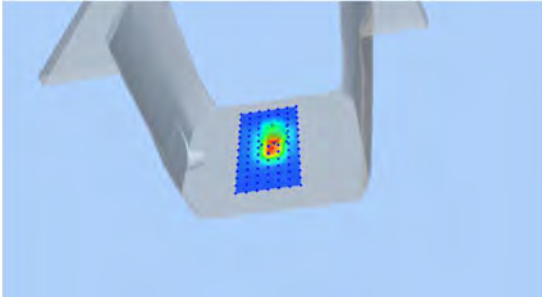
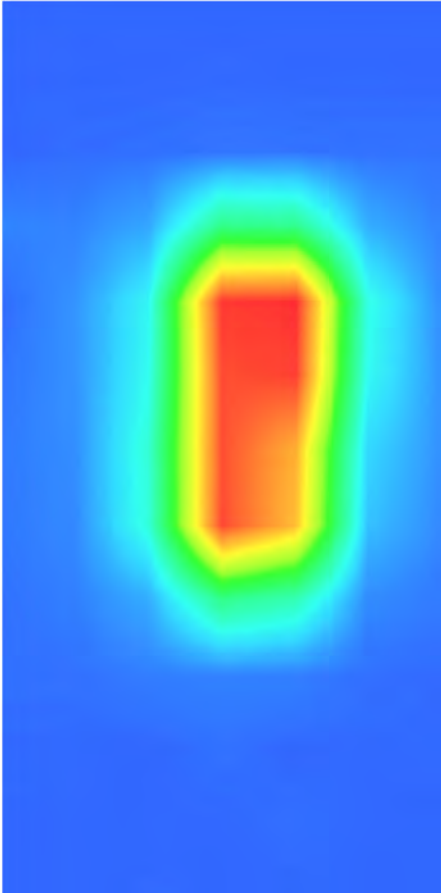
3D screen shot	Hot spot position
 <p>A 3D perspective view of a grey, L-shaped device. A small, rectangular area on the inner surface of the 'L' is highlighted with a color-coded grid, representing a hot spot. The colors range from blue (low SAR) to red (high SAR).</p>	 <p>A 2D heatmap visualization of the hot spot. The central region is colored red and orange, indicating the highest SAR values. This is surrounded by a green ring, and the outermost region is blue, indicating the lowest SAR values. The overall shape is roughly rectangular with rounded corners.</p>

MEASUREMENT 10

Type: Validation measurement

Date of measurement: 21/9/2016

Measurement duration: 21 minutes 36 seconds

Mobile Phone IMEI number: --

A. Experimental conditions.

<u>Area Scan</u>	dx=5mm dy=5mm
<u>ZoomScan</u>	7x7x8,dx=5mm dy=5mm dz=4mm
<u>Phantom</u>	<u>Validation plane</u>
<u>Device Position</u>	<u>Body</u>
<u>Band</u>	<u>CW2600</u>
<u>Channels</u>	<u>Middle</u>
<u>Signal</u>	<u>CW (Crest factor: 1.0)</u>

B. SAR Measurement Results

E-Field Probe	SATIMO SN_43/15_EP276
Frequency (MHz)	2600.0
Relative permittivity (real part)	54.228298
Relative permittivity (imaginary)	14.374000
Conductivity (S/m)	2.076244
Variation (%)	-0.480000
Temperature:	21.3°C
ConvF:	5.73

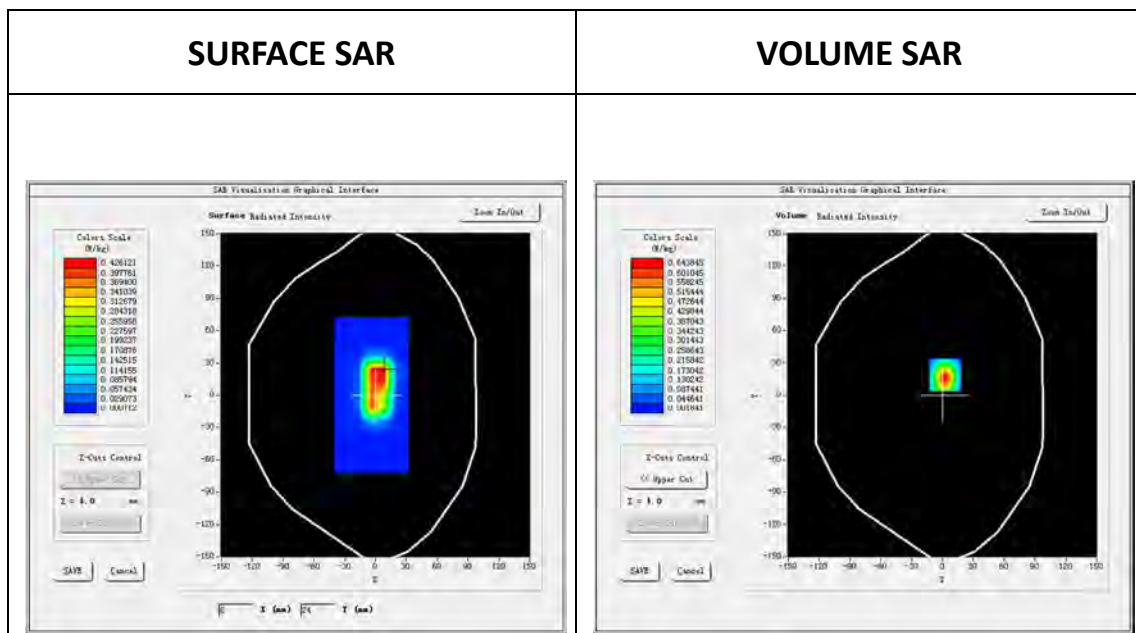

Maximum location: X=3.00, Y=19.00

SAR Peak: 1.18 W/kg

SAR 10g (W/Kg)	0.241881
SAR 1g (W/Kg)	0.575809

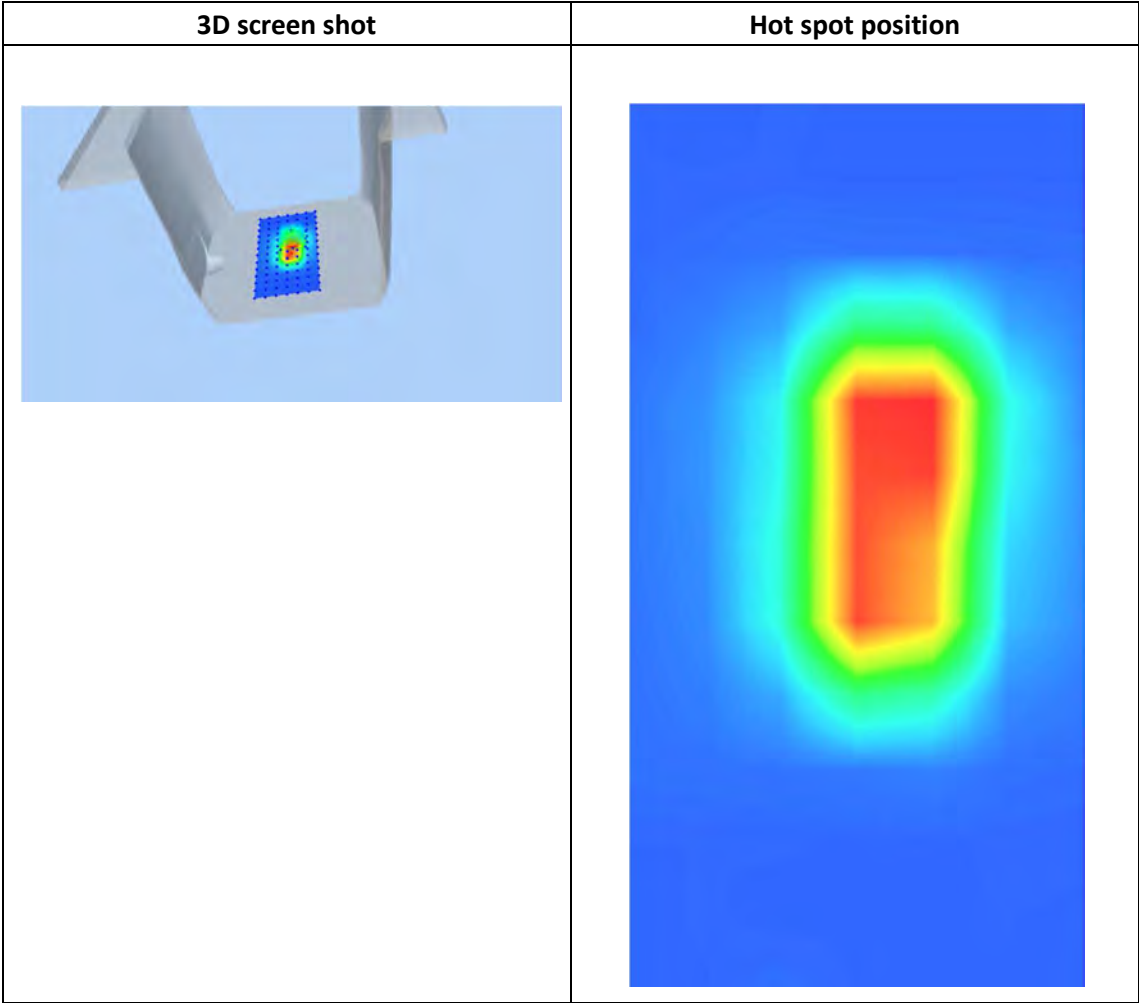
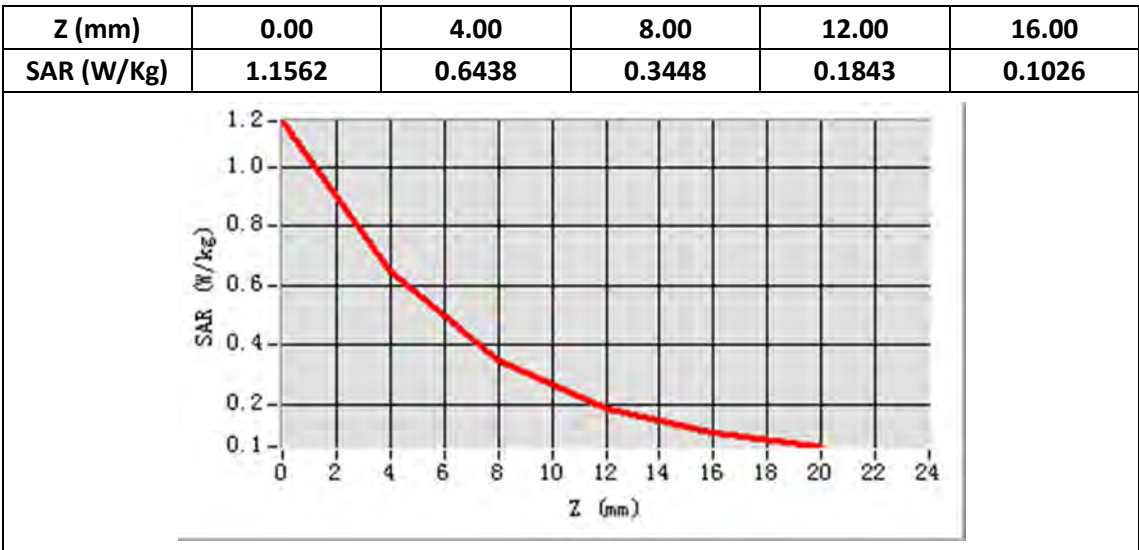

Appendix B. SAR Plots of SAR Measurement

The SAR plots for highest measured SAR in each exposure configuration, wireless mode and frequency band combination, and measured SAR > 1.5 W/kg are shown as follows.



Plot No	Band	Mode	Test Position	Channel	Battery
1	G850	GSM	Right Cheek	190	1

Type: Phone measurement

Date of measurement: 26/9/2016

Measurement duration: 20 minutes 29 seconds

Mobile Phone IMEI number: --

A. Experimental conditions.

<u>Area Scan</u>	<u>dx=8mm dy=8mm</u>
<u>ZoomScan</u>	<u>5x5x7,dx=8mm dy=8mm dz=5mm</u>
<u>Phantom</u>	<u>Right head</u>
<u>Device Position</u>	<u>Cheek</u>
<u>Band</u>	<u>GSM850</u>
<u>Channels</u>	<u>Middle</u>
<u>Signal</u>	<u>TDMA (Crest factor: 8.3)</u>

B.SAR Measurement Results

Middle Band SAR (Channel 190):

E-Field Probe	SATIMO SN_43/15_EP276
Frequency (MHz)	836.6
Relative permittivity (real part)	41.883472
Relative permittivity (imaginary)	19.277695
Conductivity (S/m)	0.895984
Variation (%)	-2.630000
ConvF:	6.81

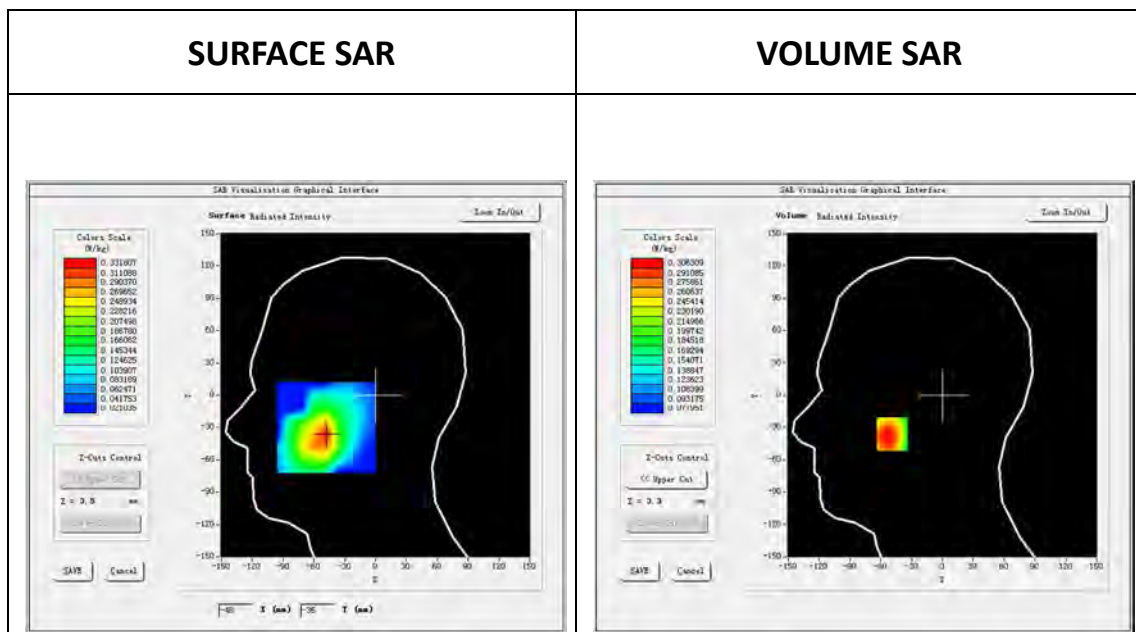

Maximum location: X=-49.00, Y=-36.00

SAR Peak: 0.35 W/kg

SAR 10g (W/Kg)	0.221099
SAR 1g (W/Kg)	0.295251

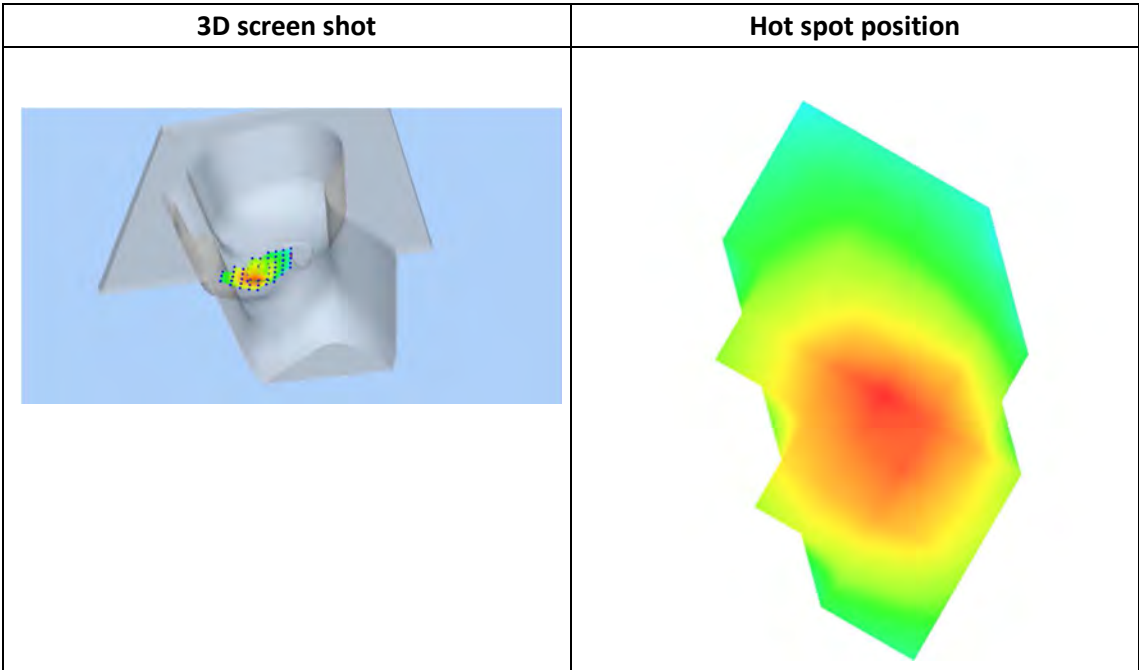
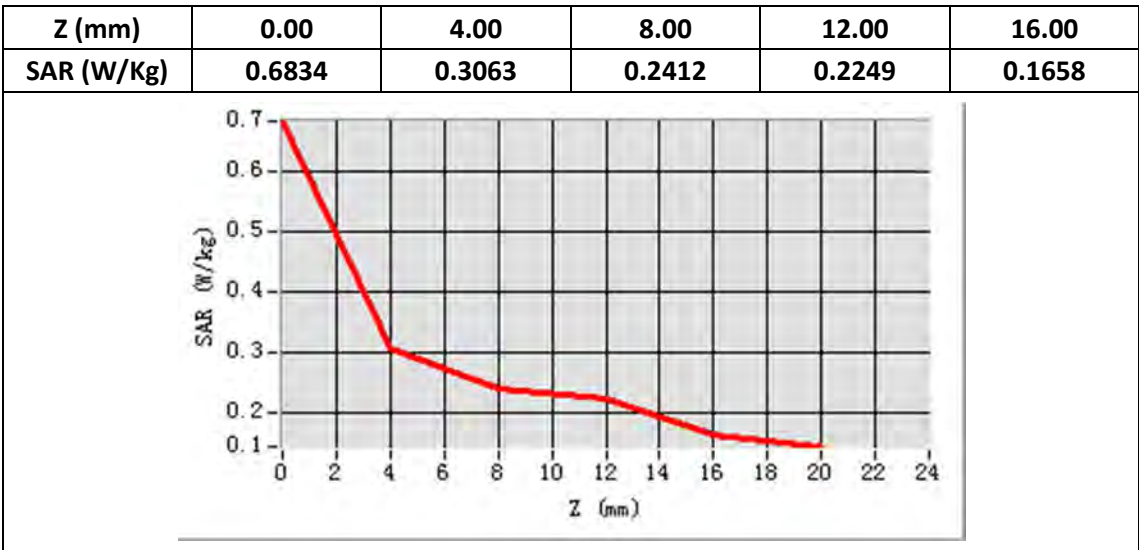

Plot No	Band	Mode	Test Position	Channel	Battery
2	G850	GSM	Back upward	190	1

Type: Phone measurement

Date of measurement: 19/9/2016

Measurement duration: 20 minutes 12 seconds

Mobile Phone IMEI number: --

A. Experimental conditions.

<u>Area Scan</u>	<u>dx=8mm dy=8mm</u>
<u>ZoomScan</u>	<u>5x5x7,dx=8mm dy=8mm dz=5mm</u>
<u>Phantom</u>	<u>Validation plane</u>
<u>Device Position</u>	<u>Body</u>
<u>Band</u>	<u>GSM850</u>
<u>Channels</u>	<u>Middle</u>
<u>Signal</u>	<u>TDMA (Crest factor: 8.3)</u>