

# FCC Radio Test Report

## FCC ID: 2AFRJ-DESS1

### Original Grant

**Report No.** : TB-FCC158915  
**Applicant** : Noke  
**Equipment Under Test (EUT)**  
**EUT Name** : Electric door strike lock controller  
**Model No.** : DESS1  
**Serial Model No.** : N/A  
**Brand Name** : NOKE  
**Receipt Date** : 2018-03-27  
**Test Date** : 2018-03-28 to 2018-04-08  
**Issue Date** : 2018-04-09  
**Standards** : FCC Part 15: 2017, Subpart C(15.247)  
**Test Method** : ANSI C63.10: 2013  
**Conclusions** : **PASS**

In the configuration tested, the EUT complied with the standards specified above,

**Test/Witness Engineer** : *Jason Xu* Jason Xu  
**Engineer Supervisor** : *Ivan Su* Ivan Su  
**Engineer Manager** : *Ray Lai* Ray Lai \*



This report details the results of the testing carried out on one sample. The results contained in this test report do not relate to other samples of the same product. The manufacturer should ensure that all products in series production are in conformity with the product sample detailed in the report.

## Contents

<b>CONTENTS.....</b>	<b>2</b>
<b>1. GENERAL INFORMATION ABOUT EUT .....</b>	<b>5</b>
1.1 Client Information.....	5
1.2 General Description of EUT (Equipment Under Test) .....	5
1.3 Block Diagram Showing the Configuration of System Tested.....	6
1.4 Description of Support Units .....	6
1.5 Description of Test Mode.....	7
1.6 Description of Test Software Setting .....	8
1.7 Measurement Uncertainty .....	8
1.8 Test Facility.....	9
<b>2. TEST SUMMARY .....</b>	<b>10</b>
<b>3. TEST EQUIPMENT.....</b>	<b>11</b>
<b>4. CONDUCTED EMISSION TEST .....</b>	<b>12</b>
4.1 Test Standard and Limit.....	12
4.2 Test Setup.....	12
4.3 Test Procedure.....	12
4.4 EUT Operating Mode .....	13
4.5 Test Da5ta.....	13
<b>5. RADIATED EMISSION TEST .....</b>	<b>14</b>
5.1 Test Standard and Limit.....	14
5.2 Test Setup.....	15
5.3 Test Procedure.....	16
5.4 EUT Operating Condition .....	17
5.5 Test Data.....	17
<b>6. RESTRICTED BANDS REQUIREMENT .....</b>	<b>18</b>
6.1 Test Standard and Limit.....	18
6.2 Test Setup.....	18
6.3 Test Procedure.....	18
6.4 EUT Operating Condition .....	19
6.5 Test Data.....	19
<b>7. BANDWIDTH TEST.....</b>	<b>20</b>
7.1 Test Standard and Limit.....	20
7.2 Test Setup.....	20
7.3 Test Procedure.....	20
7.4 EUT Operating Condition .....	20
7.5 Test Data.....	20
<b>8. PEAK OUTPUT POWER TEST.....</b>	<b>21</b>
8.1 Test Standard and Limit.....	21
8.2 Test Setup.....	21

8.3 Test Procedure.....	21
8.4 EUT Operating Condition .....	21
8.5 Test Data.....	21
<b>9. POWER SPECTRAL DENSITY TEST .....</b>	<b>22</b>
9.1 Test Standard and Limit.....	22
9.2 Test Setup.....	22
9.3 Test Procedure.....	22
9.4 EUT Operating Condition .....	22
9.5 Test Data.....	22
<b>10. ANTENNA REQUIREMENT.....</b>	<b>23</b>
10.1 Standard Requirement.....	23
10.2 Antenna Connected Construction .....	23
10.3 Result.....	23
<b>ATTACHMENT A-- RADIATED EMISSION TEST DATA .....</b>	<b>24</b>
<b>ATTACHMENT B-- RESTRICTED BANDS REQUIREMENT TEST DATA.....</b>	<b>38</b>
<b>ATTACHMENT C-- BANDWIDTH TEST DATA.....</b>	<b>48</b>
<b>ATTACHMENT D-- PEAK OUTPUT POWER TEST DATA.....</b>	<b>52</b>
<b>ATTACHMENT E-- POWER SPECTRAL DENSITY TEST DATA.....</b>	<b>60</b>



# 1. General Information about EUT

## 1.1 Client Information

<b>Applicant</b>	:	Noke
<b>Address</b>	:	2801 Thanksgiving Way, Ste 220 Lehi, UT 84043
<b>Manufacturer</b>	:	Mapleaf technology CO., LIMITED
<b>Address</b>	:	5B1003, Shengtaoshajunyuan, Baoan District, Shenzhen City, Guangdong, China

## 1.2 General Description of EUT (Equipment Under Test)

<b>EUT Name</b>	:	Electric door strike lock controller
<b>Models No.</b>	:	DESS1
<b>Model Difference</b>	:	N/A
<b>Product Description</b>	Operation Frequency:	Bluetooth 4.2(BLE): 2402MHz~2480MHz
	Number of Channel:	Bluetooth 4.2(BLE): 40 channels <i>see note(3)</i>
	RF Output Power:	0.564 dBm Conducted Power(Module 1) 0.129 dBm Conducted Power(Module 2)
	Antenna Gain:	0.5 dBi Internal Antenna
	Modulation Type:	GFSK
	Bit Rate of Transmitter:	1Mbps(GFSK)
<b>Power Rating</b>	:	DC 3.6V 2800mAh by Li-ion Battery. DC 12V from DC port.
<b>Connecting I/O Port(S)</b>	:	Please refer to the User's Manual
Remark: The EUT has two bluetooth Module (N52832), the one is for APP, the other one is for Networking.		

### Note:

This Test Report is FCC Part 15.247 for BLE, the test procedure follows the FCC KDB 558074 D01 DTS Means Guidance v04.

- (1) For a more detailed features description, please refer to the manufacturer's specifications or the User's Manual.
- (2) Antenna information provided by the applicant.

(3) Channel List:

Channel	Frequency (MHz)	Channel	Frequency (MHz)	Channel	Frequency (MHz)
00	2402	14	2430	28	2458
01	2404	15	2432	29	2460
02	2406	16	2434	30	2462
03	2408	17	2436	31	2464
04	2410	18	2438	32	2466
05	2412	19	2440	33	2468
06	2414	20	2442	34	2470
07	2416	21	2444	35	2472
08	2418	22	2446	36	2474
09	2420	23	2448	37	2476
10	2422	24	2450	38	2478
11	2424	25	2452	39	2480
12	2426	26	2454		
13	2428	27	2456		

1.3 Block Diagram Showing the Configuration of System Tested

**TX Mode**



1.4 Description of Support Units

The EUT has been test as an independent unit.

### 1.5 Description of Test Mode

To investigate the maximum EMI emission characteristics generates from EUT, the test system was pre-scanning tested base on the consideration of following EUT operation mode or test configuration mode which possible have effect on EMI emission level. Each of these EUT operation mode(s) or test configuration mode(s) mentioned follow was evaluated respectively.

For Conducted Test	
Final Test Mode	Description
Mode 1	N/A

For Radiated Test	
Final Test Mode	Description
Mode 2	TX Mode
Mode 3	TX Mode (Channel 00/20/39)

Note: The EUT has Two bluetooth Module, they can be operated simultaneously.

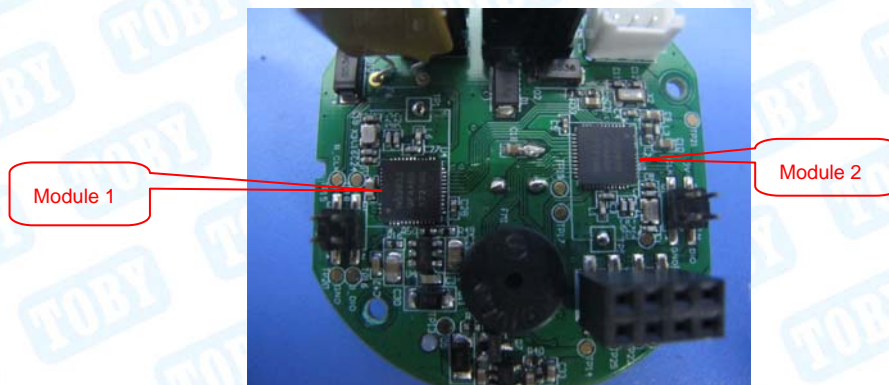

**Note:**

- (1) For all test, we have verified the construction and function in typical operation. And all the test modes were carried out with the EUT in transmitting operation in maximum power with all kinds of data rate.

According to ANSI C63.10 standards, the measurements are performed at the highest, middle, lowest available channels, and the worst case data rate as follows:

BLE Mode: GFSK Modulation Transmitting mode.

- (2) During the testing procedure, the continuously transmitting with the maximum power mode was programmed by the customer.
- (3) The EUT is considered a portable unit; in normal use it was positioned on X-plane. The worst case was found positioned on X-plane. Therefore only the test data of this X-plane was used for radiated emission measurement test.

## 1.6 Description of Test Software Setting

During testing channel & Power controlling software provided by the customer was used to control the operating channel as well as the output power level. The RF output power selection is for the setting of RF output power expected by the customer and is going to be fixed on the firmware of the final end product power parameters of RF setting.

Test Software Version	Nrfgo studio		
Frequency	2402 MHz	2442MHz	2480 MHz
BLE GFSK	DEF	DEF	DEF

## 1.7 Measurement Uncertainty

The reported uncertainty of measurement  $y \pm U$ , where expanded uncertainty  $U$  is based on a standard uncertainty multiplied by a coverage factor of  $k=2$ , providing a level of confidence of approximately 95 %.

Test Item	Parameters	Expanded Uncertainty ( $U_{Lab}$ )
Conducted Emission	Level Accuracy: 9kHz~150kHz 150kHz to 30MHz	$\pm 3.42$ dB $\pm 3.42$ dB
Radiated Emission	Level Accuracy: 9kHz to 30 MHz	$\pm 4.60$ dB
Radiated Emission	Level Accuracy: 30MHz to 1000 MHz	$\pm 4.40$ dB
Radiated Emission	Level Accuracy: Above 1000MHz	$\pm 4.20$ dB



## 1.8 Test Facility

The testing report were performed by the Shenzhen Toby Technology Co., Ltd., in their facilities located at 1A/F., Bldg.6, Yusheng Industrial Zone, The National Road No.107 Xixiang Section 467, Xixiang, Bao'an, Shenzhen, Guangdong, China. At the time of testing, the following bodies accredited the Laboratory:

### **CNAS (L5813)**

The Laboratory has been accredited by CNAS to ISO/IEC 17025: 2005 General Requirements for the Competence of Testing and Calibration Laboratories for the competence in the field of testing. And the Registration No.: CNAS L5813.

### **A2LA Certificate No.: 4750.01**

The laboratory has been accredited by American Association for Laboratory Accreditation(A2LA) to ISO/IEC 17025: 2005 General Requirements for the Competence of Testing and Calibration Laboratories for the technical competence in the field of Electrical Testing. And the A2LA Certificate No.: 4750.01.

### **IC Registration No.: (11950A-1)**

The Laboratory has been registered by Certification and Engineering Bureau of Industry Canada for radio equipment testing. The site registration: Site# 11950A-1.

## 2. Test Summary

FCC Part 15 Subpart C(15.247)/RSS 247 Issue 1				
Standard Section		Test Item	Judgment	Remark
FCC	IC			
15.203		Antenna Requirement	PASS	N/A
15.207(a)	RSS-GEN 7.2.4	Conducted Emission	N/A	(1)
15.205&15.247(d)	RSS-GEN 7.2.2	Band-Edge & Unwanted Emissions into Restricted Frequency	PASS	N/A
15.247(a)(2)	RSS 247 5.2 (1)	6dB Bandwidth	PASS	N/A
15.247(b)(3)	RSS 247 5.4 (4)	Conducted Max Output Power	PASS	N/A
15.247(e)	RSS 247 5.2 (2)	Power Spectral Density	PASS	N/A
15.205, 15.209&15.247(d)	RSS 247 5.5	Transmitter Radiated Spurious & Unwanted Emissions into Restricted Frequency	PASS	N/A

**Note:** (1) The EUT is powered by Li-ion battery, no requirement for this test item.  
N/A is an abbreviation for Not Applicable.

### 3. Test Equipment

Conducted Emission Test					
Equipment	Manufacturer	Model No.	Serial No.	Last Cal.	Cal. Due Date
EMI Test Receiver	Rohde & Schwarz	ESCI	100321	Jul. 20, 2017	Jul. 19, 2018
RF Switching Unit	Compliance Direction Systems Inc	RSU-A4	34403	Jul. 20, 2017	Jul. 19, 2018
AMN	SCHWARZBECK	NNBL 8226-2	8226-2/164	Jul. 20, 2017	Jul. 19, 2018
LISN	Rohde & Schwarz	ENV216	101131	Jul. 21, 2017	Jul. 20, 2018
Radiation Emission Test					
Equipment	Manufacturer	Model No.	Serial No.	Last Cal.	Cal. Due Date
Spectrum Analyzer	Agilent	E4407B	MY45106456	Jul. 20, 2017	Jul. 19, 2018
EMI Test Receiver	Rohde & Schwarz	ESPI	100010/007	Jul. 20, 2017	Jul. 19, 2018
Bilog Antenna	ETS-LINDGREN	3142E	00117537	Mar.16, 2018	Mar. 15, 2019
Bilog Antenna	ETS-LINDGREN	3142E	00117542	Mar.16, 2018	Mar. 15, 2019
Horn Antenna	ETS-LINDGREN	3117	00143207	Mar.16, 2018	Mar. 15, 2019
Horn Antenna	ETS-LINDGREN	3117	00143209	Mar.16, 2018	Mar. 15, 2019
Loop Antenna	SCHWARZBECK	FMZB 1519 B	1519B-059	Jul. 03, 2017	Jul. 02, 2018
Pre-amplifier	Sonoma	310N	185903	Mar.17, 2018	Mar. 16, 2019
Pre-amplifier	HP	8449B	3008A00849	Mar.17, 2018	Mar. 16, 2019
Cable	HUBER+SUHNER	100	SUCOFLEX	Mar.17, 2018	Mar. 16, 2019
Positioning Controller	ETS-LINDGREN	2090	N/A	N/A	N/A
Antenna Conducted Emission					
Equipment	Manufacturer	Model No.	Serial No.	Last Cal.	Cal. Due Date
Spectrum Analyzer	Agilent	E4407B	MY45106456	Jul. 20, 2017	Jul. 19, 2018
Spectrum Analyzer	Rohde & Schwarz	ESCI	100010/007	Jul. 20, 2017	Jul. 19, 2018
MXA Signal Analyzer	Agilent	N9020A	MY49100060	Oct. 26, 2017	Oct. 25, 2018
Vector Signal Generator	Agilent	N5182A	MY50141294	Oct. 26, 2017	Oct. 25, 2018
Analog Signal Generator	Agilent	N5181A	MY50141953	Oct. 26, 2017	Oct. 25, 2018
RF Power Sensor	DARE!! Instruments	RadiPowerRPR3006W	17I00015SNO26	Oct. 26, 2017	Oct. 25, 2018
	DARE!! Instruments	RadiPowerRPR3006W	17I00015SNO29	Oct. 26, 2017	Oct. 25, 2018
	DARE!! Instruments	RadiPowerRPR3006W	17I00015SNO31	Oct. 26, 2017	Oct. 25, 2018
	DARE!! Instruments	RadiPowerRPR3006W	17I00015SNO33	Oct. 26, 2017	Oct. 25, 2018

## 4. Conducted Emission Test

### 4.1 Test Standard and Limit

#### 4.1.1 Test Standard

FCC Part 15.207

#### 4.1.2 Test Limit

**Conducted Emission Test Limit**

Frequency	Maximum RF Line Voltage (dB $\mu$ V)	
	Quasi-peak Level	Average Level
150kHz~500kHz	66 ~ 56 *	56 ~ 46 *
500kHz~5MHz	56	46
5MHz~30MHz	60	50

Notes:

(1) \*Decreasing linearly with logarithm of the frequency.

(2) The lower limit shall apply at the transition frequencies.

(3) The limit decrease in line with the logarithm of the frequency in the range of 0.15 to 0.50MHz.

### 4.2 Test Setup

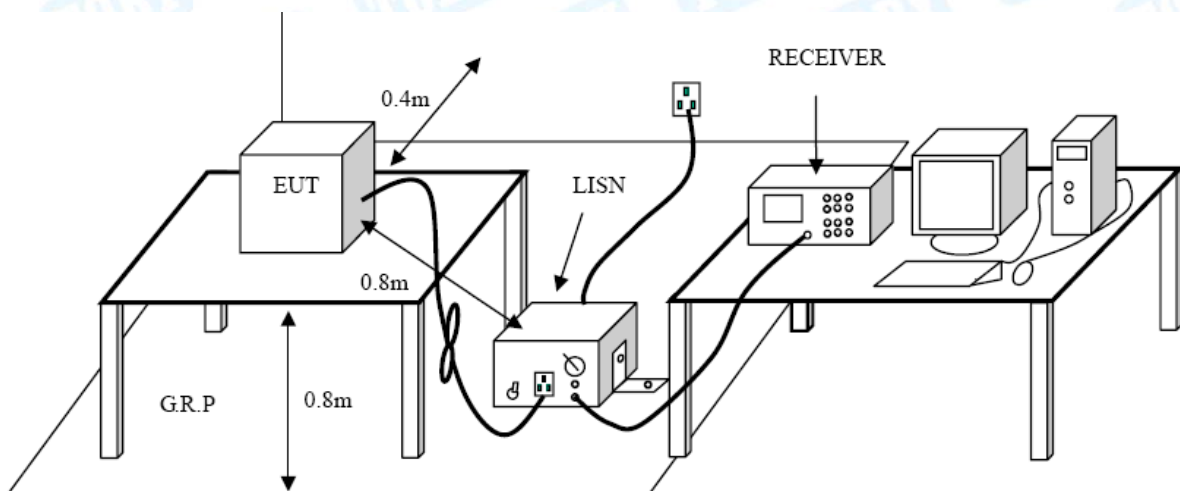

### 4.3 Test Procedure

The EUT was placed 0.8 meters from the horizontal ground plane with EUT being connected to the power mains through a line impedance stabilization network (LISN). All other support equipments powered from additional LISN(s). The LISN provide 50 Ohm/ 50uH of coupling impedance for the measuring instrument.

Interconnecting cables that hang closer than 40 cm to the ground plane shall be folded back and forth in the center forming a bundle 30 to 40 cm long.

I/O cables that are not connected to a peripheral shall be bundled in the center. The end of the cable may be terminated, if required, using the correct terminating impedance. The overall length shall not exceed 1 m.

LISN at least 80 cm from nearest part of EUT chassis.

The bandwidth of EMI test receiver is set at 9 kHz, and the test frequency band is from 0.15MHz to 30MHz.

#### 4.4 EUT Operating Mode

Please refer to the description of test mode.

#### 4.5 Test Da5ta

The EUT is powered by battery, no requirement for this test item.

## 5. Radiated Emission Test

### 5.1 Test Standard and Limit

- 5.1.1 Test Standard  
FCC Part 15.247(d)
- 5.1.2 Test Limit

**Radiated Emission Limits (9kHz~1000MHz)**

Frequency (MHz)	Field Strength (microvolt/meter)	Measurement Distance (meters)
0.009~0.490	2400/F(KHz)	300
0.490~1.705	24000/F(KHz)	30
1.705~30.0	30	30
30~88	100	3
88~216	150	3
216~960	200	3
Above 960	500	3

**Radiated Emission Limit (Above 1000MHz)**

Frequency (MHz)	Distance Meters(at 3m)	
	Peak (dBuV/m)	Average (dBuV/m)
Above 1000	74	54

**Note:**

- (1) The tighter limit applies at the band edges.
- (2) Emission Level (dBuV/m)=20log Emission Level (uV/m)

5.2 Test Setup

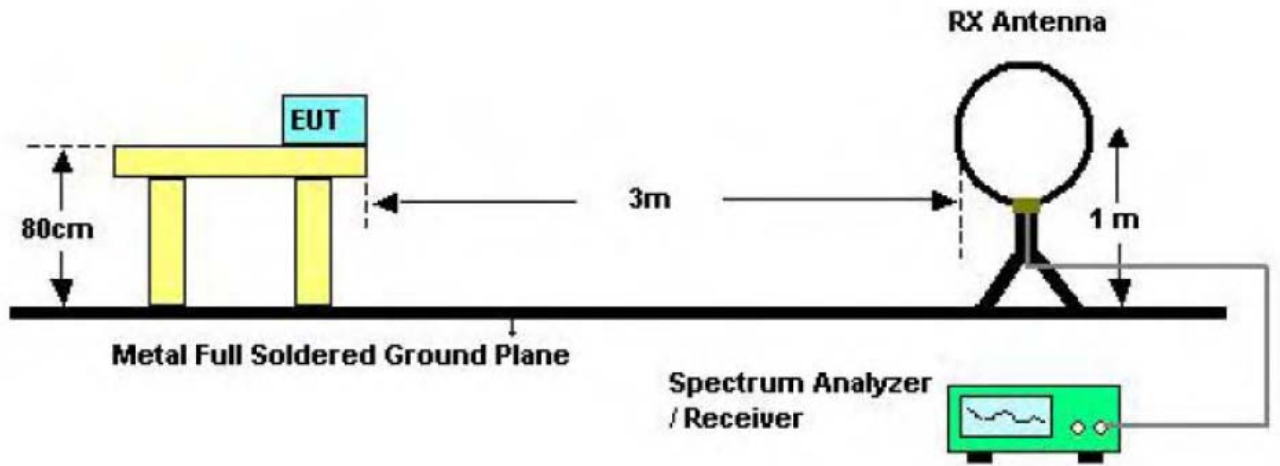

Below 30MHz Test Setup

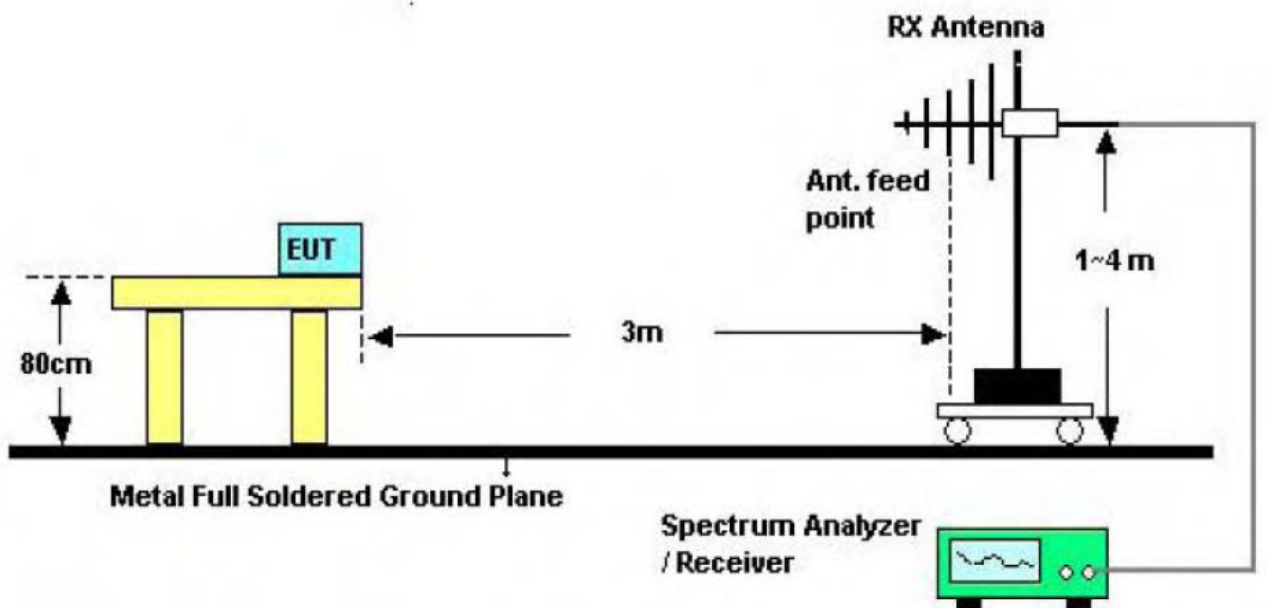

Below 1000MHz Test Setup



Above 1GHz Test Setup

### 5.3 Test Procedure

- (1) The measuring distance of 3m shall be used for measurements at frequency up to 1GHz and above 1 GHz. The EUT was placed on a rotating 0.8m high above ground, the table was rotated 360 degrees to determine the position of the highest radiation.
- (2) Measurements at frequency above 1GHz. The EUT was placed on a rotating 1.5m high above the ground. RF absorbers covered the ground plane with a minimum area of 3.0m by 3.0m between the EUT and measurement receiver antenna. The RF absorber shall not exceed 30cm in high above the conducting floor. The table was rotated 360 degrees to determine the position of the highest radiation.
- (3) The Test antenna shall vary between 1m and 4m, Both Horizontal and Vertical antenna are set to make measurement.
- (4) The initial step in collecting conducted emission data is a spectrum analyzer peak detector mode pre-scanning the measurement frequency range. Significant peaks are then marked and then Quasi Peak detector mode re-measured.
- (5) If the Peak Mode measured value compliance with and lower than Quasi Peak Mode Limit Bellow 1 GHz, the EUT shall be deemed to meet QP Limits and then no additional QP Mode measurement performed. But the Peak Value and average value both need to comply with applicable limit above 1 GHz.
- (6) Testing frequency range below 1GHz the measuring instrument use VBW=120 kHz with Quasi-peak detection.
- (7) Testing frequency range above 1GHz the measuring instrument use RBW=1 MHz and VBW=3 MHz with Peak Detector for Peak Values, and use RBW=1 MHz and VBW=10 Hz with Peak Detector for Average Values.
- (8) For the actual test configuration, please see the test setup photo.



## 5.4 EUT Operating Condition

The Equipment Under Test was set to Continual Transmitting in maximum power.

## 5.5 Test Data

Remark: During testing above 1GHz the measuring instrument use RBW=1 MHz and VBW=3 MHz with Peak Detector for Peak Values, and use RBW=1 MHz and VBW=10 Hz with Peak Detector for Average Values.

Please refer to the Attachment A.

## 6. Restricted Bands Requirement

### 6.1 Test Standard and Limit

#### 6.1.1 Test Standard

FCC Part 15.247(d) FCC Part 15.205

#### 6.1.2 Test Limit

Restricted Frequency Band (MHz)	Distance Meters(at 3m)	
	Peak (dBuV/m)	Average (dBuV/m)
2310 ~2390	74	54
2483.5 ~2500	74	54

### 6.2 Test Setup

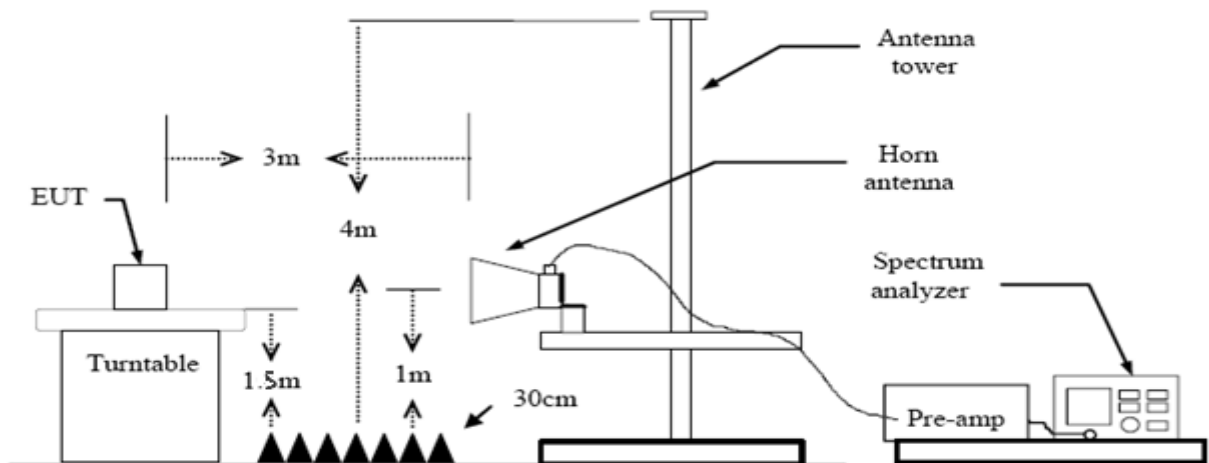

### 6.3 Test Procedure

- (1) The measuring distance of 3m shall be used for measurements at frequency up to 1GHz and above 1 GHz. The EUT was placed on a rotating 0.8m high above ground, the table was rotated 360 degrees to determine the position of the highest radiation.
- (2) Measurements at frequency above 1GHz. The EUT was placed on a rotating 1.5m high above the ground. RF absorbers covered the ground plane with a minimum area of 3.0m by 3.0m between the EUT and measurement receiver antenna. The RF absorber shall not exceed 30cm in high above the conducting floor. The table was rotated 360 degrees to determine the position of the highest radiation.
- (3) The Test antenna shall vary between 1m and 4m, Both Horizontal and Vertical antenna are set to make measurement.
- (4) The initial step in collecting conducted emission data is a spectrum analyzer peak detector

mode pre-scanning the measurement frequency range. Significant peaks are then marked and then Quasi Peak detector mode re-measured.

- (5) If the Peak Mode measured value compliance with and lower than Quasi Peak Mode Limit Bellow 1 GHz, the EUT shall be deemed to meet QP Limits and then no additional QP Mode measurement performed. But the Peak Value and average value both need to comply with applicable limit above 1 GHz.
- (6) Testing frequency range below 1GHz the measuring instrument use VBW=120 kHz with Quasi-peak detection.
- (7) Testing frequency range above 1GHz the measuring instrument use RBW=1 MHz and VBW=3 MHz with Peak Detector for Peak Values, and use RBW=1 MHz and VBW=10 Hz with Peak Detector for Average Values.
- (8) For the actual test configuration, please see the test setup photo.

#### 6.4 EUT Operating Condition

The Equipment Under Test was set to Continual Transmitting in maximum power.

#### 6.5 Test Data

Remark: During testing above 1GHz the measuring instrument use RBW=1 MHz and VBW=3 MHz with Peak Detector for Peak Values, and use RBW=1 MHz and VBW=10 Hz with Peak Detector for Average Values.

Please refer to the Attachment B.

## 7. Bandwidth Test

### 7.1 Test Standard and Limit

#### 7.1.1 Test Standard

FCC Part 15.247 (a)(2)

#### 7.1.2 Test Limit

FCC Part 15 Subpart C(15.247)/RSS-247		
Test Item	Limit	Frequency Range(MHz)
Bandwidth	$\geq 500$ KHz (6dB bandwidth)	2400~2483.5

### 7.2 Test Setup

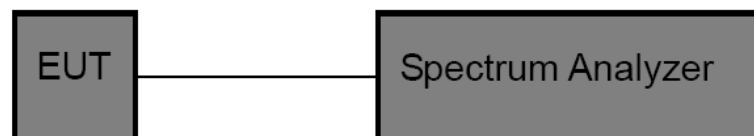

### 7.3 Test Procedure

- (1) The EUT was directly connected to the spectrum analyzer and antenna output port as show in the block diagram above.
- (2) The bandwidth is measured at an amplitude level reduced 6dB from the reference level. The reference level is the level of the highest amplitude signal observed from the transmitter at the fundamental frequency. Once the reference level is established, the equipment is conditioned with typical modulating signal to produce the worst -case (i.e the widest) bandwidth.
- (3) Measure the channel separation the spectrum analyzer was set to Resolution Bandwidth:100 kHz, and Video Bandwidth:300 kHz, Detector: Peak, Sweep Time set auto.

### 7.4 EUT Operating Condition

The EUT was set to continuously transmitting in each mode and low, middle and high channel for the test.

### 7.5 Test Data

Please refer to the Attachment C.

## 8. Peak Output Power Test

### 8.1 Test Standard and Limit

- 8.1.1 Test Standard  
FCC Part 15.247 (b)(3)
- 8.1.2 Test Limit

FCC Part 15 Subpart C(15.247)/RSS-247		
Test Item	Limit	Frequency Range(MHz)
Peak Output Power	1 Watt or 30 dBm	2400~2483.5

### 8.2 Test Setup

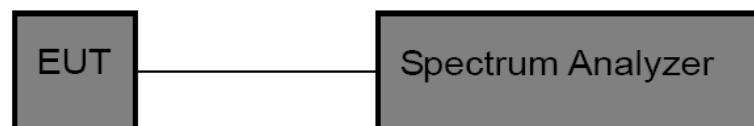

### 8.3 Test Procedure

The EUT was directly connected to the Spectrum Analyzer and antenna output port as show in the block diagram above. The measurement is according to section 9.1.1 of KDB 558074 D01 DTS Meas Guidance v04.

- (1) Set the  $RBW \geq DTS$  Bandwidth
- (2) Set  $VBW \geq 3 * RBW$
- (3) Set  $Span \geq 3 * RBW$
- (4) Sweep time=auto
- (5) Detector= peak
- (6) Trace mode= maxhold.
- (7) Allow trace to fully stabilize, and then use peak marker function to determine the peak amplitude level.

### 8.4 EUT Operating Condition

The EUT was set to continuously transmitting in the max power during the test.

### 8.5 Test Data

Please refer to the Attachment D.

## 9. Power Spectral Density Test

### 9.1 Test Standard and Limit

#### 9.1.1 Test Standard

FCC Part 15.247 (e)

#### 9.1.2 Test Limit

FCC Part 15 Subpart C(15.247)		
Test Item	Limit	Frequency Range(MHz)
Power Spectral Density	8dBm(in any 3 kHz)	2400~2483.5

### 9.2 Test Setup

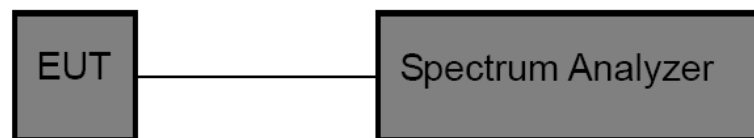

### 9.3 Test Procedure

The EUT was directly connected to the Spectrum Analyzer and antenna output port as show in the block diagram above. The measurement according to section 10.2 of KDB 558074 D01 DTS Meas Guidance v04.

- (1) The EUT was directly connected to the spectrum analyzer and antenna output port as show in the block diagram above.
- (2) Set analyser center frequency to DTS channel center frequency.
- (3) Set the span to 1.5 times the DTS bandwidth.
- (4) Set the RBW to: 3 kHz
- (5) Set the VBW to: 10 kHz
- (6) Detector: peak
- (7) Sweep time: auto
- (8) Allow trace to fully stabilize. Then use the peak marker function to determine the maximum amplitude level.

### 9.4 EUT Operating Condition

The EUT was set to continuously transmitting in each mode and low, Middle and high channel for the test.

### 9.5 Test Data

Please refer to the Attachment E.

## 10. Antenna Requirement

### 10.1 Standard Requirement

#### 10.1.1 Standard

FCC Part 15.203

#### 10.1.2 Requirement

An intentional radiator shall be designed to ensure that no antenna other than that furnished by the responsible party shall be used with the device. The use of a permanently attached antenna or of an antenna that uses a unique coupling to the intentional radiator shall be considered sufficient to comply with the provisions of this Section. The manufacturer may design the unit so that a broken antenna can be replaced by the user, but the use of a standard antenna jack or electrical connector is prohibited.

### 10.2 Antenna Connected Construction

The directional gains of the antenna used for transmitting is 0.5dBi, and the antenna de-signed with permanent attachment and no consideration of replacement. Please see the EUT photo for details.

### 10.3 Result

The EUT antenna is a Internal Antenna. It complies with the standard requirement.

Antenna Type
<input checked="" type="checkbox"/> Permanent attached antenna
<input type="checkbox"/> Unique connector antenna
<input type="checkbox"/> Professional installation antenna

## Attachment A-- Radiated Emission Test Data

### 9 KHz~30 MHz

From 9 KHz to 30 MHz: Conclusion: PASS

Note: The amplitude of spurious emissions which are attenuated by more than 20dB  
Below the permissible value has no need to be reported.

### 30MHz~1GHz

<b>Temperature:</b>	25°C	<b>Relative Humidity:</b>	55%
<b>Test Voltage:</b>	DC 3.6V		
<b>Ant. Pol.</b>	Horizontal		
<b>Test Mode:</b>	BLE TX 2402 Mode		
<b>Remark:</b>	Only worse case is reported		

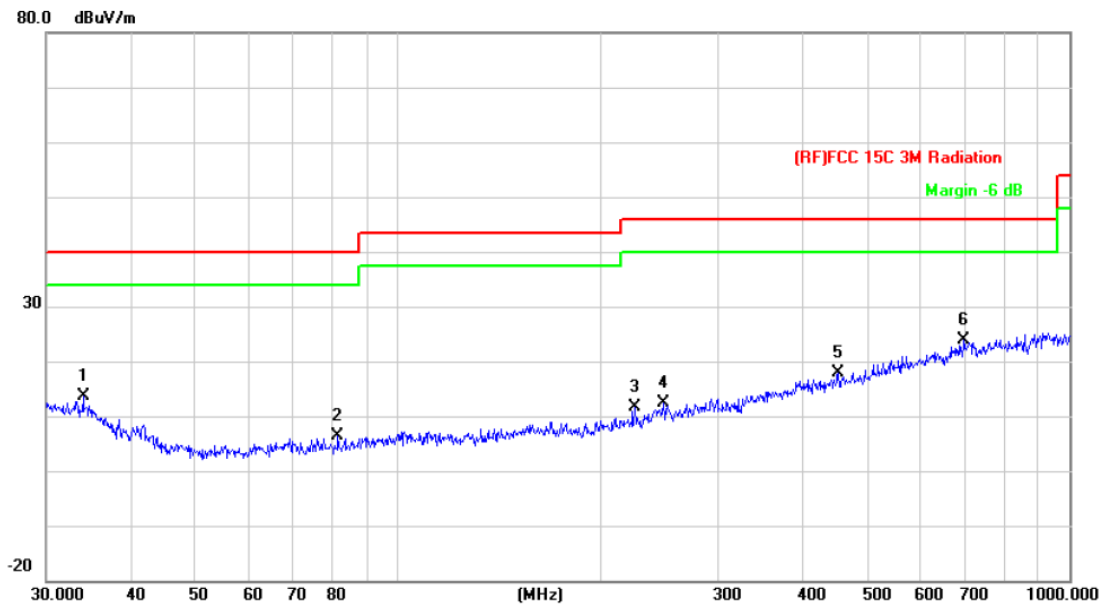

No.	Mk.	Freq.	Reading Level	Correct Factor	Measurement	Limit	Over	Detector
		MHz	dBuV	dB/m	dBuV/m	dBuV/m	dB	
1		34.0365	29.50	-15.95	13.55	40.00	-26.45	peak
2		81.4970	29.09	-22.65	6.44	40.00	-33.56	peak
3		225.3080	29.86	-18.31	11.55	46.00	-34.45	peak
4		248.5519	29.51	-17.15	12.36	46.00	-33.64	peak
5		452.7197	29.31	-11.44	17.87	46.00	-28.13	peak
6	*	696.8567	29.29	-5.42	23.87	46.00	-22.13	peak

\*:Maximum data x:Over limit !:over margin

**Emission Level= Read Level+ Correct Factor**



<b>Temperature:</b>	25°C	<b>Relative Humidity:</b>	55%
<b>Test Voltage:</b>	DC 3.6V		
<b>Ant. Pol.</b>	Vertical		
<b>Test Mode:</b>	BLE TX 2402 Mode		
<b>Remark:</b>	Only worse case is reported		

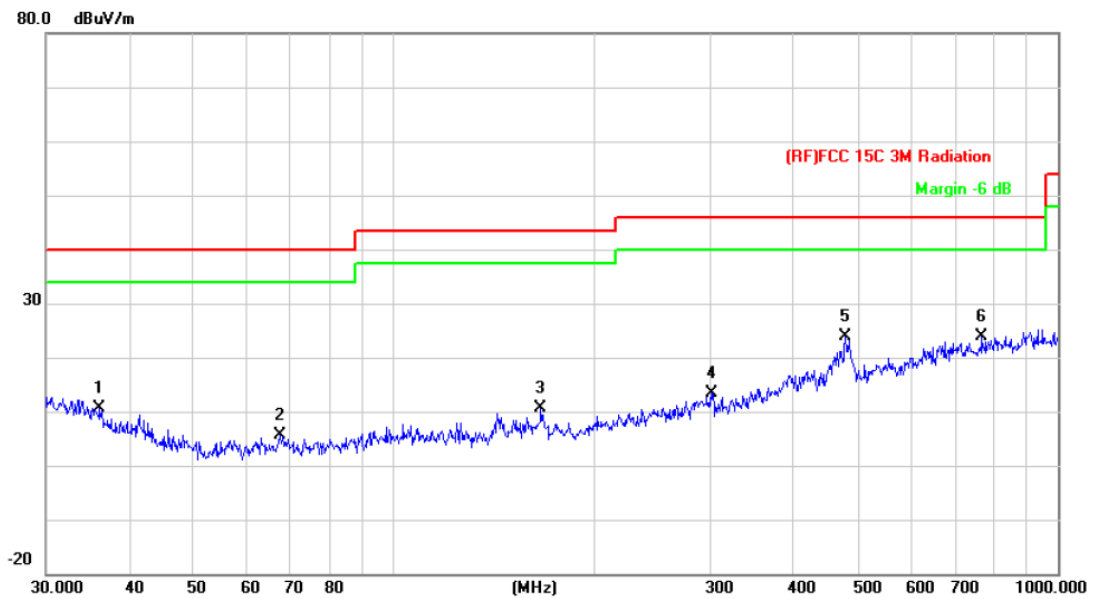

No.	Mk.	Freq. MHz	Reading Level dBuV	Correct Factor dB/m	Measure- ment dBuV/m	Limit dBuV/m	Over dB	Detector
1		36.1272	27.74	-17.22	10.52	40.00	-29.48	peak
2		67.4382	28.79	-23.28	5.51	40.00	-34.49	peak
3		166.6514	30.77	-20.21	10.56	43.50	-32.94	peak
4		301.4224	29.35	-15.88	13.47	46.00	-32.53	peak
5	*	478.8456	34.68	-10.73	23.95	46.00	-22.05	peak
6		768.7481	29.55	-5.63	23.92	46.00	-22.08	peak

\*:Maximum data    x:Over limit    !:over margin

**Emission Level= Read Level+ Correct Factor**

**Above 1GHz**

<b>Temperature:</b>	25°C	<b>Relative Humidity:</b>	55%
<b>Test Voltage:</b>	DC 3.6V		
<b>Ant. Pol.</b>	Horizontal		
<b>Test Mode:</b>	BLE Mode TX 2402 MHz(Module 1)		
<b>Remark:</b>	No report for the emission which more than 10 dB below the prescribed limit.		

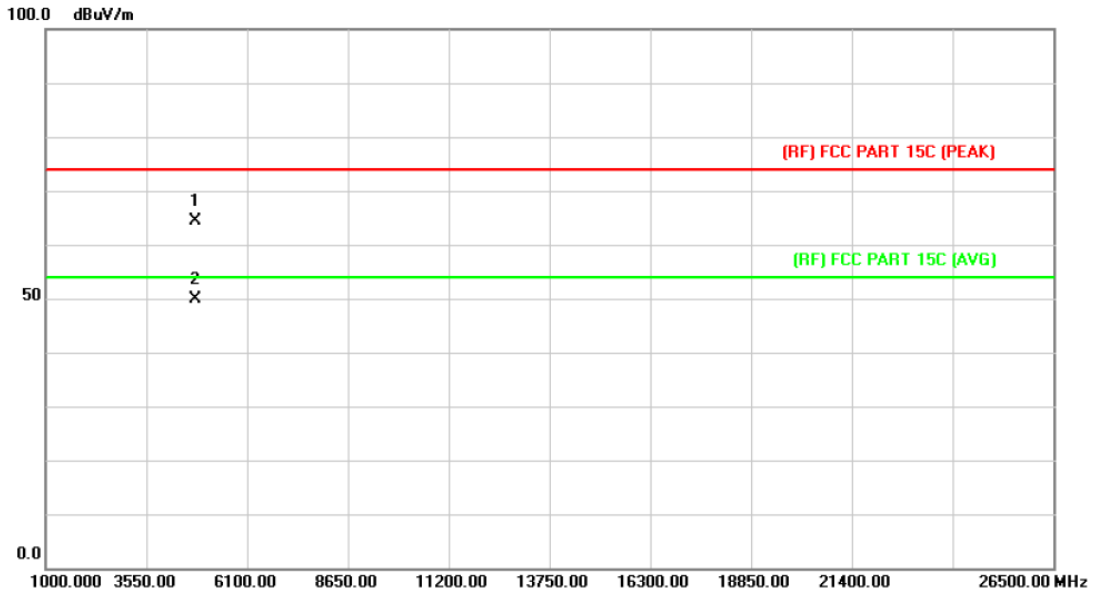

No.	Mk.	Freq. MHz	Reading Level dBuV	Correct Factor dB/m	Measure- ment dBuV/m	Limit dBuV/m	Over dB	Detector
1		4803.130	48.42	15.86	64.28	74.00	-9.72	peak
2	*	4804.030	34.11	15.87	49.98	54.00	-4.02	AVG

**Emission Level= Read Level+ Correct Factor**

<b>Temperature:</b>	25°C	<b>Relative Humidity:</b>	55%
<b>Test Voltage:</b>	DC 3.6V		
<b>Ant. Pol.</b>	Vertical		
<b>Test Mode:</b>	BLE Mode TX 2402 MHz(Module 1)		
<b>Remark:</b>	No report for the emission which more than 10 dB below the prescribed limit.		

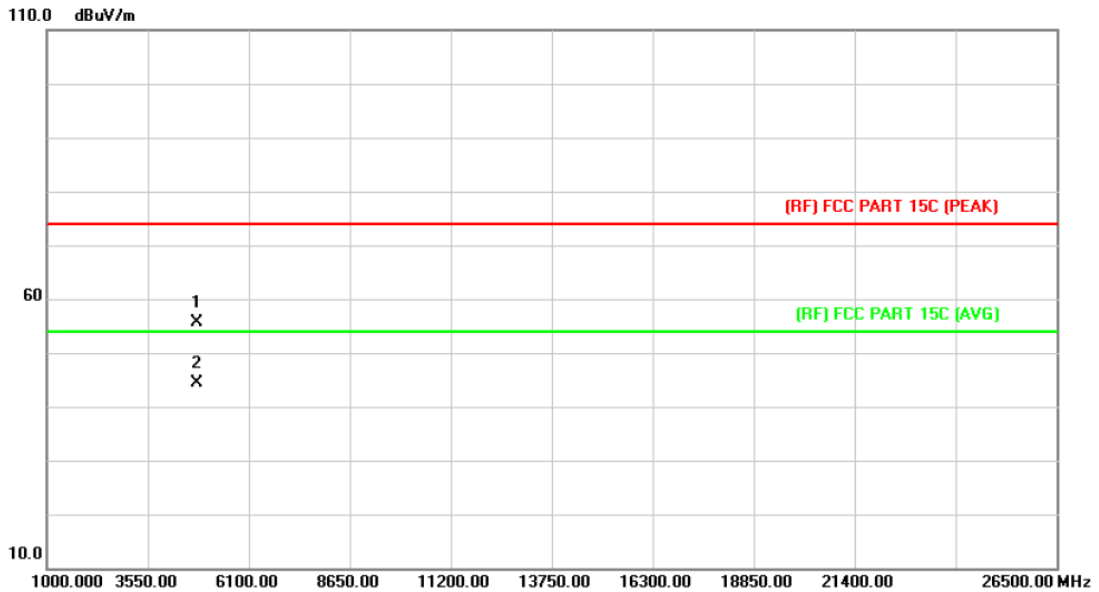

No.	Mk.	Freq. MHz	Reading Level dBuV	Correct Factor dB/m	Measure- ment dBuV/m	Limit dBuV/m	Over dB	Detector
1		4803.000	39.83	15.86	55.69	74.00	-18.31	peak
2	*	4801.142	28.50	15.85	44.35	54.00	-9.65	AVG

Emission Level= Read Level+ Correct Factor

<b>Temperature:</b>	25°C	<b>Relative Humidity:</b>	55%
<b>Test Voltage:</b>	DC 3.6V		
<b>Ant. Pol.</b>	Horizontal		
<b>Test Mode:</b>	BLE Mode TX 2442 MHz(Module 1)		
<b>Remark:</b>	No report for the emission which more than 10 dB below the prescribed limit.		

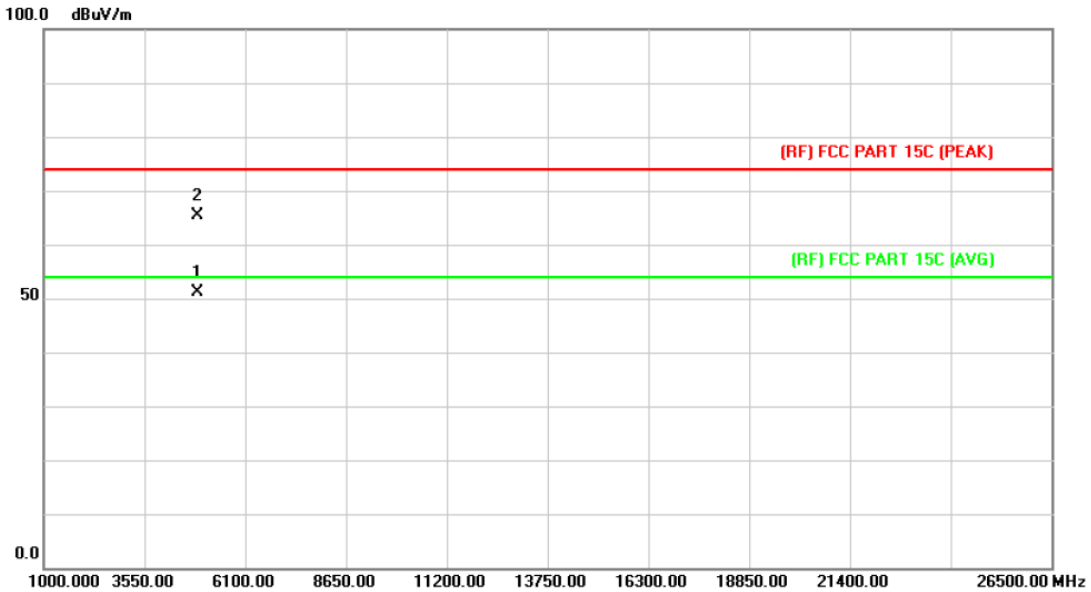

No.	Mk.	Freq.	Reading Level	Correct Factor	Measurement	Limit	Over	Detector
		MHz	dBuV	dB/m	dBuV/m	dBuV/m	dB	
1	*	4885.000	34.60	16.55	51.15	54.00	-2.85	AVG
2		4883.062	48.91	16.54	65.45	74.00	-8.55	peak

Emission Level= Read Level+ Correct Factor

<b>Temperature:</b>	25°C	<b>Relative Humidity:</b>	55%
<b>Test Voltage:</b>	DC 3.6V		
<b>Ant. Pol.</b>	Vertical		
<b>Test Mode:</b>	BLE Mode TX 2442 MHz(Module 1)		
<b>Remark:</b>	No report for the emission which more than 10 dB below the prescribed limit.		

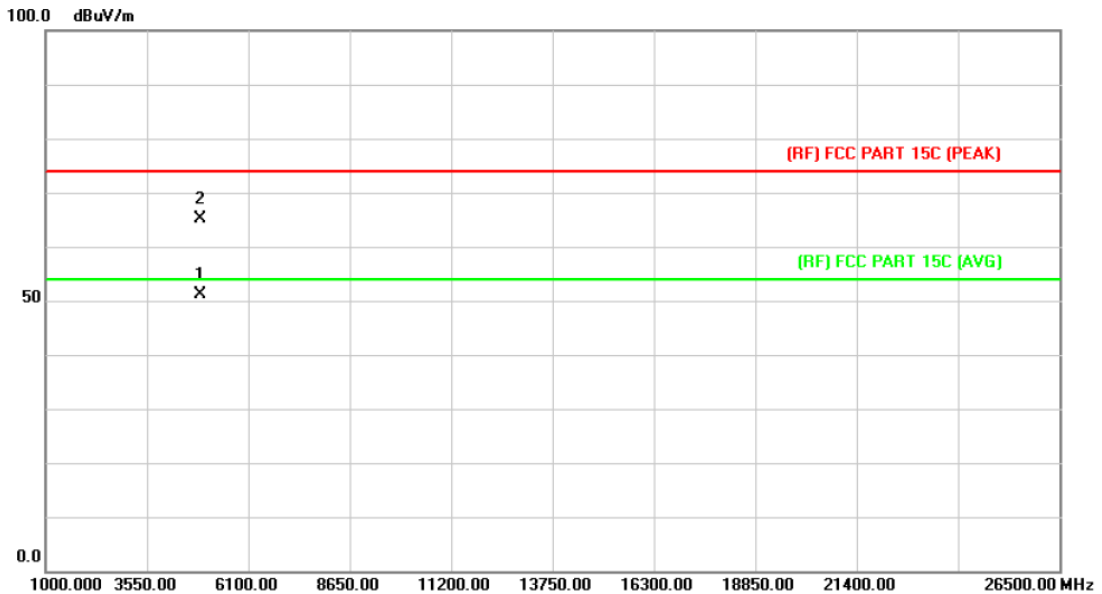

No.	Mk.	Freq.	Reading Level	Correct Factor	Measurement	Limit	Over	Detector
		MHz	dBuV	dB/m	dBuV/m	dBuV/m	dB	
1	*	4884.656	34.61	16.55	51.16	54.00	-2.84	AVG
2		4884.036	48.62	16.54	65.16	74.00	-8.84	peak

Emission Level= Read Level+ Correct Factor

<b>Temperature:</b>	25°C	<b>Relative Humidity:</b>	55%
<b>Test Voltage:</b>	DC 3.6V		
<b>Ant. Pol.</b>	Horizontal		
<b>Test Mode:</b>	BLE Mode TX 2480 MHz(Module 1)		
<b>Remark:</b>	No report for the emission which more than 10 dB below the prescribed limit.		

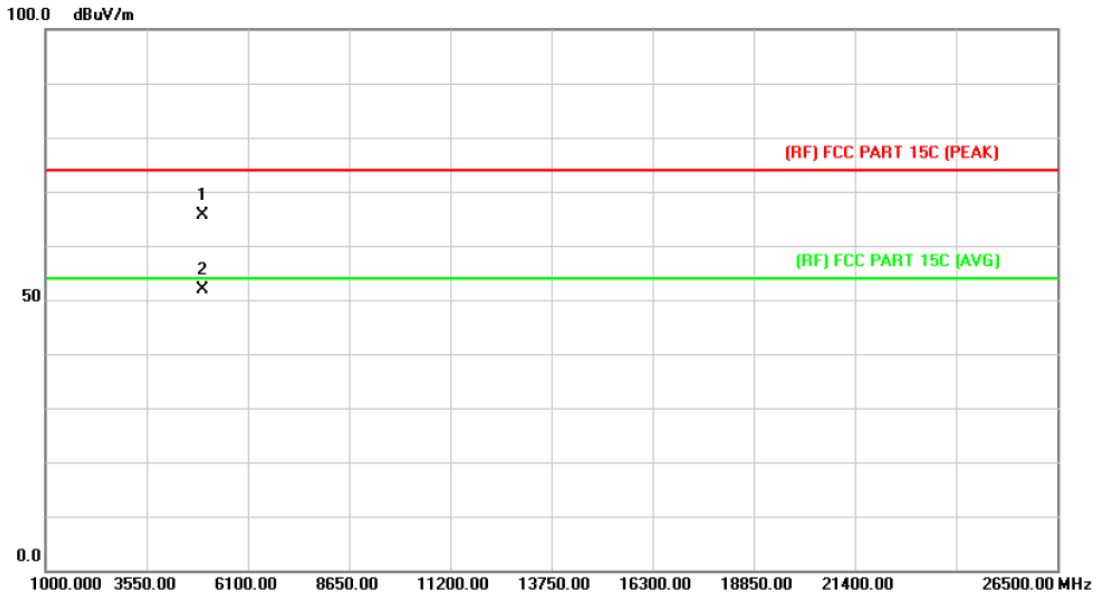

No.	Mk.	Freq. MHz	Reading Level dBuV	Correct Factor dB/m	Measure- ment dBuV/m	Limit dBuV/m	Over dB	Detector
1		4959.738	48.51	17.19	65.70	74.00	-8.30	peak
2	*	4960.738	34.58	17.19	51.77	54.00	-2.23	AVG

Emission Level= Read Level+ Correct Factor

<b>Temperature:</b>	25°C	<b>Relative Humidity:</b>	55%
<b>Test Voltage:</b>	DC 3.6V		
<b>Ant. Pol.</b>	Vertical		
<b>Test Mode:</b>	BLE Mode TX 2480 MHz(Module 1)		
<b>Remark:</b>	No report for the emission which more than 10 dB below the prescribed limit.		

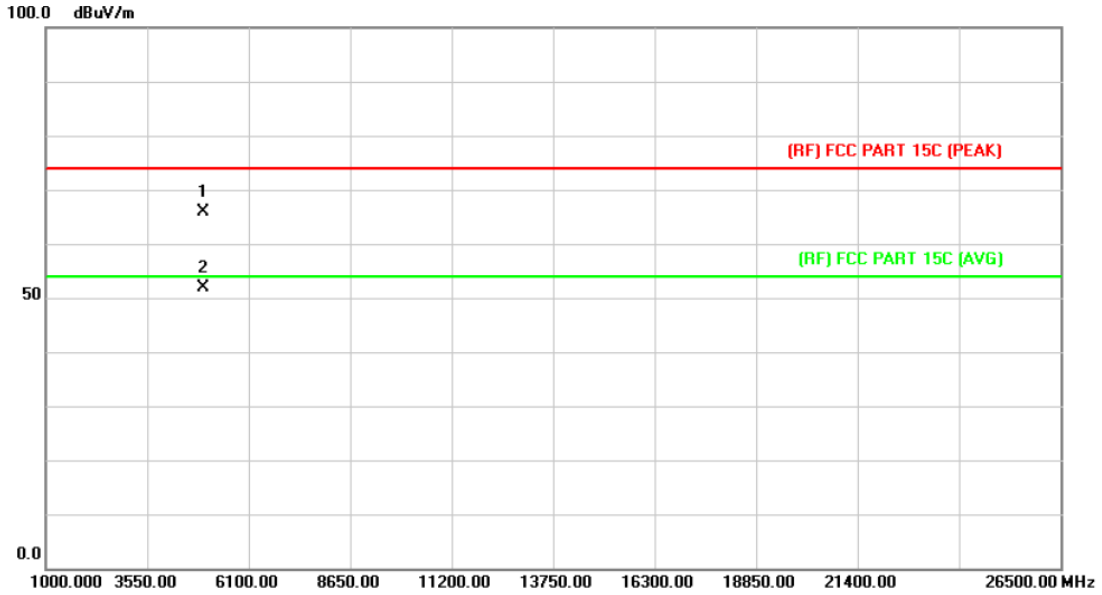

No.	Mk.	Freq. MHz	Reading Level dBuV	Correct Factor dB/m	Measure- ment dBuV/m	Limit dBuV/m	Over dB	Detector
1		4959.366	48.76	17.19	65.95	74.00	-8.05	peak
2	*	4959.284	34.60	17.19	51.79	54.00	-2.21	AVG

Emission Level= Read Level+ Correct Factor

<b>Temperature:</b>	25°C	<b>Relative Humidity:</b>	55%
<b>Test Voltage:</b>	DC 3.6V		
<b>Ant. Pol.</b>	Horizontal		
<b>Test Mode:</b>	BLE Mode TX 2402 MHz(Module 2)		
<b>Remark:</b>	No report for the emission which more than 10 dB below the prescribed limit.		

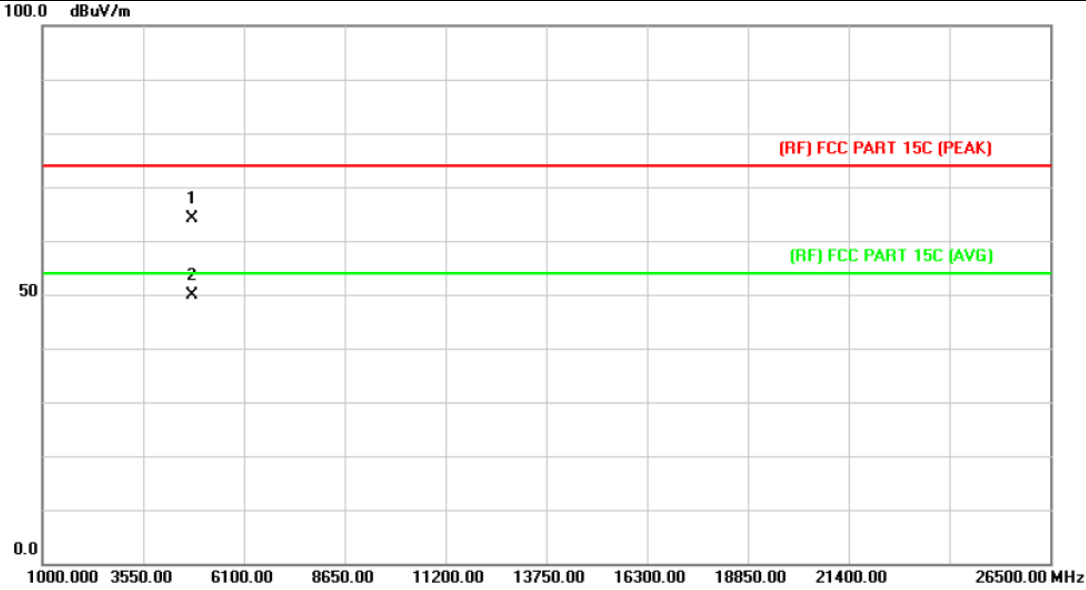

No.	Mk.	Freq. MHz	Reading Level dBuV	Correct Factor dB/m	Measure- ment dBuV/m	Limit dBuV/m	Over dB	Detector
1	*	4803.336	48.36	15.86	64.22	74.00	-9.78	peak
2		4804.172	34.00	15.87	49.87	54.00	-4.13	AVG

Emission Level= Read Level+ Correct Factor



<b>Temperature:</b>	25°C	<b>Relative Humidity:</b>	55%
<b>Test Voltage:</b>	DC 3.6V		
<b>Ant. Pol.</b>	Vertical		
<b>Test Mode:</b>	BLE Mode TX 2402 MHz(Module 2)		
<b>Remark:</b>	No report for the emission which more than 10 dB below the prescribed limit.		

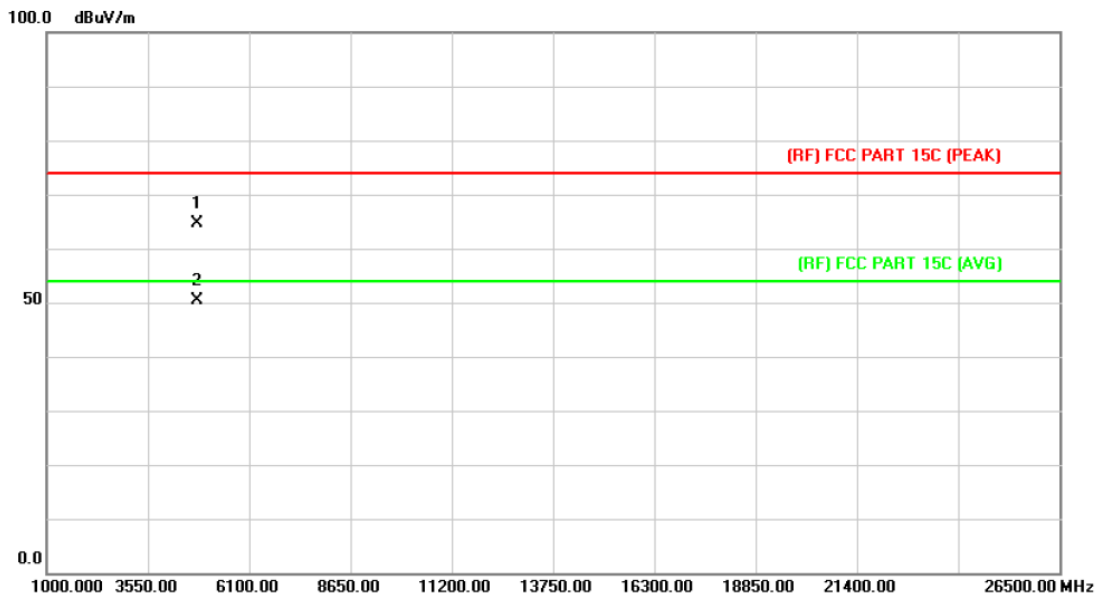

No.	Mk.	Freq. MHz	Reading Level dBuV	Correct Factor dB/m	Measure- ment dBuV/m	Limit dBuV/m	Over dB	Detector
1		4804.082	48.87	15.87	64.74	74.00	-9.26	peak
2	*	4804.132	34.41	15.87	50.28	54.00	-3.72	AVG

Emission Level= Read Level+ Correct Factor

<b>Temperature:</b>	25°C	<b>Relative Humidity:</b>	55%
<b>Test Voltage:</b>	DC 3.6V		
<b>Ant. Pol.</b>	Horizontal		
<b>Test Mode:</b>	BLE Mode TX 2442 MHz(Module 2)		
<b>Remark:</b>	No report for the emission which more than 10 dB below the prescribed limit.		

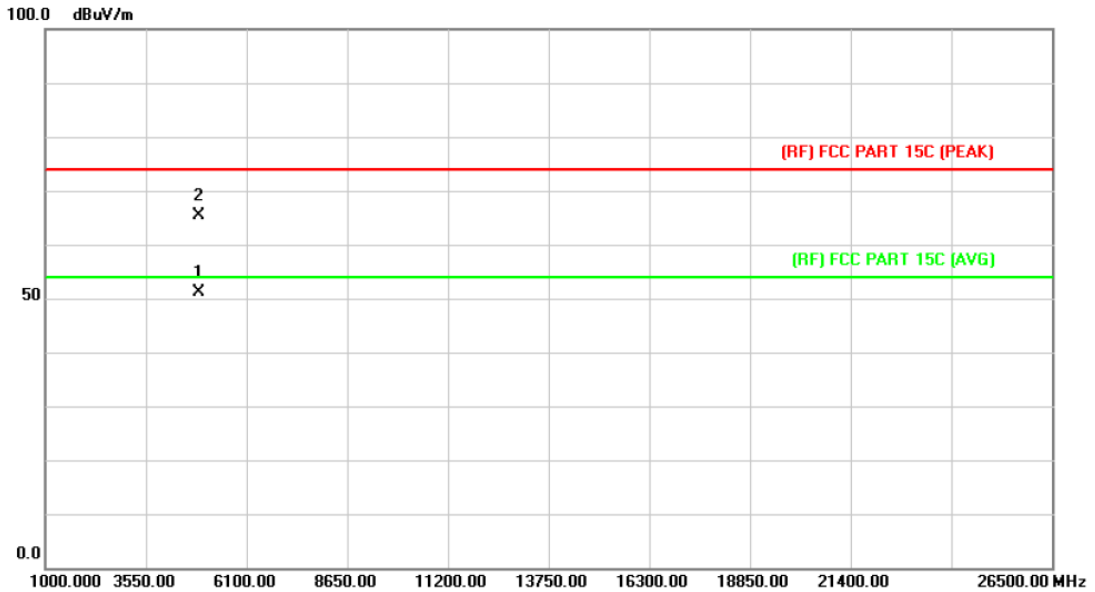

No.	Mk.	Freq. MHz	Reading Level dBuV	Correct Factor dB/m	Measure- ment dBuV/m	Limit dBuV/m	Over dB	Detector
1	*	4884.516	34.59	16.55	51.14	54.00	-2.86	AVG
2		4884.264	48.79	16.55	65.34	74.00	-8.66	peak

Emission Level= Read Level+ Correct Factor

<b>Temperature:</b>	25°C	<b>Relative Humidity:</b>	55%
<b>Test Voltage:</b>	DC 3.6V		
<b>Ant. Pol.</b>	Vertical		
<b>Test Mode:</b>	BLE Mode TX 2442 MHz(Module 2)		
<b>Remark:</b>	No report for the emission which more than 10 dB below the prescribed limit.		

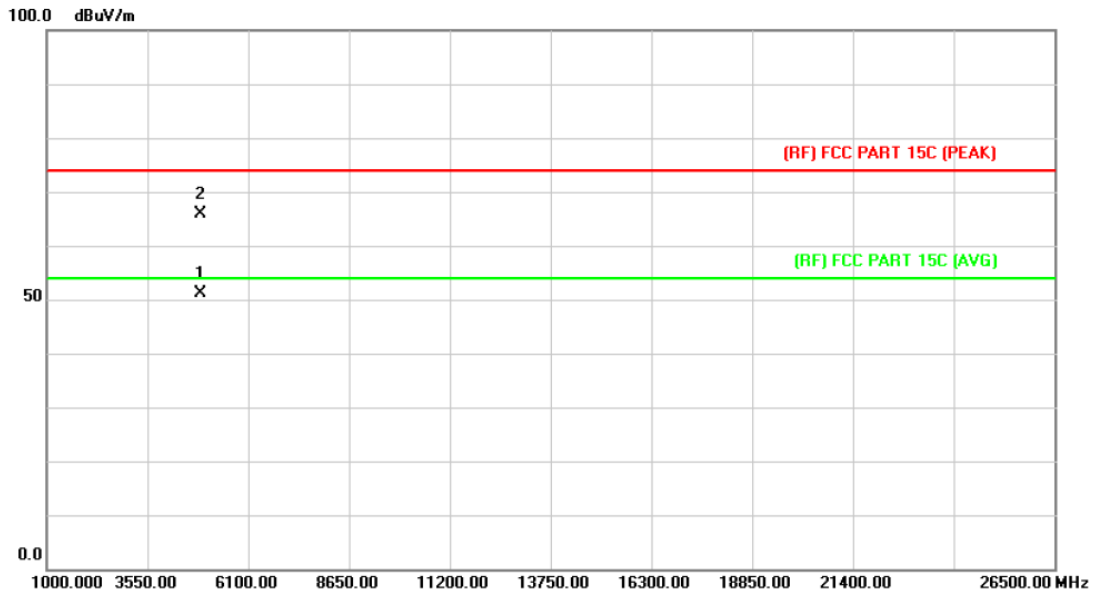

No.	Mk.	Freq. MHz	Reading Level dBuV	Correct Factor dB/m	Measure- ment dBuV/m	Limit dBuV/m	Over dB	Detector
1		4884.940	34.55	16.55	51.10	74.00	-2.90	AVG
2	*	4883.500	49.31	16.54	65.85	74.00	-8.15	peak

Emission Level= Read Level+ Correct Factor

<b>Temperature:</b>	25°C	<b>Relative Humidity:</b>	55%
<b>Test Voltage:</b>	DC 3.6V		
<b>Ant. Pol.</b>	Horizontal		
<b>Test Mode:</b>	BLE Mode TX 2480 MHz(Module 2)		
<b>Remark:</b>	No report for the emission which more than 10 dB below the prescribed limit.		

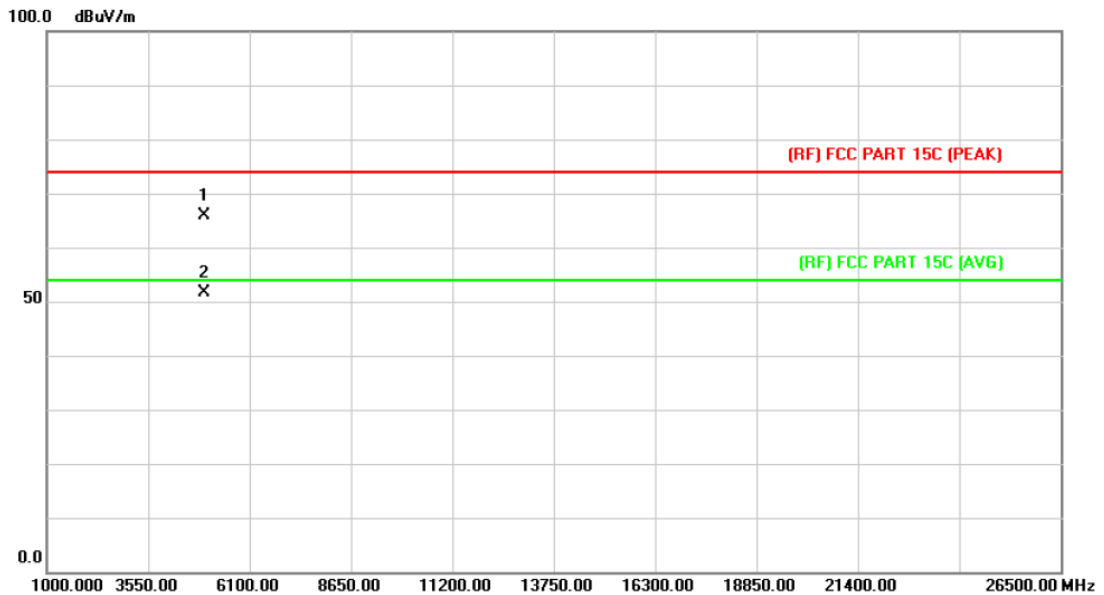

No.	Mk.	Freq. MHz	Reading Level dBuV	Correct Factor dB/m	Measure- ment dBuV/m	Limit dBuV/m	Over dB	Detector
1		4960.950	48.76	17.19	65.95	74.00	-8.05	peak
2	*	4960.980	34.54	17.19	51.73	54.00	-2.27	AVG

Emission Level= Read Level+ Correct Factor

<b>Temperature:</b>	25°C	<b>Relative Humidity:</b>	55%
<b>Test Voltage:</b>	DC 3.6V		
<b>Ant. Pol.</b>	Vertical		
<b>Test Mode:</b>	BLE Mode TX 2480 MHz(Module 2)		
<b>Remark:</b>	No report for the emission which more than 10 dB below the prescribed limit.		

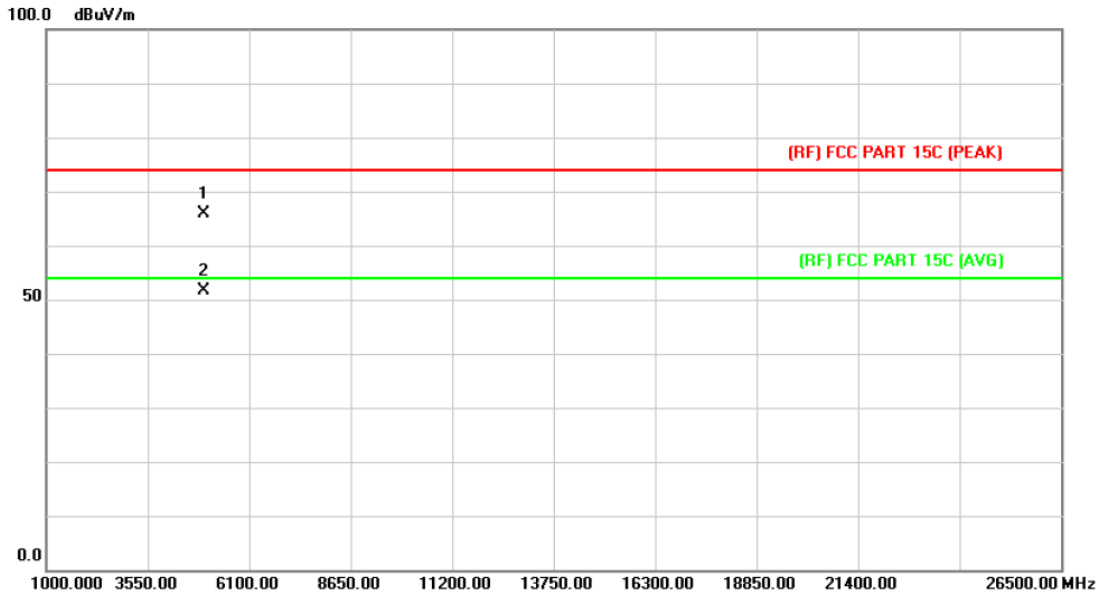

No.	Mk.	Freq. MHz	Reading Level dBuV	Correct Factor dB/m	Measure- ment dBuV/m	Limit dBuV/m	Over dB	Detector
1		4959.192	48.70	17.19	65.89	74.00	-8.11	peak
2	*	4960.496	34.54	17.19	51.73	54.00	-2.27	AVG

Emission Level= Read Level+ Correct Factor

## Attachment B-- Restricted Bands Requirement Test Data

### (1) Radiation Test

Temperature:	25°C	Relative Humidity:	55%
Test Voltage:	DC 3.6V		
Ant. Pol.	Horizontal		
Test Mode:	BLE Mode TX 2402 MHz(Module 1)		
Remark:	N/A		

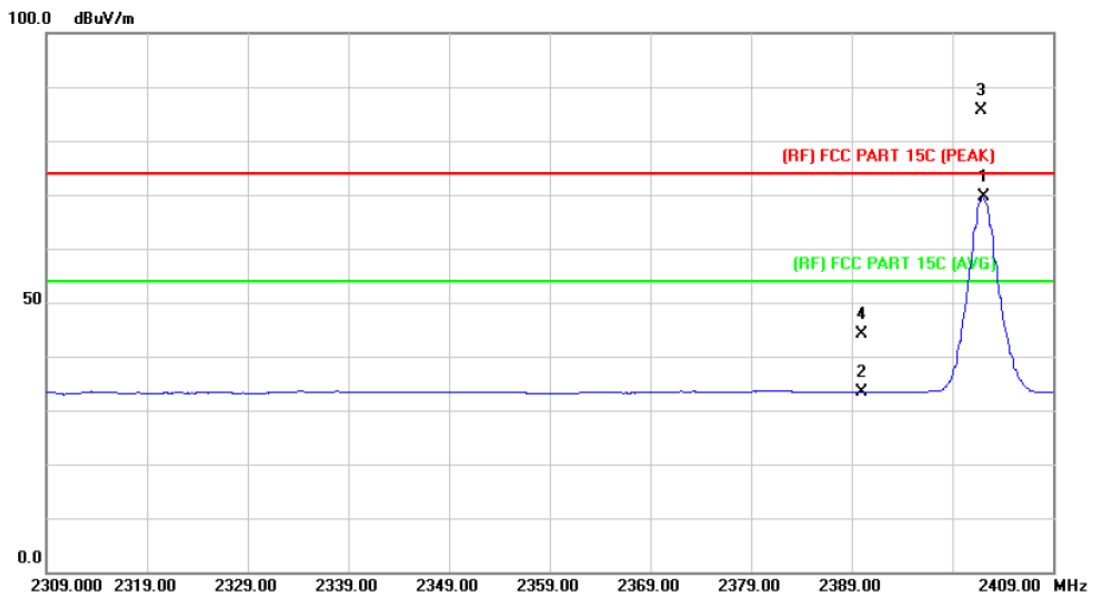

No.	Mk.	Freq. MHz	Reading Level dBuV	Correct Factor dB/m	Measure- ment dBuV/m	Limit dBuV/m	Over dB	Detector
1	*	2402.100	68.54	0.98	69.52	Fundamental Frequency		AVG
2		2390.000	32.52	0.91	33.43	54.00	-20.57	AVG
3	X	2401.800	84.58	0.98	85.56	Fundamental Frequency		peak
4		2390.000	43.11	0.91	44.02	74.00	-29.98	peak

Emission Level= Read Level+ Correct Factor

<b>Temperature:</b>	25°C	<b>Relative Humidity:</b>	55%
<b>Test Voltage:</b>	DC 3.6V		
<b>Ant. Pol.</b>	Vertical		
<b>Test Mode:</b>	BLE Mode TX 2402 MHz(Module 1)		
<b>Remark:</b>	N/A		

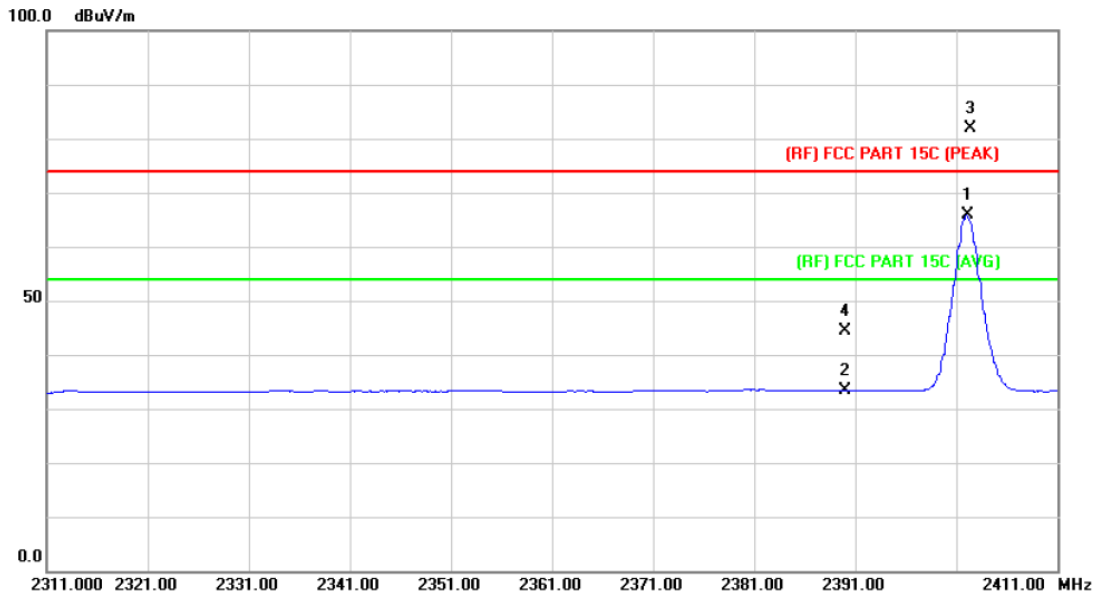

No.	Mk.	Freq. MHz	Reading Level dBuV	Correct Factor dB/m	Measure- ment dBuV/m	Limit dBuV/m	Over dB	Detector
1	*	2402.100	64.79	0.98	65.77	Fundamental Frequency		AVG
2		2390.000	32.49	0.91	33.40	54.00	-20.60	AVG
3	X	2402.400	80.81	0.98	81.79	Fundamental Frequency		peak
4		2390.000	43.55	0.91	44.46	74.00	-29.54	peak

Emission Level= Read Level+ Correct Factor

<b>Temperature:</b>	25°C	<b>Relative Humidity:</b>	55%
<b>Test Voltage:</b>	DC 3.6V		
<b>Ant. Pol.</b>	Horizontal		
<b>Test Mode:</b>	BLE Mode TX 2480 MHz(Module 1)		
<b>Remark:</b>	N/A		

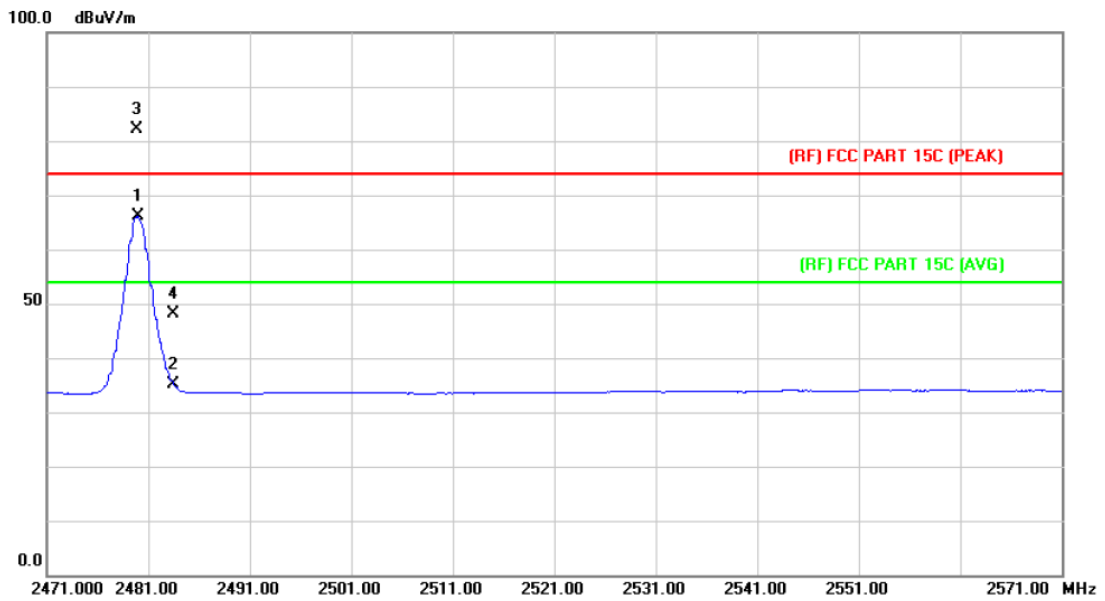

No.	Mk.	Freq. MHz	Reading Level dBuV	Correct Factor dB/m	Measure- ment dBuV/m	Limit dBuV/m	Over dB	Detector
1	*	2480.000	64.81	1.32	66.13	Fundamental Frequency		AVG
2		2483.500	33.90	1.34	35.24	54.00	-18.76	AVG
3	X	2479.800	80.80	1.32	82.12	Fundamental Frequency		peak
4		2483.500	46.73	1.34	48.07	74.00	-25.93	peak

Emission Level= Read Level+ Correct Factor



<b>Temperature:</b>	25°C	<b>Relative Humidity:</b>	55%
<b>Test Voltage:</b>	DC 3.6V		
<b>Ant. Pol.</b>	Vertical		
<b>Test Mode:</b>	BLE Mode TX 2480 MHz(Module 1)		
<b>Remark:</b>	N/A		

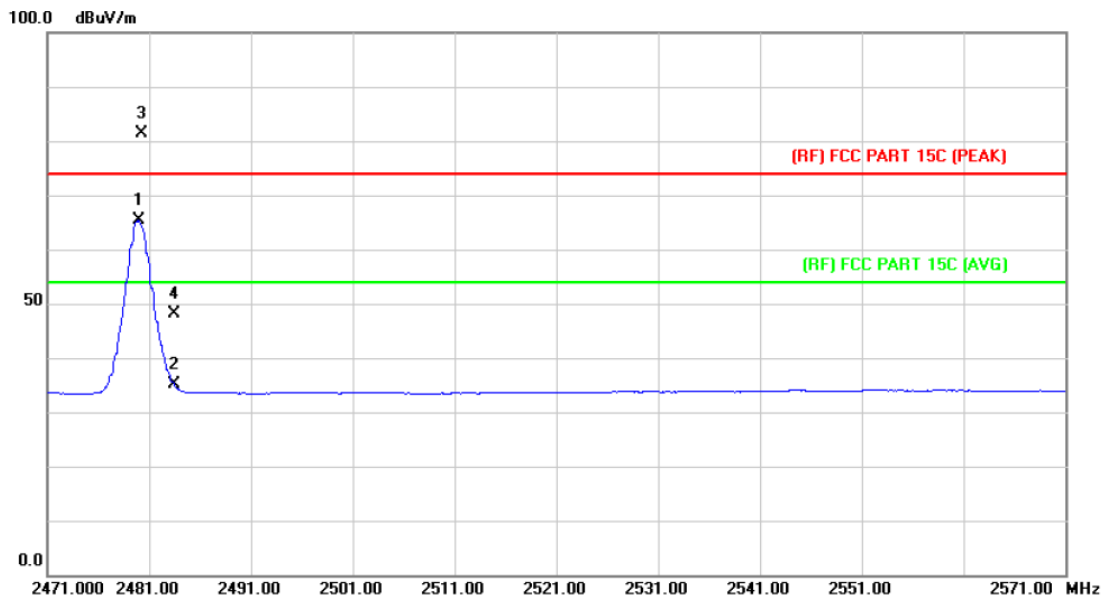

No.	Mk.	Freq. MHz	Reading Level dBuV	Correct Factor dB/m	Measure- ment dBuV/m	Limit dBuV/m	Over dB	Detector
1	*	2480.000	64.14	1.32	65.46	Fundamental Frequency		AVG
2		2483.500	33.70	1.34	35.04	54.00	-18.96	AVG
3	X	2480.300	80.13	1.32	81.45	Fundamental Frequency		peak
4		2483.500	46.78	1.34	48.12	74.00	-25.88	peak

Emission Level= Read Level+ Correct Factor

Temperature:	25°C	Relative Humidity:	55%
Test Voltage:	DC 3.6V		
Ant. Pol.	Horizontal		
Test Mode:	BLE Mode TX 2402 MHz(Module 2)		
Remark:	N/A		

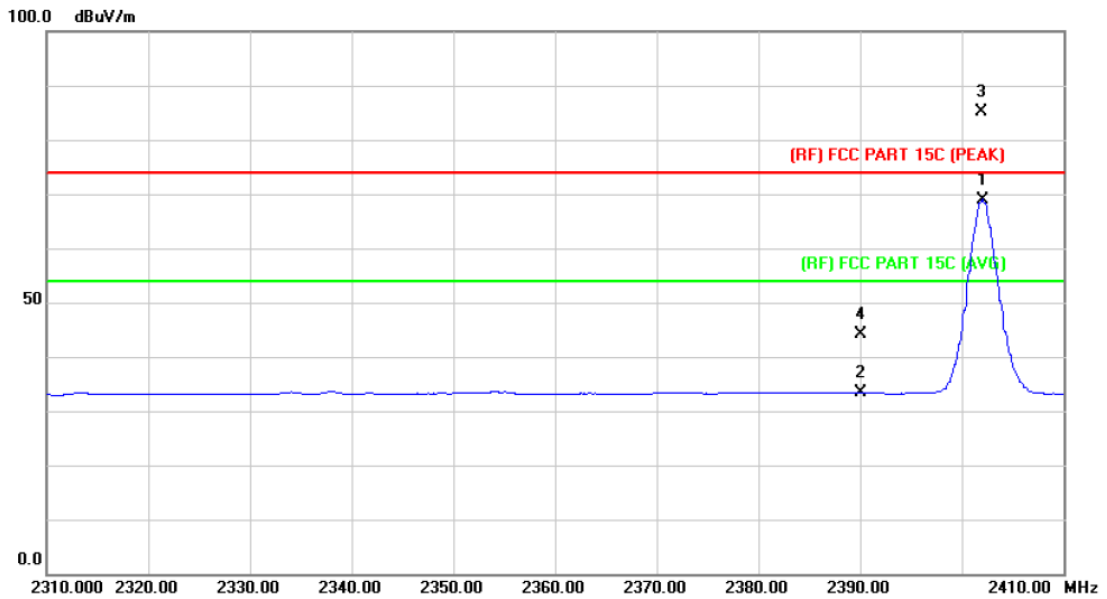

No.	Mk.	Freq. MHz	Reading Level dBuV	Correct Factor dB/m	Measure- ment dBuV/m	Limit dBuV/m	Over dB	Detector
1	*	2402.100	68.02	0.98	69.00	Fundamental Frequency		AVG
2		2390.000	32.46	0.91	33.37	54.00	-20.63	AVG
3	X	2401.900	84.09	0.98	85.07	Fundamental Frequency		peak
4		2390.000	43.18	0.91	44.09	74.00	-29.91	peak

Emission Level= Read Level+ Correct Factor

Temperature:	25°C	Relative Humidity:	55%
Test Voltage:	DC 3.6V		
Ant. Pol.	Vertical		
Test Mode:	BLE Mode TX 2402 MHz(Module 2)		
Remark:	N/A		

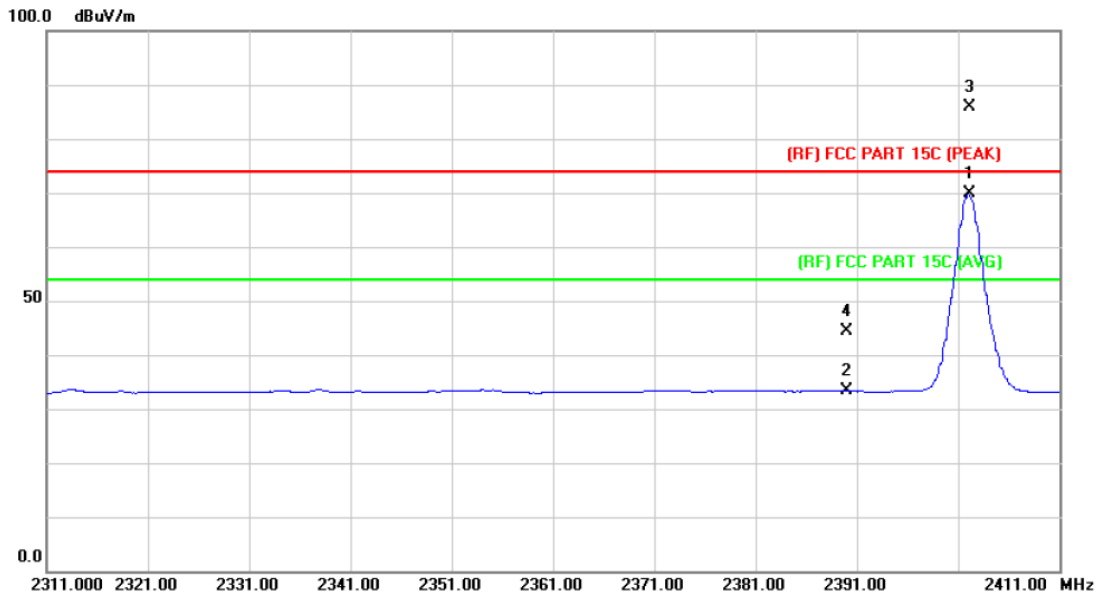

No.	Mk.	Freq. MHz	Reading Level dBuV	Correct Factor dB/m	Measure- ment dBuV/m	Limit dBuV/m	Over dB	Detector
1	*	2402.100	68.86	0.98	69.84	Fundamental Frequency		AVG
2		2390.000	32.45	0.91	33.36	54.00	-20.64	AVG
3	X	2402.100	84.94	0.98	85.92	Fundamental Frequency		peak
4		2390.000	43.47	0.91	44.38	74.00	-29.62	peak

Emission Level= Read Level+ Correct Factor

<b>Temperature:</b>	25°C	<b>Relative Humidity:</b>	55%
<b>Test Voltage:</b>	DC 3.6V		
<b>Ant. Pol.</b>	Horizontal		
<b>Test Mode:</b>	BLE Mode TX 2480 MHz(Module 2)		
<b>Remark:</b>	N/A		

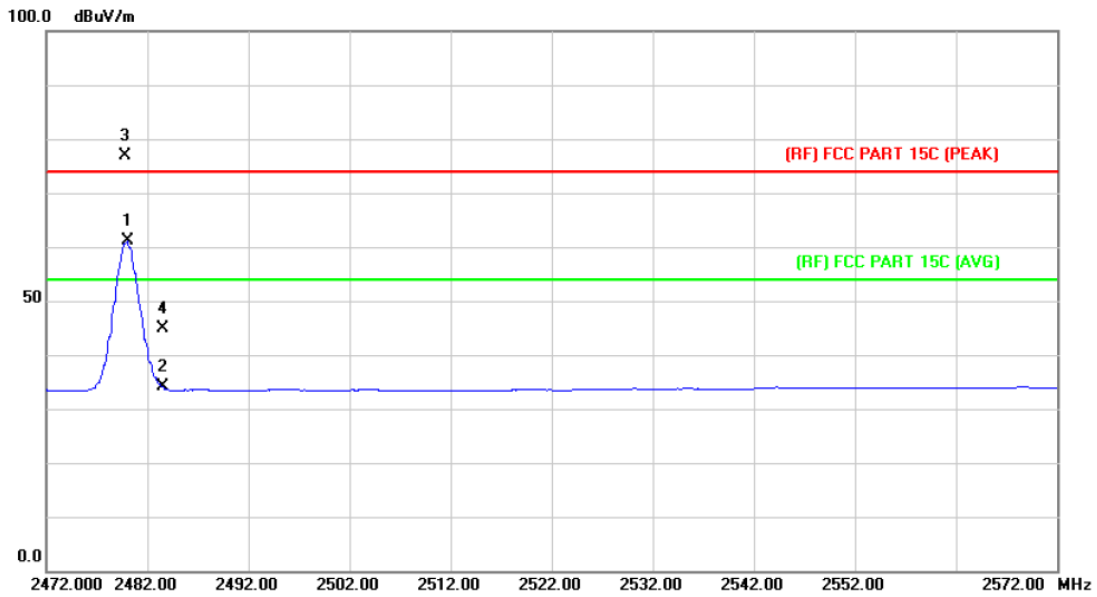

No.	Mk.	Freq. MHz	Reading Level dBuV	Correct Factor dB/m	Measure- ment dBuV/m	Limit dBuV/m	Over dB	Detector
1	*	2480.000	59.72	1.32	61.04	Fundamental Frequency		AVG
2		2483.500	32.69	1.34	34.03	54.00	-19.97	AVG
3	X	2479.800	75.67	1.32	76.99	Fundamental Frequency		peak
4		2483.500	43.56	1.34	44.90	74.00	-29.10	peak

Emission Level= Read Level+ Correct Factor

Temperature:	25°C	Relative Humidity:	55%
Test Voltage:	DC 3.6V		
Ant. Pol.	Vertical		
Test Mode:	BLE Mode TX 2480 MHz(Module 2)		
Remark:	N/A		

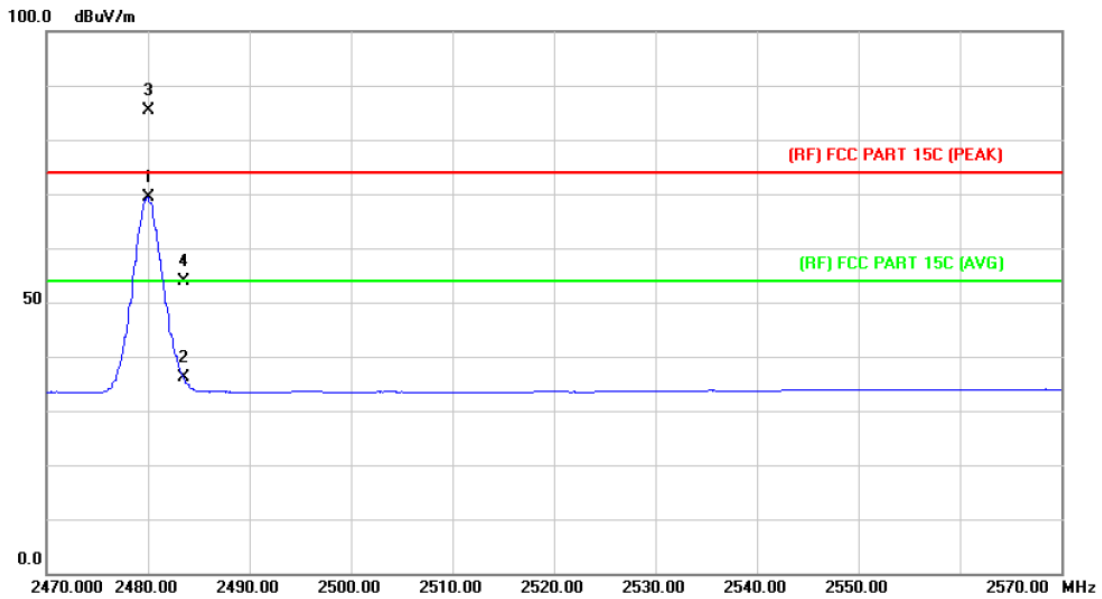

No.	Mk.	Freq. MHz	Reading Level dBuV	Correct Factor dB/m	Measure- ment dBuV/m	Limit dBuV/m	Over dB	Detector
1	*	2480.000	68.02	1.32	69.34	Fundamental Frequency		AVG
2		2483.500	34.89	1.34	36.23	54.00	-17.77	AVG
3	X	2480.000	84.08	1.32	85.40	Fundamental Frequency		peak
4		2483.500	52.59	1.34	53.93	74.00	-20.07	peak

Emission Level= Read Level+ Correct Factor

(2) Conducted Test

Temperature:	25°C	Relative Humidity:	55%
Test Voltage:	DC 3.6V		
Test Mode:	BLE Mode TX 2402MHz / BLE Mode TX 2480MHz(Module 1)		
Remark:	The EUT is programed in continuously transmitting mode		

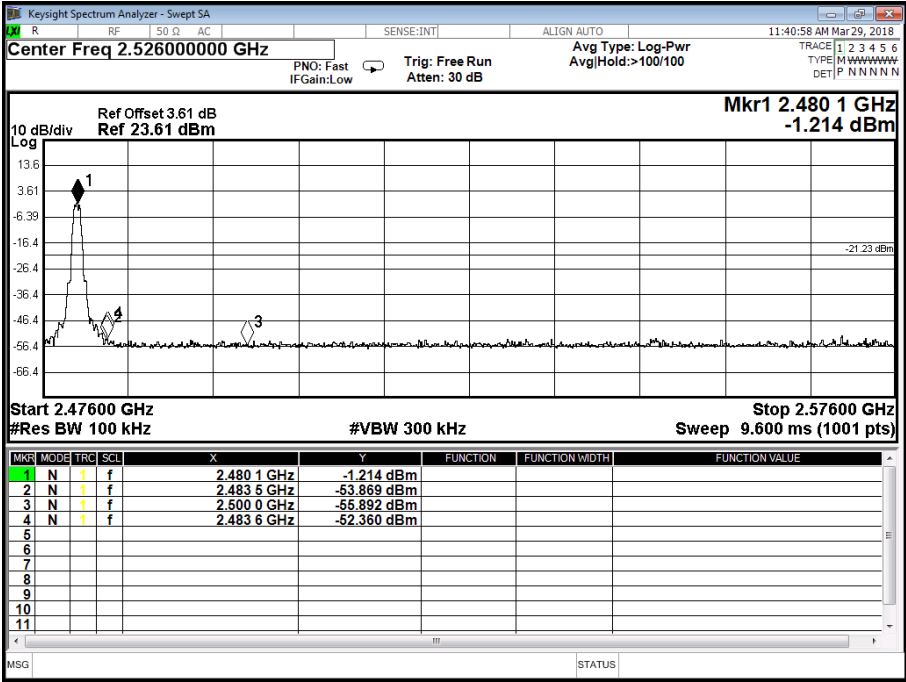
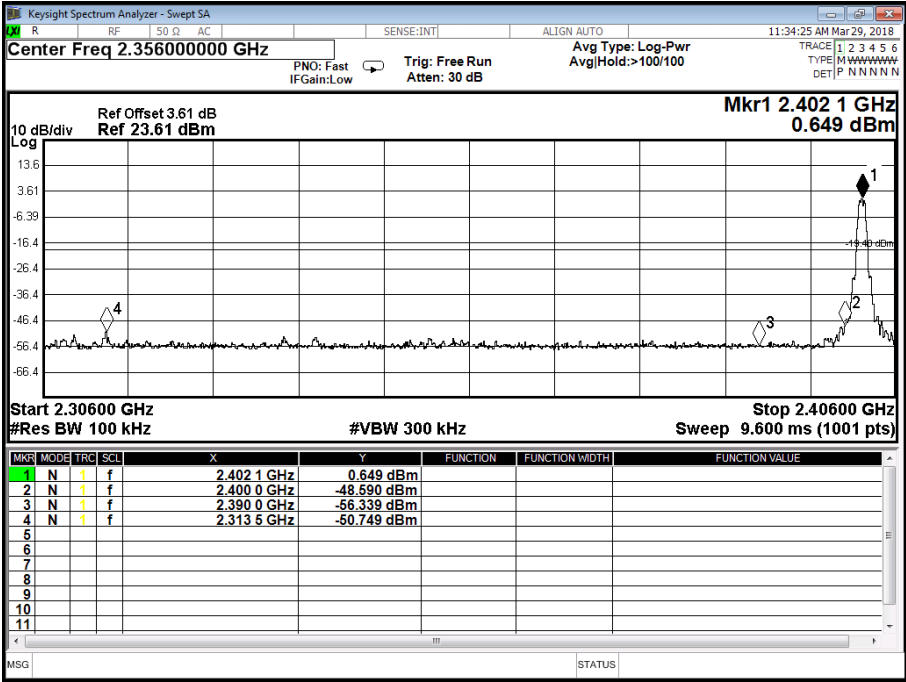

Temperature:	25°C	Relative Humidity:	55%
Test Voltage:	DC 3.6V		
Test Mode:	BLE Mode TX 2402MHz / BLE Mode TX 2480MHz(Module 2)		
Remark:	The EUT is programed in continuously transmitting mode		

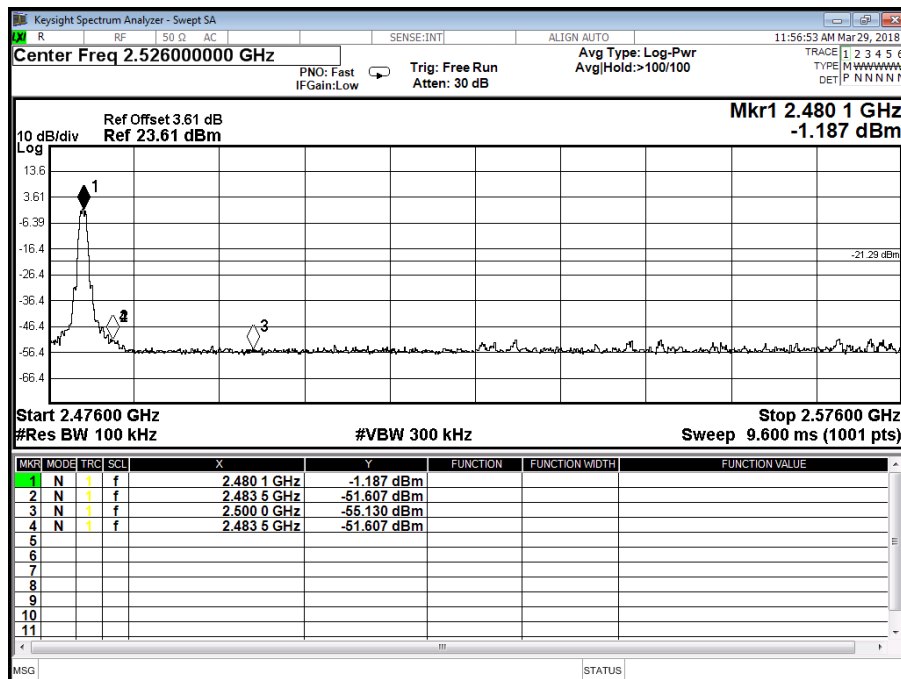
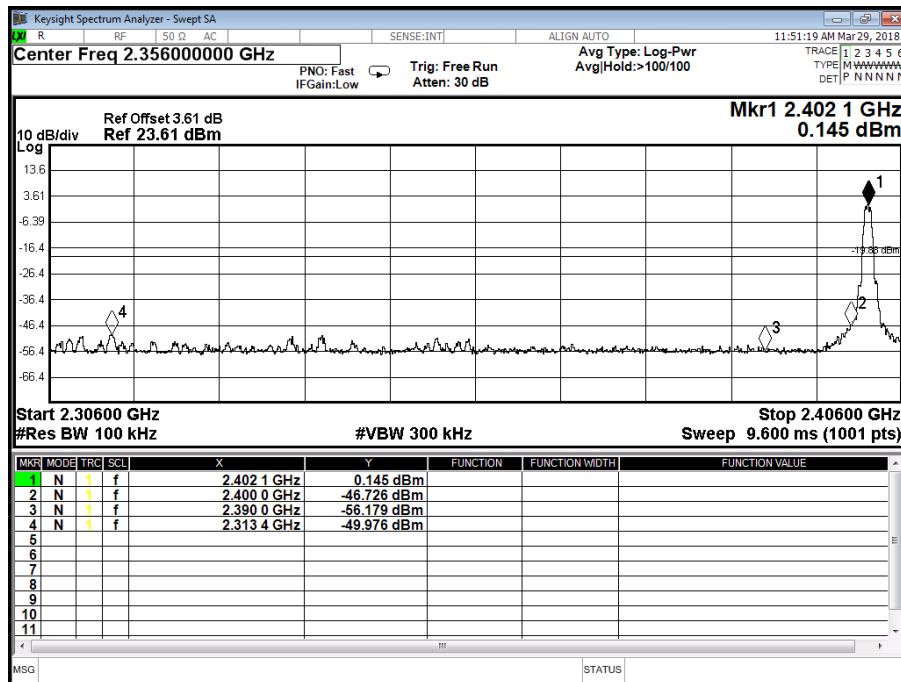

## Attachment C-- Bandwidth Test Data

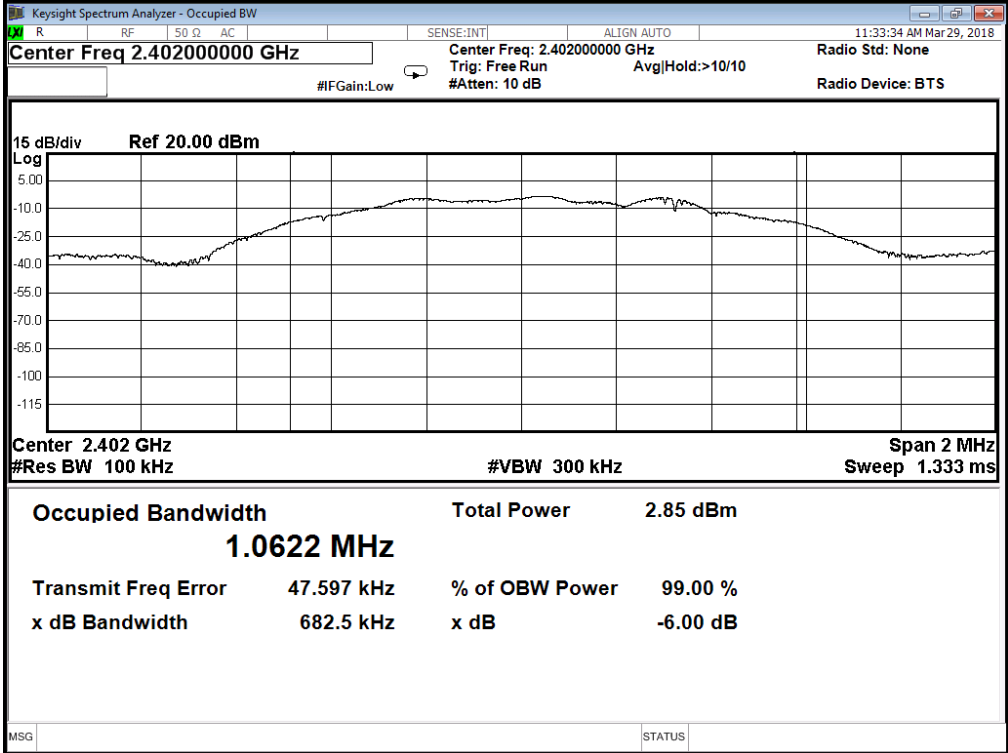
Temperature:	25°C	Relative Humidity:	55%
Test Voltage:	DC 3.6V		
Test Mode:	BLE TX Mode(Module 1)		
Channel frequency (MHz)	6dB Bandwidth (kHz)	99% Bandwidth (kHz)	Limit (kHz)
2402	682.50	1062.20	>=500
2442	684.30	1066.10	
2480	687.30	1064.50	
<b>BLE Mode</b>			
<b>2402 MHz</b>			
			



**BLE Mode**  
**2442 MHz**

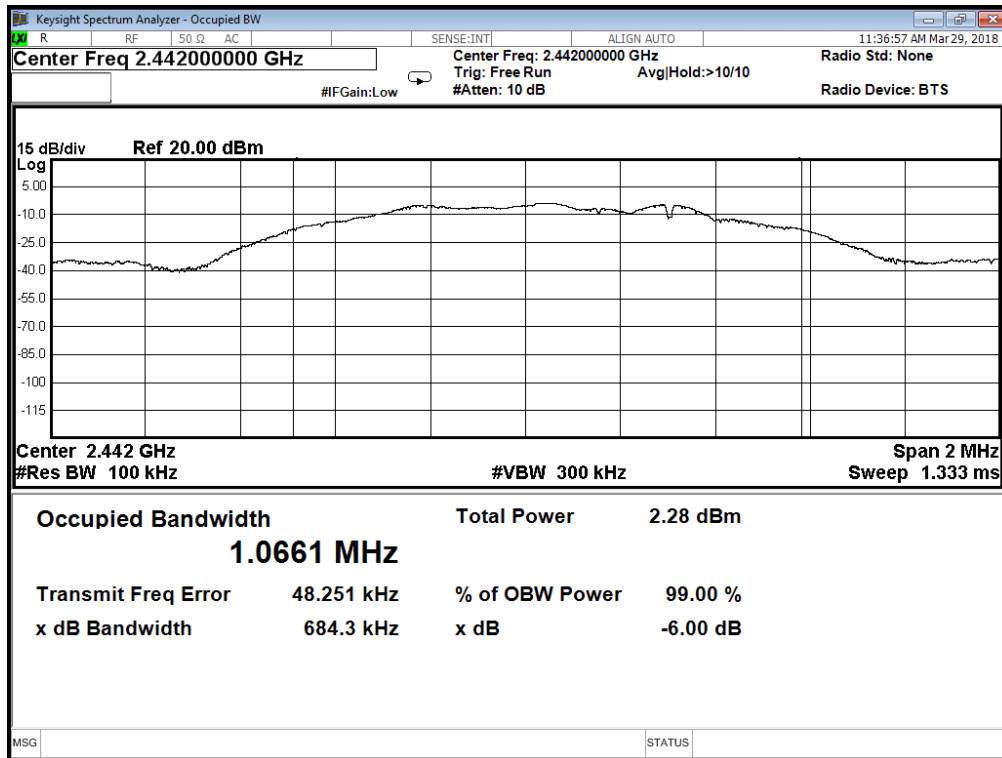

**BLE Mode**  
**2480 MHz**

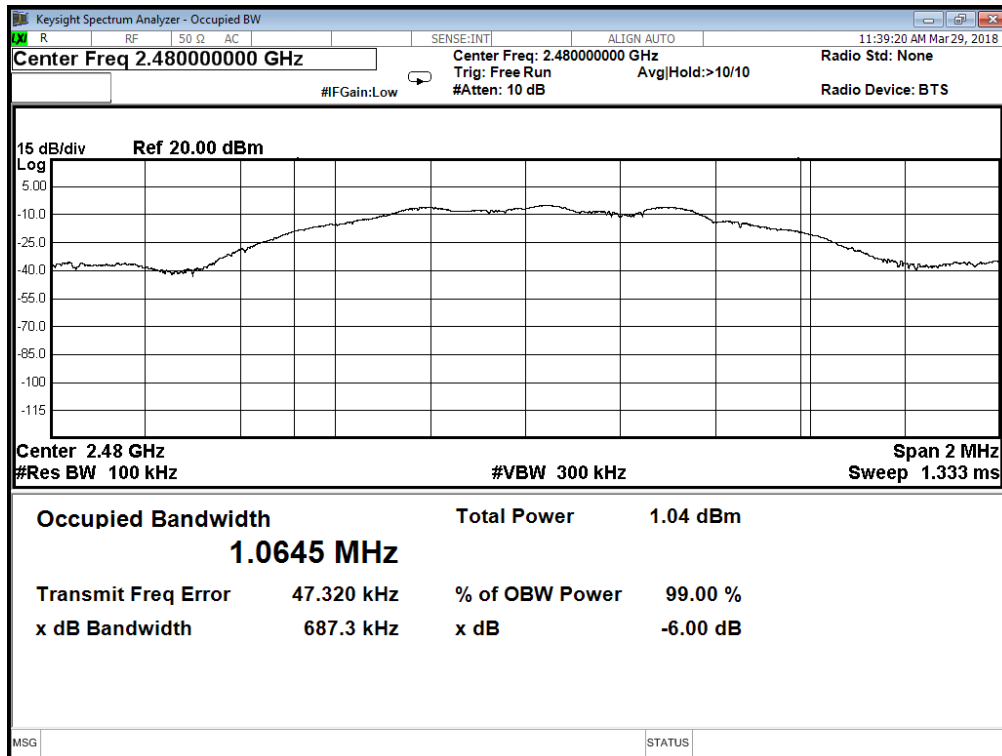

<b>Temperature:</b>	25°C	<b>Relative Humidity:</b>	55%
<b>Test Voltage:</b>	DC 3.6V		
<b>Test Mode:</b>	BLE TX Mode(Module 2)		
<b>Channel frequency (MHz)</b>	<b>6dB Bandwidth (kHz)</b>	<b>99% Bandwidth (kHz)</b>	<b>Limit (kHz)</b>
2402	682.90	1061.30	>=500
2442	685.00	1065.50	
2480	684.70	1065.20	

**BLE Mode**

**2402 MHz**

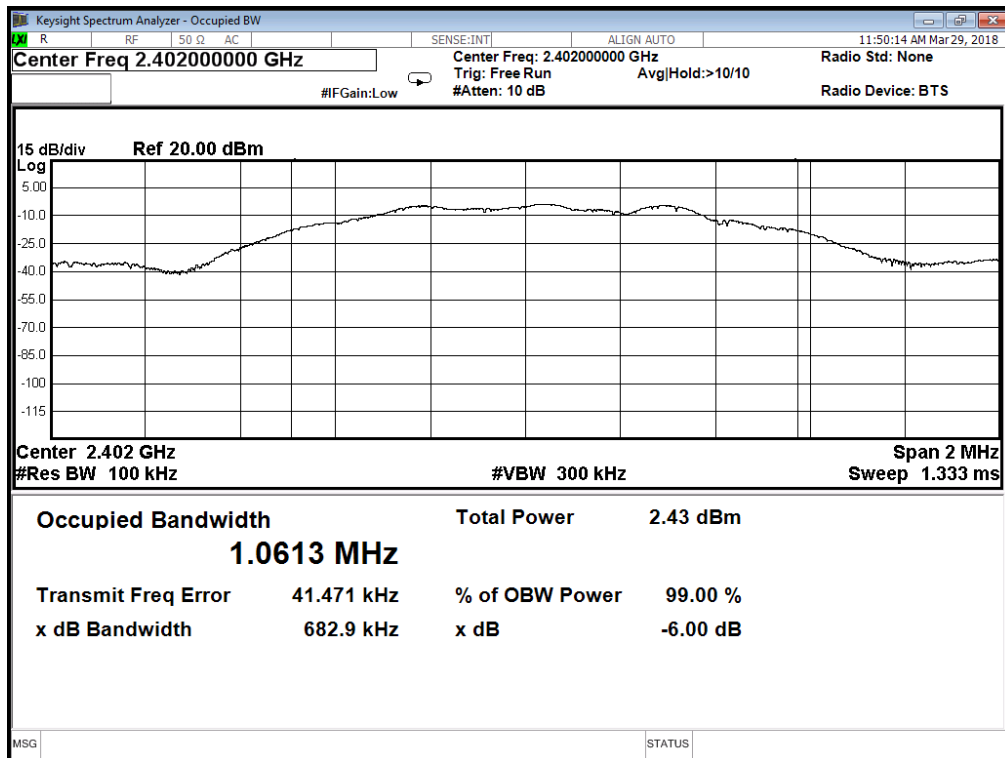

**BLE Mode**  
**2442 MHz**

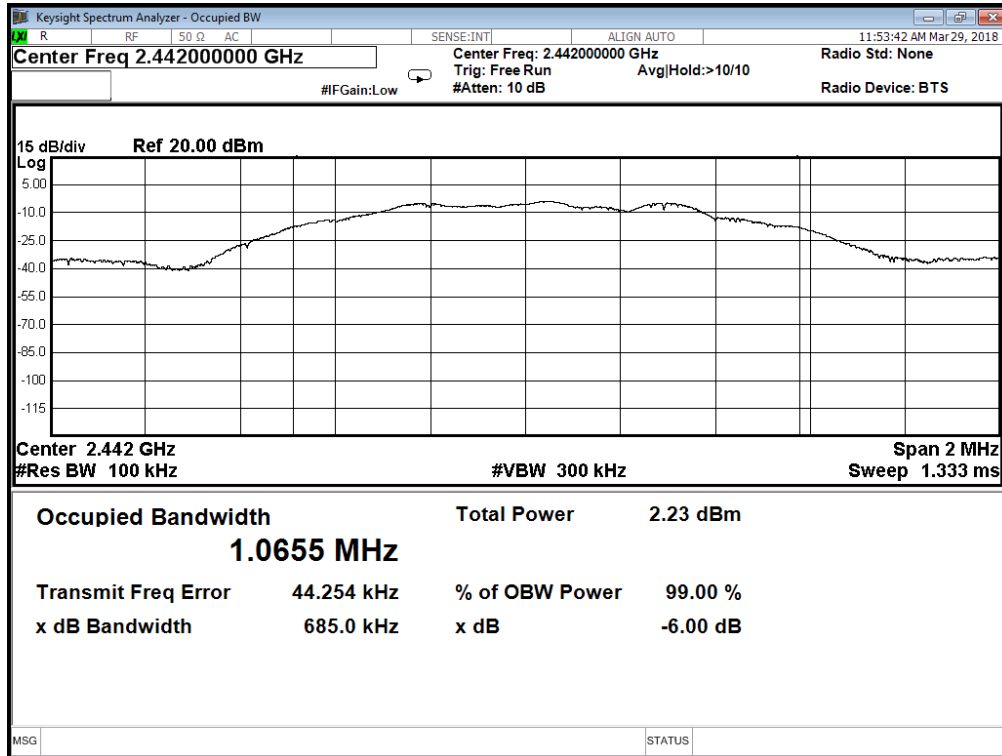

**BLE Mode**  
**2480 MHz**

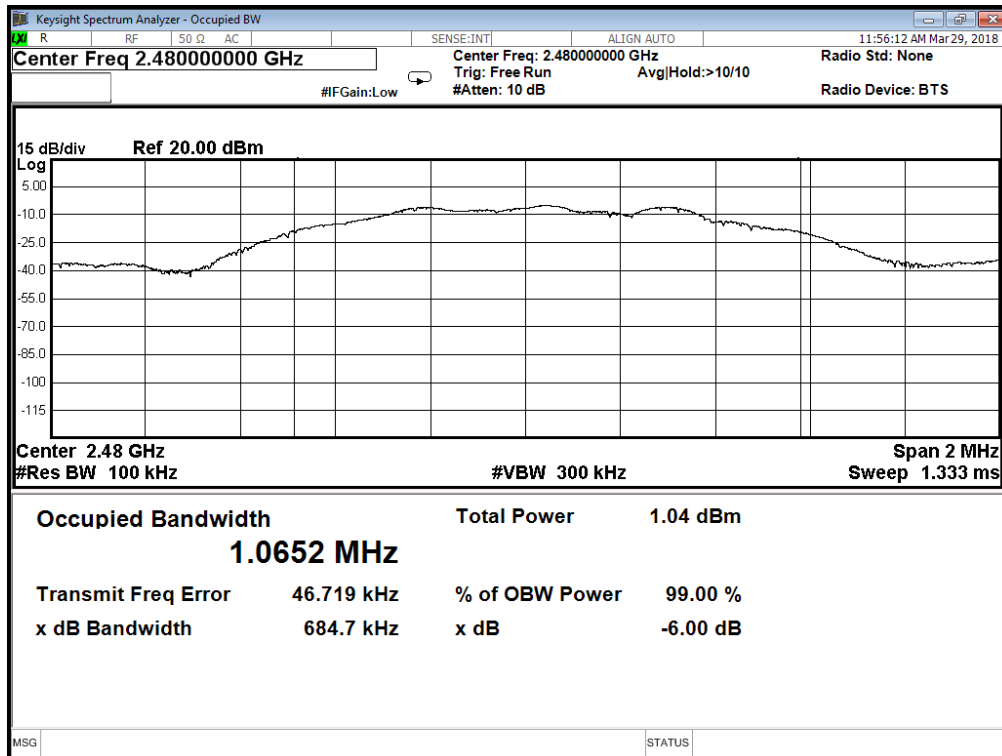

## Attachment D-- Peak Output Power Test Data

<b>Temperature:</b>	25°C	<b>Relative Humidity:</b>	55%
<b>Test Voltage:</b>	DC 3.6V		
<b>Test Mode:</b>	BLE TX Mode(Module 1)		
<b>Channel frequency (MHz)</b>	<b>Test Result (dBm)</b>	<b>Limit (dBm)</b>	
2402	0.565	<b>30</b>	
2442	0.019		
2480	-1.241		
<b>BLE Mode</b>			
<b>2402 MHz</b>			

**BLE Mode**  
**2442 MHz**

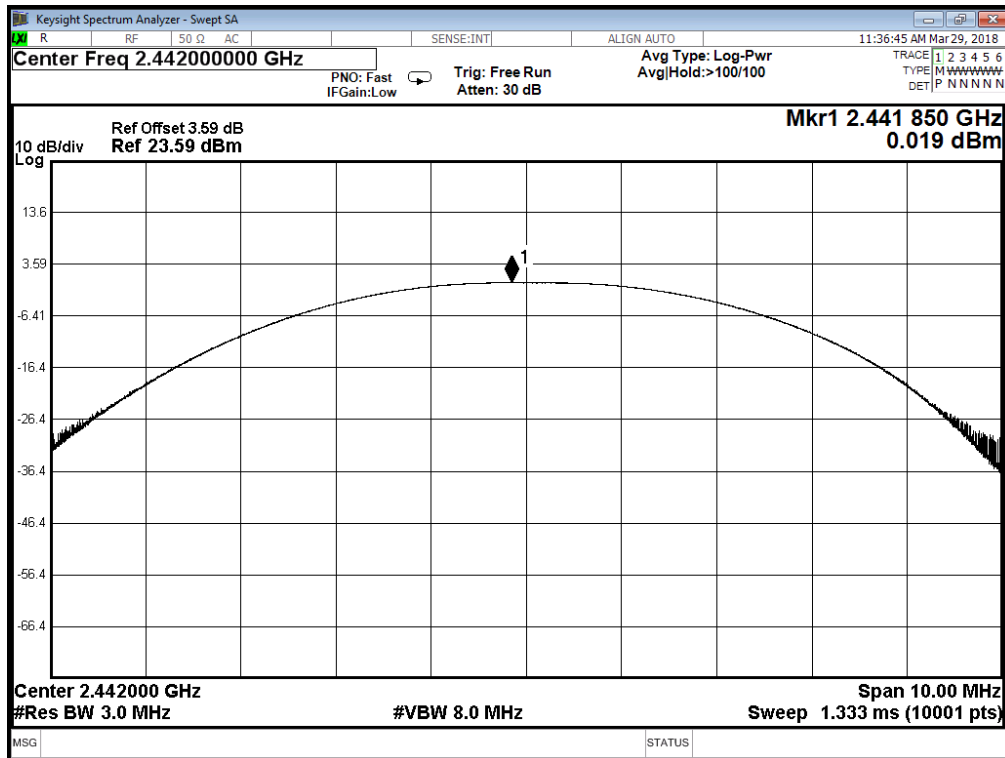

**BLE Mode**  
**2480 MHz**

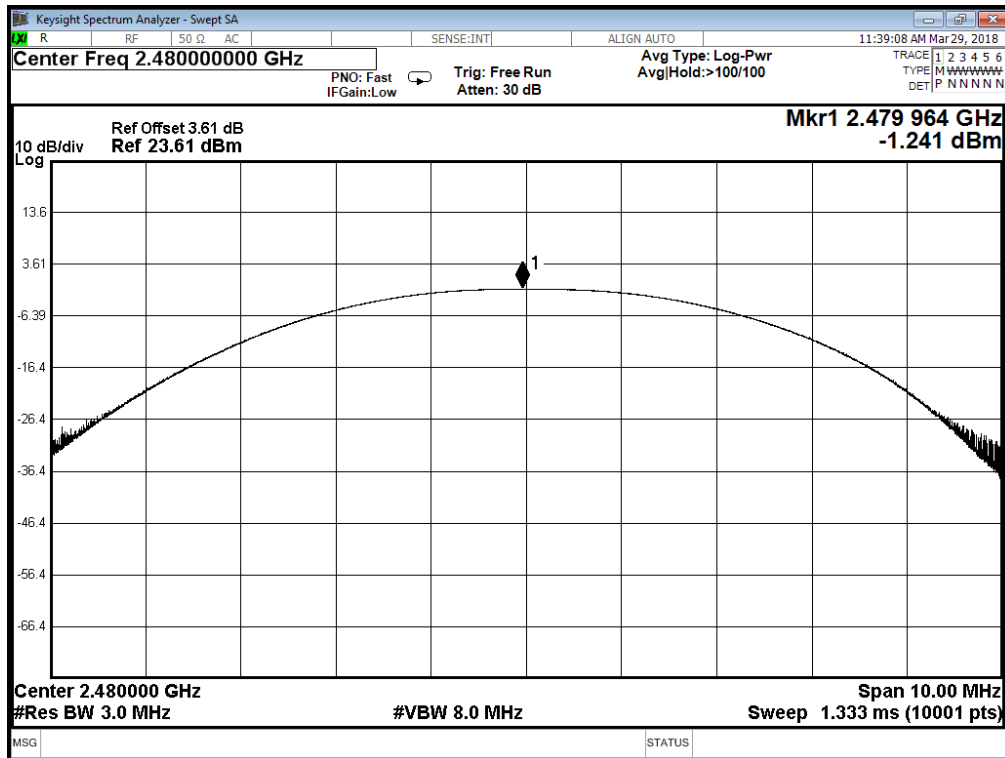

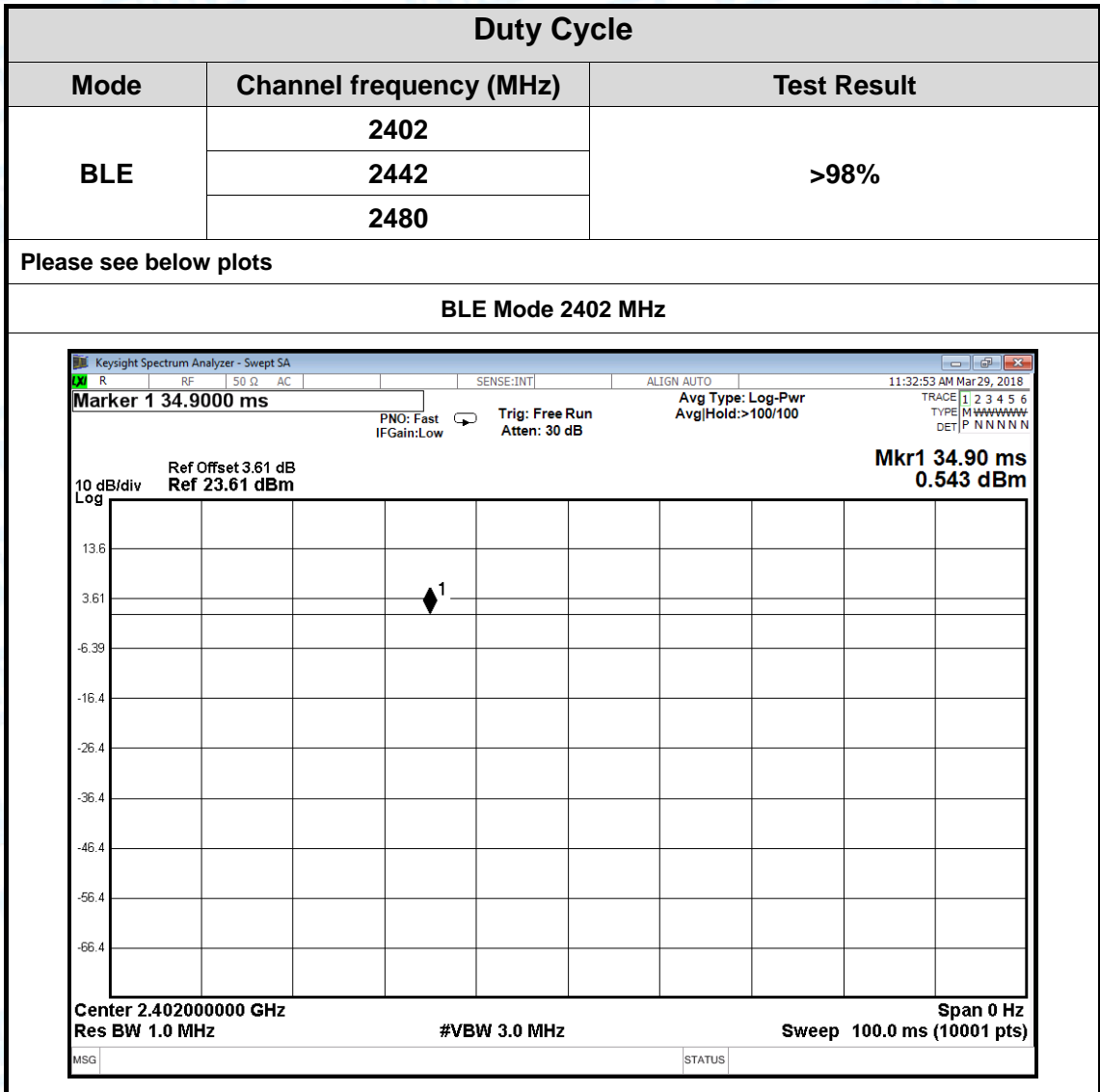

**BLE Mode 2442 MHz**

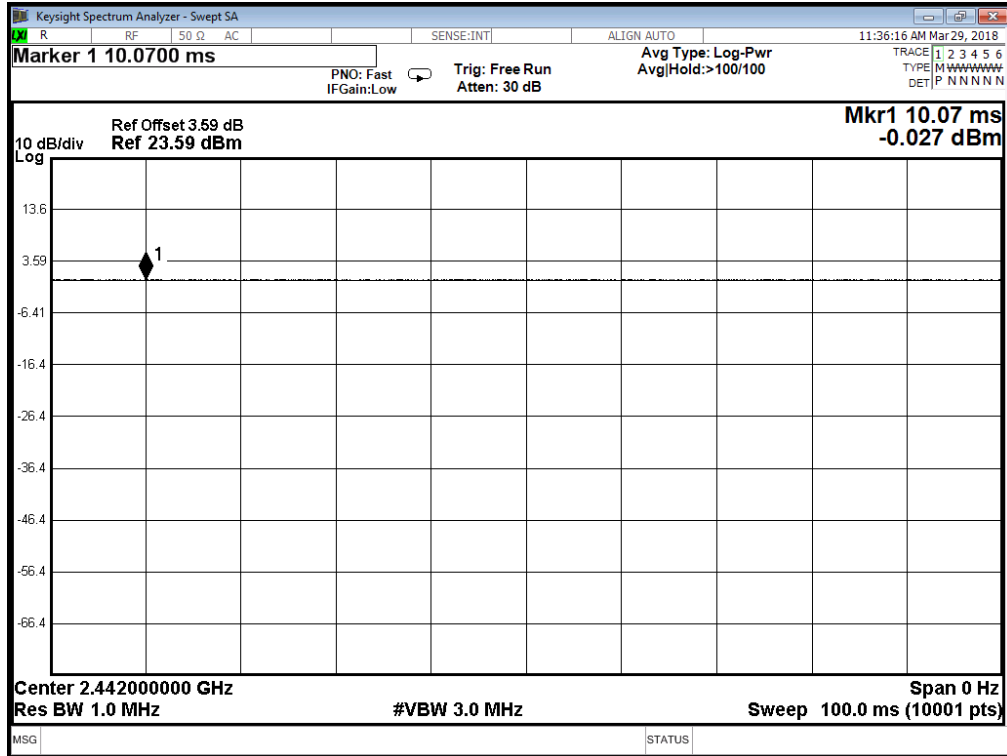

**BLE Mode 2480 MHz**

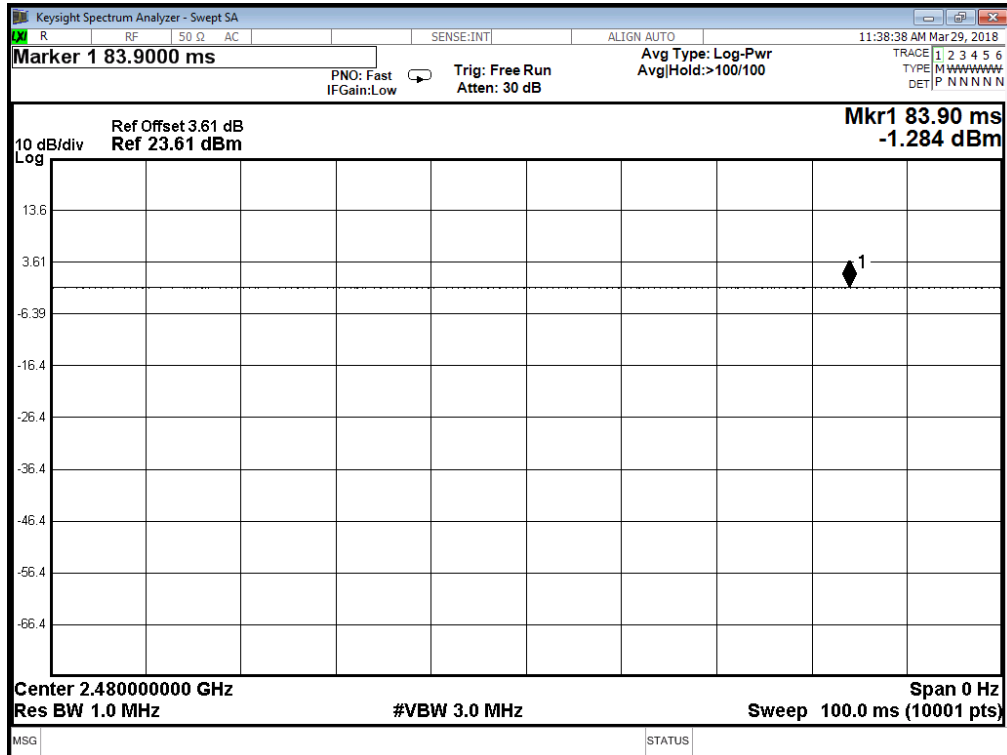

<b>Temperature:</b>	25°C	<b>Relative Humidity:</b>	55%
<b>Test Voltage:</b>	DC 3.6V		
<b>Test Mode:</b>	BLE TX Mode(Module 2)		
<b>Channel frequency (MHz)</b>	<b>Test Result (dBm)</b>	<b>Limit (dBm)</b>	
2402	0.129	<b>30</b>	
2442	-0.093		
2480	-1.233		

**BLE Mode**  
**2402 MHz**

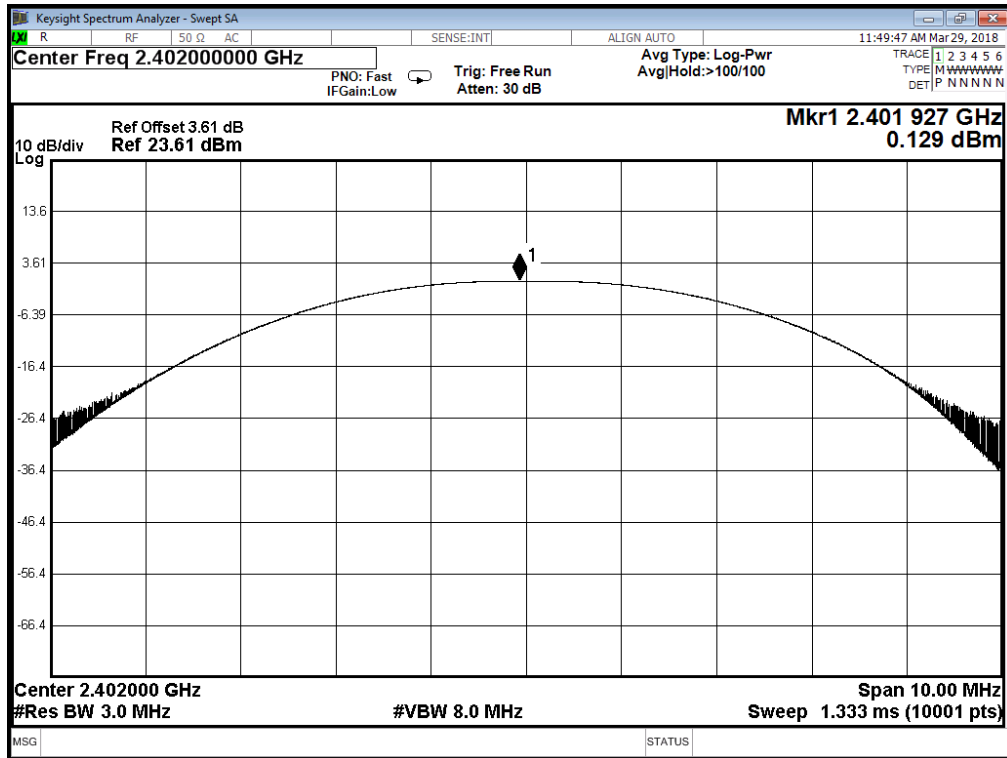



**BLE Mode**  
**2442 MHz**

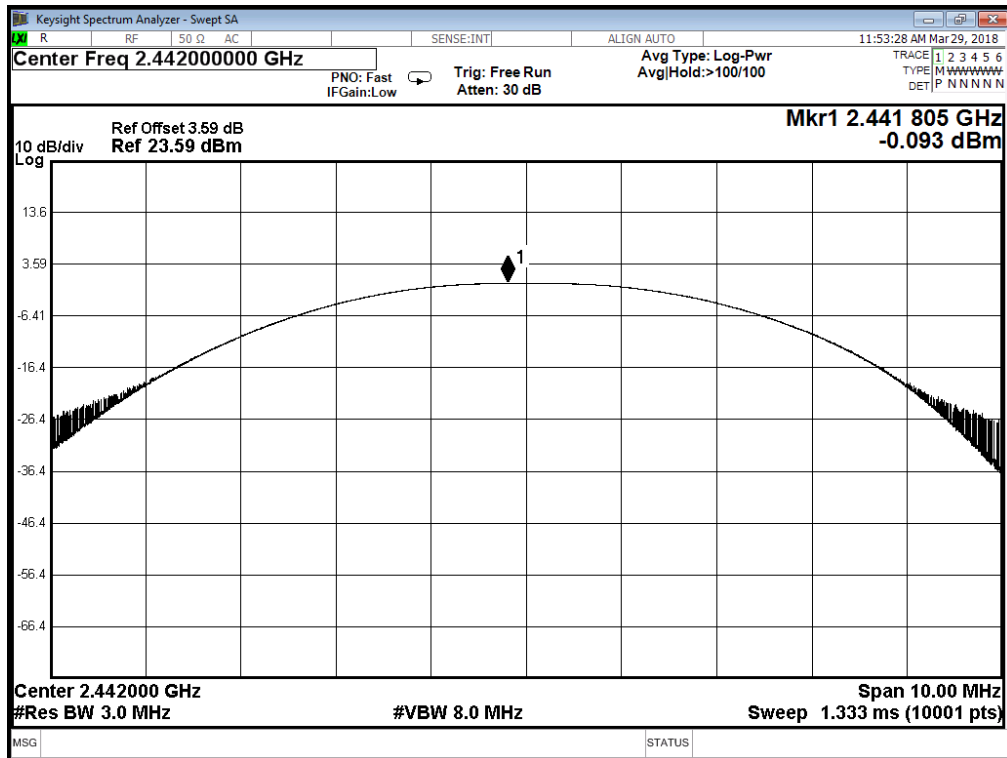

**BLE Mode**  
**2480 MHz**

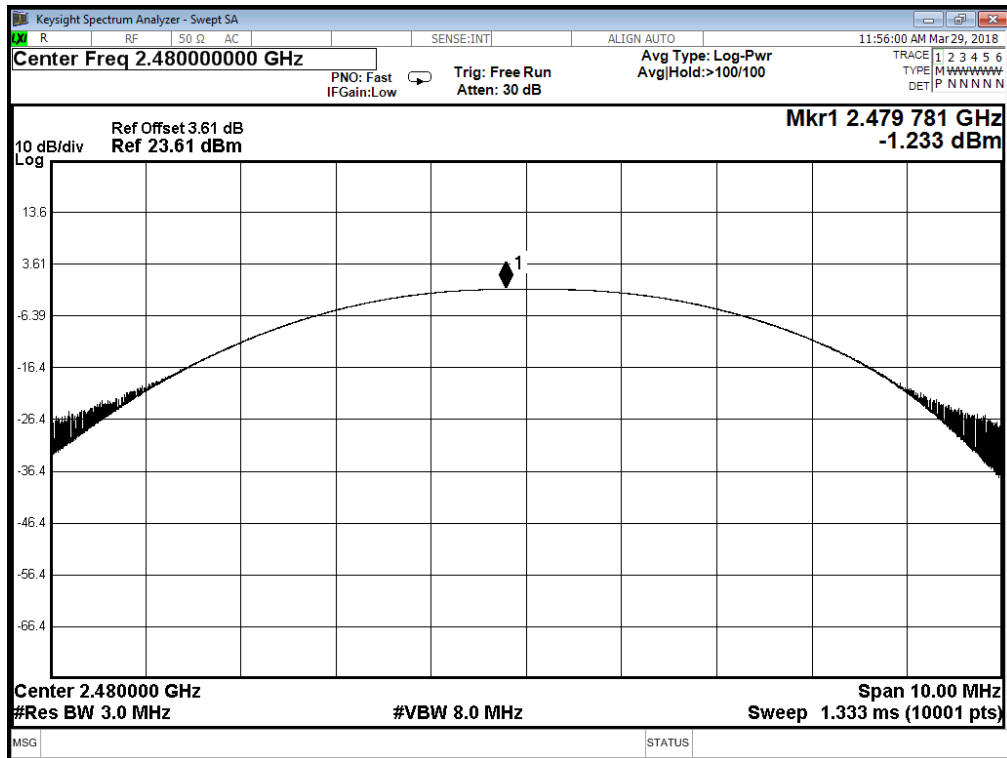

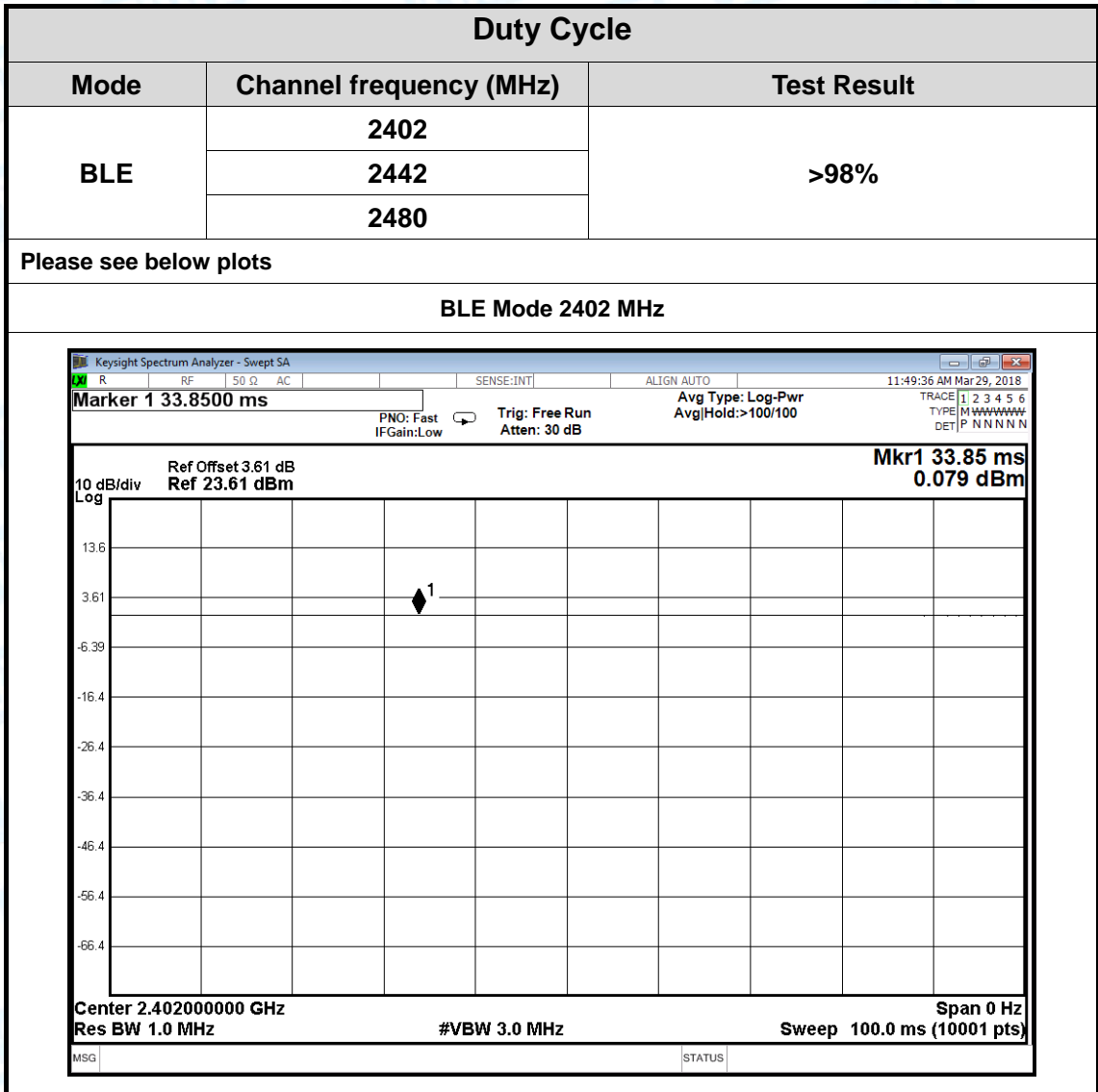

**BLE Mode 2442 MHz**

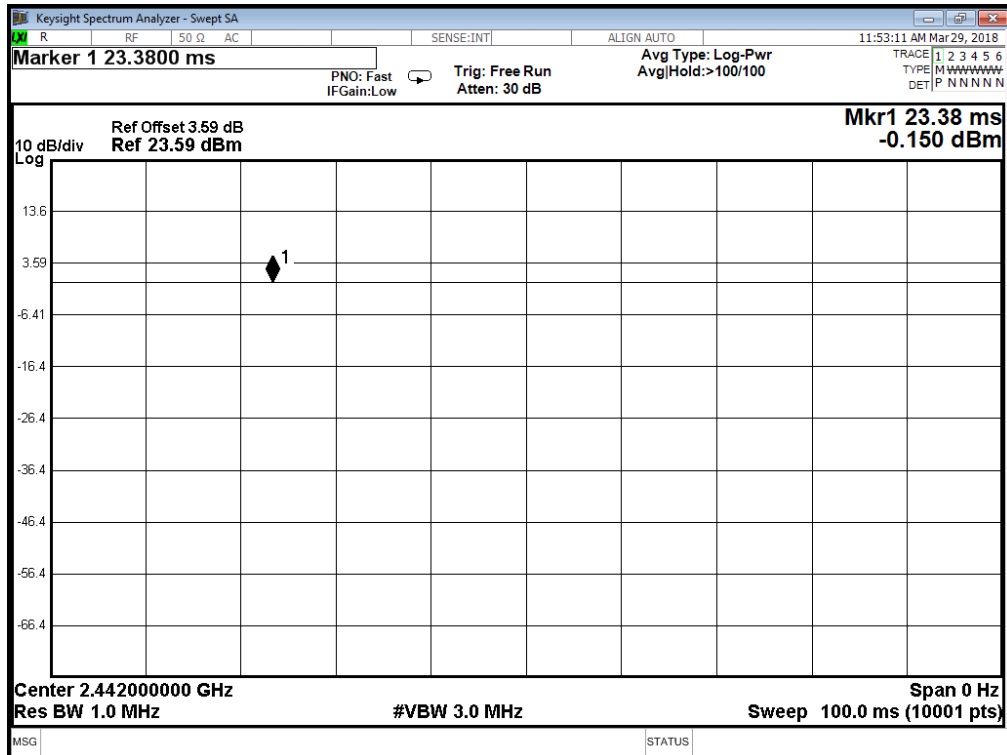

**BLE Mode 2480 MHz**

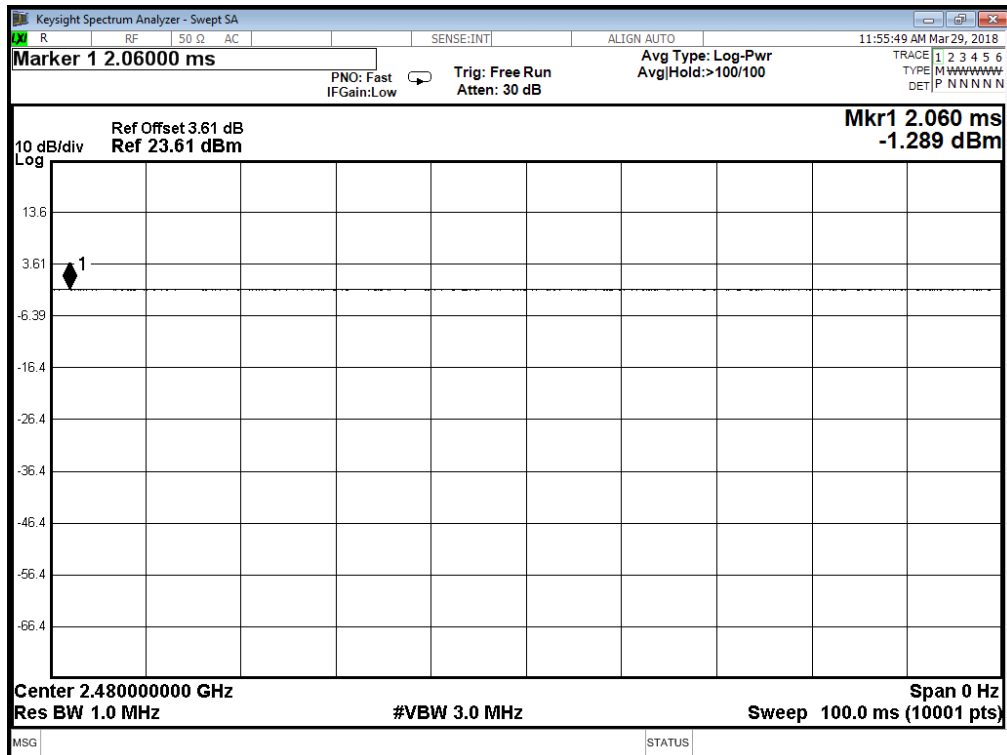

## Attachment E-- Power Spectral Density Test Data

Temperature:	25°C	Relative Humidity:	55%
Test Voltage:	DC 3.6V		
Test Mode:	BLE TX Mode(Module 1)		
Channel Frequency (MHz)	Power Density (dBm/3 kHz)	Limit (dBm/3 kHz)	Result
2402	-17.385	8	PASS
2442	-17.921		
2480	-19.198		

BLE Mode

2402 MHz

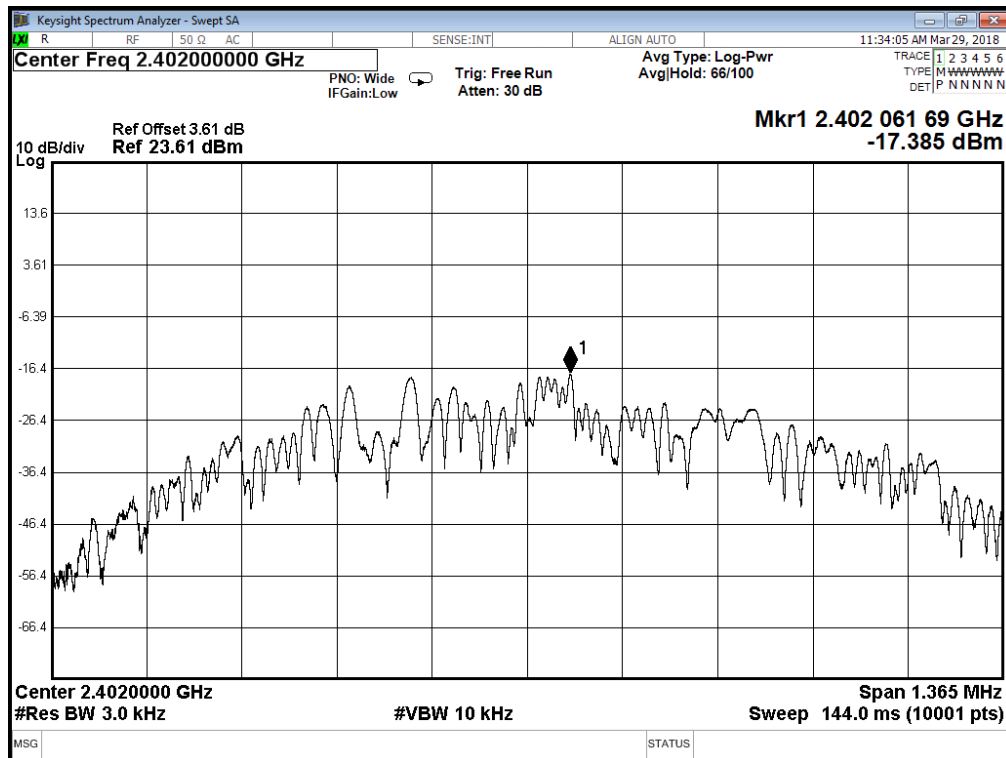

**BLE Mode**  
**2442 MHz**

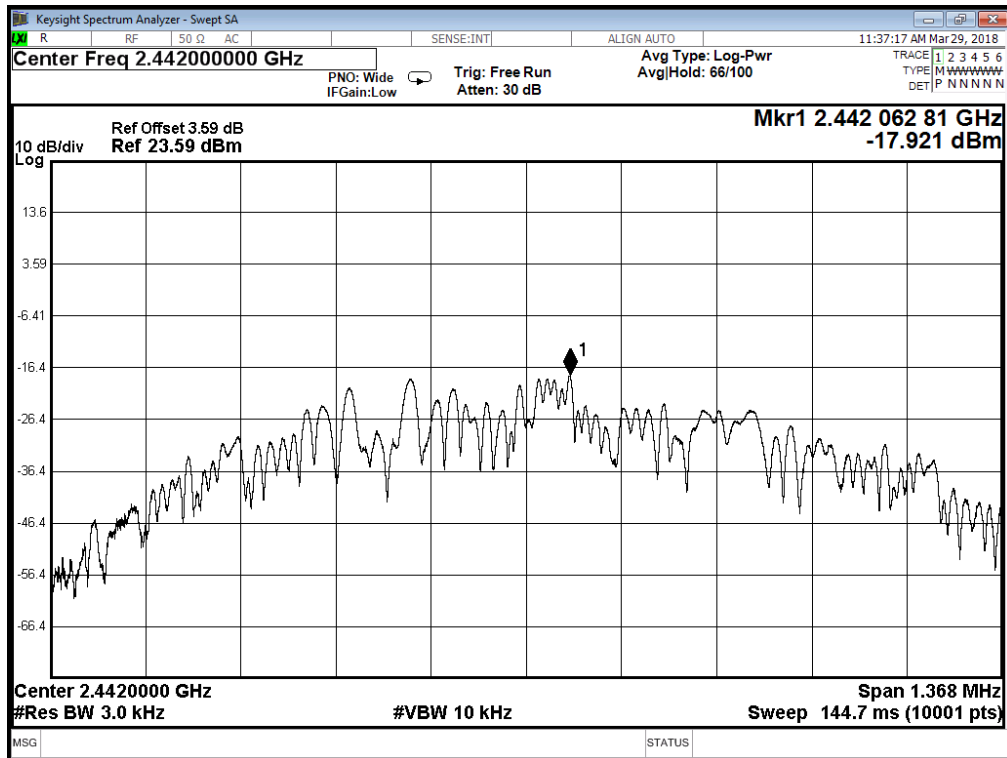

**BLE Mode**  
**2480 MHz**

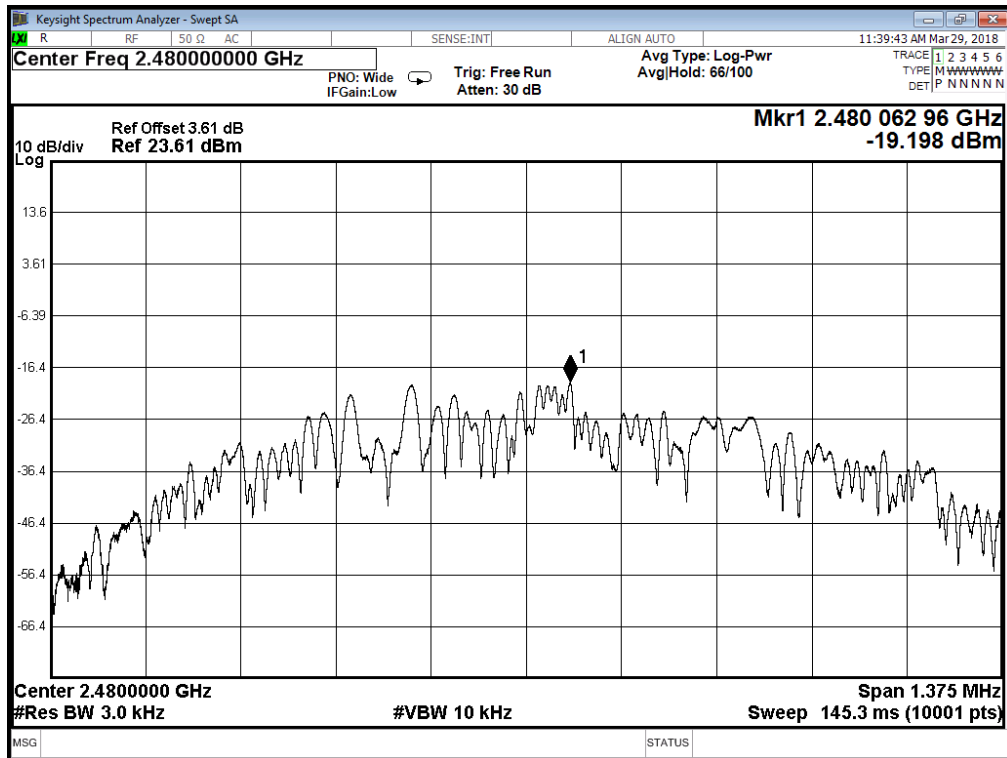

<b>Temperature:</b>	25°C	<b>Relative Humidity:</b>	55%
<b>Test Voltage:</b>	DC 3.6V		
<b>Test Mode:</b>	BLE TX Mode(Module 2)		
<b>Channel Frequency (MHz)</b>	<b>Power Density (dBm/3 kHz)</b>	<b>Limit (dBm/3 kHz)</b>	<b>Result</b>
2402	-17.404	8	PASS
2442	-17.579		
2480	-18.845		
<b>BLE Mode</b>			
<b>2402 MHz</b>			

  

Keysight Spectrum Analyzer - Swept SA  
Center Freq 2.40200000 GHz  
PNO: Wide IFGain:Low Trig: Free Run Atten: 30 dB  
Avg Type: Log-Pwr AvgHold: 66/100  
11:50:46 AM Mar 29, 2018  
TRACE 1 2 3 4 5 6  
TYPE M W W W W W W W  
DET P N N N N N N

Ref Offset 3.61 dB Ref 23.61 dB  
Mkr1 2.402 056 13 GHz -17.404 dBm

10 dB/div Log  
Center 2.4020000 GHz #Res BW 3.0 kHz #VBW 10 kHz Span 1.366 MHz Sweep 144.7 ms (10001 pts)

**BLE Mode**  
**2442 MHz**

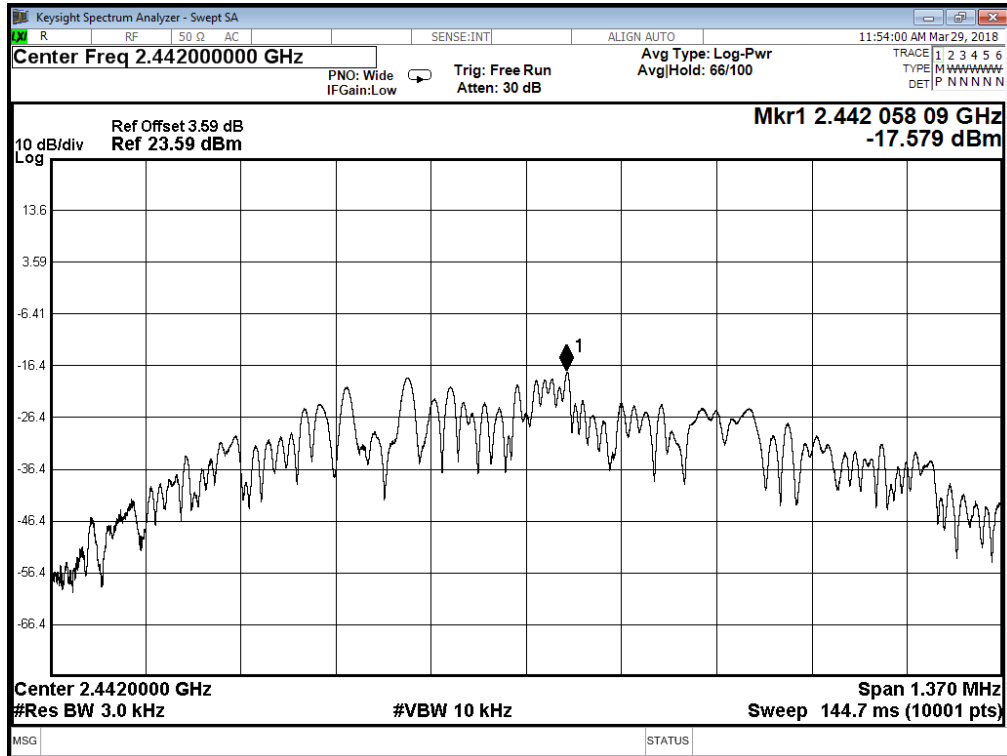

**BLE Mode**  
**2480 MHz**

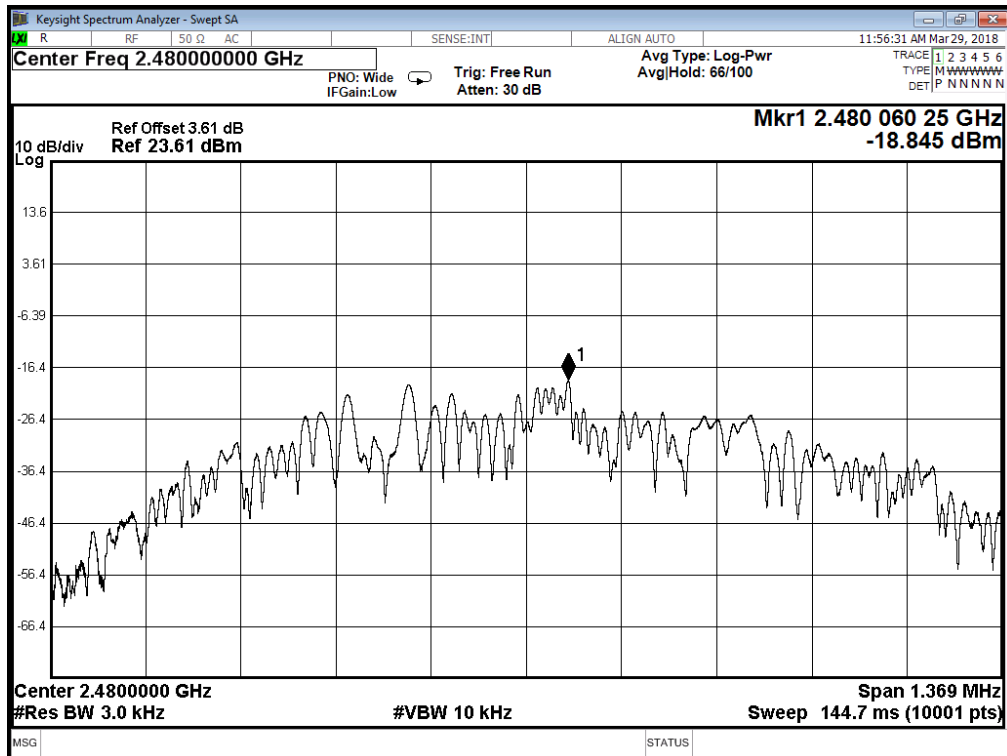

-----END OF REPORT-----