



TEST REPORT



Applicant	SZ Telstar CO.,LTD
Address	Telstar Technology Park No.12~14,Gangbei Industrial Zone, Ailian, Longgang District, ShenZhen

Manufacturer or Supplier	SZ Telstar CO.,LTD
Address	Telstar Technology Park No.12~14,Gangbei Industrial Zone, Ailian, Longgang District, ShenZhen
Product	Projector
Brand Name	miroir, Brookstone
Model	U5
Additional Model & Model Difference	M400A, M400, 318490, see item 3.1
Date of tests	Oct. 15, 2016 ~ Nov. 08, 2016

The tests have been carried out according to the requirements of the following standard:

FCC Part 15, Subpart E, Section 15.407

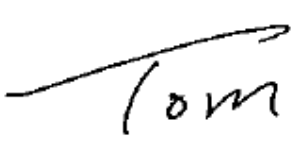
CONCLUSION: The submitted sample was found to COMPLY with the test requirement

Tested by Tom Chen Project Engineer / EMC Department	Approved by Glyn He Supervisor/ EMC Department
	 Date: Nov. 30, 2016

This report is for your exclusive use. Any copying or replication of this report to or for any other person or entity, or use of our name or trademark, is permitted only with our prior written permission. This report sets forth our findings solely with respect to the test samples identified herein. The results set forth in this report are not indicative or representative of the quality or characteristics of the lot from which a test sample was taken or any similar or identical product unless specifically and expressly noted. Our report includes all of the tests requested by you and the results thereof based upon the information that you provided to us. You have 60 days from date of issuance of this report to notify us of any material error or omission caused by our negligence, provided, however, that such notice shall be in writing and shall specifically address the issue you wish to raise. A failure to raise such issue within the prescribed time shall constitute your unqualified acceptance of the completeness of this report, the tests conducted and the correctness of the report contents. Unless specific mention, the uncertainty of measurement has been explicitly taken into account to declare the compliance or non-compliance to the specification



TABLE OF CONTENTS

RELEASE CONTROL RECORD 4

1. SUMMARY OF TEST RESULTS..... 5

1.1 MEASUREMENT UNCERTAINTY 5

2. GENERAL INFORMATION 6

2.1 GENERAL DESCRIPTION OF EUT..... 6

2.2 DESCRIPTION OF TEST MODES..... 8

2.2.1 TEST MODE APPLICABILITY AND TESTED CHANNEL DETAIL 9

2.3 DUTY CYCLE OF TEST SIGNAL 11

2.4 DESCRIPTION OF SUPPORT UNITS..... 15

2.5 GENERAL DESCRIPTION OF APPLIED STANDARDS..... 15

3. TEST TYPES AND RESULTS..... 16

3.1 RADIATED EMISSION AND BANDEDGE MEASUREMENT 16

3.1.1 LIMITS OF RADIATED EMISSION AND BANDEDGE MEASUREMENT 16

3.1.2 LIMITS OF UNWANTED EMISSION OUT OF THE RESTRICTED BANDS 17

3.1.3 TEST INSTRUMENTS..... 17

3.1.4 TEST PROCEDURES 19

3.1.5 DEVIATION FROM TEST STANDARD 19

3.1.6 TEST SETUP 20

3.1.7 EUT OPERATING CONDITION 20

3.1.8 TEST RESULTS 21

3.2 CONDUCTED EMISSION MEASUREMENT 39

3.2.1 LIMITS OF CONDUCTED EMISSION MEASUREMENT 39

3.2.2 TEST INSTRUMENTS..... 39

3.2.3 TEST PROCEDURES 40

3.2.4 DEVIATION FROM TEST STANDARD 40

3.2.5 TEST SETUP 40

3.2.6 EUT OPERATING CONDITIONS 40

3.2.7 TEST RESULTS 41

3.3 TRANSMIT POWER MEASUREMENT 43



3.3.1	LIMITS OF TRANSMIT POWER MEASUREMENT	43
3.3.2	TEST SETUP	43
3.3.3	TEST INSTRUMENTS.....	44
3.3.4	TEST PROCEDURE	44
3.3.5	DEVIATION FROM TEST STANDARD	46
3.3.6	EUT OPERATING CONDITIONS	46
3.3.7	TEST RESULTS	47
3.4	PEAK POWER SPECTRAL DENSITY MEASUREMENT.....	57
3.4.1	LIMITS OF PEAK POWER SPECTRAL DENSITY MEASUREMENT	57
3.4.2	TEST SETUP	57
3.4.3	TEST INSTRUMENTS.....	57
3.4.4	TEST PROCEDURES	57
3.4.5	DEVIATION FROM TEST STANDARD	58
3.4.6	EUT OPERATING CONDITIONS	58
3.4.7	TEST RESULTS	59
3.5	FREQUENCY STABILITY	63
3.5.1	LIMITS OF FREQUENCY STABILITY MEASUREMENT	63
3.5.2	TEST SETUP	63
3.5.3	TEST INSTRUMENTS.....	63
3.5.4	TEST PROCEDURE	64
3.5.5	DEVIATION FROM TEST STANDARD	64
3.5.6	EUT OPERATING CONDITION	64
3.5.7	TEST RESULTS	65
4.	PHOTOGRAPHS OF THE TEST CONFIGURATION.....	66
5.	APPENDIX A – MODIFICATIONS RECORDERS FOR ENGINEERING CHANGES TO THE EUT BY THE LAB.....	67



BUREAU VERITAS Test Report No.: RF160928N001-3

RELEASE CONTROL RECORD

ISSUE NO.	REASON FOR CHANGE	DATE ISSUED
RF160928N001-3	Original release	Nov. 30, 2016



1. SUMMARY OF TEST RESULTS

The EUT has been tested according to the following specifications:

APPLIED STANDARD: FCC PART 15, SUBPART E (SECTION 15.407 UNDER NEW RULE)			
STANDARD SECTION	TEST TYPE	RESULT	REMARK
15.407(b)(6)	AC Power Conducted Emissions	PASS	Meet the requirement of limit.
15.407(b) (1/2/3/4/6)	Radiated Emissions & Band Edge Measurement	PASS	Meet the requirement of limit.
15.407(a)(1/2/3)	Max Average Transmit Power	PASS	Meet the requirement of limit.
15.407(a)(1/2/3)	Peak Power Spectral Density	PASS	Meet the requirement of limit.
15.407(g)	Frequency Stability	PASS	Meet the requirement of limit.
15.203	Antenna Requirement	PASS	No antenna connector is used

1.1 MEASUREMENT UNCERTAINTY

Where relevant, the following measurement uncertainty levels have been estimated for tests performed on the EUT as specified in CISPR 16-4-2:

MEASUREMENT	FREQUENCY	UNCERTAINTY
Conducted emissions	9kHz~30MHz	2.70dB
Radiated emissions	9KHz ~ 30MHz	2.90dB
	30MHz ~ 1GMHz	3.83dB
	1GHz ~ 18GHz	4.93dB
	18GHz ~ 40GHz	4.80dB

This uncertainty represents an expanded uncertainty expressed at approximately the 95% confidence level using a coverage factor of $k = 2$.



2. GENERAL INFORMATION

2.1 GENERAL DESCRIPTION OF EUT

EUT	Projector
MODEL NO.	U5
MODULE NO.	AP62X2
ADDITIONAL MODEL	M400A, M400, 318490
FCC ID	2AFOW-UST520U5
POWER SUPPLY	AC 120V 60Hz
MODULATION TYPE	CCK, DQPSK, DBPSK, 64QAM, 16QAM, QPSK, BPSK
MODULATION TECHNOLOGY	OFDM
TRANSFER RATE	802.11a: 54.0/ 48.0/ 36.0/ 24.0/ 18.0/ 12.0/ 9.0/ 6.0Mbps 802.11n: up to 150Mbps
OPERATING FREQUENCY	5180 ~ 5240MHz; 5745 ~ 5825MHz
NUMBER OF CHANNEL	5180 ~ 5240MHz: 4 for 802.11a, 802.11n (20MHz) 2 for 802.11n (40MHz) 5745 ~ 5825MHz: 5 for 802.11a, 802.11n (20MHz) 2 for 802.11n (40MHz)
OUTPUT POWER(Average)	16.12dBm for 5180 ~ 5240MHz (Maximum) 14.11dBm for 5745 ~ 5825MHz (Maximum)
ANTENNA TYPE	Integral FPCB Antenna, 2.0dBi Gain
DATA CABLE	AC Cable: Unshielded, detachable, 2.0m Audio Out Cable: Unshielded, detachable, 1.7m HDMI Cable: Unshielded, detachable, 1.5m
I/O PORTS	Refer to user's manual

NOTE:

1. The EUT provides completed transmitters and receivers.

MODULATION MODE	TX FUNCTION
802.11a	1TX/1RX
802.11n (20MHz)	2TX/2RX
802.11n (40MHz)	2TX/2RX

The directional gain = 2dBi + 10log(2) = 5.01dBi

2. For a more detailed features description, please refer to the manufacturer's specifications or the user's manual.



BUREAU VERITAS Test Report No.: RF160928N001-3

3. For the test results, the EUT had been tested with all conditions. But only the worst case was shown in test report.
4. Please refer to the EUT photo document (Reference No.: 160928N001) for detailed product photo.
5. Additional models M400A, M400, 318490 are identical with the test model U5, except the model number for marketing purpose.



2.2 DESCRIPTION OF TEST MODES

FOR 5180 ~ 5240MHz

4 channels are provided for 802.11a, 802.11n (20MHz):

CHANNEL	FREQUENCY	CHANNEL	FREQUENCY
36	5180 MHz	40	5200 MHz
44	5220 MHz	48	5240 MHz

2 channels are provided for 802.11n (40MHz):

CHANNEL	FREQUENCY	CHANNEL	FREQUENCY
38	5190 MHz	46	5230 MHz

FOR 5745 ~ 5825MHz

5 channels are provided for 802.11a, 802.11n (20MHz):

CHANNEL	FREQUENCY	CHANNEL	FREQUENCY
149	5745MHz	153	5765MHz
157	5785MHz	161	5805MHz
165	5825MHz		

2 channels are provided for 802.11n (40MHz):

CHANNEL	FREQUENCY	CHANNEL	FREQUENCY
151	5755MHz	159	5795MHz



2.2.1 TEST MODE APPLICABILITY AND TESTED CHANNEL DETAIL

EUT CONFIGURE MODE	APPLICABLE TO				DESCRIPTION
	RE≥1G	RE<1G	PLC	APCM	
A	√	√	√	√	Powered by AC120V with WIFI 5GHz

Where **RE≥1G**: Radiated Emission above 1GHz **RE<1G**: Radiated Emission below 1GHz
PLC: Power Line Conducted Emission **APCM**: Antenna Port Conducted Measurement

NOTE: "-" means no effect.

RADIATED EMISSION TEST (ABOVE 1GHz):

- Pre-Scan has been conducted to determine the worst-case mode from all possible combinations between available modulations, data rates and antenna ports (if EUT with antenna diversity architecture).
- Following channel(s) was (were) selected for the final test as listed below.

EUT CONFIGURE MODE	MODE	FREQ. BAND (MHz)	AVAILABLE CHANNEL	TESTED CHANNEL	MODULATION TECHNOLOGY	MODULATION TYPE	DATA RATE (Mbps)
A	802.11a	5180-5240 5745-5825	36 to 48 149 to 165	36, 44, 48 149,157,165	OFDM	BPSK	6.0
A	802.11n (20MHz)		36 to 48 149 to 165	36, 44, 48 149,157,165	OFDM	BPSK	6.5
A	802.11n (40MHz)		38 to 46 151 to 159	38, 46 151,159	OFDM	BPSK	13.5

RADIATED EMISSION TEST (BELOW 1GHz):

- Pre-Scan has been conducted to determine the worst-case mode from all possible combinations between available modulations, data rates and antenna ports (if EUT with antenna diversity architecture).
- Following channel(s) was (were) selected for the final test as listed below.

EUT CONFIGURE MODE	MODE	FREQ. BAND (MHz)	AVAILABLE CHANNEL	TESTED CHANNEL	MODULATION TECHNOLOGY	MODULATION TYPE	DATA RATE (Mbps)
A	802.11a	5180-5240 5745-5825	36 to 48 149 to 165	36	OFDM	BPSK	6.0

POWER LINE CONDUCTED EMISSION TEST:

- Pre-Scan has been conducted to determine the worst-case mode from all possible combinations between available modulations, data rates and antenna ports (if EUT with antenna diversity architecture).
- Following channel(s) was (were) selected for the final test as listed below.

EUT CONFIGURE MODE	MODE	FREQ. BAND (MHz)	AVAILABLE CHANNEL	TESTED CHANNEL	MODULATION TECHNOLOGY	MODULATION TYPE	DATA RATE (Mbps)
A	802.11a	5180-5240 5745-5825	36 to 48 149 to 165	36	OFDM	BPSK	6.0



ANTENNA PORT CONDUCTED MEASUREMENT:

- This item includes all test value of each mode, but only includes spectrum plot of worst value of each mode.
- Pre-Scan has been conducted to determine the worst-case mode from all possible combinations between available modulations, data rates and antenna ports (if EUT with antenna diversity architecture).
- Following channel(s) was (were) selected for the final test as listed below.

EUT CONFIGURE MODE	MODE	FREQ. BAND (MHz)	AVAILABLE CHANNEL	TESTED CHANNEL	MODULATION TECHNOLOGY	MODULATION TYPE	DATA RATE (Mbps)
A	802.11a	5180-5240 5745-5825	36 to 48 149 to 165	36, 44, 48 149,157,165	OFDM	BPSK	6.0
A	802.11n (20MHz)		36 to 48 149 to 165	36, 44, 48 149,157,165	OFDM	BPSK	6.5
A	802.11n (40MHz)		38 to 46 151 to 159	38, 46 151,159	OFDM	BPSK	13.5

TEST CONDITION:

APPLICABLE TO	ENVIRONMENTAL CONDITIONS	INPUT POWER	TESTED BY
RE≥1G	25deg. C, 50%RH	AC 120V 60Hz	Cheng Zhong
RE<1G	25deg. C, 50%RH	AC 120V 60Hz	Cheng Zhong
PLC	20deg. C, 56%RH	AC 120V 60Hz	Robert Cheng
APCM	20deg. C, 55%RH	AC 120V 60Hz	Robert Cheng



2.3 DUTY CYCLE OF TEST SIGNAL

Band 1

Chain 0:

802.11a: Duty cycle = 1.296/1.335 = 0.97, Duty factor = $10 * \log(1/0.97) = 0.13$

802.11n (20MHz): Duty cycle = 1.297/1.335 = 0.97, Duty factor = $10 * \log(1/0.97) = 0.13$

802.11n (40MHz): Duty cycle = 0.335/0.374 = 0.90, Duty factor = $10 * \log(1/0.90) = 0.46$





Chain 1:

802.11n (20MHz): Duty cycle = 1.885/1.923= 0.980, Duty factor = 10 * log(1/0.980) = 0.088

802.11n (40MHz): Duty cycle = 0.926/0.964= 0.961, Duty factor = 10 * log(1/0.961) = 0.173

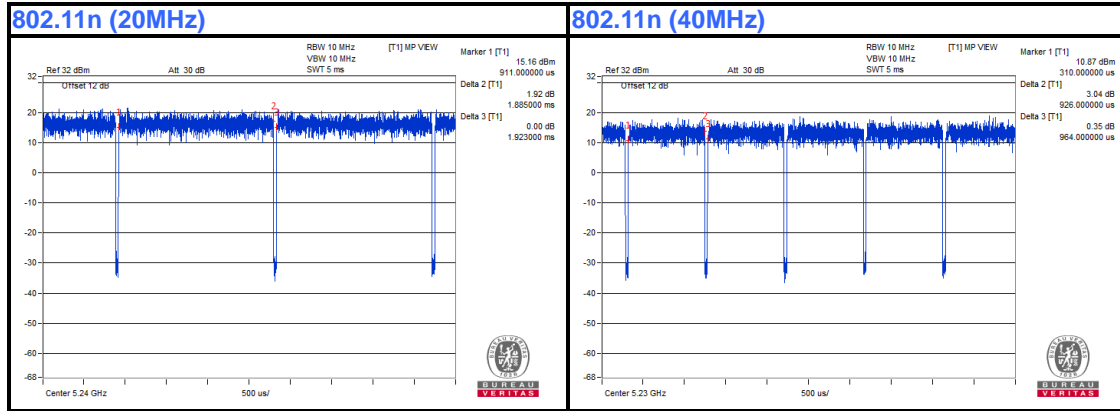



Band 4

Chain 0:

802.11a: Duty cycle = 2.022/2.064 = 0.978, Duty factor = 10 * log(1/0.978) = 0.097

802.11n (20MHz): Duty cycle = 1.885/1.925 = 0.979, Duty factor = 10 * log(1/0.979) = 0.092

802.11n (40MHz): Duty cycle = 0.926/0.963 = 0.962, Duty factor = 10 * log(1/0.962) = 0.168





Chain 1:

802.11n (20MHz): Duty cycle = 1.886/1.924 = 0.980, Duty factor = 10 * log(1/0.980) = 0.088

802.11n (40MHz): Duty cycle = 0.925/0.965 = 0.959, Duty factor = 10 * log(1/0.959) = 0.182





2.4 DESCRIPTION OF SUPPORT UNITS

The EUT has been tested as an independent unit together with other necessary accessories or support units. The following support units or accessories were used to form a representative test configuration during the tests.

NO.	PRODUCT	BRAND	MODEL NO.	SERIAL NO.	FCC ID
1	N/A	N/A	N/A	N/A	N/A

NO.	DESCRIPTION OF THE ABOVE SUPPORT UNITS
1	N/A

2.5 GENERAL DESCRIPTION OF APPLIED STANDARDS

The EUT is a RF Product. According to the specification of the EUT declared by the manufacturer, it must comply with the requirements of the following standards:

FCC Part 15, Subpart E (15.407)

789033 D02 General UNII Test Procedures New Rules v01r03

KDB 662911 D01 v02r01

ANSI C63.10-2013

All test items have been performed and recorded as per the above standards.

NOTE: The EUT is also considered as a kind of computer peripheral, because the connection to computer is necessary for typical use. It has been verified to comply with the requirements of FCC Part 15, Subpart B, Class B (DoC). The test report has been issued separately.



3. TEST TYPES AND RESULTS

3.1 RADIATED EMISSION AND BANDEDGE MEASUREMENT

3.1.1 LIMITS OF RADIATED EMISSION AND BANDEDGE MEASUREMENT

Radiated emissions which fall in the restricted bands must comply with the radiated emission limits specified as below table:

FREQUENCIES (MHz)	FIELD STRENGTH (microvolts/meter)	MEASUREMENT DISTANCE (meters)
0.009 ~ 0.490	2400/F(kHz)	300
0.490 ~ 1.705	24000/F(kHz)	30
1.705 ~ 30.0	30	30
30 ~ 88	100	3
88 ~ 216	150	3
216 ~ 960	200	3
Above 960	500	3

NOTE:

1. The lower limit shall apply at the transition frequencies.
2. Emission level (dBuV/m) = 20 log Emission level (uV/m).
3. For frequencies above 1000MHz, the field strength limits are based on average detector, however, the peak field strength of any emission shall not exceed the maximum permitted average limits, specified above by more than 30dB under any condition of modulation.



3.1.2 LIMITS OF UNWANTED EMISSION OUT OF THE RESTRICTED BANDS

APPLICABLE TO	LIMIT	
789033 D02 General UNII Test Procedures New Rules v01r03	FIELD STRENGTH AT 3m	
	PK: 74 (dBμV/m)	AV: 54 (dBμV/m)
APPLICABLE TO	EIRP LIMIT	EQUIVALENT FIELD STRENGTH AT 3m
15.407(b)(1)	PK: -27 (dBm/MHz)	PK: 68.2 (dBμV/m)
15.407(b)(2)		
15.407(b)(3)		
15.407(b)(4)	Note	Note

NOTE: For transmitters operating in the 5.725-5.85 GHz band:

15.407(b)(4)(i) All emissions shall be limited to a level of -27 dBm/MHz at 75 MHz or more above or below the band edge increasing linearly to 10 dBm/MHz at 25 MHz above or below the band edge, and from 25 MHz above or below the band edge increasing linearly to a level of 15.6 dBm/MHz at 5 MHz above or below the band edge, and from 5 MHz above or below the band edge increasing linearly to a level of 27 dBm/MHz at the band edge.

The following formula is used to convert the equipment isotropic radiated power (eirp) to field strength:

$$E = \frac{1000000\sqrt{30P}}{3} \mu\text{V/m, where P is the eirp (Watts).}$$



3.1.3 TEST INSTRUMENTS

Equipment	Manufacturer	Model No.	Serial No.	Last Cal.	Next Cal.
EMI Test Receiver	Rohde&Schwarz	ESR7	101494	Apr. 05,16	Apr. 04,17
Signal and Spectrum Analyzer	Rohde&Schwarz	FSV7	102331	Nov. 04,16	Nov. 03,17
Bilog Antenna	Teseq	CBL 6111D	30643	Jul. 14, 16	Jul. 13, 17
Horn Antenna (1GHz -18GHz)	ETS -Lindgren	3117	00062558	May 18,16	May 17,17
GPS Generator+ Antenna	TOJOIN	GNSS-5000A	E1-010119	Aug. 08, 16	Aug. 07, 17
3m Semi-anechoic Chamber	ETS-LINDGREN	9m*6m*6m	NSEMC003	Mar. 12,16	Mar. 11,18
Test Software	ADT	ADT_Radiated_V7.6.15.9.2	N/A	N/A	N/A
Horn Antenna	SCHWARZBECK	BBHA 9170	BBHA9170242	Mar. 12,16	Mar. 11,17
Amplifier (9kHz-1GHz)	SONOMA	310D	186955	Mar. 04,16	Mar. 03, 17
Pre-Amplifier(1-18G)	HP	8449B	3008A00409	Apr. 25,16	Apr. 24,17
Pre-Amplifier (18GHz-40GHz)	EMCI	EMC 184045	980102	Nov. 04,16	Nov. 03,17
Test Software	ADT	ADT_Radiated_V7.6.15.9.2	N/A	N/A	N/A
BLUETOOTH TESTER	Rohde&Schwarz	CBT32	100811	Aug. 08,16	Aug. 07,17

NOTE:

1. The test was performed in 966 Chamber.
2. The calibration interval of the above test instruments is 12 or 24 months and the calibrations are traceable to CEPREI/CHINA, GRGT/CHINA and NIM/CHINA.
3. The horn antenna is used only for the measurement of emission frequency above 1GHz if tested.
4. The FCC Site Registration No. is 494399.



3.1.4 TEST PROCEDURES

- a. The EUT was placed on the top of a rotating table 1.5 meters above the ground at a 3 meter semi-anechoic chamber. The table was rotated 360 degrees to determine the position of the highest radiation.
- b. The EUT was set 3 meters away from the interference-receiving antenna, which was mounted on the top of a variable-height antenna tower.
- c. The antenna is a broadband antenna, and its height is varied from one meter to four meters above the ground to determine the maximum value of the field strength. Both horizontal and vertical polarizations of the antenna are set to make the measurement.
- d. For each suspected emission, the EUT was arranged to its worst case and then the antenna was tuned to heights from 1 meter to 4 meters and the rotatable table was turned from 0 degrees to 360 degrees to find the maximum reading.
- e. The test-receiver system was set to Peak Detect Function and Specified Bandwidth with Maximum Hold Mode.
- f. If the emission level of the EUT in peak mode was 10dB lower than the limit specified, then testing could be stopped and the peak values of the EUT would be reported. Otherwise the emissions that did not have 10dB margin would be re-tested one by one using peak, quasi-peak or average method as specified and then reported in a data sheet.

NOTE:

1. The resolution bandwidth and video bandwidth of test receiver/spectrum analyzer is 120kHz for Quasi-peak detection at frequency below 1GHz.
2. The resolution bandwidth of test receiver/spectrum analyzer is 1MHz and video bandwidth is 3MHz for Peak detection at frequency above 1GHz.
3. The resolution bandwidth of test receiver/spectrum analyzer is 1MHz and the video bandwidth is $\geq 1/T$ (Duty cycle $< 98\%$) or 10Hz (Duty cycle $> 98\%$) for Average detection (AV) at frequency above 1GHz.
4. All modes of operation were investigated and the worst-case emissions are reported.
5. The testing of the EUT was performed on all 3 orthogonal axes; the worst-case test configuration was reported on the file Test Setup Photo.

3.1.5 DEVIATION FROM TEST STANDARD

No deviation.



3.1.6 TEST SETUP

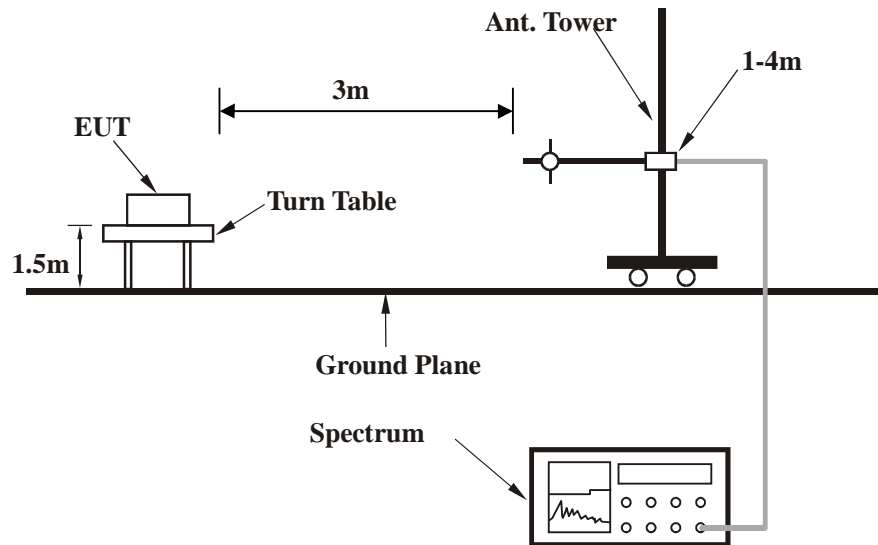

For the actual test configuration, please refer to the attached file (Test Setup Photo).

3.1.7 EUT OPERATING CONDITION

- Placed the EUT on the testing table.
- Prepared a notebook to act as a communication partner and placed it outside of testing area.
- The communication partner was connected with the EUT via a RJ45 cable and ran a test program (provided by manufacturer) to enable the EUT under transmission condition continuously at specific channel frequency.



3.1.8 TEST RESULTS

BELOW 1GHz WORST-CASE DATA

802.11a

CHANNEL	TX Channel 36	DETECTOR FUNCTION	Quasi-Peak (QP)
FREQUENCY RANGE	30MHz ~ 1GHz		

ANTENNA POLARITY & TEST DISTANCE: HORIZONTAL AT 3 M								
NO.	FREQ. (MHz)	EMISSION LEVEL (dBuV/m)	LIMIT (dBuV/m)	MARGIN (dB)	ANTENNA HEIGHT (m)	TABLE ANGLE (Degree)	RAW VALUE (dBuV)	CORRECTION FACTOR (dB/m)
1	221.19	40.21 QP	46.00	-5.79	1.00 H	0	57.82	-17.61
2	263.36	42.64 QP	46.00	-3.36	1.00 H	0	55.50	-12.86
3	297.10	42.23 QP	46.00	-3.77	1.00 H	0	55.57	-13.34
4	444.71	41.83 QP	46.00	-4.17	1.00 H	0	50.20	-8.37
5	593.72	35.59 QP	46.00	-10.41	1.00 H	0	40.00	-4.41
6	742.74	41.73 QP	46.00	-4.27	1.00 H	0	42.16	-0.43

REMARKS:

1. Emission level (dBuV/m) = Raw Value (dBuV) + Correction Factor (dB/m).
2. Correction Factor (dB/m) = Antenna Factor (dB/m) + Cable Factor (dB).
3. The other emission levels were very low against the limit.
4. Margin value = Emission level – Limit value.

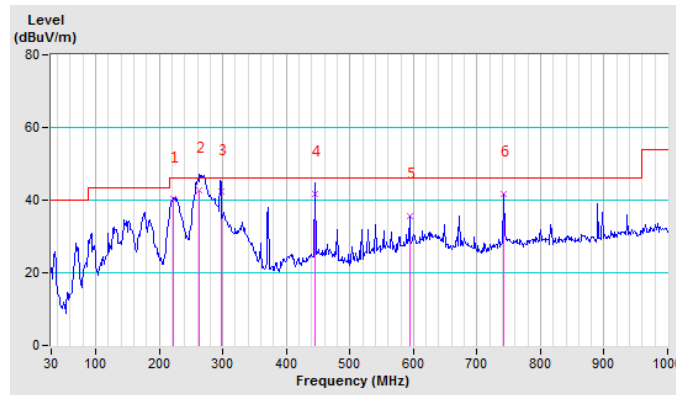



CHANNEL	TX Channel 36	DETECTOR FUNCTION	Quasi-Peak (QP)
FREQUENCY RANGE	30MHz ~ 1GHz		

ANTENNA POLARITY & TEST DISTANCE: VERTICAL AT 3 M								
NO.	FREQ. (MHz)	EMISSION LEVEL (dBuV/m)	LIMIT (dBuV/m)	MARGIN (dB)	ANTENNA HEIGHT (m)	TABLE ANGLE (Degree)	RAW VALUE (dBuV)	CORRECTION FACTOR (dB/m)
1	30.00	35.94 QP	40.00	-4.06	1.00 V	0	46.72	-10.78
2	146.68	32.54 QP	43.50	-10.96	1.00 V	0	49.17	-16.63
3	270.39	42.52 QP	46.00	-3.48	1.00 V	0	56.07	-13.55
4	444.71	40.66 QP	46.00	-5.34	1.00 V	0	49.03	-8.37
5	479.86	34.48 QP	46.00	-11.52	1.00 V	0	41.39	-6.91
6	742.74	42.36 QP	46.00	-3.64	1.00 V	0	42.79	-0.43

REMARKS:

1. Emission level (dBuV/m) = Raw Value (dBuV) + Correction Factor (dB/m).
2. Correction Factor (dB/m) = Antenna Factor (dB/m) + Cable Factor (dB).
3. The other emission levels were very low against the limit.
4. Margin value = Emission level – Limit value.

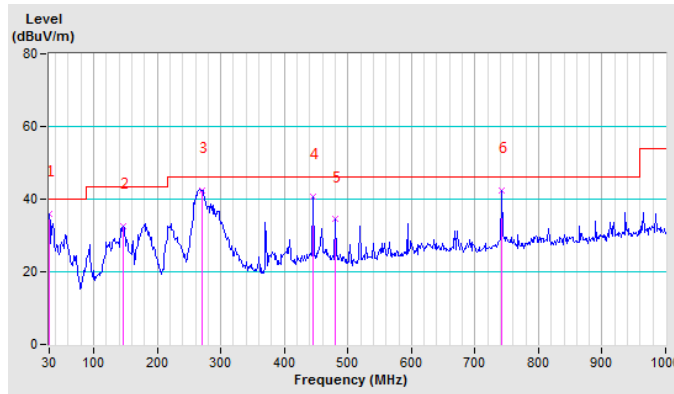



Band 1 (5180-5240MHz):

ABOVE 1GHz DATA

802.11a

CHANNEL	TX Channel 36	DETECTOR FUNCTION	Peak (PK)
FREQUENCY RANGE	1GHz ~ 40GHz		Average (AV)

ANTENNA POLARITY & TEST DISTANCE: HORIZONTAL AT 3 M

NO.	FREQ. (MHz)	EMISSION LEVEL (dBuV/m)	LIMIT (dBuV/m)	MARGIN (dB)	ANTENNA HEIGHT (m)	TABLE ANGLE (Degree)	RAW VALUE (dBuV)	CORRECTION FACTOR (dB/m)
1	5150.00	71.23 PK	74.00	-2.77	1.97 H	290	62.76	8.47
2	5150.00	52.95 AV	54.00	-1.05	1.97 H	290	44.48	8.47
3	*5180.00	108.86 PK			1.97 H	290	100.34	8.52
4	*5180.00	97.21 AV			1.97 H	290	88.69	8.52
5	#10360.00	57.89 PK	74.00	-16.11	1.55 H	210	37.66	20.23
6	#10360.00	42.25 AV	54.00	-11.75	1.55 H	210	22.02	20.23
7	15540.00	62.20 PK	74.00	-11.80	1.00 H	215	39.51	22.69
8	15540.00	46.88 AV	54.00	-7.12	1.00 H	215	24.19	22.69

ANTENNA POLARITY & TEST DISTANCE: VERTICAL AT 3 M

NO.	FREQ. (MHz)	EMISSION LEVEL (dBuV/m)	LIMIT (dBuV/m)	MARGIN (dB)	ANTENNA HEIGHT (m)	TABLE ANGLE (Degree)	RAW VALUE (dBuV)	CORRECTION FACTOR (dB/m)
1	5150.00	63.25 PK	74.00	-10.75	2.62 V	85	54.78	8.47
2	5150.00	44.87 AV	54.00	-9.13	2.62 V	85	36.40	8.47
3	*5180.00	104.84 PK			2.62 V	85	96.32	8.52
4	*5180.00	92.69 AV			2.62 V	85	84.17	8.52
5	#10360.00	55.88 PK	74.00	-18.12	1.20 V	220	35.65	20.23
6	#10360.00	42.01 AV	54.00	-11.99	1.20 V	220	21.78	20.23
7	15540.00	61.22 PK	74.00	-12.78	1.00 V	210	38.53	22.69
8	15540.00	45.25 AV	54.00	-8.75	1.00 V	210	22.56	22.69

REMARKS:

1. Emission level (dBuV/m) = Raw Value (dBuV) + Correction Factor (dB/m).
2. Correction Factor (dB/m) = Antenna Factor (dB/m) + Cable Factor (dB).
3. The other emission levels were very low against the limit.
4. Margin value = Emission level – Limit value.
5. " * ": Fundamental frequency.
6. " # ": The radiated frequency is out of the restricted band.



CHANNEL	TX Channel 44	DETECTOR FUNCTION	Peak (PK)
FREQUENCY RANGE	1GHz ~ 40GHz		Average (AV)

ANTENNA POLARITY & TEST DISTANCE: HORIZONTAL AT 3 M

NO.	FREQ. (MHz)	EMISSION LEVEL (dBuV/m)	LIMIT (dBuV/m)	MARGIN (dB)	ANTENNA HEIGHT (m)	TABLE ANGLE (Degree)	RAW VALUE (dBuV)	CORRECTION FACTOR (dB/m)
1	*5220.00	108.89 PK			1.90 H	287	100.31	8.58
2	*5220.00	96.55 AV			1.90 H	287	87.97	8.58
3	#10440.00	55.69 PK	74.00	-18.31	1.55 H	211	35.39	20.30
4	#10440.00	43.22 AV	54.00	-10.78	1.55 H	211	22.92	20.30
5	15660.00	62.22 PK	74.00	-11.78	1.00 H	21	39.44	22.78
6	15660.00	47.93 AV	54.00	-6.07	1.00 H	21	25.15	22.78

ANTENNA POLARITY & TEST DISTANCE: VERTICAL AT 3 M

NO.	FREQ. (MHz)	EMISSION LEVEL (dBuV/m)	LIMIT (dBuV/m)	MARGIN (dB)	ANTENNA HEIGHT (m)	TABLE ANGLE (Degree)	RAW VALUE (dBuV)	CORRECTION FACTOR (dB/m)
1	*5220.00	103.21 PK			2.26 V	79	94.63	8.58
2	*5220.00	92.03 AV			2.26 V	79	83.45	8.58
3	#10440.00	57.95 PK	74.00	-16.05	1.50 V	21	37.65	20.30
4	#10440.00	43.25 AV	54.00	-10.75	1.50 V	21	22.95	20.30
5	15660.00	62.01 PK	74.00	-11.99	1.00 V	250	39.23	22.78
6	15660.00	48.25 AV	54.00	-5.75	1.00 V	250	25.47	22.78

REMARKS:

1. Emission level (dBuV/m) = Raw Value (dBuV) + Correction Factor (dB/m).
2. Correction Factor (dB/m) = Antenna Factor (dB/m) + Cable Factor (dB).
3. The other emission levels were very low against the limit.
4. Margin value = Emission level – Limit value.
5. " * ": Fundamental frequency.
6. " # ": The radiated frequency is out of the restricted band.



CHANNEL	TX Channel 48	DETECTOR FUNCTION	Peak (PK)
FREQUENCY RANGE	1GHz ~ 40GHz		Average (AV)

ANTENNA POLARITY & TEST DISTANCE: HORIZONTAL AT 3 M

NO.	FREQ. (MHz)	EMISSION LEVEL (dBuV/m)	LIMIT (dBuV/m)	MARGIN (dB)	ANTENNA HEIGHT (m)	TABLE ANGLE (Degree)	RAW VALUE (dBuV)	CORRECTION FACTOR (dB/m)
1	*5240.00	108.22 PK			1.86 H	287	99.62	8.60
2	*5240.00	98.69 AV			1.86 H	287	90.09	8.60
3	#10480.00	58.78 PK	74.00	-15.22	1.55 H	210	38.44	20.34
4	#10480.00	44.87 AV	54.00	-9.13	1.55 H	210	24.53	20.34
5	15720.00	62.58 PK	74.00	-11.42	1.20 H	51	39.76	22.82
6	15720.00	47.98 AV	54.00	-6.02	1.20 H	51	25.16	22.82

ANTENNA POLARITY & TEST DISTANCE: VERTICAL AT 3 M

NO.	FREQ. (MHz)	EMISSION LEVEL (dBuV/m)	LIMIT (dBuV/m)	MARGIN (dB)	ANTENNA HEIGHT (m)	TABLE ANGLE (Degree)	RAW VALUE (dBuV)	CORRECTION FACTOR (dB/m)
1	*5240.00	103.23 PK			1.33 V	216	94.63	8.60
2	*5240.00	94.02 AV			1.33 V	216	85.42	8.60
3	#10480.00	57.21 PK	74.00	-16.79	1.50 V	210	36.87	20.34
4	#10480.00	44.56 AV	54.00	-9.44	1.50 V	210	24.22	20.34
5	15720.00	62.77 PK	74.00	-11.23	1.55 V	210	39.95	22.82
6	15720.00	46.97 AV	54.00	-7.03	1.55 V	210	24.15	22.82

REMARKS:

1. Emission level (dBuV/m) = Raw Value (dBuV) + Correction Factor (dB/m).
2. Correction Factor (dB/m) = Antenna Factor (dB/m) + Cable Factor (dB).
3. The other emission levels were very low against the limit.
4. Margin value = Emission level – Limit value.
5. " * ": Fundamental frequency.
6. " # ": The radiated frequency is out of the restricted band.



802.11n (20MHz)

CHANNEL	TX Channel 36	DETECTOR FUNCTION	Peak (PK)
FREQUENCY RANGE	1GHz ~ 40GHz		Average (AV)

ANTENNA POLARITY & TEST DISTANCE: HORIZONTAL AT 3 M

NO.	FREQ. (MHz)	EMISSION LEVEL (dBuV/m)	LIMIT (dBuV/m)	MARGIN (dB)	ANTENNA HEIGHT (m)	TABLE ANGLE (Degree)	RAW VALUE (dBuV)	CORRECTION FACTOR (dB/m)
1	5150.00	65.34 PK	74.00	-8.66	2.01 H	287	56.87	8.47
2	5150.00	49.31 AV	54.00	-4.69	2.01 H	287	40.84	8.47
3	*5180.00	107.22 PK			2.01 H	287	98.70	8.52
4	*5180.00	97.12 AV			2.01 H	287	88.60	8.52
5	#10360.00	56.22 PK	74.00	-17.78	1.55 H	21	35.99	20.23
6	#10360.00	42.31 AV	54.00	-11.69	1.55 H	21	22.08	20.23
7	15540.00	62.45 PK	74.00	-11.55	1.80 H	100	39.76	22.69
8	15540.00	47.02 AV	54.00	-6.98	1.80 H	100	24.33	22.69

ANTENNA POLARITY & TEST DISTANCE: VERTICAL AT 3 M

NO.	FREQ. (MHz)	EMISSION LEVEL (dBuV/m)	LIMIT (dBuV/m)	MARGIN (dB)	ANTENNA HEIGHT (m)	TABLE ANGLE (Degree)	RAW VALUE (dBuV)	CORRECTION FACTOR (dB/m)
1	5150.00	58.42 PK	74.00	-15.58	2.24 V	81	49.95	8.47
2	5150.00	40.55 AV	54.00	-13.45	2.24 V	81	32.08	8.47
3	*5180.00	101.76 PK			2.24 V	81	93.24	8.52
4	*5180.00	92.72 AV			2.24 V	81	84.20	8.52
5	#10360.00	58.22 PK	74.00	-15.78	1.55 V	219	37.99	20.23
6	#10360.00	44.98 AV	54.00	-9.02	1.55 V	219	24.75	20.23
7	15540.00	62.55 PK	74.00	-11.45	1.45 V	320	39.86	22.69
8	15540.00	47.88 AV	54.00	-6.12	1.45 V	320	25.19	22.69

REMARKS:

1. Emission level (dBuV/m) = Raw Value (dBuV) + Correction Factor (dB/m).
2. Correction Factor (dB/m) = Antenna Factor (dB/m) + Cable Factor (dB).
3. The other emission levels were very low against the limit.
4. Margin value = Emission level – Limit value.
5. " * ": Fundamental frequency.
6. " # ": The radiated frequency is out of the restricted band.



CHANNEL	TX Channel 44	DETECTOR FUNCTION	Peak (PK)
FREQUENCY RANGE	1GHz ~ 40GHz		Average (AV)

ANTENNA POLARITY & TEST DISTANCE: HORIZONTAL AT 3 M

NO.	FREQ. (MHz)	EMISSION LEVEL (dBuV/m)	LIMIT (dBuV/m)	MARGIN (dB)	ANTENNA HEIGHT (m)	TABLE ANGLE (Degree)	RAW VALUE (dBuV)	CORRECTION FACTOR (dB/m)
1	*5220.00	107.08 PK			1.49 H	285	98.50	8.58
2	*5220.00	94.28 AV			1.49 H	285	85.70	8.58
3	#10440.00	50.63 PK	74.00	-23.37	1.95 H	332	30.33	20.30
4	#10440.00	43.35 AV	54.00	-10.65	1.95 H	332	23.05	20.30
5	15660.00	57.63 PK	74.00	-16.37	1.49 H	246	34.85	22.78
6	15660.00	46.96 AV	54.00	-7.04	1.49 H	246	24.18	22.78

ANTENNA POLARITY & TEST DISTANCE: VERTICAL AT 3 M

NO.	FREQ. (MHz)	EMISSION LEVEL (dBuV/m)	LIMIT (dBuV/m)	MARGIN (dB)	ANTENNA HEIGHT (m)	TABLE ANGLE (Degree)	RAW VALUE (dBuV)	CORRECTION FACTOR (dB/m)
1	*5220.00	101.67 PK			1.31 V	218	93.09	8.58
2	*5220.00	90.03 AV			1.31 V	218	81.45	8.58
3	#10440.00	52.33 PK	74.00	-21.67	1.95 V	230	32.03	20.30
4	#10440.00	43.26 AV	54.00	-10.74	1.95 V	230	22.96	20.30
5	15660.00	58.42 PK	74.00	-15.58	1.28 V	253	35.64	22.78
6	15660.00	47.33 AV	54.00	-6.67	1.28 V	253	24.55	22.78

REMARKS:

1. Emission level (dBuV/m) = Raw Value (dBuV) + Correction Factor (dB/m).
2. Correction Factor (dB/m) = Antenna Factor (dB/m) + Cable Factor (dB).
3. The other emission levels were very low against the limit.
4. Margin value = Emission level – Limit value.
5. " * ": Fundamental frequency.
6. " # ": The radiated frequency is out of the restricted band.



CHANNEL	TX Channel 48	DETECTOR FUNCTION	Peak (PK)
FREQUENCY RANGE	1GHz ~ 40GHz		Average (AV)

ANTENNA POLARITY & TEST DISTANCE: HORIZONTAL AT 3 M

NO.	FREQ. (MHz)	EMISSION LEVEL (dBuV/m)	LIMIT (dBuV/m)	MARGIN (dB)	ANTENNA HEIGHT (m)	TABLE ANGLE (Degree)	RAW VALUE (dBuV)	CORRECTION FACTOR (dB/m)
1	*5240.00	106.89 PK			1.75 H	148	98.29	8.60
2	*5240.00	94.78 AV			1.75 H	148	86.18	8.60
3	#10480.00	54.13 PK	74.00	-19.87	1.88 H	263	33.79	20.34
4	#10480.00	42.23 AV	54.00	-11.77	1.88 H	263	21.89	20.34
5	15720.00	55.26 PK	74.00	-18.74	1.94 H	302	32.44	22.82
6	15720.00	47.33 AV	54.00	-6.67	1.94 H	302	24.51	22.82

ANTENNA POLARITY & TEST DISTANCE: VERTICAL AT 3 M

NO.	FREQ. (MHz)	EMISSION LEVEL (dBuV/m)	LIMIT (dBuV/m)	MARGIN (dB)	ANTENNA HEIGHT (m)	TABLE ANGLE (Degree)	RAW VALUE (dBuV)	CORRECTION FACTOR (dB/m)
1	*5240.00	101.56 PK			1.77 V	263	92.96	8.60
2	*5240.00	89.53 AV			1.77 V	263	80.93	8.60
3	#10480.00	53.67 PK	74.00	-20.33	1.56 V	275	33.33	20.34
4	#10480.00	43.62 AV	54.00	-10.38	1.56 V	275	23.28	20.34
5	15720.00	56.98 PK	74.00	-17.02	1.87 V	235	34.16	22.82
6	15720.00	47.53 AV	54.00	-6.47	1.87 V	235	24.71	22.82

REMARKS:

1. Emission level (dBuV/m) = Raw Value (dBuV) + Correction Factor (dB/m).
2. Correction Factor (dB/m) = Antenna Factor (dB/m) + Cable Factor (dB).
3. The other emission levels were very low against the limit.
4. Margin value = Emission level – Limit value.
5. " * ": Fundamental frequency.
6. " # ": The radiated frequency is out of the restricted band.



802.11n (40MHz)

CHANNEL	TX Channel 38	DETECTOR FUNCTION	Peak (PK)
FREQUENCY RANGE	1GHz ~ 40GHz		Average (AV)

ANTENNA POLARITY & TEST DISTANCE: HORIZONTAL AT 3 M

NO.	FREQ. (MHz)	EMISSION LEVEL (dBuV/m)	LIMIT (dBuV/m)	MARGIN (dB)	ANTENNA HEIGHT (m)	TABLE ANGLE (Degree)	RAW VALUE (dBuV)	CORRECTION FACTOR (dB/m)
1	5150.00	72.98 PK	74.00	-1.02	1.49 H	230	29.32	43.66
2	5150.00	52.63 AV	54.00	-1.37	1.49 H	230	8.97	43.66
3	*5190.00	101.87 PK			1.49 H	230	58.12	43.75
4	*5190.00	87.69 AV			1.49 H	230	43.94	43.75
5	#10380.00	52.60 PK	74.00	-21.40	1.62 H	95	-0.82	53.42
6	#10380.00	41.58 AV	54.00	-12.42	1.62 H	95	-11.84	53.42
7	15570.00	59.92 PK	74.00	-14.08	1.42 H	285	5.51	54.41
8	15570.00	47.32 AV	54.00	-6.68	1.42 H	285	-7.09	54.41

ANTENNA POLARITY & TEST DISTANCE: VERTICAL AT 3 M

NO.	FREQ. (MHz)	EMISSION LEVEL (dBuV/m)	LIMIT (dBuV/m)	MARGIN (dB)	ANTENNA HEIGHT (m)	TABLE ANGLE (Degree)	RAW VALUE (dBuV)	CORRECTION FACTOR (dB/m)
1	5150.00	72.84 PK	74.00	-1.16	1.48 V	233	29.18	43.66
2	5150.00	52.43 AV	54.00	-1.57	1.48 V	233	8.77	43.66
3	*5190.00	96.65 PK			1.48 V	233	52.90	43.75
4	*5190.00	84.22 AV			1.48 V	233	40.47	43.75
5	#10380.00	54.07 PK	74.00	-19.93	1.16 V	253	0.65	53.42
6	#10380.00	41.77 AV	54.00	-12.23	1.16 V	253	-11.65	53.42
7	15570.00	59.68 PK	74.00	-14.32	1.03 V	223	5.27	54.41
8	15570.00	46.95 AV	54.00	-7.05	1.03 V	223	-7.46	54.41

REMARKS:

1. Emission level (dBuV/m) = Raw Value (dBuV) + Correction Factor (dB/m).
2. Correction Factor (dB/m) = Antenna Factor (dB/m) + Cable Factor (dB).
3. The other emission levels were very low against the limit.
4. Margin value = Emission level – Limit value.
5. " * ": Fundamental frequency.
6. " # ": The radiated frequency is out of the restricted band.



CHANNEL	TX Channel 46	DETECTOR FUNCTION	Peak (PK)
FREQUENCY RANGE	1GHz ~ 40GHz		Average (AV)

ANTENNA POLARITY & TEST DISTANCE: HORIZONTAL AT 3 M

NO.	FREQ. (MHz)	EMISSION LEVEL (dBuV/m)	LIMIT (dBuV/m)	MARGIN (dB)	ANTENNA HEIGHT (m)	TABLE ANGLE (Degree)	RAW VALUE (dBuV)	CORRECTION FACTOR (dB/m)
1	*5230.00	103.73 PK			1.16 H	201	95.14	8.59
2	*5230.00	89.64 AV			1.16 H	201	81.05	8.59
3	#10460.00	54.42 PK	74.00	-19.58	1.49 H	285	34.10	20.32
4	#10460.00	44.33 AV	54.00	-9.67	1.49 H	285	24.01	20.32
5	15690.00	59.13 PK	74.00	-14.87	1.44 H	334	36.33	22.80
6	15690.00	47.07 AV	54.00	-6.93	1.44 H	334	24.27	22.80

ANTENNA POLARITY & TEST DISTANCE: VERTICAL AT 3 M

NO.	FREQ. (MHz)	EMISSION LEVEL (dBuV/m)	LIMIT (dBuV/m)	MARGIN (dB)	ANTENNA HEIGHT (m)	TABLE ANGLE (Degree)	RAW VALUE (dBuV)	CORRECTION FACTOR (dB/m)
1	*5230.00	98.54 PK			1.48 V	243	89.95	8.59
2	*5230.00	87.90 AV			1.48 V	243	79.31	8.59
3	#10460.00	54.18 PK	74.00	-19.82	1.56 V	230	33.86	20.32
4	#10460.00	41.95 AV	54.00	-12.05	1.56 V	230	21.63	20.32
5	15690.00	56.85 PK	74.00	-17.15	1.49 V	248	34.05	22.80
6	15690.00	45.80 AV	54.00	-8.20	1.49 V	248	23.00	22.80

REMARKS:

1. Emission level (dBuV/m) = Raw Value (dBuV) + Correction Factor (dB/m).
2. Correction Factor (dB/m) = Antenna Factor (dB/m) + Cable Factor (dB).
3. The other emission levels were very low against the limit.
4. Margin value = Emission level – Limit value.
5. " * ": Fundamental frequency.
6. " # ": The radiated frequency is out of the restricted band.



Band 4 (5745-5825MHz):

ABOVE 1GHz DATA

802.11a

CHANNEL	TX Channel 149	DETECTOR FUNCTION	Peak (PK)
FREQUENCY RANGE	1GHz ~ 40GHz		Average (AV)

ANTENNA POLARITY & TEST DISTANCE: HORIZONTAL AT 3 M								
NO.	FREQ. (MHz)	EMISSION LEVEL (dBuV/m)	LIMIT (dBuV/m)	MARGIN (dB)	ANTENNA HEIGHT (m)	TABLE ANGLE (Degree)	RAW VALUE (dBuV)	CORRECTION FACTOR (dB/m)
1	#5650.00	44.94 PK	68.2	-23.26	1.64 H	252	35.14	9.80
2	#5700.00	59.05 PK	105.2	-46.15	1.64 H	252	48.98	10.07
3	#5720.00	65.40 PK	110.8	-45.40	1.64 H	252	55.22	10.18
4	#5725.00	68.20 PK	122.2	-54.0	1.64 H	252	58.00	10.20
5	*5745.00	102.81 PK			1.64 H	252	92.50	10.31
6	*5745.00	90.87 AV			1.64 H	252	80.56	10.31
7	11490.00	53.64 PK	74.00	-20.36	1.75 H	280	34.34	19.30
8	11490.00	40.10 AV	54.00	-13.90	1.75 H	280	20.80	19.30
9	#17235.00	61.62 PK	74.00	-12.38	1.46 H	302	35.85	25.77
10	#17235.00	49.12 AV	54.00	-4.88	1.46 H	302	23.35	25.77

ANTENNA POLARITY & TEST DISTANCE: VERTICAL AT 3 M								
NO.	FREQ. (MHz)	EMISSION LEVEL (dBuV/m)	LIMIT (dBuV/m)	MARGIN (dB)	ANTENNA HEIGHT (m)	TABLE ANGLE (Degree)	RAW VALUE (dBuV)	CORRECTION FACTOR (dB/m)
1	#5650.00	34.63 PK	68.2	-33.57	1.54 V	210	24.83	9.80
2	#5700.00	45.94 PK	105.2	-59.26	1.54 V	210	35.87	10.07
3	#5720.00	53.29 PK	110.8	-57.51	1.54 V	210	43.11	10.18
4	#5725.00	57.65 PK	122.2	-64.55	1.54 V	210	47.45	10.20
5	*5745.00	102.34 PK			1.54 V	210	92.03	10.31
6	*5745.00	90.67 AV			1.54 V	210	80.36	10.31
7	11490.00	53.64 PK	74.00	-20.36	2.63 V	249	34.34	19.30
8	11490.00	40.57 AV	54.00	-13.43	2.63 V	249	21.27	19.30
9	#17235.00	62.45 PK	74.00	-11.55	1.64 V	201	36.68	25.77
10	#17235.00	48.88 AV	54.00	-5.12	1.64 V	201	23.11	25.77

REMARKS:

1. Emission level (dBuV/m) = Raw Value (dBuV) + Correction Factor (dB/m).
2. Correction Factor (dB/m) = Antenna Factor (dB/m) + Cable Factor (dB).
3. The other emission levels were very low against the limit.
4. Margin value = Emission level – Limit value.
5. " * ": Fundamental frequency.
6. " # ": The radiated frequency is out of the restricted band.



CHANNEL	TX Channel 157	DETECTOR FUNCTION	Peak (PK)
FREQUENCY RANGE	1GHz ~ 40GHz		Average (AV)

ANTENNA POLARITY & TEST DISTANCE: HORIZONTAL AT 3 M

NO.	FREQ. (MHz)	EMISSION LEVEL (dBuV/m)	LIMIT (dBuV/m)	MARGIN (dB)	ANTENNA HEIGHT (m)	TABLE ANGLE (Degree)	RAW VALUE (dBuV)	CORRECTION FACTOR (dB/m)
1	*5785.00	102.73 PK			1.46 H	203	92.20	10.53
2	*5785.00	91.50 AV			1.46 H	203	80.97	10.53
3	11570.00	51.32 PK	74.00	-22.68	1.49 H	256	32.07	19.25
4	11570.00	40.62 AV	54.00	-13.38	1.49 H	256	21.37	19.25
5	#17355.00	58.20 PK	74.00	-15.80	2.05 H	315	32.36	25.84
6	#17355.00	49.27 AV	54.00	-4.73	2.05 H	315	23.43	25.84

ANTENNA POLARITY & TEST DISTANCE: VERTICAL AT 3 M

NO.	FREQ. (MHz)	EMISSION LEVEL (dBuV/m)	LIMIT (dBuV/m)	MARGIN (dB)	ANTENNA HEIGHT (m)	TABLE ANGLE (Degree)	RAW VALUE (dBuV)	CORRECTION FACTOR (dB/m)
1	*5785.00	102.12 PK			1.40 V	214	91.59	10.53
2	*5785.00	90.09 AV			1.40 V	214	79.56	10.53
3	11570.00	48.62 PK	74.00	-25.38	1.96 V	148	29.37	19.25
4	11570.00	41.58 AV	54.00	-12.42	1.96 V	148	22.33	19.25
5	#17355.00	59.74 PK	74.00	-14.26	2.16 V	253	33.90	25.84
6	#17355.00	48.82 AV	54.00	-5.18	2.16 V	253	22.98	25.84

REMARKS:

1. Emission level (dBuV/m) = Raw Value (dBuV) + Correction Factor (dB/m).
2. Correction Factor (dB/m) = Antenna Factor (dB/m) + Cable Factor (dB).
3. The other emission levels were very low against the limit.
4. Margin value = Emission level – Limit value.
5. " * ": Fundamental frequency.
6. " # ": The radiated frequency is out of the restricted band.



CHANNEL	TX Channel 165	DETECTOR FUNCTION	Peak (PK)
FREQUENCY RANGE	1GHz ~ 40GHz		Average (AV)

ANTENNA POLARITY & TEST DISTANCE: HORIZONTAL AT 3 M								
NO.	FREQ. (MHz)	EMISSION LEVEL (dBuV/m)	LIMIT (dBuV/m)	MARGIN (dB)	ANTENNA HEIGHT (m)	TABLE ANGLE (Degree)	RAW VALUE (dBuV)	CORRECTION FACTOR (dB/m)
1	*5825.00	104.46 PK			1.50 H	75	93.71	10.75
2	*5825.00	92.72 AV			1.50 H	75	81.97	10.75
3	#5850.00	69.28 PK	122.2	-52.92	1.50 H	75	58.40	10.88
4	#5855.00	69.23 PK	110.8	-41.57	1.50 H	75	58.33	10.90
5	#5875.00	59.76 PK	105.2	-45.44	1.50 H	75	48.75	11.01
6	#5925.00	47.64 PK	68.2	-20.56	1.50 H	0	36.36	11.28
7	11650.00	53.72 PK	74.00	-20.28	1.85 H	206	34.48	19.24
8	11650.00	41.15 AV	54.00	-12.85	1.85 H	206	21.91	19.24
9	#17475.00	62.24 PK	74.00	-11.76	2.15 H	325	36.34	25.90
10	#17475.00	48.47 AV	54.00	-5.53	2.15 H	325	22.57	25.90
ANTENNA POLARITY & TEST DISTANCE: VERTICAL AT 3 M								
NO.	FREQ. (MHz)	EMISSION LEVEL (dBuV/m)	LIMIT (dBuV/m)	MARGIN (dB)	ANTENNA HEIGHT (m)	TABLE ANGLE (Degree)	RAW VALUE (dBuV)	CORRECTION FACTOR (dB/m)
1	*5825.00	103.57 PK			1.19 V	302	92.82	10.75
2	*5825.00	91.40 AV			1.19 V	302	80.65	10.75
3	#5850.00	68.46 PK	122.2	-53.74	1.19 V	302	57.58	10.88
4	#5855.00	66.64 PK	110.8	-44.16	1.19 V	302	55.74	10.90
5	#5875.00	65.30 PK	105.2	-39.9	1.19 V	302	54.29	11.01
6	#5925.00	47.11 PK	68.2	-21.09	1.19 V	302	35.83	11.28
7	11650.00	52.67 PK	74.00	-21.33	1.49 V	203	33.43	19.24
8	11650.00	40.26 AV	54.00	-13.74	1.49 V	203	21.02	19.24
9	#17475.00	58.94 PK	74.00	-15.06	1.54 V	206	33.04	25.90
10	#17475.00	49.06 AV	54.00	-4.94	1.54 V	206	23.16	25.90

REMARKS:

1. Emission level (dBuV/m) = Raw Value (dBuV) + Correction Factor (dB/m).
2. Correction Factor (dB/m) = Antenna Factor (dB/m) + Cable Factor (dB).
3. The other emission levels were very low against the limit.
4. Margin value = Emission level – Limit value.
5. " * ": Fundamental frequency.
6. " # ": The radiated frequency is out of the restricted band.



802.11n (20MHz)

CHANNEL	TX Channel 149	DETECTOR FUNCTION	Peak (PK)
FREQUENCY RANGE	1GHz ~ 40GHz		Average (AV)

ANTENNA POLARITY & TEST DISTANCE: HORIZONTAL AT 3 M

NO.	FREQ. (MHz)	EMISSION LEVEL (dBuV/m)	LIMIT (dBuV/m)	MARGIN (dB)	ANTENNA HEIGHT (m)	TABLE ANGLE (Degree)	RAW VALUE (dBuV)	CORRECTION FACTOR (dB/m)
1	#5650.00	44.96 PK	68.2	-23.24	2.39 H	290	35.16	9.80
2	#5700.00	53.62 PK	105.2	-51.58	2.39 H	290	43.55	10.07
3	#5720.00	64.59 PK	110.8	-46.21	2.39 H	290	54.41	10.18
4	#5725.00	67.41 PK	122.2	-54.79	2.39 H	290	57.21	10.20
5	*5745.00	101.13 PK			2.39 H	290	90.82	10.31
6	*5745.00	89.36 AV			2.39 H	290	79.05	10.31
7	11490.00	64.50 PK	74.00	-9.50	1.50 H	211	45.20	19.30
8	11490.00	42.90 AV	54.00	-11.10	1.50 H	211	23.60	19.30
9	#17235.00	64.44 PK	74.00	-9.56	1.55 H	241	38.67	25.77
10	#17235.00	50.18 AV	54.00	-3.82	1.55 H	241	24.41	25.77

ANTENNA POLARITY & TEST DISTANCE: VERTICAL AT 3 M

NO.	FREQ. (MHz)	EMISSION LEVEL (dBuV/m)	LIMIT (dBuV/m)	MARGIN (dB)	ANTENNA HEIGHT (m)	TABLE ANGLE (Degree)	RAW VALUE (dBuV)	CORRECTION FACTOR (dB/m)
1	#5650.00	44.88 PK	68.2	-23.32	2.26 V	268	35.08	9.80
2	#5700.00	54.68 PK	105.2	-50.52	2.26 V	268	44.61	10.07
3	#5720.00	62.58 PK	110.8	-48.22	2.26 V	268	52.40	10.18
4	#5725.00	64.32 PK	122.2	-57.88	2.26 V	268	54.12	10.20
5	*5745.00	100.26 PK			2.26 V	268	89.95	10.31
6	*5745.00	88.21 AV			2.26 V	268	77.90	10.31
7	11490.00	58.25 PK	74.00	-15.75	1.77 V	41	38.95	19.30
8	11490.00	44.94 AV	54.00	-9.06	1.77 V	41	25.64	19.30
9	#17235.00	65.66 PK	74.00	-8.34	1.55 V	84	39.89	25.77
10	#17235.00	50.25 AV	54.00	-3.75	1.55 V	84	24.48	25.77

REMARKS:

1. Emission level (dBuV/m) = Raw Value (dBuV) + Correction Factor (dB/m).
2. Correction Factor (dB/m) = Antenna Factor (dB/m) + Cable Factor (dB).
3. The other emission levels were very low against the limit.
4. Margin value = Emission level – Limit value.
5. " * " : Fundamental frequency.
6. " # " : The radiated frequency is out of the restricted band.



CHANNEL	TX Channel 157	DETECTOR FUNCTION	Peak (PK)
FREQUENCY RANGE	1GHz ~ 40GHz		Average (AV)

ANTENNA POLARITY & TEST DISTANCE: HORIZONTAL AT 3 M

NO.	FREQ. (MHz)	EMISSION LEVEL (dBuV/m)	LIMIT (dBuV/m)	MARGIN (dB)	ANTENNA HEIGHT (m)	TABLE ANGLE (Degree)	RAW VALUE (dBuV)	CORRECTION FACTOR (dB/m)
1	*5785.00	101.21 PK			1.81 H	291	90.68	10.53
2	*5785.00	89.55 AV			1.81 H	291	79.02	10.53
3	11570.00	63.55 PK	74.00	-10.45	1.88 H	54	44.30	19.25
4	11570.00	44.59 AV	54.00	-9.41	1.88 H	54	25.34	19.25
5	#17355.00	64.25 PK	74.00	-9.75	1.52 H	69	38.41	25.84
6	#17355.00	50.25 AV	54.00	-3.75	1.52 H	69	24.41	25.84

ANTENNA POLARITY & TEST DISTANCE: VERTICAL AT 3 M

NO.	FREQ. (MHz)	EMISSION LEVEL (dBuV/m)	LIMIT (dBuV/m)	MARGIN (dB)	ANTENNA HEIGHT (m)	TABLE ANGLE (Degree)	RAW VALUE (dBuV)	CORRECTION FACTOR (dB/m)
1	*5785.00	100.68 PK			2.33 V	267	90.15	10.53
2	*5785.00	89.02 AV			2.33 V	267	78.49	10.53
3	11570.00	62.25 PK	74.00	-11.75	1.55 V	250	43.00	19.25
4	11570.00	44.66 AV	54.00	-9.34	1.55 V	250	25.41	19.25
5	#17355.00	64.25 PK	74.00	-9.75	1.00 V	288	38.41	25.84
6	#17355.00	47.88 AV	54.00	-6.12	1.00 V	288	22.04	25.84

REMARKS:

1. Emission level (dBuV/m) = Raw Value (dBuV) + Correction Factor (dB/m).
2. Correction Factor (dB/m) = Antenna Factor (dB/m) + Cable Factor (dB).
3. The other emission levels were very low against the limit.
4. Margin value = Emission level – Limit value.
5. " * ": Fundamental frequency.
6. " # ": The radiated frequency is out of the restricted band.



CHANNEL	TX Channel 165	DETECTOR FUNCTION	Peak (PK)
FREQUENCY RANGE	1GHz ~ 40GHz		Average (AV)

ANTENNA POLARITY & TEST DISTANCE: HORIZONTAL AT 3 M

NO.	FREQ. (MHz)	EMISSION LEVEL (dBuV/m)	LIMIT (dBuV/m)	MARGIN (dB)	ANTENNA HEIGHT (m)	TABLE ANGLE (Degree)	RAW VALUE (dBuV)	CORRECTION FACTOR (dB/m)
1	*5825.00	103.86 PK			1.84 H	296	93.11	10.75
2	*5825.00	92.25 AV			1.84 H	296	81.50	10.75
3	#5850.00	67.87 PK	122.2	-54.33	1.84 H	296	56.99	10.88
4	#5855.00	64.59 PK	110.8	-46.21	1.84 H	296	53.69	10.90
5	#5875.00	56.69 PK	105.2	-48.51	1.84 H	296	45.68	11.01
6	#5925.00	47.58 PK	68.2	-20.62	1.84 H	296	36.30	11.28
7	11650.00	57.55 PK	74.00	-16.45	1.88 H	54	38.31	19.24
8	11650.00	49.23 AV	54.00	-4.77	1.88 H	54	29.99	19.24
9	#17475.00	64.66 PK	74.00	-9.34	1.85 H	126	38.76	25.90
10	#17475.00	49.25 AV	54.00	-4.75	1.85 H	126	23.35	25.90

ANTENNA POLARITY & TEST DISTANCE: VERTICAL AT 3 M

NO.	FREQ. (MHz)	EMISSION LEVEL (dBuV/m)	LIMIT (dBuV/m)	MARGIN (dB)	ANTENNA HEIGHT (m)	TABLE ANGLE (Degree)	RAW VALUE (dBuV)	CORRECTION FACTOR (dB/m)
1	*5825.00	100.99 PK			2.30 V	266	90.24	10.75
2	*5825.00	90.11 AV			2.30 V	266	79.36	10.75
3	#5850.00	63.12 PK	122.2	-59.08	2.30 V	266	52.24	10.88
4	#5855.00	63.64 PK	110.8	-47.16	2.30 V	266	52.74	10.90
5	#5875.00	56.28 PK	105.2	-48.92	2.30 V	266	45.27	11.01
6	#5925.00	47.26 PK	68.2	-20.94	2.30 V	266	35.98	11.28
7	11650.00	56.59 PK	74.00	-17.41	1.58 V	320	37.35	19.24
8	11650.00	42.22 AV	54.00	-11.78	1.58 V	320	22.98	19.24
9	#17475.00	65.26 PK	74.00	-8.74	1.88 V	360	39.36	25.90
10	#17475.00	49.22 AV	54.00	-4.78	1.88 V	360	23.32	25.90

REMARKS:

1. Emission level (dBuV/m) = Raw Value (dBuV) + Correction Factor (dB/m).
2. Correction Factor (dB/m) = Antenna Factor (dB/m) + Cable Factor (dB).
3. The other emission levels were very low against the limit.
4. Margin value = Emission level – Limit value.
5. " * ": Fundamental frequency.
6. " # ": The radiated frequency is out of the restricted band.



802.11n (40MHz)

CHANNEL	TX Channel 151	DETECTOR FUNCTION	Peak (PK)
FREQUENCY RANGE	1GHz ~ 40GHz		Average (AV)

ANTENNA POLARITY & TEST DISTANCE: HORIZONTAL AT 3 M

NO.	FREQ. (MHz)	EMISSION LEVEL (dBuV/m)	LIMIT (dBuV/m)	MARGIN (dB)	ANTENNA HEIGHT (m)	TABLE ANGLE (Degree)	RAW VALUE (dBuV)	CORRECTION FACTOR (dB/m)
1	#5650.00	45.61 PK	68.2	-22.59	1.02 H	325	35.81	9.80
2	#5700.00	59.03 PK	105.2	-46.17	1.02 H	325	48.96	10.07
3	#5720.00	69.51 PK	110.8	-41.29	1.02 H	325	59.33	10.18
4	#5725.00	69.92 PK	122.2	-52.28	1.02 H	325	59.72	10.20
5	*5755.00	99.04 PK			1.02 H	325	88.67	10.37
6	*5755.00	84.99 AV			1.02 H	325	74.62	10.37
7	11510.00	52.87 PK	74.00	-21.13	2.01 H	174	33.61	19.26
8	11510.00	40.54 AV	54.00	-13.46	2.01 H	174	21.28	19.26
9	#17265.00	62.79 PK	74.00	-11.21	1.85 H	205	37.00	25.79
10	#17265.00	49.03 AV	54.00	-4.97	1.85 H	205	23.24	25.79

ANTENNA POLARITY & TEST DISTANCE: VERTICAL AT 3 M

NO.	FREQ. (MHz)	EMISSION LEVEL (dBuV/m)	LIMIT (dBuV/m)	MARGIN (dB)	ANTENNA HEIGHT (m)	TABLE ANGLE (Degree)	RAW VALUE (dBuV)	CORRECTION FACTOR (dB/m)
1	#5650.00	44.22 PK	68.2	-23.98	1.50 V	82	34.42	9.80
2	#5700.00	59.88 PK	105.2	-45.32	1.50 V	82	49.81	10.07
3	#5720.00	69.73 PK	110.8	-41.07	1.50 V	82	59.55	10.18
4	#5725.00	69.82 PK	122.2	-52.38	1.50 V	82	59.62	10.20
5	*5755.00	95.95 PK			1.50 V	82	85.58	10.37
6	*5755.00	83.49 AV			1.50 V	82	73.12	10.37
7	11510.00	54.89 PK	74.00	-19.11	1.85 V	243	35.63	19.26
8	11510.00	40.20 AV	54.00	-13.80	1.85 V	243	20.94	19.26
9	#17265.00	61.68 PK	74.00	-12.32	1.85 V	203	35.89	25.79
10	#17265.00	49.18 AV	54.00	-4.82	1.85 V	203	23.39	25.79

REMARKS:

1. Emission level (dBuV/m) = Raw Value (dBuV) + Correction Factor (dB/m).
2. Correction Factor (dB/m) = Antenna Factor (dB/m) + Cable Factor (dB).
3. The other emission levels were very low against the limit.
4. Margin value = Emission level – Limit value.
5. " * ": Fundamental frequency.
6. " # ": The radiated frequency is out of the restricted band.



CHANNEL	TX Channel 159	DETECTOR FUNCTION	Peak (PK)
FREQUENCY RANGE	1GHz ~ 40GHz		Average (AV)

ANTENNA POLARITY & TEST DISTANCE: HORIZONTAL AT 3 M								
NO.	FREQ. (MHz)	EMISSION LEVEL (dBuV/m)	LIMIT (dBuV/m)	MARGIN (dB)	ANTENNA HEIGHT (m)	TABLE ANGLE (Degree)	RAW VALUE (dBuV)	CORRECTION FACTOR (dB/m)
1	*5795.00	99.84 PK			1.48 H	203	89.26	10.58
2	*5795.00	86.25 AV			1.48 H	203	75.67	10.58
3	#5850.00	61.55 PK	122.2	-60.65	1.48 H	203	50.67	10.88
4	#5855.00	60.42 PK	110.8	-50.38	1.48 H	203	49.52	10.90
5	#5875.00	56.49 PK	105.2	-48.71	1.48 H	203	45.48	11.01
6	#5925.00	44.59 PK	68.2	-23.61	1.48 H	203	33.31	11.28
7	11590.00	53.46 PK	74.00	-20.54	1.82 H	48	34.21	19.25
8	11590.00	40.47 AV	54.00	-13.53	1.82 H	48	21.22	19.25
9	#17385.00	61.66 PK	74.00	-12.34	1.46 H	195	35.81	25.85
10	#17385.00	48.91 AV	54.00	-5.09	1.46 H	195	23.06	25.85
ANTENNA POLARITY & TEST DISTANCE: VERTICAL AT 3 M								
NO.	FREQ. (MHz)	EMISSION LEVEL (dBuV/m)	LIMIT (dBuV/m)	MARGIN (dB)	ANTENNA HEIGHT (m)	TABLE ANGLE (Degree)	RAW VALUE (dBuV)	CORRECTION FACTOR (dB/m)
1	*5795.00	97.75 PK			1.02 V	235	87.17	10.58
2	*5795.00	84.67 AV			1.02 V	235	74.09	10.58
3	#5850.00	61.44 PK	122.2	-60.76	1.02 V	235	50.56	10.88
4	#5855.00	60.58 PK	110.8	-50.22	1.02 V	235	49.68	10.90
5	#5875.00	56.17 PK	105.2	-49.03	1.02 V	235	45.16	11.01
6	#5925.00	50.13 PK	68.2	-18.07	1.02 V	235	38.85	11.28
7	11590.00	53.71 PK	74.00	-20.29	1.25 V	178	34.46	19.25
8	11590.00	41.72 AV	54.00	-12.28	1.25 V	178	22.47	19.25
9	#17385.00	62.24 PK	74.00	-11.76	1.95 V	332	36.39	25.85
10	#17385.00	48.84 AV	54.00	-5.16	1.95 V	332	22.99	25.85

REMARKS:

1. Emission level (dBuV/m) = Raw Value (dBuV) + Correction Factor (dB/m).
2. Correction Factor (dB/m) = Antenna Factor (dB/m) + Cable Factor (dB).
3. The other emission levels were very low against the limit.
4. Margin value = Emission level – Limit value.
5. " * ": Fundamental frequency.
6. " # ": The radiated frequency is out of the restricted band.



3.2 CONDUCTED EMISSION MEASUREMENT

3.2.1 LIMITS OF CONDUCTED EMISSION MEASUREMENT

FREQUENCY OF EMISSION (MHz)	CONDUCTED LIMIT (dB μ V)	
	Quasi-peak	Average
0.15 ~ 0.5	66 to 56	56 to 46
0.5 ~ 5	56	46
5 ~ 30	60	50

- NOTE:**
1. The lower limit shall apply at the transition frequencies.
 2. The limit decreases in line with the logarithm of the frequency in the range of 0.15 to 0.50MHz.
 3. All emanations from a class A/B digital device or system, including any network of conductors and apparatus connected thereto, shall not exceed the level of field strengths specified above.

3.2.2 TEST INSTRUMENTS

Equipment	Manufacturer	Model No.	Serial No.	Last Cal.	Next Cal.
EMI Test Receiver	Rohde&Schwarz	ESR7	101588	Jan. 22,16	Jan. 21,17
Artificial Mains Network	Rohde&Schwarz	ENV216	101173	Mar. 04,16	Mar. 03,17
Artificial Mains Network	Rohde&Schwarz	ESH3-Z5	100317	Apr. 05,16	Apr. 04,17
Voltage probe	SCHWARZBECK	TK 9421	TK 9421-176	Jan. 08,16	Jan. 07,17
Test software	ADT	ADT_Cond_V7.3.7	N/A	N/A	N/A

- NOTE:**
1. The test was performed in shielded room 553.
 2. The calibration interval of the above test instruments is 12 months. And the calibrations are traceable to CEPREI/CHINA, GRGT/CHINA and NIM/CHINA.



3.2.3 TEST PROCEDURES

- a. The EUT was placed 0.4 meters from the conducting wall of the shielded room with EUT being connected to the power mains through a line impedance stabilization network (LISN). Other support units were connected to the power mains through another LISN. The two LISNs provide 50 ohm/ 50uH of coupling impedance for the measuring instrument.
- b. Both lines of the power mains connected to the EUT were checked for maximum conducted interference.
- c. The frequency range from 150kHz to 30MHz was searched. Emission levels under (Limit - 20dB) were not recorded.

NOTE: All modes of operation were investigated and the worst-case emissions are reported.

3.2.4 DEVIATION FROM TEST STANDARD

No deviation.

3.2.5 TEST SETUP

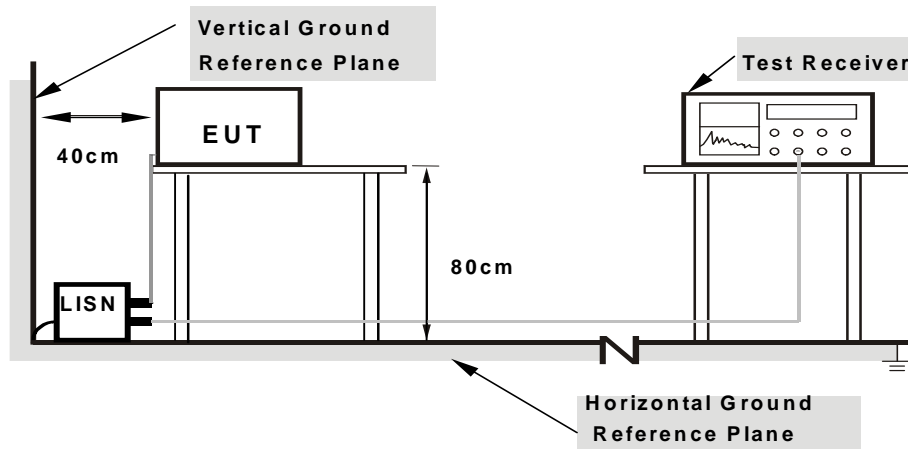

- Note:**
- 1. Support units were connected to second LISN.
 - 2. Both of LISNs (AMN) are 80 cm from EUT and at least 80 cm from other units and other metal planes

For the actual test configuration, please refer to the attached file (Test Setup Photo).

3.2.6 EUT OPERATING CONDITIONS

Same as 3.1.6



3.2.7 TEST RESULTS

CONDUCTED WORST-CASE DATA: WIFI LINK

PHASE	Line	6dB BANDWIDTH	9kHz
--------------	------	----------------------	------

No	Freq. [MHz]	Corr. Factor (dB)	Reading Value [dB (uV)]		Emission Level [dB (uV)]		Limit [dB (uV)]		Margin (dB)	
			Q.P.	AV.	Q.P.	AV.	Q.P.	AV.	Q.P.	AV.
1	0.15000	10.04	34.92	19.11	44.96	29.15	66.00	56.00	-21.04	-26.85
2	0.38362	10.10	30.47	27.75	40.57	37.85	58.20	48.20	-17.63	-10.35
3	0.52109	10.14	36.12	31.10	46.26	41.24	56.00	46.00	-9.74	-4.76
4	0.97800	10.14	26.65	20.36	36.79	30.50	56.00	46.00	-19.21	-15.50
5	1.53023	10.15	27.72	22.48	37.87	32.63	56.00	46.00	-18.13	-13.37
6	2.92425	10.15	23.82	17.67	33.97	27.82	56.00	46.00	-22.03	-18.18

- REMARKS:**
1. Q.P. and AV. are abbreviations of quasi-peak and average individually.
 2. "-": The Quasi-peak reading value also meets average limit and measurement with the average detector is unnecessary.
 3. The emission levels of other frequencies were very low against the limit.
 4. Margin value = Emission level - Limit value
 5. Correction factor = Insertion loss + Cable loss
 6. Emission Level = Correction Factor + Reading Value.

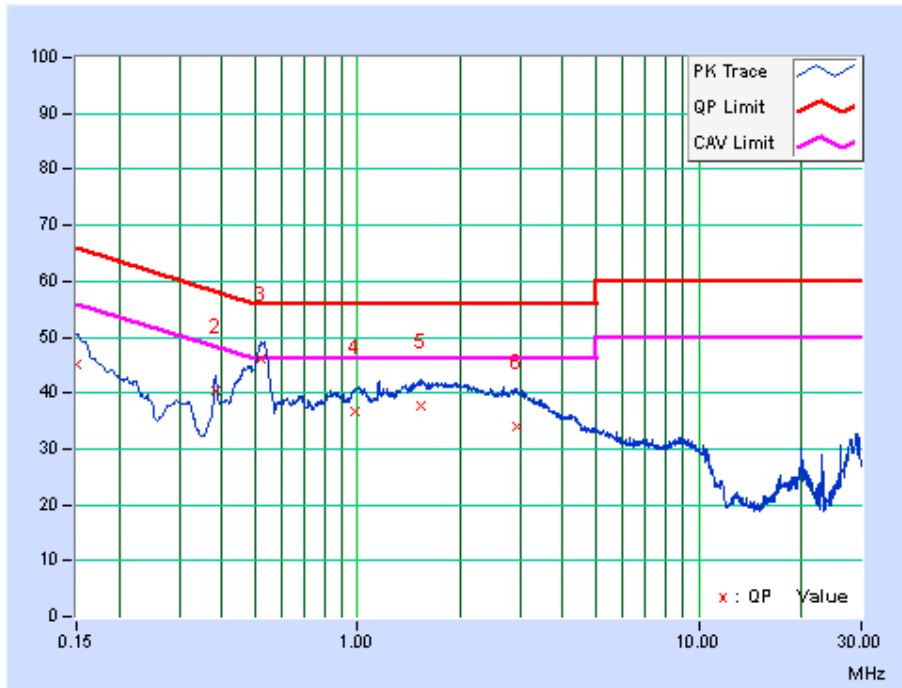



PHASE	Neutral	6dB BANDWIDTH	9kHz
--------------	---------	----------------------	------

No	Freq. [MHz]	Corr. Factor (dB)	Reading Value [dB (uV)]		Emission Level [dB (uV)]		Limit [dB (uV)]		Margin (dB)	
			Q.P.	AV.	Q.P.	AV.	Q.P.	AV.	Q.P.	AV.
1	0.15000	9.84	35.25	19.49	45.09	29.33	66.00	56.00	-20.91	-26.67
2	0.38362	9.84	30.04	27.74	39.88	37.58	58.20	48.20	-18.32	-10.62
3	0.52109	9.84	35.64	30.84	45.48	40.68	56.00	46.00	-10.52	-5.32
4	1.15125	9.84	25.56	22.79	35.40	32.63	56.00	46.00	-20.60	-13.37
5	2.68534	9.87	23.65	17.59	33.52	27.46	56.00	46.00	-22.48	-18.54
6	3.42150	9.90	22.55	16.89	32.45	26.79	56.00	46.00	-23.55	-19.21

- REMARKS:**
1. Q.P. and AV. are abbreviations of quasi-peak and average individually.
 2. "-": The Quasi-peak reading value also meets average limit and measurement with the average detector is unnecessary.
 3. The emission levels of other frequencies were very low against the limit.
 4. Margin value = Emission level - Limit value
 5. Correction factor = Insertion loss + Cable loss
 6. Emission Level = Correction Factor + Reading Value.

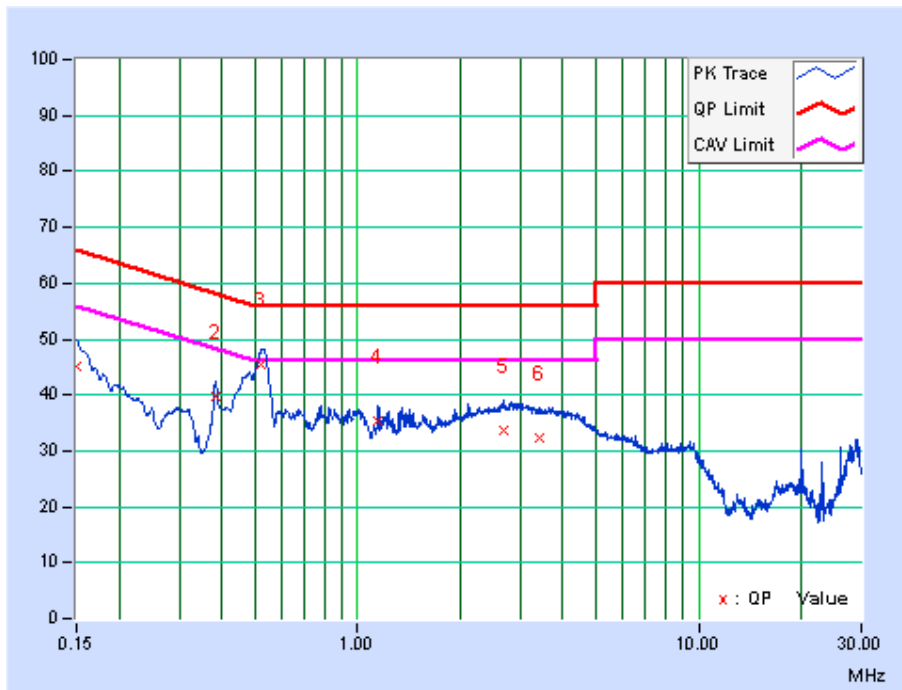



3.3 TRANSMIT POWER MEASUREMENT

3.3.1 LIMITS OF TRANSMIT POWER MEASUREMENT

Operation Band	EUT Category		LIMIT
U-NII-1		Outdoor Access Point	1 Watt (30 dBm) (Max. e.i.r.p \leq 125mW(21 dBm) at any elevation angle above 30 degrees as measured from the horizon)
		Fixed point-to-point Access Point	1 Watt (30 dBm)
		Indoor Access Point	1 Watt (30 dBm)
	√	Mobile and Portable client device	250mW (24 dBm)
U-NII-2A	√		250mW(24dBm) or 11 dBm+10LogB*
U-NII-2C	√		250mW(24dBm) or 11 dBm+10LogB*
U-NII-3	√		1 Watt (30 dBm)

NOTE: 1. Where B is the 26dB emission bandwidth in MHz.

Per KDB 662911 D01 Multiple Transmitter Output v02r01 Method of conducted output power measurement on IEEE 802.11 devices,

- Array Gain = 0 dB (i.e., no array gain) for NANT \leq 4;
- Array Gain = 0 dB (i.e., no array gain) for channel widths \geq 40 MHz for any NANT;
- Array Gain = 5 log(NANT/NSS) dB or 3 dB, whichever is less for 20-MHz channel widths with NANT \geq 5.

For power measurements on all other devices: Array Gain = 10 log(NANT/NSS) dB.

3.3.2 TEST SETUP

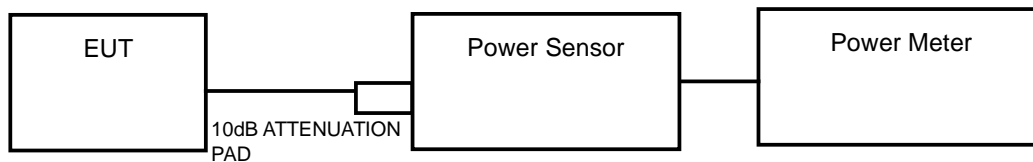



3.3.3 TEST INSTRUMENTS

Equipment	Manufacturer	Model No.	Serial No.	Last Cal.	Next Cal.
Power Sensor	Keysight	U2021XA	MY55060016	May 04,16	May 03,17
Power Sensor	Keysight	U2021XA	MY55060018	May 04,16	May 03,17
Digital Multimeter	FLUKE	15B	A1220010DG	Oct. 13, 16	Oct.12, 17
Humid & Temp Programmable Tester	Haida	HD-2257	110807201	Sep.05,16	Sep. 04,17
Oscilloscope	Agilent	DSO9254A	MY51260160	Nov. 04,16	Nov. 03,17
Signal Analyzer	Rohde & Schwarz	FSV7	102331	Nov. 04,16	Nov. 03,17
Signal Generator	Agilent	N5183A	MY50140980	Nov. 04,16	Nov. 03,17
Agile Signal Generator	Agilent	8645A	Agilent	Aug.08, 16	Aug.07, 17
ESG Vector Signal Generator	Agilent	E4438C	MY49072505	Apr. 22, 16	Apr. 21, 17
BLUETOOTH TESTER	Rohde&Schwarz	CBT32	100811	Aug.08, 16	Aug.07, 17

NOTE:

1. The test was performed in RF Oven room.
2. The calibration interval of the above test instruments is 12 months and the calibrations are traceable to CEPREI/CHINA, GRGT/CHINA and NIM/CHINA.

3.3.4 TEST PROCEDURE

For 802.11a, 802.11n (20MHz), 802.11n (40MHz)

Method PM is used to perform output power measurement, trigger and gating function of wide band power meter is enabled to measure max output power of TX on burst. Duty factor is not added to measured value.

For 802.11ac (80MHz)

- 1) Set span to encompass the entire 26 dB EBW (or, alternatively, the entire 99% occupied bandwidth) of the signal.
- 2) Set sweep trigger to “free run”.
- 3) Set RBW = 1 MHz.
- 4) Set VBW ≥ 3 MHz
- 5) Number of points in sweep ≥ 2 Span / RBW.
- 6) Sweep time ≤ (number of points in sweep) * T
- 7) Detector = RMS.
- 8) Trace mode = max hold.
- 9) Allow max hold to run for at least 60 seconds, or longer as needed to allow the trace to stabilize.



FOR 26dB BANDWIDTH

- 1) Set RBW = approximately 1% of the emission bandwidth.
- 2) Set the VBW > RBW.
- 3) Detector = RMS.
- 4) Trace mode = max hold.
- 5) Measure the maximum width of the emission that is 26 dB down from the peak of the emission. Compare this with the RBW setting of the analyzer. Readjust RBW and repeat measurement as needed until the RBW/EBW ratio is approximately 1%.

FOR 6dB BANDWIDTH

- 1) Set RBW = 100 kHz.
- 2) Set the video bandwidth (VBW) ≥ 3 RBW.
- 3) Detector = Peak.
- 4) Trace mode = max hold.
- 5) Sweep = auto couple.
- 6) Allow the trace to stabilize.
- 7) Measure the maximum width of the emission that is constrained by the frequencies associated with the two outermost amplitude points (upper and lower frequencies) that are attenuated by 6 dB relative to the maximum level measured in the fundamental emission.



3.3.5 DEVIATION FROM TEST STANDARD

No deviation.

3.3.6 EUT OPERATING CONDITIONS

The software provided by client to enable the EUT under transmission condition continuously at specific channel frequencies individually.



3.3.7 TEST RESULTS

POWER OUTPUT:

802.11a

Channel Number	FREQ. (MHz)	AVG. CONDUCTED POWER (dBm)	LIMIT (dBm)	PASS /FAIL
36	5180	13.42	24.00	PASS
44	5220	13.34	24.00	PASS
48	5240	13.28	24.00	PASS
149	5745	12.04	30.00	PASS
157	5785	12.26	30.00	PASS
165	5825	12.38	30.00	PASS

802.11n (20MHz)

Channel Number	FREQ. (MHz)	AVG. CONDUCTED POWER (dBm)		Total Max. power output	LIMIT (dBm)	PASS /FAIL
		Chain0	Chain1	dBm		
36	5180	13.42	12.56	16.02	24.00	PASS
44	5220	13.37	12.71	16.06	24.00	PASS
48	5240	13.29	12.92	16.12	24.00	PASS
149	5745	10.58	10.93	13.77	30.00	PASS
157	5785	10.56	11.28	13.95	30.00	PASS
165	5825	10.84	11.35	14.11	30.00	PASS



802.11n (40MHz)

Channel Number	FREQ. (MHz)	AVG. CONDUCTED POWER (dBm)		Total Max. power output	LIMIT (dBm)	PASS /FAIL
		Chain0	Chain1	dBm		
38	5190	9.69	10.16	12.94	24.00	PASS
46	5230	12.90	13.11	16.02	24.00	PASS
151	5755	10.23	10.56	13.41	30.00	PASS
159	5795	10.68	10.94	13.82	30.00	PASS



26dB BANDWIDTH & 6dB BANDWIDTH:

26dB BANDWIDTH For U-NII-1, U-NII-2A, U-NII-2C band

802.11a

Channel Number	Freq. (MHz)	26dB DOWN BANDWIDTH (MHz)	LIMIT(MHz)	PASS /FAIL
			Minimum	
36	5180	34.23	0.5	PASS
44	5220	33.14	0.5	PASS
48	5240	33.63	0.5	PASS

802.11n (20MHz)

Channel Number	Freq. (MHz)	26dB DOWN BANDWIDTH (MHz)		LIMIT(MHz)	PASS /FAIL
		Chain0	Chain1	Minimum	
36	5180	34.37	34.13	0.5	PASS
44	5220	32.77	33.90	0.5	PASS
48	5240	33.13	33.75	0.5	PASS

802.11n (40MHz)

Channel Number	Freq. (MHz)	26dB DOWN BANDWIDTH (MHz)		LIMIT(MHz)	PASS /FAIL
		Chain0	Chain1	Minimum	
38	5190	47.33	83.04	0.5	PASS
46	5230	96.04	96.13	0.5	PASS



6dB BANDWIDTH U-NII-3C band

802.11a

Channel Number	Freq. (MHz)	6dB DOWN BANDWIDTH (MHz)	LIMIT(MHz)	PASS /FAIL
			Minimum	
149	5745	15.67	0.5	PASS
157	5785	15.37	0.5	PASS
165	5825	15.78	0.5	PASS

802.11n (20MHz)

Channel Number	Freq. (MHz)	6dB DOWN BANDWIDTH (MHz)		LIMIT(MHz)	PASS /FAIL
		Chain0	Chain1	Minimum	
149	5745	15.54	16.07	0.5	PASS
157	5785	15.50	16.35	0.5	PASS
165	5825	15.75	16.35	0.5	PASS

802.11n (40MHz)

Channel Number	Freq. (MHz)	6dB DOWN BANDWIDTH (MHz)		LIMIT(MHz)	PASS /FAIL
		Chain0	Chain1	Minimum	
151	5755	36.43	36.42	0.5	PASS
159	5795	36.42	36.43	0.5	PASS



26dB bandwidth Test Plot

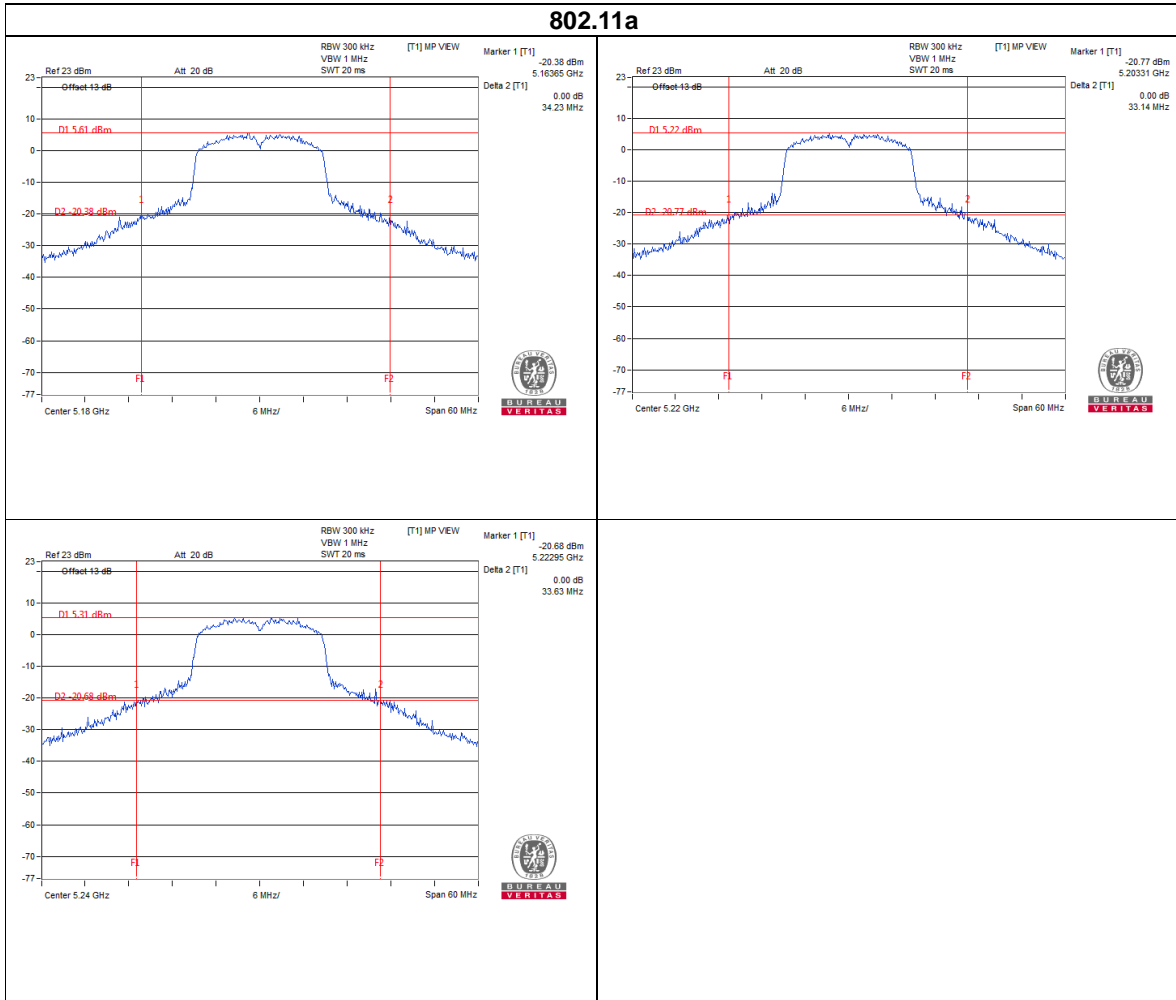

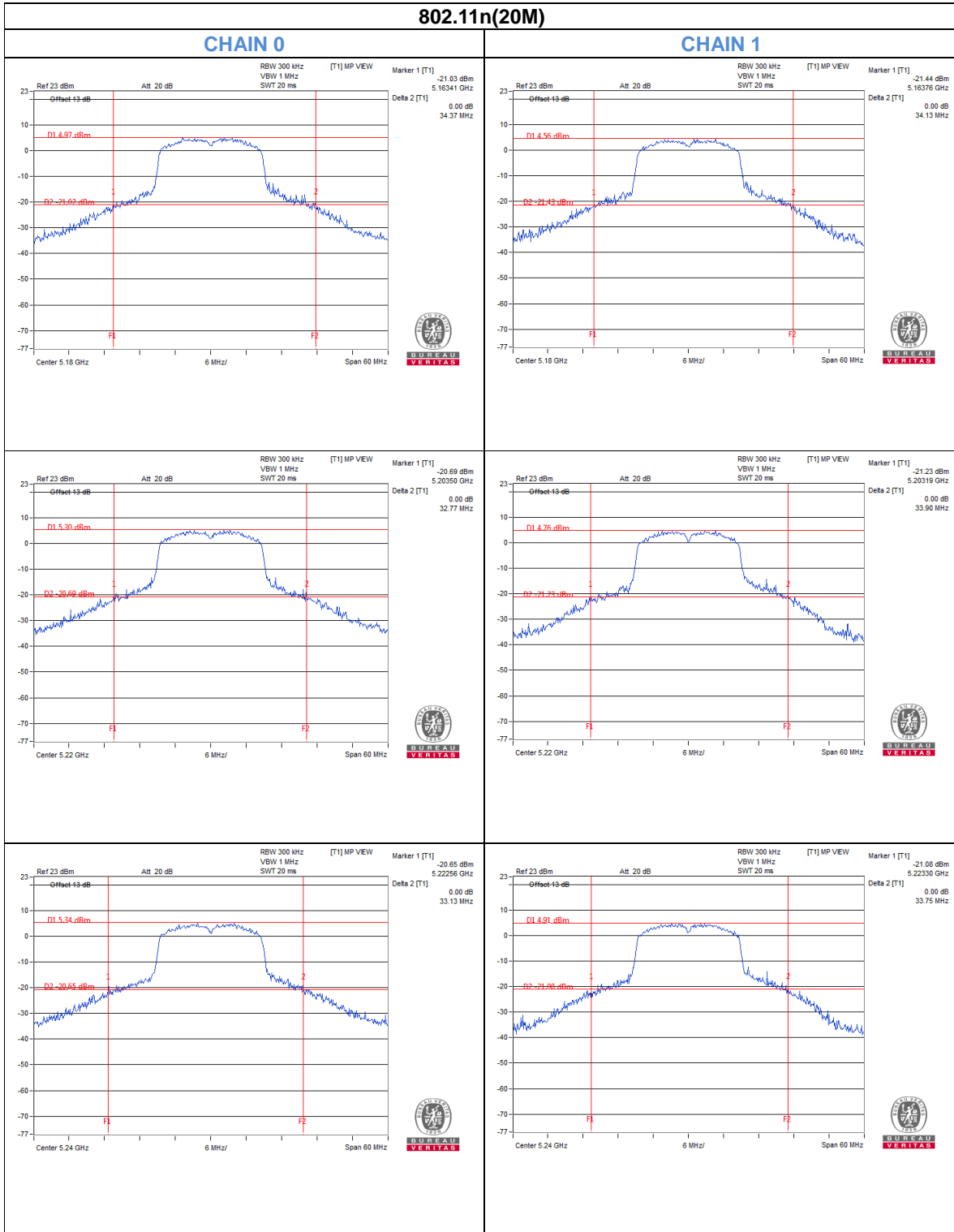

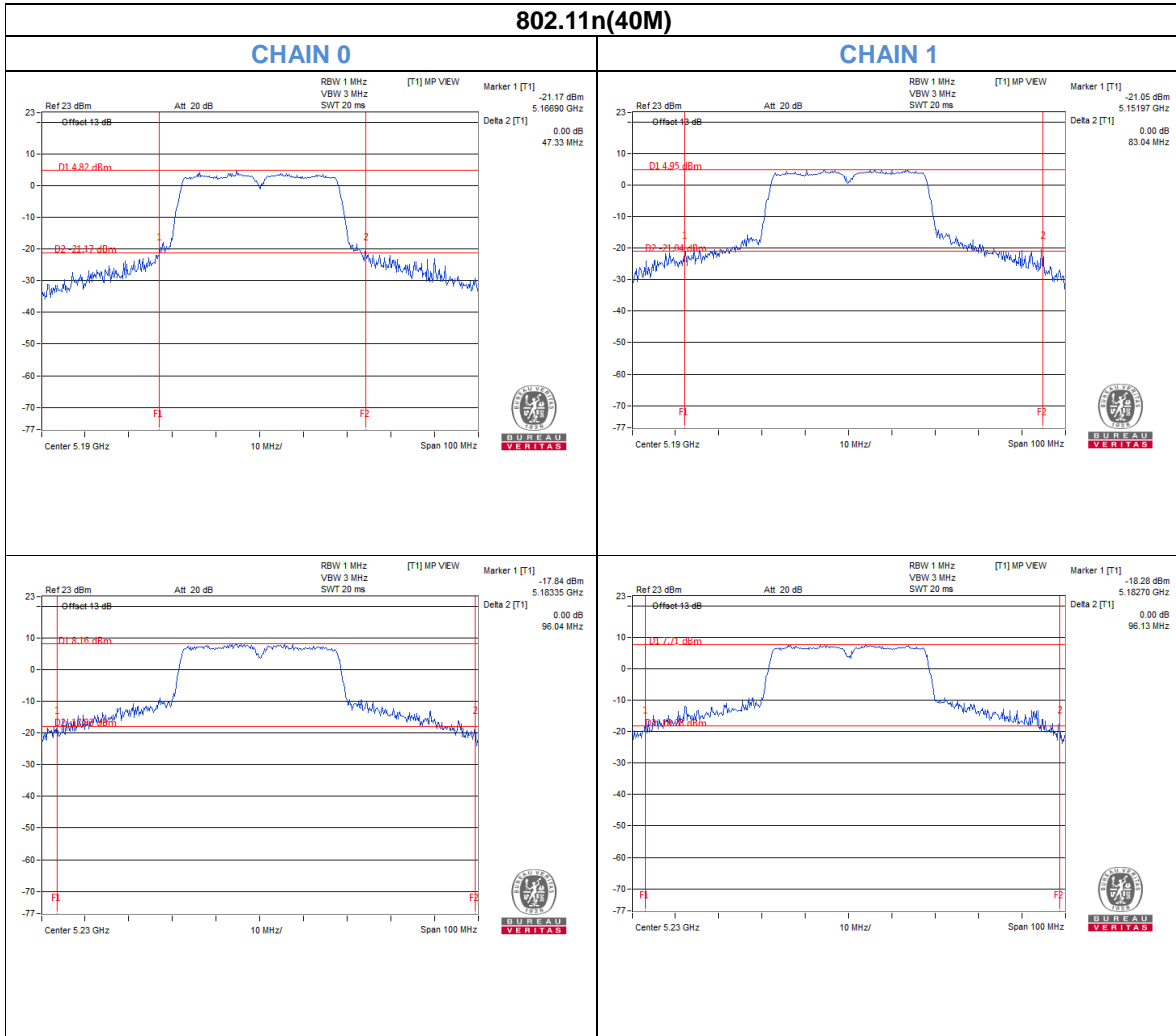



6dB bandwidth Test Plot

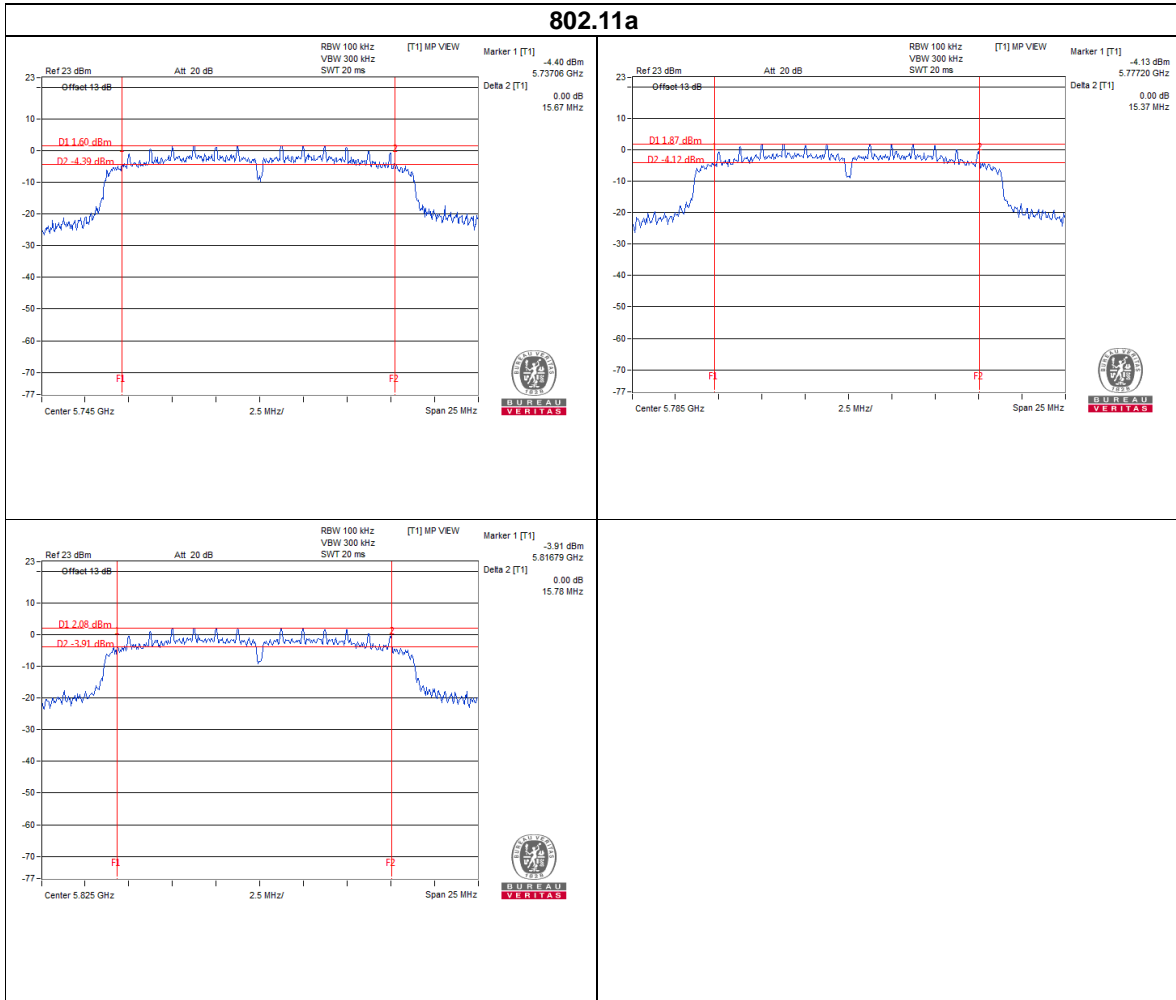

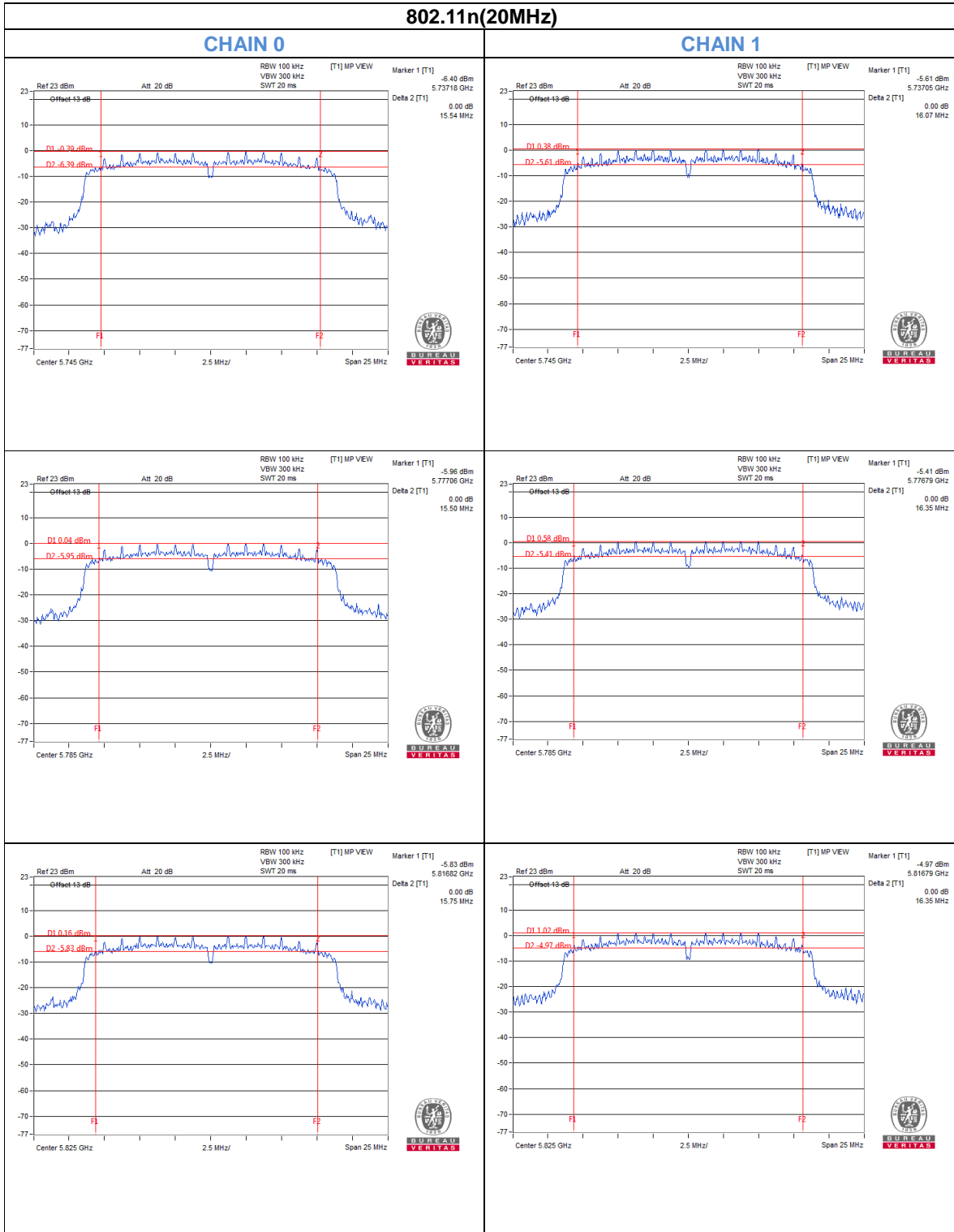

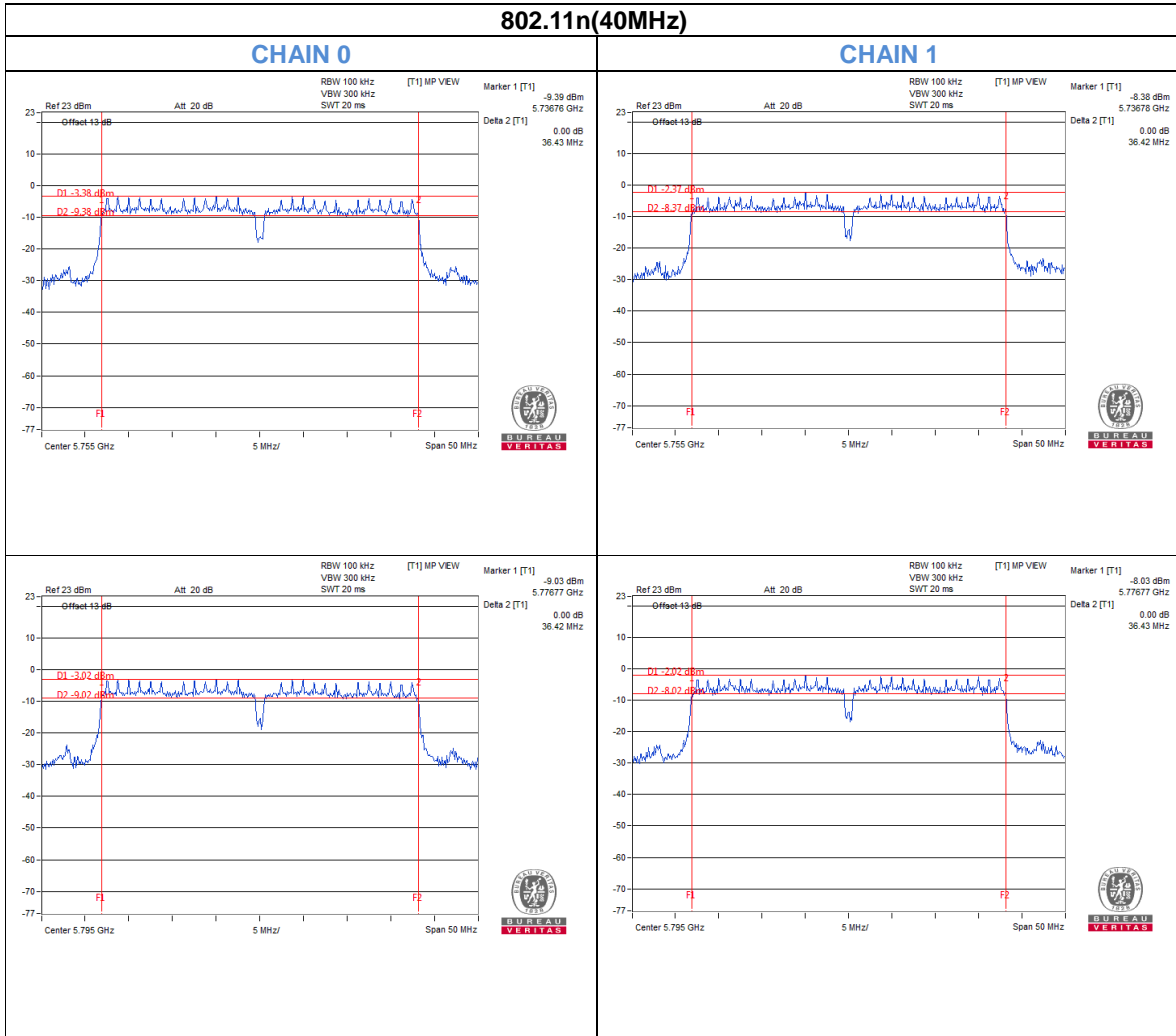



3.4 PEAK POWER SPECTRAL DENSITY MEASUREMENT

3.4.1 LIMITS OF PEAK POWER SPECTRAL DENSITY MEASUREMENT

Operation Band	EUT Category		LIMIT
U-NII-1		Outdoor Access Point	17dBm/ MHz
		Fixed point-to-point Access Point	
		Indoor Access Point	
	√	Mobile and Portable client device	11dBm/ MHz
U-NII-3	√	All Category	30dBm/500kHz

3.4.2 TEST SETUP

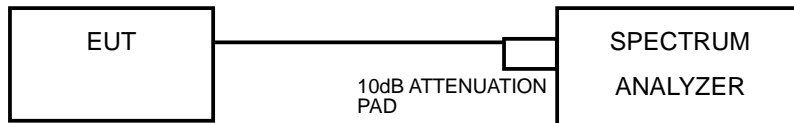

3.4.3 TEST INSTRUMENTS

Refer to section 3.3.3 to get information of above instrument.

3.4.4 TEST PROCEDURES

For U-NII-1, U-NII-2A, U-NII-2C, U-NII-3 band:

Using method SA-1

- 1) Set span to encompass the entire emission bandwidth (EBW) of the signal.
- 2) Set RBW = 1MHz(Band 1) & 300KHz(Band 4), Set VBW = 3MHz(Band 1) & 1MHz(Band 4),, Detector = RMS
- 3) Set Channel power measure = 1MHz
- 4) Sweep time = auto, trigger set to “free run”.
- 5) Trace average at least 100 traces in power averaging mode.
- 6) Record the max value



Using method SA-2

- 1) Set span to encompass the entire emission bandwidth (EBW) of the signal.
- 2) Set RBW = 1MHz(Band 1) & 300KHz(Band 4), Set VBW = 3MHz(Band 1) & 1MHz(Band 4),, Detector = RMS
- 3) Set Channel power measure = 1MHz
- 4) Sweep time = auto, trigger set to "free run".
- 5) Trace average at least 100 traces in power averaging mode.
- 6) Record the max value and add 10 log (1/duty cycle)

3.4.5 DEVIATION FROM TEST STANDARD

No deviation.

3.4.6 EUT OPERATING CONDITIONS

Same as 3.3.6



3.4.7 TEST RESULTS

For U-NII-1:

802.11a

TX chain	Channel Number	Freq. (MHz)	PSD (dBm/MHz)	Total PSD (dBm/MHz)	PSD Limit (dBm/MHz)	PASS / FAIL
0	36	5180	0.55	0.68	11.00	PASS
0	40	5200	0.52	0.65	11.00	PASS
0	48	5240	0.51	0.64	11.00	PASS

Note: Total PSD = PSD + Duty Factor

Duty Factor = 0.13dB;

802.11n (20MHz)

TX chain	Channel Number	Freq. (MHz)	PSD (dBm/MHz)	10 * log(N=2) (dB)	Total PSD (dBm/MHz)	PSD Limit (dBm/MHz)	PASS / FAIL
0	36	5180	0.50	3.01	3.64	11.00	PASS
0	40	5200	0.48	3.01	3.62	11.00	PASS
0	48	5240	0.43	3.01	3.57	11.00	PASS
1	36	5180	-0.29	3.01	2.81	11.00	PASS
1	40	5200	0.00	3.01	3.10	11.00	PASS
1	48	5240	0.17	3.01	3.27	11.00	PASS

Note: Total PSD = PSD + 10log2 + Duty Factor

Chain 0: Duty Factor = 0.13dB; Chain 1: Duty Factor = 0.088dB

802.11n (40MHz)

TX chain	Channel Number	Freq. (MHz)	PSD (dBm/MHz)	10 * log(N=2) (dB)	Total PSD (dBm/MHz)	PSD Limit (dBm/MHz)	PASS / FAIL
0	38	5190	-6.51	3.01	-3.04	11.00	PASS
0	46	5220	-3.22	3.01	0.25	11.00	PASS
1	38	5190	-5.91	3.01	-2.73	11.00	PASS
1	46	5220	-3.05	3.01	0.13	11.00	PASS

Note: Total PSD = PSD + 10log2 + Duty Factor

Chain 0: Duty Factor = 0.46dB; Chain 1: Duty Factor = 0.173dB



For U-NII-3:

802.11a

TX chain	Channel Number	Freq. (MHz)	PSD (dBm/300kHz)	PSD (dBm/500kHz)	Total PSD (dBm/500kHz)	PSD Limit (dBm/500kHz)	PASS / FAIL
0	149	5745	-8.95	-6.73	-6.63	30.00	PASS
0	157	5785	-8.56	-6.34	-6.24	30.00	PASS
0	165	5825	-10.10	-7.88	-7.78	30.00	PASS

Note: Total PSD = PSD + Duty Factor
Duty Factor = 0.097dB;

802.11n (20M)

TX chain	Channel Number	Freq. (MHz)	PSD (dBm/300kHz)	PSD (dBm/500kHz)	10 * log(N=2) (dB)	Total PSD (dBm/500kHz)	PSD Limit (dBm/500kHz)	PASS / FAIL
0	149	5745	-10.41	-8.19	3.01	-5.088	30.00	PASS
0	157	5785	-10.43	-8.21	3.01	-5.108	30.00	PASS
0	165	5825	-10.13	-7.91	3.01	-4.808	30.00	PASS
1	149	5745	-9.77	-7.55	3.01	-4.452	30.00	PASS
1	157	5785	-9.55	-7.33	3.01	-4.232	30.00	PASS
1	165	5825	-9.18	-6.96	3.01	-3.862	30.00	PASS

Note: Total PSD = PSD + 10log2 + Duty Factor
Chain 0: Duty Factor = 0.092dB; Chain 1: Duty Factor = 0.088dB

802.11n (40MHz)

TX chain	Channel Number	Freq. (MHz)	PSD (dBm/300kHz)	PSD (dBm/500kHz)	10 * log(N=2) (dB)	Total PSD (dBm/500kHz)	PSD Limit (dBm/500kHz)	PASS / FAIL
0	151	5755	-14.36	-12.14	3.01	-8.962	30.00	PASS
0	159	5795	-13.88	-11.66	3.01	-8.482	30.00	PASS
1	151	5755	-13.60	-11.38	3.01	-8.188	30.00	PASS
1	159	5795	-13.19	-10.97	3.01	-7.778	30.00	PASS

Note: Total PSD = PSD + 10log2 + Duty Factor
Chain 0: Duty Factor = 0.168dB; Chain 1: Duty Factor = 0.182dB



CHAIN 0

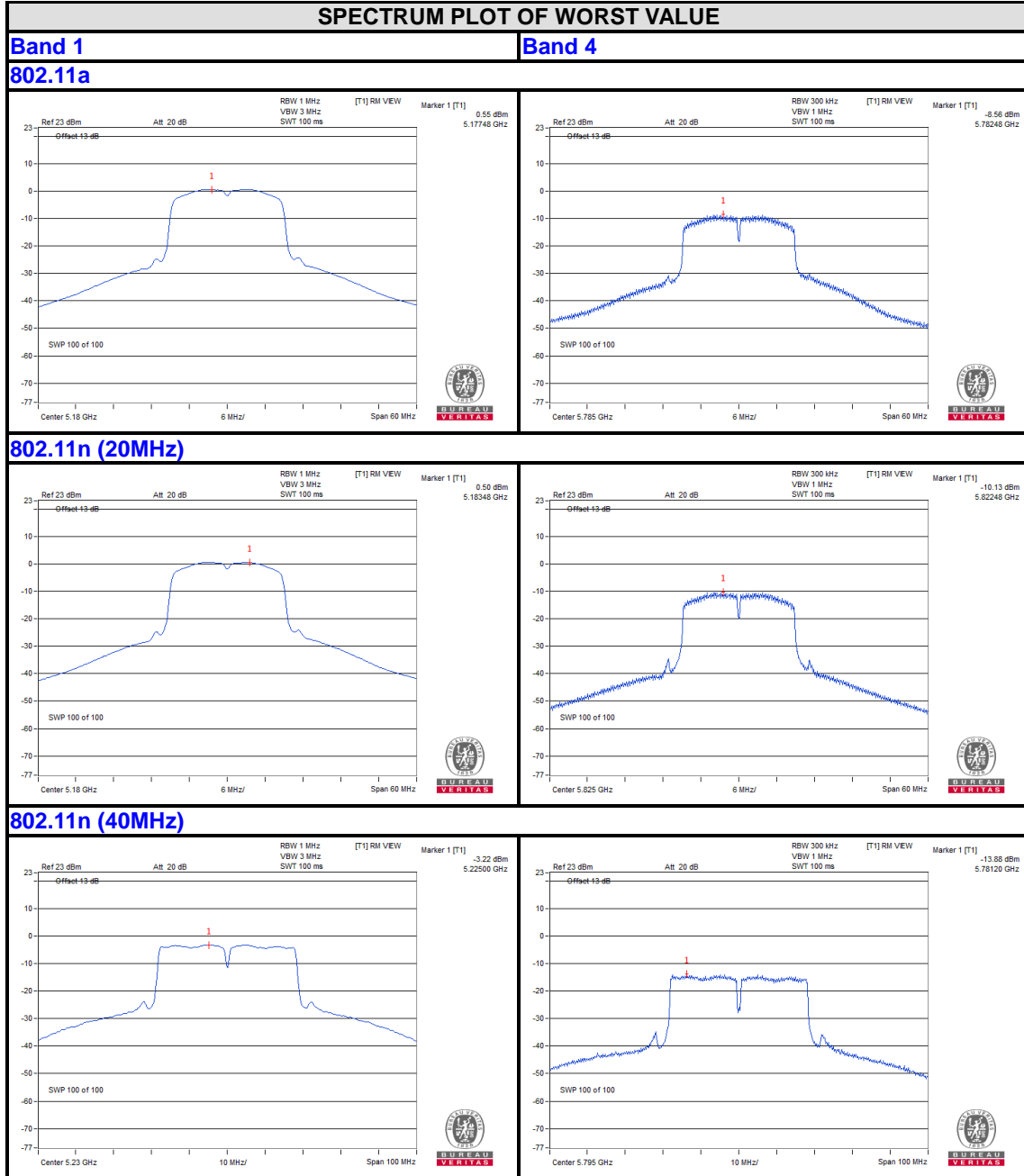



CHAIN 1

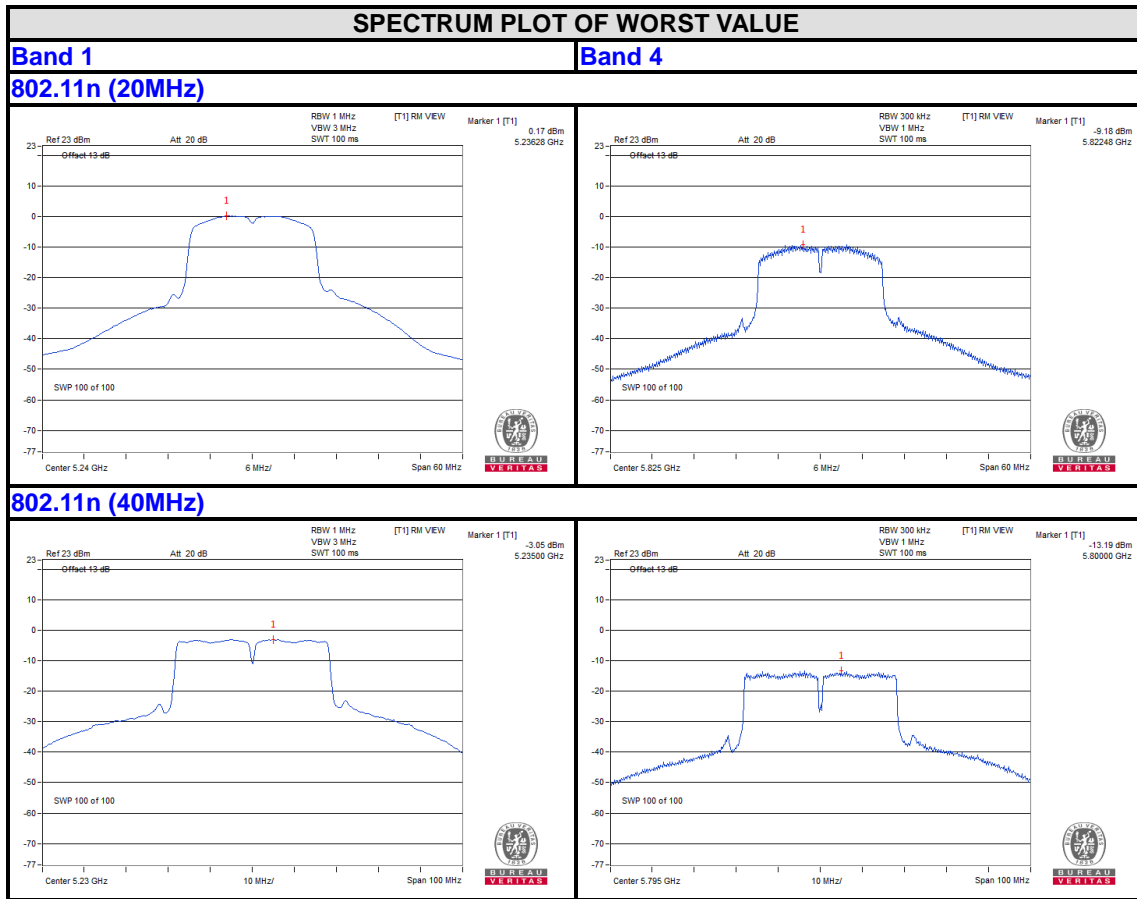



3.5 FREQUENCY STABILITY

3.5.1 LIMITS OF FREQUENCY STABILITY MEASUREMENT

The frequency of the carrier signal shall be maintained within band of operation.

3.5.2 TEST SETUP

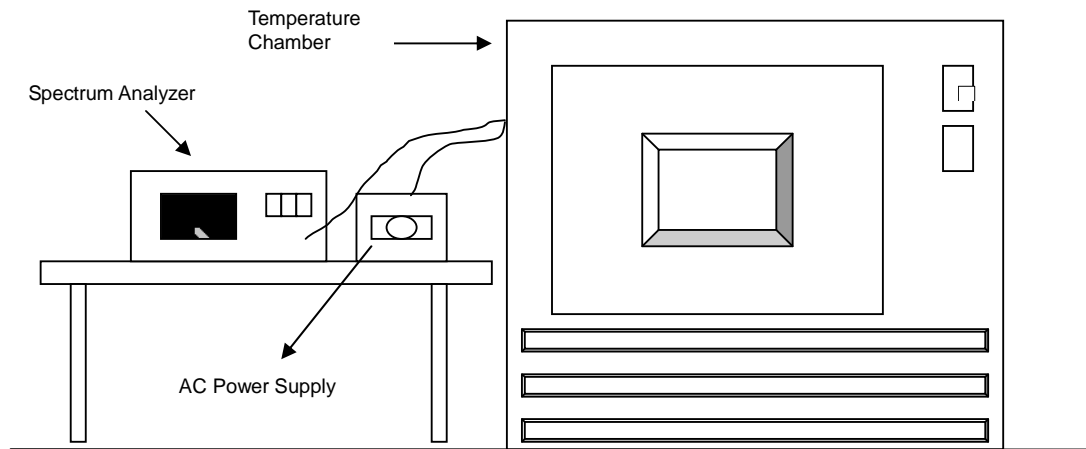

3.5.3 TEST INSTRUMENTS

Refer to section 3.3.3 to get information of above instrument.



3.5.4 TEST PROCEDURE

- a. The EUT was placed inside the environmental test chamber and powered by nominal AC voltage.
- b. Turn the EUT on and couple its output to a spectrum analyzer.
- c. Turn the EUT off and set the chamber to the highest temperature specified.
- d. Allow sufficient time (approximately 30 min) for the temperature of the chamber to stabilize, turn the EUT on and measure the operating frequency after 2, 5, and 10 minutes.
- e. Repeat step 2 and 3 with the temperature chamber set to the lowest temperature.
- f. The test chamber was allowed to stabilize at +20 degree C for a minimum of 30 minutes. The supply voltage was then adjusted on the EUT from 85% to 115% and the frequency record.

3.5.5 DEVIATION FROM TEST STANDARD

No deviation.

3.5.6 EUT OPERATING CONDITION

Set the EUT transmit at un-modulation mode to test frequency stability.



3.5.7 TEST RESULTS

FREQUENCY STABILITY VERSUS TEMP.									
OPERATING FREQUENCY: 5180MHz									
TEMP. (°C)	POWER SUPPLY (Vac)	0 MINUTE		2 MINUTE		5 MINUTE		10 MINUTE	
		Measured Frequency (MHz)	Frequency Drift (ppm)	Measured Frequency (MHz)	Frequency Drift (ppm)	Measured Frequency (MHz)	Frequency Drift (ppm)	Measured Frequency (MHz)	Frequency Drift (ppm)
50	120	5189.9798	-0.00039	5189.9771	-0.00044	5189.9797	-0.00039	5189.9775	-0.00043
40	120	5190.0085	0.00016	5190.0077	0.00015	5190.0065	0.00013	5190.006	0.00012
30	120	5189.9879	-0.00023	5189.9893	-0.00021	5189.9885	-0.00022	5189.9878	-0.00024
20	120	5190.025	0.00048	5190.0233	0.00045	5190.0231	0.00045	5190.0275	0.00053
10	120	5189.9741	-0.00050	5189.978	-0.00042	5189.9745	-0.00049	5189.9749	-0.00048
0	120	5189.9887	-0.00022	5189.9872	-0.00025	5189.9887	-0.00022	5189.9841	-0.00031
-10	120	5189.9874	-0.00024	5189.9838	-0.00031	5189.9835	-0.00032	5189.9834	-0.00032
-20	120	5190.0005	0.00001	5190.0013	0.00003	5190.0033	0.00006	5190.0032	0.00006
-30	120	5189.9939	-0.00012	5189.996	-0.00008	5189.9964	-0.00007	5189.9955	-0.00009

FREQUENCY STABILITY VERSUS TEMP.									
OPERATING FREQUENCY: 5180MHz									
TEMP. (°C)	POWER SUPPLY (Vac)	0 MINUTE		2 MINUTE		5 MINUTE		10 MINUTE	
		Measured Frequency (MHz)	Frequency Drift (ppm)	Measured Frequency (MHz)	Frequency Drift (ppm)	Measured Frequency (MHz)	Frequency Drift (ppm)	Measured Frequency (MHz)	Frequency Drift (ppm)
20	138	5190.0245	0.00047	5190.0229	0.00044	5190.0235	0.00045	5190.0274	0.00053
	120	5190.025	0.00048	5190.0233	0.00045	5190.0231	0.00045	5190.0275	0.00053
	102	5190.024	0.00046	5190.0238	0.00046	5190.0224	0.00043	5190.0276	0.00053



BUREAU Test Report No.: RF160928N001-3
VERITAS

4. PHOTOGRAPHS OF THE TEST CONFIGURATION

Please refer to the attached file (Test Setup Photo).



5. APPENDIX A – MODIFICATIONS RECORDERS FOR ENGINEERING CHANGES TO THE EUT BY THE LAB

Modifications are made to the EUT by the lab during the test.

See material declaration.

---END---