



TELEMATICS
MOBILE INFORMATION EXCHANGE

MiX 4000 Installation Guide



Table of Contents

1	Introduction	4
1.1	MiX 4000 Hardware Features	4
2	Regulatory Compliance	5
3	Product Variants and Part Numbers	5
3.1	MiX 4000 Power Requirements	7
4	Safety - read before installation	7
4.1	Installer Requirements	7
4.2	Tools	8
4.3	Secure the workplace	8
4.4	ESD - Installation Handling Precautions	8
5	Sim Card	8
5.1	Preparing the SIM card	8
5.2	Inserting the SIM card	9
5.2.1	Open and close the unit	9
5.3	Configuration of unit	10
6	Installation	11
6.1	Installation Steps	11
6.2	Installation Precautions	11
6.3	Positioning of product components	11
6.4	General Wiring Requirements	13
6.5	Harnesses and connectors	14
6.5.1	Harness Part Numbers	15
6.5.2	Main Harness	15
6.5.3	Code Plug Harness CP4	16
6.5.4	Serial Harness SR1	16
6.5.5	MiX 4000 Serial Harness 2 (use Serial Harness SR1)	17
6.5.6	GSM, GNSS and BT Antennas	17
6.5.7	GNSS antenna connection	18
6.5.8	GSM antenna (internal)	18
7	Positioning the MiX 4000 Unit in the vehicle	18
8	Starter Interrupt	19
9	Code Plug Socket Installation	20
10	Signal Inputs	21
10.1	Digital Inputs	21
10.2	Ignition Input	22
11	Power Outputs	23
11.1	Positive Drive	23
12	Serial Communication	24
13	CAN	24
13.1	Overview	24
13.1.1	Tools and Inspection needed for CAN Installation:	24
13.1.2	Wire lengths	25
13.1.3	CAN jumper settings	25
13.1.4	When must the 120 Ohm terminating resistor be in the circuit?	28
13.1.5	General Rules for CAN terminating resistors	28
13.1.6	When must the RD/WR Jumpers be in the circuit?	29
13.2	DLD and DTCO	30
13.2.1	D-8	30
13.2.2	Connect CAN to DTCO	30
13.2.3	K-line	30
14	MiX TechTool	30
15	After Installation	31
15.1	Beep codes	31
15.2	LED flash codes	31

15.2.1	GPS LED flash codes (GREEN)	31
15.2.2	GSM LED flash codes (RED)	32
16	Testing Installation.....	32
16.1	Test Drive	32
17	Closing Steps.....	32
18	Troubleshooting	33
19	Routine Maintenance.....	33
20	MiX 4000 Specifications	34
20.1	Technical description.....	34
20.2	Auxiliary inputs/outputs	34
21	Peripheral Power Manager	35
22	Backup Battery Replacement Procedure	36
23	Glossary.....	37

1 Introduction

The MiX 4000 is a fleet product that incorporates the latest market trends. It consists mainly of an on-board computer, a LTE CAT M1, 3G or 2G modem, a GNSS, an accelerometer, Low Energy Bluetooth, I/O, 2 x CAN, 2 x RS232, 4 x positive drives and 434 / 915 MHz short range transceiver.

There are various part IDs, but hereafter, the generic term, MiX 4000, will be used, unless a specific reference is required.



1.1 MiX 4000 Hardware Features

Digital/Analog Inputs	There are two analogue inputs that can be configured to monitor any device that generates a change in voltage, e.g. seat belts, headlights, refrigeration units, temperature sensors, emergency lights, doors, PTO, UDS, trailer coupling etc. Disconnection of these inputs can be detected using open-wire detect.
Frequency Inputs	There are two frequency/pulse inputs for integration with legacy sensors.
Tacho Inputs	It is possible to configure any one of the existing digital/analog or frequency inputs as Tacho inputs.
Ignition input	This monitors the ignition switch status. The unit is able to detect when the ignition is connected or disconnected. Disconnection of this input can be detected with open-wire detection. Maximum 36V input, impedance > 100kOhm.
CAN	The system has two CAN inputs that support J1939 and OBDII CAN as a minimum. Configuration of the termination resistor and the transmit-disabling can be done either with jumpers (for safety critical installs) or via software settings.
GNSS	GPS and GLONASS available.
Modem	LTE CAT M1 / 3G / 2G
Serial Ports	Two RS232 serial ports (with flow control).
K-line and D8	K-line interface for Digital Tachograph (DTCO D8 input).
Bluetooth	Single-Chip Bluetooth Solution Integrating Bluetooth Low Energy (LE) Features, Fully Compliant with the Bluetooth 4.0 Specification Up to the HCI Layer.
Accelerometer	3-axis $\pm 2g / \pm 4g / \pm 8g / \pm 16g$ dynamically selectable full-scale and is capable of measuring acceleration with output data rates from 1 Hz to 5 kHz.
Positive drive	Four positive drive with open-load detection and current sense diagnostics: one with 1A current limit and three with 250mA current limit.
Tamper detection	Tamper detection when the housing is opened, i.e. the cover removed. Shorting, cutting, or unplugging any of the external antennas will also be detected.
Code Plug	Standard FM code plug circuit (Optional: 5V aux output). Only the blue driver plug is supported.

Internal backup battery	An internal battery provides backup power for more than 8 hours if the supply from the vehicle's battery is removed.
Buzzer and LED	A buzzer is available to provide feedback of the vehicle's status and to warn the driver if necessary. Two LED's at the back provide feedback on the status of the unit.
Short Range Device (SRD)	433 or 915 MHz RF transceiver.
RTC	Real time clock with coin-cell battery.

2 Regulatory Compliance

This device complies with Part 15 of the FCC Rules. Operation is subject to the following two conditions: (1) this device may not cause harmful interference, and (2) this device must accept any interference received, including interference that may cause undesired operation.





No changes / modifications shall be made to the equipment without the manufacturer's permission as this may void the user's authority to operate the equipment.

This equipment complies with FCC radiation exposure limits for an uncontrolled environment. This equipment shall be installed and operated with a minimum distance of 20 cm (7.9 in) between users and/or bystanders and the device.

3 Product Variants and Part Numbers

Part ID	Picture	Official Name	Required / Optional	Description
440FT0194		MiX 46MC-4G	Region specific	MiX 4000 LTE with 2G fallback (Model 46MC-4G) Electronic Unit; with Magix 434MHz and 915MHz support
440FT0195		MiX 46MC-4G-B	Region specific	MiX 4000 LTE with 2G fallback (Model 46MC-4G-B) Electronic Unit with Battery (plugged in) and with Magix 434MHz and 915MHz support
440FT0187		MiX 45MC-4G	Region specific	MiX 4000 LTE (Model 45MC-4G) Electronic Unit; with Magix 434MHz and 915MHz support

Part ID	Picture	Official Name	Required / Optional	Description
440FT0191		MiX 45MC-4G-B	Region specific	MiX 4000 LTE (Model 45MC-4G-B) Electronic Unit with Battery plugged in and with Magix 434MHz and 915MHz support.
U0032MT		MiX 44MC-3G	Region specific	MiX 44MC-3G (SARA-U201) Electronic Unit; with Magix 434MHz and 915MHz support
U0034MT		MiX 44MC-3G-B	Region specific	MiX 44MC-3G (SARA-U201) Electronic Unit with Battery plugged in and with Magix 434MHz and 915MHz support
U0022MT		MiX 424C-2G	Region specific	MiX 4000 2G (SARA-G350) with Magix (433MHz).
U0023MT		MiX 424C-2G-B	Region specific	MiX 4000 2G (SARA-G350) Electronic Unit with Battery plugged in and Magix 434MHz.
440FT0033		Main Harness MP10	Required	Main Harness (Power, Ignition, Ground, Relay Socket, Buzzer, CAN Connector, 5V, 2 x Input, Positive Drive).
A0025MT		OBDII Main Harness MP14	Optional	OBDII Main Harness MP14: Power, Ignition, Ground, Relay Socket, Buzzer, OBDII Connector, 2xInput, Positive Drive; Compatible with MiX 4000 NG Series.

Part ID	Picture	Official Name	Required / Optional	Description
440FT0931		Serial Harness SR1	Optional	Serial Harness (RX, TX, CTS, RTS, GND, DSR-DTR looped, RS232 with DB9 Male Connector).
440FT0032		Code Plug Harness with socket CP4	Optional	Code Plug Harness (1m).
440FT0073		Driver Plug	Optional	Blue Driver Code plug.
440FT0933		External GNSS Antenna PA2	Optional	External GNSS (Global Navigation Satellite System) Antenna with FAKRA connector, compatible with MiX 4000 and MiX 6000 series.

3.1 MiX 4000 Power Requirements

The MiX 4000 is designed for use in 12V or 24V vehicles. Special vehicles and working machines with voltages above 33V will require a voltage converter to facilitate the required power supply input.

4 Safety - read before installation

4.1 Installer Requirements

- Installation should only be undertaken by a vehicle technician with comprehensive occupation specific knowledge. Installation by an unqualified technician may adversely affect the operating reliability of the vehicle and could endanger other road users.
- A basic knowledge of vehicle electrical and mechanical systems is required to successfully install the fleet management system.
- The system should only be installed by a suitably qualified vehicle technician with a basic knowledge of the operation of computers.
- Installation technicians should attend a training course to acquire the skills needed for installation, configuration and operation of the fleet management system.
- Installers should consult the vehicle manufacturer's documentation for the specific vehicle make and model prior to undertaking an installation.

- Installers should pay particular attention to the location of fuel systems, hydraulic systems, compressed air systems and other electrical and mechanical systems, which may have a bearing on the installation.
- Installers should pay attention to any changes to the vehicle's systems or settings, which should be noted prior to the installation.
- Installers should not smoke or make use of naked flames, which could cause a fire in or near the vehicle.

After installation, verify that no interference is caused to the vehicle's electrical system. Check dashboard warning lights and error messages. Should any error conditions exist, remove the installed unit and contact MiX Telematics for assistance.

4.2 Tools

- Standard technical equipment and appropriate tools for use with vehicles are required to install the MiX 4000.
- Vehicle specific tools may be required for the removal of consoles and covers.

4.3 Secure the workplace

- Remove the ignition key from the vehicle's ignition lock.
- Ensure that the vehicle's engine cannot be unintentionally started during the installation.
- Short-circuiting the vehicle's electrical system may result in fire, explosion of the battery and/or damage to other electrical systems.
- Electrical shock from high voltage batteries must be avoided, as this may lead to death or injury.
- The negative terminal of the vehicle's battery should be disconnected before commencing installation. If the vehicle has additional batteries, it may be necessary to disconnect the negative terminals of these batteries too.

4.4 ESD - Installation Handling Precautions

Prior to touching the PCB, inserting a new SIM or replacing the battery, always take ESD precautions:

- Either use an earthed wrist strap or touch a known earth point (or negative potential in the vehicle) prior to handling the unit.
- If the PCB must be handled, avoid direct contact with any of the components and handle it by only touching the edges of the PCB.

5 Sim Card

5.1 Preparing the SIM card

Before inserting the SIM card, determine if the SIM needs to be secured with a unique PIN.

If a PIN secured SIM is required:

- Ensure that the SIM is configured as "PIN required".
- Ensure that the PIN is set as either 0000 or 00000.
- The MiX 4000 will change the PIN to a unique number that it calculates for the device.
- The SIM is then locked to the device and the PUK will be locked if inserted into another device.

If an unsecured SIM is required:

- Ensure that the SIM is configured as “PIN not required”.
- The MiX 4000 will leave the SIM with this configuration.
- This SIM can be moved to a different device without risk of the PUK begin locked.

5.2 Inserting the SIM card

In order to insert the SIM card, the following steps must be followed:

- Observe ESD precautions as prescribed in section [4.4](#).
- The SIM card is accessible from the back panel.
- Insert the SIM card as indicated by the symbol on the label on the housing plastic. See the diagrams below.

5.2.1 Open and close the unit

1. Lift the four clips on the back and front of the unit as illustrated in Figure 1 below.
2. Unhook and lift the cover as illustrated in Figure 2.
3. Make sure the SIM card is positioned correctly as indicated in Figure 3.
4. Insert SIM card as indicated in Figure 4.
5. Clip the cover back on; ensure the clips are secured as shown in Figure 5.



Figure 1: Opening of side clips



Figure 2: Unhook the cover

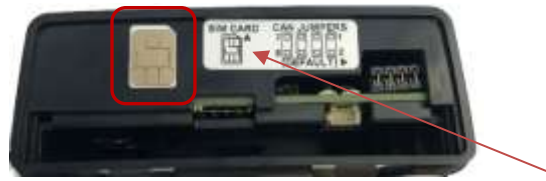

Figure 3: Position the SIM as shown on the unit.



Figure 4: Insert the SIM card into SIM card slot; ensure it is fully seated (clicks into place).



Figure 5: Clip the cover back on; the hooks need to click into place.

5.3 Configuration of unit

The MiX 4000 is configured with default fleet settings during commissioning. It is possible to make over the air (OTA) changes to some settings via the MiX Fleet Manager software interface.

6 Installation

6.1 Installation Steps

Step	Action	Software Tools
1)	Ensure the SIM is correctly prepared (refer to section 5.1).	None
2)	Insert the SIM card (refer to ESD precautions in section 4.4). <i>The SIM card orientation is illustrated in section 5.2</i>	None
3)	Configure the unit.	MiX Fleet Manager
4)	Configure Bluetooth if applicable.	MiX TechTool
5)	Install the harness. (Section 6.5)	None
6)	Install the code plug socket. (Section 9)	None
7)	Install the GPS antenna. (Section 6.5.6 and 6.5.7)	None
8)	Connect power and signal inputs. (Section 10 and Section 11)	None
9)	Test the installation. (Section 16)	Verify that the unit reports to the backend.
10)	Test GSM observing the LED flashing sequence (see 15.2.2)	None
11)	Test GPS observing the LED flashing sequence (see 15.2.1)	None
12)	Install unit. (Section 7)	

On the MiX 4000, the unit maintains an on-board odometer. This starts at 0 km from the factory. An offset can be sent from the MiX Telematics Fleet Manager user interface to align the odometer value on the MiX 4000 unit with the vehicle odometer at installation time using "MiX TechTool". An updated value can be sent at any time, over the air, from MiX Fleet Manager to realign these two values.

6.2 Installation Precautions

Should it be necessary to remove seats, covers or other components, care should be taken to avoid accidental damage and/or disconnection of cables.

- All components should be checked for damage prior to being installed into the vehicle.
- A drill should be used for small installation openings.
- For larger openings, a conical milling cutter, compass saw or file should be used.
- All rough edges should be trimmed.
- Careful attention must be paid to the manufacturers' safety regulations for all tools used.
- Oils and fuels must be collected in appropriate containers and disposed of in accordance with the law.

6.3 Positioning of product components

Installers should ensure that the components of the product do not influence or hamper the functioning of the vehicle's systems.

- Care should be taken to ensure that the product's components are not damaged during installation.
- Ensure that sufficient space is available for all components of the product, prior to commencing the installation.

- Should the bracket be used to fix the unit to the vehicle, make sure that the unit and bracket are securely clipped together. Add a cable-tie around the complete housing and bracket assembly for a more secure mounting if required.
- Avoid installing in known high-temperature areas, such as parts of the engine bay or near major heat sources. Also, do not install together with other electronic equipment in an enclosed box that would trap the heat and cause the temperature to rise.
 - Operating range (with backup battery): -20°C to +60°C
 - Operating range (without backup battery): -25°C to +85°C
 - Battery will only charge in the range 0°C to +45°C
- Ensure that the unit and harness are secured to prevent the harness vibrating differently to the unit at the harness connectors.
- Correct orientation of the unit is important to ensure good GPS reception if the internal GPS antenna is being used (it is not a problem if the external antenna is used). When the internal antenna is used, the unit should be mounted with the top side (where the MiX Telematics logo is engraved) facing up, and the label side down. (See Figure 6 below).

Additionally, it is advisable to install the unit in a location where the GPS view of the sky is relatively unobstructed by metal. Most vehicle boots for example, may form a metal cage, which prevents GPS reception. Placing it under the vehicle bonnet will also prevent good performance.

This side facing up.



Figure 6

- Please note that the voltage of the external relay is rated to the vehicle voltage specification. Do not run a 12V relay at 24V. The Relay Specifications are:
 - Coil current rating: < 200 mA
 - Coil Voltage Rating: Must match the vehicle battery supply
- Please pay attention to the routing course of cables and wiring.
- Do not install the product in or near the location of mechanical or electrical airbags.
- Do not drill into supporting or stabilizing braces or beams.

6.4 General Wiring Requirements

Note the product's wire gauge cross-sectional area. If the wire gauge cross-section is reduced, current density increases, which may cause the wiring to overheat.

- Cables should be routed in existing channels and should not be routed parallel to ignition cables or other cables subject to high current.
- Cables should be fixed with cable-ties or adhesive tape.
- Do not route cables over moving parts or too close to the high voltage areas (like the spark plugs).
- Do not fix cables on the steering column.
- Ensure that the cables are not exposed to pulling, pressure or shearing deformation.
- If the cables are routed through drilled holes, rubber grommets or similar protection should be used.
- Suitable cable-strippers should be used to strip insulating material from cables and cable-strippers should be adjusted to suit the wire gauge being stripped, to avoid damaging or separating the wire strands.
- Cables should only be connected using solder or suitable crimping lugs.
- A proper crimping tool should be used on all crimping lugs.
- Careful attention must be paid to the manufacturers' safety regulations for all tools used.
- Insulate all exposed wires to prevent short-circuits. Use good quality adhesive tape or heat shrink (provided).
- Connections to vehicle power supply must be installed with a fuse (check if the main harness is fitted with a fuse).
- Be aware that short-circuiting may be caused by faulty connections and crushed or damaged cables.
- Short-circuiting the vehicle's electrical system may result in fire, explosion of the battery and/or damage to other electrical systems. To prevent this, all connections carrying current must be soldered and insulated correctly. Other connections such as the speed signal, RPM signal, brake light or clutch switch can be made with crimping lugs.
- Incorrect connections can lead to short circuits. Connections should only be made in accordance with the vehicle's wiring diagram.
- Current and voltage should be measured with a multi-meter or diode test lamp.
- The use of inadequate test equipment may result in damage to control devices or other electrical systems.
- Route the harness in such a way as to prevent water condensation that may form on the cable from running into the unit. This can be achieved by having the harness at a lower point just before it connects to the unit. If the back plate is lower than the rest of the unit, water can accumulate inside the unit with no way to escape and invalidates the IP54 rating. The unit should also never be exposed to direct water spray and jets.
- Ensure that rubber boot is flush against enclosure.
- Shortening of antenna wires:
 - It would be better to circle/coil excess wires. Avoid sharp bends (zigzags). Take care not to tie coax wires too tight. The coax should not be squeezed or pinched. Use the broadest possible cable tie.
 - The best place to circle/coil the wires is about 300 mm in line from the antenna.
 - If the GSM and GPS antennas are both coiled, they should be spaced apart.
 - Refer to section [6.5.7](#) for more detailed GPS wiring instructions
 - Refer to section [6.5.8](#) for more detailed GSM wiring instructions

✗ Avoid

Avoid sharp corners and bends:



Avoid coupling between 2 different pieces of wire:



✓ Recommended

Use rounded bends:



Separate coiled wires where possible:



6.5 Harnesses and connectors

Please read the Safety section (Section 2) of this document before installing the vehicle harness. Confirm which of the harnesses will be used in the installation, as the colour of the wires will differ depending on the harness selected. All connector diagrams are shown from the back (wiring side) of the harness.



See the diagram below for a numbered depiction.

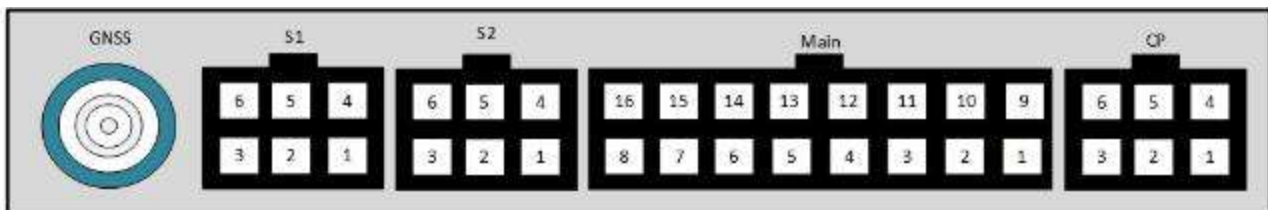

The pin layout and wire colours of the various harness options as well as detailed tables describing pin functions are shown below.

6.5.1 Harness Part Numbers

440FT0033	Main Harness MP10
440FT0032	Code Plug Harness with socket CP4
440FT0931	Serial Harness SR1
440FT0933	External GNSS Antenna PA2
440FT0816	OBDII Main Harness MP4
440FT0073	FM Driver ID Plug (Blue)

6.5.2 Main Harness

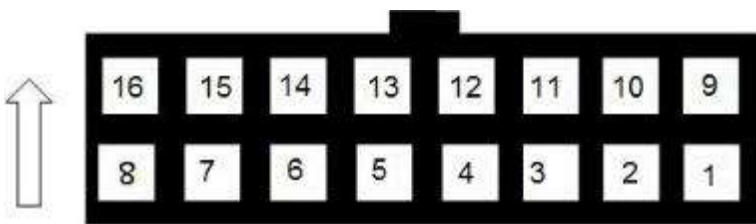

Connector viewed from the back (wiring side) of harness (440FT0033)

PIN	Colour	Name	Function	Application Information
1	Red	BAT+	Vehicle battery +	Connect to vehicle battery +12V to +24V. Must be protected with the provided 7.5 amp slow blow fuse, or a similar one already present in the vehicles wiring.
2	Black	IGN	Ignition input	Connect to vehicle ignition switch. Must be protected with a 1 amp fuse.
3	White/Violet	ANALOG1	Analogue input 1	Maximum signal voltage = 38V. Do not connect signals from unsuppressed inductive sources such as relay coils (where severe voltage spikes can be generated).
4	White/Red	ANALOG2	Analogue input 2	
5	Dark Green	RPM	RPM (Input 4)	Frequency Input. Maximum signal voltage level = 38V.
6	Blue/White	SPEED	Speed (Input 3)	
7	Red/Blue	POSD3	Ext. Relay Drive 1	Load current must not exceed 250 mA Output controlled by MiX 4000 and selected in Vehicle Properties of frontend user software.
8	Brown/Blue	POSD4	Immobiliser Relay	Load current must not exceed 250 mA Output controlled by MiX 4000 and selected in Vehicle Properties of frontend user software.
9	Brown	GND	Ground	Connect directly to vehicle ground.

PIN	Colour	Name	Function	Application Information
				⚠ Do not tap into an existing ground wire carrying high current.
10	Red/White	CP-5V-OUT	Code Plug 5V Out	Can deliver nominal 100 mA.
11	Yellow	CAN1 P	CAN1 High	1 st CAN Bus: Used to monitor supported CAN bus.
12	Green	CAN1 N	CAN1 Low	
13	Grey	K-LINE	K-Line serial signal	Serial communication to DTCO.
14	Yellow/Green	BUZZOUT	Buzzer Output	Provides warning sounds.
15	Yellow/Black	CAN2 P	CAN2 High	2 nd CAN Bus: Used to monitor supported CAN bus.
16	Green/Black	CAN2 N	CAN2 Low	

6.5.3 Code Plug Harness CP4

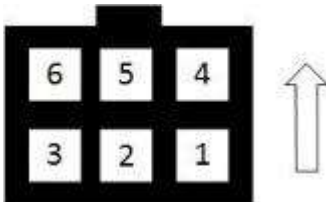

Connector viewed from the back (wiring side) of harness (440FT0032)

Pin	Colour (Prim/Sec)	Name	Function	Application Information
1	White	CP Clock	Code Plug Clock	
2	Red/White	CP 5V	Code Plug 5V	
3	Green	CP Data	Code Plug Data	
4	Red (Twisted with white)	LED	Code Plug LED	
5	NC			Not connected
6	Black/White	GND	Ground	

6.5.4 Serial Harness SR1

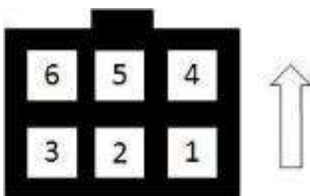

Connector viewed from the back (wiring side) of harness (440FT0931)

Pin	Colour (Prim/Sec)	Name	Function	Application Information
1	Yellow	TXD	RS-232 Transmit	

Pin	Colour (Prim/Sec)	Name	Function	Application Information
2	White	RXD	RS-232 Receive	
3	Blue	RTS	Ready to send	
4	Green	CTS	Clear to send	
5	Red	POSD1	Positive Drive 1	Load current must not exceed 1A. Suitable for driving capacitive loads such as MiX Rovi terminals. Output controlled by MiX 4000 and selected in Vehicle Properties of frontend user software.
6	Brown	GND	Ground	

6.5.5 MiX 4000 Serial Harness 2 (use Serial Harness SR1)

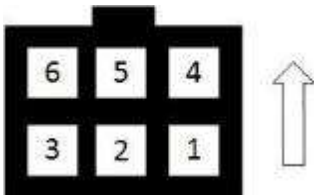

Connector viewed from the back (wiring side) of harness (440FT0931)

Pin	Colour (Prim/Sec)	Name	Function	Application Information
1	Yellow	TXD	RS-232 Transmit	
2	White	RXD	RS-232 Receive	Also used for communication to DTCO D8 line.
3	Blue	RTS	Ready to send	RTS looped to CTS.
4	Green	CTS	Clear to send	RTS looped to CTS.
5	Red	POSD2	Positive Drive 2	Load current must not exceed 0.25 A Output controlled by MiX 4000 and selected in Vehicle Properties of frontend user software.
6	Brown	GND	Ground	

6.5.6 GSM, GNSS and BT Antennas

The Modem, GNSS and BT all have internal antennas. The GNSS has an external antenna option as well to cater for circumstances where better reception is required. Thus, fitting the external antenna is optional. The system detects automatically whether an external antenna is fitted or not. It can also detect tampering, like an external antenna disconnection or a short. In the case where there is no external antenna or in the case of tampering, the system will automatically switch to the internal antenna.

For deep installations with a lot of metal obstruction, it is recommended to use the external antenna.

Refer to the picture in section 5.5 showing the positions of the connectors for the external antennas.

⚠ The Unit contains an internal Modem antenna and must be mounted more than 20cm away from the human body under normal operating conditions.

For best results when the unit cannot be mounted with a good view of the sky, the external GNSS antenna should be used. Mount the GNSS antenna horizontally where the least metal (or any conductive) obstruction between the antenna and the satellites will occur. The top side of the antenna is the rounded side. **For best results place the antenna on a metal surface facing towards the sky** (see picture below). Mount as far away from any radio signal or wire bundles as possible.



- a) Avoid pinching the coaxial cable or bending it sharply (zigzags).
- b) It would be better to circle/coil excess wires. Take care not to tie coax wires too tight. Using the broadest possible cable tie (refer to section [6.4](#)).
- c) The best place to circle/coil the wires is about 300 mm in line from the antenna.

6.5.8 GSM antenna (internal)

The standard product only has an internal Modem antenna.

7 Positioning the MiX 4000 Unit in the vehicle

Note: Please follow the instructions, regarding the positioning of product components, as contained in the "Safety" section, of this document.

- The MiX 4000 must be installed inside the passenger compartment or the driver cabin, to protect it from possible damage by water, solvents, fuel or other environmental factors.
- The MiX 4000 should not be installed in or near the ventilation, heating system, or hot surfaces, which may cause it to overheat or be damaged by condensed water vapour. Also, do not install together with other electronic equipment in an enclosed box that would trap the heat and cause the temperature to rise
- The MiX 4000 should be installed in a position where it will not be subjected to pressure, impact or excessive vibration. Uneven surfaces, where the box can be deformed or damaged should be avoided.
- Select the installation position carefully before proceeding with the installation.
- Mark and drill the required holes.
- Route cables from the unit to the appropriate senders within the vehicle. Additional information can be found in the "Harness Installation" section ([6.5](#) of this document).

8 Starter Interrupt

The MiX 4000 requires an external relay for the interruption of the vehicle’s starter circuit. The relay required should be adequately rated for the purpose intended. Please note that a 30A or 40A (contact rating) relay should be selected. A standard 5 PIN automotive relay manufactured by a reputable supplier (e.g. Bosch) would be adequate. The correct relay operating voltage is required; failure to do so may damage the relay. 24V relays will not function correctly in 12V applications and 12V relays will be damaged when used at 24V.



To connect the relay, it only needs to be plugged into the relay socket on the Main Harness. The two 2mm² black wires represent the two sides of the relay contacts that are controlled via the driver ID Plug. Cut the wires as short as possible, where higher current will be interrupted via the relay. Also use a cable-tie to secure the relay through the mounting ear (5mm hole) to the main harness, or where possible an M5 lock-nut and bolt is to be used to secure the relay to the vehicle. Ensure that the relay wires have enough play on them not to strain the relay terminal crimps connecting the relay to the wires.

It is not necessary to use a relay with a built in protective diode, because the MiX 4000 has built-in protection already. Positive drive/relay outputs are protected against shorts to ground and battery positive and the system can detect these faults. See simplified connection diagram below:

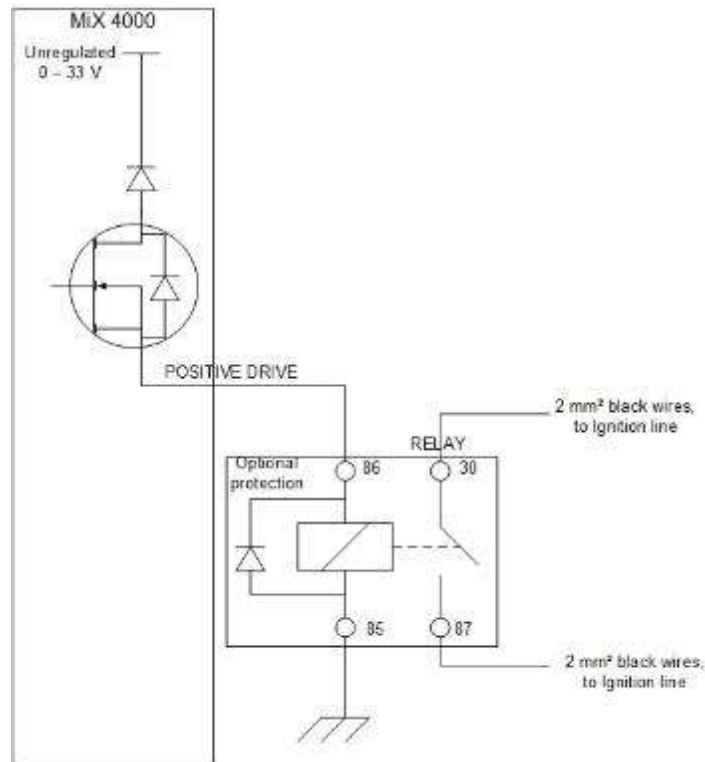

9 Code Plug Socket Installation

Note: Please follow the instructions, regarding the positioning of product components, as contained in the “Safety” section (section 4) of this document.

- The Code Plug Socket must be installed inside the passenger compartment or the driver cabin, to protect it from possible damage by water or other environmental factors.
- The Code Plug Socket should not be installed in or near the ventilation or heating systems, which may cause damage to it due to overheating.
- The Code Plug Socket should be installed in a position where it will not be subjected to pressure, impact or excessive vibration.
- Select the installation position carefully before proceeding with the installation.
- Mark and drill or cut the required hole. Hole size = 13/16” or 20 mm
- Remove the mounting clip from the socket.
- Remove the protection film from the adhesive surface of the foam ring and press it firmly against the back of the interface.
- Insert the socket into the mounting hole and slide the mounting clip into position.

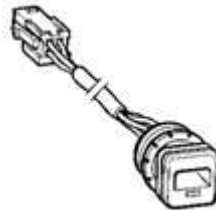

10 Signal Inputs

10.1 Digital Inputs

The MiX 4000 is equipped with two digital/analog inputs (I1-I2), which can be used to monitor digital signals. When the voltage threshold is crossed, an event is triggered. The voltage threshold and the hysteresis are set in software. Please refer to the section on “Harness Installation” for analogs: Pins 3,4 and 9 (Section 6.5.2) of this document, for more details. The external inputs and ignition line are protected from typical vehicle transients and can be directly connected to most vehicle inputs between 0 and 38V (37.95V). The input impedance is >200 kΩ. Typical connections are shown below.

Note: There is no internal pull-up resistor in the MiX 4000, so observe the correct wiring configurations shown below for switching to ground or switching to vehicle supply.

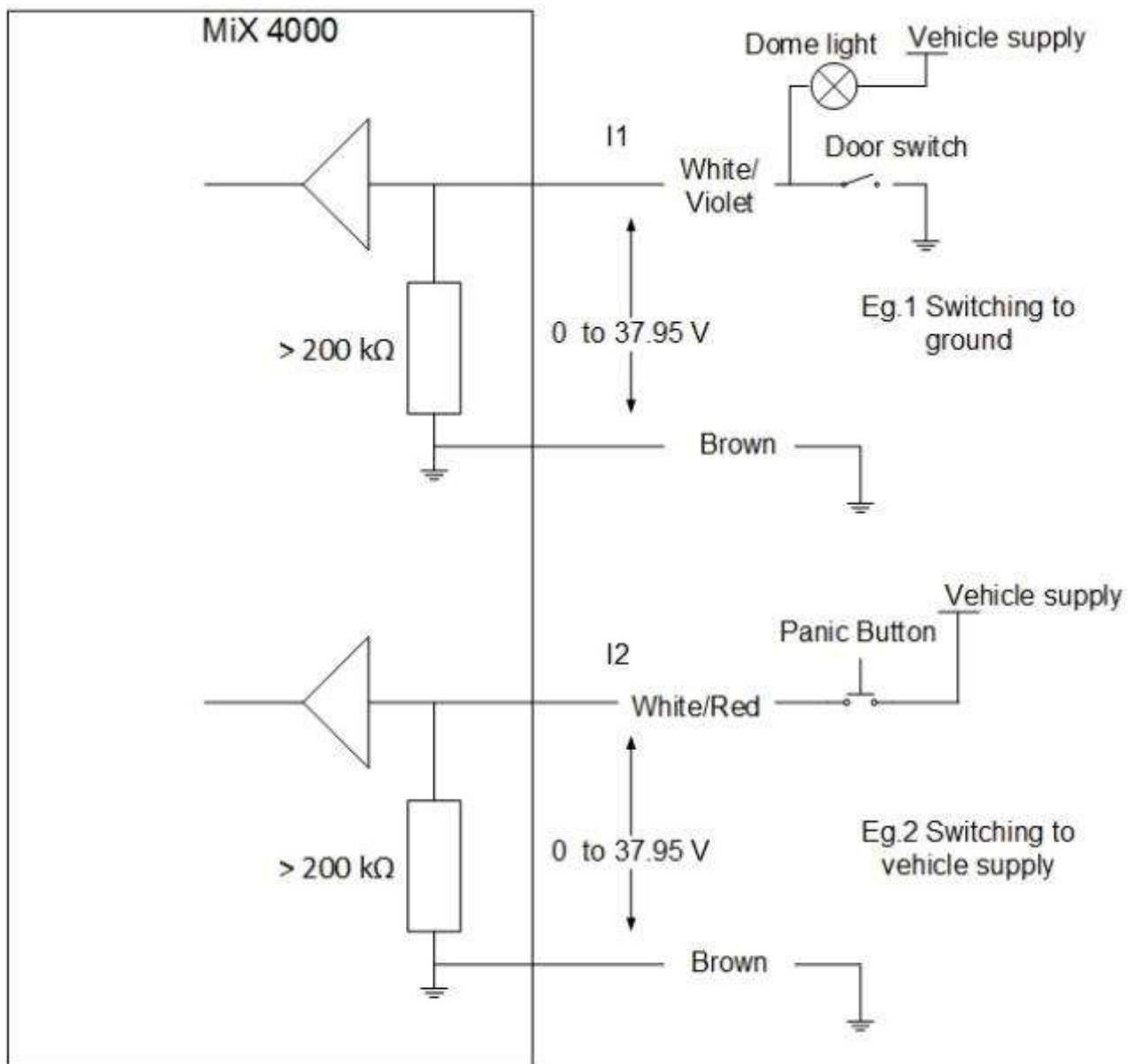

10.2 Ignition Input

The MiX 4000 includes a dedicated ignition input that must be wired if the starter interrupt immobilizer functionality is required. The input should be connected to the ignition signal on the vehicle. The MiX 4000 will automatically compensate for a 12V or 24V vehicle supply and no configuration is required. For a typical connection, see below:

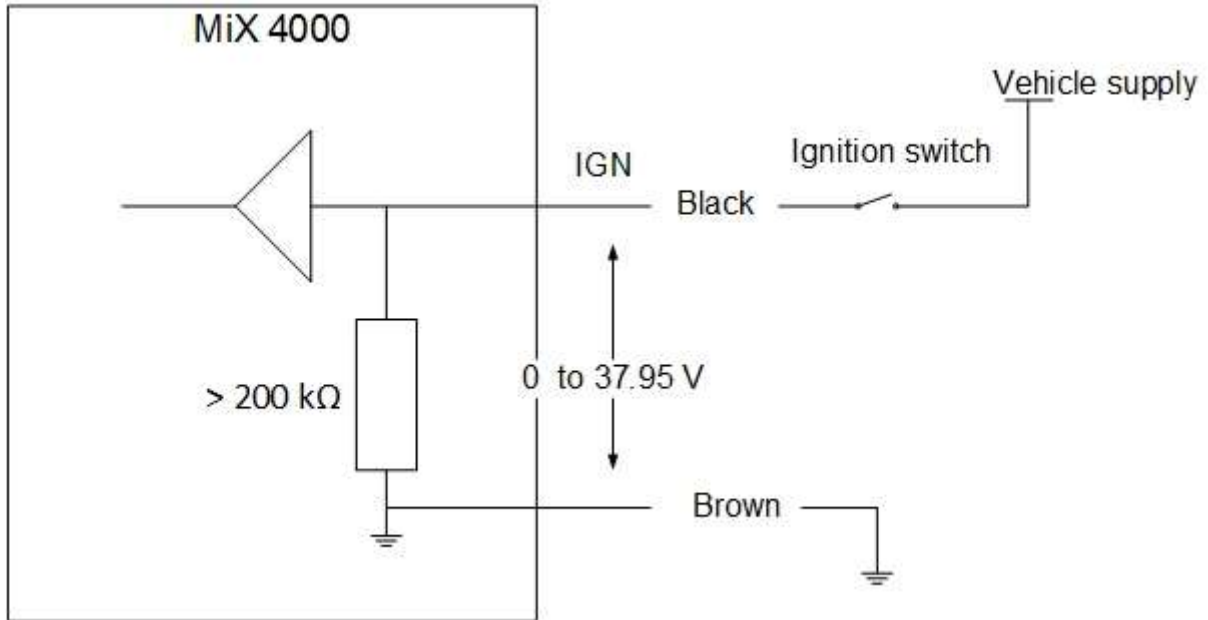

Note: If a minimal installation is being performed and the vehicle's ignition wire is not available, the MiX 4000 can use its internal accelerometer and GNSS measurements of the vehicle's power supply to determine trip start and stop conditions. If this configuration is required, it is important to configure the unit correctly see section 5.3 for more details. For improved trip start/end plotting accuracy on the MiX Telematics Fleet Manager user interface, it is recommended that the wired ignition configuration be used.

11 Power Outputs

11.1 Positive Drive

The Positive Drive output supplies power to MiX 4000 accessories. There are four Positive Drives in total.

- This output is controlled by the MiX 4000 and is configured in the vehicle properties of the Fleet Manager Application software.
- Access to these outputs is described in section 5.5.
- Do NOT connect an external voltage to the positive drive line.

Positive drive 1 can drive at least 1A and is suitable for powering up capacitive loads such as a MiX Rovi terminal, while the remaining drives can manage 250 mA each. These circuits are protected against over current and voltage. Should "Positive Drive 1" be occupied already and it is necessary to drive more peripheral devices (e.g. MiX Rovi, MiX Display, etc.) that draw more than 250 mA at any stage, it is advisable to make use of an alternative relay to ensure reliable functionality.

Below is a functional block diagram that describes how to wire such a device.

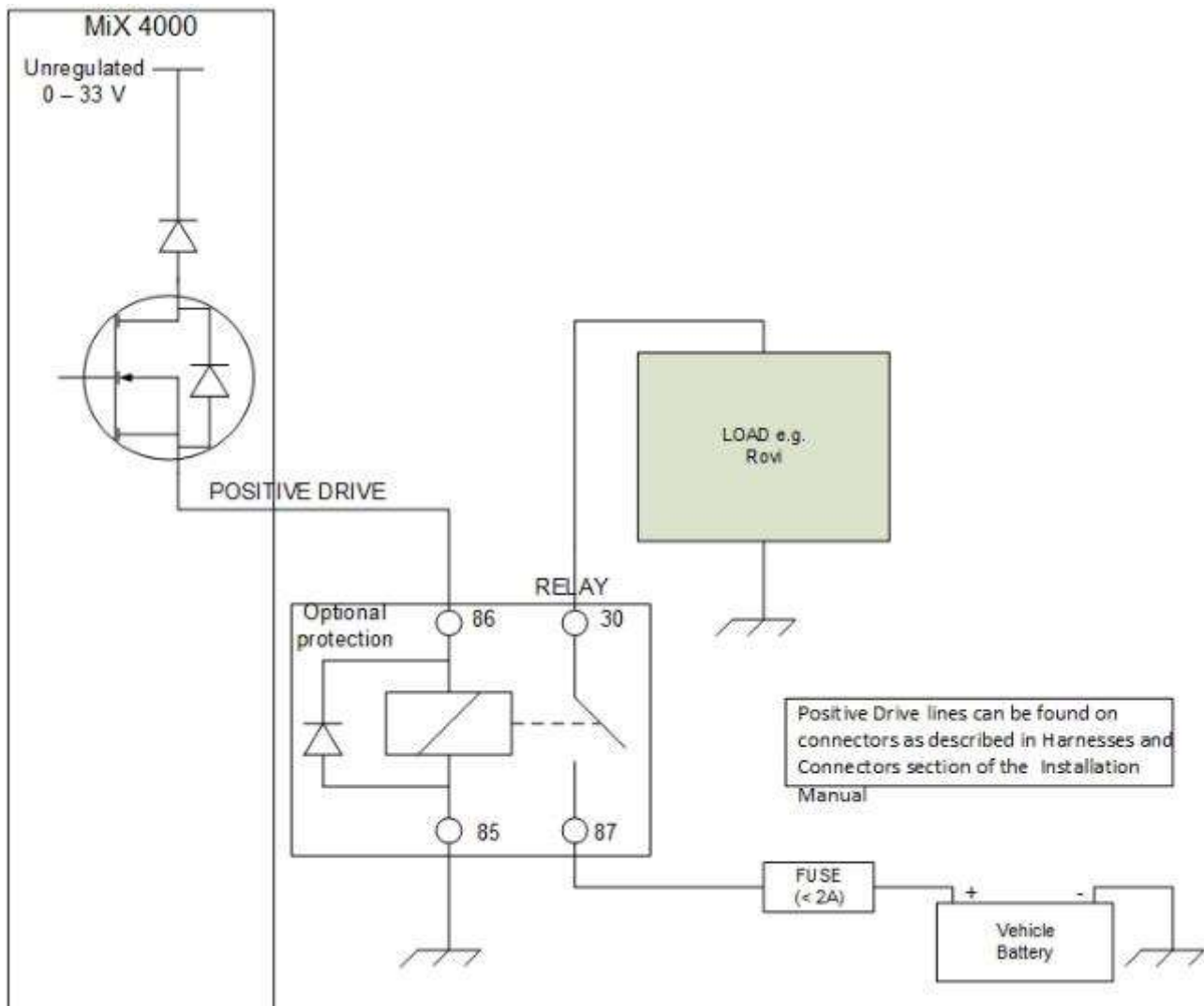

Please refer to the Starter Interrupt section 8 of this document, for more details.

12 Serial Communication

The MiX 4000 is equipped with two RS232 external serial ports. Refer to section [6.5](#) for details of the wiring. The serial ports can be used to connect to external peripherals.

Serial 1 does RTS/CTS flow control, and is paired with POSD1, so it is suitable for connection to Rovi terminals and other devices that use more power. It is normally enabled, even when the vehicle is out of trip

Serials 2 does also have RTS/CTS flow control, and is paired with POSD2. It is suitable for general purpose use, however, sometime after the vehicle is out of trip these ports may be disabled to reduce power consumption. It is intended for general purpose use or as a D8 input for DTCO use. It is normally enabled, even when the vehicle is out of trip

All serial ports are capable of up to 115200 baud operation.

13 CAN

13.1 Overview

Installation of MiX 4000 CAN-bus should only be carried out by trained installers:

- Improper connection of the MiX 4000 to the vehicle's CAN-bus may cause interference with the vehicle's normal operation.
- The MiX 4000 is already loaded with compatible device drivers.
- The unit still needs to be configured for the vehicle in which it will be installed, and the vehicle ID and odometer still need to be configured. Specifically, the MiX 4000 may not record any CAN data until it is configured.

After installation, verify that no interference is caused to the vehicle's electrical system. Check dashboard warning lights and error messages. Should any error conditions exist, remove the MiX 4000 installation and contact MiX Telematics for assistance.

- Colour coding of the wires are shown in section [6.5.2](#):
 - A green and a yellow wire, connected to pins 9 and 10 on the Main Harness, designate CAN1 Interface wires.
 - A green/black and a yellow/black wire, connected to pins 16 and 15 on the Main Harness, designate CAN2 Interface wires.
 - The convention is that the wire with the colour closer to white in the spectrum (lighter colour) is CAN-H and the wire with the colour closer to black in the colour spectrum (darker colour) is CAN-L.
 - This means that the Green wire is CAN-L and the Yellow wire is CAN-H. If the wires are not already twisted together they should be twisted together now.
- The MiX 4000 has a total of four Jumpers on the main PCB (SW3) to set the Read/Write or "Listen Only" mode and the Terminating Resistor (120 Ohm) of each CAN interface (see Figure 7 on the next page).

13.1.1 Tools and Inspection needed for CAN Installation:

Supporting tools

- Multi-meter
- Oscilloscope
- Laptop with CAN to USB interface (for example Vector CANcaseXL, IXXAT)

- Identify possible CAN busses by looking for twisted pair wires in the vehicle.
- With the vehicle's ignition turned on, measure the voltages relative to ground on each of the wires using a multi-meter.
 - For CAN, the voltage readings of the two wires should be very similar (usually 2.5V), with CAN-H likely to read only slightly higher than CAN-L.
- The actual data can be probed using an oscilloscope.
- With a properly configured 3rd party CAN tool, like the Vector CANcaseXL, the actual data can be recorded.
- CAN Baud rates of 250kb/s (SAE J1939) and 500kb/s are the most common.

13.1.2 Wire lengths

The CAN stub wires between the MiX 4000 and the vehicle's bus should be no longer than 1m. Excessive wire length may cause interference with the vehicle's normal operation.

13.1.3 CAN jumper settings

⚠ Warning: It is very important to ensure that these jumper settings are correct at installation time. If these jumpers are set incorrectly it is possible that when a new configuration or script is downloaded to the MiX 4000, it could bring down the CAN bus of the vehicle and interfere with the operation of the vehicle.
 Conduct ESD precautions as described in section [4.4](#).

Refer to Figure 7 and the table on the next page:



Figure 7: Position of jumpers on the PCB.

Setting 1 (FACTORY DEFAULT)

All Jumpers inserted

- 120 Ω Termination under software control
- RD/WR or "Listen Only" mode is under software control

When all SW1 jumpers are inserted, both CAN1 and CAN2 interfaces are set for:

- 120 Ω termination is under software control (i.e. the software can switch the 120 Ω resistor in or out of the circuit).
- RD/WR or "Listen Only" mode is under software control (i.e. the software can transmit messages on the CAN bus).

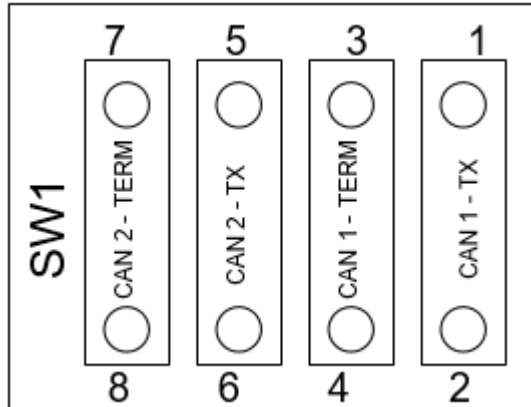

Setting 2

All jumpers removed

- NOT Terminated (120 Ω)

"Listen Only" mode

When all SW1 jumpers are removed, both CAN1 and CAN2 interfaces are set for:

- 120 Ω termination is disabled (i.e. the 120 Ω termination resistor is removed from the circuit and cannot be switched in by software).
- "Listen Only" mode (i.e. the software cannot transmit any messages).

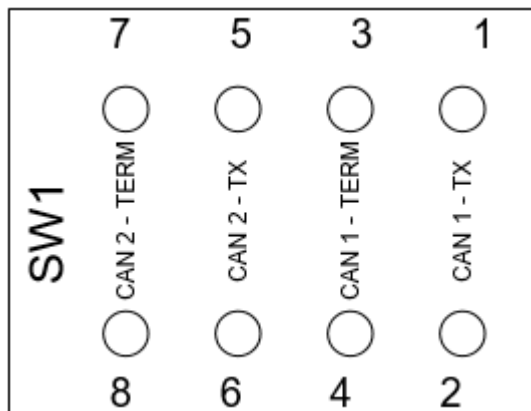

Setting 3

Jumpers 3-4 and 7-8 inserted

- 120 Ω Termination is under software control
- "Listen Only" mode

When SW1 jumpers 3-4 and 7-8 are inserted, both CAN1 and CAN2 interfaces are set for:

- 120 Ω termination is under software control (i.e. the software can switch the 120 Ω resistor in or out of the circuit).
- "Listen Only" mode (i.e. the software cannot transmit any messages).

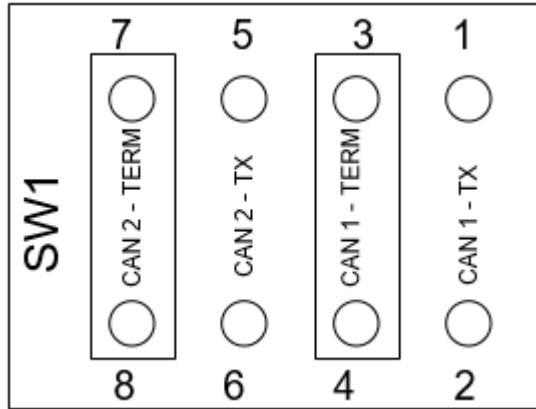

Setting 4

Jumpers 1-2 and 5-6 inserted

- NOT Terminated (120 Ω)
- RD/WR or "Listen Only" mode is under software control

When SW1 jumpers 1-2 and 5-6 are inserted, both CAN1 and CAN2 interfaces are set for:

- RD/WR or "Listen Only" mode is under software control (i.e. the software can transmit messages on the CAN bus).
- 120 Ω termination is disabled (the 120 Ω termination resistor is removed from the circuit and cannot be switched in by software).

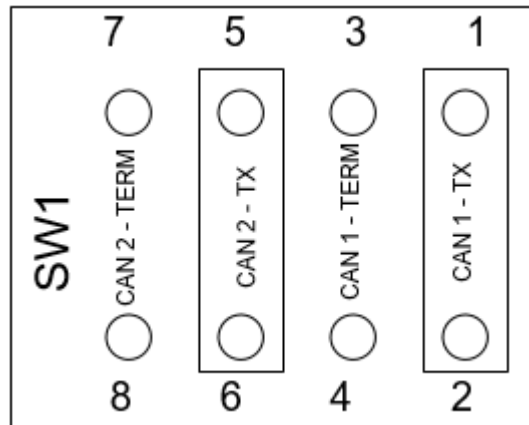

13.1.4 When must the 120 Ohm terminating resistor be in the circuit?

- A properly terminated CAN bus will have a DC resistance of approximately 60 Ω (one 120 Ω terminating resistor at each end).
- By measuring the DC resistance on the vehicle bus between CAN-H and CAN-L, before the MiX 4000 is connected, an installer can determine whether additional termination is required.
- **If the resistance measures 60 Ω, no further termination is required.**
- If it measures 120 Ω, then additional termination must be configured.
- To configure additional termination, the jumper must be fitted and the termination resistor enabled in the software.
- See the table below for a diagram of a CAN bus that is correctly terminated and how the 60 Ω is calculated.

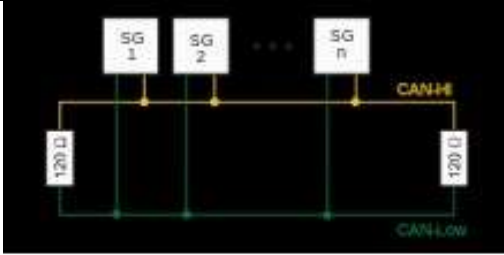
DC Resistance Calculation	Correctly terminated CAN bus with 120 Ω resistors at both ends.	Incorrectly terminating CAN bus with 120 Ω resistors at both end and a node that puts another 120 Ω resistor in circuit.
$R_{total} = 1/(1/R1+1/R2)$ $R1 = 120 \Omega$ $\text{and } R2 = 120 \Omega$ $R_{total} = 1/(1/120+1/120)$ $R_{total} = 60 \Omega$		<p>If you measure less than 60 Ω (e.g. 40 Ω), then it means the CAN Bus is already incorrectly terminated and loaded by another 120 Ω resistor (R3).</p> <p>In this case DO NOT ATTEMPT to connect to this CAN bus under any circumstances and seek the advice of the owner to determine why the CAN bus is incorrectly terminated.</p> $R_{total} = 1/(1/R1+1/R2+1/R3)$ $R1 = 120 \Omega \text{ and } R2 = 120 \Omega \text{ and } R3 = 120 \Omega$ $R_{total} = 1/(1/120+1/120+1/120) = 40 \Omega$

13.1.5 General Rules for CAN terminating resistors

- A properly terminated CAN bus will have a DC resistance of approximately 60 Ω (one 120 Ω terminating resistor at each end). By measuring the DC resistance on the vehicle bus between CANH and CANL, before the MiX 4000 is connected, an installer can determine whether additional termination is required. If the resistance measures 60 Ω, no further termination is required. If it measures 120 Ω, then additional termination must be configured. To configure additional termination, the jumper must be fitted and the termination resistor enabled in the software.
- Typically, a bus showing 120Ω before installation will only have one node on it, and will not be safety critical. Examples of this might be a DTCO bus or any of the OBDII connections.
- A bus showing 40 Ω before installation may indicate triple termination, which can cause CAN errors and failure. If this is the case, it is best to advise the customer and ensure this error is corrected by removing the offending unit or termination before MiX 4000 installation.
- For non-safety-critical CAN bus installations, it is recommended to leave the jumper fitted and configure the termination resistor to OFF or ON in software, as needed, as this allows the maximum flexibility.

- For safety-critical CAN bus (e.g. so-called “hot bus”) installations where a hard disconnect must be guaranteed and physical safety is needed, the 120 Ω termination jumper must be removed. This will guarantee that termination resistors cannot be accidentally enabled by software, potentially disrupting the CAN bus. Note that permission from the customer to connect to a safety critical CAN bus should always be obtained.
- If the installer is in doubt as to the safety critical nature of the CAN bus, the jumper must be left off.
- After installation of the MiX 4000 and configuration of the termination resistance the CAN bus should measure as 60 Ω, with the unit powered on and if not, the settings should be checked.
- Note that the MiX 4000 terminating resistor automatically disconnects from the CAN bus if the MiX 4000 unit loses power.

13.1.6 When must the RD/WR Jumpers be in the circuit?

- For non-safety-critical CAN bus installations, it is recommended to leave the transmit enable jumper fitted and configure the transmit enable to OFF or ON in software, as needed, as this allows the maximum flexibility.
- For OBDII connections the RD/WR (transmit enable jumper) must be fitted, since OBDII is a request/response protocol and requires the MiX 4000 to transmit messages on the CAN bus.
- For safety-critical CAN bus (e.g. so-called “hot bus”) installations where guaranteed, physical safety is needed, the transmit enable jumper must be removed. This will guarantee that transmissions cannot be accidentally enabled by software, potentially disrupting the CAN bus.
- **⚠ Note that permission from the customer to connect to a safety critical CAN bus should always be obtained.**
- If the installer is in doubt as to the safety critical nature of the CAN bus, the jumper must be left off.
- Some FMS gateways requires an acknowledgement (“ACK”) on the physical layer and the RD/WR (transmit enable jumper) must be fitted for the CAN chip to be able to assert the “ACK” bit in the header, otherwise the host will stop transmitting any CAN messages. See diagram below. Note that no messages are transmitted on the CAN bus, the messages are just acknowledging, so this is a safe mode.

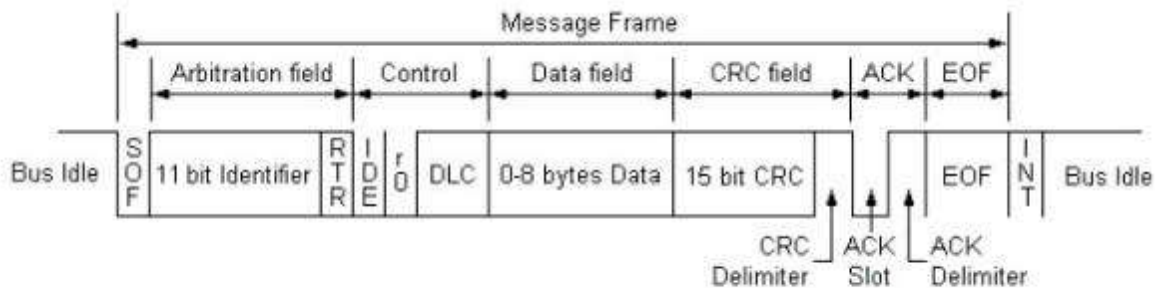

- SOF: Start of frame (start bit)
- ID: Message identifier (indicates msg priority)
- RTR: Remote transmission request
- IDE: Identifier extension bit (2.0A or 2.0B)
- r0: Reserved bit. Sent as dominant.
- DLC: Data length code. Valid range 0 – 8.
- CRC D: CRC delimiter. Marks end of CRC field.
- ACK S: Used for receiver to ACK msg. Sent as recessive.**
- ACK D: Marks end of ACK field.
- EOF: End of frame. (stop bit). Sent as 7 recessive bits.
- INT: Intermission. Sent as 3 recessive bits.

13.2 DLD and DTCO

The MiX 4000 also satisfies the need for Remote DTCO Download functionality by incorporating CAN, D8 and K-line communication. The main functionality is the ability to remotely download DTCO data as well as the D8 status change for the Hours of Service solution.

This functionality allows the user to perform the following:

- Synchronise download schedules.
- Authenticate remote tachograph cards.
- Transfer downloaded files to back-office archiving systems.
- Receive updated firmware and configuration settings.

13.2.1 D-8

The D8-line is a free running data interface for fleet management systems. The DTCO information (like date, time, currently selected driver and co-driver activity, hours of service, speed of vehicle, etc.) is sent on this communication line. The receiving line of Serial Port 2 is used for the D8-line. The pin numbers of the serial port are shown in sections [6.5.5](#). Connect to pin 2 (of Serial Port 2 on MiX 4000 PCB) to pin 8 of the brown DTCO D-connector.

13.2.2 Connect CAN to DTCO

Refer to section [13.1](#) on CAN. One of the available CAN busses (normally CAN #2) can be routed to the DTCO CAN. The Yellow and Green wires must be routed to DTCO C (red) connector pin 5 (Yellow/black) (CAN-H) and 7 (Green/black) (CAN-L). See pictures below.



13.2.3 K-line

Connect the DTCO K-line to pin 13 of the Auxiliary 1 Harness (see section [6.5.2](#)).

14 MiX TechTool

An Android and iOS version of “MiX TechTool” is available that can connect to the MiX 4000 via Bluetooth. Refer to the documentation on this tool for detailed instructions.

15 After Installation

15.1 Beep codes

The MiX 4000 has an output that drives a buzzer. The buzzer is not included inside the enclosure but is part of the 10-wire main harness. If any of the other reduced wire count main harnesses are installed, beep codes will not be audible.

The following beep codes will apply when a harness with an external buzzer is installed:

- Triple beep when an over speeding, harsh braking, harsh acceleration or harsh cornering event occurs.
- Continuous slow beeping at trip start for the duration of the user configured driver ID prompt period.

(When a valid driver ID is inserted, two short beeps will sound and the slow prompt beeps will stop – Default driver ID prompt period is set to zero seconds, disabling the driver ID prompt).









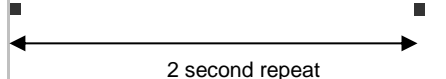

This setting is under Software Configuration control, so the behaviour will depend on the configuration settings.

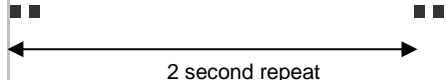
15.2 LED flash codes

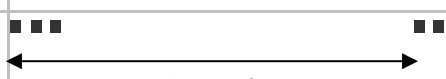











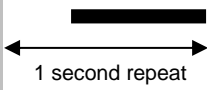

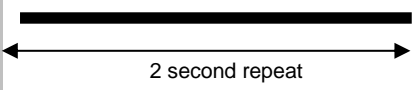

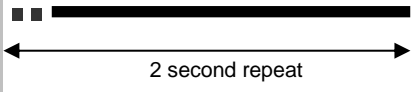
The MiX 4000 has two LED's for diagnostic purposes. Refer to Figure 8 below.

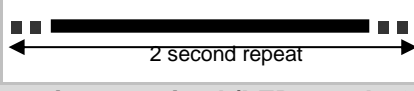

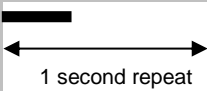
15.2.1 GPS LED flash codes (GREEN)

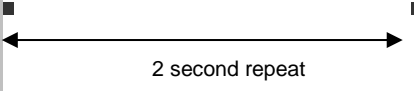
Out of trip (2 second repeat cycle, LED mostly OFF)			
Out of trip with no GPS lock			GREEN LED: One short ON blip once every two seconds
Out of trip with 2D GPS lock			GREEN LED: Two short ON blips every two seconds
Out of trip with 3D GPS lock			GREEN LED: Three short ON blips every two seconds
In trip (1 second repeat cycle, LED mostly ON)			
In trip with no GPS lock			GREEN LED: Toggles ON/OFF in quick succession continuously
In trip with 2D GPS lock			GREEN LED: 50% ON and 50% toggling ON/OFF in quick succession every second
In trip and GPS has acquired 3D lock. The unit will subsequently be able to report accurate GPS points.			GREEN LED: Mostly ON followed by two short OFF blips every second

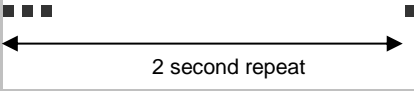
15.2.2 GSM LED flash codes (RED)

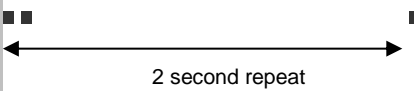
No communication settings received (LED mostly ON)			
GSM OFF			RED LED: OFF
GSM ON, searching for network*			RED LED: Mostly ON with some OFF time once every second
SMS only			RED LED: Almost completely ON with one short OFF blip once every two seconds
GPRS ready			RED LED: Almost completely ON with three short OFF blips once every two seconds
GSM Connected			RED LED: Almost completely ON with two short OFF blips once every two seconds
Communication settings received (LED mostly OFF)			
GSM OFF			RED LED: OFF
GSM ON, searching for network			RED LED: Mostly OFF with some ON time once every second
SMS only			RED LED: Almost completely OFF with 1 short ON blip once every two seconds
GPRS ready			RED LED: Almost completely OFF with 3 short ON blips once every two seconds
GSM Connected			RED LED: Almost completely OFF with 2 short ON blips once every two seconds

16 Testing Installation

16.1 Test Drive

Disarm the system by inserting the blue plug into the Code Plug socket.

- Wait for the audible signal.
- Remove the plug.
- Start the engine.
- Carry out a test drive.

17 Closing Steps

- Check all relevant vehicle functions.
- Explain the functions of the MiX 4000 system to the user.

18 Troubleshooting

Supporting documentation can be found on Confluence:

<https://confluence.mixtelematics.com/pages/viewpage.action?spaceKey=MFHF&title=MIX+4000+Home+Page>

The audible and visual information generated by the MiX 4000 are described in sections [15.1](#) and [15.2](#) of this document.

Symptom	Probable Cause	Action
Unit does not switch ON (LED does not flash)	No battery voltage applied to MiX 4000.	<ul style="list-style-type: none"> • Check the voltage supply to the MiX 4000. • Ensure the connectors are properly fitted. • Check fuse if applicable.
GPS does not get lock	<p>Orientation of the unit is incorrect.</p> <p>Location of unit is limiting good GPS reception (internal antenna).</p> <p>Location of the GPS antenna is limiting good GPS reception (external antenna).</p>	<ul style="list-style-type: none"> • Mount the unit with the rounded surface facing up, and the label side down. • Install the unit in a location where the GPS view of the sky is relatively unobstructed by metal or conductive parts. Refer to section 6.5.7 • If this is not possible, it may be necessary to install the external GPS antenna. • Check the installation of the external GPS antenna and ensure that the antenna is facing towards the satellites view of the sky is relatively unobstructed by metal or conductive parts.
GSM unable to register on network (see GSM LED flash codes in section 15.2)	<p>No SIM card inserted or SIM inserted the wrong way round.</p> <p>Automatic commissioning is not possible on the GSM network selected.</p> <p>GSM network is out of range.</p>	<ul style="list-style-type: none"> • Refer to section 5.2 for the correct SIM card orientation. Alternatively replace the SIM card • Use a serial configuration harness and the Configuration software to manually program APN and server settings for the unit • Check coverage of chosen GSM network using coverage map or a cell phone on the same network • If the MiX 4000 fails to detect a MiX approved GSM antenna it will switch to internal antenna operation.

19 Routine Maintenance

Item	Maintenance	Period
1)	Please ensure that the Code Plug Socket is kept clean and free of dust and dirt. This part is available as an accessory if it needs to be replaced.	Monthly
2)	The internal battery needs to be replaced when a replacement message is generated. Replace the battery if it is swollen.	Back End Warning Message

20 MiX 4000 Specifications

20.1 Technical description

Refer to the section on Product Variants and Part Numbers (Section 2) for more details.

20.2 Auxiliary inputs/outputs

2 x Configurable Analogue or Digital Inputs (I1 to I2)	<p>2 analogue or digital inputs can be configured to monitor any device that generates a change in voltage. E.g. seat belts, headlights, refrigeration units, temperature sensors, emergency lights, doors, PTO, UDS, trailer coupling etc. Voltages are measured in the range of 0 – 38V (37.95V) in steps of approximately 9.3 mV and 0 - 4.95 V in steps of 1.2 mV.</p> <p>Do not connect signals from unsuppressed inductive sources such relay coils (where severe voltage spikes can be generated).</p>
1 x Speed Input	<p>F1 input can measure speed pulses. The input impedance is 100 kΩ. Frequencies of up to 20 kHz can be measured.</p> <p>Maximum signal voltage level = 38V (37.95V)</p> <p>Disconnection of this input can be detected using open-wire detect.</p>
1 x RPM Input	<p>F2 input can measure RPM pulses. The input impedance is 94 kΩ. Speed and RPM calibration sensitivity is configurable.</p> <p>Frequencies up to 20 kHz can be measured.</p> <p>Maximum signal voltage level = 38V (37.95V)</p> <p>Disconnection of this input can be detected using open-wire detect.</p>
2 x RS232 Serial Interface	<p>This can be connected to any RS232 serial device.</p>
2 x CAN Interface	<p>This can be connected to a J1939 CAN bus, termination resistors and transmit disable can be configured by jumpers (for safety-critical installs) or by settings.</p>
1 x Positive Drive	<p>Positive Drive output is used to power external devices at a current up to 1A. Disconnection of loads can be detected using open-load detect.</p>
3 x Positive Drive	<p>Positive Drive outputs are used to power external devices at currents up to 250 mA. Disconnection of loads can be detected using open-load detect.</p>
1 x K-line	<p>DTCO K-line</p> <p><i>⚠ The K-line circuit is not designed for a scenario where the signal line is short circuited to vehicle supply for a prolonged period while transmitting data.</i></p>
1 x D8	<p>The D8-line is a free running data interface for fleet management systems. The DTCO information (like date, time, currently selected driver and co-driver activity (hours of service), speed of vehicle etc.) is sent on this communication line. The receive line of Serial Port 2 is used for the D8-line.</p>

Ignition input	The ignition input is used only to monitor the vehicle’s ignition line state, and can measure up to 38V (37.95V). Disconnection of this wire can be detected with open-wire detect.
-----------------------	---

21 Peripheral Power Manager

The MiX 4000 is equipped with outputs to power additional peripherals. When making use of the positive drive outputs, adjust the peripheral power management settings within the unit configuration to avoid excessive current draw from the peripherals when ignition is off.

Below are examples of standard and strict settings:

STANDARD POWER MANAGEMENT

Peripheral power management	
Automatic shutdown of peripheral devices	<input checked="" type="checkbox"/>
- Turn peripheral devices off when asset is parked for more than	18 : 0 : 0 (64800 seconds)
After waking up, leave peripheral devices on for	0 : 15 : 0 (900 seconds)
Surfacing	<input checked="" type="checkbox"/>
- Switch peripheral devices on every	4 : 0 : 0 (14400 seconds)
- Limit number of times to surface	<input checked="" type="checkbox"/>
-- Only surface a maximum of	10 times

STRICT POWER MANAGEMENT

Peripheral power management	
Automatic shutdown of peripheral devices	<input checked="" type="checkbox"/>
- Turn peripheral devices off when asset is parked for more than	0 : 15 : 0 (900 seconds)
After waking up, leave peripheral devices on for	0 : 15 : 0 (900 seconds)
Surfacing	<input checked="" type="checkbox"/>
- Switch peripheral devices on every	12 : 0 : 0 (43200 seconds)
- Limit number of times to surface	<input checked="" type="checkbox"/>
-- Only surface a maximum of	5 times

NB! Do not use the power outputs when connecting critical or emergency type of inputs i.e. Panic or Tamper Switch – these type of inputs will require a permanent power source in the event of emergency that the events do in fact record.

22 Backup Battery Replacement Procedure

Since July 2018 units ordered with a battery, are shipped with the battery already plugged in. Should it be necessary to replace the battery, refer to the steps below for fitting the battery:

- 1) Unhook the clips and remove the cover.



- 2) Unplug the old battery and remove the battery by pulling it out.
- 3) Insert the replacement battery with the wire/connector end to the right.
- 4) Fully insert the battery (⚠ *Take care not to damage the wire connection below the orange foil*).
- 5) Insert the battery connector into the socket on the PCB. Note, that it is a keyed connector. Ensure the battery connector is fully inserted.
- 6) Fold the battery wire lead in the open space to the right of the battery.



7) Clip the cover back on; ensure the hooks click into place.



23 Glossary

Abbreviation	Description
BT	Bluetooth
DLD	Download Device
DTCO	Digital Tachograph
GPS	Global Positioning System
GSM	Global System for Mobile Communications
GND	Ground (0V)
RX	Receive
TX	Transmit
WiFi	Local Area Wireless Computer Network
BT	Bluetooth