



## FCC PART 15 SUBPART C TEST REPORT

### FCC PART 15.247

**Report Reference No.....: GTSR16110086-WLAN**

**FCC ID..... : 2AFAPET**

Compiled by  
 ( position+printed name+signature)..: File administrators Jimmy Wang



Supervised by  
 ( position+printed name+signature)..: Test Engineer Peter Xiao



Approved by  
 ( position+printed name+signature)..: Manager Sam Wang

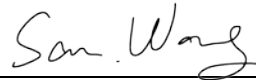

Date of issue.....: Dec. 02, 2016

**Representative Laboratory Name.: Shenzhen Global Test Service Co.,Ltd.**

Address .....: 1F, Building No. 13A, Zhonghaixin Science and Technology City, No.12,6 Road, Ganli Industrial Park, Buji Street, Longgang District, Shenzhen, Guangdong

**Applicant's name.....: ALPHA EXPORT AND IMPORT CO.,LIMITED**

Address .....: Room 4d,Huashang Block,NO.3,Biezhan Road,Shenzhen,China

**Test specification .....**

Standard .....: **FCC Part 15.247: Operation within the bands 902-928 MHz, 2400-2483.5 MHz and 5725-5850 MHz**

**Shenzhen Global Test Service Co.,Ltd. All rights reserved.**

This publication may be reproduced in whole or in part for non-commercial purposes as long as the Shenzhen Global Test Service Co.,Ltd. is acknowledged as copyright owner and source of the material. Shenzhen Global Test Service Co.,Ltd. takes no responsibility for and will not assume liability for damages resulting from the reader's interpretation of the reproduced material due to its placement and context.

**Test item description .....** Mobile Phone

Trade Mark .....: ALPHARD

Manufacturer .....: **ALPHA EXPORT AND IMPORT CO.,LIMITED**

Model/Type reference.....: ET1

Listed Models .....: ET2,ET3,ET4,ET5,ET6,ET7,ET8,ET9,ET10

Operation Frequency.....: From 2412MHz to 2462MHz

Hardware Version .....: Z6U110\_MB\_V1.1

Software Version .....: V1.0

Rating .....: DC 3.85V

Result.....: **PASS**

# TEST REPORT

<b>Test Report No. :</b>	<b>GTSR16110086-WLAN</b>	Dec. 02, 2016
		Date of issue

Equipment under Test : Mobile Phone

Model /Type : ET1

Listed Models : ET2,ET3,ET4,ET5,ET6,ET7,ET8,ET9,ET10

**Applicant : ALPHA EXPORT AND IMPORT CO.,LIMITED**

Address : Room 4d,Huashang Block,NO.3,Biezhan Road,Shenzhen,China

**Manufacturer : ALPHA EXPORT AND IMPORT CO.,LIMITED**

Address : Room 4d,Huashang Block,NO.3,Biezhan Road,Shenzhen,China

<b>Test Result:</b>	<b>PASS</b>
---------------------	-------------

The test report merely corresponds to the test sample.  
 It is not permitted to copy extracts of these test result without the written permission of the test laboratory.

## Contents

<b><u>1.</u></b>	<b><u>TEST STANDARDS .....</u></b>	<b><u>4</u></b>
<b><u>2.</u></b>	<b><u>SUMMARY .....</u></b>	<b><u>5</u></b>
2.1.	General Remarks	5
2.2.	Product Description	5
2.3.	Equipment Under Test	5
2.4.	Short description of the Equipment under Test (EUT)	5
2.5.	EUT operation mode	6
2.6.	Block Diagram of Test Setup	6
2.7.	Related Submittal(s) / Grant (s)	6
2.8.	Modifications	6
2.9.	NOTE	6
<b><u>3.</u></b>	<b><u>TEST ENVIRONMENT .....</u></b>	<b><u>7</u></b>
3.1.	Address of the test laboratory	7
3.2.	Test Facility	7
3.3.	Environmental conditions	7
3.4.	Test Description	8
3.5.	Statement of the measurement uncertainty	9
3.6.	Equipments Used during the Test	9
<b><u>4.</u></b>	<b><u>TEST CONDITIONS AND RESULTS.....</u></b>	<b><u>10</u></b>
4.1.	AC Power Conducted Emission .....	10
4.2.	Radiated Emission.....	13
4.3.	Maximum Peak Output Power.....	21
4.4.	Power Spectral Density .....	22
4.5.	6dB Bandwidth .....	25
4.6.	Band Edge Compliance of RF Emission .....	28
4.7.	Spurious RF Conducted Emission .....	32
4.8.	Antenna Requirement.....	42
<b><u>5.</u></b>	<b><u>TEST SETUP PHOTOS OF THE EUT .....</u></b>	<b><u>43</u></b>
<b><u>6.</u></b>	<b><u>EXTERNAL AND INTERNAL PHOTOS OF THE EUT .....</u></b>	<b><u>44</u></b>

## **1. TEST STANDARDS**

The tests were performed according to following standards:

[FCC Rules Part 15.247](#): Frequency Hopping, Direct Spread Spectrum and Hybrid Systems that are in operation within the bands of 902-928 MHz, 2400-2483.5 MHz, and 5725-5850 MHz.

[ANSI C63.10-2013](#): American National Standard for Testing Unlicensed Wireless Devices

[KDB558074 D01 V03r05](#): Guidance for Performing Compliance Measurements on Digital Transmission Systems (DTS) Operating Under §15.247

## 2. SUMMARY

### 2.1. General Remarks

Date of receipt of test sample	:	October. 21, 2016
Testing commenced on	:	October. 22, 2016
Testing concluded on	:	December. 02, 2016

### 2.2. Product Description

Name of EUT	Mobile Phone
Model Number	ET1
Listed Models	ET2,ET3,ET4,ET5,ET6,ET7,ET8,ET9,ET10
FCC ID	2AFAPET
Power Supply	Battery DC 3.85V
Supported type:	802.11b/802.11g/802.11n HT20
Modulation:	802.11b: DSSS(CCK,DQPSK,DBPSK) 802.11g: OFDM(64QAM, 16QAM, QPSK, BPSK) 802.11n HT20: OFDM (64QAM, 16QAM, QPSK,BPSK)
Operation frequency:	802.11b:2412-2462MHz 802.11g:2412-2462MHz 802.11n HT20:2412-2462MHz
Antenna Type	Internal Antenna
Antenna gain	-0.75dBi

### 2.3. Equipment Under Test

#### Power supply system utilised

Power supply voltage	:	<input type="radio"/> 230V / 50 Hz	<input type="radio"/> 120V / 60Hz
		<input type="radio"/> 12 V DC	<input type="radio"/> 24 V DC
		<input checked="" type="radio"/> Other (specified in blank below)	

DC 3.85V

### 2.4. Short description of the Equipment under Test (EUT)

This is a Mobile Phone.

For more details, refer to the user's manual of the EUT.

### 2.5. EUT operation mode

The application provider specific test software to control sample in continuous TX and RX (Duty Cycle >98%) for testing meet KDB558074 test requirement.

IEEE 802.11b/g/n: Thirteen channels are provided to the EUT.

Channel	Frequency(MHz)	Channel	Frequency(MHz)
1	2412	8	2447
2	2417	9	2452
3	2422	10	2457
4	2427	11	2462
5	2432		
6	2437		
7	2442		

### 2.6. Block Diagram of Test Setup

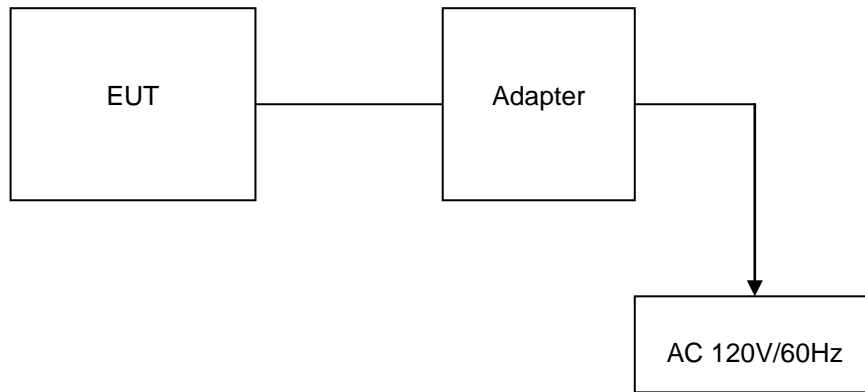

**Adapter:**

Model: NOKOKO-4  
 Input: 100-240V~50/60Hz 0.5A  
 Output:5V DC 1A  
 ◇ Shielded      ◆ Unshielded

### 2.7. Related Submittal(s) / Grant (s)

This submittal(s) (test report) is intended for **FCC ID: 2AFAPET** filing to comply with Section 15.247 of the FCC Part 15, Subpart C Rules.

### 2.8. Modifications

No modifications were implemented to meet testing criteria.

### 2.9. NOTE

	Test Standards	Reference Report
Bluetooth-EDR	FCC Part 15 Subpart C	GTSR16110086-EDR
WLAN	FCC Part 15 Subpart C	GTSR16110086-WLAN
GSM	FCC Part 22/24	GTSR16110086-GSM
WCDMA	FCC Part 22/24	GTSR16110086-WCDMA
SAR	ANSI C95.1-1999 47CFR §2.1093	GTSR16110086-SAR

### **3. TEST ENVIRONMENT**

#### **3.1. Address of the test laboratory**

**Shenzhen Global Test Service Co.,Ltd.**

1F, Building No. 13A, Zhonghaixin Science and Technology City, No.12,6 Road, Ganli Industrial Park, Buji Street, Longgang District, Shenzhen, Guangdong

**Shenzhen CTL Testing Technology Co.,Ltd.**

1/F.-A, Baisha Technology Park, No.3011, Shahexi Road, Nanshan District, Shenzhen, Guangdong, China

#### **3.2. Test Facility**

The test facility is recognized, certified, or accredited by the following organizations:

**FCC-Registration No.: 964637**

Shenzhen Global Test Service Co.,Ltd EMC Laboratory has been registered and fully described in a report filed with the (FCC) Federal Communications Commission. The acceptance letter from the FCC is maintained in our files. Registration 964637, Jul 24, 2015.

**CNAS-Lab Code: L8169**

Shenzhen Global Test Service Co.,Ltd. has been assessed and proved to be in compliance with CNAS-CL01 Accreditation Criteria for Testing and Calibration Laboratories (identical to ISO/IEC 17025: 2005 General Requirements) for the Competence of Testing and Calibration Laboratories. Date of Registration: Dec. 11, 2015. Valid time is until Dec. 10, 2018.

**FCC-Registration No.: 970318**

Shenzhen CTL Testing Technology Co., Ltd. EMC Laboratory has been registered and fully described in a report filed with the (FCC) Federal Communications Commission. The acceptance letter from the FCC is maintained in our files. Registration 970318, December 19, 2013.

#### **3.3. Environmental conditions**

During the measurement the environmental conditions were within the listed ranges:

Temperature:	15-35 ° C
Humidity:	30-60 %
Atmospheric pressure:	950-1050mbar

### 3.4. Test Description

Test Specification clause	Test case	Test Mode	Test Channel	Recorded In Report		Pass	Fail	NA	NP	Remark
§15.247(b)(4)	Antenna gain	802.11b	<input checked="" type="checkbox"/> Lowest <input checked="" type="checkbox"/> Middle <input checked="" type="checkbox"/> Highest	802.11b	<input checked="" type="checkbox"/> Lowest <input checked="" type="checkbox"/> Middle <input checked="" type="checkbox"/> Highest	<input checked="" type="checkbox"/>	<input type="checkbox"/>	<input type="checkbox"/>	<input type="checkbox"/>	complies
§15.247(e)	Power spectral density	802.11b 802.11g 802.11n HT20	<input checked="" type="checkbox"/> Lowest <input checked="" type="checkbox"/> Middle <input checked="" type="checkbox"/> Highest	802.11b 802.11g 802.11n HT20	<input checked="" type="checkbox"/> Lowest <input checked="" type="checkbox"/> Middle <input checked="" type="checkbox"/> Highest	<input checked="" type="checkbox"/>	<input type="checkbox"/>	<input type="checkbox"/>	<input type="checkbox"/>	complies
§15.247(a)(2)	Spectrum bandwidth – 6 dB bandwidth	802.11b 802.11g 802.11n HT20	<input checked="" type="checkbox"/> Lowest <input checked="" type="checkbox"/> Middle <input checked="" type="checkbox"/> Highest	802.11b 802.11g 802.11n HT20	<input checked="" type="checkbox"/> Lowest <input checked="" type="checkbox"/> Middle <input checked="" type="checkbox"/> Highest	<input checked="" type="checkbox"/> <input checked="" type="checkbox"/>	<input type="checkbox"/>	<input type="checkbox"/>	<input type="checkbox"/>	complies
§15.247(b)(1)	Maximum output power	802.11b 802.11g 802.11n HT20	<input checked="" type="checkbox"/> Lowest <input checked="" type="checkbox"/> Middle <input checked="" type="checkbox"/> Highest	802.11b 802.11g 802.11n HT20	<input checked="" type="checkbox"/> Lowest <input checked="" type="checkbox"/> Middle <input checked="" type="checkbox"/> Highest	<input checked="" type="checkbox"/> <input checked="" type="checkbox"/> <input checked="" type="checkbox"/>	<input type="checkbox"/>	<input type="checkbox"/>	<input type="checkbox"/>	complies
§15.247(d)	Band edge compliance conducted	802.11b 802.11g 802.11n HT20	<input checked="" type="checkbox"/> Lowest <input checked="" type="checkbox"/> Highest	802.11b 802.11g 802.11n HT20	<input checked="" type="checkbox"/> Lowest <input checked="" type="checkbox"/> Highest	<input checked="" type="checkbox"/> <input checked="" type="checkbox"/>	<input type="checkbox"/>	<input type="checkbox"/>	<input type="checkbox"/>	complies
§15.205	Band edge compliance radiated	802.11b 802.11g 802.11n HT20	<input checked="" type="checkbox"/> Lowest <input checked="" type="checkbox"/> Highest	802.11b 802.11g 802.11n HT20	<input checked="" type="checkbox"/> Lowest <input checked="" type="checkbox"/> Highest	<input checked="" type="checkbox"/>	<input type="checkbox"/>	<input type="checkbox"/>	<input type="checkbox"/>	complies
§15.247(d)	TX spurious emissions conducted	802.11b 802.11g 802.11n HT20	<input checked="" type="checkbox"/> Lowest <input checked="" type="checkbox"/> Middle <input checked="" type="checkbox"/> Highest	802.11b 802.11g 802.11n HT20	<input checked="" type="checkbox"/> Lowest <input checked="" type="checkbox"/> Middle <input checked="" type="checkbox"/> Highest	<input checked="" type="checkbox"/> <input checked="" type="checkbox"/>	<input type="checkbox"/>	<input type="checkbox"/>	<input type="checkbox"/>	complies
§15.247(d)	TX spurious emissions radiated	802.11b 802.11g 802.11n HT20	<input checked="" type="checkbox"/> Lowest <input checked="" type="checkbox"/> Middle <input checked="" type="checkbox"/> Highest	802.11b 802.11g 802.11n HT20	<input checked="" type="checkbox"/> Lowest <input checked="" type="checkbox"/> Middle <input checked="" type="checkbox"/> Highest	<input checked="" type="checkbox"/>	<input type="checkbox"/>	<input type="checkbox"/>	<input type="checkbox"/>	complies
§15.109	RX spurious emissions radiated	-/-	-/-	-/-	-/-	<input type="checkbox"/>	<input type="checkbox"/>	<input checked="" type="checkbox"/>	<input type="checkbox"/>	complies
§15.209(a)	TX spurious Emissions radiated < 30 MHz	802.11b	-/-	802.11b	-/-	<input checked="" type="checkbox"/>	<input type="checkbox"/>	<input type="checkbox"/>	<input type="checkbox"/>	complies
§15.107(a) §15.207	Conducted Emissions < 30 MHz	802.11b	-/-	802.11b	-/-	<input checked="" type="checkbox"/>	<input type="checkbox"/>	<input type="checkbox"/>	<input type="checkbox"/>	complies

**Remark:**

- The measurement uncertainty is not included in the test result.
- NA = Not Applicable; NP = Not Performed

Preliminary tests were performed in different data rate to find the worst radiated emission. The data rate shown in the table below is the worst-case rate with respect to the specific test item. Investigation has been done on all the possible configurations for searching the worst cases. The following table is a list of the test modes shown in this test report.

Test Items	Mode	Data Rate	Channel
Maximum Peak Conducted Output Power Power Spectral Density 6dB Bandwidth Spurious RF conducted emission Radiated Emission 9kHz~1GHz& Radiated Emission 1GHz~10 <sup>th</sup> Harmonic	11b/DSSS	1 Mbps	1/6/11
	11g/OFDM	6 Mbps	1/6/11
	11n(20MHz)/OFDM	6.5Mbps	1/6/11
Band Edge	11b/DSSS	1 Mbps	1/11
	11g/OFDM	6 Mbps	1/11
	11n(20MHz)/OFDM	6.5Mbps	1/11



### 3.5. Statement of the measurement uncertainty

The data and results referenced in this document are true and accurate. The reader is cautioned that there may be errors within the calibration limits of the equipment and facilities. The measurement uncertainty was calculated for all measurements listed in this test report acc. to CISPR 16 - 4 „Specification for radio disturbance and immunity measuring apparatus and methods – Part 4: Uncertainty in EMC Measurements“ and is documented in the Shenzhen Global Test Service Co.,Ltd quality system acc. to DIN EN ISO/IEC 17025. Furthermore, component and process variability of devices similar to that tested may result in additional deviation. The manufacturer has the sole responsibility of continued compliance of the device.

Hereafter the best measurement capability for Shenzhen GTS laboratory is reported:

Test	Range	Measurement Uncertainty	Notes
Radiated Emission	30~1000MHz	4.10 dB	(1)
Radiated Emission	1~18GHz	4.32 dB	(1)
Radiated Emission	18-40GHz	5.54 dB	(1)
Conducted Disturbance	0.15~30MHz	3.12 dB	(1)

(1) This uncertainty represents an expanded uncertainty expressed at approximately the 95% confidence level using a coverage factor of k=2.

### 3.6. Equipments Used during the Test

Test Equipment	Manufacturer	Model No.	Serial No.	Calibration Date	Calibration Due Date
LISN	R&S	ENV216	3560.6550.08	2016/05/28	2017/05/27
LISN	R&S	ESH2-Z5	893606/008	2016/05/27	2017/05/26
Bilog Antenna	Sunol Sciences Corp.	JB1	A061713	2016/06/02	2017/06/01
EMI Test Receiver	R&S	ESCI	101102	2016/06/26	2017/06/25
Spectrum Analyzer	Agilent	N9020A	MY48010425	2016/06/17	2017/06/16
Controller	EM Electronics	Controller EM 1000	N/A	2016/05/21	2017/05/20
Horn Antenna	Sunol Sciences Corp.	DRH-118	A062013	2016/05/19	2017/05/18
Active Loop Antenna	SCHWARZBEC K	FMZB1519	1519-037	2016/05/19	2017/05/18
Amplifier	Agilent	8349B	3008A02306	2016/05/19	2017/05/18
Amplifier	Agilent	8447D	2944A10176	2016/05/19	2017/05/18
Temperature/Humidity Meter	Gangxing	CTH-608	02	2016/05/20	2017/05/19
High-Pass Filter	K&L	9SH10-2700/X12750-O/O	N/A	2016/05/20	2017/05/19
High-Pass Filter	K&L	41H10-1375/U12750-O/O	N/A	2016/05/20	2017/05/19
Data acquisition card	Agilent	U2531A	TW53323507	2016/05/20	2017/05/19
Power Sensor	Agilent	U2021XA	MY5365004	2016/05/20	2017/05/19
RF Cable	HUBER+SUHNER	RG214	N/A	2016/05/20	2017/05/19

Note: The Cal.Interval was one year.

## 4. TEST CONDITIONS AND RESULTS

### 4.1. AC Power Conducted Emission

#### TEST CONFIGURATION

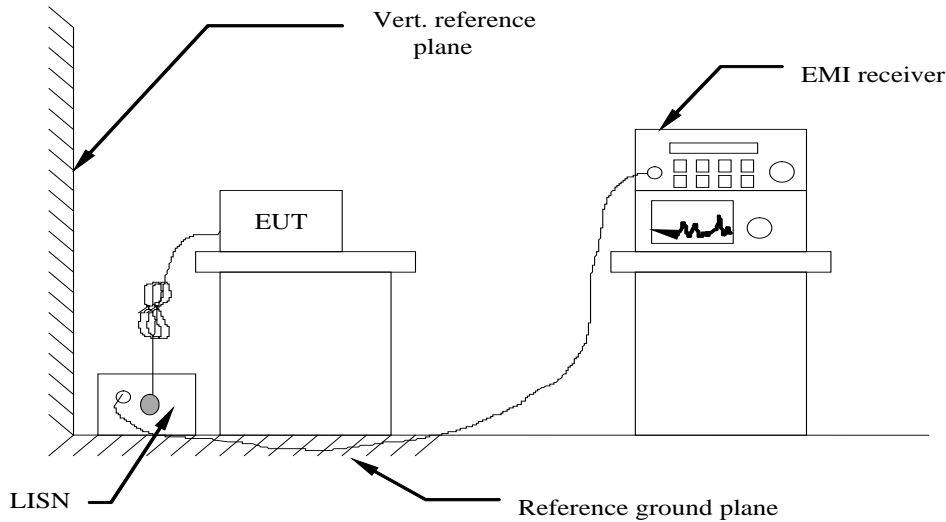

#### TEST PROCEDURE

- 1 The equipment was set up as per the test configuration to simulate typical actual usage per the user's manual. The EUT is a tabletop system, a wooden table with a height of 0.8 meters is used and is placed on the ground plane as per ANSI C63.10-2013.
- 2 Support equipment, if needed, was placed as per ANSI C63.10-2013
- 3 All I/O cables were positioned to simulate typical actual usage as per ANSI C63.10-2013
- 4 The EUT received DC5V power, the adapter received AC120V/60Hz power through a Line Impedance Stabilization Network (LISN) which supplied power source and was grounded to the ground plane.
- 5 All support equipments received AC power from a second LISN, if any.
- 6 The EUT test program was started. Emissions were measured on each current carrying line of the EUT using a spectrum Analyzer / Receiver connected to the LISN powering the EUT. The LISN has two monitoring points: Line 1 (Hot Side) and Line 2 (Neutral Side). Two scans were taken: one with Line 1 connected to Analyzer / Receiver and Line 2 connected to a 50 ohm load; the second scan had Line 1 connected to a 50 ohm load and Line 2 connected to the Analyzer / Receiver.
- 7 Analyzer / Receiver scanned from 150 KHz to 30MHz for emissions in each of the test modes.
- 8 During the above scans, the emissions were maximized by cable manipulation.

#### AC Power Conducted Emission Limit

For intentional device, according to § 15.207(a) AC Power Conducted Emission Limits is as following :

Frequency range (MHz)	Limit (dBuV)	
	Quasi-peak	Average
0.15-0.5	66 to 56*	56 to 46*
0.5-5	56	46
5-30	60	50

\* Decreases with the logarithm of the frequency.

#### TEST RESULTS

Remark: We measured Conducted Emission at 802.11b/802.11g/802.11n HT20 mode in AC 120V/60Hz and 240V/60Hz, the worst case was recorded .

Power supply:	DC 5V from Adapter AC 120V/60Hz	Polarization	L
---------------	------------------------------------	--------------	---

**SCAN TABLE: "Voltage (9K-30M) FIN"**  
 Short Description: 150K-30M Voltage

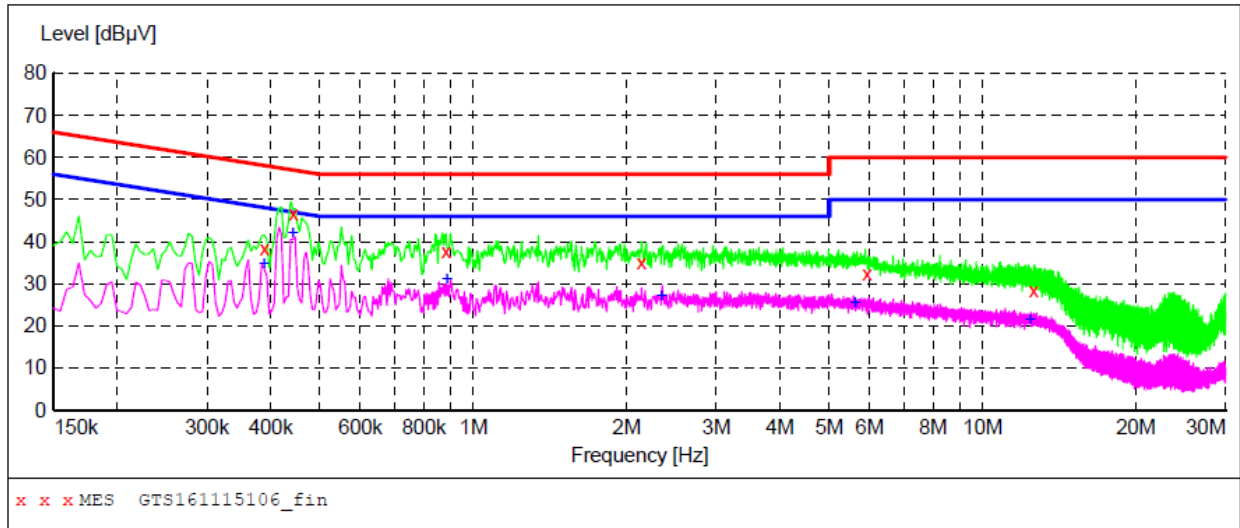

**MEASUREMENT RESULT: "GTS161115106\_fin"**

11/15/2016 12:06PM

Frequency MHz	Level dBuV	Transd dB	Limit dBuV	Margin dB	Detector	Line	PE
0.388500	38.50	9.8	58	19.6	QP	L1	GND
0.442500	46.70	9.8	57	10.3	QP	L1	GND
0.883500	37.80	9.6	56	18.2	QP	L1	GND
2.134500	35.10	9.5	56	20.9	QP	L1	GND
5.932500	32.40	9.2	60	27.6	QP	L1	GND
12.601500	28.30	8.5	60	31.7	QP	L1	GND

**MEASUREMENT RESULT: "GTS161115106\_fin2"**

11/15/2016 12:06PM

Frequency MHz	Level dBuV	Transd dB	Limit dBuV	Margin dB	Detector	Line	PE
0.388500	34.60	9.8	48	13.5	AV	L1	GND
0.442500	41.90	9.8	47	5.1	AV	L1	GND
0.888000	31.00	9.6	46	15.0	AV	L1	GND
2.341500	27.00	9.5	46	19.0	AV	L1	GND
5.613000	25.50	9.2	50	24.5	AV	L1	GND
12.399000	21.30	8.5	50	28.7	AV	L1	GND

Power supply:	DC 5V from Adapter AC 120V/60Hz	Polarization	N
---------------	------------------------------------	--------------	---

**SCAN TABLE: "Voltage (9K-30M)FIN"**

Short Description: 150K-30M Voltage

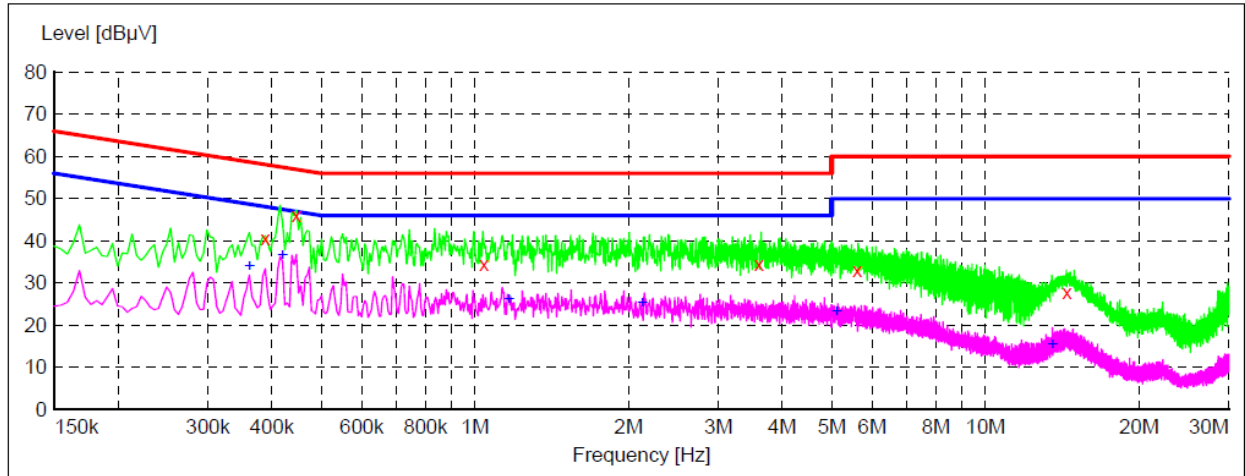

x x x MES GTS161115107\_fin

**MEASUREMENT RESULT: "GTS161115107\_fin"**

11/15/2016 12:09PM

Frequency MHz	Level dBµV	Transd dB	Limit dBµV	Margin dB	Detector	Line	PE
0.388500	40.60	9.8	58	17.5	QP	N	GND
0.447000	46.00	9.8	57	10.9	QP	N	GND
1.041000	34.60	9.6	56	21.4	QP	N	GND
3.601500	34.40	9.4	56	21.6	QP	N	GND
5.608500	33.00	9.2	60	27.0	QP	N	GND
14.433000	27.70	8.3	60	32.3	QP	N	GND

**MEASUREMENT RESULT: "GTS161115107\_fin2"**

11/15/2016 12:09PM

Frequency MHz	Level dBµV	Transd dB	Limit dBµV	Margin dB	Detector	Line	PE
0.361500	33.90	9.9	49	14.8	AV	N	GND
0.420000	36.60	9.8	47	10.8	AV	N	GND
1.167000	26.00	9.6	46	20.0	AV	N	GND
2.130000	25.20	9.5	46	20.8	AV	N	GND
5.109000	23.00	9.3	50	27.0	AV	N	GND
13.533000	15.30	8.4	50	34.7	AV	N	GND

## 4.2. Radiated Emission

### TEST CONFIGURATION

Frequency range 9 KHz – 30MHz

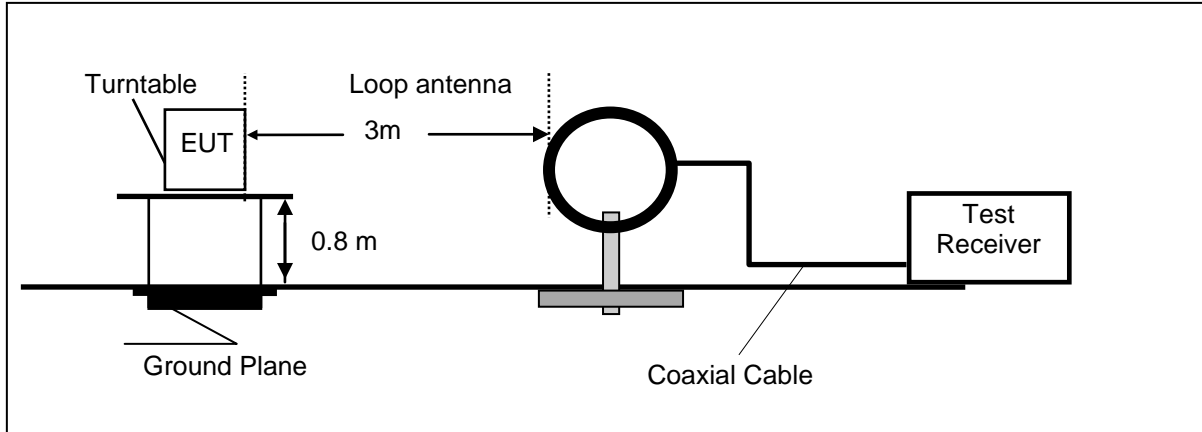

Frequency range 30MHz – 1000MHz

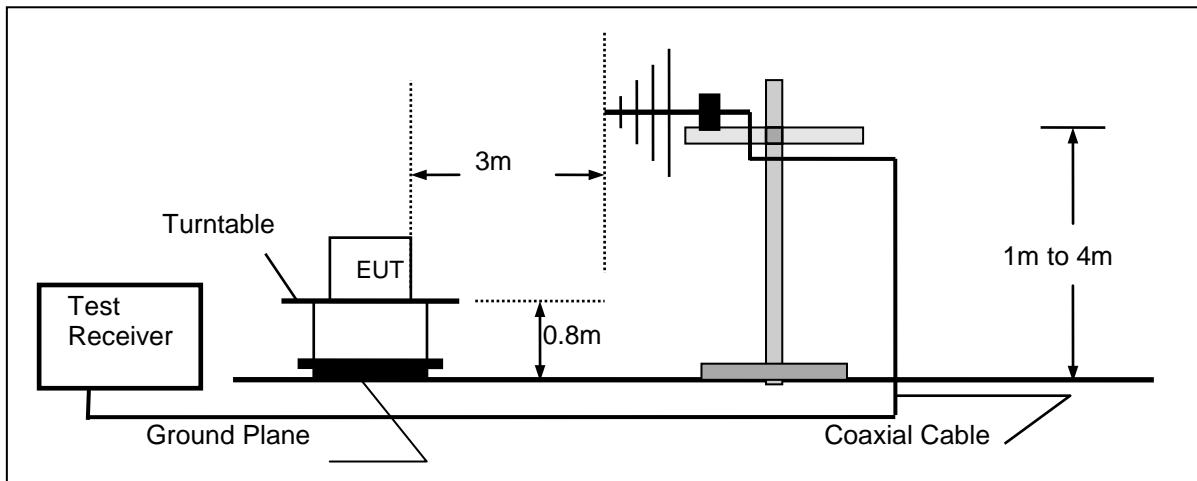

Frequency range above 1GHz-25GHz

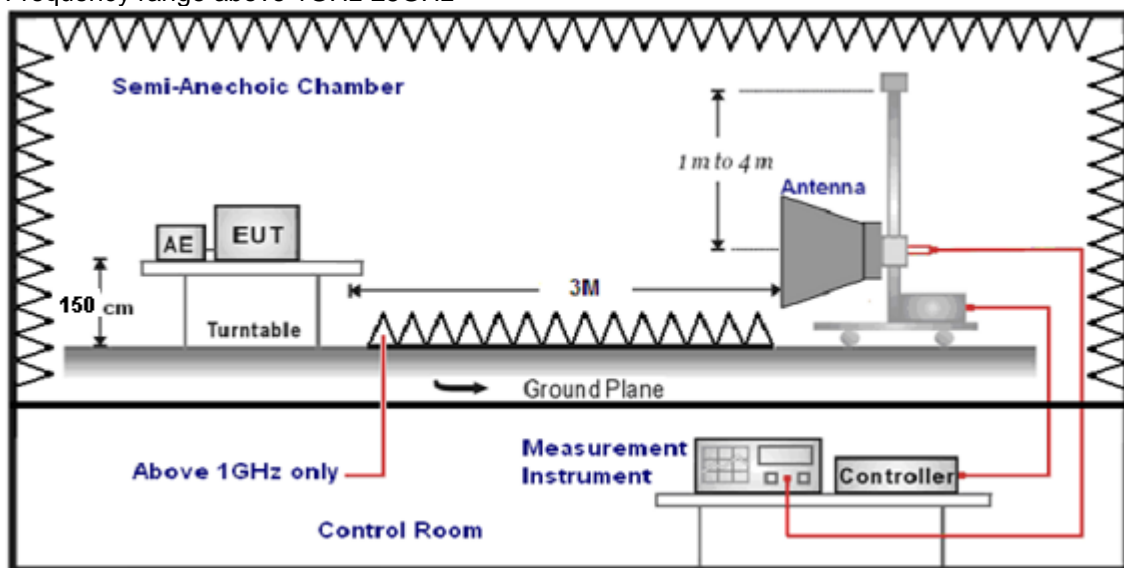

**TEST PROCEDURE**

1. The EUT was placed on a turn table which is 0.8m above ground plane when testing frequency range 9 KHz –1GHz;the EUT was placed on a turn table which is 1.5m above ground plane when testing frequency range 1GHz – 25GHz.
2. Maximum procedure was performed by raising the receiving antenna from 1m to 4m and rotating the turn table from 0° to 360° to acquire the highest emissions from EUT.
3. And also, each emission was to be maximized by changing the polarization of receiving antenna both horizontal and vertical.
4. Repeat above procedures until all frequency measurements have been completed.
5. The EUT minimum operation frequency was 32.768KHz and maximum operation frequency was 2480MHz.so radiated emission test frequency band from 9KHz to 25GHz.
6. The distance between test antenna and EUT as following table states:

Test Frequency range	Test Antenna Type	Test Distance
9KHz-30MHz	Active Loop Antenna	3
30MHz-1GHz	Ultra-Broadband Antenna	3
1GHz-18GHz	Double Ridged Horn Antenna	3
18GHz-25GHz	Horn Antenna	1

7. Setting test receiver/spectrum as following table states:

Test Frequency range	Test Receiver/Spectrum Setting	Detector
9KHz-150KHz	RBW=200Hz/VBW=3KHz,Sweep time=Auto	QP
150KHz-30MHz	RBW=9KHz/VBW=100KHz,Sweep time=Auto	QP
30MHz-1GHz	RBW=120KHz/VBW=1000KHz,Sweep time=Auto	QP
1GHz-40GHz	Peak Value: RBW=1MHz/VBW=3MHz, Sweep time=Auto Average Value: RBW=1MHz/VBW=10Hz, Sweep time=Auto	Peak

**Field Strength Calculation**

The field strength is calculated by adding the Antenna Factor and Cable Factor and subtracting the Amplifier Gain and Duty Cycle Correction Factor(if any) from the measured reading. The basic equation with a sample calculation is as follows:

$$FS = RA + AF + CL - AG$$

Where FS = Field Strength	CL = Cable Attenuation Factor (Cable Loss)
RA = Reading Amplitude	AG = Amplifier Gain
AF = Antenna Factor	

$$\text{Transd}=AF +CL-AG$$

**RADIATION LIMIT**

For intentional device, according to § 15.209(a), the general requirement of field strength of radiated emission from intentional radiators at a distance of 3 meters shall not exceed the following table. According to § 15.247(d), in any 100kHz bandwidth outside the frequency band in which the EUT is operating, the radio frequency power that is produced by the intentional radiator shall be at least 20dB below that in the100kHz bandwidth within the band that contains the highest level of desired power.

The pre-test have done for the EUT in three axes and found the worst emission at position shown in test setup photos.

Frequency (MHz)	Distance (Meters)	Radiated (dBµV/m)	Radiated (µV/m)
0.009-0.49	3	$20\log(2400/F(\text{KHz}))+40\log(300/3)$	$2400/F(\text{KHz})$
0.49-1.705	3	$20\log(24000/F(\text{KHz}))+40\log(30/3)$	$24000/F(\text{KHz})$
1.705-30	3	$20\log(30)+40\log(30/3)$	30
30-88	3	40.0	100
88-216	3	43.5	150
216-960	3	46.0	200
Above 960	3	54.0	500

**TEST RESULTS**

Remark: We measured Radiated Emission at 802.11b/802.11g/802.11n HT20 mode from 9 KHz to 25GHz in AC 120V/60Hz and AC 240V/60Hz and recorded worst case at GFSK mode.  
 Test site: Shenzhen CTL Testing Technology Co., Ltd

**For 9 KHz-30MHz**

Frequency (MHz)	Corrected Reading (dBuV/m)@3m	FCC Limit (dBuV/m) @3m	Margin (dB)	Detector	Result
0.36	50.48	96.48	46.00	QP	PASS
1.65	43.94	63.25	19.31	QP	PASS
20.51	45.00	69.54	24.54	QP	PASS
25.77	44.37	69.54	25.17	QP	PASS

**For 30MHz-1GHz**

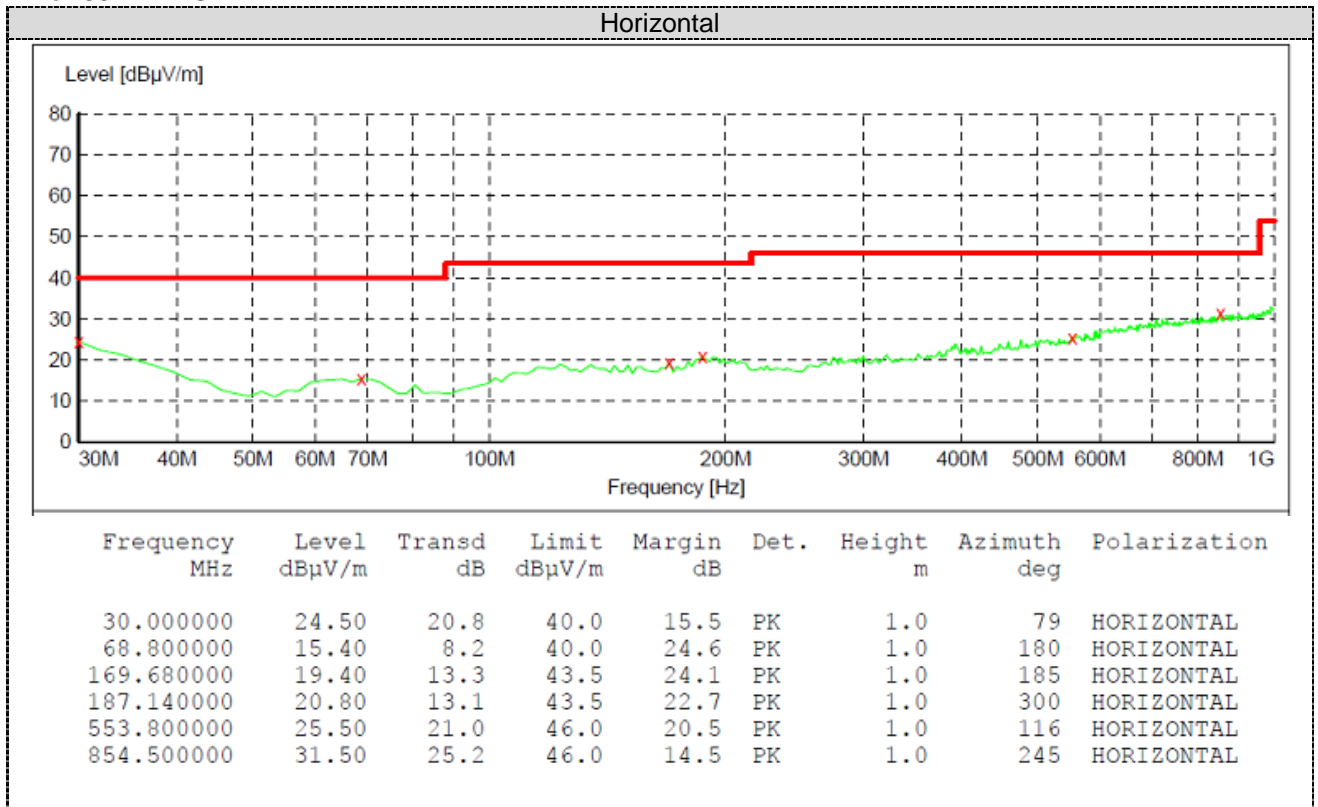

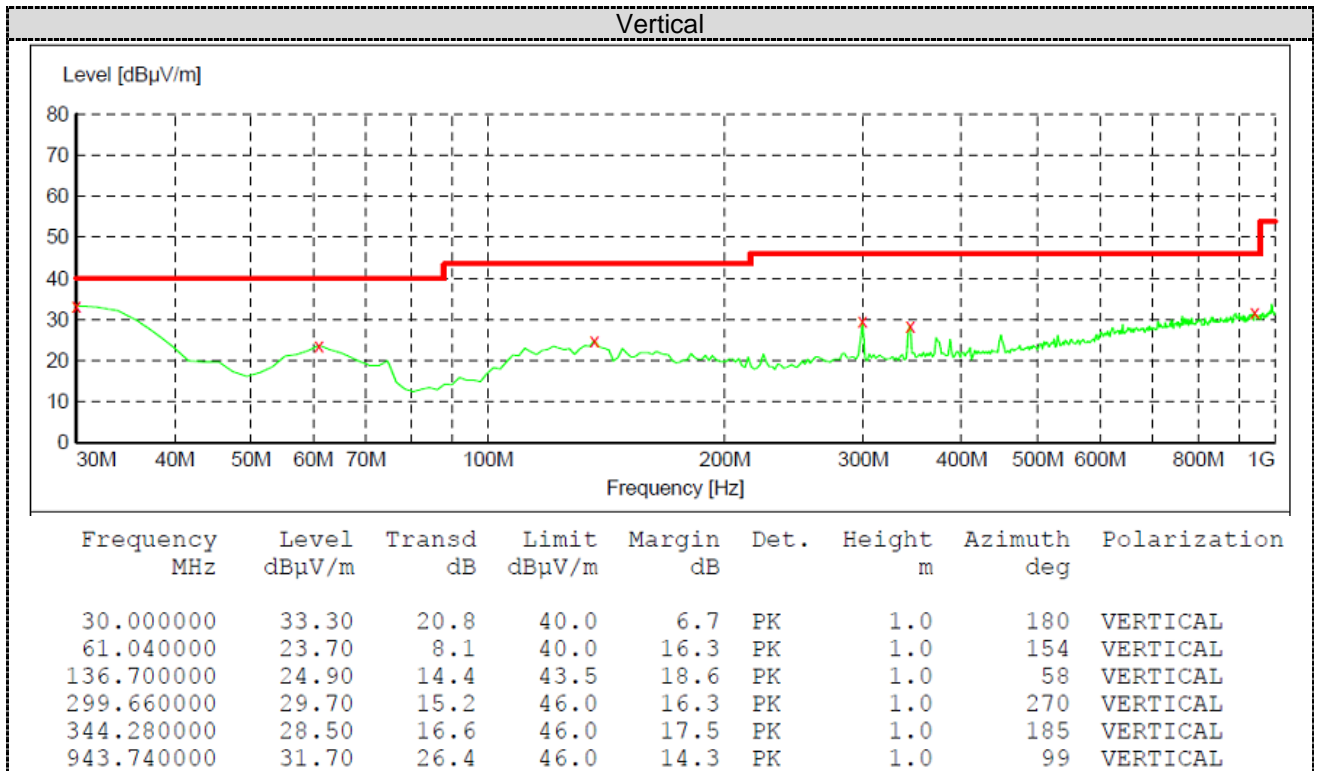

For 1GHz to 25GHz

**802.11b Mode (above 1GHz)**

Frequency(MHz):			2412			Polarity:			HORIZONTAL		
No.	Frequency (MHz)	Emission Level (dBuV/m)	Limit (dBuV/m)	Margin (dB)	Antenna Height (m)	Table Angle (Degree)	Raw Value (dBuV)	Antenna Factor (dB/m)	Cable Factor (dB)	Pre-amplifier	Correction Factor (dB/m)
1	4824	55.53 PK	74	18.47	1.00	144	53.43	31.6	7.00	36.5	2.10
1	4824	41.45 AV	54	12.55	1.00	144	39.35	31.6	7.00	36.5	2.10
2	7236	53.78 PK	74	20.22	1.00	205	42.85	37.33	8.90	35.3	10.93
2	7236	41.40 AV	54	12.60	1.00	205	30.47	37.33	8.90	35.3	10.93

Frequency(MHz):			2412			Polarity:			VERTICAL		
No.	Frequency (MHz)	Emission Level (dBuV/m)	Limit (dBuV/m)	Margin (dB)	Antenna Height (m)	Table Angle (Degree)	Raw Value (dBuV)	Antenna Factor (dB/m)	Cable Factor (dB)	Pre-amplifier	Correction Factor (dB/m)
1	4824	57.55 PK	74	16.45	1.00	132	55.45	31.60	7.00	36.50	2.10
1	4824	43.53 AV	54	10.47	1.00	132	41.43	31.60	7.00	36.50	2.10
2	7236	53.37 PK	74	20.63	1.00	226	42.44	37.33	8.90	35.30	10.93
2	7236	43.82 AV	54	10.18	1.00	226	32.89	37.33	8.90	35.30	10.93



Frequency(MHz):				2437			Polarity:			HORIZONTAL		
No.	Frequency (MHz)	Emission Level (dBuV/m)		Limit (dBuV/m)	Margin (dB)	Antenna Height (m)	Table Angle (Degree)	Raw Value (dBuV)	Antenna Factor (dB/m)	Cable Factor (dB)	Pre-amplifier	Correction Factor (dB/m)
1	4874.00	60.10	PK	74.00	13.90	1.00	89	57.98	31.02	7.60	36.5	2.12
1	4874.00	41.81	AV	54.00	12.19	1.00	89	39.69	31.02	7.60	36.5	2.12
2	7311.00	57.52	PK	74.00	16.48	1.00	156	46.44	37.28	8.60	34.8	11.08
2	7311.00	42.42	AV	54.00	11.58	1.00	156	31.34	37.28	8.60	34.8	11.08

Frequency(MHz):				2437			Polarity:			VERTICAL		
No.	Frequency (MHz)	Emission Level (dBuV/m)		Limit (dBuV/m)	Margin (dB)	Antenna Height (m)	Table Angle (Degree)	Raw Value (dBuV)	Antenna Factor (dB/m)	Cable Factor (dB)	Pre-amplifier	Correction Factor (dB/m)
1	4874.00	60.51	PK	74.00	13.49	1.00	169	58.39	31.02	7.60	36.5	2.12
1	4874.00	43.52	AV	54.00	10.48	1.00	169	41.40	31.02	7.60	36.5	2.12
2	7311.00	55.84	PK	74.00	18.16	1.00	265	44.76	37.28	8.60	34.8	11.08
2	7311.00	43.45	AV	54.00	10.55	1.00	265	32.37	37.28	8.60	34.8	11.08

Frequency(MHz):				2462			Polarity:			HORIZONTAL		
No.	Frequency (MHz)	Emission Level (dBuV/m)		Limit (dBuV/m)	Margin (dB)	Antenna Height (m)	Table Angle (Degree)	Raw Value (dBuV)	Antenna Factor (dB/m)	Cable Factor (dB)	Pre-amplifier	Correction Factor (dB/m)
1	4924.00	61.57	PK	74.00	12.43	1.00	174	58.37	31.58	7.82	36.2	3.20
1	4924.00	42.55	AV	54.00	11.45	1.00	174	39.35	31.58	7.82	36.2	3.20
2	7386.00	57.47	PK	74.00	16.53	1.00	229	45.53	38.51	8.73	35.3	11.94
2	7386.00	41.54	AV	54.00	12.46	1.00	229	29.60	38.51	8.73	35.3	11.94

Frequency(MHz):				2462			Polarity:			VERTICAL		
No.	Frequency (MHz)	Emission Level (dBuV/m)		Limit (dBuV/m)	Margin (dB)	Antenna Height (m)	Table Angle (Degree)	Raw Value (dBuV)	Antenna Factor (dB/m)	Cable Factor (dB)	Pre-amplifier (dB)	Correction Factor (dB/m)
1	4924.00	59.61	PK	74.00	14.39	1.00	144	56.41	31.58	7.82	36.2	3.20
1	4924.00	42.36	AV	54.00	11.64	1.00	144	39.16	31.58	7.82	36.2	3.20
2	7386.00	55.45	PK	74.00	18.55	1.00	235	43.51	38.51	8.73	35.3	11.94
2	7386.00	43.47	AV	54.00	10.53	1.00	235	31.53	38.51	8.73	35.3	11.94

## 802.11g Mode (above 1GHz)

Frequency(MHz):				2412			Polarity:			HORIZONTAL		
No.	Frequency (MHz)	Emission Level (dBuV/m)		Limit (dBuV/m)	Margin (dB)	Antenna Height (m)	Table Angle (Degree)	Raw Value (dBuV)	Antenna Factor (dB/m)	Cable Factor (dB)	Pre-amplifier	Correction Factor (dB/m)
1	4824	61.84	PK	74	12.16	1.00	59	59.74	31.6	7.00	36.5	2.10
1	4824	44.65	AV	54	9.35	1.00	59	42.55	31.6	7.00	36.5	2.10
2	7236	54.63	PK	74	19.37	1.00	169	43.70	37.33	8.90	35.3	10.93
2	7236	41.20	AV	54	12.80	1.00	169	30.27	37.33	8.90	35.3	10.93

Frequency(MHz):				2412			Polarity:			VERTICAL		
No.	Frequency (MHz)	Emission Level (dBuV/m)		Limit (dBuV/m)	Margin (dB)	Antenna Height (m)	Table Angle (Degree)	Raw Value (dBuV)	Antenna Factor (dB/m)	Cable Factor (dB)	Pre-amplifier	Correction Factor (dB/m)
1	4824	61.94	PK	74	12.06	1.00	118	59.84	31.60	7.00	36.50	2.10
1	4824	42.57	AV	54	11.43	1.00	118	40.47	31.60	7.00	36.50	2.10
2	7236	55.85	PK	74	18.15	1.00	186	44.92	37.33	8.90	35.30	10.93
2	7236	42.48	AV	54	11.52	1.00	186	31.55	37.33	8.90	35.30	10.93

Frequency(MHz):				2437			Polarity:			HORIZONTAL		
No.	Frequency (MHz)	Emission Level (dBuV/m)		Limit (dBuV/m)	Margin (dB)	Antenna Height (m)	Table Angle (Degree)	Raw Value (dBuV)	Antenna Factor (dB/m)	Cable Factor (dB)	Pre-amplifier	Correction Factor (dB/m)
1	4874.00	60.67	PK	74.00	13.33	1.00	144	58.57	31.02	7.60	36.5	2.12
1	4874.00	43.04	AV	54.00	10.96	1.00	144	40.92	31.02	7.60	36.5	2.12
2	7311.00	55.66	PK	74.00	18.34	1.00	231	44.58	37.28	8.60	34.8	11.08
2	7311.00	43.40	AV	54.00	10.60	1.00	231	32.32	37.28	8.60	34.8	11.08

Frequency(MHz):				2437			Polarity:			VERTICAL		
No.	Frequency (MHz)	Emission Level (dBuV/m)		Limit (dBuV/m)	Margin (dB)	Antenna Height (m)	Table Angle (Degree)	Raw Value (dBuV)	Antenna Factor (dB/m)	Cable Factor (dB)	Pre-amplifier	Correction Factor (dB/m)
1	4874.00	60.89	PK	74.00	13.11	1.00	138	58.77	31.02	7.60	36.5	2.12
1	4874.00	43.51	AV	54.00	10.49	1.00	138	41.39	31.02	7.60	36.5	2.12
2	7311.00	58.01	PK	74.00	15.99	1.00	276	46.93	37.28	8.60	34.8	11.08
2	7311.00	41.99	AV	54.00	12.01	1.00	276	30.91	37.28	8.60	34.8	11.08

Frequency(MHz):				2462			Polarity:			HORIZONTAL		
No.	Frequency (MHz)	Emission Level (dBuV/m)		Limit (dBuV/m)	Margin (dB)	Antenna Height (m)	Table Angle (Degree)	Raw Value (dBuV)	Antenna Factor (dB/m)	Cable Factor (dB)	Pre-amplifier	Correction Factor (dB/m)
1	4924.00	61.54	PK	74.00	12.46	1.00	103	58.34	31.58	7.82	36.2	3.20
1	4924.00	43.42	AV	54.00	10.58	1.00	103	40.22	31.58	7.82	36.2	3.20
2	7386.00	55.86	PK	74.00	18.14	1.00	255	43.92	38.51	8.73	35.3	11.94
2	7386.00	41.79	AV	54.00	12.21	1.00	255	29.85	38.51	8.73	35.3	11.94

Frequency(MHz):				2462			Polarity:			VERTICAL		
No.	Frequency (MHz)	Emission Level (dBuV/m)		Limit (dBuV/m)	Margin (dB)	Antenna Height (m)	Table Angle (Degree)	Raw Value (dBuV)	Antenna Factor (dB/m)	Cable Factor (dB)	Pre-amplifier	Correction Factor (dB/m)
1	4924.00	62.08	PK	74.00	11.92	1.00	119	58.88	31.58	7.82	36.2	3.20
1	4924.00	43.18	AV	54.00	10.82	1.00	119	39.98	31.58	7.82	36.2	3.20
2	7386.00	57.08	PK	74.00	16.92	1.00	220	45.14	38.51	8.73	35.3	11.94
2	7386.00	42.94	AV	54.00	11.06	1.00	220	31.00	38.51	8.73	35.3	11.94

## 802.11n HT20 Mode (above 1GHz)

Frequency(MHz):				2412			Polarity:			HORIZONTAL		
No.	Frequency (MHz)	Emission Level (dBuV/m)		Limit (dBuV/m)	Margin (dB)	Antenna Height (m)	Table Angle (Degree)	Raw Value (dBuV)	Antenna Factor (dB/m)	Cable Factor (dB)	Pre-amplifier	Correction Factor (dB/m)
1	4824	59.94	PK	74	14.06	1.00	78	57.84	31.6	7.00	36.5	2.10
1	4824	42.56	AV	54	11.44	1.00	78	40.46	31.6	7.00	36.5	2.10
2	7236	57.64	PK	74	16.36	1.00	188	46.71	37.33	8.90	35.3	10.93
2	7236	42.90	AV	54	11.10	1.00	188	31.97	37.33	8.90	35.3	10.93

Frequency(MHz):				2412			Polarity:			VERTICAL		
No.	Frequency (MHz)	Emission Level (dBuV/m)		Limit (dBuV/m)	Margin (dB)	Antenna Height (m)	Table Angle (Degree)	Raw Value (dBuV)	Antenna Factor (dB/m)	Cable Factor (dB)	Pre-amplifier	Correction Factor (dB/m)
1	4824	61.30	PK	74	12.70	1.00	136	59.20	31.60	7.00	36.50	2.10
1	4824	43.46	AV	54	10.54	1.00	136	41.36	31.60	7.00	36.50	2.10
2	7236	55.86	PK	74	18.14	1.00	291	44.93	37.33	8.90	35.30	10.93
2	7236	42.60	AV	54	11.40	1.00	291	31.67	37.33	8.90	35.30	10.93

Frequency(MHz):				2437			Polarity:			HORIZONTAL		
No.	Frequency (MHz)	Emission Level (dBuV/m)		Limit (dBuV/m)	Margin (dB)	Antenna Height (m)	Table Angle (Degree)	Raw Value (dBuV)	Antenna Factor (dB/m)	Cable Factor (dB)	Pre-amplifier	Correction Factor (dB/m)
1	4874.00	58.60	PK	74.00	15.40	1.00	131	56.48	31.02	7.60	36.5	2.12
1	4874.00	41.94	AV	54.00	12.06	1.00	131	39.82	31.02	7.60	36.5	2.12
2	7311.00	55.62	PK	74.00	18.38	1.00	199	44.54	37.28	8.60	34.8	11.08
2	7311.00	43.55	AV	54.00	10.45	1.00	199	32.47	37.28	8.60	34.8	11.08

Frequency(MHz):				2437			Polarity:			VERTICAL		
No.	Frequency (MHz)	Emission Level (dBuV/m)		Limit (dBuV/m)	Margin (dB)	Antenna Height (m)	Table Angle (Degree)	Raw Value (dBuV)	Antenna Factor (dB/m)	Cable Factor (dB)	Pre-amplifier	Correction Factor (dB/m)
1	4874.00	61.75	PK	74.00	12.25	1.00	122	59.63	31.02	7.60	36.5	2.12
1	4874.00	44.47	AV	54.00	9.53	1.00	122	42.35	31.02	7.60	36.5	2.12
2	7311.00	55.97	PK	74.00	18.03	1.00	202	44.89	37.28	8.60	34.8	11.08
2	7311.00	41.91	AV	54.00	12.09	1.00	202	30.83	37.28	8.60	34.8	11.08

Frequency(MHz):				2462			Polarity:			HORIZONTAL		
No.	Frequency (MHz)	Emission Level (dBuV/m)		Limit (dBuV/m)	Margin (dB)	Antenna Height (m)	Table Angle (Degree)	Raw Value (dBuV)	Antenna Factor (dB/m)	Cable Factor (dB)	Pre-amplifier	Correction Factor (dB/m)
1	4924.00	59.85	PK	74.00	14.15	1.00	154	56.65	31.58	7.82	36.2	3.20
1	4924.00	42.93	AV	54.00	11.07	1.00	154	39.73	31.58	7.82	36.2	3.20
2	7386.00	56.90	PK	74.00	17.10	1.00	237	44.96	38.51	8.73	35.3	11.94
2	7386.00	43.46	AV	54.00	10.54	1.00	237	31.52	38.51	8.73	35.3	11.94

Frequency(MHz):				2462			Polarity:			VERTICAL		
No.	Frequency (MHz)	Emission Level (dBuV/m)		Limit (dBuV/m)	Margin (dB)	Antenna Height (m)	Table Angle (Degree)	Raw Value (dBuV)	Antenna Factor (dB/m)	Cable Factor (dB)	Pre-amplifier	Correction Factor (dB/m)
1	4924.00	60.29	PK	74.00	13.71	1.00	101	57.09	31.58	7.82	36.2	3.20
1	4924.00	42.73	AV	54.00	11.27	1.00	101	39.53	31.58	7.82	36.2	3.20
2	7386.00	56.91	PK	74.00	17.09	1.00	262	44.97	38.51	8.73	35.3	11.94
2	7386.00	43.86	AV	54.00	10.14	1.00	262	31.92	38.51	8.73	35.3	11.94

REMARKS:

1. Emission level (dBuV/m) = Raw Value (dBuV) + Correction Factor (dB/m)
2. Correction Factor (dB/m) = Antenna Factor (dB/m) + Cable Factor (dB) - Pre-amplifier Factor
3. Margin value = Limit value - Emission level.
4. -- Mean the PK detector measured value is below average limit.
5. The other emission levels were very low against the limit.

### 4.3. Maximum Peak Output Power

#### TEST CONFIGURATION

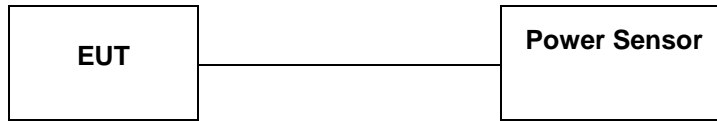

#### TEST PROCEDURE

According to KDB558074 D01 DTS Measurement Guidance Section 9.1 Maximum peak conducted output power,9.1.1. The maximum peak conducted output power may be measured using a broadband peak RF power meter. The power meter shall have a video bandwidth that is greater than or equal to the DTS bandwidth and shall utilize a fast-responding diode detector.

#### LIMIT

The Maximum Peak Output Power Measurement is 30dBm.

#### TEST RESULTS

Type	Channel	Output power PK (dBm)	Output power AV (dBm)	Limit (dBm)	Result
802.11b	01	17.52	15.43	30.00	Pass
	06	17.68	15.69		
	11	17.87	15.38		
802.11g	01	19.24	15.08	30.00	Pass
	06	19.73	15.36		
	11	19.36	15.15		
802.11n(HT20)	01	18.77	14.86	30.00	Pass
	06	18.85	14.91		
	11	18.72	14.83		

Note: 1.The test results including the cable lose.

Duty cycle used in all test items: 100%

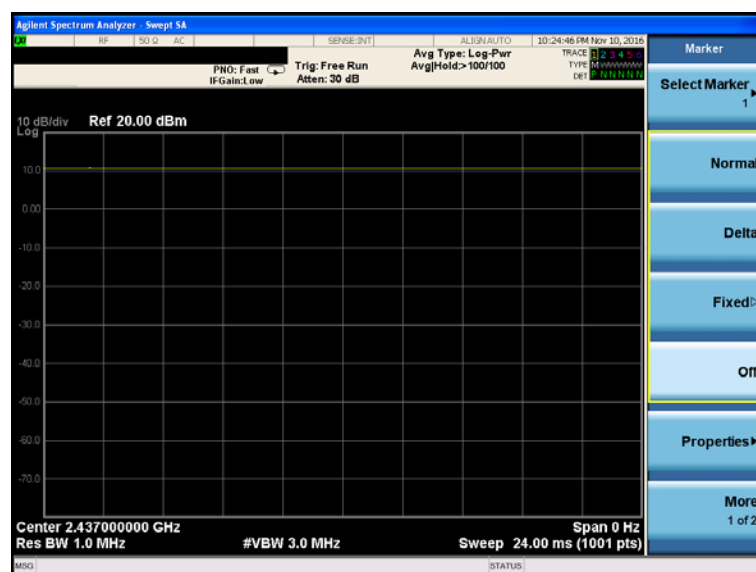

### 4.4. Power Spectral Density

#### TEST CONFIGURATION

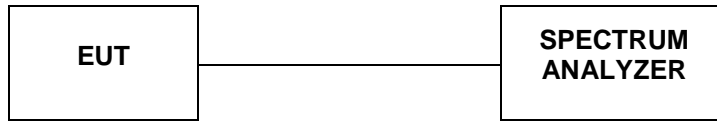

#### TEST PROCEDURE

According to KDB 558074 D01 Method PKPSD (peak PSD) This procedure shall be used if maximum peak conducted output power was used to demonstrate compliance, and is optional if the maximum conducted (average) output power was used to demonstrate compliance.

1. Set analyzer center frequency to DTS channel center frequency.
2. Set the span to 1.5 times the DTS bandwidth.
3. Set the RBW to:  $3 \text{ kHz} \leq \text{RBW} \leq 100 \text{ kHz}$ .
4. Set the VBW  $\geq 3 \text{ RBW}$ .
5. Detector = peak.
6. Sweep time = auto couple.
7. Trace mode = max hold.
8. Allow trace to fully stabilize.
9. Use the peak marker function to determine the maximum amplitude level within the RBW.
10. If measured value exceeds limit, reduce RBW (no less than 3 kHz) and repeat.

#### LIMIT

For digitally modulated systems, the power spectral density conducted from the intentional radiator to the antenna shall not be greater than 8 dBm in any 3 kHz band during any time interval of continuous transmission.

#### TEST RESULTS

Type	Channel	Power Spectral Density (dBm/3KHz)	Limit (dBm/3KHz)	Result
802.11b	01	-13.029	8.00	Pass
	06	-13.088		
	11	-13.434		
802.11g	01	-14.619	8.00	Pass
	06	-13.757		
	11	-14.159		
802.11n(HT20)	01	-14.109	8.00	Pass
	06	-14.490		
	11	-14.626		

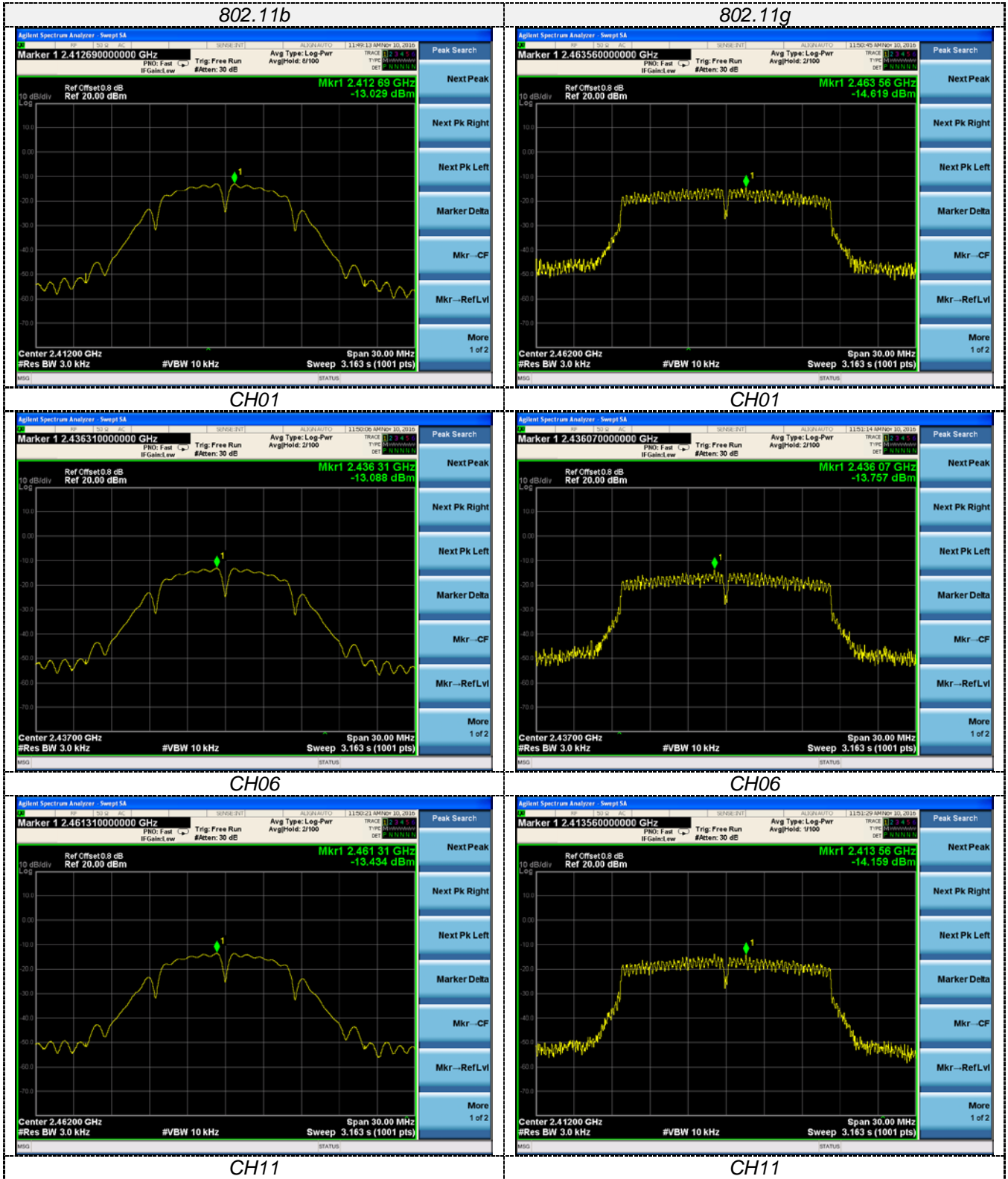

802.11nHT20

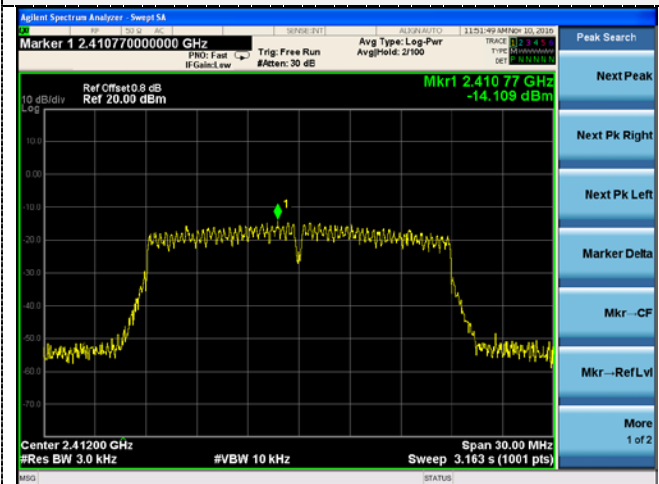

CH01

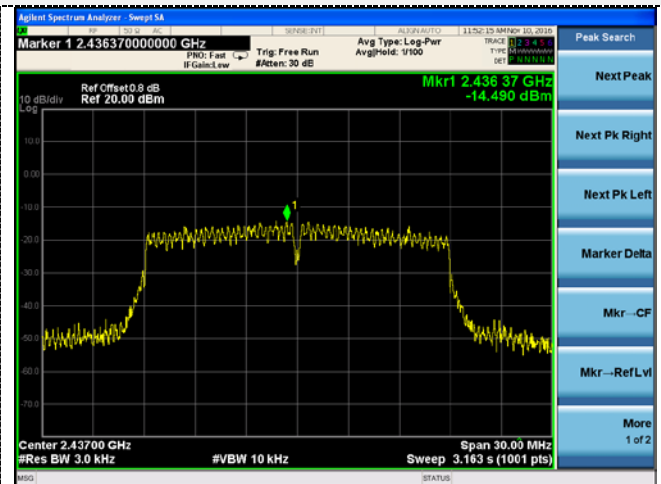

CH06

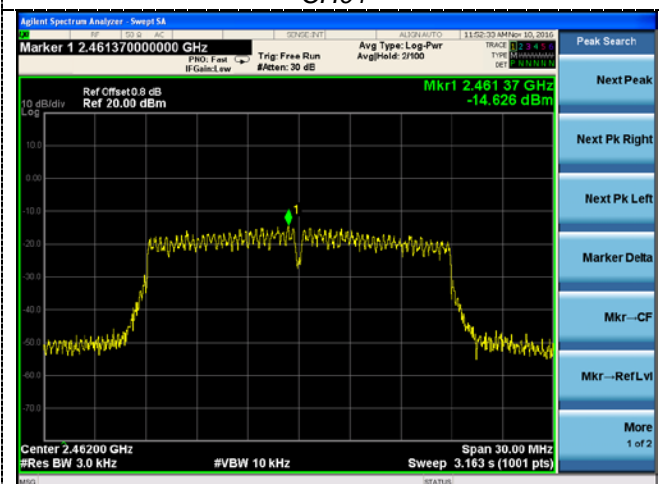

CH11

