FCC Part 90 Rules Test Report

Report No.: AGC05395151102FE10

FCC ID : 2AE6CEP3120U1
PRODUCT DESIGNATION : Digital Portable Radio
BRAND NAME : EXCERA
MODEL NAME : EP3120 U1
CLIENT : Shenzhen Excera Technology Co., Ltd.
DATE OF ISSUE : Jan.28, 2016
STANDARD(S) : FCC Part 90 Rules
REPORT VERSION : V 1.0

Attestation of Global Compliance (Shenzhen) Co., Ltd



CAUTION:

This report shall not be reproduced except in full without the written permission of the test laboratory and shall not be quoted out of context.



REPORT REVISE RECORD

Report Version	Revise Time	Issued Date	Valid Version	Notes
V1.0	/	Jan.28, 2016	Valid	Original Report

TABLE OF CONTENTS

1. VERIFICATION OF COMPLIANCE	5
2. GENERAL INFORMATION	6
2.1 PRODUCT DESCRIPTION	6
2.2 RELATED SUBMITTAL(S) / GRANT (S)	7
2.3 TEST METHODOLOGY	8
2.4 TEST FACILITY	8
2.5 SPECIAL ACCESSORIES	8
2.6 EQUIPMENT MODIFICATIONS	8
3. SYSTEM TEST CONFIGURATION	9
3.1 EUT CONFIGURATION	9
3.2 EUT EXERCISE	9
3.3 GENERAL TECHNICAL REQUIREMENTS	9
3.4 CONFIGURATION OF TESTED SYSTEM.....	10
3.5. SUMMARY OF TEST RESULTS	10
4. IDENTIFICATION OF THE RESPONSIBLE TESTING LOCATION	11
5. DESCRIPTION OF TEST MODES	12
6. FREQUENCY TOLERANCE	13
6.1 PROVISIONS APPLICABLE	13
6.2 MEASUREMENT PROCEDURE	13
6.3 TEST SETUP BLOCK DIAGRAM	14
6.4 TEST RESULT	15
7. EMISSION BANDWIDTH	23
7.1 PROVISIONS APPLICABLE	23
7.2 MEASUREMENT PROCEDURE	23
7.3 TEST SETUP BLOCK DIAGRAM	23
7.4 MEASUREMENT RESULT	24
8. UNWANTED RADIATION	26
8.1 PROVISIONS APPLICABLE	26
8.2 MEASUREMENT PROCEDURE	26
8.3 TEST SETUP BLOCK DIAGRAM	27
8.4 MEASUREMENT RESULTS:.....	29
8.5 EMISSION MASK PLOT	35
9. MODULATION CHARACTERISTICS	37
9.1 PROVISIONS APPLICABLE	37
9.2 MEASUREMENT METHOD	37
9.3 MEASUREMENT RESULT	38
10. MAXIMUM TRANSMITTER POWER (CONDUCTED OUTPUT POWER)	44
10.1 PROVISIONS APPLICABLE	44
10.2 TEST PROCEDURE	44

10.3 TEST CONFIGURATION 44

10.4 TEST RESULT 46

10.5 CONDUCT SPURIOUS PLOT 48

11. TRANSMITTER FREQUENCY BEHAVIOR 50

11.1 PROVISIONS APPLICABLE 50

11.2 TEST METHOD 50

11.3 DESCRIBE LIMIT LINE OF TRANSMITTER FREQUENCY BEHAVIOR 51

11.4 MEASURE RESULT 52

12. AUDIO LOW PASS FILTER RESPONSE 53

12.1 LIMITS 53

12.2. METHOD OF MEASUREMENTS 53

12.3 TEST DATA 54

APPENDIX I: PHOTOGRAPHS OF SETUP 58

APPENDIX II: EXTERNAL VIEW OF EUT 59

1. VERIFICATION OF COMPLIANCE

Applicant	Shenzhen Excera Technology Co., Ltd.
Address	3rd Floor, Jiada R&D Building, No.5 Songpingshan Road, Hi-Tech Park North, Nanshan District, Shenzhen, 518052, China
Manufacturer	Shenzhen Excera Technology Co., Ltd.
Address	3rd Floor, Jiada R&D Building, No.5 Songpingshan Road, Hi-Tech Park North, Nanshan District, Shenzhen, 518052, China
Product Designation	Digital Portable Radio
Brand Name	EXCERA
Test Model	EP3120 U1
Date of Test	Jan.26, 2016 to Jan.27, 2016

WE HEREBY CERTIFY THAT:

The above equipment was tested by Dong guan Precise Testing Service Co., Ltd. The data evaluation, test procedures, and equipment configurations shown in this report were made in accordance with the procedures given in TIA/EIA 603. The sample tested as described in this report is in compliance with the FCC Rules Part 90 requirements.

The test results of this report relate only to the tested sample identified in this report.

Tested by



Steven Zhou (Zhou Pengyun) Jan.28, 2016

Reviewed by

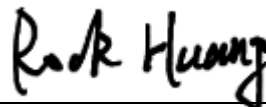

Rock Huang (Huang Dinglue) Jan.28, 2016

Approved by



Solger Zhang (Zhang Hongyi)
Authorized Officer Jan.28, 2016

2. GENERAL INFORMATION

2.1 PRODUCT DESCRIPTION

The EUT is a **DIGITAL/ANALOG RADIO** designed for voice/data communication. It is designed by way of utilizing the FM/4FSK modulation achieves the system operating.

A major technical description of EUT is described as following:

Communication Type	Voice / data
Modulation	FM/4FSK
Emission Type	11K0F3E, 7K60FXD, 7K60FXW
Emission Bandwidth	Analog:6.200KHz Digital: 9.265KHz
Peak Frequency Deviation	Analog:1.78KHz Digital: 1.91KHz
Audio Frequency Response	Analog:6.75 dB Digital: 9.71 dB
Maximum Transmitter Power	Analog:36.85 dBm Digital: 36.90 dBm
Output power Modification	5W (It was fixed by the manufacturer, any individual can't arbitrarily change it.)
Data Rate	9600bps/12.5KHz(Channel Spacing)
Antenna Designation	Detachable
Antenna Model	QA13U
Antenna Gain	2.15 dBi
Power Supply	DC 7.4V, 2000mAh (by battery)
Adapter Parameter	INPUT: 100V-240V , 50HZ , 0.3A OUTPUT: 12V , 0.5A
Limiting Voltage	DC 6.00V-8.51V
Operation Frequency Range and Channel	Frequency Range: 400MHz to 480MHz (UHF) Channel Spacing: 12.5KHz (Analog), 12.5KHz(Digital)
	Bottom Channel: 400.025MHz Middle Channel: 440.025MHz Top Channel: 479.975MHz
Frequency Tolerance	1.277ppm

Frequency Range (MHz)	Rated Transmit Power(W)(Conducted)	Transmit Mode/Emission Designator
400-480	5	11K0F3E(Analog Voice;NB)
400-480	5	7K60FXD/7K60FXW(9600Data/Digital Voice NB)

Channel No. (6.25KHz)	Channel No. (12.5KHz)	12.5KHz Channel Spaced 400MHz Band Plan(MHz)
1	1-2	400.025
2		
3	3-4	440.025
4		
5	5-6	479.975
6		

FCC Rules and Regulations Part 2.202: Necessary Bandwidth and Emission Bandwidth
Voice –FM Analog (12.5KHz)

Calculation:

Max modulation (M) in kHz : 3.0

Max deviation(D) in kHz:2.5

Constant factor (K): 1(assumed)

$B_n = 2XM + 2XDK = 11.0 \text{ KHz}$

Emission designator: 11K0F3E

9600 Digital Voice/data (12.5KHz)

Calculation:

Data rate in bps(R)=9600

Deviation Peak deviation of carrier(D)=2359.585

Constant factor (K): 1 (default)

$B_n = 3.86D + 1.27RK = 3.86(2359.585) + 0.27(9600)(1) = 11.7 \text{ KHz}$

Emission designator: 11K0FXD

2.2 RELATED SUBMITTAL(S) / GRANT (S)

This submittal(s) (test report) is intended for FCC ID: **2AE6CEP3120U1**, filing to comply with the FCC Part 90 requirements

2.3 TEST METHODOLOGY

The radiated emission testing was performed according to the procedures of TIA/EIA 603 and FCC CFR 47 Rules of 2.1046, 2.1047, 2.1049, 2.1051, 2.1053, 2.1055, 2.1057.

2.4 TEST FACILITY

The test site used to collect the radiated data is located on the address of Dong guan Precise Testing Service Co., Ltd. The test site is constructed and calibrated to meet the FCC requirements in documents TIA/EIA 603.

2.5 SPECIAL ACCESSORIES

Not available for this EUT intended for grant.

2.6 EQUIPMENT MODIFICATIONS

Not available for this EUT intended for grant.

3. SYSTEM TEST CONFIGURATION

3.1 EUT CONFIGURATION

The EUT configuration for testing is installed on RF field strength measurement to meet the Commission's requirement and operating in a manner which intends to maximize its emission characteristics in a continuous normal application.

3.2 EUT EXERCISE

The Transmitter was operated in transmitting mode. The TX frequency was fixed which was for the purpose of the measurements.

3.3 GENERAL TECHNICAL REQUIREMENTS

For FCC Part 90 requirements:

- (1). Section 90.205: Maximum ERP is dependent upon the station's antenna HAAT and required service area
- (2). Section 90.207: Modulation Characteristic
- (3). Section 90.209: Occupied Bandwidth
- (4). Section 90.210: Emission Mask
- (5). Section 90.213: Frequency Tolerance
- (6). Section 90.214: Transient Frequency Behavior

3.4 CONFIGURATION OF TESTED SYSTEM

Fig. 2-1 Configuration of Tested System



Table 2-1 Equipment Used in Tested System

Item	Equipment	Model No.	Identifier	Note
1	Digital Portable Radio	EP3120 U1	FCC ID: 2AE6CEP3120U1	EUT

3.5. SUMMARY OF TEST RESULTS

FCC Rules	Description Of Test	Result
§90.205	Maximum Transmitter Power	Compliant
§90.207	Modulation Characteristic	Compliant
§90.209	Occupied Bandwidth	Compliant
§90.210	Emission Mask	Compliant
§90.213	Frequency Tolerance	Compliant
§90.214	Transient Frequency Behavior	Compliant

4. IDENTIFICATION OF THE RESPONSIBLE TESTING LOCATION

Site	Dongguan Precise Testing Service Co., Ltd.
Location	Building D, Baoding Technology Park, Guangming Road2, Dongcheng District, Dongguan, Guangdong, China.
Description	The test site is constructed and calibrated to meet the FCC requirements in documents TIA/EIA 603.
FCC Registration No.	371540

List of Equipments Used

NAME OF EQUIPMENT	MANUFACTURER	MODEL	SERIAL NO.	Cal. Date	Cal. Due
CLIMATE CHAMBER	EXPERY	TN-400	TN2007SR038	2015.07.14	2016.07.13
ATTENUATOR	WEINSCHTEL CORP	58-30-33	ML030	2015.03.06	2016.03.05
DC POWER SUPPLY	ZHAOXIN	RXN-605D	N/A	2015.03.06	2016.03.05
MODULATION ANALYZER	HP	8920B	3104A03367	2015.07.23	2016.07.22
SIGNAL GENERATOR	AGILENT	E4421B	122501288	2015.07.25	2016.07.24
SIGNAL GENERATOR	R&S	SMT03	A0304261	2015.07.25	2016.07.24
EMI Test Receiver	Rohde & Schwarz	ESCI	101417	2015.07.04	2016.07.03
Trilog Broadband Antenna	SCHWARZBECK	VULB9160	9160-3355	2015.07.04	2016.07.03
Substitution Antenna	SCHWARZBECK	VULB9160	9168-494	2015.07.04	2016.07.03
Signal Amplifier	SCHWARZBECK	BBV 9475	9745-0013	2015.07.04	2016.07.03
RF Cable	SCHWARZBECK	AK9515E	96221	2015.07.04	2016.07.03
3m Anechoic Chamber	CHENGYU	966	PTS-001	2015.06.06	2016.06.05
MULTI-DEVICE Positioning Controller	Max-Full	MF-7802	MF780208339	N/A	N/A
Active loop antenna (9K-30MHz)	Schwarzbeck	FMZB1519	1519-038	2015.06.06	2016.06.05
Spectrum analyzer	Agilent	E4407B	MY46185649	2015.06.06	2016.06.05
Double-Ridged Waveguide Horn	ETS LINDGREN	3117	00034609	2015.06.06	2016.06.05
Substitution ANTENNA	EM	EM-AH-10180	67	2015.06.06	2016.06.05
Modulation Domain Analyzer	HP	53310A	3121A02467	2015.06.06	2016.06.05
EMI Test Receiver	Rohde & Schwarz	ESCI	101417	2015.07.06	2016.07.05
RF Cable	SCHWARZBECK	AK9515E	96222	2015.07.04	2016.07.03
Shielded Room	CHENGYU	843	PTS-002	2015.06.06	2016.06.05

NOTE: 8920B can generate audio modulation frequency.

5. DESCRIPTION OF TEST MODES

RF TEST MODES

The EUT (Digital Portable Radio) has been tested under transmitting condition. (The top channel, the middle channel and the bottom channel) are chosen for testing at each channel separation.

Analog:

No.	TEST MODES	CHANNEL SEPARATION
1	Bottom Channel	12.5 KHz
2	Middle Channel	12.5 KHz
3	Top Channel	12.5 KHz

Digital:

No.	TEST MODES	CHANNEL SEPARATION
1	Bottom Channel	12.5 KHz
2	Middle Channel	12.5 KHz
3	Top Channel	12.5 KHz

EMC TEST MODES

No.	TEST MODES
1	Standby Mode+ TX

Note: Only the result of the worst case was recorded in the report.

6. FREQUENCY TOLERANCE

6.1 PROVISIONS APPLICABLE

- a). According to FCC Part 2 Section 2.1055(a)(1), the frequency stability shall be measured with variation of ambient temperature from -30°C to $+50^{\circ}\text{C}$ centigrade.
- b). According to FCC Part 2 Section 2.1055(d)(2), for battery powered equipment, the frequency stability shall be measured with reducing primary supply voltage to the battery operating end point, which is specified by the manufacturer.
- c). According to FCC Part 90 Section 90.213, the frequency tolerance must be maintained within 0.00025% for 12.5 KHz channel separation and 0.0001% for 6.25 KHz channel separation.

6.2 MEASUREMENT PROCEDURE

6.2.1 FREQUENCY STABILITY VERSUS ENVIRONMENTAL TEMPERATURE

1. Setup the configuration per figure 1 for frequencies measurement inside an environment chamber, Install new battery in the EUT.
2. Turn on EUT and set SA center frequency to the EUT radiated frequency. Set SA Resolution Bandwidth to 1KHz and Video Resolution Bandwidth to 1KHz and Frequency Span to 50KHz. Record this frequency as reference frequency.
3. Set the temperature of chamber to 50°C . Allow sufficient time (approximately 30 min) for the temperature of the chamber to stabilize. While maintaining a constant temperature inside the chamber, turn the EUT on and measure the EUT operating frequency.
4. Repeat step 2 with a 10°C decreased per stage until the lowest temperature -30°C is measured, record all measured frequencies on each temperature step.

6.2.2 FREQUENCY STABILITY VERSUS INPUT VOLTAGE

1. Setup the configuration per figure 1 for frequencies measured at temperature if it is within 15°C to 25°C . Otherwise, an environment chamber set for a temperature of 20°C shall be used. The EUT shall be powered by DC 7.4V.
2. Set SA center frequency to the EUT radiated frequency. Set SA Resolution Bandwidth to 1 KHz and Video Resolution Bandwidth to 1KHz. Record this frequency as reference frequency.
3. Supply the EUT primary voltage at the operating end point which is specified by manufacturer and record the frequency.

6.3 TEST SETUP BLOCK DIAGRAM

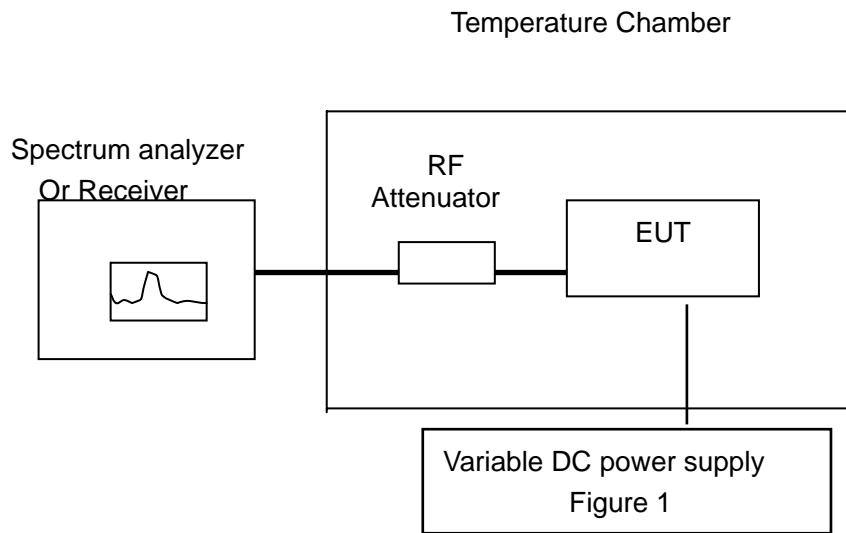

6.4 TEST RESULT

Analog:

(1) Frequency stability versus input voltage (Supply nominal voltage is 7.40V)-5W

Bottom Channel @ 12.5 KHz Channel Separation

Reference Frequency:	400.025 MHz	Limit:	2.5ppm
Environment Temperature	Power Supply	Frequency Deviation	
(°C)	(V)	(MHz)	ppm
50	DC 7.40 V	400.025206	0.515
40	DC 7.40 V	400.02539	0.975
30	DC 7.40 V	400.025372	0.930
20	DC 7.40 V	400.025402	1.005
10	DC 7.40 V	400.025193	0.482
0	DC 7.40 V	400.025301	0.752
-10	DC 7.40 V	400.025273	0.682
-20	DC 7.40 V	400.025097	0.242
-30	DC 7.40 V	400.025453	1.132

Middle Channel @ 12.5 KHz Channel Separation

Reference Frequency:	440.025 MHz	Limit:	2.5ppm
Environment Temperature	Power Supply	Frequency Deviation	
(°C)	(V)	(MHz)	ppm
50	DC 7.40 V	440.025176	0.400
40	DC 7.40 V	440.025129	0.293
30	DC 7.40 V	440.025405	0.920
20	DC 7.40 V	440.025283	0.643
10	DC 7.40 V	440.025165	0.375
0	DC 7.40 V	440.025342	0.777
-10	DC 7.40 V	440.025187	0.425
-20	DC 7.40 V	440.025303	0.689
-30	DC 7.40 V	440.025099	0.225

Top Channel @ 12.5 KHz Channel Separation

Reference Frequency:	479.975 MHz	Limit:	2.5ppm
Environment Temperature	Power Supply	Frequency Deviation	
(°C)	(V)	(MHz)	ppm
50	DC 7.40 V	479.975256	0.533
40	DC 7.40 V	479.975398	0.829
30	DC 7.40 V	479.975401	0.835
20	DC 7.40 V	479.975183	0.381
10	DC 7.40 V	479.975231	0.481
0	DC 7.40 V	479.975406	0.846
-10	DC 7.40 V	479.975352	0.733
-20	DC 7.40 V	479.975261	0.544
-30	DC 7.40 V	479.975393	0.819

(2) Frequency stability versus input voltage (Battery limiting voltage is 6.29V) -5W

Bottom Channel @ 12.5 KHz Channel Separation

Reference Frequency:	400.025 MHz	Limit:	2.5ppm
Environment Temperature	Power Supply	Frequency Deviation	
(°C)	(V)	(MHz)	ppm
50	DC 6.29 V	400.025363	0.907
40	DC 6.29 V	400.025259	0.647
30	DC 6.29 V	400.025436	1.090
20	DC 6.29 V	400.025295	0.737
10	DC 6.29 V	400.025347	0.867
0	DC 6.29 V	400.025291	0.727
-10	DC 6.29 V	400.025334	0.835
-20	DC 6.29 V	400.025502	1.255
-30	DC 6.29 V	400.025488	1.220

Middle Channel @ 12.5 KHz Channel Separation

Reference Frequency:	440.025 MHz	Limit:	2.5ppm
Environment Temperature	Power Supply	Frequency Deviation	
(°C)	(V)	(MHz)	ppm
50	DC 6.29 V	440.025163	0.370
40	DC 6.29 V	440.025254	0.577
30	DC 6.29 V	440.025312	0.709
20	DC 6.29 V	440.025261	0.593
10	DC 6.29 V	440.025256	0.582
0	DC 6.29 V	440.025312	0.709
-10	DC 6.29 V	440.025463	1.052
-20	DC 6.29 V	440.025281	0.639
-30	DC 6.29 V	440.025435	0.989

Top Channel @ 12.5 KHz Channel Separation

Reference Frequency:	479.975 MHz	Limit:	2.5ppm
Environment Temperature	Power Supply	Frequency Deviation	
(°C)	(V)	(MHz)	ppm
50	DC 6.29 V	479.975306	0.638
40	DC 6.29 V	479.975149	0.310
30	DC 6.29 V	479.975231	0.481
20	DC 6.29 V	479.975265	0.552
10	DC 6.29 V	479.975493	1.027
0	DC 6.29 V	479.97538	0.792
-10	DC 6.29 V	479.975403	0.840
-20	DC 6.29 V	479.975223	0.465
-30	DC 6.29 V	479.975189	0.394

(3) Frequency stability versus input voltage (Battery Fully Charged voltage is 8.51V) **-5W**

Bottom Channel @ 12.5 KHz Channel Separation

Reference Frequency:	400.025 MHz	Limit:	2.5ppm
Environment Temperature	Power Supply	Frequency Deviation	
(°C)	(V)	(MHz)	ppm
50	DC 8.51 V	400.025369	0.922
40	DC 8.51 V	400.025463	1.157
30	DC 8.51 V	400.025143	0.357
20	DC 8.51 V	400.025208	0.520
10	DC 8.51 V	400.025507	1.267
0	DC 8.51 V	400.025374	0.935
-10	DC 8.51 V	400.025286	0.715
-20	DC 8.51 V	400.025293	0.732
-30	DC 8.51 V	400.025361	0.902

Middle Channel @ 12.5 KHz Channel Separation

Reference Frequency:	440.025 MHz	Limit:	2.5ppm
Environment Temperature	Power Supply	Frequency Deviation	
(°C)	(V)	(MHz)	ppm
50	DC 8.51 V	440.025436	0.991
40	DC 8.51 V	440.025225	0.511
30	DC 8.51 V	440.025186	0.423
20	DC 8.51 V	440.025247	0.561
10	DC 8.51 V	440.025108	0.245
0	DC 8.51 V	440.025216	0.491
-10	DC 8.51 V	440.025352	0.800
-20	DC 8.51 V	440.025488	1.109
-30	DC 8.51 V	440.025367	0.834

Top Channel @ 12.5 KHz Channel Separation

Reference Frequency:	479.975 MHz	Limit:	2.5ppm
Environment Temperature	Power Supply	Frequency Deviation	
(°C)	(V)	(MHz)	ppm
50	DC 8.51 V	479.975285	0.594
40	DC 8.51 V	479.975333	0.688
30	DC 8.51 V	479.975178	0.371
20	DC 8.51 V	479.97552	1.083
10	DC 8.51 V	479.975369	0.769
0	DC 8.51 V	479.975467	0.973
-10	DC 8.51 V	479.975388	0.808
-20	DC 8.51 V	479.975292	0.608
-30	DC 8.51 V	479.975355	0.740

(4) Frequency stability versus input voltage (Battery end point is 6.0V) -5W

Bottom Channel @ 12.5 KHz Channel Separation

Reference Frequency:	400.025 MHz	Limit:	2.5ppm
Environment Temperature	Power Supply	Frequency Deviation	
(°C)	(Battery End Point)	(MHz)	ppm
50	DC 6.00 V	400.025128	0.320
40	DC 6.00 V	400.025362	0.905
30	DC 6.00 V	400.025257	0.642
20	DC 6.00 V	400.025085	0.212
10	DC 6.00 V	400.025122	0.305
0	DC 6.00 V	400.025261	0.652
-10	DC 6.00 V	400.025241	0.602
-20	DC 6.00 V	400.025286	0.715
-30	DC 6.00 V	400.025273	0.682

Middle Channel @ 12.5 KHz Channel Separation

Reference Frequency:	440.025 MHz	Limit:	2.5ppm
Environment Temperature	Power Supply	Frequency Deviation	
(°C)	(Battery End Point)	(MHz)	ppm
50	DC 6.00 V	440.025248	0.564
40	DC 6.00 V	440.025269	0.611
30	DC 6.00 V	440.025125	0.284
20	DC 6.00 V	440.02526	0.591
10	DC 6.00 V	440.025291	0.661
0	DC 6.00 V	440.025235	0.534
-10	DC 6.00 V	440.025328	0.745
-20	DC 6.00 V	440.025219	0.498
-30	DC 6.00 V	440.025351	0.798

Top Channel @ 12.5 KHz Channel Separation

Reference Frequency:	479.975 MHz	Limit:	2.5ppm
Environment Temperature	Power Supply	Frequency Deviation	
(°C)	(Battery End Point)	(MHz)	ppm
50	DC 6.00 V	479.975258	0.538
40	DC 6.00V	479.975134	0.279
30	DC 6.00 V	479.975153	0.319
20	DC 6.00 V	479.975328	0.683
10	DC 6.00 V	479.975096	0.200
0	DC 6.00 V	479.975314	0.654
-10	DC 6.00 V	479.975281	0.585
-20	DC 6.00 V	479.975276	0.575
-30	DC 6.00 V	479.975084	0.175

Digital:

(1) Frequency stability versus input voltage (Supply nominal voltage is 7.40V)-5W

Bottom Channel @ 12.5 KHz Channel Separation

Reference Frequency:	400.025 MHz	Limit:	2.5ppm
Environment Temperature	Power Supply	Frequency Deviation	
(°C)	(V)	(MHz)	ppm
50	DC 7.40 V	400.025312	0.780
40	DC 7.40 V	400.025436	1.090
30	DC 7.40 V	400.025207	0.517
20	DC 7.40 V	400.025354	0.885
10	DC 7.40 V	400.025286	0.715
0	DC 7.40 V	400.025393	0.982
-10	DC 7.40 V	400.025478	1.195
-20	DC 7.40 V	400.025383	0.957
-30	DC 7.40 V	400.025123	0.307

Middle Channel @ 12.5 KHz Channel Separation

Reference Frequency:	440.025 MHz	Limit:	2.5ppm
Environment Temperature	Power Supply	Frequency Deviation	
(°C)	(V)	(MHz)	ppm
50	DC 7.40 V	440.025236	0.536
40	DC 7.40 V	440.025364	0.827
30	DC 7.40 V	440.025472	1.073
20	DC 7.40 V	440.025388	0.882
10	DC 7.40 V	440.025562	1.277
0	DC 7.40 V	440.025243	0.552
-10	DC 7.40 V	440.025162	0.368
-20	DC 7.40 V	440.025354	0.804
-30	DC 7.40 V	440.025355	0.807

Top Channel @ 12.5 KHz Channel Separation

Reference Frequency:	479.975 MHz	Limit:	2.5ppm
Environment Temperature	Power Supply	Frequency Deviation	
(°C)	(V)	(MHz)	ppm
50	DC 7.40 V	479.975253	0.527
40	DC 7.40 V	479.975134	0.279
30	DC 7.40 V	479.975253	0.527
20	DC 7.40 V	479.975361	0.752
10	DC 7.40 V	479.975526	1.096
0	DC 7.40 V	479.975255	0.531
-10	DC 7.40 V	479.975313	0.652
-20	DC 7.40 V	479.975422	0.879
-30	DC 7.40 V	479.975316	0.658

(2) Frequency stability versus input voltage (Battery limiting voltage is 6.29V) -5W

Bottom Channel @ 12.5 KHz Channel Separation

Reference Frequency:	400.025 MHz	Limit:	2.5ppm
Environment Temperature	Power Supply	Frequency Deviation	
(°C)	(V)	(MHz)	ppm
50	DC 6.29 V	400.025251	0.627
40	DC 6.29 V	400.025321	0.802
30	DC 6.29 V	400.02551	1.275
20	DC 6.29 V	400.025393	0.982
10	DC 6.29 V	400.025258	0.645
0	DC 6.29 V	400.025342	0.855
-10	DC 6.29 V	400.02528	0.700
-20	DC 6.29 V	400.025315	0.787
-30	DC 6.29 V	400.025295	0.737

Middle Channel @ 12.5 KHz Channel Separation

Reference Frequency:	440.025 MHz	Limit:	2.5ppm
Environment Temperature	Power Supply	Frequency Deviation	
(°C)	(V)	(MHz)	ppm
50	DC 6.29 V	440.025356	0.809
40	DC 6.29 V	440.025432	0.982
30	DC 6.29 V	440.025258	0.586
20	DC 6.29 V	440.025173	0.393
10	DC 6.29 V	440.025265	0.602
0	DC 6.29 V	440.025317	0.720
-10	DC 6.29 V	440.025294	0.668
-20	DC 6.29 V	440.025353	0.802
-30	DC 6.29 V	440.025182	0.414

Top Channel @ 12.5 KHz Channel Separation

Reference Frequency:	479.975 MHz	Limit:	2.5ppm
Environment Temperature	Power Supply	Frequency Deviation	
(°C)	(V)	(MHz)	ppm
50	DC 6.29 V	479.975435	0.906
40	DC 6.29 V	479.975162	0.338
30	DC 6.29 V	479.975523	1.090
20	DC 6.29 V	479.975274	0.571
10	DC 6.29 V	479.975356	0.742
0	DC 6.29 V	479.975431	0.898
-10	DC 6.29 V	479.975462	0.963
-20	DC 6.29 V	479.975334	0.696
-30	DC 6.29 V	479.975281	0.585

(3) Frequency stability versus input voltage (Battery Fully Charged voltage is 8.51V) -5W

Bottom Channel @ 12.5 KHz Channel Separation

Reference Frequency:	400.025 MHz	Limit:	2.5ppm
Environment Temperature	Power Supply	Frequency Deviation	
(°C)	(V)	(MHz)	ppm
50	DC 8.51 V	400.025185	0.462
40	DC 8.51 V	400.025357	0.892
30	DC 8.51 V	400.025462	1.155
20	DC 8.51 V	400.025138	0.345
10	DC 8.51 V	400.025251	0.627
0	DC 8.51 V	400.025465	1.162
-10	DC 8.51 V	400.025361	0.902
-20	DC 8.51 V	400.02525	0.625
-30	DC 8.51 V	400.025148	0.370

Middle Channel @ 12.5 KHz Channel Separation

Reference Frequency:	440.025 MHz	Limit:	2.5ppm
Environment Temperature	Power Supply	Frequency Deviation	
(°C)	(V)	(MHz)	ppm
50	DC 8.51 V	440.025437	0.993
40	DC 8.51 V	440.025365	0.829
30	DC 8.51 V	440.025264	0.600
20	DC 8.51 V	440.025261	0.593
10	DC 8.51 V	440.025438	0.995
0	DC 8.51 V	440.025503	1.143
-10	DC 8.51 V	440.025126	0.286
-20	DC 8.51 V	440.025287	0.652
-30	DC 8.51 V	440.025391	0.889

Top Channel @ 12.5 KHz Channel Separation

Reference Frequency:	479.975 MHz	Limit:	2.5ppm
Environment Temperature	Power Supply	Frequency Deviation	
(°C)	(V)	(MHz)	ppm
50	DC 8.51 V	479.975387	0.806
40	DC 8.51 V	479.975261	0.544
30	DC 8.51 V	479.975624	1.300
20	DC 8.51 V	479.975375	0.781
10	DC 8.51 V	479.975496	1.033
0	DC 8.51 V	479.975261	0.544
-10	DC 8.51 V	479.975358	0.746
-20	DC 8.51 V	479.975435	0.906
-30	DC 8.51 V	479.975512	1.067

(4) Frequency stability versus input voltage (Battery end point is 6.0V) **-5W**

Bottom Channel @ 12.5 KHz Channel Separation

Reference Frequency:	400.025 MHz	Limit:	2.5ppm
Environment Temperature	Power Supply	Frequency Deviation	
(°C)	(Battery End Point)	(MHz)	ppm
50	DC 6.00 V	400.025264	0.660
40	DC 6.00 V	400.025239	0.597
30	DC 6.00 V	400.025362	0.905
20	DC 6.00 V	400.025351	0.877
10	DC 6.00 V	400.025243	0.607
0	DC 6.00 V	400.025291	0.727
-10	DC 6.00 V	400.025283	0.707
-20	DC 6.00 V	400.025316	0.790
-30	DC 6.00 V	400.025349	0.872

Middle Channel @ 12.5 KHz Channel Separation

Reference Frequency:	440.025 MHz	Limit:	2.5ppm
Environment Temperature	Power Supply	Frequency Deviation	
(°C)	(Battery End Point)	(MHz)	ppm
50	DC 6.00 V	440.025249	0.566
40	DC 6.00 V	440.025218	0.495
30	DC 6.00 V	440.025309	0.702
20	DC 6.00 V	440.025254	0.577
10	DC 6.00 V	440.025231	0.525
0	DC 6.00 V	440.025306	0.695
-10	DC 6.00 V	440.025317	0.720
-20	DC 6.00 V	440.025281	0.639
-30	DC 6.00 V	440.025167	0.380

Top Channel @ 12.5 KHz Channel Separation

Reference Frequency:	479.975 MHz	Limit:	2.5ppm
Environment Temperature	Power Supply	Frequency Deviation	
(°C)	(Battery End Point)	(MHz)	ppm
50	DC 6.00 V	479.975316	0.658
40	DC 6.00 V	479.975245	0.510
30	DC 6.00 V	479.975168	0.350
20	DC 6.00 V	479.975182	0.379
10	DC 6.00 V	479.975193	0.402
0	DC 6.00 V	479.975156	0.325
-10	DC 6.00 V	479.975402	0.838
-20	DC 6.00 V	479.975312	0.650
-30	DC 6.00 V	479.975125	0.260

7. EMISSION BANDWIDTH

7.1 PROVISIONS APPLICABLE

According to FCC Part 90 Section 90.209: The authorized bandwidth shall be 11.25 KHz for 12.5 KHz channel separation and 6 KHz for 6.25 KHz channel separation.

7.2 MEASUREMENT PROCEDURE

- 1). The EUT was placed on a turn table which is 0.8m above ground plane.
- 2). The EUT was modulated by 2.5 KHz Sine wave audio signal, The level of the audio signal employed is 16 dB greater than that necessary to produce 50% of rated system deviation. Rated system deviation is 2.5 kHz (12.5 kHz channel spacing).
- 3). Set SPA Center Frequency = fundamental frequency, RBW=100Hz, VBW= 300 Hz, Span =50 KHz.
- 4). Set SPA Max hold. Mark peak, -26 dB.

7.3 TEST SETUP BLOCK DIAGRAM

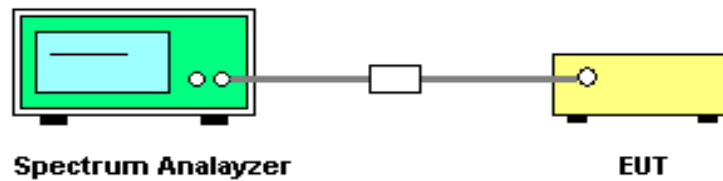

7.4 MEASUREMENT RESULT

Analog:

26 DB BANDWIDTH MEASUREMENT RESULT			
Operating Frequency	12.5 KHz Channel Separation		
	Test Data	Limits	Result
400.025MHz	6.196KHz	11.25 KHz	Pass
440.025MHz	6.188KHz	11.25 KHz	Pass
479.975MHz	6.200KHz	11.25 KHz	Pass

Occupied bandwidth of Top Channel (Maximum)

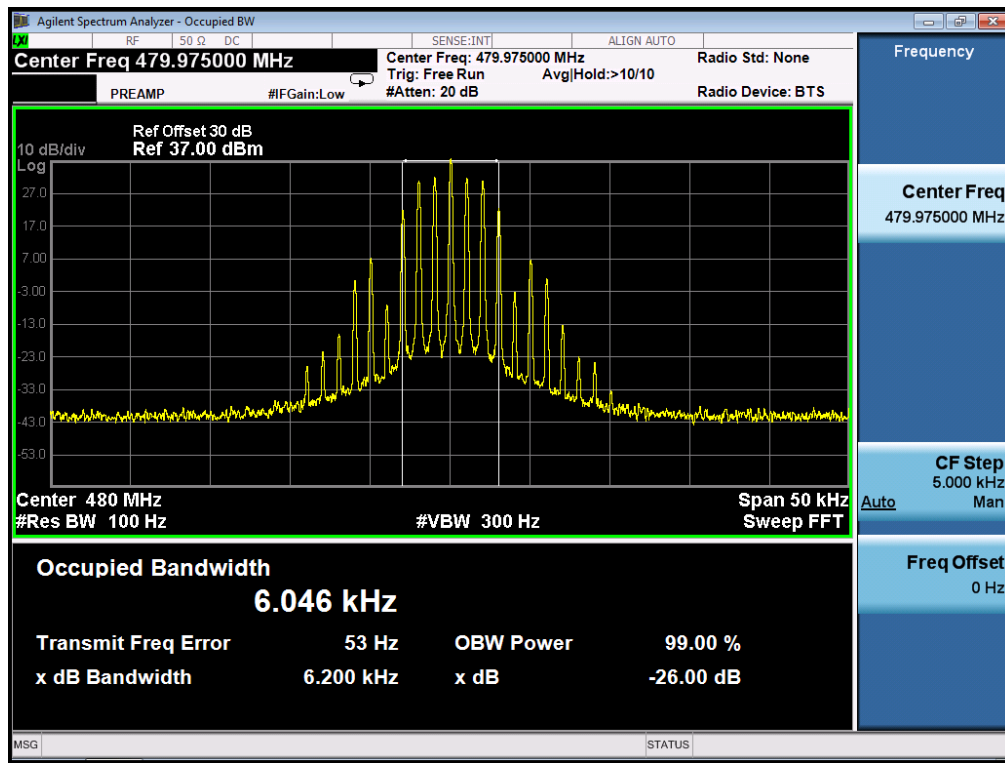

Digital:

TEST RESULTS

26 DB BANDWIDTH MEASUREMENT RESULT			
Operating Frequency	12.5 KHz Channel Separation		
	Test Data	Limits	Result
400.025MHz	9.260KHz	11.25 KHz	Pass
440.025MHz	9.265KHz	11.25 KHz	Pass
479.975MHz	9.257KHz	11.25 KHz	Pass

Occupied bandwidth of Middle Channel (Maximum)

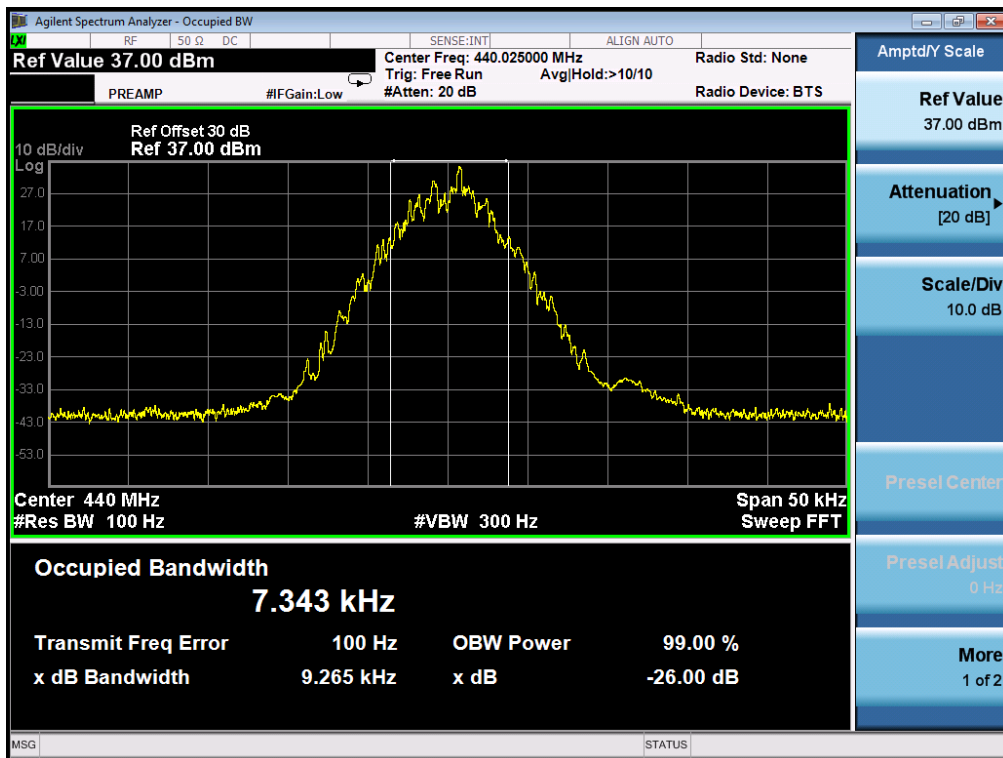

8. UNWANTED RADIATION

8.1 PROVISIONS APPLICABLE

8.1.1 According to Section 90.210, the power of each unwanted emission shall be less than Transmitted Power as specified below for transmitters designed to operate with each channel separation.

For 12.5 KHz Channel Separation:

- (1). On any frequency removed from the center of the authorized bandwidth f_0 to 5.625 KHz removed from f_0 : Zero dB.
- (2). On any frequency removed from the center of the authorized bandwidth by a displacement Frequency (f_d in KHz) f_0 of more than 5.625 KHz but no more than 12.5 KHz: At least $7.27(f_d - 2.88 \text{ KHz})$ dB
- (3). On any frequency removed from the center of the authorized bandwidth by a displacement Frequency (f_d in KHz) f_0 of more than 12.5 KHz: At least $50 + 10 \log(P)$ dB or 70 dB, whichever is lesser attenuation.

For 6.25 KHz Channel Separation:

- (1). On any frequency from the center of the authorized bandwidth f_0 to 3.0 kHz removed from f_0 : Zero dB.
- (2). On any frequency removed from the center of the authorized bandwidth by a displacement frequency (f_d in kHz) of more than 3.0 kHz but no more than 4.6 kHz: At least $30 + 16.67(f_d - 3 \text{ kHz})$ or $55 + 10 \log(P)$ or 65 dB, whichever is the lesser attenuation.
- (3). On any frequency removed from the center of the authorized bandwidth by more than 4.6 kHz: At least $55 + 10 \log(P)$ or 65 dB, whichever is the lesser attenuation.

8.2 MEASUREMENT PROCEDURE

- (1) On a test site, the EUT shall be placed on a turntable, and in the position closest to the normal use as declared by the user.
- (2) The test antenna shall be oriented initially for vertical polarization located 3m from the EUT to correspond to the transmitter.
- (3) The output of the antenna shall be connected to the measuring receiver and either a peak or quasi-peak detector was used for the measurement as indicated on the report. The detector selection is based on how close the emission level was approaching the limit.
- (4) The transmitter shall be switched on; if possible, without the modulation and the measurement receiver shall be tuned to the frequency of the transmitter under test.
- (5) The test antenna shall be raised and lowered through the specified range of height until the measuring receiver detects a maximum signal level.
- (6) The transmitter shall then be rotated through 360° in the horizontal plane, until the maximum signal level is detected by the measuring receiver.
- (7) The test antenna shall be raised and lowered again through the specified range of height until the measuring receiver detects a maximum signal level.

- (8) The maximum signal level detected by the measuring receiver shall be noted.
- (9) The measurement shall be repeated with the test antenna set to horizontal polarization.
- (10) Replace the antenna with a proper Antenna (substitution antenna).
- (11) The substitution antenna shall be oriented for vertical polarization and, if necessary, the length of the substitution antenna shall be adjusted to correspond to the frequency of transmitting.
- (12) The substitution antenna shall be connected to a calibrated signal generator.
- (13) If necessary, the input attenuator setting of the measuring receiver shall be adjusted in order to increase the sensitivity of the measuring receiver.
- (14) The test antenna shall be raised and lowered through the specified range of the height to ensure that the maximum signal is received.
- (15) The input signal to substitution antenna shall be adjusted to the level that produces a level detected by the measuring receiver, that is equal to the level noted while the transmitter radiated power was measured, corrected for the change of input attenuator setting of the measuring receiver.
- (16) The input level to the substitution antenna shall be recorded as power level in dBm, corrected for any change of input attenuator setting of the measuring receiver.
- (17) The measurement shall be repeated with the test antenna and the substitution antenna oriented for horizontal polarization.

8.3 TEST SETUP BLOCK DIAGRAM

SUBSTITUTION METHOD: (Radiated Emissions)

Radiated Below 1GHz

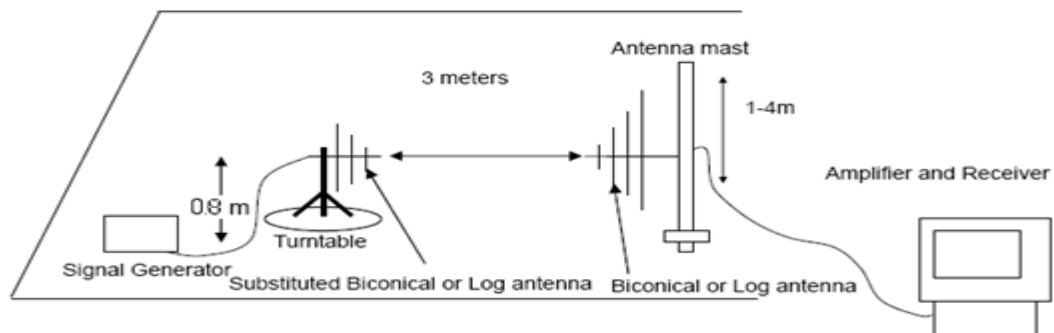
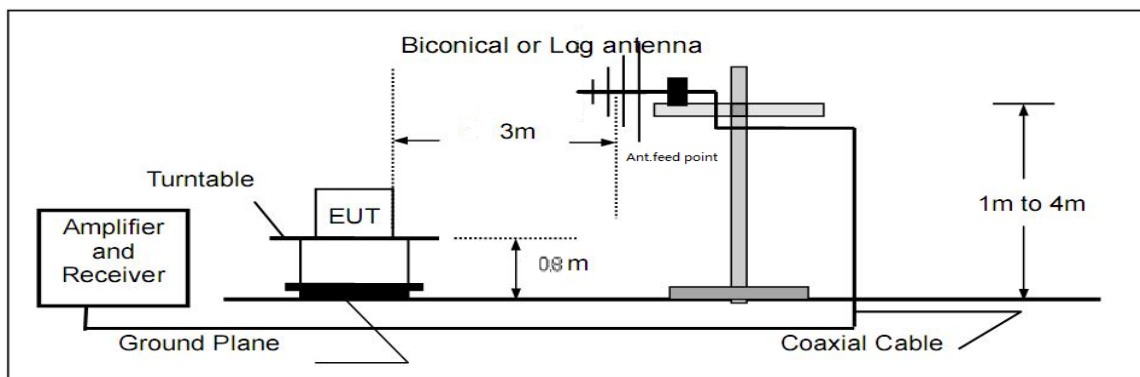

Radiated Above 1 GHz

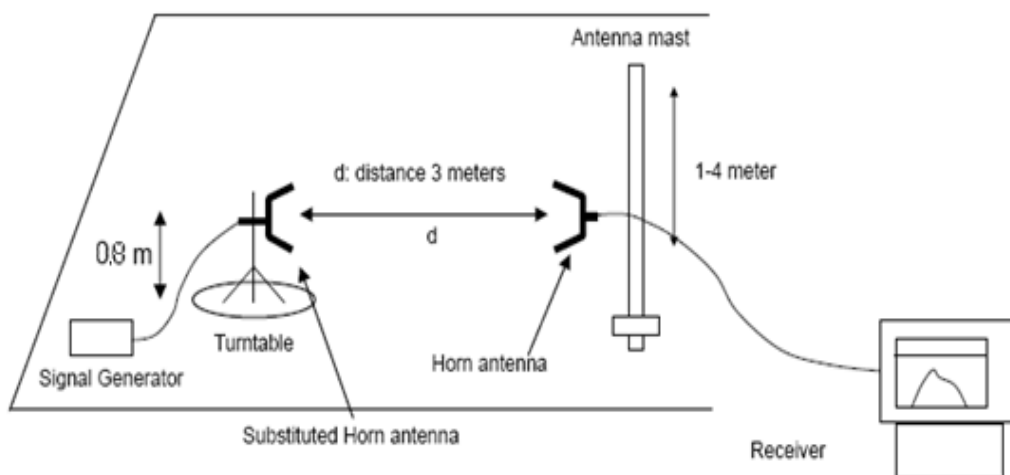
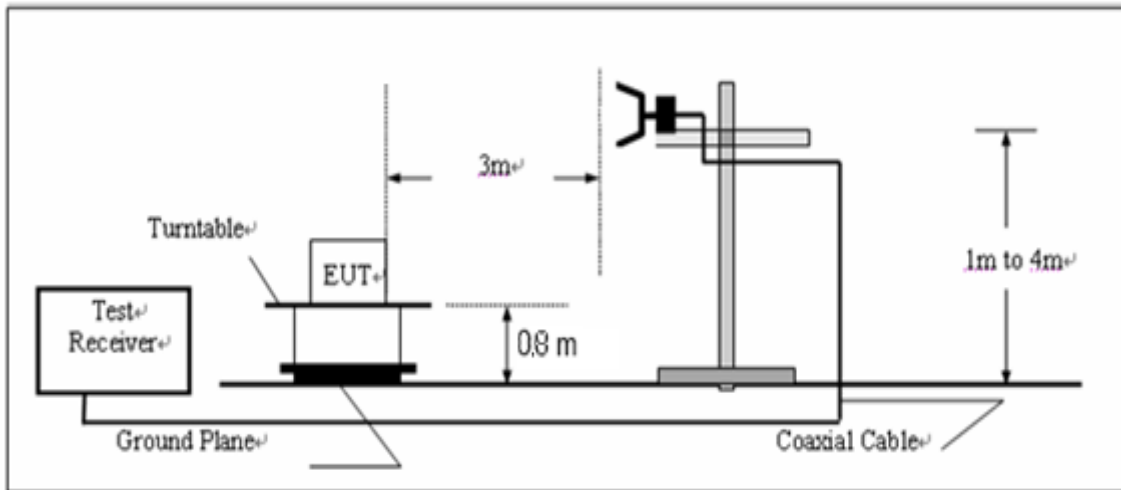

8.4 MEASUREMENT RESULTS:

Measurement Result for 12.5 KHz Channel Separation

On any frequency removed from the center of the authorized bandwidth by a displacement Frequency (f_d in KHz)for of more than 12.5 KHz: at least $50+10 \log(P)$ dB or 70 dB, which ever is lesser attenuation.

Limit: At least $50+10 \log(P) = 50+10\log(5) = 57$ (dB)

Analog:

TEST RESULTS

Measurement Result for 12.5 KHz Channel Separation @ 400.025MHz

Emission Frequency (MHz)	Ant. Polarity(H/V)	Measurement Result Below carrier(dBc)	Limit below carrier(dBc)	Result(P/F)
400.025	H	0		pass
800.050	H	86.92	57	pass
1200.075	H	87.61	57	pass
1600.100	H	89.64	57	pass
2000.125	H	90.58	57	pass
2400.150	H	87.69	57	pass
2800.175	H	88.42	57	pass
3200.200	H	89.14	57	pass
3600.225	H	89.52	57	pass
4000.250	H	90.22	57	pass

Emission Frequency (MHz)	Ant. Polarity(H/V)	Measurement Result Below carrier(dBc)	Limit below carrier(dBc)	Result(P/F)
400.025	V	0		pass
800.050	V	85.63	57	pass
1200.075	V	86.47	57	pass
1600.100	V	87.58	57	pass
2000.125	V	87.94	57	pass
2400.150	V	88.59	57	pass
2800.175	V	89.58	57	pass
3200.200	V	88.46	57	pass
3600.225	V	87.62	57	pass
4000.250	V	88.51	57	pass

Measurement Result for 12.5 KHz Channel Separation @ 440.025MHz

Emission Frequency (MHz)	Ant. Polarity(H/V)	Measurement Result Below carrier(dBc)	Limit below carrier(dBc)	Result(P/F)
440.025	H	0		pass
880.050	H	84.58	57	pass
1320.075	H	84.92	57	pass
1760.100	H	85.52	57	pass
2200.125	H	85.63	57	pass
2640.150	H	86.28	57	pass
3080.175	H	87.61	57	pass
3520.200	H	88.63	57	pass
3960.225	H	86.63	57	pass
4400.250	H	89.25	57	pass

Emission Frequency (MHz)	Ant. Polarity(H/V)	Measurement Result Below carrier(dBc)	Limit below carrier(dBc)	Result(P/F)
440.025	V	0		pass
880.050	V	83.21	57	pass
1320.075	V	84.69	57	pass
1760.100	V	87.69	57	pass
2200.125	V	89.53	57	pass
2640.150	V	87.38	57	pass
3080.175	V	86.64	57	pass
3520.200	V	88.26	57	pass
3960.225	V	89.58	57	pass
4400.250	V	86.91	57	pass

Measurement Result for 12.5 KHz Channel Separation @ 479.975MHz

Emission Frequency (MHz)	Ant. Polarity(H/V)	Measurement Result Below carrier(dBc)	Limit below carrier(dBc)	Result(P/F)
479.975	H	0		pass
959.950	H	84.69	57	pass
1439.925	H	85.24	57	pass
1919.900	H	86.29	57	pass
2399.875	H	89.16	57	pass
2879.850	H	88.62	57	pass
3359.825	H	87.14	57	pass
3839.800	H	89.52	57	pass
4319.775	H	89.28	57	pass
4799.750	H	90.61	57	pass

Emission Frequency (MHz)	Ant. Polarity(H/V)	Measurement Result Below carrier(dBc)	Limit below carrier(dBc)	Result(P/F)
479.975	V	0		pass
959.950	V	84.35	57	pass
1439.925	V	83.61	57	pass
1919.900	V	85.93	57	pass
2399.875	V	88.69	57	pass
2879.850	V	86.42	57	pass
3359.825	V	84.07	57	pass
3839.800	V	86.27	57	pass
4319.775	V	89.63	57	pass
4799.750	V	87.51	57	pass

Digital:

TEST RESULTS

Measurement Result for 12.5 KHz Channel Separation @ 400.025MHz

Emission Frequency (MHz)	Ant. Polarity(H/V)	Measurement Result Below carrier(dBc)	Limit below carrier(dBc)	Result(P/F)
400.025	H	0		pass
800.050	H	86.92	57	pass
1200.075	H	87.51	57	pass
1600.100	H	88.24	57	pass
2000.125	H	87.16	57	pass
2400.150	H	85.97	57	pass
2800.175	H	83.62	57	pass
3200.200	H	84.51	57	pass
3600.225	H	85.38	57	pass
4000.250	H	86.68	57	pass

Emission Frequency (MHz)	Ant. Polarity(H/V)	Measurement Result Below carrier(dBc)	Limit below carrier(dBc)	Result(P/F)
400.025	V	0		pass
800.050	V	83.59	57	pass
1200.075	V	83.91	57	pass
1600.100	V	84.62	57	pass
2000.125	V	85.16	57	pass
2400.150	V	85.18	57	pass
2800.175	V	83.24	57	pass
3200.200	V	82.13	57	pass
3600.225	V	84.52	57	pass
4000.250	V	86.25	57	pass

Measurement Result for 12.5 KHz Channel Separation @ 440.025MHz

Emission Frequency (MHz)	Ant. Polarity(H/V)	Measurement Result Below carrier(dBc)	Limit below carrier(dBc)	Result(P/F)
440.025	H	0		pass
880.050	H	85.64	57	pass
1320.075	H	84.26	57	pass
1760.100	H	83.38	57	pass
2200.125	H	85.29	57	pass
2640.150	H	84.58	57	pass
3080.175	H	86.19	57	pass
3520.200	H	87.81	57	pass
3960.225	H	89.73	57	pass
4400.250	H	88.24	57	pass

Emission Frequency (MHz)	Ant. Polarity(H/V)	Measurement Result Below carrier(dBc)	Limit below carrier(dBc)	Result(P/F)
440.025	V	0		pass
880.050	V	83.51	57	pass
1320.075	V	84.29	57	pass
1760.100	V	85.64	57	pass
2200.125	V	86.84	57	pass
2640.150	V	86.97	57	pass
3080.175	V	87.25	57	pass
3520.200	V	86.24	57	pass
3960.225	V	87.31	57	pass
4400.250	V	88.63	57	pass

Measurement Result for 12.5 KHz Channel Separation @ 479.975MHz

Emission Frequency (MHz)	Ant. Polarity(H/V)	Measurement Result Below carrier(dBc)	Limit below carrier(dBc)	Result(P/F)
479.975	H	0		pass
959.950	H	85.62	57	pass
1439.925	H	87.61	57	pass
1919.900	H	86.52	57	pass
2399.875	H	85.21	57	pass
2879.850	H	87.64	57	pass
3359.825	H	86.38	57	pass
3839.800	H	85.16	57	pass
4319.775	H	83.14	57	pass
4799.750	H	85.29	57	pass

Emission Frequency (MHz)	Ant. Polarity(H/V)	Measurement Result Below carrier(dBc)	Limit below carrier(dBc)	Result(P/F)
479.975	V	0		pass
959.950	V	84.96	57	pass
1439.925	V	85.27	57	pass
1919.900	V	89.28	57	pass
2399.875	V	87.14	57	pass
2879.850	V	86.25	57	pass
3359.825	V	87.18	57	pass
3839.800	V	84.53	57	pass
4319.775	V	86.28	57	pass
4799.750	V	87.39	57	pass

8.5 EMISSION MASK PLOT

The detailed procedure employed for Emission Mask measurements are specified as following:

- The transmitter shall be modulated by a 2.5 kHz audio signal,
- The level of the audio signal employed is 16 dB greater than that necessary to produce 50% of rated system deviation. Rated system deviation is 2.5 kHz.

Analog:

The Worst Emission Mask D for 12.5 KHz channel Separation (5W)

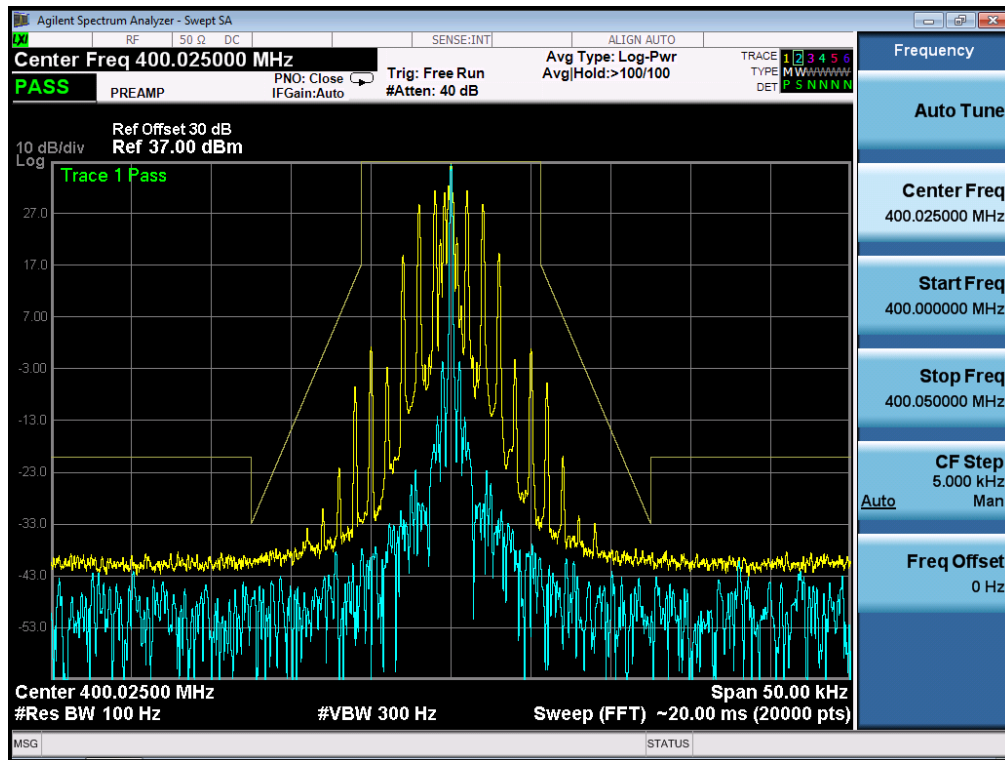

Digital:

The Worst Emission Mask D for 12.5 KHz channel Separation (5W)

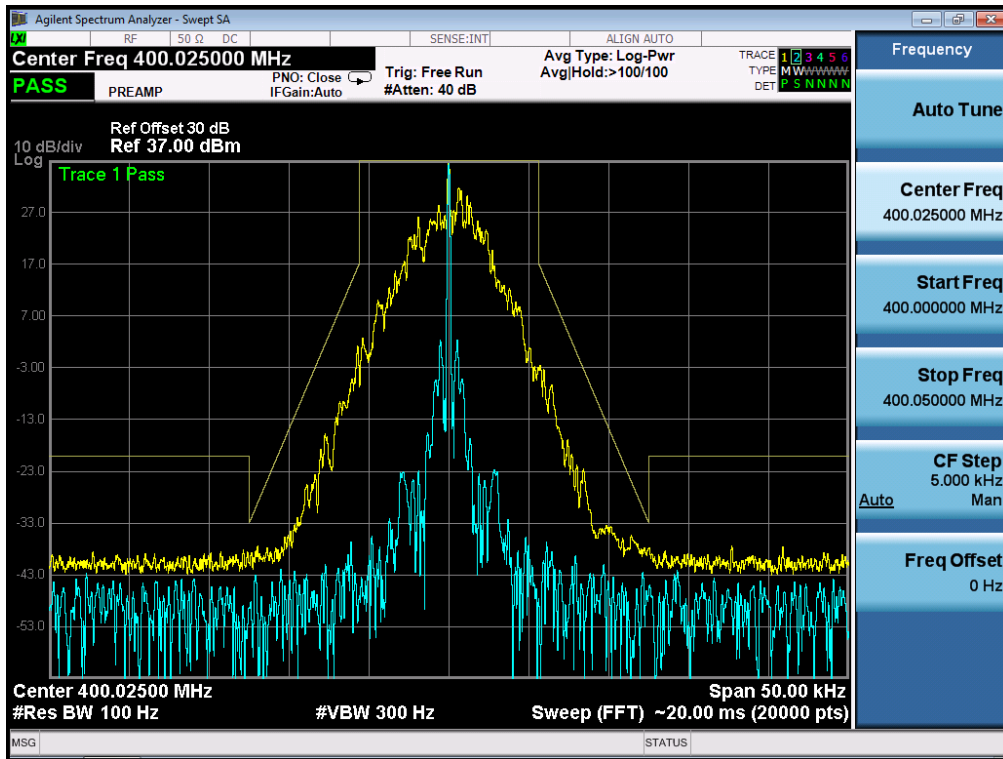

9. MODULATION CHARACTERISTICS

9.1 PROVISIONS APPLICABLE

According to CFR 47 section 2.1047(a), for Voice Modulation Communication Equipment, the frequency response of the audio modulation circuit over a range of 100 to 5000Hz shall be measured.

9.2 MEASUREMENT METHOD

9.2.1 MODULATION LIMIT

- (1). Configure the EUT as shown in figure 1, adjust the audio input for 60% of rated system deviation at 1KHz using this level as a reference (0dB) and vary the input level from -20 to +20dB. Record the frequency deviation obtained as a function of the input level.
- (2). Repeat step 1 with input frequency changing to 300, 1000, 1500 and 3000Hz in sequence.

9.2.2 AUDIO FREQUENCY RESPONSE

- (1). Configure the EUT as shown in figure 1.
- (2). Adjust the audio input for 20% of rated system deviation at 1 KHz using this level as a reference (0 dB).
- (3). Vary the Audio frequency from 100 Hz to 10 KHz and record the frequency deviation.
- (4). Audio Frequency Response = $20\log_{10}(\text{Deviation of test frequency}/\text{Deviation of 1 KHz reference})$.

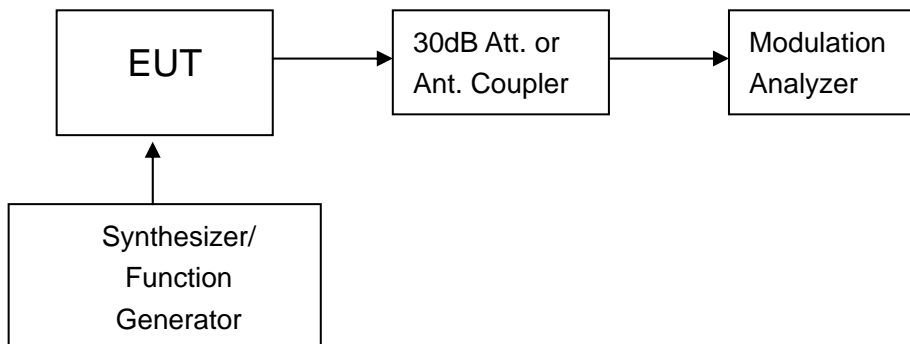

Figure 1: Modulation characteristic measurement configuration

9.3 MEASUREMENT RESULT

Analog:

TEST RESULTS

(A). MODULATION LIMIT:

Middle Channel @ 12.5 KHz Channel Separations

Modulation Level (dB)	Peak Freq. Deviation At 300 Hz	Peak Freq. Deviation At 1000 Hz	Peak Freq. Deviation At 1500 Hz	Peak Freq. Deviation At 3000 Hz
-20	0.2	0.65	0.73	0.87
-15	0.28	0.71	0.85	0.95
-10	0.35	1.09	1.21	1.28
-5	0.46	1.21	1.32	1.43
0	0.52	1.33	1.46	1.51
+5	0.68	1.39	1.52	1.73
+10	0.8	1.46	1.69	1.78
+15	0.91	1.53	1.69	1.72
+20	0.76	1.59	1.65	1.73

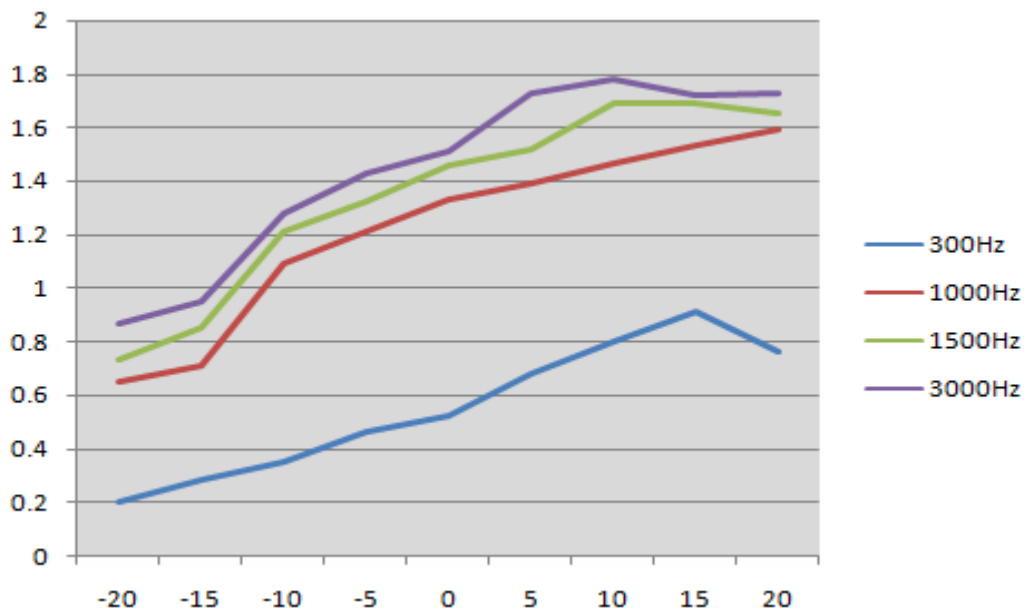

Note: All the modes had been tested, but only the worst data recorded in the report.

(B). AUDIO FREQUENCY RESPONSE:

Middle Channel @ 12.5 KHz Channel Separations

Frequency (Hz)	Deviation (KHz)	Audio Frequency Response(dB)
100	--	--
200	--	--
300	0.14	-15.78
400	0.18	-13.98
500	0.23	-11.21
600	0.27	-10.10
700	0.29	-9.12
800	0.36	-6.94
900	0.41	-5.81
1000	0.5	-3.74
1200	0.55	-3.10
1400	0.65	-1.28
1600	0.75	-0.80
1800	0.86	0.53
2000	0.94	1.21
2400	1.22	3.59
2500	1.44	5.04
2800	1.66	6.29
3000	1.75	6.75
3200	1.71	6.65
3600	1.56	5.63
4000	1.05	2.11
4500	0.84	0.32
5000	0.74	-0.92
5500	0.56	-5.19
6000	0.14	-15.78
6500	0.05	-24.08
7000	0.04	-28.52
7500	0.01	-38.06
9000	--	--
10000	--	--
14000	--	--
18000	--	--
20000	--	--
30000	--	--

Frequency Response of Middle Channel (UHF)

12.5 KHz Channel Separations

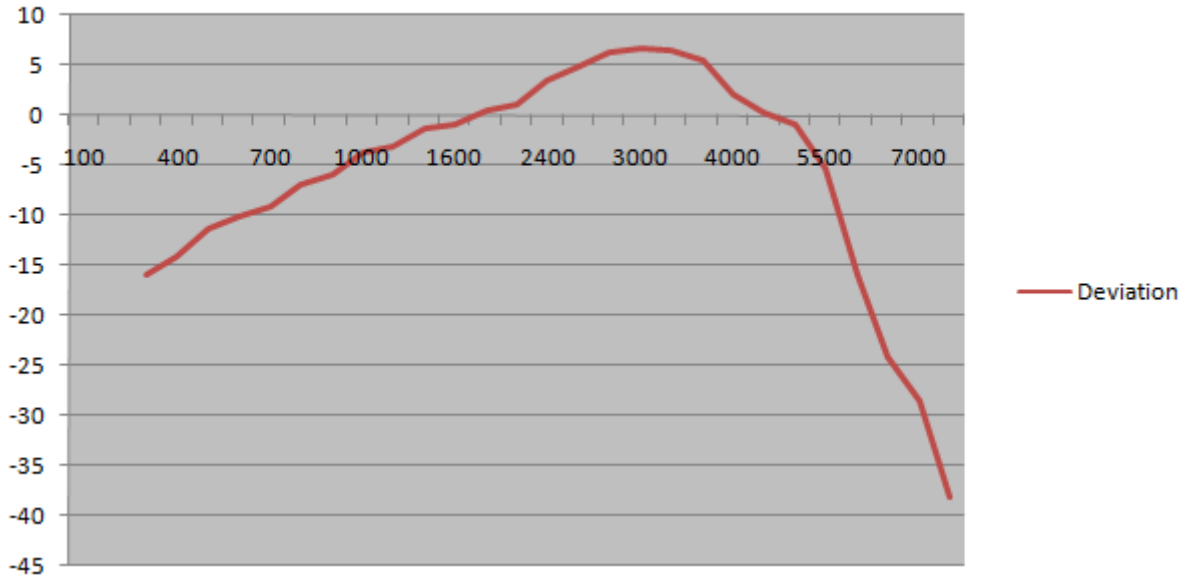

Note: All the modes had been tested, but only the worst data recorded in the report.

Digital:

TEST RESULT TS FOR H POWER LEVEL

(A). MODULATION LIMIT:

High Channel @ 12.5 KHz Channel Separations

Modulation Level (dB)	Peak Freq. Deviation At 300 Hz	Peak Freq. Deviation At 1000 Hz	Peak Freq. Deviation At 1500 Hz	Peak Freq. Deviation At 3000 Hz
-20	0.22	0.73	0.83	0.98
-15	0.36	0.86	0.94	1.02
-10	0.42	1.2	1.25	1.26
-5	0.44	1.33	1.4	1.38
0	0.55	1.45	1.48	1.52
+5	0.75	1.63	1.72	1.72
+10	0.85	1.76	1.81	1.85
+15	0.94	1.64	1.65	1.89
+20	0.9	1.56	1.66	1.91

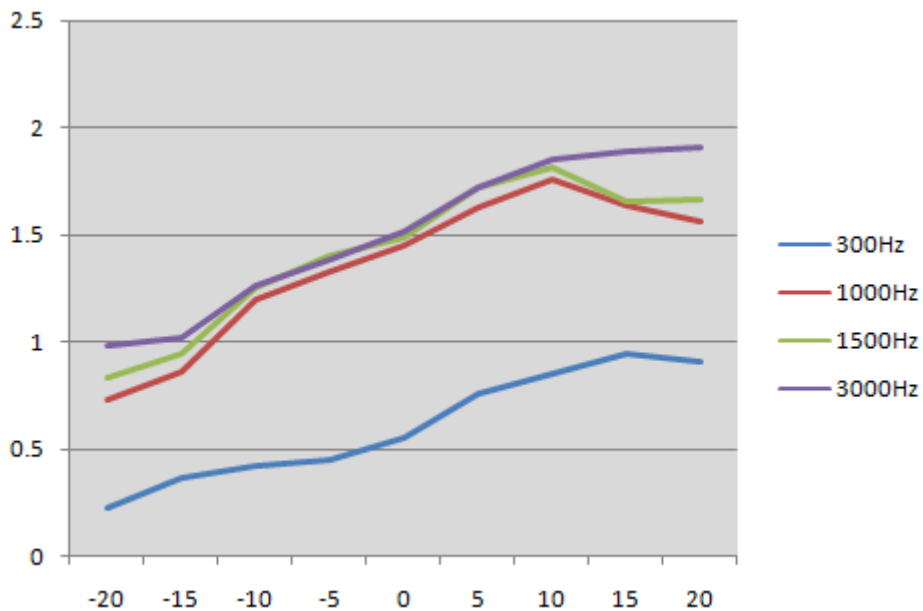

Note: All the modes had been tested, but only the worst data recorded in the report.

(B). AUDIO FREQUENCY RESPONSE:

High Channel @ 12.5 KHz Channel Separations

Frequency (Hz)	Deviation (KHz)	Audio Frequency Response(dB)
100	--	--
200	--	--
300	0.12	-13.98
400	0.15	-9.37
500	0.19	-7.54
600	0.25	-4.73
700	0.36	-3.35
800	0.34	-2.38
900	0.42	-1.11
1000	0.56	0.51
1200	0.62	2.41
1400	0.73	3.05
1600	0.80	4.19
1800	0.92	5.39
2000	1.07	6.53
2400	1.22	7.68
2500	1.42	9.48
2800	1.53	9.71
3000	1.44	9.37
3200	1.16	7.00
3600	0.79	3.64
4000	0.42	-0.54
4500	0.31	-5.35
5000	0.18	-9.90
5500	0.21	-8.40
6000	0.10	-14.89
6500	0.05	-21.94
7000	0.04	-24.44
7500	0.02	-33.98
9000	--	--
10000	--	--
14000	--	--
18000	--	--
20000	--	--
30000	--	--

Frequency Response of Middle Channel

12.5 KHz Channel Separations

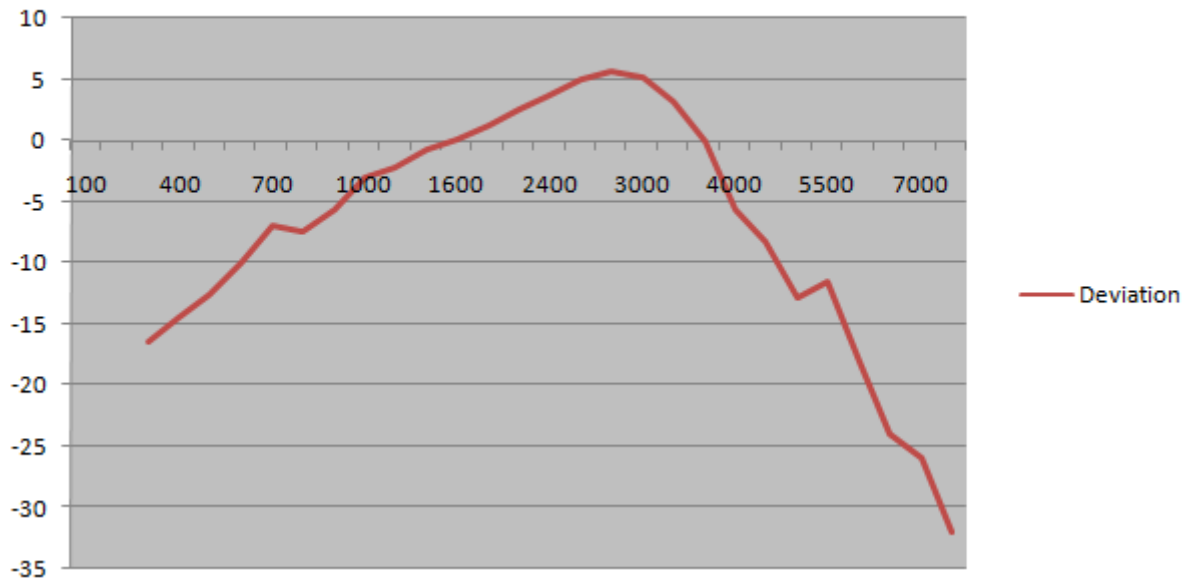

Note: All the modes had been tested, but only the worst data recorded in the report.

10. MAXIMUM TRANSMITTER POWER (CONDUCTED OUTPUT POWER)

10.1 PROVISIONS APPLICABLE

Per FCC §2.1046 and §90.205: Maximum ERP is dependent upon the station's antenna HAAT and required service area.

10.2 TEST PROCEDURE

The RF output of Two-way Radio was conducted to a spectrum analyzer through an appropriate attenuator.

10.3 TEST CONFIGURATION

Conducted Output Power:

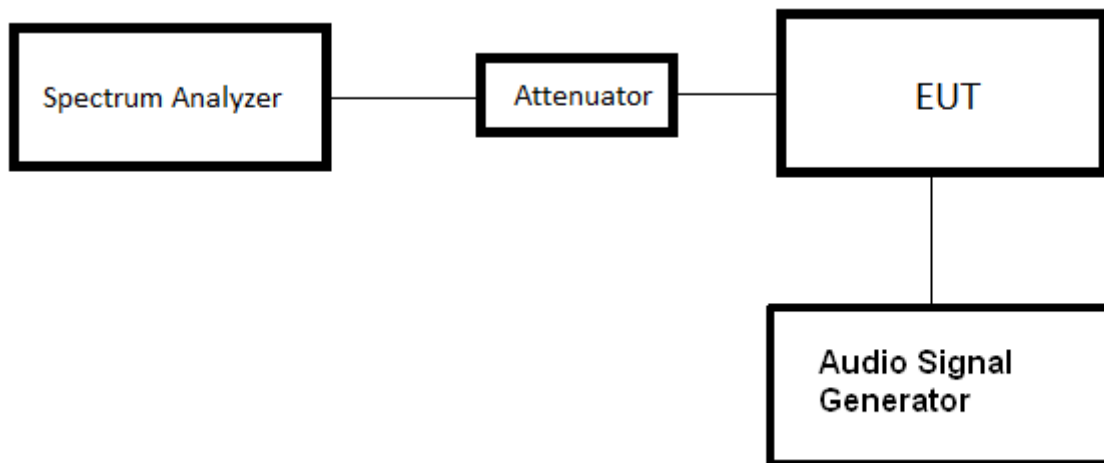

Effective Radiated Power :

Radiated Below 1GHz

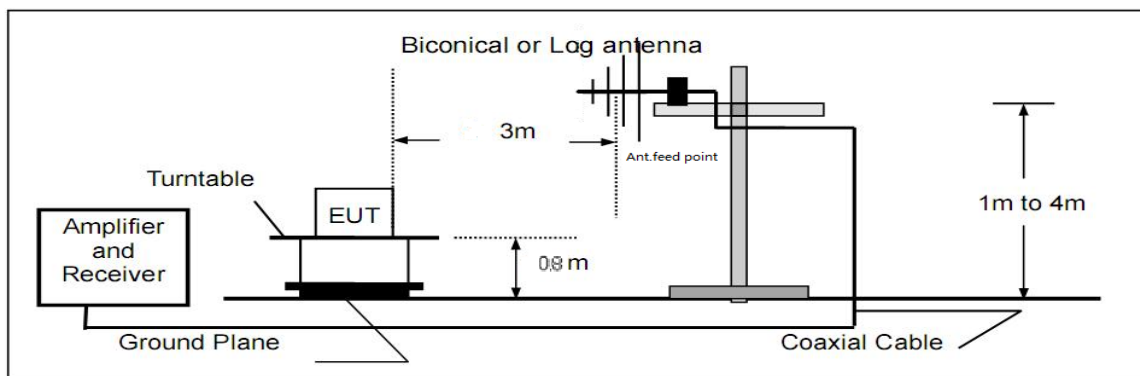

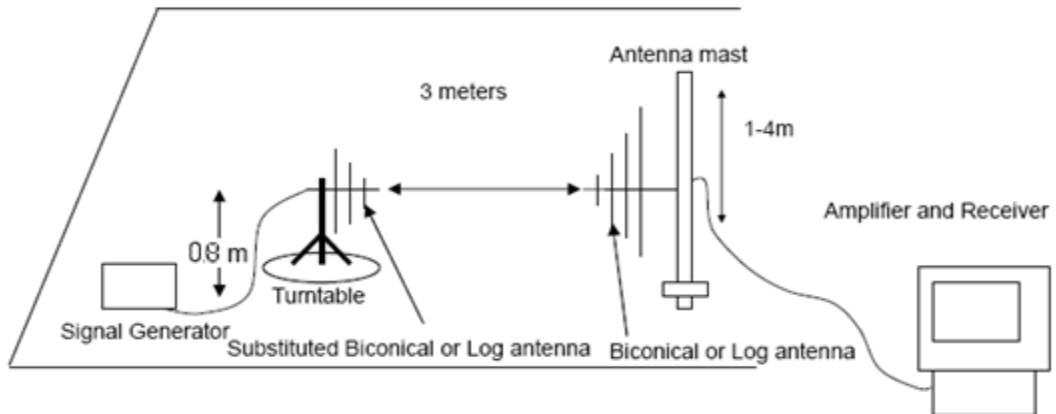

Radiated Above 1 GHz

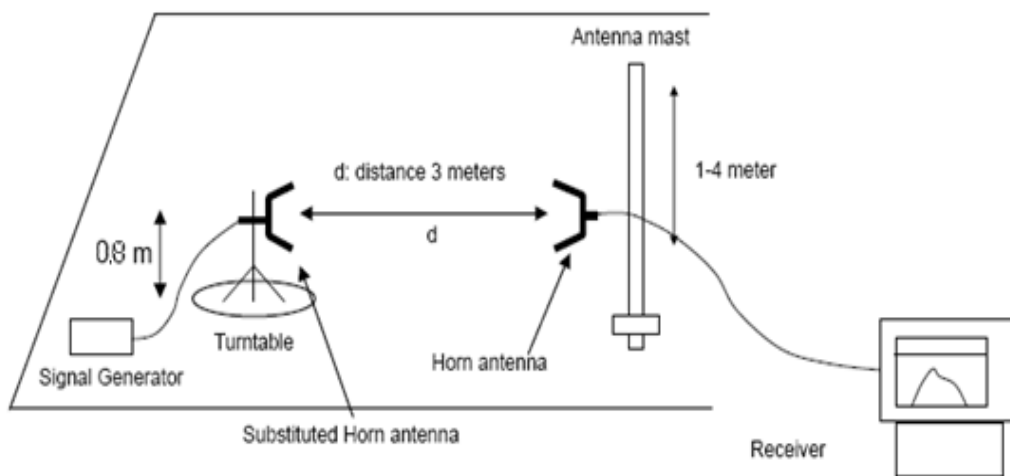
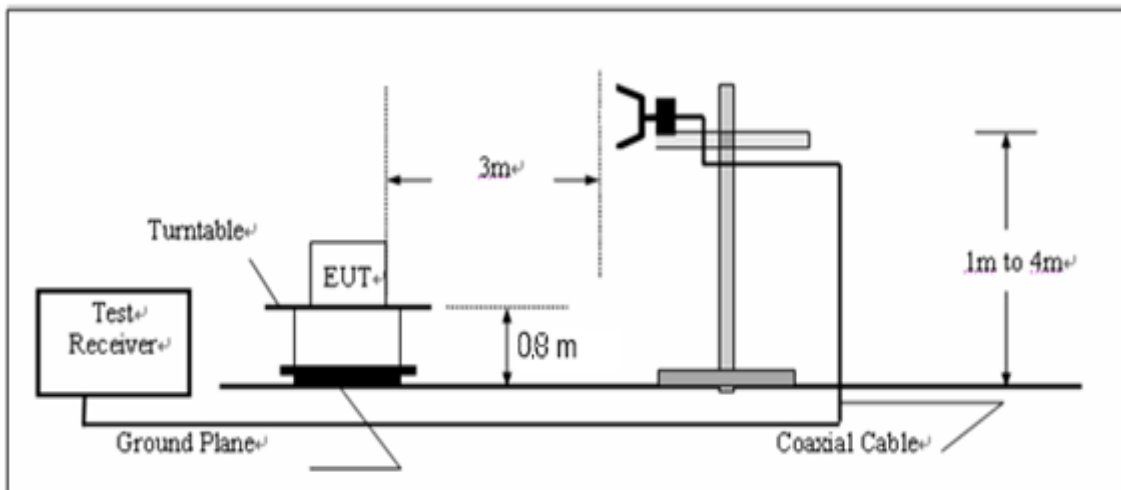

10.4 TEST RESULT

The maximum Conducted Power (CP) is

Analog : 5 W for 12.5 KHz Channel Separation

Digital : 5W for 12.5 KHz Channel Separation

Calculation Formula: $CP = R + A + L$

* Note:

CP: The final Conducted Power

R : The reading value from spectrum analyzer

A : The attenuation value of the used attenuator

L : The loss of all connection cables

Analog:

Conducted Power Measurement Results		
Channel Separation	Channel	Measurement Result (dBm)
		For 36.99dBm(5W)
12.5 KHz	Bottom(400.025MHz)	36.85
	Middle(440.025MHz)	36.81
	Top (479.975MHz)	36.74

Radiated Power Measurement Results		
Channel Separation	Channel	Measurement Result (dBm)
		For 36.99dBm(5W)
12.5 KHz	Bottom(400.025MHz)	36.75
	Middle(440.025MHz)	36.80
	Top (479.975MHz)	36.69

Digital:

Date + voice:

Conducted Power Measurement Results		
Channel Separation	Channel	Measurement Result (dBm)
		For 36.99dBm(5W)
12.5 KHz	Bottom(400.025MHz)	36.78
	Middle(440.025MHz)	36.85
	Top (479.975MHz)	36.80

Radiated Power Measurement Results		
Channel Separation	Channel	Measurement Result (dBm)
		For 36.99dBm(5W)
12.5 KHz	Bottom(400.025MHz)	36.90
	Middle(440.025MHz)	36.75
	Top (479.975MHz)	36.83

Date transmission mode:

Conducted Power Measurement Results		
Channel Separation	Channel	Measurement Result (dBm)
		For 36.99dBm(5W)
12.5 KHz	Bottom(400.025MHz)	36.75
	Middle(440.025MHz)	36.84
	Top (479.975MHz)	36.78

Radiated Power Measurement Results		
Channel Separation	Channel	Measurement Result (dBm)
		For 36.99dBm(5W)
12.5 KHz	Bottom(400.025MHz)	36.83
	Middle(440.025MHz)	36.76
	Top (479.975MHz)	36.68

11. TRANSMITTER FREQUENCY BEHAVIOR

11.1 PROVISIONS APPLICABLE

Section 90.214

Time intervals ^{1, 2}	Maximum frequency difference ³	All equipment	
		150 to 174 MHz	421 to 512 MHz
Transient Frequency Behavior for Equipment Designed to Operate on 25 kHz Channels			
t ₁ ⁴	± 25.0 kHz	5.0 ms	10.0 ms
t ₂	± 12.5 kHz	20.0 ms	25.0 ms
t ₃ ⁴	± 25.0 kHz	5.0 ms	10.0 ms
Transient Frequency Behavior for Equipment Designed to Operate on 12.5 kHz Channels			
t ₁ ⁴	± 12.5 kHz	5.0 ms	10.0 ms
t ₂	± 6.25 kHz	20.0 ms	25.0 ms
t ₃ ⁴	± 12.5 kHz	5.0 ms	10.0 ms
Transient Frequency Behavior for Equipment Designed to Operate on 6.25 kHz Channels			
t ₁ ⁴	± 6.25 kHz	5.0 ms	10.0 ms
t ₂	± 3.125 kHz	20.0 ms	25.0 ms
t ₃ ⁴	± 6.25 kHz	5.0 ms	10.0 ms

¹ t_{on} is the instant when a 1 kHz test signal is completely suppressed, including any capture time due to phasing.

t₁ is the time period immediately following t_{on}.

t₂ is the time period immediately following t₁.

t₃ is the time period from the instant when the transmitter is turned off until t_{off}.

t_{off} is the instant when the 1 kHz test signal starts to rise.

² During the time from the end of t₂ to the beginning of t₃, the frequency difference must not exceed the limits specified in §90.213.

³ Difference between the actual transmitter frequency and the assigned transmitter frequency.

⁴ If the transmitter carrier output power rating is 6 watts or less, the frequency difference during this time period may exceed the maximum frequency difference for this time period.

11.2 TEST METHOD

TIA/EIA-603 2.2.19

11.3 DESCRIBE LIMIT LINE OF TRANSMITTER FREQUENCY BEHAVIOR

ton: The switch-on instant of a transmitter is defined by the condition when the output power, measured at the antenna terminal, exceeds 0,1 % of the full output power (-30 dBc).

t1: period of time starting at ton and finishing according to above 11.1

t2: period of time starting at the end of t1 and finishing according to above 11.1

toff: switch-off instant defined by the condition when the output power falls below 0,1 % of the full output power (-30 dBc).

t3: period of time that finishing at toff and starting according to above 11.1

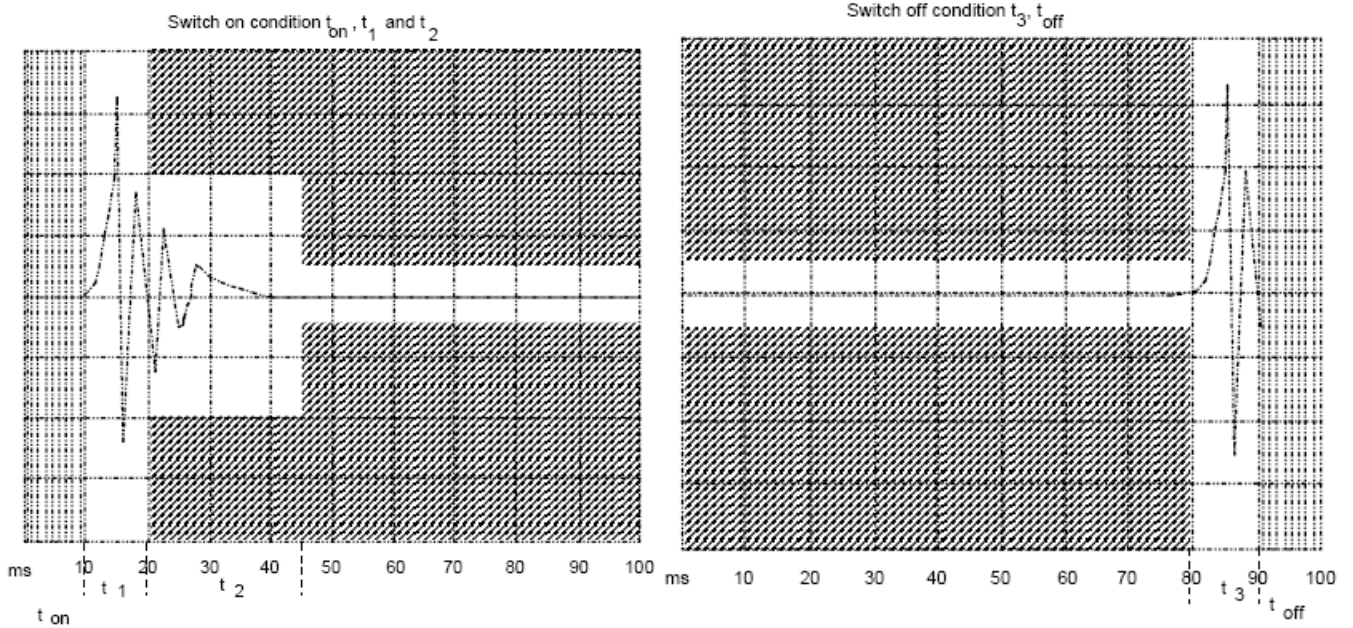

11.4 MEASURE RESULT

Transmitter Frequency Behavior @ 12.5 KHz Channel Separation--Off to On

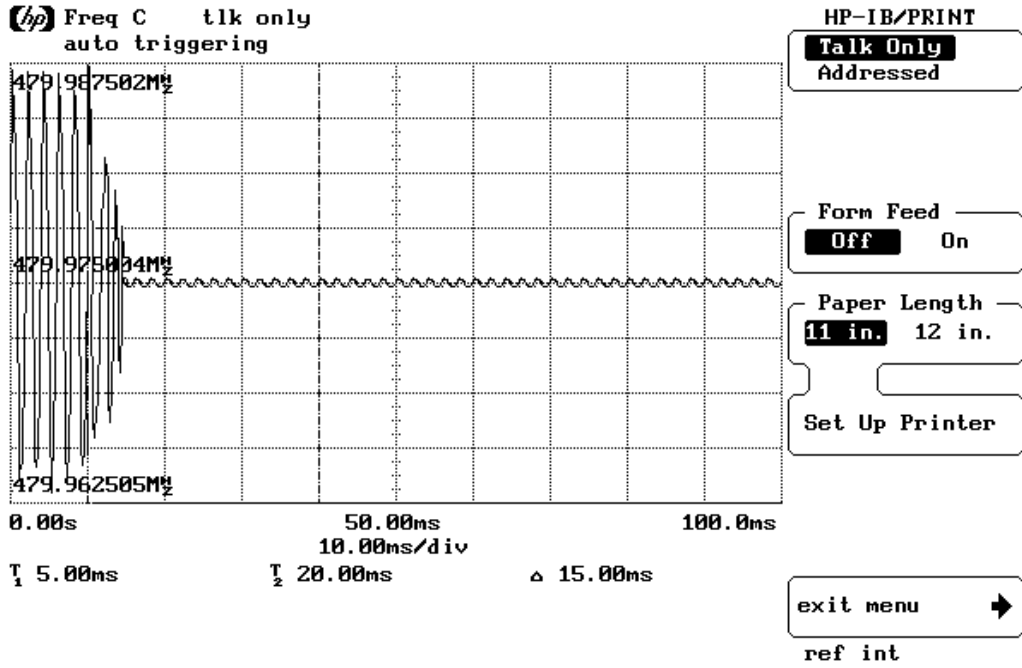

Transmitter Frequency Behavior @ 12.5 KHz Channel Separation--On to Off

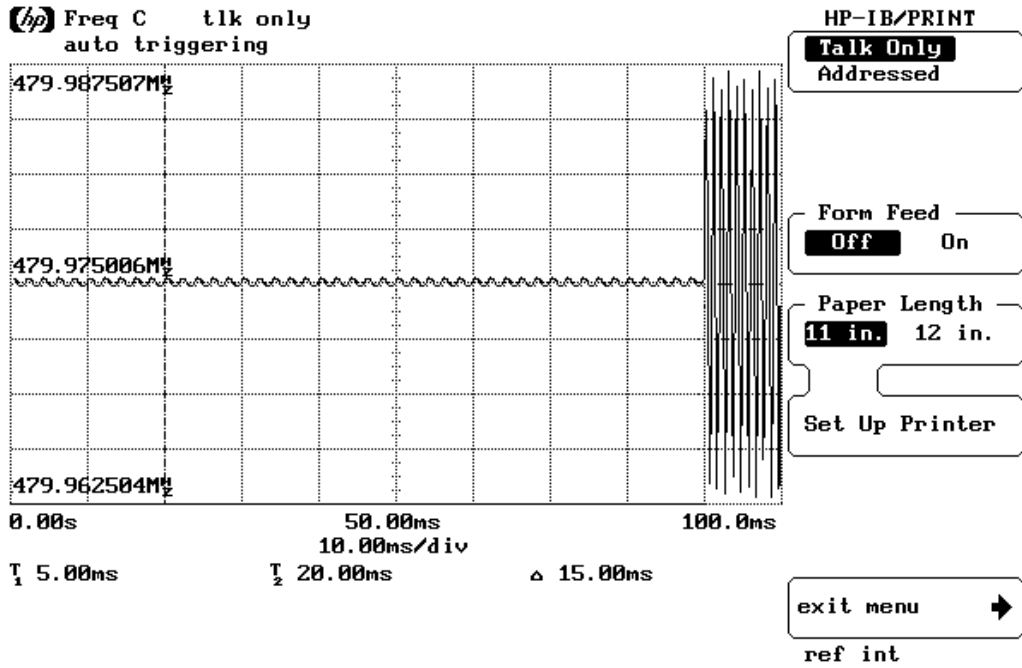

12. AUDIO LOW PASS FILTER RESPONSE

12.1 LIMITS

2.1047(a): Voice modulated communication equipment. A curve or equivalent data showing the frequency response of the audio modulating circuit over a range of 100 to 5000 Hz shall be submitted. For equipment required to have an audio low-pass filter, a curve showing the frequency response of the filter or of all circuitry installed between the modulation limiter and the modulated stage shall be submitted.

90.242(b)(8): Recommended audio filter attenuation characteristics are given below:

Audio band	Minimum Attenuation Rel. to 1 KHz Attenuation
3 –20 KHz	$60 \log_{10}(f/3)$ dB where f is in KHz
20 – 30 KHz	50dB

12.2. METHOD OF MEASUREMENTS

The rated audio input signal was applied to the input of the audio low-pass filter (or of all modulation stages) using an audio oscillator, this input signal level and its corresponding output signal were then measured and recorded using the FFT Digital Spectrum Analyzer. Tests were repeated at different audio signal frequencies from 0 to 50 KHz.

12.3 TEST DATA

Analog:

12.5KHZ CHANNEL SPACING, F3E, FREQUENCY OF ALL MODULATION STATES -5W

Frequency (KHz)	Audio In (dBV)	Audio out (dBV)	Attenuation (Out_In) dB	Attenuation Rel.to 3 KHz (dB)	Recommended Attenuation (dB)
0.1	-76.15	-31.21	46.37	-36.57	
0.2	-76.15	-17.34	58.26	-25.68	
0.4	-76.15	-6.27	71.67	-12.86	
0.6	-76.15	0.41	74.28	-6.48	
0.8	-76.15	4.15	78.96	-2.98	
1.0	-76.15	7.16	83.67	-0.05	
1.5	-76.15	8.25	84.85	2.18	
2.0	-76.15	8.95	85.37	1.5	
2.5	-76.15	7.50	83.88	0.68	
3.0	-76.15	6.25	82.55	-1.73	0
3.5	-76.15	2.61	78.48	-4.56	-4
4.0	-76.15	-2.26	74.68	-9.49	-6
4.5	-76.15	-9.18	68.26	-16.52	-11
5.0	-76.15	-15.14	60.65	-21.76	-14
6.0	-76.15	-21.20	54.17	-28.67	-19
7.0	-76.15	-31.58	46.26	-36.48	-21
8.0	-76.15	-39.19	37.98	-47.69	-25
9.0	-76.15	-61.96	15.14	-66.93	-27
10.0	-76.15	-61.96	15.16	-66.47	-30
12.0	-76.15	-61.96	15.16	-66.45	-38
14.0	-76.15	-61.96	15.16	-66.45	-41
16.0	-76.15	-61.96	15.16	-66.45	-43
18.0	-76.15	-61.96	15.16	-66.45	-46
20.0	-76.15	-61.96	15.16	-66.45	-48
25.0	-76.15	-61.96	15.16	-66.45	-48
30.0	-76.15	-61.96	15.16	-66.45	-48
35.0	-76.15	-61.96	15.16	-66.45	-48
40.0	-76.15	-61.96	15.16	-66.45	-48
45.0	-76.15	-61.96	15.16	-66.45	-48
50.0	-76.15	-61.96	15.16	-66.45	-48

Note: Due to the difficulty of measuring the Frequency Response of the internal low-pass filter, the Frequency Response of All Modulation States is performed to show the roll-off at 3 KHz in comparison with the recommended audio filter attenuation.

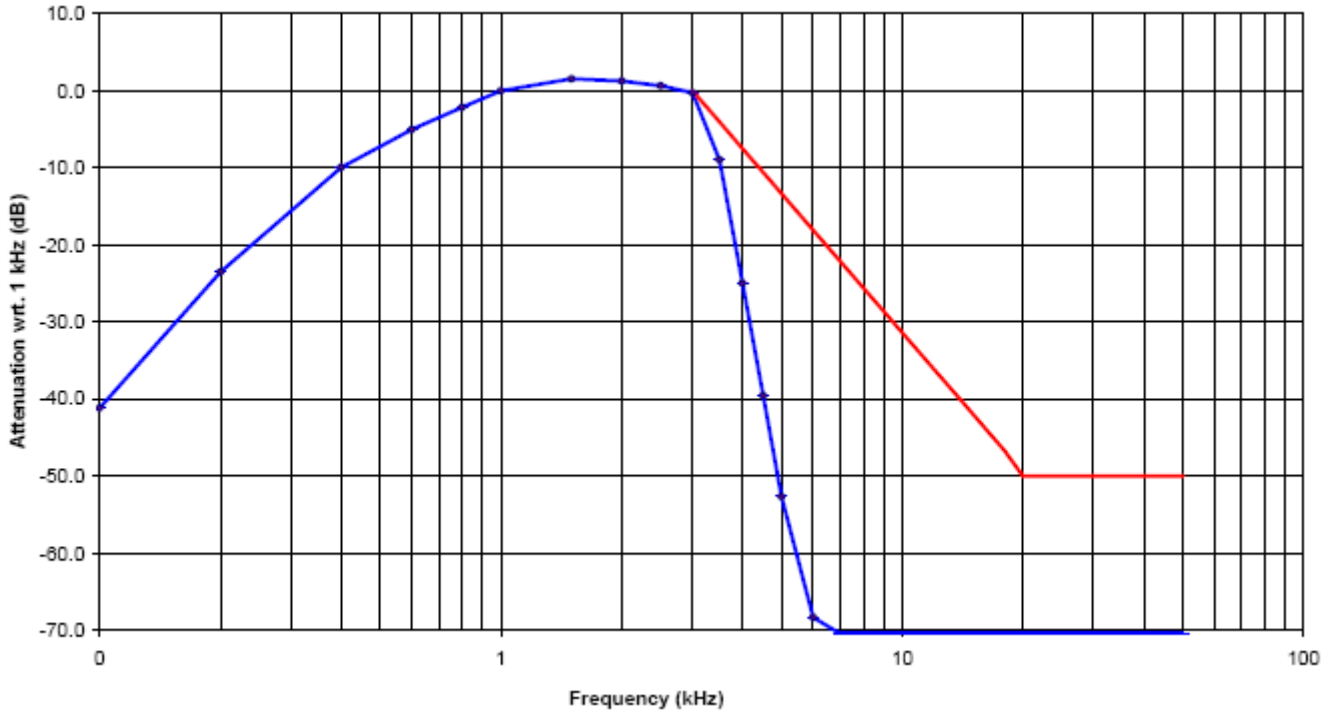

Digital:

12.5KHZ CHANNEL SPACING, FREQUENCY OF ALL MODULATION STATES -5W

Frequency (KHz)	Audio In (dBV)	Audio out (dBV)	Attenuation (Out_In) dB	Attenuation Rel.to 3 KHz (dB)	Recommended Attenuation (dB)
0.1	-76.18	-31.19	46.35	-36.4	
0.2	-76.18	-17.34	58.24	-25.35	
0.4	-76.18	-6.25	71.65	-12.63	
0.6	-76.18	0.45	74.27	-6.21	
0.8	-76.18	4.14	78.98	-2.86	
1.0	-76.18	7.13	83.68	-0.03	
1.5	-76.18	8.26	84.84	2.14	
2.0	-76.18	8.98	85.33	1.58	
2.5	-76.18	7.48	83.87	0.69	
3.0	-76.18	6.19	82.53	-1.83	0
3.5	-76.18	2.58	78.47	-4.91	-5
4.0	-76.18	-2.15	74.64	-9.46	-8
4.5	-76.18	-9.25	68.27	-16.57	-13
5.0	-76.18	-15.19	60.68	-21.71	-16
6.0	-76.18	-21.25	54.15	-28.63	-17
7.0	-76.18	-31.56	46.24	-36.44	-21
8.0	-76.18	-39.27	37.93	-47.67	-24
9.0	-76.18	-61.87	15.19	-66.85	-27
10.0	-76.18	-61.87	15.19	-66.43	-30
12.0	-76.18	-61.87	15.19	-66.43	-35
14.0	-76.18	-61.87	15.19	-66.43	-39
16.0	-76.18	-61.87	15.19	-66.43	-43
18.0	-76.18	-61.87	15.19	-66.43	-45
20.0	-76.18	-61.87	15.19	-66.43	-47
25.0	-76.18	-61.87	15.19	-66.43	-47
30.0	-76.18	-61.87	15.19	-66.43	-47
35.0	-76.18	-61.87	15.19	-66.43	-47
40.0	-76.18	-61.87	15.19	-66.43	-47
45.0	-76.18	-61.87	15.19	-66.43	-47
50.0	-76.18	-61.87	15.19	-66.43	-47

Note: Due to the difficulty of measuring the Frequency Response of the internal low-pass filter, the Frequency Response of All Modulation States is performed to show the roll-off at 3 KHz in comparison with the recommended audio filter attenuation.

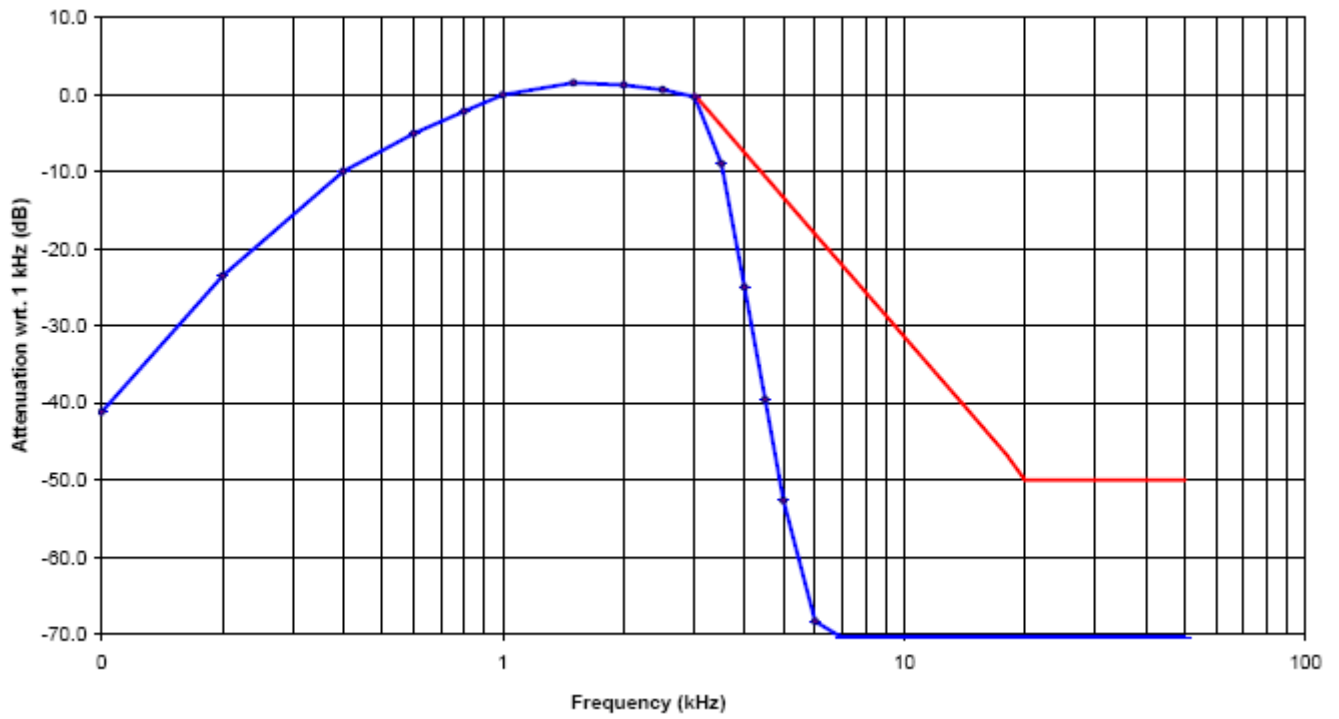

APPENDIX I: PHOTOGRAPHS OF SETUP
RADIATED EMISSION TEST SETUP

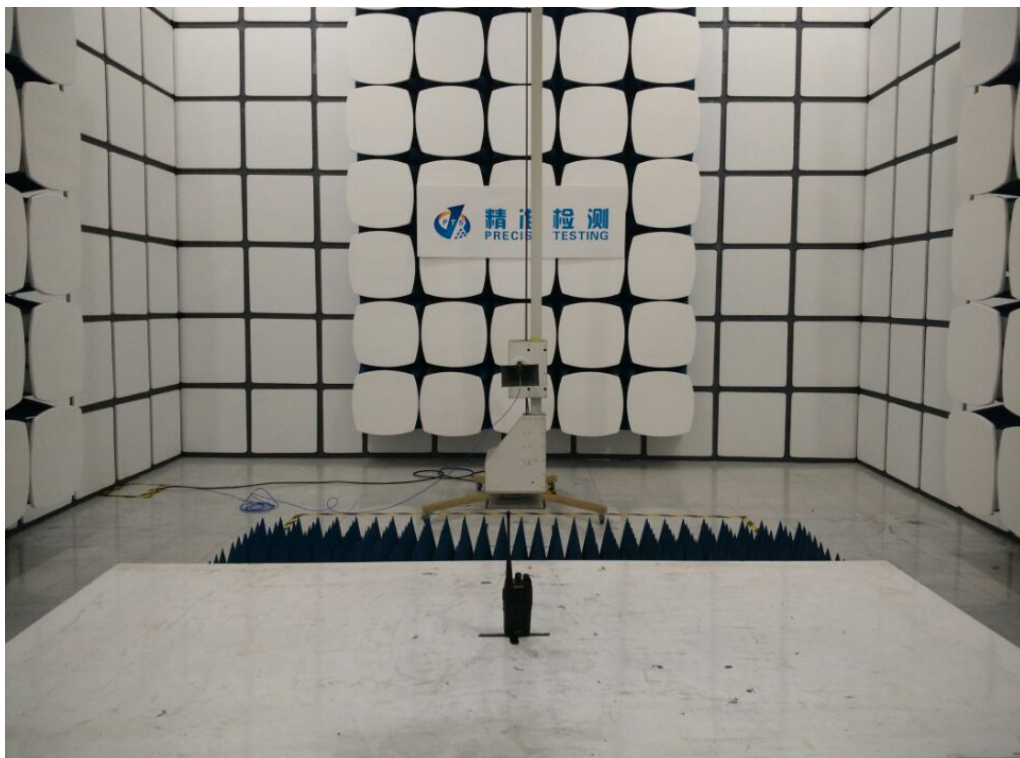
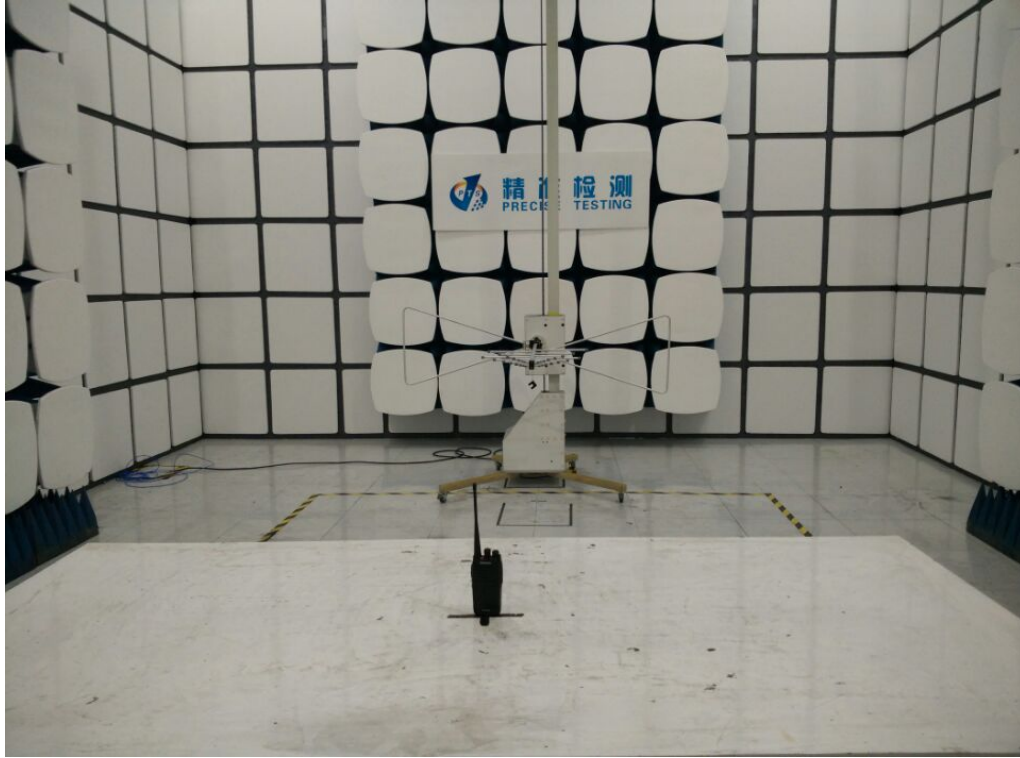

APPENDIX II: EXTERNAL VIEW OF EUT
TOTAL VIEW OF EUT



TOP VIEW OF EUT



BOTTOM VIEW OF EUT



FRONT VIEW OF EUT



BACK VIEW OF EUT



LEFT VIEW OF EUT



RIGHT VIEW OF EUT



THE LABEL OF POWER ADAPTER



OPEN VIEW-1 OF EUT



OPEN VIEW-2 OF EUT



OPEN VIEW-3 OF EUT

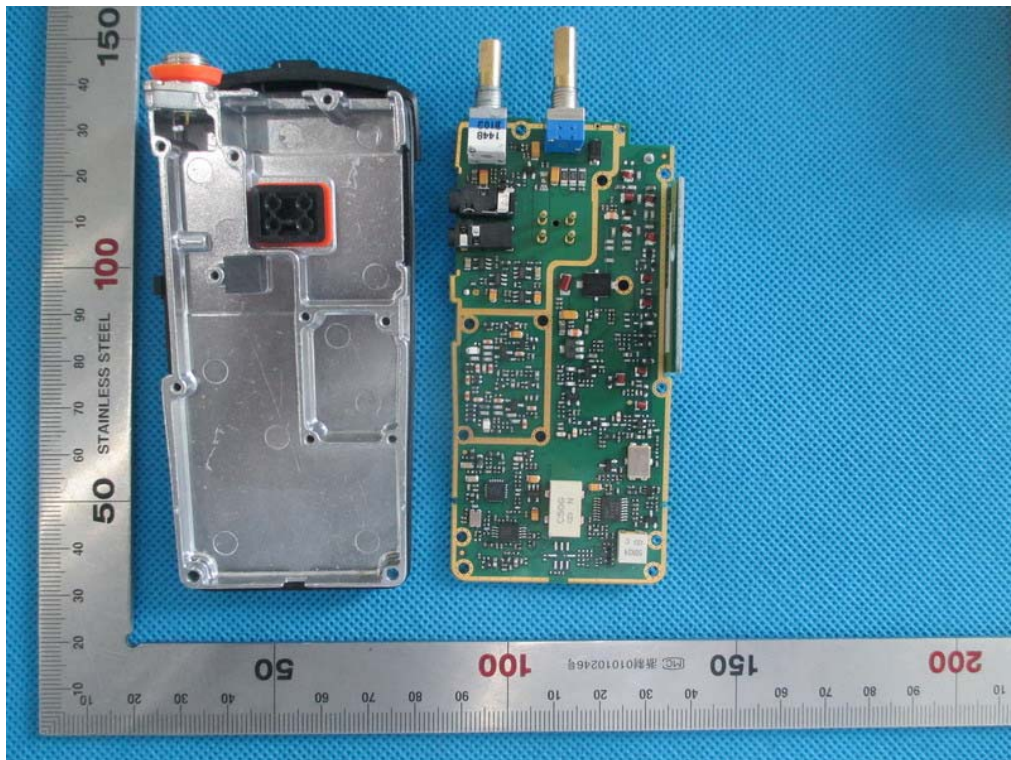

INTERNAL VIEW-1 OF EUT

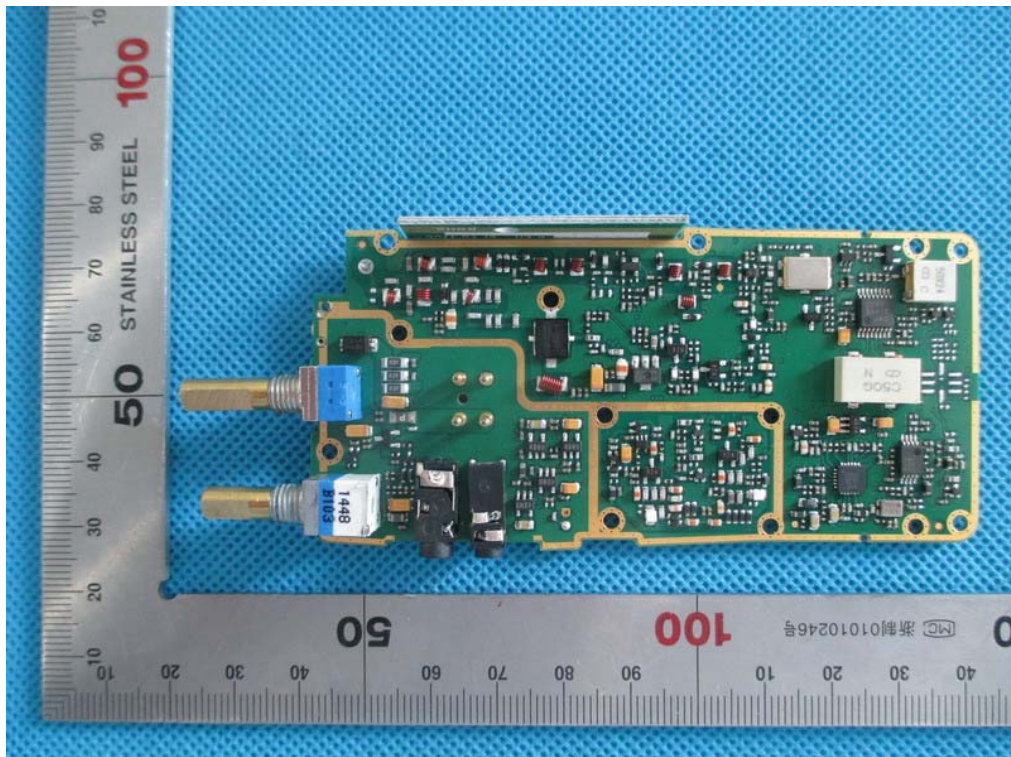

INTERNAL VIEW-2 OF EUT

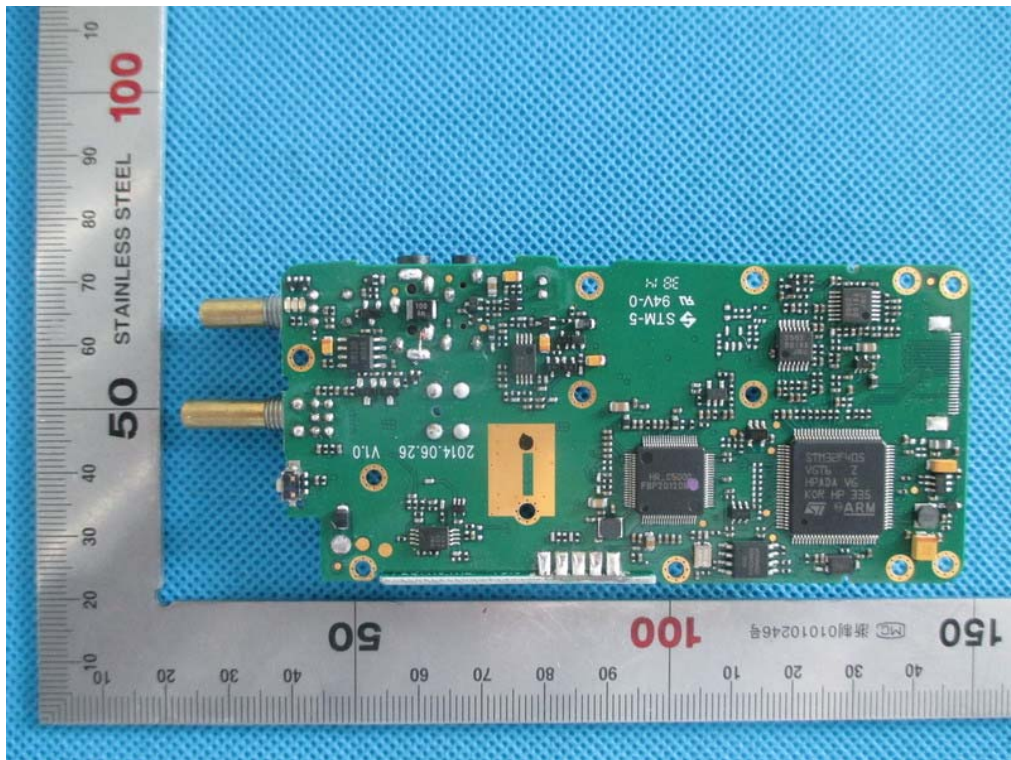

----END OF REPORT----