



**In accordance with the requirements of  
FCC 47 CFR Part 2(2.1093), ANSI/IEEE C95.1-1992 and  
IEEE Std 1528-2013**

## **FCC SAR EVALUATION REPORT**

**Product Name :** Smart phone

**Trademark :** Cosmo Z

**Model Name :** P5047A

**Serial Model :** P5047AD

**Report No. :** NTEK-2017NT04142704HF

**FCC ID :** 2ADWUP5047A

**Prepared for**

ONE DIAMOND ELECTRONICS INC.

1450 Frazee Road, Suite 303, San Diego, California, United States

**Prepared by**

Shenzhen NTEK Testing Technology Co., Ltd.

1/F, Building E, Fenda Science Park, Sanwei Community, Xixiang Street, Bao'an District,  
Shenzhen 518126 P.R.China.

Tel.: +86-755-6115 9388 Fax.: +86-755-6115 6599

Website: <http://www.ntek.org.cn>

## TEST RESULT CERTIFICATION

**Applicant's name** .....: ONE DIAMOND ELECTRONICS INC.

Address.....: 1450 Frazee Road, Suite 303, San Diego, California, United States

**Manufacturer's Name** .....: Shenzhen X&F Technology Co., Ltd.

Address.....: Shenzhen, Nanshan District science and Technology Park Wandelai  
North Block Building 5&6 floor

### Product description

Product name.....: Smart phone

Trademark .....: Cosmo Z

Model and/or type reference .: P5047A

Serial Model.....: P5047AD

FCC 47 CFR Part 2(2.1093)

ANSI/IEEE C95.1-1992

**Standards** .....: IEEE Std 1528-2013

Published RF exposure KDB procedures

This device described above has been tested by Shenzhen NTEK. In accordance with the measurement methods and procedures specified in IEEE Std 1528-2013 and KDB 865664 D01. Testing has shown that this device is capable of compliance with localized specific absorption rate (SAR) specified in FCC 47 CFR Part 2(2.1093) and ANSI/IEEE C95.1-1992. The test results in this report apply only to the tested sample of the stated device/equipment. Other similar device/equipment will not necessarily produce the same results due to production tolerance and measurement uncertainties.

This report shall not be reproduced except in full, without the written approval of Shenzhen NTEK, this document may be altered or revised by Shenzhen NTEK, personal only, and shall be noted in the revision of the document.

### Date of Test

Date (s) of performance of tests .....: Apr. 20, 2017 ~ May. 08, 2017

Date of Issue .....: May. 19, 2017

Test Result .....: **Pass**

Prepared By  
(Test Engineer)

:   
\_\_\_\_\_  
(Cheng Jiawen)

Approved By  
(Lab Manager)

:   
\_\_\_\_\_  
(Sam Chen)

※ ※ **Revision History** ※ ※

REV.	DESCRIPTION	ISSUED DATE	REMARK
Rev.1.0	Initial Test Report Release	May. 19, 2017	Cheng Jiawen

## TABLE OF CONTENTS

1. General Information .....	6
1.1. RF exposure limits .....	6
1.2. Statement of Compliance.....	7
1.3. EUT Description .....	8
1.4. Test specification(s) .....	10
1.5. Ambient Condition .....	10
2. SAR Measurement System .....	11
2.1. SATIMO SAR Measurement Set-up Diagram .....	11
2.2. Robot .....	12
2.3. E-Field Probe.....	13
2.3.1. E-Field Probe Calibration.....	14
2.4. SAM phantoms .....	14
2.4.1. Technical Data .....	14
2.5. Device Holder .....	16
2.6. Test Equipment List .....	17
3. SAR Measurement Procedures .....	19
3.1. Power Reference.....	19
3.2. Area scan & Zoom scan .....	19
3.3. Description of interpolation/extrapolation scheme .....	21
3.4. Volumetric Scan .....	21
3.5. Power Drift .....	21
4. System Verification Procedure.....	22
4.1. Tissue Verification.....	22
4.1.1. Tissue Dielectric Parameter Check Results .....	23
4.2. System Verification Procedure .....	24
4.2.1. System Verification Results .....	25
5. SAR Measurement variability and uncertainty .....	26
5.1. SAR measurement variability .....	26
5.2. SAR measurement uncertainty.....	26
6. RF Exposure Positions .....	27
6.1. Ear and handset reference point.....	27
6.2. Definition of the cheek position .....	27
6.3. Definition of the tilt position.....	29
6.4. Body Worn Accessory .....	29
6.5. Wireless Router Devices.....	30
7. RF Output Power .....	31
7.1. Maximum Tune-up Limit .....	31
7.2. GSM Conducted Power .....	36
7.3. WCDMA Conducted Power.....	37

7.4. LTE Conducted Power.....	39
7.5. Wi-Fi & BT Output Power .....	49
7.5.1. Output Power Results Of Wi-Fi .....	49
7.5.2. Output Power Results Of BT .....	49
8. Antenna Location.....	50
9. Stand-alone SAR test exclusion .....	51
10. SAR Measurement Results.....	52
10.1. SAR measurement results .....	52
10.1.1. SAR measurement Result of GSM850.....	53
10.1.2. SAR measurement Result of GSM1900.....	54
10.1.3. SAR measurement Result of WCDMA Band V.....	55
10.1.4. SAR measurement Result of WCDMA Band II.....	56
10.1.5. SAR measurement Result of LTE Band V .....	57
10.1.6. SAR measurement Result of LTE Band IV .....	58
10.1.7. SAR measurement Result of LTE Band II .....	60
10.1.8. SAR measurement Result of LTE Band VII .....	62
10.1.9. SAR measurement Result of Wi-Fi 2.4G .....	64
10.2. Simultaneous Transmission Possibilities.....	66
10.3. SAR Summation Scenario .....	67
11. Appendix A. Photo documentation.....	74
12. Appendix B. System Check Plots .....	81
13. Appendix C. Plots of High SAR Measurement .....	92
14. Appendix D. Calibration Certificate.....	113

# 1. General Information

## 1.1. RF exposure limits

(A).Limits for Occupational/Controlled Exposure (W/kg)

Whole-Body	Partial-Body	Hands, Wrists, Feet and Ankles
0.4	8.0	20.0

(B).Limits for General Population/Uncontrolled Exposure (W/kg)

Whole-Body	Partial-Body	Hands, Wrists, Feet and Ankles
0.08	1.6	4.0

NOTE: **Whole-Body SAR** is averaged over the entire body, **partial-body SAR** is averaged over any 1 gram of tissue defined as a tissue volume in the shape of a cube. **SAR for hands, wrists, feet and ankles** is averaged over any 10 grams of tissue defined as a tissue volume in the shape of a cube.

### Occupational/Controlled Environments:

Are defined as locations where there is exposure that may be incurred by people who are aware of the potential for exposure, (i.e. as a result of employment or occupation).

### General Population/Uncontrolled Environments:

Are defined as locations where there is the exposure of individuals who have no knowledge or control of their exposure.

NOTE  
 HEAD AND TRUNK LIMIT  
 1.6 W/kg  
 APPLIED TO THIS EUT

### 1.2. Statement of Compliance

The maximum results of Specific Absorption Rate (SAR) found during testing for P5047A are as follows.

Band	Max Reported SAR Value(W/kg)			Max. SAR Summation
	1-g Head	1-g Body-Worn (Separation distance of 10mm)	1-g Hotspot (Separation distance of 10mm)	
GSM 850	0.140	0.228	0.228	1.590
GSM 1900	0.145	0.620	0.641	
WCDMA Band V	0.117	0.169	0.169	
WCDMA Band II	0.207	0.987	0.987	
LTE Band V	0.108	0.173	0.173	
LTE Band IV	0.253	0.577	0.577	
LTE Band II	0.203	0.918	0.918	
LTE Band VII	0.364	0.283	0.427	
Wi-Fi 2.4G	1.337	0.383	0.383	

NOTE: The Max. SAR Summation is calculated based on the same configuration and test position. This device is in compliance with Specific Absorption Rate (SAR) for general population/uncontrolled exposure limits (1.6 W/kg) specified in FCC 47 CFR Part 2(2.1093) and ANSI/IEEE C95.1-1992, and had been tested in accordance with the measurement methods and procedures specified in IEEE Std 1528-2013 & KDB 865664 D01.

### 1.3. EUT Description

Device Information			
Product Name	Smart phone		
Trade Name	Cosmo Z		
Model Name	P5047A		
Serial Model	P5047AD		
FCC ID	2ADWUP5047A		
Device Phase	Identical Prototype		
Exposure Category	General population / Uncontrolled environment		
Antenna	FPCB Antenna		
Battery Information	3.8V, 2400mAh		
Device Operating Configurations			
Supporting Mode(s)	GSM 850/1900, WCDMA Band V/II, LTE Band V/IV/III/VII, Wi-Fi 2.4G, BT		
Test Modulation	GSM(GMSK/8PSK), WCDMA(QPSK), LTE(QPSK/16QAM), Wi-Fi(DSSS/OFDM)		
Device Class	B		
Operating Frequency Range(s)	Band	Tx (MHz)	Rx (MHz)
	GSM 850	824-849	869-894
	GSM 1900	1850-1910	1930-1990
	WCDMA Band V	824-849	869-894
	WCDMA Band II	1850-1910	1930-1990
	LTE Band V	824-849	869-894
	LTE Band IV	1710-1755	2110-2155
	LTE Band II	1850-1910	1930-1990
	LTE Band VII	2500-2570	2620-2690
	Wi-Fi 2.4G	2412-2462	
	BT	2402-2480	
	GPRS Multislot Class(12)	Max Number of Timeslots in Uplink	
Max Number of Timeslots in Downlink		4	
Max Total Timeslot		5	
EDGE Multislot Class(12)	Max Number of Timeslots in Uplink		4
	Max Number of Timeslots in Downlink		4
	Max Total Timeslot		5
HSDPA UE Category	14		
HSUPA UE Category	6		
Power Class	4, tested with power level 5(GSM 850)		
	1, tested with power level 0(GSM 1900)		
	3, tested with power control "all 1"(WCDMA Band V)		



	3, tested with power control "all 1"(WCDMA Band II)
	3, tested with power control all Max.(LTE Band V)
	3, tested with power control all Max.(LTE Band IV)
	3, tested with power control all Max.(LTE Band II)
	3, tested with power control all Max.(LTE Band VII)
Test Channels (low-mid-high)	128-189-251(GSM 850)
	512-661-810(GSM 1900)
	4132-4182-4233(WCDMA Band V)
	9262-9400-9538(WCDMA Band II)
	20407-20525-20643(LTE Band V BW=1.4MHz)
	20415-20525-20635(LTE Band V BW=3MHz)
	20425-20525-20625(LTE Band V BW=5MHz)
	20450-20525-20600(LTE Band V BW=10MHz)
	19957-20175-20393(LTE Band IV BW=1.4MHz)
	19965-20175-20385(LTE Band IV BW=3MHz)
	19975-20175-20375(LTE Band IV BW=5MHz)
	20000-20175-20350(LTE Band IV BW=10MHz)
	20025-20175-20325(LTE Band IV BW=15MHz)
	20050-20175-20300(LTE Band IV BW=20MHz)
	18607-18900-19193(LTE Band II BW=1.4MHz)
	18615-18900-19185(LTE Band II BW=3MHz)
	18625-18900-19175(LTE Band II BW=5MHz)
	18650-18900-19150(LTE Band II BW=10MHz)
	18675-18900-19125(LTE Band II BW=15MHz)
	18700-18900-19100(LTE Band II BW=20MHz)
	20775-21100-21425(LTE Band VII BW=5MHz)
	20800-21100-21400(LTE Band VII BW=10MHz)
	20825-21100-21375(LTE Band VII BW=15MHz)
20850-21100-21350(LTE Band VII BW=20MHz)	
802.11 b/g/n:1-6-11(Wi-Fi 2.4G)	

**1.4. Test specification(s)**

FCC 47 CFR Part 2(2.1093)
ANSI/IEEE C95.1-1992
IEEE Std 1528-2013
KDB 865664 D01 SAR measurement 100 MHz to 6 GHz
KDB 865664 D02 RF Exposure Reporting
KDB 447498 D01 General RF Exposure Guidance
KDB 248227 D01 802.11 Wi-Fi SAR
KDB 941225 D01 3G SAR Procedures
KDB 941225 D05 SAR for LTE Devices
KDB 941225 D06 Hotspot SAR
KDB 648474 D04 Handset SAR

**1.5. Ambient Condition**

Ambient temperature	20°C – 24°C
Relative Humidity	30% – 70%

## 2. SAR Measurement System

### 2.1. SATIMO SAR Measurement Set-up Diagram

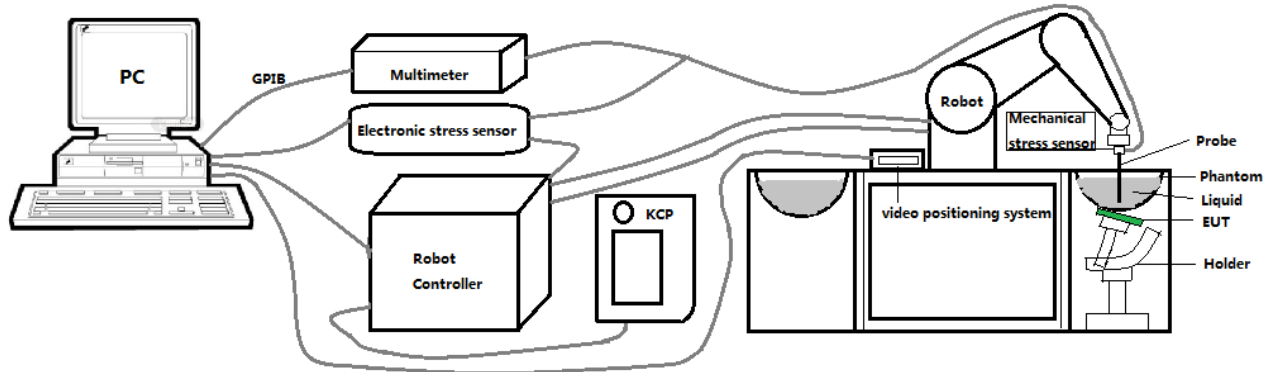

These measurements were performed with the automated near-field scanning system OPENSAR from SATIMO. The system is based on a high precision robot (working range: 901 mm), which positions the probes with a positional repeatability of better than  $\pm 0.03$  mm. The SAR measurements were conducted with dosimetric probe (manufactured by SATIMO), designed in the classical triangular configuration and optimized for dosimetric evaluation.

The first step of the field measurement is the evaluation of the voltages induced on the probe by the device under test. Probe diode detectors are nonlinear. Below the diode compression point, the output voltage is proportional to the square of the applied E-field; above the diode compression point, it is linear to the applied E-field. The compression point depends on the diode, and a calibration procedure is necessary for each sensor of the probe.

The Keithley multimeter reads the voltage of each sensor and send these three values to the PC. The corresponding E field value is calculated using the probe calibration factors, which are stored in the working directory. This evaluation includes linearization of the diode characteristics. The field calculation is done separately for each sensor. Each component of the E field is displayed on the "Dipole Area Scan Interface" and the total E field is displayed on the "3D Interface"

## 2.2. Robot

The SATIMO SAR system uses the high precision robots from KUKA. For the 6-axis controller system, the robot controller version (KUKA) from KUKA is used. The KUKA robot series have many features that are important for our application:



- High precision (repeatability  $\pm 0.03$  mm)
- High reliability (industrial design)
- Jerk-free straight movements
- Low ELF interference (the closed metallic construction shields against motor control fields)

### 2.3. E-Field Probe

This E-field detection probe is composed of three orthogonal dipoles linked to special Schottky diodes with low detection thresholds. The probe allows the measurement of electric fields in liquids such as the one defined in the IEEE and CENELEC standards.

For the measurements the Specific Dosimetric E-Field Probe SN 08/16 EPGO287 with following specifications is used



- Dynamic range: 0.01-100 W/kg
  - Tip Diameter : 2.5 mm
  - Distance between probe tip and sensor center: 1 mm
  - Distance between sensor center and the inner phantom surface: 4 mm (repeatability better than  $\pm 1$  mm).
  - Probe linearity:  $\pm 0.08$  dB
  - Axial isotropy:  $< 0.25$  dB
  - Hemispherical Isotropy:  $< 0.50$  dB
  - Calibration range: 450MHz to 6000MHz for head & body simulating liquid.
  - Lower detection limit: 8mW/kg
- Angle between probe axis (evaluation axis) and surface normal line: less than  $30^\circ$ .

For the measurements the Specific Dosimetric E-Field Probe SN 07/15 EP 247 with following specifications is used



- Dynamic range: 0.01-100 W/kg
  - Tip Diameter : 5 mm
  - Distance between probe tip and sensor center: 2.7 mm
  - Distance between sensor center and the inner phantom surface: 4 mm (repeatability better than  $\pm 1$  mm).
  - Probe linearity:  $\pm 0.05$  dB
  - Axial isotropy:  $< 0.25$  dB
  - Hemispherical Isotropy:  $< 0.50$  dB
  - Calibration range: 450MHz to 2600MHz for head & body simulating liquid.
  - Lower detection limit: 8mW/kg
- Angle between probe axis (evaluation axis) and surface normal line: less than  $30^\circ$ .

**2.3.1. E-Field Probe Calibration**

Each probe needs to be calibrated according to a dosimetric assessment procedure with accuracy better than  $\pm 10\%$ . The spherical isotropy shall be evaluated and within  $\pm 0.25\text{dB}$ . The sensitivity parameters (Norm X, Norm Y, and Norm Z), the diode compression parameter (DCP) and the conversion factor (Conv F) of the probe are tested. The calibration data can be referred to appendix D of this report.

**2.4. SAM phantoms**

Photo of SAM phantom SN 16/15 SAM119



The SAM phantom is used to measure the SAR relative to people exposed to electro-magnetic field radiated by mobile phones.

**2.4.1. Technical Data**

Serial Number	Shell thickness	Filling volume	Dimensions	Positionner Material	Permittivity	Loss Tangent
SN 16/15 SAM119	2 mm $\pm 0.2$ mm	27 liters	Length:1000 mm Width:500 mm Height:200 mm	Gelcoat with fiberglass	3.4	0.02

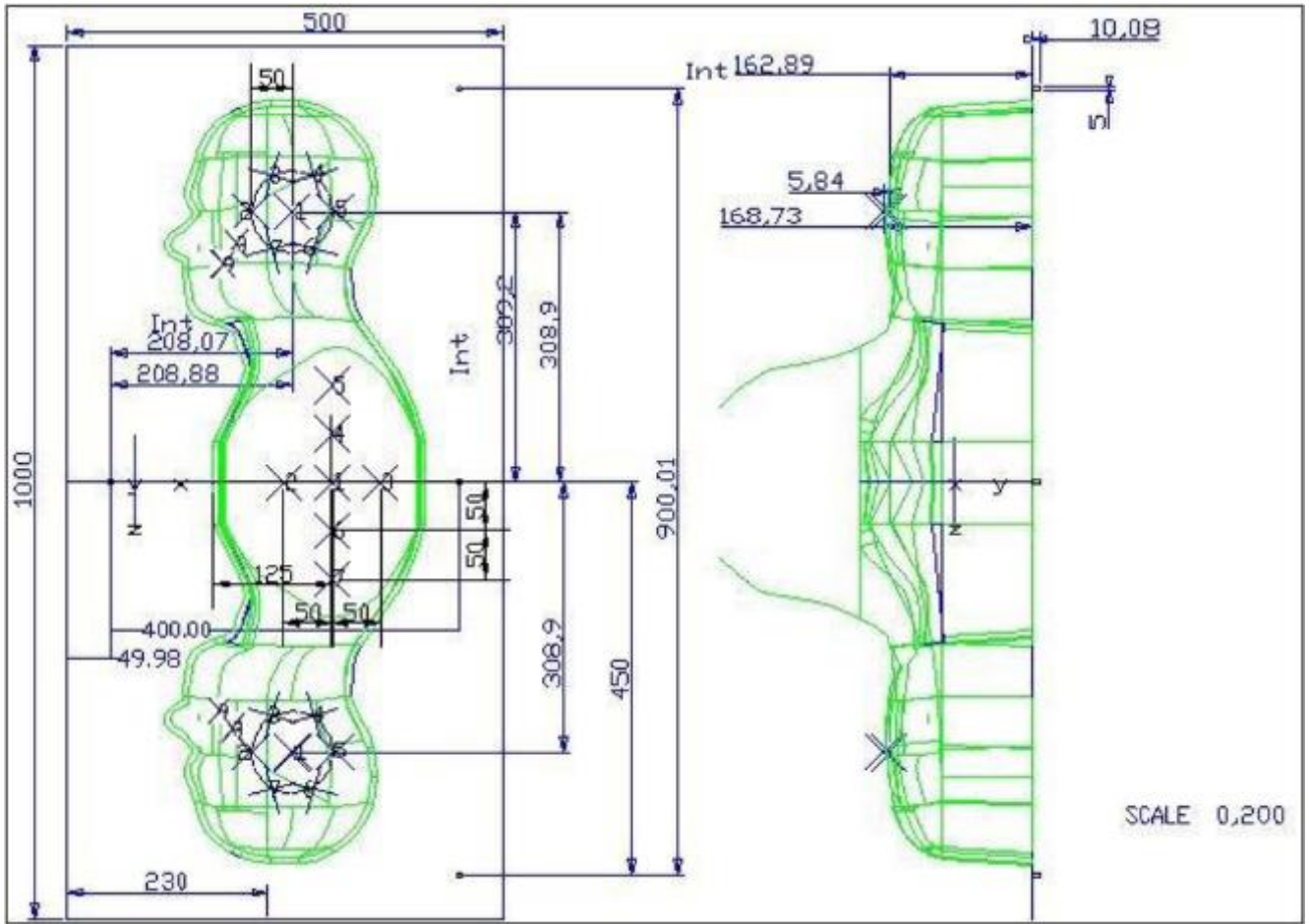

Serial Number	Left Head		Right Head		Flat Part	
<b>SN 16/15 SAM119</b>	2	2.02	2	2.08	1	2.09
	3	2.05	3	2.06	2	2.06
	4	2.07	4	2.07	3	2.08
	5	2.08	5	2.08	4	2.10
	6	2.05	6	2.07	5	2.10
	7	2.05	7	2.05	6	2.07
	8	2.07	8	2.06	7	2.07
	9	2.08	9	2.06	-	-

The test, based on ultrasonic system, allows measuring the thickness with an accuracy of 10 µm.

### 2.5. Device Holder

The positioning system allows obtaining cheek and tilting position with a very good accuracy. In compliance with CENELEC, the tilt angle uncertainty is lower than 1 degree.

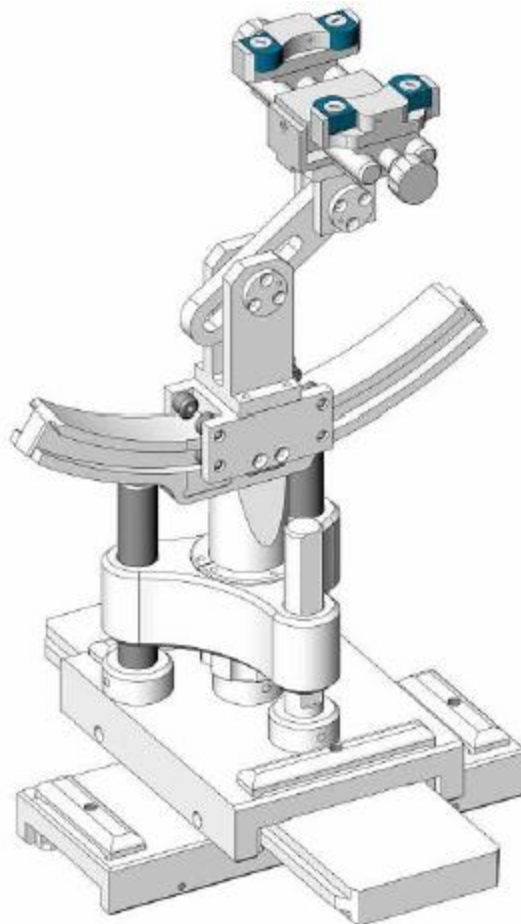

Serial Number	Holder Material	Permittivity	Loss Tangent
SN 16/15 MSH100	Delrin	3.7	0.005



## 2.6. Test Equipment List

This table gives a complete overview of the SAR measurement equipment.

Devices used during the test described are marked

	Manufacturer	Name of Equipment	Type/Model	Serial Number	Calibration	
					Last Cal.	Due Date
<input checked="" type="checkbox"/>	MVG	E FIELD PROBE	SSE2	SN 08/16 EPGO287	Sep. 08, 2016	Sep. 07, 2017
<input checked="" type="checkbox"/>	MVG	E FIELD PROBE	SSE5	SN 07/15 EP247	Apr. 06, 2017	Apr. 05, 2018
<input type="checkbox"/>	MVG	450 MHz Dipole	SID450	SN 03/15 DIP 0G450-345	Apr. 06, 2015	Apr. 05, 2018
<input type="checkbox"/>	MVG	750 MHz Dipole	SID750	SN 03/15 DIP 0G750-355	Apr. 06, 2015	Apr. 05, 2018
<input checked="" type="checkbox"/>	MVG	835 MHz Dipole	SID835	SN 03/15 DIP 0G835-347	Apr. 06, 2015	Apr. 05, 2018
<input type="checkbox"/>	MVG	900 MHz Dipole	SID900	SN 03/15 DIP 0G900-348	Apr. 06, 2015	Apr. 05, 2018
<input checked="" type="checkbox"/>	MVG	1750 MHz Dipole	SID1750	SN 03/16 DIP 1G750-357	Dec. 09, 2016	Dec. 08, 2019
<input checked="" type="checkbox"/>	MVG	1900 MHz Dipole	SID1900	SN 03/15 DIP 1G900-350	Apr. 06, 2015	Apr. 05, 2018
<input type="checkbox"/>	MVG	2000 MHz Dipole	SID2000	SN 03/15 DIP 2G000-351	Apr. 06, 2015	Apr. 05, 2018
<input checked="" type="checkbox"/>	MVG	2450 MHz Dipole	SID2450	SN 03/15 DIP 2G450-352	Apr. 06, 2015	Apr. 05, 2018
<input checked="" type="checkbox"/>	MVG	2600 MHz Dipole	SID2600	SN 03/15 DIP 2G600-356	Apr. 06, 2015	Apr. 05, 2018
<input type="checkbox"/>	MVG	5000 MHz Dipole	SWG5500	SN 13/14 WGA 33	Apr. 06, 2015	Apr. 05, 2018
<input checked="" type="checkbox"/>	MVG	Liquid measurement Kit	SCLMP	SN 21/15 OCPG 72	NCR	NCR
<input checked="" type="checkbox"/>	MVG	Power Amplifier	N.A	AMPLISAR_28/14_003	NCR	NCR
<input checked="" type="checkbox"/>	KEITHLEY	Millivoltmeter	2000	4072790	NCR	NCR
<input checked="" type="checkbox"/>	R&S	Universal radio communication tester	CMU200	117858	Aug. 09, 2016	Aug. 08, 2017
<input checked="" type="checkbox"/>	R&S	Wideband radio communication tester	CMW500	148500	Jun. 26, 2016	Jun. 25, 2017

<input checked="" type="checkbox"/>	HP	Network Analyzer	8753D	3410J01136	Aug. 09, 2016	Aug. 08, 2017
<input checked="" type="checkbox"/>	Agilent	PSG Analog Signal Generator	E8257D	MY51110112	Aug. 09, 2016	Aug. 08, 2017
<input checked="" type="checkbox"/>	Agilent	Power meter	E4419B	MY45102538	Aug. 09, 2016	Aug. 08, 2017
<input checked="" type="checkbox"/>	Agilent	Power sensor	E9301A	MY41495644	Aug. 09, 2016	Aug. 08, 2017
<input checked="" type="checkbox"/>	Agilent	Power sensor	E9301A	US39212148	Aug. 09, 2016	Aug. 08, 2017
<input checked="" type="checkbox"/>	MCLI/USA	Directional Coupler	CB11-20	0D2L51502	Aug. 16, 2016	Aug. 15, 2017

### 3. SAR Measurement Procedures

The measurement procedures are as follows:

<Conducted power measurement>

- (a) For WWAN power measurement, use base station simulator to configure EUT WWAN transmission in conducted connection with RF cable, at maximum power in each supported wireless interface and frequency band.
- (b) Read the WWAN RF power level from the base station simulator.
- (c) For Wi-Fi/BT power measurement, use engineering software to configure EUT Wi-Fi/BT continuously transmission, at maximum RF power in each supported wireless interface and frequency band.
- (d) Connect EUT RF port through RF cable to the power meter, and measure Wi-Fi/BT output power.

<SAR measurement>

- (a) Use base station simulator to configure EUT WWAN transmission in radiated connection, and engineering software to configure EUT Wi-Fi/BT continuously transmission, at maximum RF power, in the highest power channel.
- (b) Place the EUT in the positions as Appendix A demonstrates.
- (c) Set scan area, grid size and other setting on the OPENSAR software.
- (d) Measure SAR results for the highest power channel on each testing position.
- (e) Find out the largest SAR result on these testing positions of each band.
- (f) Measure SAR results for other channels in worst SAR testing position if the reported SAR of highest power channel is larger than 0.8 W/kg.

According to the test standard, the recommended procedure for assessing the peak spatial-average SAR value consists of the following steps:

- (a) Power reference measurement
- (b) Area scan
- (c) Zoom scan
- (d) Power drift measurement

#### 3.1. Power Reference

The Power Reference Measurement and Power Drift Measurements are for monitoring the power drift of the device under test in the batch process. The minimum distance of probe sensors to surface determines the closest measurement point to phantom surface. This distance cannot be smaller than the distance of sensor calibration points to probe tip as defined in the probe properties.

#### 3.2. Area scan & Zoom scan

The area scan is a 2D scan to find the hot spot location on the DUT. The zoom scan is a 3D scan above the hot spot to calculate the 1g and 10g SAR value.

Measurement of the SAR distribution with a grid of 8 to 16 mm \* 8 to 16 mm and a constant distance to

the inner surface of the phantom. Since the sensors cannot directly measure at the inner phantom surface, the values between the sensors and the inner phantom surface are extrapolated. With these values the area of the maximum SAR is calculated by an interpolation scheme. Around this point, a cube of 30 \* 30 \* 30 mm or 32 \* 32 \* 32 mm is assessed by measuring 5 or 8 \* 5 or 8 \* 4 or 5 mm. With these data, the peak spatial-average SAR value can be calculated.

From the scanned SAR distribution, identify the position of the maximum SAR value, in addition identify the positions of any local maxima with SAR values within 2 dB of the maximum value that will not be within the zoom scan of other peaks; additional peaks shall be measured only when the primary peak is within 2 dB of the SAR compliance limit (e.g., 1 W/kg for 1,6 W/kg 1 g limit, or 1,26 W/kg for 2 W/kg, 10 g limit).

Area scan & Zoom scan scan parameters extracted from FCC KDB 865664 D01 SAR measurement 100 MHz to 6 GHz.

		≤ 3 GHz	> 3 GHz
Maximum distance from closest measurement point (geometric center of probe sensors) to phantom surface		5 ± 1 mm	½·δ·ln(2) ± 0.5 mm
Maximum probe angle from probe axis to phantom surface normal at the measurement location		30° ± 1°	20° ± 1°
Maximum area scan spatial resolution: Δx <sub>Area</sub> , Δy <sub>Area</sub>		≤ 2 GHz: ≤ 15 mm 2 – 3 GHz: ≤ 12 mm	3 – 4 GHz: ≤ 12 mm 4 – 6 GHz: ≤ 10 mm
		When the x or y dimension of the test device, in the measurement plane orientation, is smaller than the above, the measurement resolution must be ≤ the corresponding x or y dimension of the test device with at least one measurement point on the test device.	
Maximum zoom scan spatial resolution: Δx <sub>Zoom</sub> , Δy <sub>Zoom</sub>		≤ 2 GHz: ≤ 8 mm 2 – 3 GHz: ≤ 5 mm*	3 – 4 GHz: ≤ 5 mm* 4 – 6 GHz: ≤ 4 mm*
Maximum zoom scan spatial resolution, normal to phantom surface	uniform grid: Δz <sub>Zoom</sub> (n)	≤ 5 mm	3 – 4 GHz: ≤ 4 mm 4 – 5 GHz: ≤ 3 mm 5 – 6 GHz: ≤ 2 mm
	graded grid Δz <sub>Zoom</sub> (1): between 1 <sup>st</sup> two points closest to phantom surface	≤ 4 mm	3 – 4 GHz: ≤ 3 mm 4 – 5 GHz: ≤ 2.5 mm 5 – 6 GHz: ≤ 2 mm
		Δz <sub>Zoom</sub> (n>1): between subsequent points	≤ 1.5·Δz <sub>Zoom</sub> (n-1)
Minimum zoom scan volume	x, y, z	≥ 30 mm	3 – 4 GHz: ≥ 28 mm 4 – 5 GHz: ≥ 25 mm 5 – 6 GHz: ≥ 22 mm

Note: δ is the penetration depth of a plane-wave at normal incidence to the tissue medium; see draft standard IEEE P1528-2011 for details.

\* When zoom scan is required and the *reported* SAR from the *area scan based 1-g SAR estimation* procedures of KDB 447498 is ≤ 1.4 W/kg, ≤ 8 mm, ≤ 7 mm and ≤ 5 mm zoom scan resolution may be applied, respectively, for 2 GHz to 3 GHz, 3 GHz to 4 GHz and 4 GHz to 6 GHz.

### **3.3. Description of interpolation/extrapolation scheme**

The local SAR inside the phantom is measured using small dipole sensing elements inside a probe body. The probe tip must not be in contact with the phantom surface in order to minimise measurements errors, but the highest local SAR will occur at the surface of the phantom.

An extrapolation is used to determine these highest local SAR values. The extrapolation is based on a fourth-order least-square polynomial fit of measured data. The local SAR value is then extrapolated from the liquid surface with a 1 mm step.

The measurements have to be performed over a limited time (due to the duration of the battery) so the step of measurement is high. It could vary between 5 and 8 mm. To obtain an accurate assessment of the maximum SAR averaged over 10 grams and 1 gram requires a very fine resolution in the three dimensional scanned data array.

### **3.4. Volumetric Scan**

The volumetric scan consists to a full 3D scan over a specific area. This 3D scan is useful for multi Tx SAR measurement. Indeed, it is possible with OpenSAR to add, point by point, several volumetric scans to calculate the SAR value of the combined measurement as it is defined in the standard IEEE1528 and IEC62209.

### **3.5. Power Drift**

All SAR testing is under the EUT installed full charged battery and transmit maximum output power. In OpenSAR measurement software, the power reference measurement and power drift measurement procedures are used for monitoring the power drift of EUT during SAR test. Both these procedures measure the field at a specified reference position before and after the SAR testing. The software will calculate the field difference in V/m. If the power drifts more than  $\pm 5\%$ , the SAR will be retested.

## 4. System Verification Procedure

### 4.1. Tissue Verification

The following tissue formulations are provided for reference only as some of the parameters have not been thoroughly verified. The composition of ingredients may be modified accordingly to achieve the desired target tissue parameters required for routine SAR evaluation.

<b>Ingredients</b> (% of weight)	<b>Head Tissue</b>							
Frequency Band (MHz)	750	835	900	1800	1900	2000	2450	2600
Water	34.40	34.40	34.40	55.36	55.36	57.87	57.87	57.87
NaCl	0.79	0.79	0.79	0.35	0.35	0.16	0.16	0.16
1,2-Propanediol	64.81	64.81	64.81	0.00	0.00	0.00	0.00	0.00
Triton X-100	0.00	0.00	0.00	30.45	30.45	19.97	19.97	19.97
DGBE	0.00	0.00	0.00	13.84	13.84	22.00	22.00	22.00
<b>Ingredients</b> (% of weight)	<b>Body Tissue</b>							
Frequency Band (MHz)	750	835	900	1800	1900	2000	2450	2600
Water	50.30	50.30	50.30	69.91	69.91	71.88	71.88	71.88
NaCl	0.60	0.60	0.60	0.13	0.13	0.16	0.16	0.16
1,2-Propanediol	49.10	49.10	49.10	0.00	0.00	0.00	0.00	0.00
Triton X-100	0.00	0.00	0.00	9.99	9.99	19.97	19.97	19.97
DGBE	0.00	0.00	0.00	19.97	19.97	7.99	7.99	7.99

**4.1.1. Tissue Dielectric Parameter Check Results**

The simulating liquids should be checked at the beginning of a series of SAR measurements to determine if the dielectric parameters are within the tolerances of the specified target values. The measured conductivity and relative permittivity should be within  $\pm 5\%$  of the target values.

Tissue Type	Measured Frequency (MHz)	Target Tissue		Measured Tissue		Liquid Temp.	Test Date
		$\epsilon_r$ ( $\pm 5\%$ )	$\sigma$ (S/m) ( $\pm 5\%$ )	$\epsilon_r$	$\sigma$ (S/m)		
Head 850	835	41.50 (39.43~43.57)	0.90 (0.86~0.94)	42.54	0.89	21.4 °C	Apr. 22, 2017
Body 850	835	55.20 (52.44~57.96)	0.97 (0.92~1.01)	55.40	0.98	21.6 °C	Apr. 22, 2017
Head 1750	1750	40.10 (38.10~42.11)	1.37 (1.30~1.44)	40.25	1.37	21.4 °C	Apr. 26, 2017
Body 1750	1750	53.40 (50.73~56.07)	1.49 (1.42~1.56)	54.22	1.50	21.3 °C	Apr. 28, 2017
Head 1900	1900	40.00 (38.00~42.00)	1.40 (1.33~1.47)	39.36	1.43	21.2 °C	Apr. 25, 2017
Body 1900	1900	53.30 (50.64~55.96)	1.52 (1.44~1.59)	53.51	1.56	21.5 °C	Apr. 25, 2017
Head 2450	2450	39.20 (37.24~41.16)	1.80 (1.71~1.89)	39.94	1.79	21.4 °C	Apr. 20, 2017
Body 2450	2450	52.70 (50.07~55.33)	1.95 (1.85~2.04)	52.33	1.96	21.6 °C	Apr. 20, 2017
Head 2600	2600	39.00 (37.05~40.95)	1.96 (1.86~2.05)	39.02	1.97	21.4 °C	May. 04, 2017
Body 2600	2600	52.50 (49.88~55.13)	2.16 (2.05~2.27)	53.70	2.17	21.5 °C	May. 08, 2017

NOTE: The dielectric parameters of the tissue-equivalent liquid should be measured under similar ambient conditions and within 2 °C of the conditions expected during the SAR evaluation to satisfy protocol requirements.

### 4.2. System Verification Procedure

The system verification is performed for verifying the accuracy of the complete measurement system and performance of the software. The dipole is connected to the signal source consisting of signal generator and amplifier via a directional coupler, N-connector cable and adaption to SMA. It is fed with a power of 100mW (below 5GHz) or 100mW (above 5GHz). To adjust this power a power meter is used. The power sensor is connected to the cable before the system verification to measure the power at this point and do adjustments at the signal generator. At the outputs of the directional coupler both return loss as well as forward power are controlled during the system verification to make sure that emitted power at the dipole is kept constant. This can also be checked by the power drift measurement after the test (result on plot).

The system verification is shown as below picture:

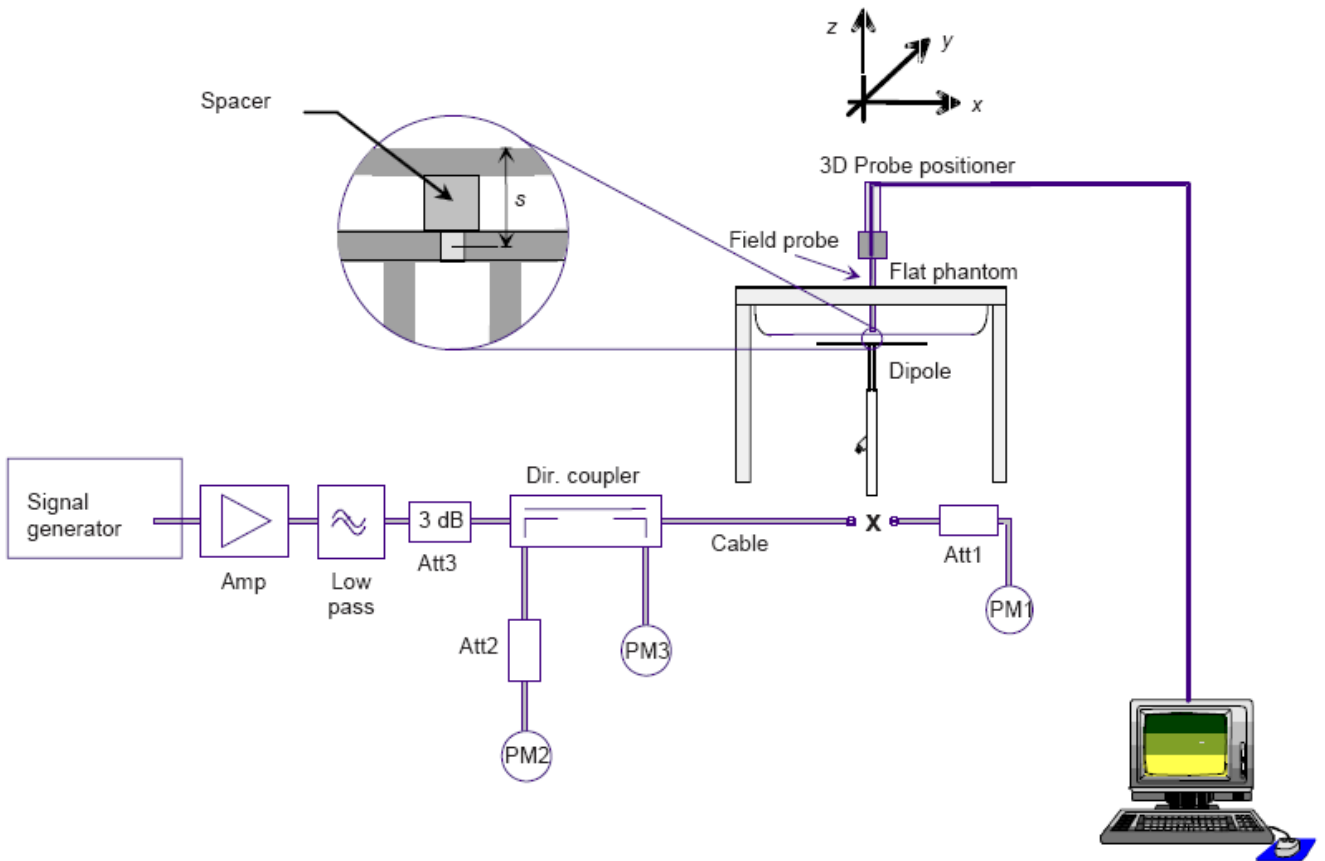



#### 4.2.1. System Verification Results

Comparing to the original SAR value provided by SATIMO, the verification data should be within its specification of  $\pm 10\%$ . Below table shows the target SAR and measured SAR after normalized to 1W input power. The table below indicates the system performance verification can meet the variation criterion and the plots can be referred to Appendix B of this report.

System Verification	Target SAR (1W) ( $\pm 10\%$ )		Measured SAR (Normalized to 1W)		Liquid Temp.	Test Date
	1-g (W/Kg)	10-g (W/Kg)	1-g (W/Kg)	10-g (W/Kg)		
835MHz Head	9.56 (8.60~10.51)	6.22 (5.60~6.84)	9.72	6.51	21.4 °C	Apr. 22, 2017
835MHz Body	9.48 (8.53~10.42)	6.29 (5.66~6.91)	9.54	6.37	21.6 °C	Apr. 22, 2017
1750MHz Head	36.40 (32.76~40.04)	19.30 (17.37~21.23)	37.39	19.68	21.4 °C	Apr. 26, 2017
1750MHz Body	36.91 (33.22~40.60)	20.18 (18.16~22.20)	36.71	19.00	21.3 °C	Apr. 28, 2017
1900MHz Head	39.70 (35.73~43.67)	20.50 (18.45~22.55)	41.94	21.68	21.2 °C	Apr. 25, 2017
1900MHz Body	38.43 (34.59~42.27)	20.34 (18.31~22.37)	40.10	20.77	21.5 °C	Apr. 25, 2017
2450MHz Head	52.40 (47.16~57.64)	24.00 (21.60~26.40)	54.84	24.07	21.4 °C	Apr. 20, 2017
2450MHz Body	49.32 (44.39~54.25)	22.89 (20.60~25.17)	50.15	22.21	21.6 °C	Apr. 20, 2017
2600MHz Head	55.30 (49.77~60.83)	24.60 (22.14~27.06)	53.40	23.62	21.4 °C	May. 04, 2017
2600MHz Body	52.95 (47.66~58.25)	23.64 (21.28~26.00)	51.75	22.91	21.5 °C	May. 08, 2017

## 5. SAR Measurement variability and uncertainty

### 5.1. SAR measurement variability

Per KDB865664 D01 SAR measurement 100 MHz to 6 GHz, SAR measurement variability must be assessed for each frequency band, which is determined by the SAR probe calibration point and tissue-equivalent medium used for the device measurements. The additional measurements are repeated after the completion of all measurements requiring the same head or body tissue-equivalent medium in a frequency band. The test device should be returned to ambient conditions (normal room temperature) with the battery fully charged before it is re-mounted on the device holder for the repeated measurement(s) to minimize any unexpected variations in the repeated results.

- 1) Repeated measurement is not required when the original highest measured SAR is  $< 0.80$  W/kg; steps 2) through 4) do not apply.
- 2) When the original highest measured SAR is  $\geq 0.80$  W/kg, repeat that measurement once.
- 3) Perform a second repeated measurement only if the ratio of largest to smallest SAR for the original and first repeated measurements is  $> 1.20$  or when the original or repeated measurement is  $\geq 1.45$  W/kg (~ 10% from the 1-g SAR limit).
- 4) Perform a third repeated measurement only if the original, first or second repeated measurement is  $\geq 1.5$  W/kg and the ratio of largest to smallest SAR for the original, first and second repeated measurements is  $> 1.20$ .

### 5.2. SAR measurement uncertainty

Per KDB865664 D01 SAR Measurement 100 MHz to 6 GHz, when the highest measured 1-g SAR within a frequency band is  $< 1.5$  W/kg, the extensive SAR measurement uncertainty analysis described in IEEE Std 1528-2013 is not required in SAR reports submitted for equipment approval. The equivalent ratio (1.5/1.6) is applied to extremity and occupational exposure conditions.

## 6. RF Exposure Positions

### 6.1. Ear and handset reference point

Figure 6.1.1 shows the front, back, and side views of the SAM phantom. The center-of-mouth reference point is labeled “M”, the left ear reference point (ERP) is marked “LE”, and the right ERP is marked “RE”.



Fig 6.1.1 Front, back, and side views of SAM phantom

### 6.2. Definition of the cheek position

1. Define two imaginary lines on the handset, the vertical centerline and the horizontal line. The vertical centerline passes through two points on the front side of the handset: the midpoint of the width  $w_t$  of the handset at the level of the acoustic output (point A in Figure 6.2.1 and Figure 6.2.2), and the midpoint of the width  $w_b$  of the bottom of the handset (point B). The horizontal line is perpendicular to the vertical centerline and passes through the center of the acoustic output (see Figure 6.2.1). The two lines intersect at point A. Note that for many handsets, point A coincides with the center of the acoustic output; however, the acoustic output may be located elsewhere on the horizontal line. Also note that the vertical centerline is not necessarily parallel to the front face of the handset (see Figure 6.2.2), especially for clamshell handsets, handsets with flip covers, and other irregularly-shaped handsets.
2. Position the handset close to the surface of the phantom such that point A is on the (virtual) extension of the line passing through points RE and LE on the phantom (see Figure 6.2.3), such that the plane defined by the vertical centerline and the horizontal line of the handset is approximately parallel to the sagittal plane of the phantom.
3. Translate the handset towards the phantom along the line passing through RE and LE until handset point A touches the pinna at the ERP
4. While maintaining the handset in this plane, rotate it around the LE-RE line until the vertical centerline is in the plane normal to the plane containing B-M and N-F lines, i.e., the Reference Plane.
5. Rotate the handset around the vertical centerline until the handset (horizontal line) is parallel to the N-F line.

6. While maintaining the vertical centerline in the Reference Plane, keeping point A on the line passing through RE and LE, and maintaining the handset contact with the pinna, rotate the handset about the N-F line until any point on the handset is in contact with a phantom point below the pinna on the cheek. See Figure 6.2.3. The actual rotation angles should be documented in the test report.

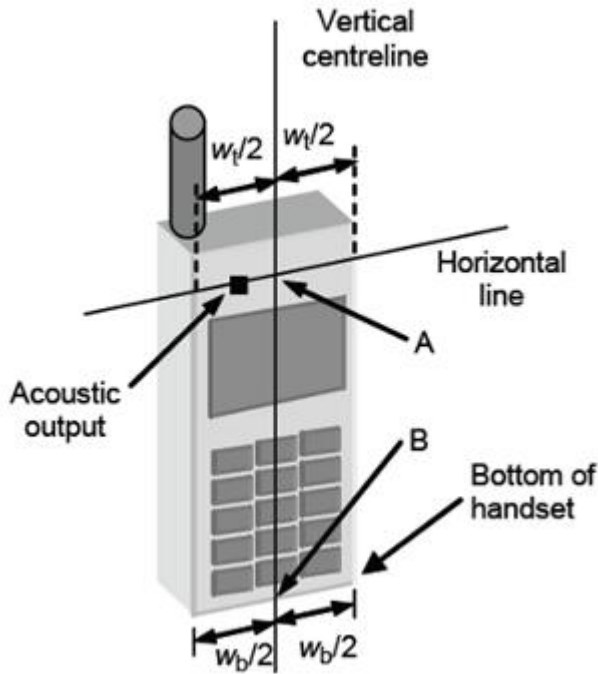

Fig 6.2.1 Handset vertical and horizontal reference lines—"fixed case"

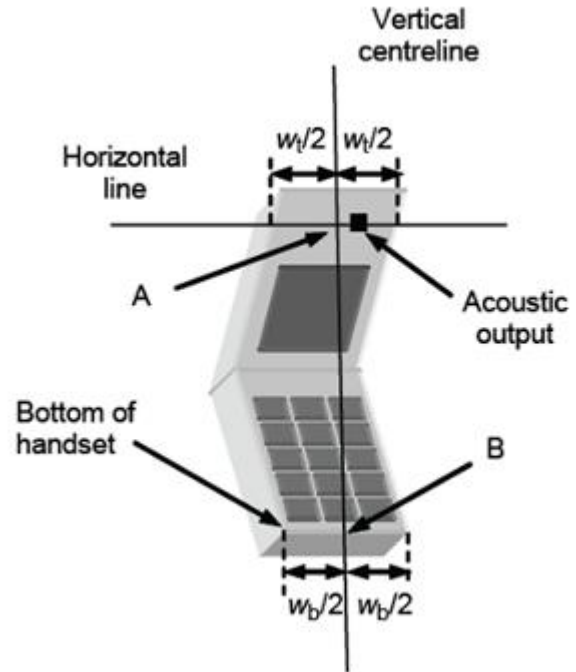

Fig 6.2.2 Handset vertical and horizontal reference lines—"clam-shell case"

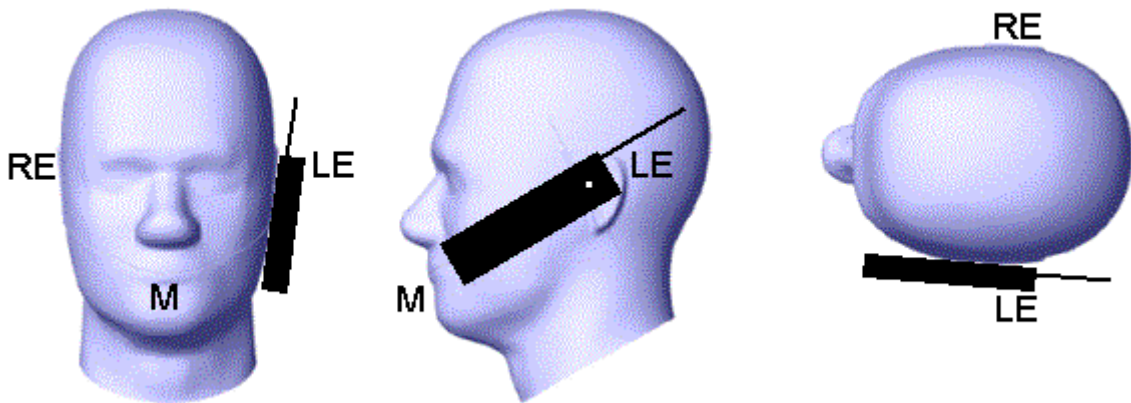

Fig 6.2.3 cheek or touch position. The reference points for the right ear (RE), left ear (LE), and mouth (M), which establish the Reference Plane for handset positioning, are indicated.

### 6.3. Definition of the tilt position

1. While maintaining the orientation of the handset, retract the handset parallel to the reference plane far enough away from the phantom to enable a rotation of the device by 15 degree.
2. Rotate the Handset around the horizontal line by 15 degree (see Figure 6.3.1).
3. While maintaining the orientation of the handset, move the handset towards the phantom on a line passing through RE and LE until any part of the handset touches the ear. The tilt position is obtained when the contact is on the pinna. If the contact is at any location other than the pinna, e.g., the antenna with the back of the phantom head, the angle of the handset shall be reduced. In this case, the tilt position is obtained if any part of the handset is in contact with the pinna as well as a second part of the handset is in contact with the phantom, e.g., the antenna with the back of the head.

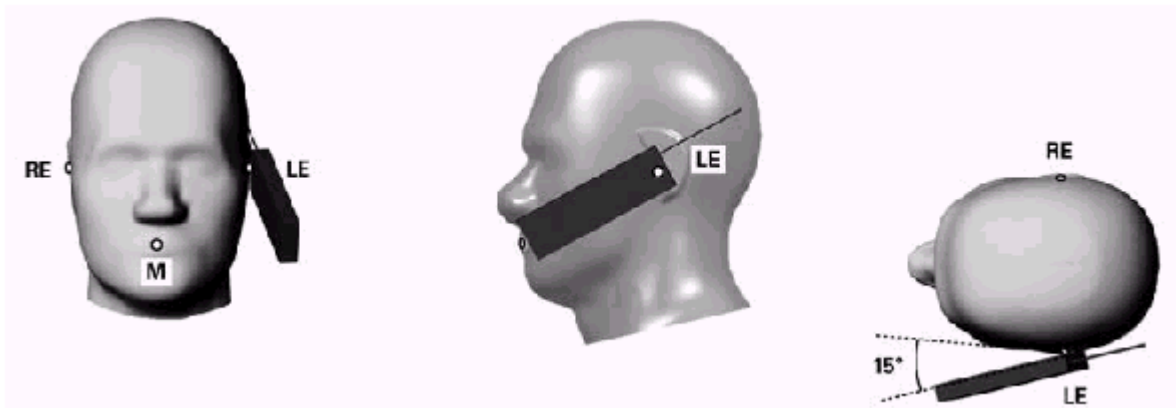

Figure 6.3.1 – Tilt position of the wireless device on the left side of SAM

### 6.4. Body Worn Accessory

1. Body-worn operating configurations are tested with the belt-clips and holsters attached to the device and positioned against a flat phantom in a normal use configuration (see Figure 6.4.1). Per KDB 648474 D04, body-worn accessory exposure is typically related to voice mode operations when handsets are carried in body-worn accessories. The body-worn accessory procedures in FCC KDB 447498 D01 should be used to test for body-worn accessory SAR compliance, without a headset connected to it. This enables the test results for such configuration to be compatible with that required for hotspot mode when the body-worn accessory test separation distance is greater than or equal to that required for hotspot mode, when applicable. When the reported SAR for body-worn accessory, measured without a headset connected to the handset is  $< 1.2$  W/kg, the highest reported SAR configuration for that wireless mode and frequency band should be repeated for that body-worn accessory with a handset attached to the handset.
2. Accessories for body-worn operation configurations are divided into two categories: those that do not contain metallic components and those that do contain metallic components and those that do contain metallic components. When multiple accessories that do not contain metallic components are supplied with the device, the device is tested with only the accessory that dictates the closest

spacing to the body. Then multiple accessories that contain metallic components are test with the device with each accessory. If multiple accessories share an identical metallic component (i.e. the same metallic belt-clip used with different holsters with no other metallic components) only the accessory that dictates the closest spacing to the body is tested.

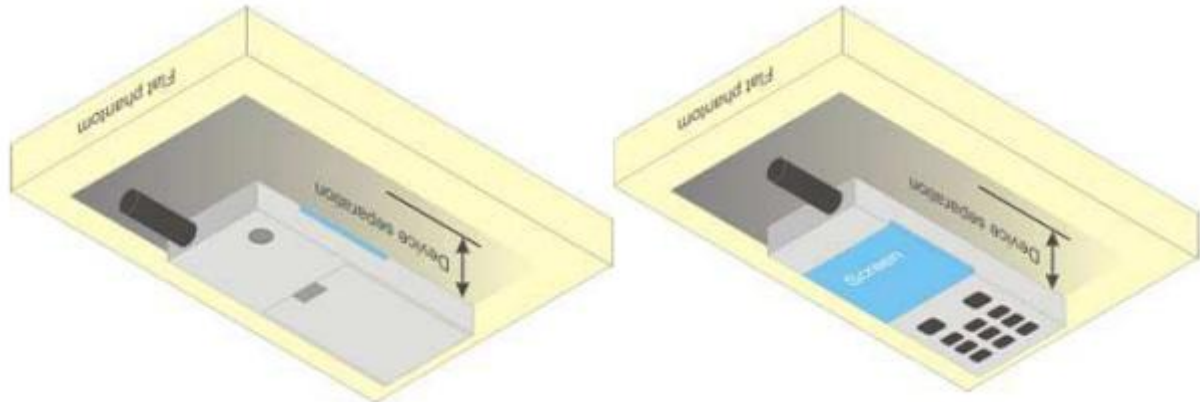

Figure 6.4.1 – Test positions for body-worn devices

### 6.5. Wireless Router Devices

Some battery-operated handsets have the capability to transmit and receive user through simultaneous transmission of WI-FI simultaneously with a separate licensed transmitter. The FCC has provided guidance in FCC HDB Publication 941225 D06 where SAR test considerations for handsets ( $L \times W \geq 9 \text{ cm} \times 5 \text{ cm}$ ) are based on a composite test separation distance of 10mm from the front, back and edges of the device containing transmitting antennas within 2.5cm of their edges, determined from general mixed use conditions for this type of devices. Since the hotspot SAR results may overlap with the body-worn accessory SAR requirements, the more conservative configurations can be considered, thus excluding some body-worn accessory SAR tests.

When the user enables the personal wireless router functions for the handset, actual operations include simultaneous transmission of both the WI-FI transmitter and another licensed transmitter. Both transmitters often do not transmit at the same transmitting frequency and thus cannot be evaluated for SAR under actual use conditions due to the limitations of the SAR assessment probes. Therefore, SAR must be evaluated for each frequency transmission and mode separately and spatially summed with the WI-FI transmitter according to FCC KDB Publication 447498 D01 publication procedures. The “Portable Hotspot” feature on the handset was NOT activated during SAR assessments, to ensure the SAR measurements were evaluated for a single transmission frequency RF signal at a time.

## 7. RF Output Power

### 7.1. Maximum Tune-up Limit

Band	Mode	The Tune-up Maximum Power (Customer Declared)(dBm)	Range	Measured Maximum Output Power(dBm)
GSM 850	GSM (GMSK)	32±1	31~33	32.59
	GPRS(GMSK, 1 Tx slot)	32±1	31~33	32.58
	GPRS(GMSK, 2 Tx slot)	31±1	30~32	31.79
	GPRS(GMSK, 3 Tx slot)	30±1	29~31	30.07
	GPRS(GMSK, 4 Tx slot)	29±1	28~30	28.95
	EDGE(8PSK, 1 Tx slot)	27±1	26~28	27.49
	EDGE(8PSK, 2 Tx slot)	26±1	25~27	26.20
	EDGE(8PSK, 3 Tx slot)	23±1	22~24	23.98
	EDGE(8PSK, 4 Tx slot)	22±1	21~23	22.97
GSM 1900	GSM (GMSK)	29±1	28~30	29.83
	GPRS(GMSK, 1 Tx slot)	29±1	28~30	29.83
	GPRS(GMSK, 2 Tx slot)	29±1	28~30	29.07
	GPRS(GMSK, 3 Tx slot)	27±1	26~28	27.38
	GPRS(GMSK, 4 Tx slot)	26±1	25~27	26.33
	EDGE(8PSK, 1 Tx slot)	27±1	26~28	27.21
	EDGE(8PSK, 2 Tx slot)	26±1	25~27	26.31
	EDGE(8PSK, 3 Tx slot)	24±1	23~25	24.57
	EDGE(8PSK, 4 Tx slot)	23±1	22~24	23.41
WCDMA Band V	RMC 12.2Kbps	22±1	21~23	22.71
	HSDPA Subtest-1	21±1	20~22	21.73
	HSDPA Subtest-2	21±1	20~22	21.18
	HSDPA Subtest-3	21±1	20~22	21.22
	HSDPA Subtest-4	21±1	20~22	21.25
	HSUPA Subtest-1	21±1	20~22	21.18
	HSUPA Subtest-2	21±1	20~22	21.18
	HSUPA Subtest-3	21±1	20~22	21.12
	HSUPA Subtest-4	21±1	20~22	21.21
	HSUPA Subtest-5	21±1	20~22	21.75
WCDMA Band II	RMC 12.2Kbps	22±1	21~23	22.63
	HSDPA Subtest-1	21±1	20~22	21.90
	HSDPA Subtest-2	21±1	20~22	21.48
	HSDPA Subtest-3	21±1	20~22	21.53
	HSDPA Subtest-4	21±1	20~22	21.53

	HSUPA Subtest-1	21±1	20~22	21.49
	HSUPA Subtest-2	21±1	20~22	21.38
	HSUPA Subtest-3	21±1	20~22	21.42
	HSUPA Subtest-4	21±1	20~22	21.45
	HSUPA Subtest-5	21±1	20~22	21.95
LTE Band V	1.4M QPSK 1RB	22.5±1	21.5~23.5	23.16
	1.4M QPSK 3RB	22.5±1	21.5~23.5	23.18
	1.4M QPSK 6RB	21.5±1	20.5~22.5	22.04
	1.4M 16QAM 1RB	21.5±1	20.5~22.5	22.15
	1.4M 16QAM 3RB	22.5±1	21.5~23.5	23.18
	1.4M 16QAM 6RB	20.5±1	19.5~21.5	21.05
	3M QPSK 1RB	22.5±1	21.5~23.5	23.11
	3M QPSK 8RB	22.5±1	21.5~23.5	23.06
	3M QPSK 15RB	21.5±1	20.5~22.5	22.11
	3M 16QAM 1RB	22.5±1	21.5~23.5	22.68
	3M 16QAM 8RB	22.5±1	21.5~23.5	22.65
	3M 16QAM 15RB	21.5±1	20.5~22.5	21.16
	5M QPSK 1RB	22.5±1	21.5~23.5	23.18
	5M QPSK 12RB	21.5±1	20.5~22.5	22.16
	5M QPSK 25RB	21.5±1	20.5~22.5	22.09
	5M 16QAM 1RB	22.5±1	21.5~23.5	22.30
	5M 16QAM 12RB	21.5±1	20.5~22.5	22.16
	5M 16QAM 25RB	20.5±1	19.5~21.5	21.16
	10M QPSK 1RB	22.5±1	21.5~23.5	23.20
	10M QPSK 25RB	22.5±1	21.5~23.5	23.10
	10M QPSK 50RB	21.5±1	20.5~22.5	22.07
	10M 16QAM 1RB	22.5±1	21.5~23.5	22.71
	10M 16QAM 25RB	21.5±1	20.5~22.5	22.11
10M 16QAM 50RB	20.5±1	19.5~21.5	21.06	
LTE Band IV	1.4M QPSK 1RB	22±1	21~23	22.43
	1.4M QPSK 3RB	22±1	21~23	22.52
	1.4M QPSK 6RB	21±1	20~22	21.39
	1.4M 16QAM 1RB	21±1	20~22	21.49
	1.4M 16QAM 3RB	22±1	21~23	22.51
	1.4M 16QAM 6RB	20±1	19~21	20.46
	3M QPSK 1RB	22±1	21~23	22.45
	3M QPSK 8RB	22±1	21~23	22.41
	3M QPSK 15RB	21±1	20~22	21.50
	3M 16QAM 1RB	22±1	21~23	22.09
	3M 16QAM 8RB	22±1	21~23	22.05



	3M 16QAM 15RB	20±1	19~21	20.60
	5M QPSK 1RB	22±1	21~23	22.60
	5M QPSK 12RB	21±1	20~22	21.61
	5M QPSK 25RB	21±1	20~22	21.52
	5M 16QAM 1RB	21±1	20~22	21.86
	5M 16QAM 12RB	21±1	20~22	21.57
	5M 16QAM 25RB	20±1	19~21	20.62
	10M QPSK 1RB	22±1	21~23	22.52
	10M QPSK 25RB	21±1	20~22	21.52
	10M QPSK 50RB	21±1	20~22	21.54
	10M 16QAM 1RB	22±1	21~23	22.17
	10M 16QAM 25RB	21±1	20~22	21.52
	10M 16QAM 50RB	20±1	19~21	20.56
	15M QPSK 1RB	22±1	21~23	22.53
	15M QPSK 36RB	21±1	20~22	21.54
	15M QPSK 75RB	21±1	20~22	21.55
	15M 16QAM 1RB	22±1	21~23	22.16
	15M 16QAM 36RB	21±1	20~22	21.53
	15M 16QAM 75RB	20±1	19~21	20.53
	20M QPSK 1RB	22±1	21~23	22.63
	20M QPSK 50RB	22±1	21~23	22.57
	20M QPSK 100RB	21±1	20~22	21.52
	20M 16QAM 1RB	22±1	21~23	22.18
	20M 16QAM 50RB	21±1	20~22	21.57
	20M 16QAM 100RB	20±1	19~21	20.54
LTE Band II	1.4M QPSK 1RB	22±1	21~23	22.67
	1.4M QPSK 3RB	22±1	21~23	22.76
	1.4M QPSK 6RB	21±1	20~22	21.63
	1.4M 16QAM 1RB	21±1	20~22	21.74
	1.4M 16QAM 3RB	22±1	21~23	22.72
	1.4M 16QAM 6RB	20±1	19~21	20.67
	3M QPSK 1RB	22±1	21~23	22.68
	3M QPSK 8RB	22±1	21~23	22.63
	3M QPSK 15RB	21±1	20~22	21.68
	3M 16QAM 1RB	22±1	21~23	22.16
	3M 16QAM 8RB	22±1	21~23	22.63
	3M 16QAM 15RB	20±1	19~21	20.79
	5M QPSK 1RB	22±1	21~23	22.77
	5M QPSK 12RB	22±1	21~23	22.74
	5M QPSK 25RB	21±1	20~22	21.69

	5M 16QAM 1RB	21±1	20~22	21.93
	5M 16QAM 12RB	21±1	20~22	21.72
	5M 16QAM 25RB	20±1	19~21	20.72
	10M QPSK 1RB	22±1	21~23	22.67
	10M QPSK 25RB	21±1	20~22	21.68
	10M QPSK 50RB	21±1	20~22	21.67
	10M 16QAM 1RB	22±1	21~23	22.23
	10M 16QAM 25RB	21±1	20~22	21.69
	10M 16QAM 50RB	20±1	19~21	20.74
	15M QPSK 1RB	22±1	21~23	22.74
	15M QPSK 36RB	21±1	20~22	21.75
	15M QPSK 75RB	21±1	20~22	21.77
	15M 16QAM 1RB	22±1	21~23	22.30
	15M 16QAM 36RB	21±1	20~22	21.76
	15M 16QAM 75RB	20±1	19~21	20.75
	20M QPSK 1RB	22±1	21~23	22.86
	20M QPSK 50RB	22±1	21~23	22.80
	20M QPSK 100RB	21±1	20~22	21.69
	20M 16QAM 1RB	22±1	21~23	22.27
	20M 16QAM 50RB	21±1	20~22	21.70
	20M 16QAM 100RB	20±1	19~21	20.73
LTE Band VII	5M QPSK 1RB	23±1	22~24	23.61
	5M QPSK 12RB	22±1	21~23	22.78
	5M QPSK 25RB	22±1	21~23	22.72
	5M 16QAM 1RB	21±1	20~22	21.74
	5M 16QAM 12RB	22±1	21~23	22.78
	5M 16QAM 25RB	22±1	21~23	22.71
	10M QPSK 1RB	22±1	21~23	22.56
	10M QPSK 25RB	22±1	21~23	22.68
	10M QPSK 50RB	22±1	21~23	22.64
	10M 16QAM 1RB	22±1	21~23	22.50
	10M 16QAM 25RB	22±1	21~23	22.67
	10M 16QAM 50RB	22±1	21~23	22.63
	15M QPSK 1RB	22±1	21~23	22.66
	15M QPSK 36RB	21±1	20~22	21.77
	15M QPSK 75RB	21±1	20~22	21.69
	15M 16QAM 1RB	22±1	21~23	22.66
	15M 16QAM 36RB	21±1	20~22	21.78
	15M 16QAM 75RB	21±1	20~22	20.69
	20M QPSK 1RB	23±1	22~24	23.67

	20M QPSK 50RB	22±1	21~23	22.83	
	20M QPSK 100RB	22±1	21~23	22.61	
	20M 16QAM 1RB	22±1	21~23	22.68	
	20M 16QAM 50RB	21±1	20~22	21.65	
	20M 16QAM 100RB	21±1	20~22	21.60	
Wi-Fi 2.4G	802.11b	14.5±1	13.5~15.5	15.30	
	802.11g	12.5±1	11.5~13.5	12.80	
	802.11n-HT20	12.5±1	11.5~13.5	12.80	
	802.11n-HT40	12.5±1	11.5~13.5	13.40	
BT	3.0	0	2±1	1~3	2.23
		39	3±1	2~4	3.87
		78	2±1	1~3	2.56
	4.0	0	3±1	2~4	2.11
		19	3±1	2~4	3.72
		39	3±1	2~4	2.42

### 7.2. GSM Conducted Power

Per KDB 447498 D01, the maximum output power channel is used for SAR testing and for further SAR test reduction. Therefore, the EUT was set in GPRS (4Tx slots) for GSM850/GSM1900.

Band GSM850	Burst-Averaged output Power (dBm)				Frame-Averaged output Power (dBm)			
Tx Channel	Tune-up	128	189	251	Tune-up	128	189	251
Frequency (MHz)	(dBm)	824.2	836.4	848.8	(dBm)	824.2	836.4	848.8
GSM (GMSK)	33.00	32.59	32.53	32.45	23.97	23.56	23.50	23.42
GPRS(GMSK, 1 TS)	33.00	32.58	32.56	32.49	23.97	23.55	23.53	23.46
GPRS(GMSK, 2 TS)	32.00	31.79	31.79	31.74	25.98	25.77	25.77	25.72
GPRS(GMSK, 3 TS)	31.00	30.07	30.04	30.01	26.74	25.81	25.78	25.75
GPRS(GMSK, 4 TS)	30.00	28.94	28.95	28.94	26.99	25.93	25.94	25.93
EDGE(8PSK, 1 TS)	28.00	27.49	27.45	27.38	18.97	18.46	18.42	18.35
EDGE(8PSK, 2 TS)	27.00	26.20	26.09	25.95	20.98	20.18	20.07	19.93
EDGE(8PSK, 3 TS)	24.00	23.98	23.95	23.85	19.74	19.72	19.69	19.59
EDGE(8PSK, 4 TS)	23.00	22.97	22.95	22.81	19.99	19.96	19.94	19.80
Band GSM1900	Burst-Averaged output Power (dBm)				Frame-Averaged output Power (dBm)			
Tx Channel	Tune-up	512	661	810	Tune-up	512	661	810
Frequency (MHz)	(dBm)	1850.2	1880.0	1909.8	(dBm)	1850.2	1880.0	1909.8
GSM (GMSK)	30.00	29.83	29.80	29.78	20.97	20.80	20.77	20.75
GPRS(GMSK, 1 TS)	30.00	29.83	29.81	29.75	20.97	20.80	20.78	20.72
GPRS(GMSK, 2 TS)	30.00	29.07	29.07	29.05	23.98	23.05	23.05	23.03
GPRS(GMSK, 3 TS)	28.00	27.33	27.35	27.38	23.74	23.07	23.09	23.12
GPRS(GMSK, 4 TS)	27.00	26.25	26.29	26.33	23.99	23.24	23.28	23.32
EDGE(8PSK, 1 TS)	28.00	26.98	27.08	27.21	18.97	17.95	18.05	18.18
EDGE(8PSK, 2 TS)	27.00	26.14	26.25	26.31	20.98	20.12	20.23	20.29
EDGE(8PSK, 3 TS)	25.00	24.15	24.37	24.57	20.74	19.89	20.11	20.31
EDGE(8PSK, 4 TS)	24.00	23.19	23.23	23.41	20.99	20.18	20.22	20.40

Note: The frame-averaged power is linearly scaled the maximum burst averaged power over 8 time slots.

The calculated method are shown as below:

Frame-averaged power = Maximum burst averaged power (1 TS) – 9.03 dB

Frame-averaged power = Maximum burst averaged power (2 TS) – 6.02 dB

Frame-averaged power = Maximum burst averaged power (3 TS) - 4.26 dB

Frame-averaged power = Maximum burst averaged power (4 TS) – 3.01 dB

### 7.3. WCDMA Conducted Power

The following tests were conducted according to the test requirements outlines in 3GPP TS 34.121 specification. A summary of these settings are illustrated below:

#### 1. Release99 Setup Configuration

Mode	Subtest	Rel99
WCDMA General Settings	Loopback Mode	Test Mode 1
	Rel99 RMC	12.2kbps RMC
	Power Control Algorithm	Algorithm2
	$\beta_c/\beta_d$	8/15

#### 2. HSDPA Setup Configuration

	Mode	HSDPA	HSDPA	HSDPA	HSDPA
	Subtest	1	2	3	4
WCDMA General Settings	Loopback Mode	Test Mode 1			
	Rel99 RMC	12.2kbps RMC			
	HSDPA FRC	H-Set1			
	Power Control Algorithm	Algorithm 2			
	$\beta_c$	2/15	12/15	15/15	15/15
	$\beta_d$	15/15	15/15	8/15	4/15
	Bd (SF)	64			
	$\beta_c/\beta_d$	2/15	12/15	15/8	15/4
	$\beta_{hs}$	4/15	24/15	30/15	30/15
HSDPA Specific Settings	$D_{ACK}$	8			
	$D_{NAK}$	8			
	DCQI	8			
	Ack-Nack repetition factor	3			
	CQI Feedback (Table 5.2B.4)	4ms			
	CQI Repetition Factor (Table 5.2B.4)	2			
	$A_{hs} = \beta_{hs}/\beta_c$	30/15			

#### 3. HSUPA Setup Configuration

	Mode	HSUPA	HSUPA	HSUPA	HSUPA	HSUPA
	Subtest	1	2	3	4	5
WCDMA General Settings	Loopback Mode	Test Mode 1				
	Rel99 RMC	12.2kbps RMC				
	HSDPA FRC	H-Set1				
	HSUPA Test	HSUPA Loopback				
	Power Control Algorithm	Algorithm2				
	$\beta_c$	11/15	6/15	15/15	2/15	15/15
	$\beta_d$	15/15	15/15	9/15	15/15	15/15
	$\beta_{ec}$	209/225	12/15	30/15	2/15	24/15
	$\beta_c/\beta_d$	11/15	6/15	15/9	2/15	15/15
	$\beta_{hs}$	22/15	12/15	30/15	4/15	30/15
	$\beta_{ed}$	1309/225	94/75	47/15 47/15	56/75	134/15
	CM (dB)	1.0	3.0	2.0	3.0	1.0
HSDPA Specific Settings	$D_{ACK}$	8				
	$D_{NAK}$	8				
	DCQI	8				
	Ack-Nack repetition factor	3				
	CQI Feedback (Table 5.2B.4)	4ms				

HSUPA Specific Settings	CQI Repetition Factor (Table 5.2B.4)	2				
	Ahs = $\beta_{hs}/\beta_c$	30/15				
	D E-DPCCH	6	8	8	5	7
	DHARQ	0	0	0	0	0
	AG Index	20	12	15	17	21
	ETFCI (from 34.121 Table C.11.1.3)	75	67	92	71	81
Associated Max UL Data Rate kbps	242.1	174.9	482.8	205.8	308.9	

4. WCDMA Conducted Power Results

- 1) Per KDB 941225 D01, SAR for Head / Hotspot / Body-worn exposure is measured using a 12.2 kbps RMC with TPC bits configured to all “1’s”.
- 2) Per KDB 941225 D01, RMC 12.2kbps setting is used to evaluate SAR. If the maximum output power and tune-up tolerance specified for production units in HSDPA / HSUPA is  $\leq \frac{1}{4}$  dB higher than RMC 12.2Kbps or when the highest reported SAR of the RMC12.2Kbps is scaled by the ratio of specified maximum output power and tune-up tolerance of HSDPA / HSUPA to RMC12.2Kbps and the adjusted SAR is  $\leq 1.2$  W/kg, SAR measurement is not required for HSDPA / HSUPA.

Band	WCDMA Band V			
Tx Channel	Tune-up	4132	4182	4233
Frequency (MHz)		826.4	836.4	846.6
RMC 12.2Kbps	23.00	22.61	22.52	22.71
HSDPA Subtest-1	22.00	21.61	21.55	21.73
HSDPA Subtest-2	22.00	21.12	21.06	21.18
HSDPA Subtest-3	22.00	21.16	21.07	21.22
HSDPA Subtest-4	22.00	21.14	21.07	21.25
HSUPA Subtest-1	22.00	21.12	21.06	21.18
HSUPA Subtest-2	22.00	21.06	21.08	21.18
HSUPA Subtest-3	22.00	21.08	21.12	21.11
HSUPA Subtest-4	22.00	21.11	21.09	21.21
HSUPA Subtest-5	22.00	21.65	21.59	21.75
Band	WCDMA Band II			
Tx Channel	Tune-up	9262	9400	9538
Frequency (MHz)		1852.4	1880	1907.6
RMC 12.2Kbps	23.00	22.45	22.63	22.58
HSDPA Subtest-1	22.00	21.67	21.87	21.90
HSDPA Subtest-2	22.00	21.24	21.43	21.48
HSDPA Subtest-3	22.00	21.29	21.47	21.53
HSDPA Subtest-4	22.00	21.28	21.43	21.53
HSUPA Subtest-1	22.00	21.22	21.44	21.49

HSUPA Subtest-2	22.00	21.18	21.38	21.38
HSUPA Subtest-3	22.00	21.19	21.42	21.42
HSUPA Subtest-4	22.00	21.21	21.39	21.45
HSUPA Subtest-5	22.00	21.58	21.79	21.95

**7.4. LTE Conducted Power**

R&S CMW500 base station simulator was used to setup the connection with EUT; the frequency band, channel bandwidth, RB allocation configuration, modulation type are set in the base station simulator to configure EUT transmitting at maximum power and at different configurations which are requested to be reported to FCC, for conducted power measurement and SAR testing.

<LTE Band V>

Band	Band Width	Modulation	RB Configuration		Tune-up	Channel/Frequency(MHz)		
			RB Size	RB Offset		20407/824.7	20525/836.5	20643/848.3
LTE Band V	1.4MHz	QPSK	1	0	23.50	23.07	23.07	23.08
			1	2	23.50	23.11	23.09	23.16
			1	5	23.50	23.07	23.05	23.09
			3	0	23.50	23.18	23.15	23.17
			3	1	23.50	23.12	23.16	23.17
			3	2	23.50	23.17	23.15	23.18
			6	0	22.50	22.04	22.01	22.01
		16QAM	1	0	22.50	22.06	22.07	22.05
			1	2	22.50	22.09	22.09	22.15
			1	5	22.50	22.07	22.08	22.07
			3	0	23.50	23.17	23.15	23.18
			3	1	23.50	23.17	23.15	23.18
			3	2	23.50	23.17	23.14	23.18
			6	0	21.50	21.05	21.03	20.96
Band	Band Width	Modulation	RB Configuration		Tune-up	Channel/Frequency(MHz)		
			RB Size	RB Offset		20415/825.5	20525/836.5	20635/847.5
LTE Band V	3MHz	QPSK	1	0	23.50	23.04	22.99	23.09
			1	7	23.50	23.05	23.02	23.11
			1	14	23.50	23.00	23.02	23.05
			8	0	23.50	22.99	23.02	23.06
			8	4	23.50	22.98	22.02	22.05
			8	7	23.50	23.00	23.01	23.05

Band	Band Width	Modulation	RB Configuration		Tune-up	Channel/Frequency(MHz)		
			RB Size	RB Offset		20425/826.5	20525/836.5	20625/846.5
		16QAM	15	0	22.50	22.11	22.08	22.07
			1	0	23.50	22.64	22.60	22.07
			1	7	23.50	22.65	22.68	22.06
			1	14	23.50	22.56	22.66	22.06
			8	0	23.50	22.54	22.65	22.06
			8	4	23.50	22.56	22.65	22.06
			8	7	23.50	22.53	22.65	22.06
			15	0	22.50	21.15	21.16	21.12
Band	Band Width	Modulation	RB Configuration		Tune-up	Channel/Frequency(MHz)		
			RB Size	RB Offset		20450/829	20525/836.5	20600/844
LTE Band V	5MHz	QPSK	1	0	23.50	23.14	23.08	23.16
			1	12	23.50	23.11	23.13	23.18
			1	24	23.50	23.08	23.09	23.13
			12	0	22.50	22.16	22.12	22.14
			12	6	22.50	22.15	22.14	22.16
			12	11	22.50	22.15	22.14	22.15
		16QAM	1	0	23.50	22.16	22.10	22.30
			1	12	23.50	22.13	22.14	22.29
			1	24	23.50	22.09	22.12	22.29
			12	0	22.50	22.15	22.15	22.15
			12	6	22.50	22.15	22.14	22.15
			12	11	22.50	22.13	22.13	22.16
			25	0	21.50	21.15	21.16	21.04
Band	Band Width	Modulation	RB Configuration		Tune-up	Channel/Frequency(MHz)		
			RB Size	RB Offset		20450/829	20525/836.5	20600/844
LTE Band V	10MHz	QPSK	1	0	23.50	23.06	23.06	23.10
			1	24	23.50	23.10	23.06	23.20
			1	49	23.50	23.05	23.09	23.11
			25	0	23.50	23.07	23.04	23.09
			25	12	23.50	23.06	23.05	23.09
			25	24	23.50	23.04	23.10	23.08
			50	0	22.50	22.07	22.04	22.05
		16QAM	1	0	23.50	22.65	22.64	22.09
			1	24	23.50	22.64	22.71	22.12
			1	49	23.50	22.66	22.69	22.12



			25	0	22.50	22.05	22.11	22.08
			25	12	22.50	22.05	22.10	22.08
			25	24	22.50	22.05	22.11	22.08
			50	0	21.50	21.06	21.06	21.05

<LTE Band IV>

Band	Band Width	Modulation	RB Configuration		Tune-up	Channel/Frequency(MHz)		
			RB Size	RB Offset		19957/1710.7	20175/1732.5	20393/1754.3
LTE Band IV	1.4MHz	QPSK	1	0	23.00	22.31	22.40	22.41
			1	2	23.00	22.30	22.40	22.40
			1	5	23.00	22.32	22.43	22.39
			3	0	23.00	22.44	22.52	22.51
			3	1	23.00	22.41	22.52	22.51
			3	2	23.00	22.39	22.51	22.49
		16QAM	6	0	22.00	21.29	21.39	21.37
			1	0	22.00	21.39	21.46	21.48
			1	2	22.00	21.35	21.45	21.45
			1	5	22.00	21.38	21.49	21.47
			3	0	23.00	22.40	22.48	22.48
			3	1	23.00	22.42	22.51	22.49
			3	2	23.00	22.41	22.51	22.50
			6	0	21.00	20.34	20.46	20.33
Band	Band Width	Modulation	RB Configuration		Tune-up	Channel/Frequency(MHz)		
			RB Size	RB Offset		19965/1711.5	20175/1732.5	20385/1753.5
LTE Band IV	3MHz	QPSK	1	0	23.00	22.30	22.37	22.44
			1	7	23.00	22.34	22.42	22.45
			1	14	23.00	22.27	22.39	22.40
			8	0	23.00	22.28	22.39	22.40
			8	4	23.00	22.25	22.39	22.41
			8	7	23.00	22.28	22.39	22.40
			15	0	22.00	21.43	21.50	21.50
		16QAM	1	0	23.00	21.97	22.04	21.51
			1	7	23.00	22.00	22.09	21.50
			1	14	23.00	21.94	22.02	21.46
			8	0	23.00	21.92	22.02	21.46
8	4	23.00	21.92	22.05	21.46			

Band	Band Width	Modulation	RB Configuration		Tune-up	Channel/Frequency(MHz)		
			RB Size	RB Offset		19975/1712.5	20175/1732.5	20375/1752.5
			8	7	23.00	21.92	22.01	21.46
			15	0	21.00	20.52	20.60	20.58
Band	Band Width	Modulation	RB Configuration		Tune-up	Channel/Frequency(MHz)		
			RB Size	RB Offset		19975/1712.5	20175/1732.5	20375/1752.5
LTE Band IV	5MHz	QPSK	1	0	23.00	22.32	22.46	22.60
			1	12	23.00	22.34	22.49	22.56
			1	24	23.00	22.28	22.47	22.51
			12	0	22.00	21.43	21.55	21.61
			12	6	22.00	21.42	21.52	21.59
			12	11	22.00	21.42	21.56	21.57
			25	0	22.00	21.35	21.49	21.52
		16QAM	1	0	22.00	21.39	21.51	21.86
			1	12	22.00	21.38	21.55	21.81
			1	24	22.00	21.35	21.51	21.76
			12	0	22.00	21.42	21.57	21.56
			12	6	22.00	21.48	21.54	21.56
			12	11	22.00	21.42	21.57	21.55
			25	0	21.00	20.47	20.62	20.52
Band	Band Width	Modulation	RB Configuration		Tune-up	Channel/Frequency(MHz)		
			RB Size	RB Offset		20000/1715	20175/1732.5	20350/1750
LTE Band IV	10MHz	QPSK	1	0	23.00	22.33	22.40	22.52
			1	24	23.00	22.30	22.43	22.46
			1	49	23.00	22.35	22.34	22.39
			25	0	22.00	21.37	21.33	21.52
			25	12	22.00	21.35	21.43	21.51
			25	24	22.00	21.37	21.41	21.50
			50	0	22.00	21.39	21.40	21.54
		16QAM	1	0	23.00	22.00	22.06	22.16
			1	24	23.00	21.96	22.12	22.16
			1	49	23.00	22.00	22.17	22.05
			25	0	22.00	21.37	21.50	21.48
			25	12	22.00	21.38	21.49	21.46
			25	24	22.00	21.37	21.52	21.49
			50	0	21.00	20.41	20.53	20.56
Band	Band Width	Modulation	RB Configuration		Tune-up	Channel/Frequency(MHz)		
			RB Size	RB Offset		20000/1715	20175/1732.5	20350/1750



LTE Band II	1.4MHz	QPSK	1	0	23.00	22.15	22.54	22.64
			1	2	23.00	22.15	22.57	22.63
			1	5	23.00	22.16	22.59	22.67
			3	0	23.00	22.27	22.65	22.76
			3	1	23.00	22.26	22.67	22.75
			3	2	23.00	22.26	22.67	22.73
			6	0	22.00	21.09	21.51	21.63
		16QAM	1	0	22.00	21.21	21.69	21.64
			1	2	22.00	21.18	21.67	21.63
			1	5	22.00	21.24	21.74	21.68
			3	0	23.00	22.23	22.66	22.72
			3	1	23.00	22.25	22.66	22.71
			3	2	23.00	22.25	22.66	22.72
			6	0	21.00	20.08	20.56	20.67
Band	Band Width	Modulation	RB Configuration		Tune-up	Channel/Frequency(MHz)		
			RB Size	RB Offset		18615/1851.5	18900/1880	19185/1908.5
LTE Band II	3MHz	QPSK	1	0	23.00	22.11	22.48	22.66
			1	7	23.00	22.11	22.52	22.68
			1	14	23.00	22.09	22.52	22.62
			8	0	23.00	22.10	22.52	22.63
			8	4	23.00	22.13	22.52	22.62
			8	7	23.00	22.10	22.52	22.63
			15	0	22.00	21.20	21.58	21.68
		16QAM	1	0	23.00	21.78	22.11	21.68
			1	7	23.00	21.77	22.16	21.67
			1	14	23.00	21.73	22.13	21.63
			8	0	23.00	21.73	22.13	21.63
			8	4	23.00	21.73	22.14	22.63
			8	7	23.00	21.73	22.13	21.63
			15	0	21.00	20.27	20.69	20.79
Band	Band Width	Modulation	RB Configuration		Tune-up	Channel/Frequency(MHz)		
			RB Size	RB Offset		18625/1852.5	18900/1880	19175/1907.5
LTE Band II	5MHz	QPSK	1	0	23.00	22.17	22.59	22.76
			1	12	23.00	22.19	22.64	22.77
			1	24	23.00	22.14	22.60	22.71
			12	0	23.00	21.25	21.65	21.75

Band	Band Width	Modulation	RB Configuration		Tune-up	Channel/Frequency(MHz)		
			RB Size	RB Offset		18650/1855	18900/1880	19150/1905
		16QAM	12	6	23.00	22.25	22.65	22.74
			12	11	23.00	21.25	21.65	21.72
			25	0	22.00	21.21	21.59	21.69
			1	0	22.00	21.25	21.66	21.90
			1	12	22.00	21.24	21.67	21.93
			1	24	22.00	21.20	21.63	21.86
			12	0	22.00	21.25	21.64	21.72
			12	6	22.00	21.25	21.65	21.71
			12	11	22.00	21.25	21.65	21.72
			25	0	21.00	20.30	20.72	20.70
Band	Band Width	Modulation	RB Configuration		Tune-up	Channel/Frequency(MHz)		
			RB Size	RB Offset		18650/1855	18900/1880	19150/1905
LTE Band II	10MHz	QPSK	1	0	23.00	22.17	22.56	22.67
			1	24	23.00	22.12	22.58	22.65
			1	49	23.00	22.25	22.64	22.59
			25	0	22.00	21.20	21.60	21.67
			25	12	22.00	21.24	21.62	21.67
			25	24	22.00	21.25	21.63	21.68
			50	0	22.00	21.24	21.60	21.67
		16QAM	1	0	23.00	21.80	22.17	21.71
			1	24	23.00	21.78	22.19	21.61
			1	49	23.00	21.90	22.23	21.68
			25	0	22.00	21.25	21.62	21.68
			25	12	22.00	21.25	21.62	21.69
			25	24	22.00	21.24	21.63	21.68
			50	0	21.00	20.22	20.64	20.74
Band	Band Width	Modulation	RB Configuration		Tune-up	Channel/Frequency(MHz)		
			RB Size	RB Offset		18675/1857.5	18900/1880	19125/1902.5
LTE Band II	15MHz	QPSK	1	0	23.00	22.16	22.53	22.68
			1	37	23.00	22.20	22.60	22.71
			1	74	23.00	22.36	22.68	22.74
			36	0	22.00	21.22	21.61	21.73
			36	18	22.00	21.32	21.65	21.74
			36	37	22.00	21.38	21.69	21.75
			75	0	22.00	21.32	21.66	21.77
		16QAM	1	0	23.00	21.80	22.15	22.14

Band	Band Width	Modulation	RB Configuration		Tune-up	Channel/Frequency(MHz)		
			RB Size	RB Offset		18700/1860	18900/1880	19100/1900
			1	37	23.00	21.87	22.24	22.10
			1	74	23.00	21.98	22.30	22.10
			36	0	22.00	21.37	21.69	21.76
			36	18	22.00	21.38	21.69	21.75
			36	37	22.00	21.37	21.69	21.76
			75	0	21.00	20.30	20.67	20.75
LTE Band II	20MHz	QPSK	1	0	23.00	22.21	22.55	22.66
			1	49	23.00	22.30	22.63	22.67
			1	99	23.00	22.55	22.86	22.71
			50	0	23.00	22.26	22.57	22.69
			50	24	23.00	22.36	22.58	22.68
			50	49	23.00	22.42	22.68	22.80
			100	0	22.00	21.34	21.59	21.69
		16QAM	1	0	23.00	21.52	21.85	22.27
			1	49	23.00	21.67	21.96	22.22
			1	99	23.00	21.87	22.07	22.25
			50	0	22.00	21.42	21.68	21.69
			50	24	22.00	21.42	21.69	21.68
			50	49	22.00	21.42	21.68	21.70
			100	0	21.00	20.35	20.66	20.73

<LTE Band VII>

Band	Band Width	Modulation	RB Configuration		Tune-up	Channel/Frequency(MHz)		
			RB Size	RB Offset		20775/2502.5	21100/2535	21425/2567.5
LTE Band VII	5MHz	QPSK	1	0	24.00	23.48	23.61	23.43
			1	12	24.00	23.51	23.56	23.49
			1	24	24.00	23.48	23.57	23.52
			12	0	23.00	22.51	22.76	22.68
			12	6	23.00	22.53	22.68	22.66
			12	11	23.00	22.51	22.78	22.65
			25	0	23.00	22.46	22.72	22.43
		16QAM	1	0	22.00	21.19	21.69	21.59
			1	12	22.00	21.23	21.64	21.60
1	24		22.00	21.18	21.74	21.72		

Band	Band Width	Modulation	RB Configuration		Tune-up	Channel/Frequency(MHz)		
			RB Size	RB Offset		20800/2505	21100/2535	21400/2565
			12	0	23.00	22.51	22.76	22.64
			12	6	23.00	22.46	22.68	22.61
			12	11	23.00	22.53	22.78	22.64
			25	0	23.00	22.46	22.71	22.65
Band	Band Width	Modulation	RB Configuration		Tune-up	Channel/Frequency(MHz)		
			RB Size	RB Offset		20800/2505	21100/2535	21400/2565
LTE Band VII	10MHz	QPSK	1	0	23.00	22.32	22.56	22.50
			1	24	23.00	22.35	22.49	22.54
			1	49	23.00	22.31	22.48	22.51
			25	0	23.00	22.47	22.52	22.46
			25	12	23.00	22.49	22.59	22.48
			25	24	23.00	22.52	22.68	22.48
			50	0	23.00	22.51	22.64	22.51
		16QAM	1	0	23.00	22.19	21.92	21.44
			1	24	23.00	22.50	22.25	21.20
			1	49	23.00	22.43	22.42	21.24
			25	0	23.00	22.46	22.51	22.38
			25	12	23.00	22.51	22.64	22.39
			25	24	23.00	22.53	22.67	22.46
			50	0	23.00	22.51	22.63	22.58
Band	Band Width	Modulation	RB Configuration		Tune-up	Channel/Frequency(MHz)		
			RB Size	RB Offset		20825/2507.5	21100/2535	21375/2562.5
LTE Band VII	15MHz	QPSK	1	0	23.00	22.35	22.00	22.12
			1	37	23.00	22.46	22.23	21.18
			1	74	23.00	22.34	22.66	21.39
			36	0	22.00	21.65	21.31	20.86
			36	18	22.00	21.34	21.15	20.82
			36	37	22.00	21.69	21.77	20.50
			75	0	22.00	21.69	21.57	20.68
		16QAM	1	0	23.00	22.29	21.95	22.07
			1	37	23.00	22.45	22.21	21.17
			1	74	23.00	22.32	22.66	21.39
			36	0	22.00	21.63	21.27	20.85
			36	18	22.00	21.65	21.63	20.51
			36	37	22.00	21.68	21.78	20.51
			75	0	22.00	21.68	21.55	20.69

Band	Band Width	Modulation	RB Configuration		Tune-up	Channel/Frequency(MHz)		
			RB Size	RB Offset		20850/2510	21100/2535	21350/2560
LTE Band VII	20MHz	QPSK	1	0	24.00	23.37	23.01	23.46
			1	49	24.00	23.39	23.24	22.45
			1	99	24.00	23.17	23.67	22.42
			50	0	23.00	22.62	22.26	22.25
			50	24	23.00	22.53	22.59	21.73
			50	49	23.00	22.46	22.83	21.57
			100	0	23.00	22.58	22.61	21.94
		16QAM	1	0	23.00	22.32	21.96	22.46
			1	49	23.00	22.41	22.21	21.45
			1	99	23.00	22.22	22.68	21.43
			50	0	22.00	21.65	21.23	21.27
			50	24	22.00	21.33	21.06	21.20
			50	49	22.00	21.50	21.61	20.57
			100	0	22.00	21.60	21.60	20.95



### 7.5. Wi-Fi & BT Output Power

#### 7.5.1. Output Power Results Of Wi-Fi

The output power of Wi-Fi is as following:

Mode	Channel	Frequency (MHz)	Tune-up	Output Power (dBm)
802.11b	1	2412	15.50	15.10
	6	2437	15.50	14.70
	11	2462	15.50	15.30
802.11g	1	2412	13.50	12.50
	6	2437	13.50	12.50
	11	2462	13.50	12.80
802.11n (HT20)	1	2412	13.50	12.80
	6	2437	13.50	12.30
	11	2462	13.50	12.80
802.11n (HT40)	3	2422	13.50	13.30
	6	2437	13.50	12.30
	9	2452	13.50	13.40

#### 7.5.2. Output Power Results Of BT

The output power of BT is as following:

BT(3.0)	Output Power (dBm)				
	Channel	Tune-up	Data Rates		
			1M	2M	3M
	0CH	3.00	2.23	1.25	1.61
	39CH	4.00	3.87	2.65	3.04
	78CH	3.00	2.56	1.33	1.70

BT(4.0)	Channel	Tune-up	Output Power (dBm)
	0CH	4.00	2.11
	19CH	4.00	3.72
	39CH	4.00	2.42

### 8. Antenna Location

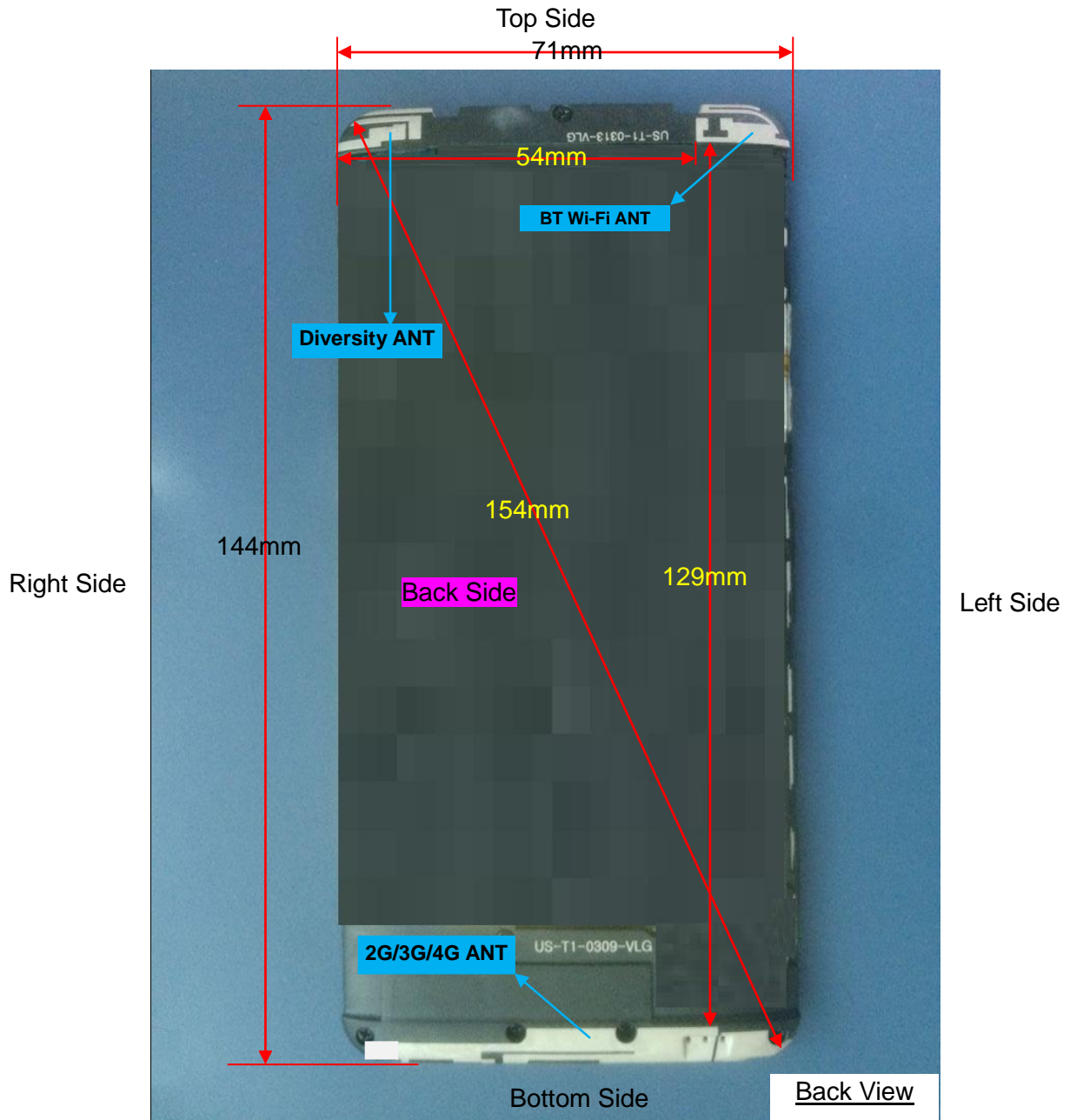

Distance of the Antenna to the EUT surface/edge						
Antennas	Front Side	Back Side	Left Side	Right Side	Top Side	Bottom Side
WWAN Main	≤ 25mm	≤ 25mm	≤ 25mm	≤ 25mm	>25mm	≤ 25mm
WLAN & BT	≤ 25mm	≤ 25mm	≤ 25mm	>25mm	≤ 25mm	>25mm

Positions for SAR tests						
Antennas	Front Side	Back Side	Left Side	Right Side	Top Side	Bottom Side
WWAN Main	Yes	Yes	Yes	Yes	NO	Yes
WLAN & BT	Yes	Yes	Yes	NO	Yes	NO

### 9. Stand-alone SAR test exclusion

Per FCC KDB 447498D01, the 1-g SAR and 10-g SAR test exclusion thresholds for 100 MHz to 6 GHz at test separation distances  $\leq 50$  mm are determined by:

$[(\text{max. power of channel, including tune-up tolerance, mW})/(\text{min. test separation distance, mm})] \cdot [\sqrt{f_{\text{(GHz)}}}] \leq 3.0$  for 1-g SAR and  $\leq 7.5$  for 10-g extremity SAR, where:

- $f_{\text{(GHz)}}$  is the RF channel transmit frequency in GHz
- Power and distance are rounded to the nearest mW and mm before calculation
- The result is rounded to one decimal place for comparison

When the minimum test separation distance is  $< 5$  mm, a distance of 5 mm is applied to determine SAR test exclusion.

Mode	$P_{\text{max}}$ (dBm)	$P_{\text{max}}$ (mW)	Distance (mm)	f (GHz)	Calculation Result	SAR Exclusion threshold	SAR test exclusion
BT	4	2.51	5	2.480	0.8	3.0	Yes

NOTE: Standalone SAR test exclusion for BT

When standalone SAR test exclusion applies to an antenna that transmits simultaneously with other antennas, the standalone SAR must be estimated according to following to determine simultaneous transmission SAR test exclusion:

$[(\text{max. power of channel, including tune-up tolerance, mW})/(\text{min. test separation distance, mm})] \cdot [\sqrt{f_{\text{(GHz)}}/x}] \text{ W/kg}$  for test separation distances  $\leq 50\text{mm}$ , where  $x = 7.5$  for 1-g SAR and  $x = 18.75$  for 10-g SAR.

When the minimum test separation distance is  $< 5$  mm, a distance of 5 mm is applied to determine SAR test exclusion.

Mode	Position	$P_{\text{max}}$ (dBm)	$P_{\text{max}}$ (mW)	Distance (mm)	f (GHz)	x	Estimated SAR (W/Kg)
BT	Head	4	2.51	5	2.480	7.5	0.105
BT	Body	4	2.51	10	2.480	7.5	0.053
BT	Hotspot	4	2.51	10	2.480	7.5	0.053

NOTE: Estimated SAR calculation for BT

## 10. SAR Measurement Results

### 10.1. SAR measurement results

General Notes:

- 1) Per KDB447498 D01, all measurement SAR results are scaled to the maximum tune-up tolerance limit to demonstrate compliant.
- 2) Per KDB447498 D01, testing of other required channels within the operating mode of a frequency band is not required when the reported 1-g or 10-g SAR for the mid-band or highest output power channel is:  $\leq 0.8$  W/kg or  $2.0$  W/kg, for 1-g or 10-g respectively, when the transmission band is  $\leq 100$  MHz. When the maximum output power variation across the required test channels is  $> \frac{1}{2}$  dB, instead of the middle channel, the highest output power channel must be used.
- 3) Per KDB865664 D01, for each frequency band, repeated SAR measurement is required only when the measured SAR is  $\geq 0.8$ W/Kg; if the deviation among the repeated measurement is  $\leq 20\%$ , and the measured SAR  $< 1.45$ W/Kg, only one repeated measurement is required.
- 4) Per KDB648474 D04, SAR is evaluated without a headset connected to the device. When the standalone reported Body-Worn SAR is  $\leq 1.2$  W/kg, no additional SAR evaluations using a headset are required.
- 5) Per KDB865664 D02, SAR plot is only required for the highest measured SAR in each exposure configuration, wireless mode and frequency band combination; Plots are also required when the measured SAR is  $> 1.5$  W/kg, or  $> 7.0$  W/kg for occupational exposure. The published RF exposure KDB procedures may require additional plots; for example, to support SAR to peak location separation ratio test exclusion and/or volume scan post-processing(Refer to appendix C for details).
- 6) Per KDB 941225 D05, start with the largest channel bandwidth and measure SAR for QPSK with 1 RB allocation, using the RB offset and required test channel combination with the highest maximum output power for RB offsets at the upper edge, middle and lower edge of each required test channel.
- 7) Per KDB 941225 D05, 50% RB allocation for QPSK SAR testing follows 1RB QPSK allocation procedure.
- 8) Per KDB 941225 D05, For QPSK with 100% RB allocation, SAR is not required when the highest maximum output power for 100 % RB allocation is less than the highest maximum output power in 50% and 1 RB allocations and the highest reported SAR for 1 RB and 50% RB allocation are  $\leq 0.8$  W/kg. Otherwise, SAR is measured for the highest output power channel; and if the reported SAR is  $> 1.45$  W/kg, the remaining required test channels must also be tested.
- 9) Per KDB 941225 D05, 16QAM output power for each RB allocation configuration is  $>$  not  $\frac{1}{2}$  dB higher than the same configuration in QPSK and the reported SAR for the QPSK configuration is  $\leq 1.45$  W/kg; Per KDB 941225 D05, 16QAM SAR testing is not required.
- 10) Per KDB 941225 D05, Smaller bandwidth output power for each RB allocation configuration is  $>$  not  $\frac{1}{2}$  dB higher than the same configuration in the largest supported bandwidth, and the reported SAR for the largest supported bandwidth is  $\leq 1.45$  W/kg; Per KDB 941225 D05, smaller bandwidth SAR testing is not required.

**10.1.1. SAR measurement Result of GSM850**

Test Position of Head	Test channel /Freq.	Test Mode	SAR Value (W/kg)		Power Drift (±5%)	Conducted power (dBm)	Tune-up power (dBm)	Scaled SAR 1g (W/Kg)
			1g	10g				
Left Cheek	189/836.4	GPRS(GMSK 4TS)	0.089	0.067	1.91	28.95	30.00	0.113
Left Tilt 15 Degree	189/836.4	GPRS(GMSK 4TS)	0.051	0.039	0.03	28.95	30.00	0.065
Right Cheek	189/836.4	GPRS(GMSK 4TS)	0.110	0.078	-4.92	28.95	30.00	0.140
Right Tilt 15 Degree	189/836.4	GPRS(GMSK 4TS)	0.016	0.013	1.83	28.95	30.00	0.020

NOTE: Head SAR test results of GSM850.

Test Position of Body-Worn with 10mm	Test channel /Freq.	Test Mode	SAR Value (W/kg)		Power Drift (±5%)	Conducted power (dBm)	Tune-up power (dBm)	Scaled SAR 1g (W/Kg)
			1g	10g				
Front Side	189/836.4	GPRS(GMSK 4TS)	0.106	0.077	-1.45	28.95	30.00	0.135
Back Side	189/836.4	GPRS(GMSK 4TS)	0.179	0.100	-2.54	28.95	30.00	0.228

NOTE: Body-Worn SAR test results of GSM850

Test Position of Hotspot with 10mm	Test channel /Freq.	Test Mode	SAR Value (W/kg)		Power Drift (±5%)	Conducted power (dBm)	Tune-up power (dBm)	Scaled SAR 1g (W/Kg)
			1g	10g				
Front Side	189/836.4	GPRS(GMSK 4TS)	0.106	0.077	-1.45	28.95	30.00	0.135
Back Side	189/836.4	GPRS(GMSK 4TS)	0.179	0.100	-2.54	28.95	30.00	0.228
Left Side	189/836.4	GPRS(GMSK 4TS)	0.026	0.017	-3.23	28.95	30.00	0.033
Right Side	189/836.4	GPRS(GMSK 4TS)	0.157	0.105	-1.18	28.95	30.00	0.200
Bottom Side	189/836.4	GPRS(GMSK 4TS)	0.090	0.050	0.56	28.95	30.00	0.115

NOTE: Hotspot SAR test results of GSM850

**10.1.2. SAR measurement Result of GSM1900**

Test Position of Head	Test channel /Freq.	Test Mode	SAR Value (W/kg)		Power Drift (±5%)	Conducted power (dBm)	Tune-up power (dBm)	Scaled SAR 1g (W/Kg)
			1g	10g				
Left Cheek	810/1909.8	GPRS(GMSK 4TS)	0.073	0.043	-1.34	26.33	27.00	0.085
Left Tilt 15 Degree	810/1909.8	GPRS(GMSK 4TS)	0.029	0.016	-1.29	26.33	27.00	0.034
Right Cheek	810/1909.8	GPRS(GMSK 4TS)	0.124	0.074	1.48	26.33	27.00	0.145
Right Tilt 15 Degree	810/1909.8	GPRS(GMSK 4TS)	0.041	0.025	-2.91	26.33	27.00	0.048

NOTE: Head SAR test results of GSM1900

Test Position of Body-Worn with 10mm	Test channel /Freq.	Test Mode	SAR Value (W/kg)		Power Drift (±5%)	Conducted power (dBm)	Tune-up power (dBm)	Scaled SAR 1g (W/Kg)
			1g	10g				
Front Side	810/1909.8	GPRS(GMSK 4TS)	0.441	0.235	1.83	26.33	27.00	0.515
Back Side	810/1909.8	GPRS(GMSK 4TS)	0.531	0.274	-0.31	26.33	27.00	0.620

NOTE: Body-Worn SAR test results of GSM1900

Test Position of Hotspot with 10mm	Test channel /Freq.	Test Mode	SAR Value (W/kg)		Power Drift (±5%)	Conducted power (dBm)	Tune-up power (dBm)	Scaled SAR 1g (W/Kg)
			1g	10g				
Front Side	810/1909.8	GPRS(GMSK 4TS)	0.441	0.235	1.83	26.33	27.00	0.515
Back Side	810/1909.8	GPRS(GMSK 4TS)	0.531	0.274	-0.31	26.33	27.00	0.620
Left Side	810/1909.8	GPRS(GMSK 4TS)	0.031	0.024	-1.28	26.33	27.00	0.036
Right Side	810/1909.8	GPRS(GMSK 4TS)	0.129	0.071	-3.53	26.33	27.00	0.151
Bottom Side	810/1909.8	GPRS(GMSK 4TS)	0.549	0.282	-4.20	26.33	27.00	0.641

NOTE: Hotspot SAR test results of GSM1900

**10.1.3. SAR measurement Result of WCDMA Band V**

Test Position of Head	Test channel /Freq.	Test Mode	SAR Value (W/kg)		Power Drift (±5%)	Conducted power (dBm)	Tune-up power (dBm)	Scaled SAR 1g (W/Kg)
			1g	10g				
Left Cheek	4233/846.6	RMC12.2K	0.084	0.064	-0.90	22.71	23.00	0.090
Left Tilt 15 Degree	4233/846.6	RMC12.2K	0.073	0.051	-1.61	22.71	23.00	0.078
Right Cheek	4233/846.6	RMC12.2K	0.109	0.083	-0.66	22.71	23.00	0.117
Right Tilt 15 Degree	4233/846.6	RMC12.2K	0.086	0.059	-3.15	22.71	23.00	0.092

NOTE: Head SAR test results of WCDMA Band V

Test Position of Body-Worn with 10mm	Test channel /Freq.	Test Mode	SAR Value (W/kg)		Power Drift (±5%)	Conducted power (dBm)	Tune-up power (dBm)	Scaled SAR 1g (W/Kg)
			1g	10g				
Front Side	4233/846.6	RMC12.2K	0.096	0.070	0.35	22.71	23.00	0.103
Back Side	4233/846.6	RMC12.2K	0.158	0.091	0.78	22.71	23.00	0.169

NOTE: Body-Worn SAR test results of WCDMA Band V

Test Position of Hotspot with 10mm	Test channel /Freq.	Test Mode	SAR Value (W/kg)		Power Drift (±5%)	Conducted power (dBm)	Tune-up power (dBm)	Scaled SAR 1g (W/Kg)
			1g	10g				
Front Side	4233/846.6	RMC12.2K	0.096	0.070	0.35	22.71	23.00	0.103
Back Side	4233/846.6	RMC12.2K	0.158	0.091	0.78	22.71	23.00	0.169
Left Side	4233/846.6	RMC12.2K	0.068	0.042	-3.25	22.71	23.00	0.073
Right Side	4233/846.6	RMC12.2K	0.110	0.075	-0.33	22.71	23.00	0.118
Bottom Side	4233/846.6	RMC12.2K	0.078	0.045	4.61	22.71	23.00	0.083

NOTE: Hotspot SAR test results of WCDMA Band V

**10.1.4. SAR measurement Result of WCDMA Band II**

Test Position of Head	Test channel /Freq.	Test Mode	SAR Value (W/kg)		Power Drift (±5%)	Conducted power (dBm)	Tune-up power (dBm)	Scaled SAR 1g (W/Kg)
			1g	10g				
Left Cheek	9400/1880	RMC12.2K	0.106	0.067	-3.81	22.63	23.00	0.115
Left Tilt 15 Degree	9400/1880	RMC12.2K	0.035	0.022	-1.28	22.63	23.00	0.038
Right Cheek	9400/1880	RMC12.2K	0.190	0.116	2.25	22.63	23.00	0.207
Right Tilt 15 Degree	9400/1880	RMC12.2K	0.049	0.030	-0.99	22.63	23.00	0.053

NOTE: Head SAR test results of WCDMA Band II

Test Position of Body-Worn with 10mm	Test channel /Freq.	Test Mode	SAR Value (W/kg)		Power Drift (±5%)	Conducted power (dBm)	Tune-up power (dBm)	Scaled SAR 1g (W/Kg)
			1g	10g				
Front Side	9400/1880	RMC12.2K	0.592	0.325	1.12	22.63	23.00	0.645
Back Side	9400/1880	RMC12.2K	0.777	0.408	-0.39	22.63	23.00	0.846
Back Side	9262/1852.4	RMC12.2K	0.870	0.468	0.25	22.45	23.00	0.987
Back Side-Repeated	9262/1852.4	RMC12.2K	0.860	0.463	-0.73	22.45	23.00	0.976
Back Side	9538/1907.6	RMC12.2K	0.638	0.328	-0.33	22.58	23.00	0.703

NOTE: Body-Worn SAR test results of WCDMA Band II

Test Position of Hotspot with 10mm	Test channel /Freq.	Test Mode	SAR Value (W/kg)		Power Drift (±5%)	Conducted power (dBm)	Tune-up power (dBm)	Scaled SAR 1g (W/Kg)
			1g	10g				
Front Side	9400/1880	RMC12.2K	0.592	0.325	1.12	22.63	23.00	0.645
Back Side	9400/1880	RMC12.2K	0.777	0.408	-0.39	22.63	23.00	0.846
Left Side	9400/1880	RMC12.2K	0.142	0.081	-3.12	22.63	23.00	0.155
Right Side	9400/1880	RMC12.2K	0.163	0.094	-0.82	22.63	23.00	0.177
Bottom Side	9400/1880	RMC12.2K	0.803	0.418	-0.34	22.63	23.00	0.874
Back Side	9262/1852.4	RMC12.2K	0.870	0.468	0.25	22.45	23.00	0.987
Back Side-Repeated	9262/1852.4	RMC12.2K	0.860	0.463	-0.73	22.45	23.00	0.976
Back Side	9538/1907.6	RMC12.2K	0.638	0.328	-0.33	22.58	23.00	0.703
Bottom Side	9262/1852.4	RMC12.2K	0.850	0.449	0.80	22.45	23.00	0.965
Bottom Side	9538/1907.6	RMC12.2K	0.723	0.371	0.40	22.58	23.00	0.796

NOTE: Hotspot SAR test results of WCDMA Band II



**10.1.5. SAR measurement Result of LTE Band V**

Test Position of Head	Test channel /Freq.	Test Mode	SAR Value (W/kg)		Power Drift (±5%)	Conducted power (dBm)	Tune-up power (dBm)	Scaled SAR 1g (W/Kg)
			1g	10g				
<b>1RB</b>								
Left Cheek	20600/844	10M QPSK(1,24)	0.083	0.064	3.08	23.20	23.50	0.089
Left Tilt 15 Degree	20600/844	10M QPSK(1,24)	0.053	0.032	-1.94	23.20	23.50	0.057
Right Cheek	20600/844	10M QPSK(1,24)	0.101	0.075	-3.50	23.20	23.50	0.108
Right Tilt 15 Degree	20600/844	10M QPSK(1,24)	0.069	0.041	-1.35	23.20	23.50	0.074
<b>50%RB</b>								
Left Cheek	20525/836.5	10M QPSK(25,24)	0.064	0.045	4.25	23.10	23.50	0.070
Left Tilt 15 Degree	20525/836.5	10M QPSK(25,24)	0.038	0.025	-2.61	23.10	23.50	0.042
Right Cheek	20525/836.5	10M QPSK(25,24)	0.071	0.051	1.61	23.10	23.50	0.078
Right Tilt 15 Degree	20525/836.5	10M QPSK(25,24)	0.046	0.032	-3.28	23.10	23.50	0.050

NOTE: Head SAR test results of LTE Band V

Test Position of Body-Worn with 10mm	Test channel /Freq.	Test Mode	SAR Value (W/kg)		Power Drift (±5%)	Conducted power (dBm)	Tune-up power (dBm)	Scaled SAR 1g (W/Kg)
			1g	10g				
<b>1RB</b>								
Front Side	20600/844	10M QPSK(1,24)	0.118	0.090	-0.12	23.20	23.50	0.126
Back Side	20600/844	10M QPSK(1,24)	0.161	0.119	0.53	23.20	23.50	0.173
<b>50%RB</b>								
Front Side	20525/836.5	10M QPSK(25,24)	0.082	0.057	-1.36	23.10	23.50	0.090
Back Side	20525/836.5	10M	0.105	0.069	-2.16	23.10	23.50	0.115

		QPSK(25,24)						
--	--	-------------	--	--	--	--	--	--

NOTE: Body-Worn SAR test results of LTE Band V

Test Position of Hotspot with 10mm	Test channel /Freq.	Test Mode	SAR Value (W/kg)		Power Drift (±5%)	Conducted power (dBm)	Tune-up power (dBm)	Scaled SAR 1g (W/Kg)
			1g	10g				
1RB								
Front Side	20600/844	10M QPSK(1,24)	0.118	0.090	-0.12	23.20	23.50	0.126
Back Side	20600/844	10M QPSK(1,24)	0.161	0.119	0.53	23.20	23.50	0.173
Left Side	20600/844	10M QPSK(1,24)	0.046	0.033	-0.54	23.20	23.50	0.049
Right Side	20600/844	10M QPSK(1,24)	0.151	0.106	1.96	23.20	23.50	0.162
Bottom Side	20600/844	10M QPSK(1,24)	0.070	0.043	1.77	23.20	23.50	0.075
50%RB								
Front Side	20525/836.5	10M QPSK(25,24)	0.082	0.057	-1.36	23.10	23.50	0.090
Back Side	20525/836.5	10M QPSK(25,24)	0.105	0.069	-2.16	23.10	23.50	0.115
Left Side	20525/836.5	10M QPSK(25,24)	0.030	0.021	2.18	23.10	23.50	0.033
Right Side	20525/836.5	10M QPSK(25,24)	0.103	0.065	-1.29	23.10	23.50	0.113
Bottom Side	20525/836.5	10M QPSK(25,24)	0.043	0.029	-2.46	23.10	23.50	0.047

NOTE: Hotspot SAR test results of LTE Band V

**10.1.6. SAR measurement Result of LTE Band IV**

Test Position of Head	Test channel /Freq.	Test Mode	SAR Value (W/kg)		Power Drift (±5%)	Conducted power (dBm)	Tune-up power (dBm)	Scaled SAR 1g (W/Kg)
			1g	10g				
1RB								
Left Cheek	20175/1732.5	20M QPSK(1,99)	0.168	0.108	-2.63	22.63	23.00	0.183

Left Tilt 15 Degree	20175/1732.5	20M QPSK(1,99)	0.056	0.032	-1.57	22.63	23.00	0.061
Right Cheek	20175/1732.5	20M QPSK(1,99)	0.232	0.154	-0.34	22.63	23.00	0.253
Right Tilt 15 Degree	20175/1732.5	20M QPSK(1,99)	0.108	0.072	2.64	22.63	23.00	0.118
50%RB								
Left Cheek	20175/1732.5	20M QPSK(50,49)	0.147	0.094	2.15	22.57	23.00	0.162
Left Tilt 15 Degree	20175/1732.5	20M QPSK(50,49)	0.051	0.028	1.39	22.57	23.00	0.056
Right Cheek	20175/1732.5	20M QPSK(50,49)	0.203	0.129	1.07	22.57	23.00	0.224
Right Tilt 15 Degree	20175/1732.5	20M QPSK(50,49)	0.095	0.067	3.14	22.57	23.00	0.105

NOTE: Head SAR test results of LTE Band IV

Test Position of Body-Worn with 10mm	Test channel /Freq.	Test Mode	SAR Value (W/kg)		Power Drift (±5%)	Conduc ted power (dBm)	Tune-u p power (dBm)	Scaled SAR 1g (W/Kg)
			1g	10g				
1RB								
Front Side	20175/1732. 5	20M QPSK(1,99)	0.441	0.257	0.56	22.63	23.00	0.480
Back Side	20175/1732. 5	20M QPSK(1,99)	0.530	0.303	0.25	22.63	23.00	0.577
50%RB								
Front Side	20175/1732. 5	20M QPSK (50,49)	0.410	0.172	0.06	22.57	23.00	0.453
Back Side	20175/1732. 5	20M QPSK (50,49)	0.437	0.248	-2.82	22.57	23.00	0.482

NOTE: Body-Worn SAR test results of LTE Band IV

Test Position of Hotspot with 10mm	Test channel /Freq.	Test Mode	SAR Value (W/kg)		Power Drift (±5%)	Conduc ted power (dBm)	Tune-u p power (dBm)	Scaled SAR 1g (W/Kg)
			1g	10g				

1RB								
Front Side	20175/1732. 5	20M QPSK(1,99)	0.441	0.257	0.56	22.63	23.00	0.480
Back Side	20175/1732. 5	20M QPSK(1,99)	0.530	0.303	0.25	22.63	23.00	0.577
Left Side	20175/1732. 5	20M QPSK(1,99)	0.128	0.079	2.15	22.63	23.00	0.139
Right Side	20175/1732. 5	20M QPSK(1,99)	0.256	0.149	-3.54	22.63	23.00	0.279
Bottom Side	20175/1732. 5	20M QPSK(1,99)	0.469	0.261	-1.16	22.63	23.00	0.511
50%RB								
Front Side	20175/1732. 5	20M QPSK (50,49)	0.410	0.172	0.06	22.57	23.00	0.453
Back Side	20175/1732. 5	20M QPSK (50,49)	0.437	0.248	-2.82	22.57	23.00	0.482
Left Side	20175/1732. 5	20M QPSK (50,49)	0.102	0.065	-1.35	22.57	23.00	0.113
Right Side	20175/1732. 5	20M QPSK (50,49)	0.230	0.149	1.15	22.57	23.00	0.254
Bottom Side	20175/1732. 5	20M QPSK (50,49)	0.384	0.201	-2.16	22.57	23.00	0.424

NOTE: Hotspot SAR test results of LTE Band IV

**10.1.7. SAR measurement Result of LTE Band II**

Test Position of Head	Test channel /Freq.	Test Mode	SAR Value (W/kg)		Power Drift (±5%)	Conducted power (dBm)	Tune-up power (dBm)	Scaled SAR 1g (W/Kg)
			1g	10g				
1RB								
Left Cheek	18900/1880	20M QPSK(1,99)	0.100	0.060	-3.21	22.86	23.00	0.103
Left Tilt 15 Degree	18900/1880	20M QPSK(1,99)	0.034	0.022	-1.94	22.86	23.00	0.035
Right Cheek	18900/1880	20M QPSK(1,99)	0.197	0.119	-0.62	22.86	23.00	0.203
Right Tilt 15 Degree	18900/1880	20M QPSK(1,99)	0.049	0.031	-2.18	22.86	23.00	0.051

50%RB								
Left Cheek	19100/1900	20M QPSK(50,49)	0.082	0.049	-2.16	22.80	23.00	0.086
Left Tilt 15 Degree	19100/1900	20M QPSK(50,49)	0.026	0.018	-1.18	22.80	23.00	0.027
Right Cheek	19100/1900	20M QPSK(50,49)	0.148	0.090	-0.29	22.80	23.00	0.155
Right Tilt 15 Degree	19100/1900	20M QPSK(50,49)	0.043	0.025	-2.40	22.80	23.00	0.045

NOTE: Head SAR test results of LTE Band II

Test Position of Body-Worn with 10mm	Test channel /Freq.	Test Mode	SAR Value (W/kg)		Power Drift (±5%)	Conducted power (dBm)	Tune-up power (dBm)	Scaled SAR 1g (W/Kg)
			1g	10g				
1RB								
Front Side	18900/1880	20M QPSK(1,99)	0.666	0.364	-1.27	22.86	23.00	0.688
Back Side	18900/1880	20M QPSK(1,99)	0.788	0.423	-0.91	22.86	23.00	0.814
Back Side	18700/1860	20M QPSK(1,99)	0.828	0.451	0.78	22.55	23.00	0.918
Back Side-Repeated	18700/1860	20M QPSK(1,99)	0.816	0.452	2.13	22.55	23.00	0.905
Back Side	19100/1900	20M QPSK(1,99)	0.701	0.373	-0.70	22.71	23.00	0.749
50%RB								
Front Side	19100/1900	20M QPSK (50,49)	0.415	0.284	-2.38	22.80	23.00	0.435
Back Side	19100/1900	20M QPSK (50,49)	0.591	0.313	-1.03	22.80	23.00	0.619
100%RB								
Back Side	19100/1900	20M QPSK (100,0)	0.562	0.287	1.57	21.69	22.00	0.604

NOTE: Body-Worn SAR test results of LTE Band II

Test Position of Hotspot with 10mm	Test channel /Freq.	Test Mode	SAR Value (W/kg)		Power Drift (±5%)	Conducted power (dBm)	Tune-up power (dBm)	Scaled SAR 1g (W/Kg)
			1g	10g				
1RB								
Front Side	18900/1880	20M	0.666	0.364	-1.27	22.86	23.00	0.688

		QPSK(1,99)						
Back Side	18900/1880	20M QPSK(1,99)	0.788	0.423	-0.91	22.86	23.00	0.814
Left Side	18900/1880	20M QPSK(1,99)	0.081	0.047	-4.49	22.86	23.00	0.084
Right Side	18900/1880	20M QPSK(1,99)	0.183	0.104	-0.43	22.86	23.00	0.189
Bottom Side	18900/1880	20M QPSK(1,99)	0.268	0.145	-2.97	22.86	23.00	0.277
Back Side	18700/1860	20M QPSK(1,99)	0.828	0.451	0.78	22.55	23.00	0.918
Back Side-Repeated	18700/1860	20M QPSK(1,99)	0.816	0.452	2.13	22.55	23.00	0.905
Back Side	19100/1900	20M QPSK(1,99)	0.701	0.373	-0.70	22.71	23.00	0.749
50%RB								
Front Side	19100/1900	20M QPSK (50,49)	0.415	0.284	-2.38	22.80	23.00	0.435
Back Side	19100/1900	20M QPSK (50,49)	0.591	0.313	-1.03	22.80	23.00	0.619
Left Side	19100/1900	20M QPSK (50,49)	0.065	0.041	2.22	22.80	23.00	0.068
Right Side	19100/1900	20M QPSK (50,49)	0.135	0.076	1.54	22.80	23.00	0.141
Bottom Side	19100/1900	20M QPSK (50,49)	0.213	0.129	2.31	22.80	23.00	0.223
100%RB								
Back Side	19100/1900	20M QPSK (100,0)	0.562	0.287	1.57	21.69	22.00	0.604

NOTE: Hotspot SAR test results of LTE Band II

**10.1.8. SAR measurement Result of LTE Band VII**

Test Position of Head	Test channel /Freq.	Test Mode	SAR Value (W/kg)		Power Drift (±5%)	Conducted power (dBm)	Tune-up power (dBm)	Scaled SAR 1g (W/Kg)
			1g	10g				
1RB								
Left Cheek	21100/2535	20M QPSK(1,99)	0.337	0.148	-3.34	23.67	24.00	0.364

Left Tilt 15 Degree	21100/2535	20M QPSK(1,99)	0.105	0.058	1.84	23.67	24.00	0.113
Right Cheek	21100/2535	20M QPSK(1,99)	0.104	0.056	-4.58	23.67	24.00	0.112
Right Tilt 15 Degree	21100/2535	20M QPSK(1,99)	0.054	0.031	2.61	23.67	24.00	0.058
50%RB								
Left Cheek	21100/2535	20M QPSK(50,49)	0.229	0.117	-1.82	22.83	23.00	0.238
Left Tilt 15 Degree	21100/2535	20M QPSK(50,49)	0.095	0.058	3.14	22.83	23.00	0.099
Right Cheek	21100/2535	20M QPSK(50,49)	0.100	0.054	-1.39	22.83	23.00	0.104
Right Tilt 15 Degree	21100/2535	20M QPSK(50,49)	0.057	0.032	1.51	22.83	23.00	0.059

NOTE: Head SAR test results of LTE Band VII

Test Position of Body-Worn with 10mm	Test channel /Freq.	Test Mode	SAR Value (W/kg)		Power Drift (±5%)	Conduc ted power (dBm)	Tune-u p power (dBm)	Scaled SAR 1g (W/Kg)
			1g	10g				
1RB								
Front Side	21100/2535	20M QPSK(1,99)	0.229	0.126	0.53	23.67	24.00	0.247
Back Side	21100/2535	20M QPSK(1,99)	0.262	0.132	0.16	23.67	24.00	0.283
50%RB								
Front Side	21100/2535	20M QPSK(50,49)	0.232	0.128	0.79	22.83	23.00	0.241
Back Side	21100/2535	20M QPSK(50,49)	0.262	0.134	-0.67	22.83	23.00	0.272

NOTE: Body-Worn SAR test results of LTE Band VII

Test Position of Hotspot with 10mm	Test channel /Freq.	Test Mode	SAR Value (W/kg)		Power Drift (±5%)	Conduc ted power (dBm)	Tune-u p power (dBm)	Scaled SAR 1g (W/Kg)
			1g	10g				
1RB								
Front Side	21100/2535	20M	0.229	0.126	0.53	23.67	24.00	0.247

		QPSK(1,99)						
Back Side	21100/2535	20M QPSK(1,99)	0.262	0.132	0.16	23.67	24.00	0.283
Left Side	21100/2535	20M QPSK(1,99)	0.187	0.101	-2.33	23.67	24.00	0.202
Right Side	21100/2535	20M QPSK(1,99)	0.041	0.023	0.19	23.67	24.00	0.044
Bottom Side	21100/2535	20M QPSK(1,99)	0.396	0.199	-1.82	23.67	24.00	0.427
50%RB								
Front Side	21100/2535	20M QPSK(50,49)	0.232	0.128	0.79	22.83	23.00	0.241
Back Side	21100/2535	20M QPSK(50,49)	0.261	0.134	-0.67	22.83	23.00	0.271
Left Side	21100/2535	20M QPSK(50,49)	0.176	0.100	-1.94	22.83	23.00	0.183
Right Side	21100/2535	20M QPSK(50,49)	0.038	0.022	1.58	22.83	23.00	0.040
Bottom Side	21100/2535	20M QPSK(50,49)	0.354	0.184	-0.38	22.83	23.00	0.368

NOTE: Hotspot SAR test results of LTE Band VII

**10.1.9. SAR measurement Result of Wi-Fi 2.4G**

Test Position of Head	Test channel /Freq.	Test Mode	SAR Value (W/kg)		Power Drift (±5%)	Conducted power (dBm)	Tune-up power (dBm)	Scaled SAR 1g (W/Kg)
			1g	10g				
Left Cheek	11/2462	802.11 b	0.520	0.297	4.19	15.30	15.50	0.545
Left Tilt 15 Degree	11/2462	802.11 b	0.576	0.306	3.34	15.30	15.50	0.603
Right Cheek	11/2462	802.11 b	1.277	0.661	-0.54	15.30	15.50	1.337
Right Cheek-Repeated	11/2462	802.11 b	1.254	0.642	-1.84	15.30	15.50	1.313
Right Tilt 15 Degree	11/2462	802.11 b	1.043	0.487	1.52	15.30	15.50	1.092
Right Cheek	1/2412	802.11 b	1.059	0.496	0.27	15.10	15.50	1.161
Right Cheek	6/2442	802.11 b	0.952	0.440	-0.34	14.70	15.50	1.145
Right Tilt 15 Degree	1/2412	802.11 b	0.952	0.429	1.58	15.10	15.50	1.044
Right Tilt 15 Degree	6/2442	802.11 b	0.863	0.418	1.13	14.70	15.50	1.038



NOTE: Head SAR test results of Wi-Fi 2.4G

Test Position of Body-Worn with 10mm	Test channel /Freq.	Test Mode	SAR Value (W/kg)		Power Drift (±5%)	Conducted power (dBm)	Tune-up power (dBm)	Scaled SAR 1g (W/Kg)
			1g	10g				
Front Side	11/2462	802.11 b	0.304	0.175	4.97	15.30	15.50	0.318
Back Side	11/2462	802.11 b	0.366	0.208	-0.09	15.30	15.50	0.383

NOTE: Body-Worn SAR test results of Wi-Fi 2.4G

Test Position of Hotspot with 10mm	Test channel /Freq.	Test Mode	SAR Value (W/kg)		Power Drift (±5%)	Conducted power (dBm)	Tune-up power (dBm)	Scaled SAR 1g (W/Kg)
			1g	10g				
Front Side	11/2462	802.11 b	0.304	0.175	4.97	15.30	15.50	0.318
Back Side	11/2462	802.11 b	0.366	0.208	-0.09	15.30	15.50	0.383
Left Side	11/2462	802.11 b	0.043	0.029	-2.19	15.30	15.50	0.045
Top Side	11/2462	802.11 b	0.065	0.036	-1.76	15.30	15.50	0.068

NOTE: Hotspot SAR test results of Wi-Fi 2.4G

### 10.2. Simultaneous Transmission Possibilities

The Simultaneous Transmission Possibilities of this device are as below:

No.	Configuration	Head	Body	Hotspot	Note
1	GSM(Voice) + Wi-Fi 2.4GHz(data)	Yes	Yes	N/A	
2	WCDMA(Voice) + Wi-Fi 2.4GHz(data)	Yes	Yes	N/A	
3	GSM(Voice) + BT(data)	Yes	Yes	N/A	
4	WCDMA(Voice) + BT(data)	Yes	Yes	N/A	
5	GPRS/EDGE(data) + Wi-Fi 2.4GHz(data)	Yes	Yes	Yes	2.4GHz Hotspot
6	WCDMA(data) + Wi-Fi 2.4GHz(data)	Yes	Yes	Yes	2.4GHz Hotspot
7	LTE(data) + Wi-Fi 2.4GHz(data)	Yes	Yes	Yes	2.4GHz Hotspot
8	GPRS/EDGE(data) + BT(data)	Yes	Yes	Yes	BT Tethering
9	WCDMA(data) + BT(data)	Yes	Yes	Yes	BT Tethering
10	LTE(data) + BT(data)	Yes	Yes	Yes	BT Tethering

**NOTE:**

- 1) This device supported VoIP in GPRS/EDGE, WCDMA and LTE(e.g. 3rd party VoIP).
- 2) This device Wi-Fi 2.4GHz supports Hotspot operation.
- 3) Wi-Fi 2.4GHz and BT share the same antenna, and cannot transmit simultaneously.
- 4) EUT will choose each GSM, WCDMA and LTE according to the network signal condition; therefore, they will not operate simultaneously at any moment.
- 5) The Scaled SAR summation is calculated based on the same configuration and test position.

### 10.3. SAR Summation Scenario

Per KDB 447498 D01, simultaneous transmission SAR is compliant if,

- 1) Scalar SAR summation < 1.6W/kg.
- 2) SPLSR =  $(SAR_1 + SAR_2)^{1.5} / (\text{min. separation distance, mm})$ , and the peak separation distance is determined from the square root of  $[(x_1-x_2)^2 + (y_1-y_2)^2 + (z_1-z_2)^2]$ , where  $(x_1, y_1, z_1)$  and  $(x_2, y_2, z_2)$  are the coordinates of the extrapolated peak SAR locations in the zoom scan. If  $SPLSR \leq 0.04$ , simultaneously transmission SAR measurement is not necessary.

Test Position		Scaled SAR <sub>MAX</sub>		Σ 1-g SAR (W/Kg)	SPLSR	Remark
		GSM 850	Wi-Fi 2.4G			
Head	Left Cheek	0.113	0.545	0.658	N/A	N/A
	Left Tilt 15 Degree	0.065	0.603	0.668	N/A	N/A
	Right Cheek	0.140	1.337	1.477	N/A	N/A
	Right Tilt 15 Degree	0.020	1.092	1.113	N/A	N/A
Body-Worn	Front Side	0.135	0.318	0.453	N/A	N/A
	Back Side	0.228	0.383	0.611	N/A	N/A
Hotspot	Front Side	0.135	0.318	0.453	N/A	N/A
	Back Side	0.228	0.383	0.611	N/A	N/A
	Left Side	0.033	N/A	0.033	N/A	N/A
	Right Side	0.200	0.045	0.245	N/A	N/A
	Top Side	N/A	0.068	0.068	N/A	N/A
	Bottom Side	0.115	N/A	0.115	N/A	N/A

NOTE: 1-g SAR Simultaneous Tx Combination of GSM850 and Wi-Fi 2.4G.

Test Position		Scaled SAR <sub>MAX</sub>		Σ 1-g SAR (W/Kg)	SPLSR	Remark
		GSM 1900	Wi-Fi 2.4G			
Head	Left Cheek	0.085	0.545	0.630	N/A	N/A
	Left Tilt 15 Degree	0.034	0.603	0.637	N/A	N/A
	Right Cheek	0.145	1.337	1.482	N/A	N/A
	Right Tilt 15 Degree	0.048	1.092	1.140	N/A	N/A
Body-Worn	Front Side	0.515	0.318	0.833	N/A	N/A
	Back Side	0.620	0.383	1.003	N/A	N/A
Hotspot	Front Side	0.515	0.318	0.833	N/A	N/A
	Back Side	0.620	0.383	1.003	N/A	N/A
	Left Side	0.036	N/A	0.036	N/A	N/A
	Right Side	0.151	0.045	0.196	N/A	N/A
	Top Side	N/A	0.068	0.068	N/A	N/A
	Bottom Side	0.641	N/A	0.641	N/A	N/A

NOTE: 1-g SAR Simultaneous Tx Combination of GSM1900 and Wi-Fi 2.4G.

Test Position		Scaled SAR <sub>MAX</sub>		Σ 1-g SAR (W/Kg)	SPLSR	Remark
		WCDMA Band V	Wi-Fi 2.4G			
Head	Left Cheek	0.090	0.545	0.634	N/A	N/A
	Left Tilt 15 Degree	0.078	0.603	0.681	N/A	N/A
	Right Cheek	0.117	1.337	1.454	N/A	N/A
	Right Tilt 15 Degree	0.092	1.092	1.184	N/A	N/A
Body-Worn	Front Side	0.103	0.318	0.421	N/A	N/A
	Back Side	0.169	0.383	0.552	N/A	N/A
Hotspot	Front Side	0.103	0.318	0.421	N/A	N/A
	Back Side	0.169	0.383	0.552	N/A	N/A
	Left Side	0.073	N/A	0.073	N/A	N/A
	Right Side	0.118	0.045	0.163	N/A	N/A
	Top Side	N/A	0.068	0.068	N/A	N/A
	Bottom Side	0.083	N/A	0.083	N/A	N/A

NOTE: 1-g SAR Simultaneous Tx Combination of WCDMA Band V and Wi-Fi 2.4G.

Test Position		Scaled SAR <sub>MAX</sub>		Σ 1-g SAR (W/Kg)	SPLSR	Remark
		WCDMA Band II	Wi-Fi 2.4G			
Head	Left Cheek	0.115	0.545	0.660	N/A	N/A
	Left Tilt 15 Degree	0.038	0.603	0.641	N/A	N/A
	Right Cheek	0.207	1.337	1.544	N/A	N/A
	Right Tilt 15 Degree	0.053	1.092	1.146	N/A	N/A
Body-Worn	Front Side	0.645	0.318	0.963	N/A	N/A
	Back Side	0.987	0.383	1.371	N/A	N/A
Hotspot	Front Side	0.645	0.318	0.963	N/A	N/A
	Back Side	0.987	0.383	1.371	N/A	N/A
	Left Side	0.155	N/A	0.155	N/A	N/A
	Right Side	0.177	0.045	0.223	N/A	N/A
	Top Side	N/A	0.068	0.068	N/A	N/A
	Bottom Side	0.965	N/A	0.965	N/A	N/A

NOTE: 1-g SAR Simultaneous Tx Combination of WCDMA Band II and Wi-Fi 2.4G.

Test Position		Scaled SAR <sub>MAX</sub>		Σ 1-g SAR (W/Kg)	SPLSR	Remark
		LTE Band V	Wi-Fi 2.4G			
Head	Left Cheek	0.089	0.545	0.633	N/A	N/A
	Left Tilt 15 Degree	0.057	0.603	0.660	N/A	N/A

	Right Cheek	0.108	1.337	1.445	N/A	N/A
	Right Tilt 15 Degree	0.074	1.092	1.166	N/A	N/A
Body-Worn	Front Side	0.126	0.318	0.445	N/A	N/A
	Back Side	0.173	0.383	0.556	N/A	N/A
Hotspot	Front Side	0.126	0.318	0.445	N/A	N/A
	Back Side	0.173	0.383	0.556	N/A	N/A
	Left Side	0.049	N/A	0.049	N/A	N/A
	Right Side	0.162	0.045	0.207	N/A	N/A
	Top Side	N/A	0.068	0.068	N/A	N/A
	Bottom Side	0.075	N/A	0.075	N/A	N/A

NOTE: 1-g SAR Simultaneous Tx Combination of LTE Band V and Wi-Fi 2.4G.

Test Position		Scaled SAR <sub>MAX</sub>		Σ 1-g SAR (W/Kg)	SPLSR	Remark
		LTE Band IV	Wi-Fi 2.4G			
Head	Left Cheek	0.183	0.545	0.727	N/A	N/A
	Left Tilt 15 Degree	0.061	0.603	0.664	N/A	N/A
	Right Cheek	0.253	1.337	1.590	N/A	N/A
	Right Tilt 15 Degree	0.118	1.092	1.210	N/A	N/A
Body-Worn	Front Side	0.480	0.318	0.799	N/A	N/A
	Back Side	0.577	0.383	0.960	N/A	N/A
Hotspot	Front Side	0.480	0.318	0.799	N/A	N/A
	Back Side	0.577	0.383	0.960	N/A	N/A
	Left Side	0.139	N/A	0.139	N/A	N/A
	Right Side	0.279	0.045	0.324	N/A	N/A
	Top Side	N/A	0.068	0.068	N/A	N/A
	Bottom Side	0.511	N/A	0.511	N/A	N/A

NOTE: 1-g SAR Simultaneous Tx Combination of LTE Band IV and Wi-Fi 2.4G.

Test Position		Scaled SAR <sub>MAX</sub>		Σ 1-g SAR (W/Kg)	SPLSR	Remark
		LTE Band II	Wi-Fi 2.4G			
Head	Left Cheek	0.103	0.545	0.648	N/A	N/A
	Left Tilt 15 Degree	0.035	0.603	0.638	N/A	N/A
	Right Cheek	0.203	1.337	1.541	N/A	N/A
	Right Tilt 15 Degree	0.051	1.092	1.143	N/A	N/A
Body-Worn	Front Side	0.688	0.318	1.006	N/A	N/A
	Back Side	0.918	0.383	1.302	N/A	N/A
Hotspot	Front Side	0.688	0.318	1.006	N/A	N/A
	Back Side	0.918	0.383	1.302	N/A	N/A
	Left Side	0.084	N/A	0.084	N/A	N/A

	Right Side	0.189	0.045	0.234	N/A	N/A
	Top Side	N/A	0.068	0.068	N/A	N/A
	Bottom Side	0.277	N/A	0.277	N/A	N/A

NOTE: 1-g SAR Simultaneous Tx Combination of LTE Band II and Wi-Fi 2.4G.

Test Position		Scaled SAR <sub>MAX</sub>		Σ 1-g SAR (W/Kg)	SPLSR	Remark
		LTE Band VII	Wi-Fi 2.4G			
Head	Left Cheek	0.364	0.545	0.908	N/A	N/A
	Left Tilt 15 Degree	0.113	0.603	0.716	N/A	N/A
	Right Cheek	0.112	1.337	1.449	N/A	N/A
	Right Tilt 15 Degree	0.059	1.092	1.151	N/A	N/A
Body-Worn	Front Side	0.247	0.318	0.565	N/A	N/A
	Back Side	0.283	0.383	0.666	N/A	N/A
Hotspot	Front Side	0.247	0.318	0.565	N/A	N/A
	Back Side	0.283	0.383	0.666	N/A	N/A
	Left Side	0.202	N/A	0.202	N/A	N/A
	Right Side	0.044	0.045	0.089	N/A	N/A
	Top Side	N/A	0.068	0.068	N/A	N/A
	Bottom Side	0.427	N/A	0.427	N/A	N/A

NOTE: 1-g SAR Simultaneous Tx Combination of LTE Band VII and Wi-Fi 2.4G.

Test Position		Scaled SAR <sub>MAX</sub>		Σ 1-g SAR (W/Kg)	SPLSR	Remark
		GSM 850	BT			
Head	Left Cheek	0.113	0.105	0.219	N/A	N/A
	Left Tilt 15 Degree	0.065	0.105	0.170	N/A	N/A
	Right Cheek	0.140	0.105	0.246	N/A	N/A
	Right Tilt 15 Degree	0.020	0.105	0.126	N/A	N/A
Body-Worn	Front Side	0.135	0.053	0.188	N/A	N/A
	Back Side	0.228	0.053	0.281	N/A	N/A
Hotspot	Front Side	0.135	0.053	0.188	N/A	N/A
	Back Side	0.228	0.053	0.281	N/A	N/A
	Left Side	0.033	N/A	0.033	N/A	N/A
	Right Side	0.200	0.053	0.253	N/A	N/A
	Top Side	N/A	0.053	0.053	N/A	N/A
	Bottom Side	0.115	N/A	0.115	N/A	N/A

NOTE: 1-g SAR Simultaneous Tx Combination of GSM850 and BT

Test Position	Scaled SAR <sub>MAX</sub>		Σ 1-g SAR	SPLSR	Remark
---------------	---------------------------	--	-----------	-------	--------

		GSM 1900	BT	(W/Kg)		
Head	Left Cheek	0.085	0.105	0.191	N/A	N/A
	Left Tilt 15 Degree	0.034	0.105	0.139	N/A	N/A
	Right Cheek	0.145	0.105	0.250	N/A	N/A
	Right Tilt 15 Degree	0.048	0.105	0.153	N/A	N/A
Body-Worn	Front Side	0.515	0.053	0.567	N/A	N/A
	Back Side	0.620	0.053	0.672	N/A	N/A
Hotspot	Front Side	0.515	0.053	0.567	N/A	N/A
	Back Side	0.620	0.053	0.672	N/A	N/A
	Left Side	0.036	N/A	0.036	N/A	N/A
	Right Side	0.151	0.053	0.203	N/A	N/A
	Top Side	N/A	0.053	0.053	N/A	N/A
	Bottom Side	0.641	N/A	0.641	N/A	N/A

NOTE: 1-g SAR Simultaneous Tx Combination of GSM1900 and BT

Test Position		Scaled SAR <sub>MAX</sub>		Σ 1-g SAR (W/Kg)	SPLSR	Remark
		WCDMA Band V	BT			
Head	Left Cheek	0.090	0.105	0.195	N/A	N/A
	Left Tilt 15 Degree	0.078	0.105	0.184	N/A	N/A
	Right Cheek	0.117	0.105	0.222	N/A	N/A
	Right Tilt 15 Degree	0.092	0.105	0.197	N/A	N/A
Body-Worn	Front Side	0.103	0.053	0.155	N/A	N/A
	Back Side	0.169	0.053	0.222	N/A	N/A
Hotspot	Front Side	0.103	0.053	0.155	N/A	N/A
	Back Side	0.169	0.053	0.222	N/A	N/A
	Left Side	0.073	N/A	0.073	N/A	N/A
	Right Side	0.118	0.053	0.170	N/A	N/A
	Top Side	N/A	0.053	0.053	N/A	N/A
	Bottom Side	0.083	N/A	0.083	N/A	N/A

NOTE: 1-g SAR Simultaneous Tx Combination of WCDMA Band V and BT

Test Position		Scaled SAR <sub>MAX</sub>		Σ 1-g SAR (W/Kg)	SPLSR	Remark
		WCDMA Band II	BT			
Head	Left Cheek	0.115	0.105	0.221	N/A	N/A
	Left Tilt 15 Degree	0.038	0.105	0.144	N/A	N/A
	Right Cheek	0.207	0.105	0.312	N/A	N/A
	Right Tilt 15 Degree	0.053	0.105	0.159	N/A	N/A

Body-Worn	Front Side	0.645	0.053	0.697	N/A	N/A
	Back Side	0.987	0.053	1.040	N/A	N/A
Hotspot	Front Side	0.645	0.053	0.697	N/A	N/A
	Back Side	0.987	0.053	1.040	N/A	N/A
	Left Side	0.155	N/A	0.155	N/A	N/A
	Right Side	0.177	0.053	0.230	N/A	N/A
	Top Side	N/A	0.053	0.053	N/A	N/A
	Bottom Side	0.965	N/A	0.965	N/A	N/A

NOTE: 1-g SAR Simultaneous Tx Combination of WCDMA Band II and BT

Test Position		Scaled SAR <sub>MAX</sub>		Σ 1-g SAR (W/Kg)	SPLSR	Remark
		LTE Band V	BT			
Head	Left Cheek	0.089	0.105	0.194	N/A	N/A
	Left Tilt 15 Degree	0.057	0.105	0.162	N/A	N/A
	Right Cheek	0.108	0.105	0.214	N/A	N/A
	Right Tilt 15 Degree	0.074	0.105	0.179	N/A	N/A
Body-Worn	Front Side	0.126	0.053	0.179	N/A	N/A
	Back Side	0.173	0.053	0.225	N/A	N/A
Hotspot	Front Side	0.126	0.053	0.179	N/A	N/A
	Back Side	0.173	0.053	0.225	N/A	N/A
	Left Side	0.049	N/A	0.049	N/A	N/A
	Right Side	0.162	0.053	0.215	N/A	N/A
	Top Side	N/A	0.053	0.053	N/A	N/A
	Bottom Side	0.075	N/A	0.075	N/A	N/A

NOTE: 1-g SAR Simultaneous Tx Combination of LTE Band V and BT

Test Position		Scaled SAR <sub>MAX</sub>		Σ 1-g SAR (W/Kg)	SPLSR	Remark
		LTE Band IV	BT			
Head	Left Cheek	0.183	0.105	0.288	N/A	N/A
	Left Tilt 15 Degree	0.061	0.105	0.166	N/A	N/A
	Right Cheek	0.253	0.105	0.358	N/A	N/A
	Right Tilt 15 Degree	0.118	0.105	0.223	N/A	N/A
Body-Worn	Front Side	0.480	0.053	0.533	N/A	N/A
	Back Side	0.577	0.053	0.630	N/A	N/A
Hotspot	Front Side	0.480	0.053	0.533	N/A	N/A
	Back Side	0.577	0.053	0.630	N/A	N/A
	Left Side	0.139	N/A	0.139	N/A	N/A
	Right Side	0.279	0.053	0.332	N/A	N/A
	Top Side	N/A	0.053	0.053	N/A	N/A



	Bottom Side	0.511	N/A	0.511	N/A	N/A
--	-------------	-------	-----	-------	-----	-----

NOTE: 1-g SAR Simultaneous Tx Combination of LTE Band IV and BT

Test Position		Scaled SAR <sub>MAX</sub>		Σ 1-g SAR (W/Kg)	SPLSR	Remark
		LTE Band II	BT			
Head	Left Cheek	0.103	0.105	0.209	N/A	N/A
	Left Tilt 15 Degree	0.035	0.105	0.141	N/A	N/A
	Right Cheek	0.203	0.105	0.309	N/A	N/A
	Right Tilt 15 Degree	0.051	0.105	0.156	N/A	N/A
Body-Worn	Front Side	0.688	0.053	0.741	N/A	N/A
	Back Side	0.918	0.053	0.971	N/A	N/A
Hotspot	Front Side	0.688	0.053	0.741	N/A	N/A
	Back Side	0.918	0.053	0.971	N/A	N/A
	Left Side	0.084	N/A	0.084	N/A	N/A
	Right Side	0.189	0.053	0.242	N/A	N/A
	Top Side	N/A	0.053	0.053	N/A	N/A
	Bottom Side	0.277	N/A	0.277	N/A	N/A

NOTE: 1-g SAR Simultaneous Tx Combination of LTE Band II and BT

Test Position		Scaled SAR <sub>MAX</sub>		Σ 1-g SAR (W/Kg)	SPLSR	Remark
		LTE Band VII	BT			
Head	Left Cheek	0.364	0.105	0.469	N/A	N/A
	Left Tilt 15 Degree	0.113	0.105	0.219	N/A	N/A
	Right Cheek	0.112	0.105	0.218	N/A	N/A
	Right Tilt 15 Degree	0.059	0.105	0.165	N/A	N/A
Body-Worn	Front Side	0.247	0.053	0.300	N/A	N/A
	Back Side	0.283	0.053	0.335	N/A	N/A
Hotspot	Front Side	0.247	0.053	0.300	N/A	N/A
	Back Side	0.283	0.053	0.335	N/A	N/A
	Left Side	0.202	N/A	0.202	N/A	N/A
	Right Side	0.044	0.053	0.097	N/A	N/A
	Top Side	N/A	0.053	0.053	N/A	N/A
	Bottom Side	0.427	N/A	0.427	N/A	N/A

NOTE: 1-g SAR Simultaneous Tx Combination of LTE Band VII and BT

## 11. Appendix A. Photo documentation

<b>Table of contents</b>
<b>Test Facility</b>
<b>Product Photo</b>
<b>Test Positions</b>
<b>Liquid depth</b>

**Test Facility**

Measurement System SATIMO



**Product Photo**

Front View

Back View

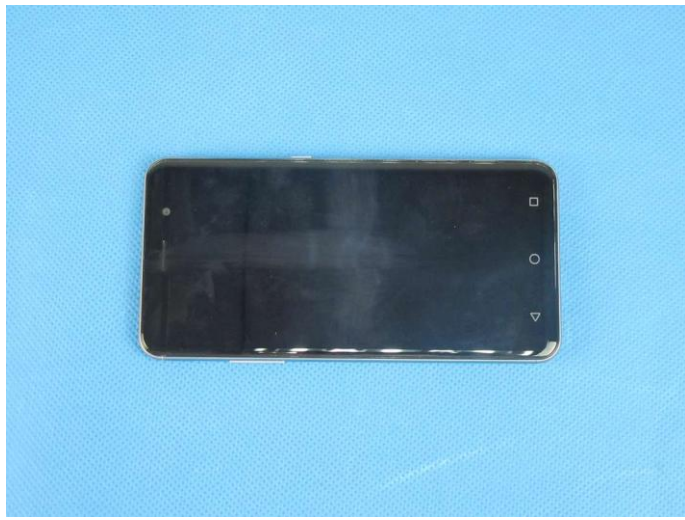

Reference Line

N/A

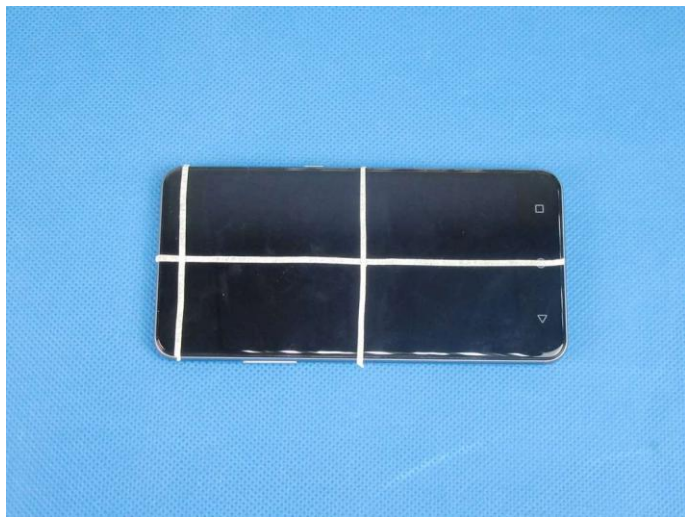

N/A

**Test Positions**

Left Cheek

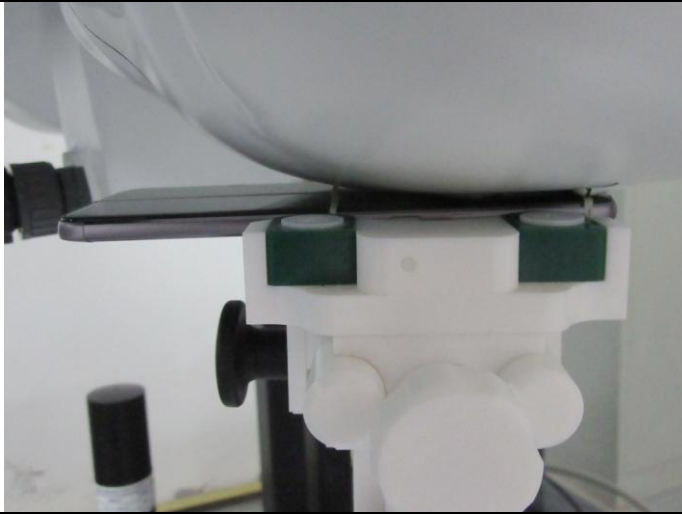

Left Tilt 15 Degree



Right Cheek



Right Tilt 15 Degree



Front Side  
(Separation distance of 10mm)

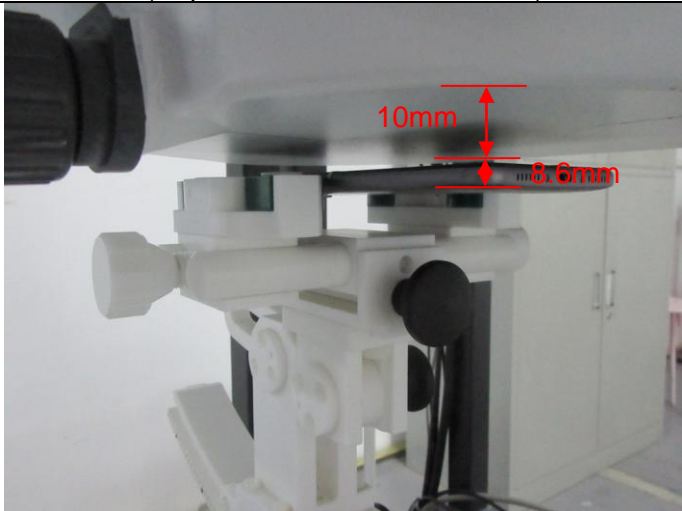

Back Side  
(Separation distance of 10mm)

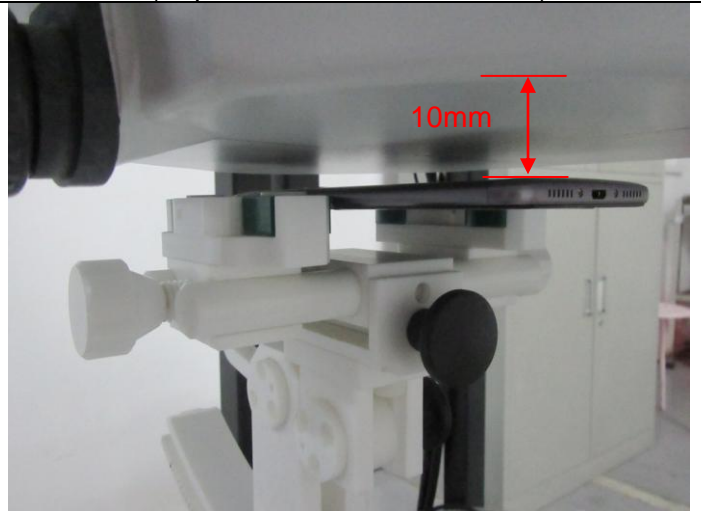

Left Side  
(Separation distance of 10mm)

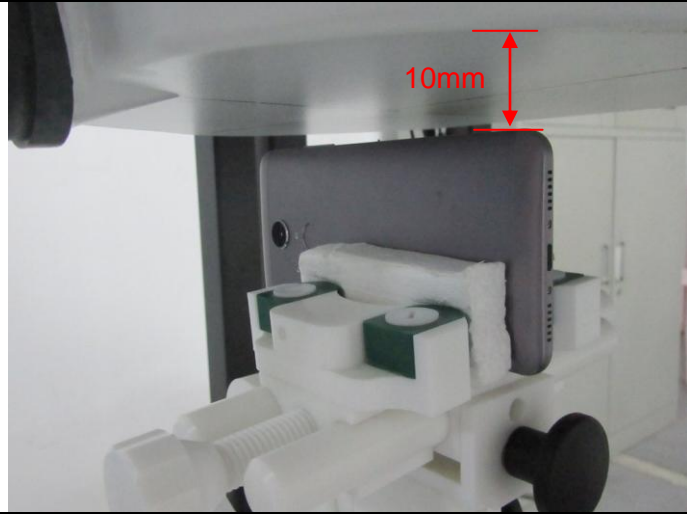

Right Side  
(Separation distance of 10mm)

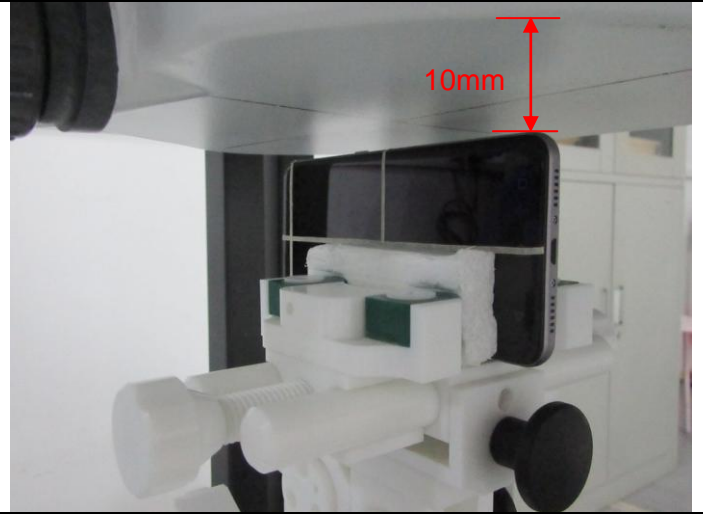

Top Side  
(Separation distance of 10mm)

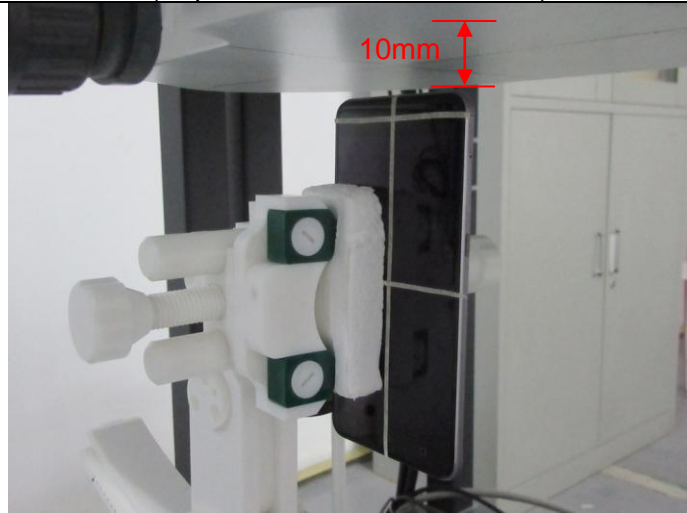

Bottom Side  
(Separation distance of 10mm)

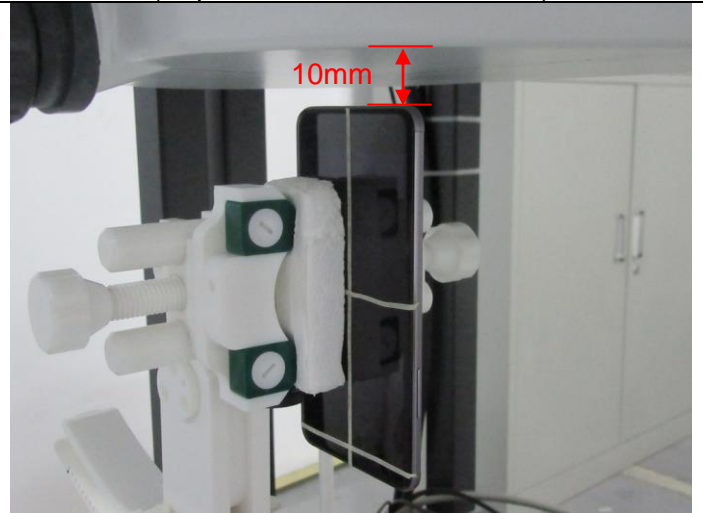

**Liquid depth**

Head 850MHz depth (15.2cm)

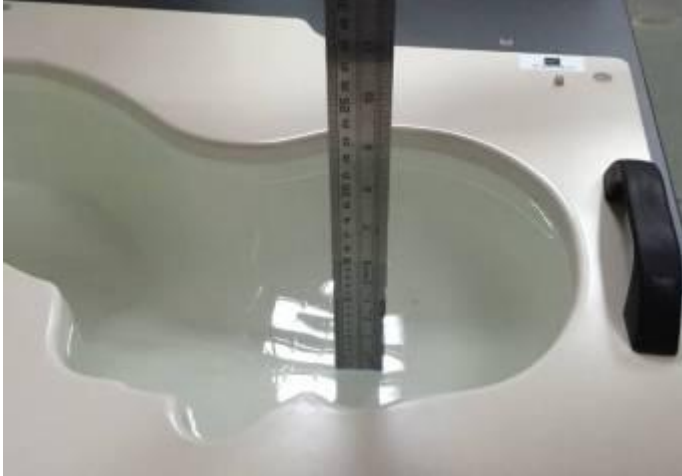

Body 850MHz depth (15.3cm)



Head 1750MHz depth (15.1cm)



Body 1750MHz depth (15.4cm)



Head 1900MHz depth (15.3cm)



Body 1900MHz depth (15.2cm)



Head 2450MHz depth (15.1cm)

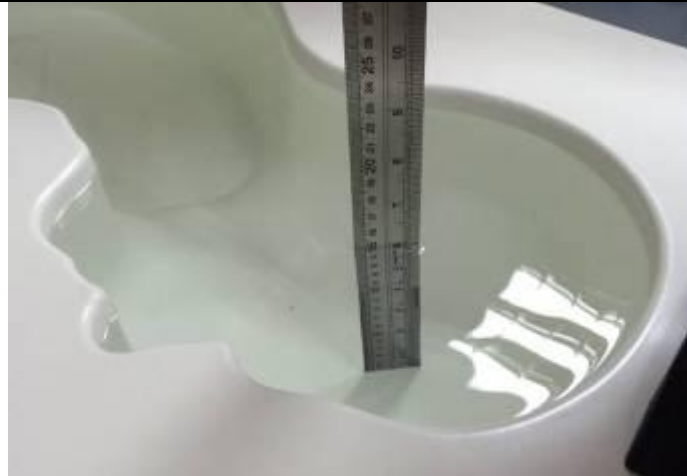

Body 2450MHz depth (15.2cm)



Head 2600MHz depth (15.2cm)

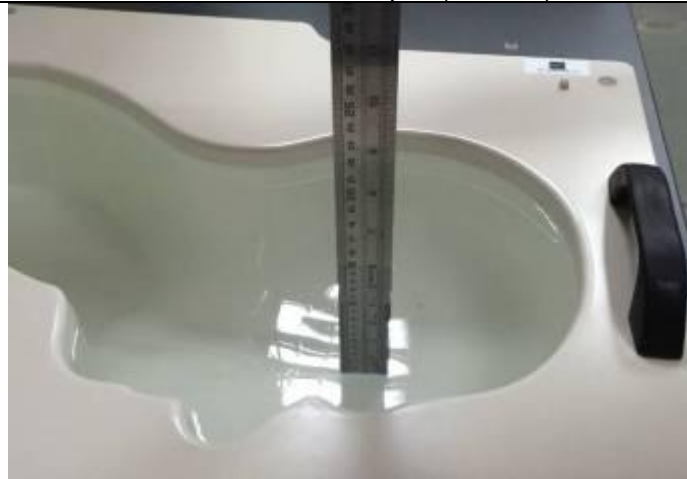

Body 2600MHz depth (15.3cm)





## 12. Appendix B. System Check Plots

<b>Table of contents</b>
<b>System Performance Check - SID835 - Head</b>
<b>System Performance Check - SID835 - Body</b>
<b>System Performance Check - SID1750 - Head</b>
<b>System Performance Check - SID1750 - Body</b>
<b>System Performance Check - SID1900 - Head</b>
<b>System Performance Check - SID1900 - Body</b>
<b>System Performance Check - SID2450 - Head</b>
<b>System Performance Check - SID2450 - Body</b>
<b>System Performance Check - SID2600 - Head</b>
<b>System Performance Check - SID2600 - Body</b>

### System Performance Check - SID835-Head

Date of measurement:	Apr. 22, 2017
Signal:	Communication System: CW; Frequency: 835.00MHz; Duty Cycle: 1:1.00
ConvF:	1.53
Liquid Parameters:	Relative permittivity (real part): 42.54; Conductivity (S/m): 0.89;
Device Position:	Dipole
Area Scan:	dx=15mm dy=15mm, h=5.00mm
Zoom Scan:	5x5x7, dx=8mm dy=8mm dz=5mm, h=5.00mm

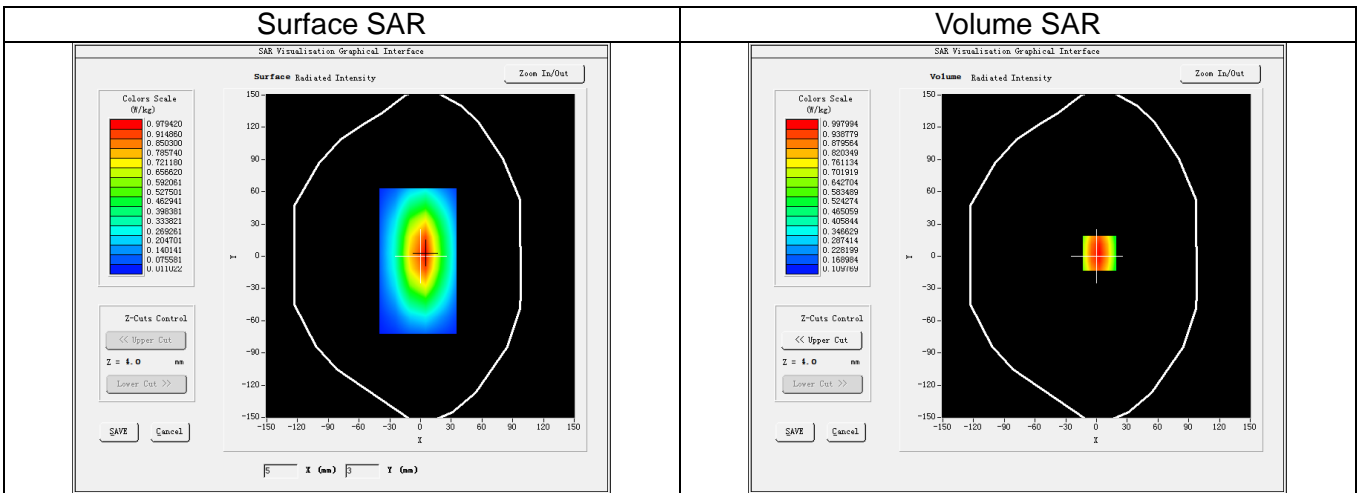

3D screen shot

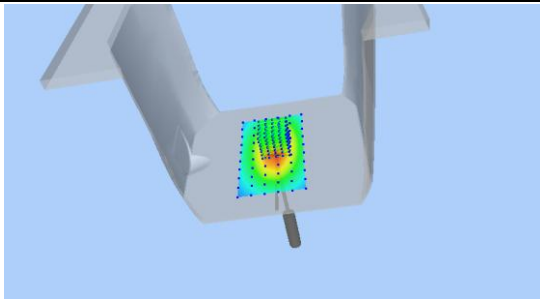

Hot spot position

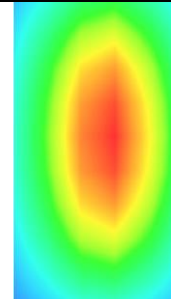

Maximum location: X=3.00, Y=3.00  
SAR Peak: 1.34 W/kg

SAR 1g (W/Kg)		0.972					
SAR 10g (W/Kg)		0.651					
Power Drift (±5%):		0.10					
Z (mm)	0.00	4.00	9.00	14.00	19.00	24.00	29.00
SAR (W/Kg)	1.3377	0.9980	0.6983	0.4988	0.3612	0.2639	0.1929

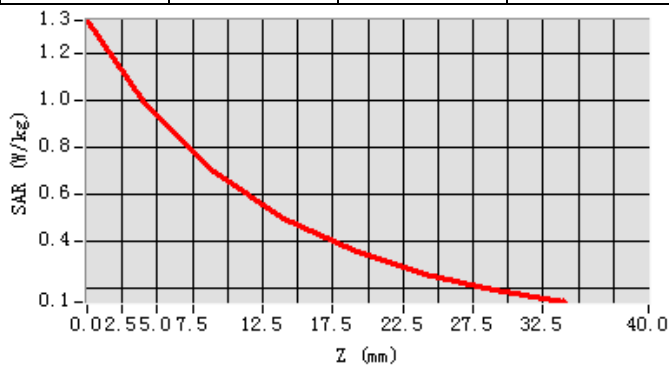

### System Performance Check - SID835-Body

Date of measurement:	Apr. 22, 2017
Signal:	Communication System: CW; Frequency: 835.00MHz; Duty Cycle: 1:1.00
ConvF:	1.59
Liquid Parameters:	Relative permittivity (real part): 55.40; Conductivity (S/m): 0.98;
Device Position:	Dipole
Area Scan:	dx=15mm dy=15mm, h=5.00mm
Zoom Scan:	5x5x7, dx=8mm dy=8mm dz=5mm, h=5.00mm

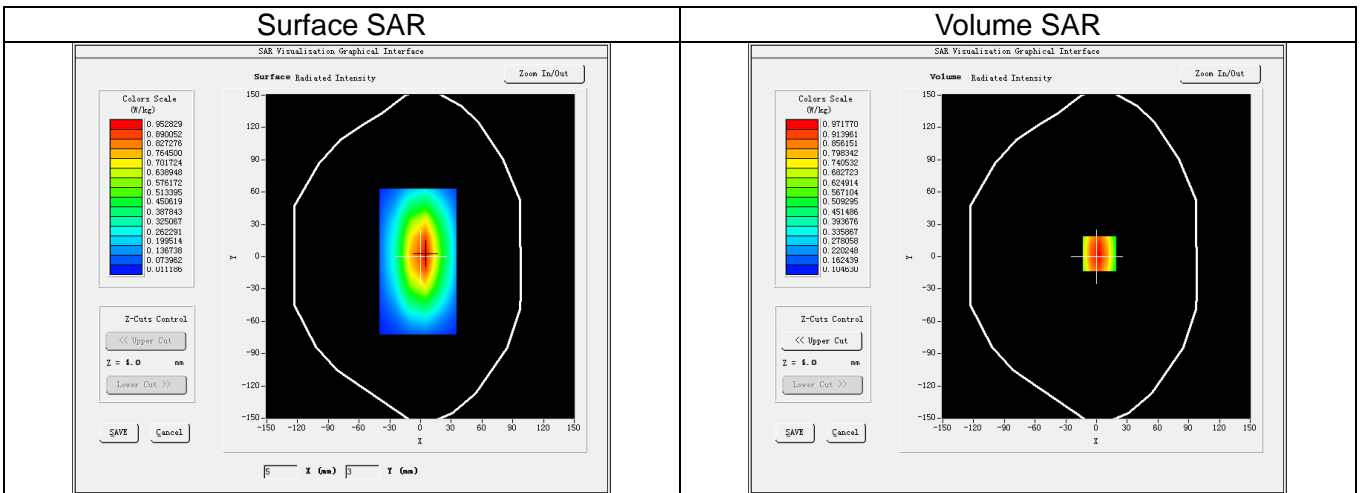

3D screen shot

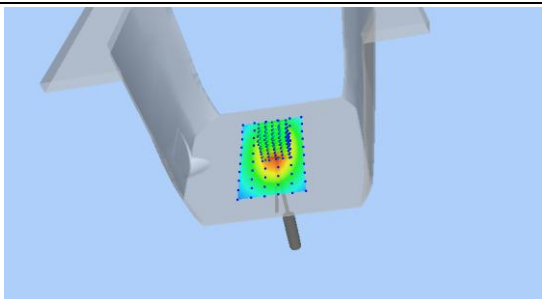

Hot spot position

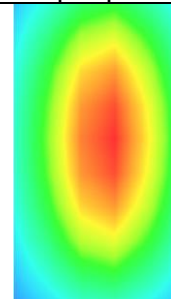

Maximum location: X=3.00, Y=3.00  
SAR Peak: 1.31 W/kg

SAR 1g (W/Kg)		0.954					
SAR 10g (W/Kg)		0.637					
Power Drift (±5%):		0.02					
Z (mm)	0.00	4.00	9.00	14.00	19.00	24.00	29.00
SAR (W/Kg)	1.3067	0.9718	0.6777	0.4834	0.3496	0.2541	0.1854

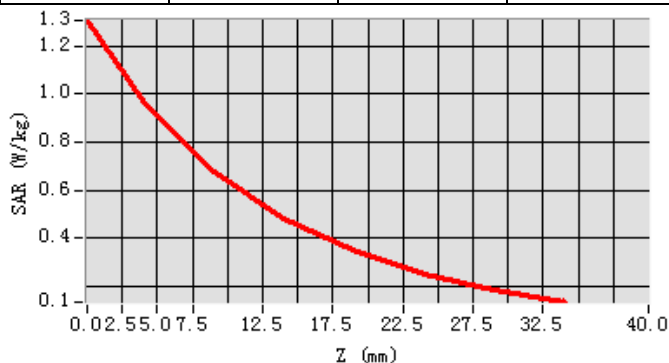

### System Performance Check - SID1750-Head

Date of measurement:	Apr. 26, 2017
Signal:	Communication System: CW; Frequency: 1750.00MHz; Duty Cycle: 1:1.00
ConvF:	3.77
Liquid Parameters:	Relative permittivity (real part): 40.25; Conductivity (S/m): 1.37;
Device Position:	Dipole
Area Scan:	dx=15mm dy=15mm, h=5.00mm
Zoom Scan:	5x5x7, dx=8mm dy=8mm dz=5mm, h=5.00mm

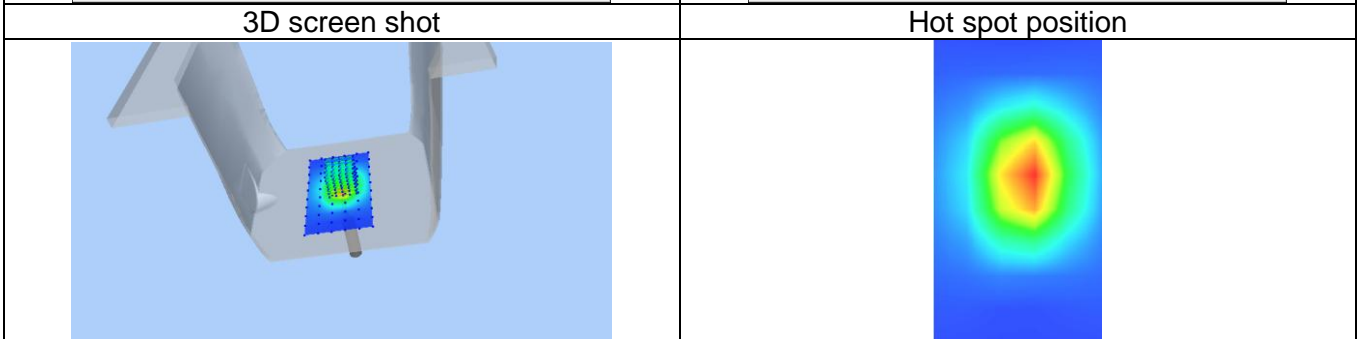
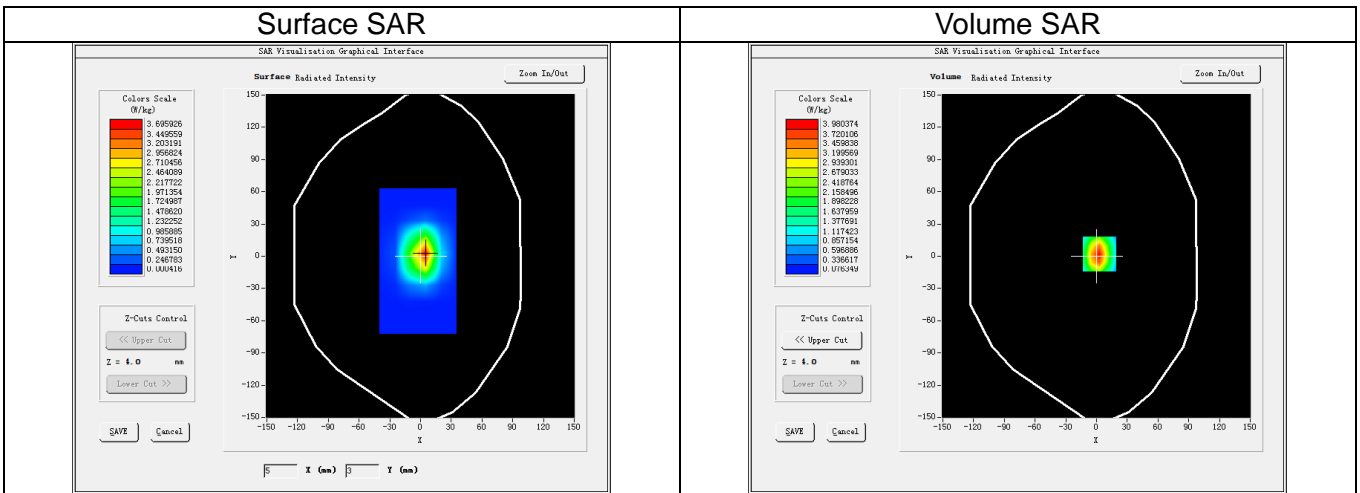

Maximum location: X=3.00, Y=2.00  
SAR Peak: 6.09 W/kg

SAR 1g (W/Kg)	3.739						
SAR 10g (W/Kg)	1.968						
Power Drift (±5%):	4.19						
Z (mm)	0.00	4.00	9.00	14.00	19.00	24.00	29.00
SAR (W/Kg)	6.0746	3.9804	2.3154	1.4098	0.8524	0.5258	0.3255

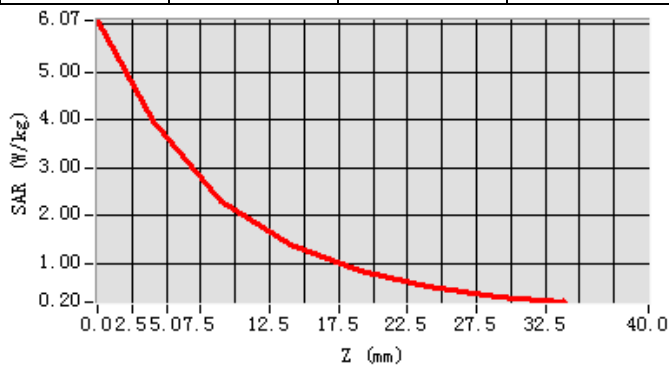

### System Performance Check - SID1750-Body

Date of measurement:	Apr. 28, 2017
Signal:	Communication System: CW; Frequency: 1750.00MHz; Duty Cycle: 1:1.00
ConvF:	3.85
Liquid Parameters:	Relative permittivity (real part): 54.22; Conductivity (S/m): 1.50;
Device Position:	Dipole
Area Scan:	dx=15mm dy=15mm, h=5.00mm
Zoom Scan:	5x5x7, dx=8mm dy=8mm dz=5mm, h=5.00mm

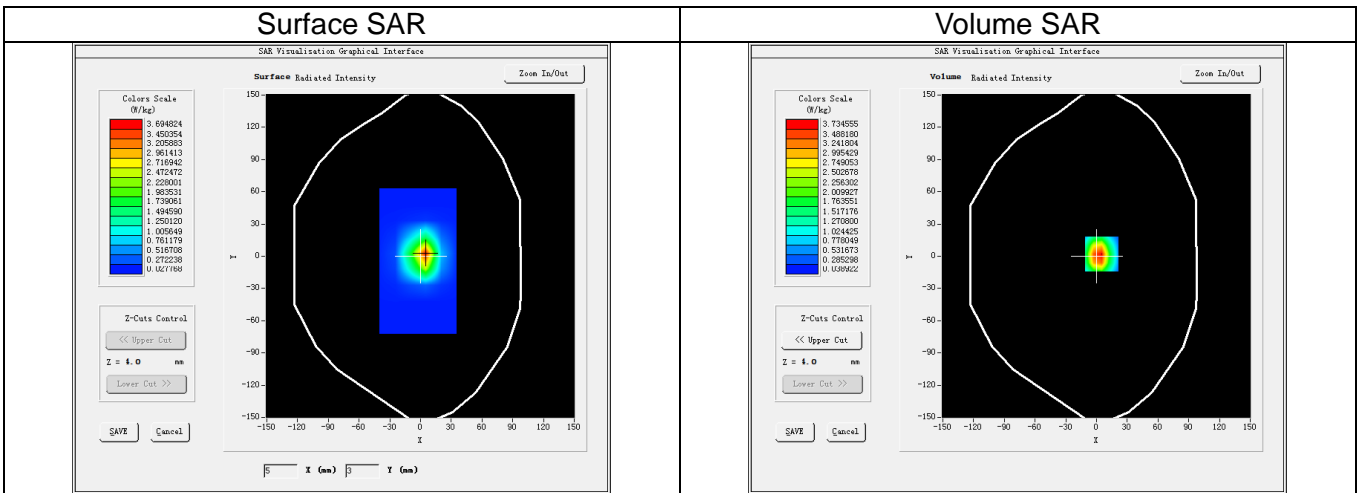

3D screen shot

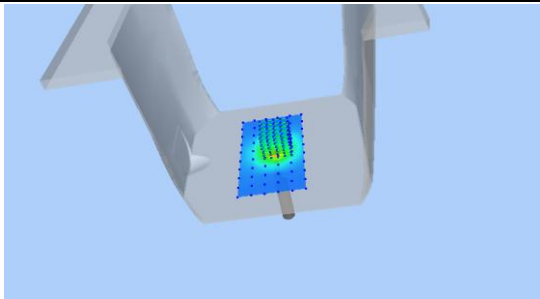

Hot spot position

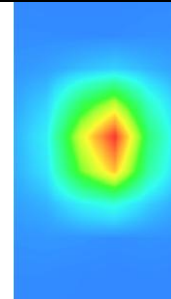

Maximum location: X=5.00, Y=2.00  
SAR Peak: 6.87 W/kg

SAR 1g (W/Kg)		3.671					
SAR 10g (W/Kg)		1.900					
Power Drift (±5%):		0.02					
Z (mm)	0.00	4.00	9.00	14.00	19.00	24.00	29.00
SAR (W/Kg)	6.5042	3.7346	1.7366	0.8222	0.3972	0.2014	0.1095

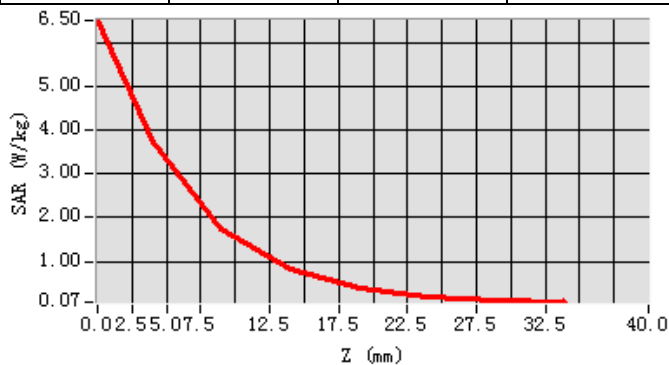

### System Performance Check - SID1900-Head

Date of measurement:	Apr. 25, 2017
Signal:	Communication System: CW; Frequency: 1900.00MHz; Duty Cycle: 1:1.00
ConvF:	1.94
Liquid Parameters:	Relative permittivity (real part): 39.36; Conductivity (S/m): 1.43;
Device Position:	Dipole
Area Scan:	dx=15mm dy=15mm, h=5.00mm
Zoom Scan:	5x5x7, dx=8mm dy=8mm dz=5mm, h=5.00mm

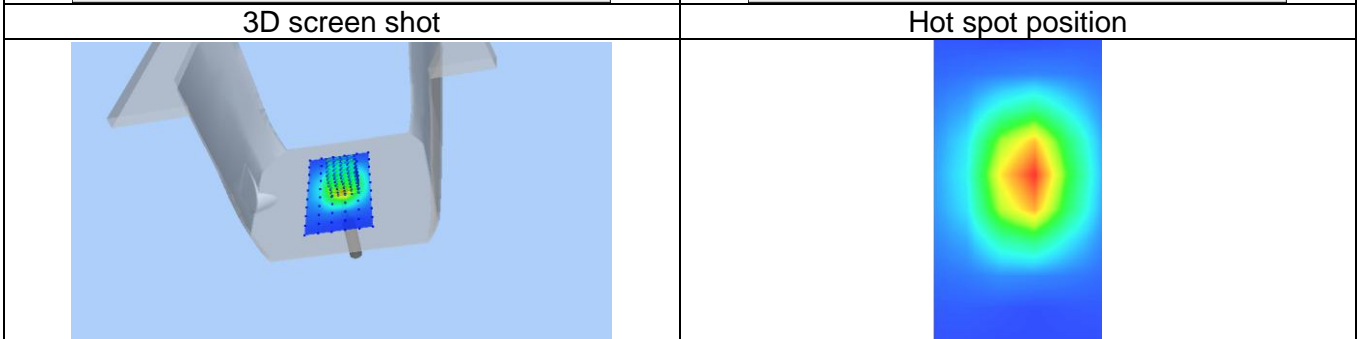
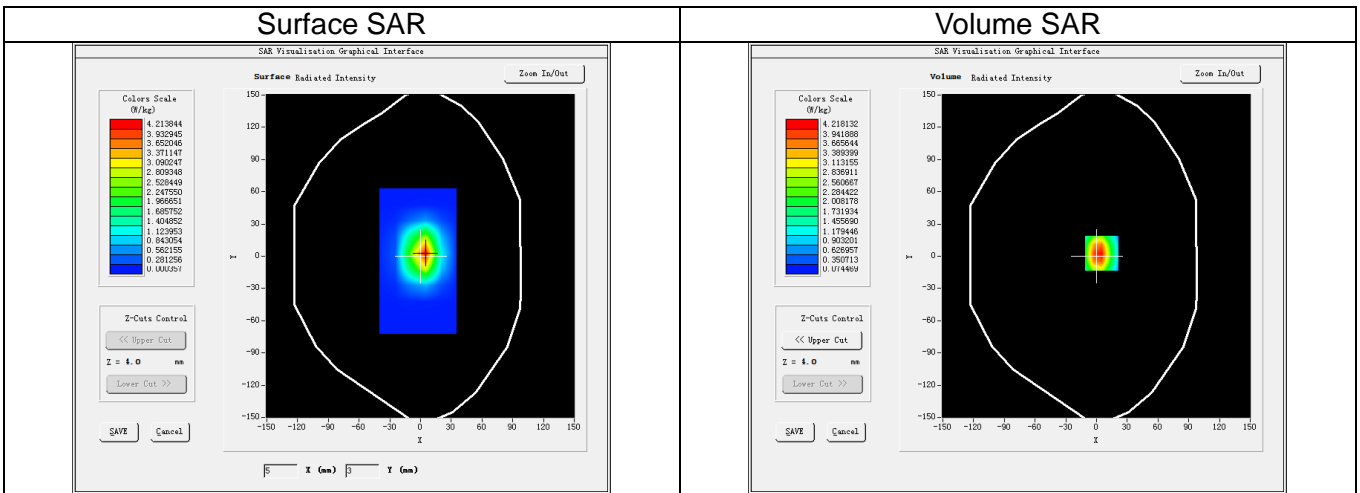

Maximum location: X=5.00, Y=3.00  
SAR Peak: 6.79 W/kg

SAR 1g (W/Kg)		4.194					
SAR 10g (W/Kg)		2.168					
Power Drift (±5%):		-0.41					
Z (mm)	0.00	4.00	9.00	14.00	19.00	24.00	29.00
SAR (W/Kg)	6.5171	4.2181	2.4087	1.4319	0.8520	0.5137	0.3110

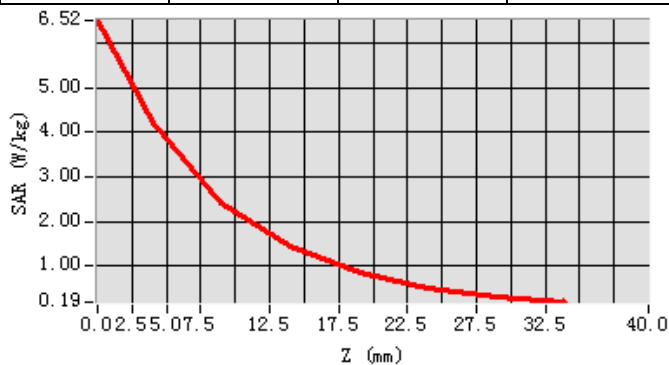

### System Performance Check - SID1900-Body

Date of measurement:	Apr. 25, 2017
Signal:	Communication System: CW; Frequency: 1900.00MHz; Duty Cycle: 1:1.00
ConvF:	2.00
Liquid Parameters:	Relative permittivity (real part): 53.51; Conductivity (S/m): 1.56;
Device Position:	Dipole
Area Scan:	dx=15mm dy=15mm, h=5.00mm
Zoom Scan:	5x5x7, dx=8mm dy=8mm dz=5mm, h=5.00mm

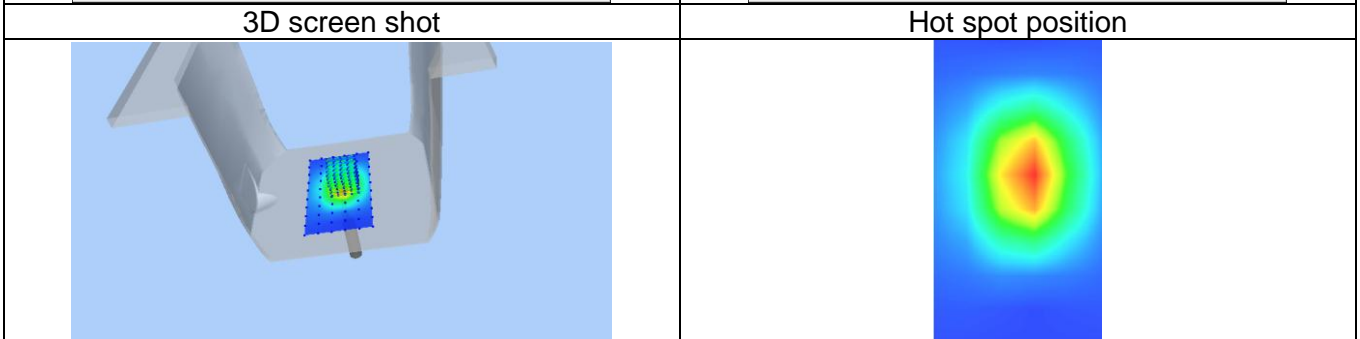
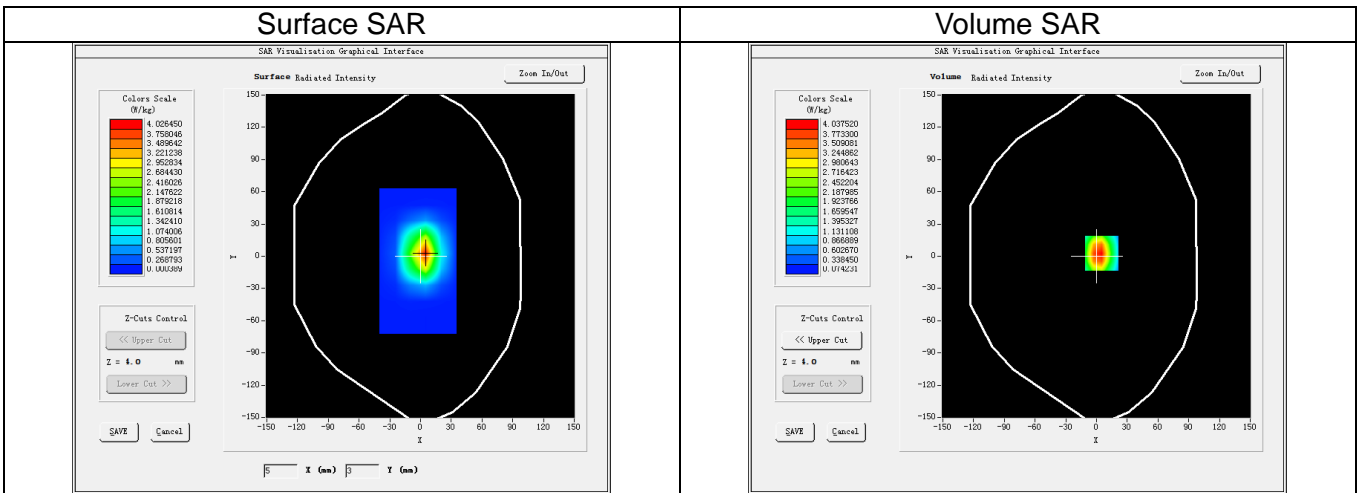

Maximum location: X=5.00, Y=3.00  
SAR Peak: 6.48 W/kg

SAR 1g (W/Kg)		4.010					
SAR 10g (W/Kg)		2.077					
Power Drift (±5%):		-0.44					
Z (mm)	0.00	4.00	9.00	14.00	19.00	24.00	29.00
SAR (W/Kg)	6.2230	4.0375	2.3143	1.3814	0.8253	0.5004	0.3048

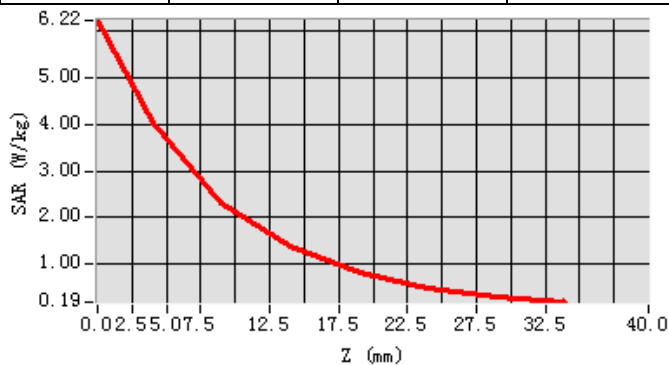

### System Performance Check - SID2450-Head

Date of measurement:	Apr. 20, 2017
Signal:	Communication System: CW; Frequency: 2450.00MHz; Duty Cycle: 1:1.00
ConvF:	2.03
Liquid Parameters:	Relative permittivity (real part): 39.94; Conductivity (S/m): 1.79;
Device Position:	Dipole
Area Scan:	dx=12mm dy=12mm, h=5.00mm
Zoom Scan:	7x7x7, dx=5mm dy=5mm dz=5mm, h=5.00mm

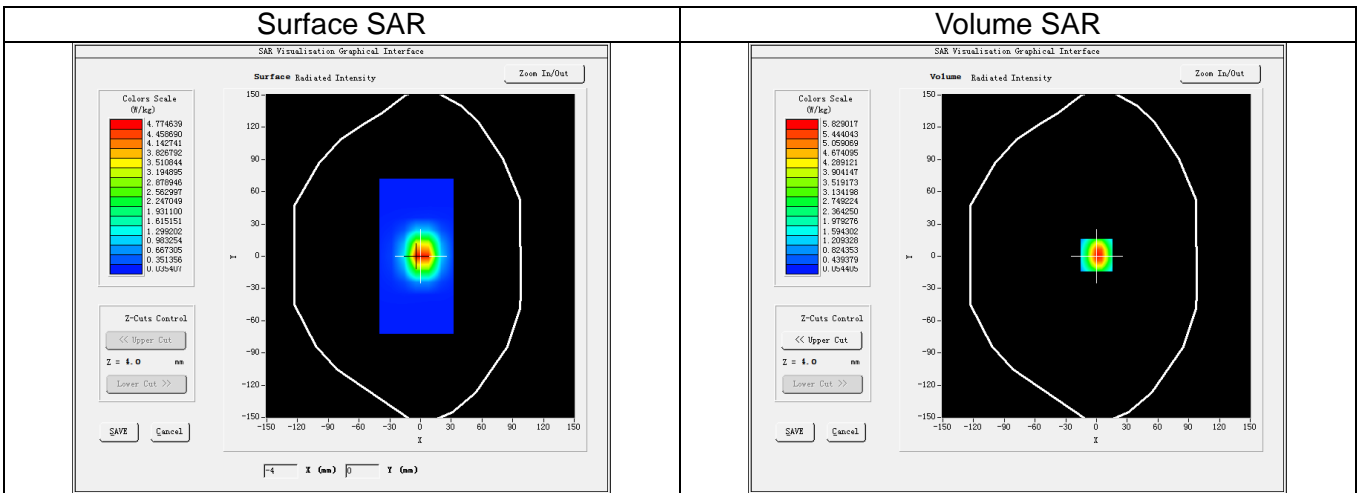

3D screen shot

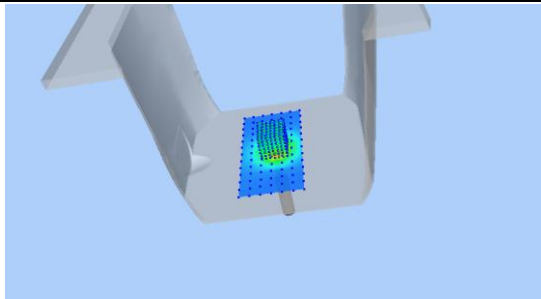

Hot spot position

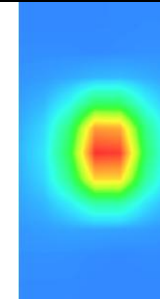

Maximum location: X=0.00, Y=1.00  
SAR Peak: 10.33 W/kg

SAR 1g (W/Kg)		5.484					
SAR 10g (W/Kg)		2.407					
Power Drift (±5%):		-0.28					
Z (mm)	0.00	4.00	9.00	14.00	19.00	24.00	29.00
SAR (W/Kg)	10.2468	5.8290	2.6528	1.2272	0.5648	0.2939	0.1571

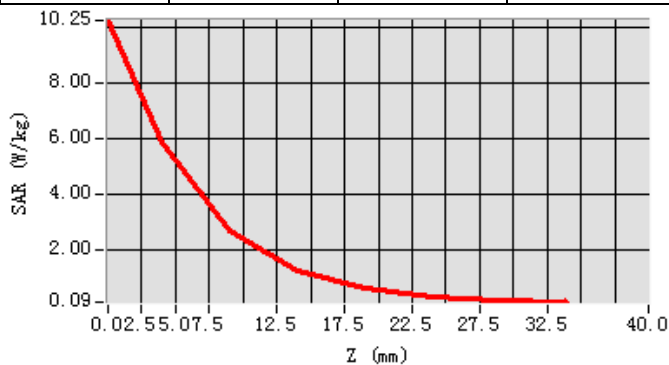



### System Performance Check - SID2450-Body

Date of measurement:	Apr. 20, 2017
Signal:	Communication System: CW; Frequency: 2450.00MHz; Duty Cycle: 1:1.00
ConvF:	2.10
Liquid Parameters:	Relative permittivity (real part): 52.33; Conductivity (S/m): 1.96;
Device Position:	Dipole
Area Scan:	dx=12mm dy=12mm, h=5.00mm
Zoom Scan:	7x7x7, dx=5mm dy=5mm dz=5mm, h=5.00mm

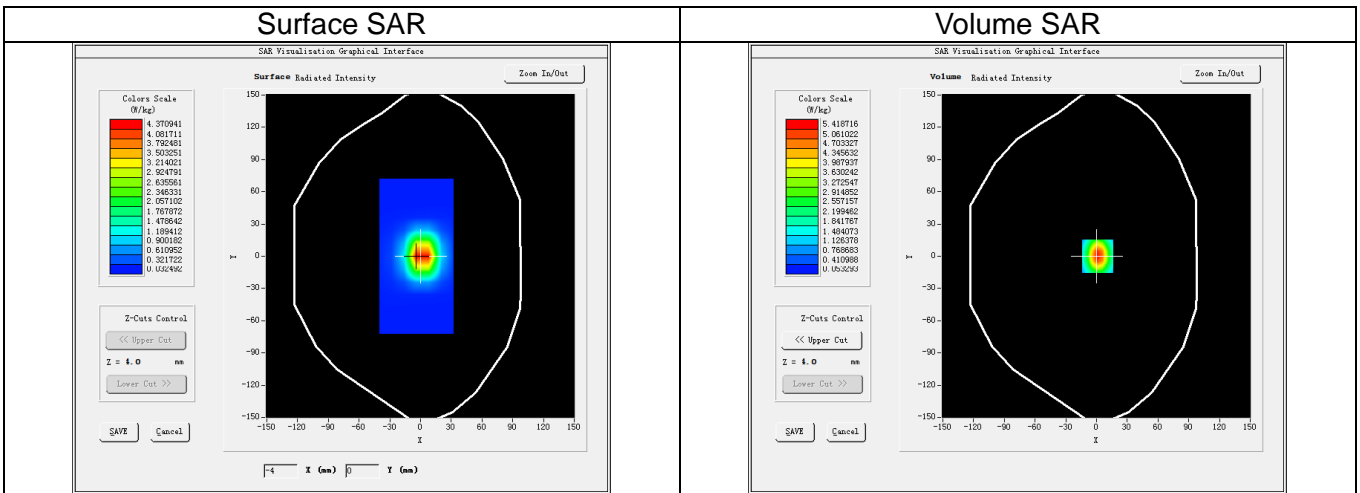

3D screen shot

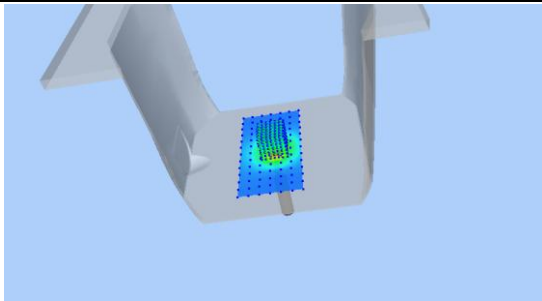

Hot spot position

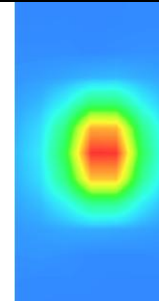

Maximum location: X=1.00, Y=0.00  
SAR Peak: 9.46 W/kg

SAR 1g (W/Kg)		5.015					
SAR 10g (W/Kg)		2.221					
Power Drift (±5%):		-0.04					
Z (mm)	0.00	4.00	9.00	14.00	19.00	24.00	29.00
SAR (W/Kg)	9.5562	5.4187	2.4710	1.1436	0.5549	0.2762	0.1471

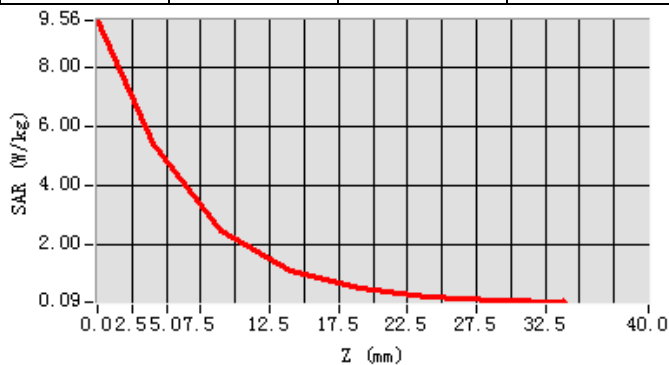

### System Performance Check - SID2600-Head

Date of measurement:	May. 04, 2017
Signal:	Communication System: CW; Frequency: 2600.00MHz; Duty Cycle: 1:1.00
ConvF:	2.11
Liquid Parameters:	Relative permittivity (real part): 39.02; Conductivity (S/m): 1.97;
Device Position:	Dipole
Area Scan:	dx=12mm dy=12mm, h=5.00mm
Zoom Scan:	7x7x7, dx=5mm dy=5mm dz=5mm, h=5.00mm

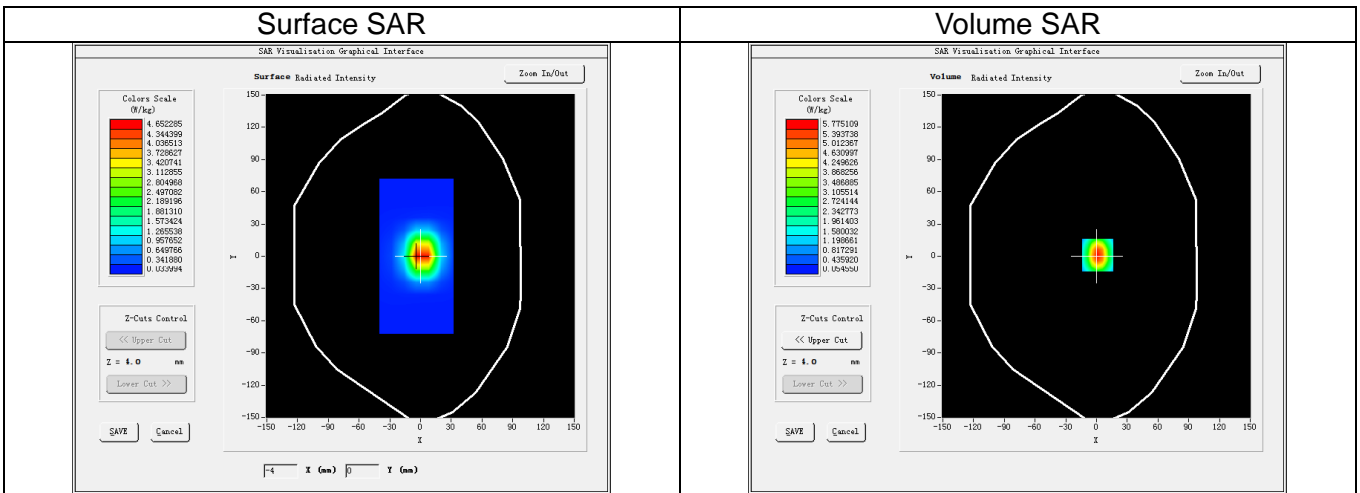

3D screen shot

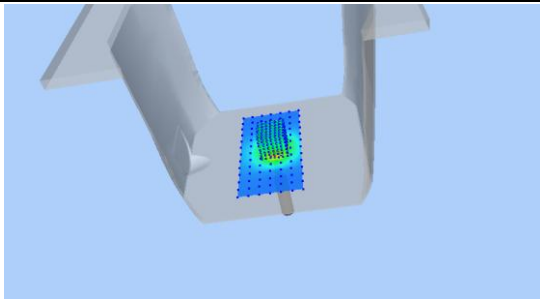

Hot spot position

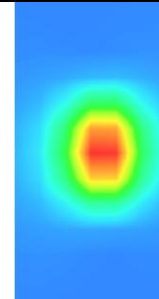

Maximum location: X=1.00, Y=1.00  
SAR Peak: 10.08 W/kg

SAR 1g (W/Kg)		5.340					
SAR 10g (W/Kg)		2.362					
Power Drift (±5%):		-0.05					
Z (mm)	0.00	4.00	9.00	14.00	19.00	24.00	29.00
SAR (W/Kg)	10.1922	5.7751	2.6280	1.2137	0.5848	0.2917	0.1545

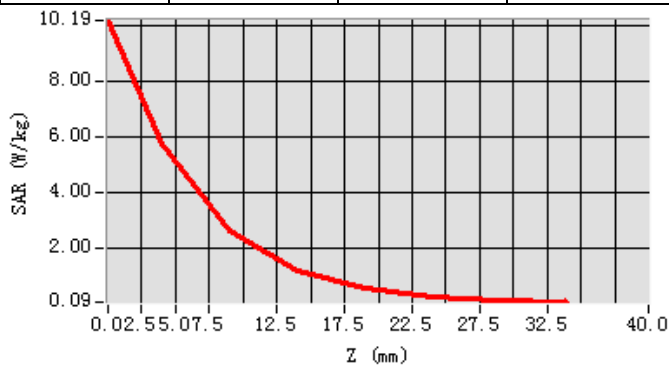

### System Performance Check - SID2600-Body

Date of measurement:	May. 08, 2017
Signal:	Communication System: CW; Frequency: 2600.00MHz; Duty Cycle: 1:1.00
ConvF:	2.17
Liquid Parameters:	Relative permittivity (real part): 53.70; Conductivity (S/m): 2.17;
Device Position:	Dipole
Area Scan:	dx=12mm dy=12mm, h=5.00mm
Zoom Scan:	7x7x7, dx=5mm dy=5mm dz=5mm, h=5.00mm

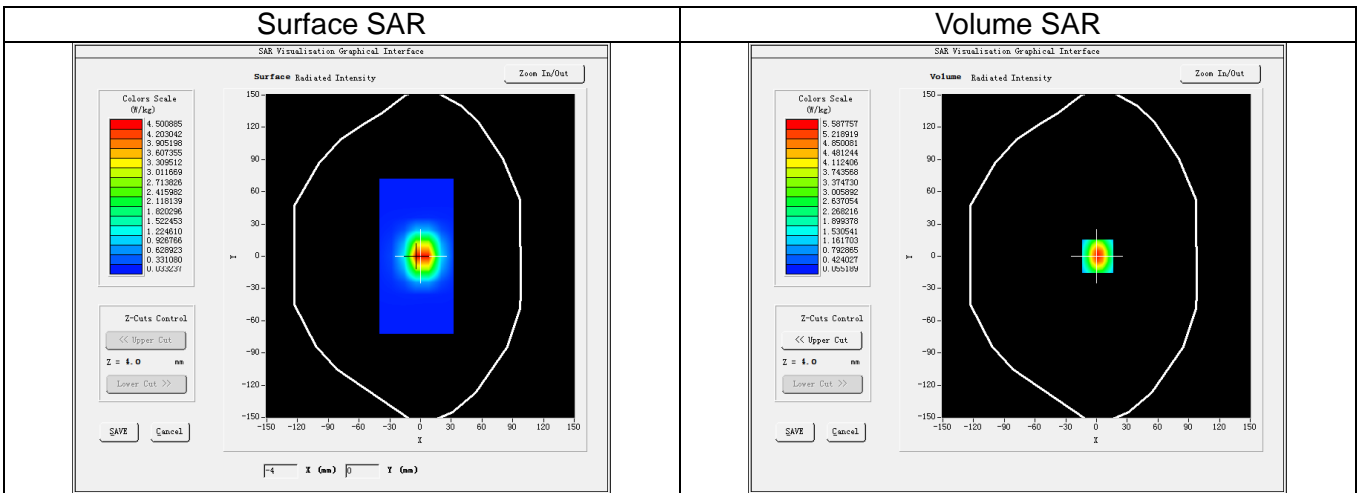

3D screen shot

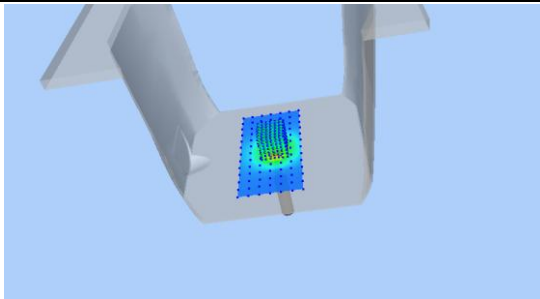

Hot spot position

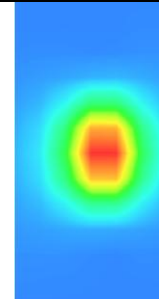

Maximum location: X=1.00, Y=0.00  
SAR Peak: 9.77 W/kg

SAR 1g (W/Kg)		5.175					
SAR 10g (W/Kg)		2.291					
Power Drift (±5%):		-0.08					
Z (mm)	0.00	4.00	9.00	14.00	19.00	24.00	29.00
SAR (W/Kg)	9.8539	5.5878	2.5471	1.1786	0.5689	0.2837	0.1504

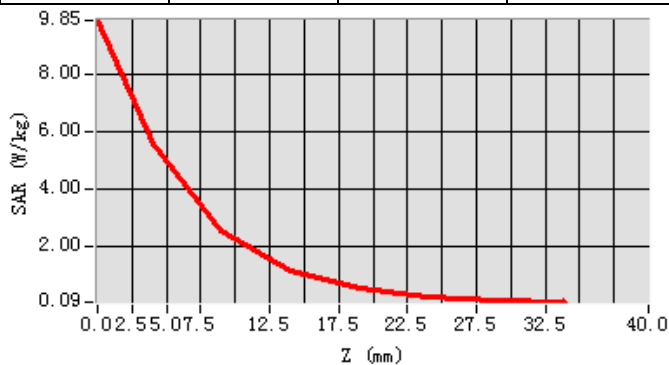

### 13. Appendix C. Plots of High SAR Measurement

<b>Table of contents</b>
<b>GSM 850 Head</b>
<b>GSM 850 Body</b>
<b>GSM 1900 Head</b>
<b>GSM 1900 Body</b>
<b>WCDMA Band V Head</b>
<b>WCDMA Band V Body</b>
<b>WCDMA Band II Head</b>
<b>WCDMA Band II Body</b>
<b>LTE Band V Head</b>
<b>LTE Band V Body</b>
<b>LTE Band IV Head</b>
<b>LTE Band IV Body</b>
<b>LTE Band II Head</b>
<b>LTE Band II Body</b>
<b>LTE Band VII Head</b>
<b>LTE Band VII Body</b>
<b>Wi-Fi 2.4G Head</b>
<b>Wi-Fi 2.4G Body</b>

**GSM850\_GPRS(GMSK 4TS)\_Ch189\_Right Cheek**

Date of measurement:	Apr. 22, 2017
Signal:	Communication System: GPRS(GMSK 4TS); Frequency: 836.40MHz; Duty Cycle: 1:2.08
ConvF:	1.53
Liquid Parameters:	Relative permittivity (real part): 42.51; Conductivity (S/m): 0.89;
Device Position:	Cheek
Area Scan:	dx=15mm dy=15mm, h=5.00mm
Zoom Scan:	5x5x7, dx=8mm dy=8mm dz=5mm, h=5.00mm

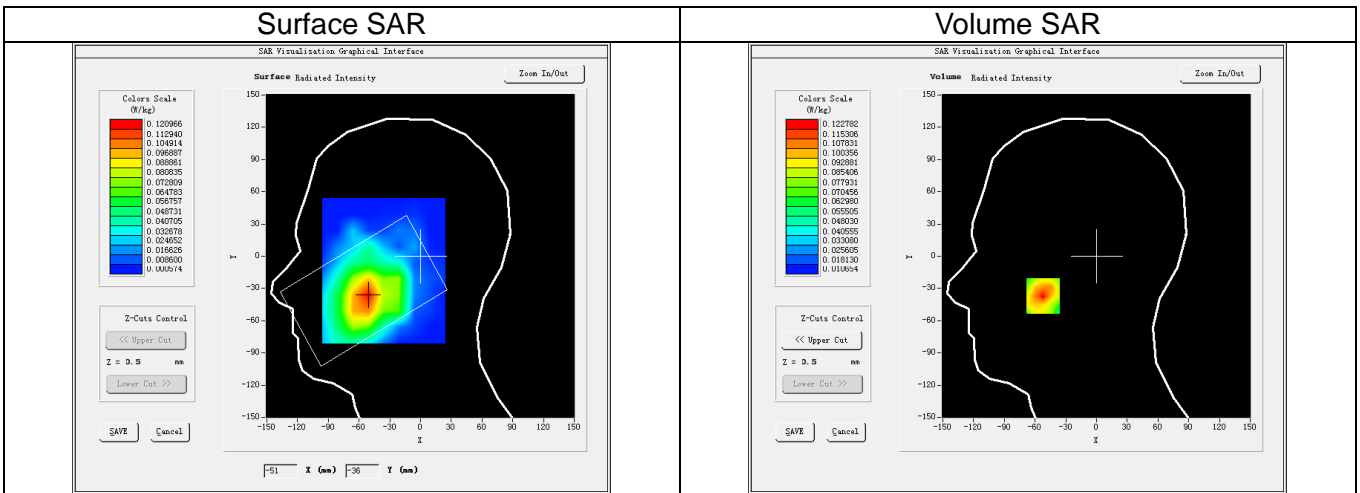

3D screen shot

Hot spot position

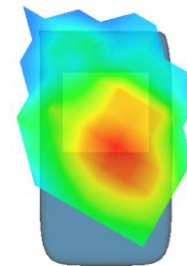
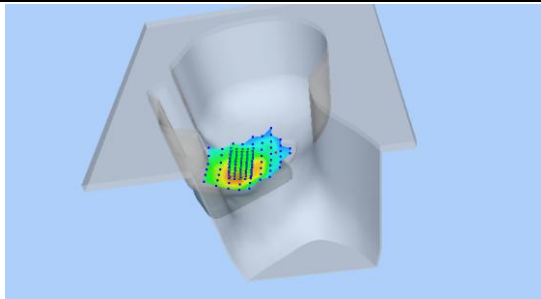

Maximum location: X=-52.00, Y=-37.00  
SAR Peak: 0.16 W/kg

SAR 1g (W/Kg)		0.110					
SAR 10g (W/Kg)		0.078					
Power Drift (±5%):		-4.92					
Z (mm)	0.00	4.00	9.00	14.00	19.00	24.00	29.00
SAR (W/Kg)	0.1343	0.1228	0.0848	0.0663	0.0488	0.0337	0.0226

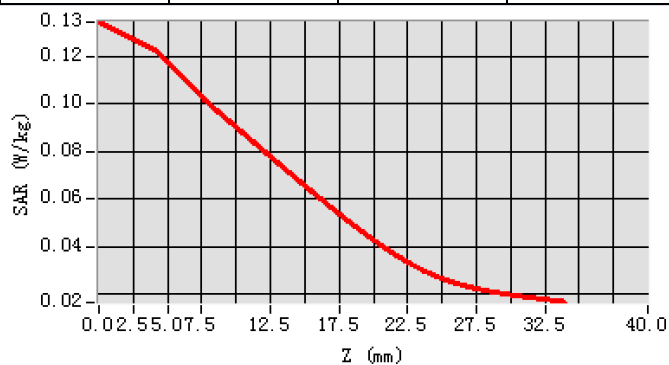

**GSM850\_GPRS(GMSK 4TS)\_Ch189\_Back Side\_10mm**

Date of measurement:	Apr. 22, 2017
Signal:	Communication System: GPRS(GMSK 4TS); Frequency: 836.40MHz; Duty Cycle: 1:2.08
ConvF:	1.59
Liquid Parameters:	Relative permittivity (real part): 55.36; Conductivity (S/m): 0.98;
Device Position:	Body
Area Scan:	dx=15mm dy=15mm, h=5.00mm
Zoom Scan:	5x5x7, dx=8mm dy=8mm dz=5mm, h=5.00mm

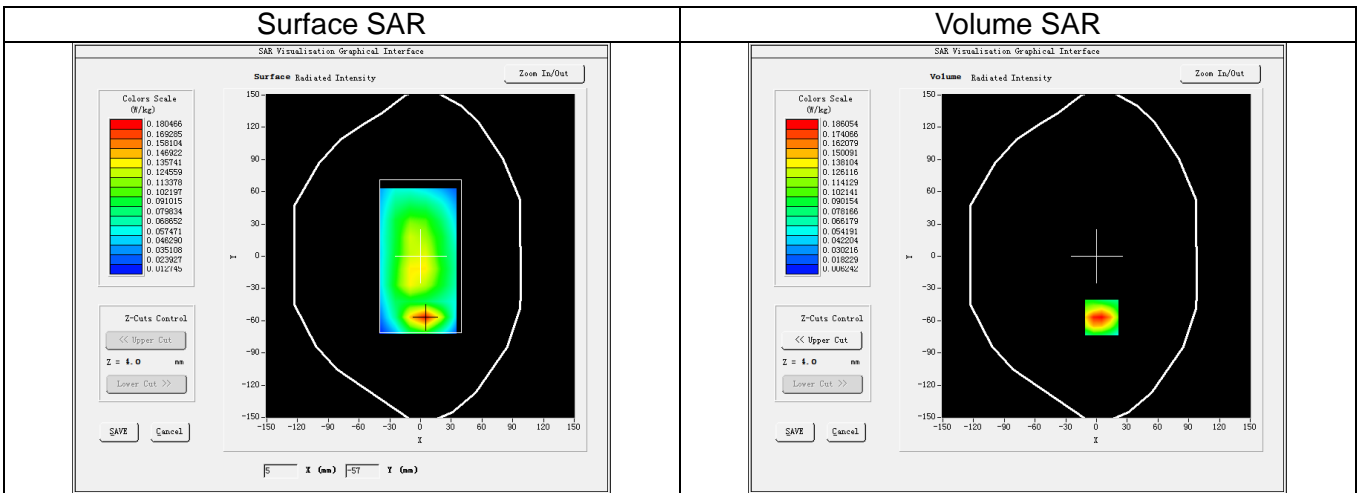

3D screen shot

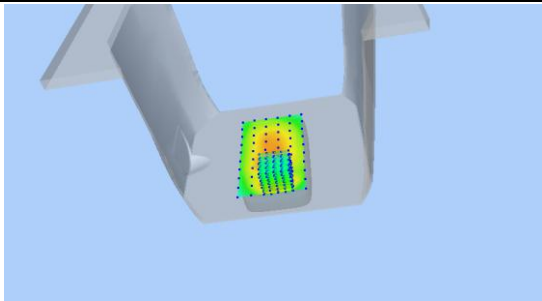

Hot spot position

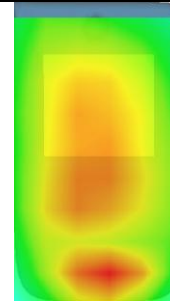

Maximum location: X=5.00, Y=-57.00  
SAR Peak: 0.29 W/kg

SAR 1g (W/Kg)		0.179					
SAR 10g (W/Kg)		0.100					
Power Drift (±5%):		-2.54					
Z (mm)	0.00	4.00	9.00	14.00	19.00	24.00	29.00
SAR (W/Kg)	0.2843	0.1861	0.1094	0.0683	0.0437	0.0294	0.0194

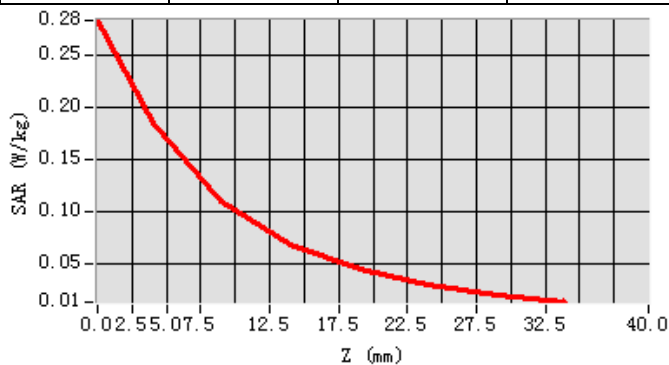

**GSM1900\_GPRS(GMSK 4TS)\_Ch810\_Right Cheek**

Date of measurement:	Apr. 25, 2017
Signal:	Communication System: GPRS(GMSK 4TS); Frequency: 1909.80MHz; Duty Cycle: 1:2.08
ConvF:	1.94
Liquid Parameters:	Relative permittivity (real part): 39.32; Conductivity (S/m): 1.43;
Device Position:	Cheek
Area Scan:	dx=15mm dy=15mm, h=5.00mm
Zoom Scan:	5x5x7, dx=8mm dy=8mm dz=5mm, h=5.00mm

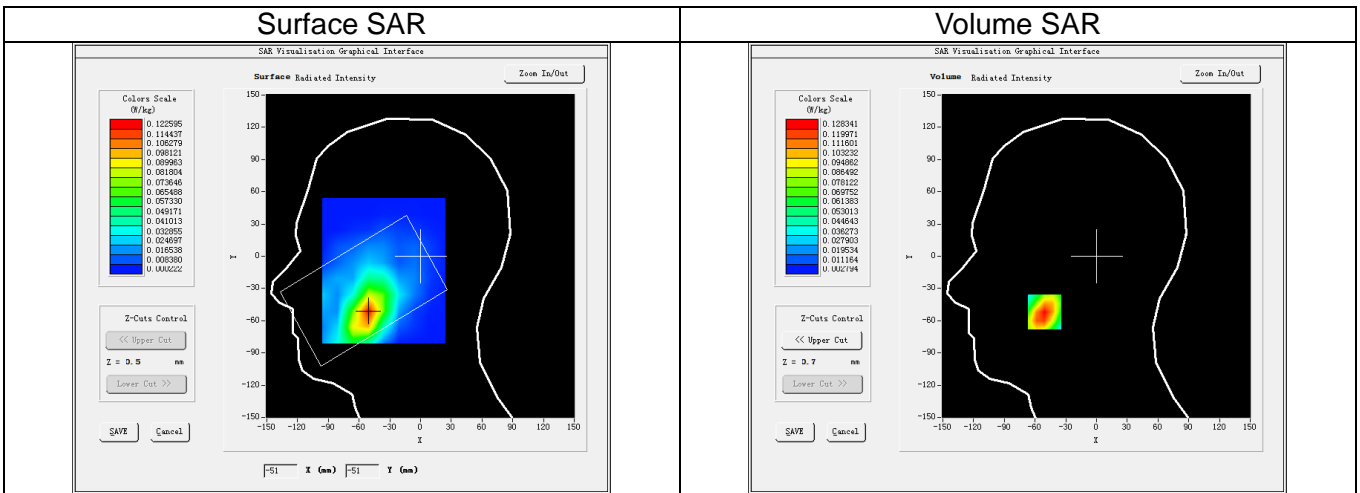

3D screen shot

Hot spot position

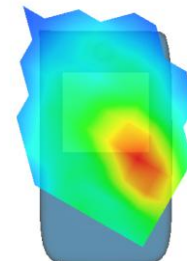
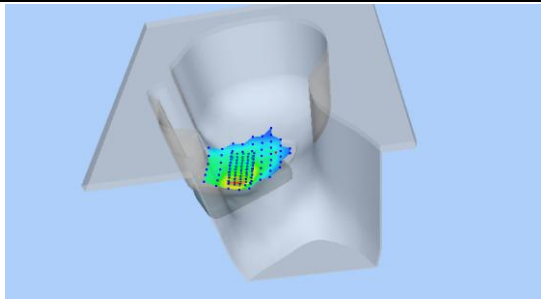

Maximum location: X=-51.00, Y=-52.00  
SAR Peak: 0.18 W/kg

SAR 1g (W/Kg)		0.124					
SAR 10g (W/Kg)		0.074					
Power Drift (±5%):		1.48					
Z (mm)	0.00	4.00	9.00	14.00	19.00	24.00	29.00
SAR (W/Kg)	0.1769	0.1283	0.0844	0.0576	0.0376	0.0263	0.0184

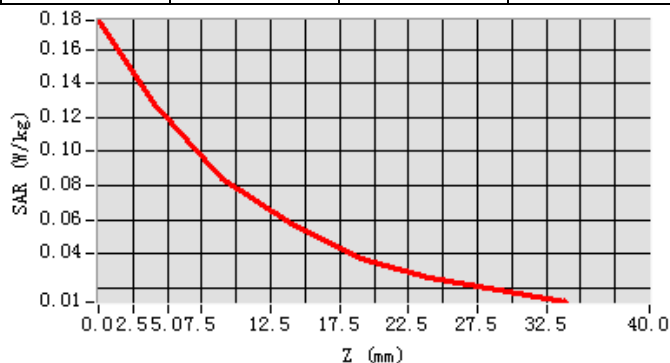

**GSM1900\_GPRS(GMSK 4TS)\_Ch810\_Back Side\_10mm**

Date of measurement:	Apr. 25, 2017
Signal:	Communication System: GPRS(GMSK 4TS); Frequency: 1909.80MHz; Duty Cycle: 1:2.08
ConvF:	2.00
Liquid Parameters:	Relative permittivity (real part): 53.51; Conductivity (S/m): 1.57;
Device Position:	Body
Area Scan:	dx=15mm dy=15mm, h=5.00mm
Zoom Scan:	5x5x7, dx=8mm dy=8mm dz=5mm, h=5.00mm

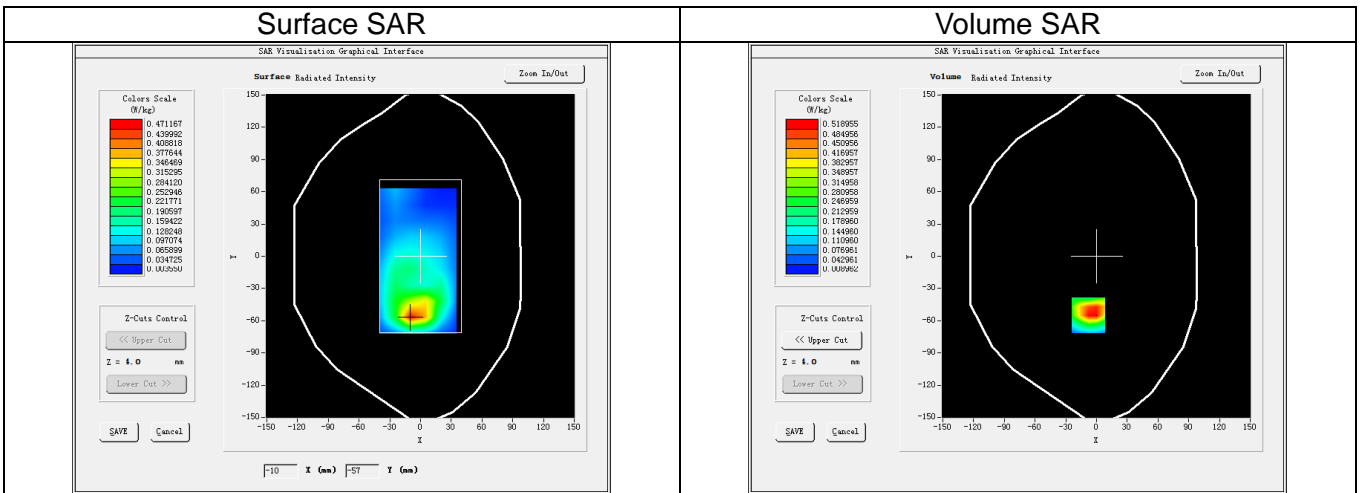

3D screen shot

Hot spot position

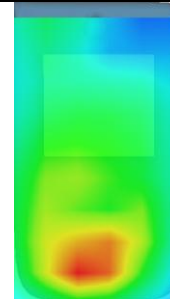
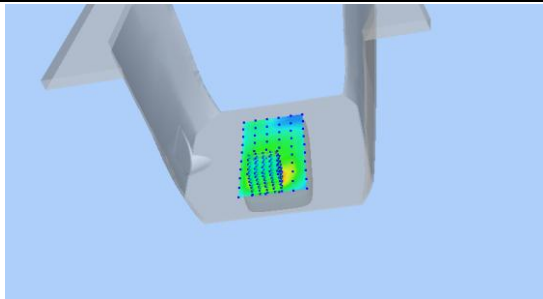

Maximum location: X=-8.00, Y=-55.00  
SAR Peak: 0.89 W/kg

SAR 1g (W/Kg)		0.531					
SAR 10g (W/Kg)		0.274					
Power Drift (±5%):		-0.31					
Z (mm)	0.00	4.00	9.00	14.00	19.00	24.00	29.00
SAR (W/Kg)	0.8927	0.5190	0.2560	0.1911	0.1010	0.0648	0.0359

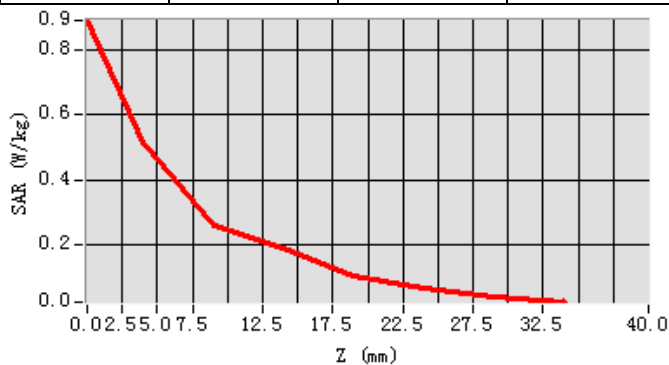



**GSM1900\_GPRS(GMSK 4TS)\_Ch810\_Bottom Side\_10mm**

Date of measurement:	Apr. 25, 2017
Signal:	Communication System: GPRS(GMSK 4TS); Frequency: 1909.80MHz; Duty Cycle: 1:2.08
ConvF:	2.00
Liquid Parameters:	Relative permittivity (real part): 53.51; Conductivity (S/m): 1.57;
Device Position:	Body
Area Scan:	dx=15mm dy=15mm, h=5.00mm
Zoom Scan:	5x5x7, dx=8mm dy=8mm dz=5mm, h=5.00mm

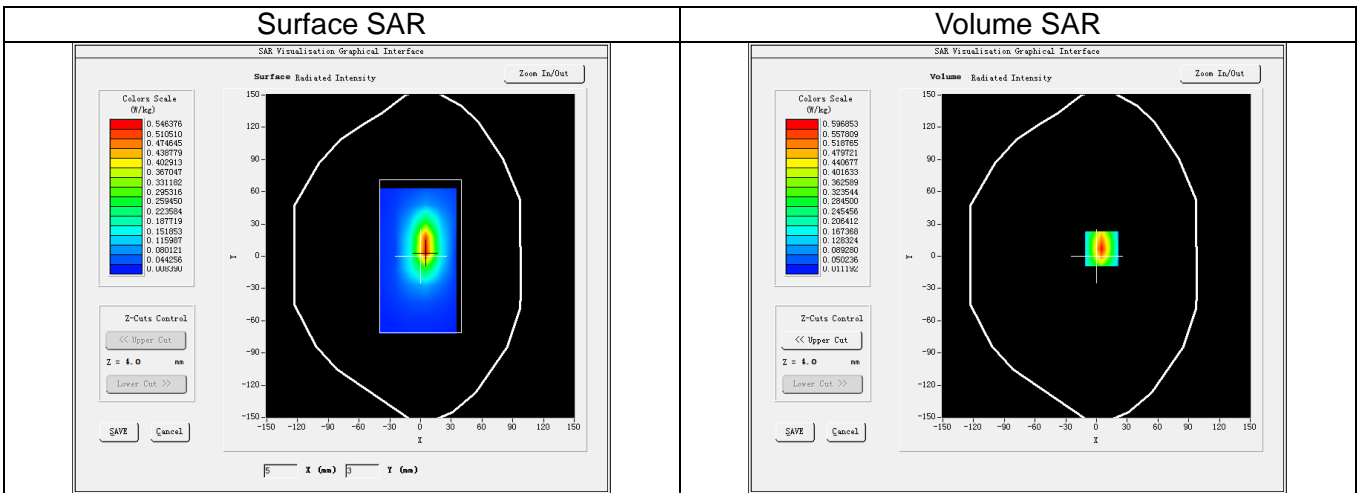

3D screen shot

Hot spot position

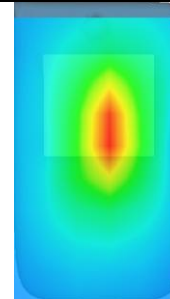
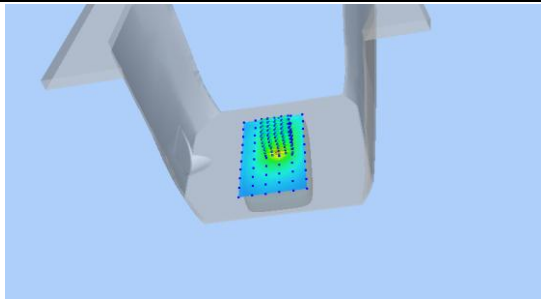

Maximum location: X=5.00, Y=7.00  
SAR Peak: 0.90 W/kg

SAR 1g (W/Kg)		0.549					
SAR 10g (W/Kg)		0.282					
Power Drift (±5%):		-4.20					
Z (mm)	0.00	4.00	9.00	14.00	19.00	24.00	29.00
SAR (W/Kg)	0.8986	0.5969	0.3523	0.2073	0.1254	0.0767	0.0459

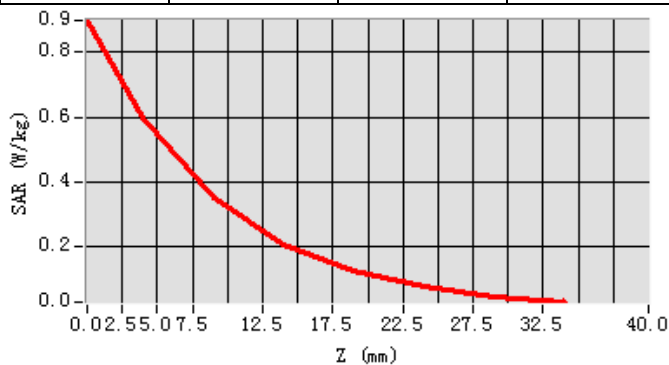

**WCDMA Band V\_RMC 12.2Kbps\_Ch4233\_Right Cheek**

Date of measurement:	Apr. 22, 2017
Signal:	Communication System: WCDMA-FDD(WCDMA); Frequency: 846.6MHz; Duty Cycle: 1:1.00
ConvF:	1.53
Liquid Parameters:	Relative permittivity (real part): 42.40; Conductivity (S/m): 0.91;
Device Position:	Cheek
Area Scan:	dx=15mm dy=15mm, h=5.00mm
Zoom Scan:	5x5x7, dx=8mm dy=8mm dz=5mm, h=5.00mm

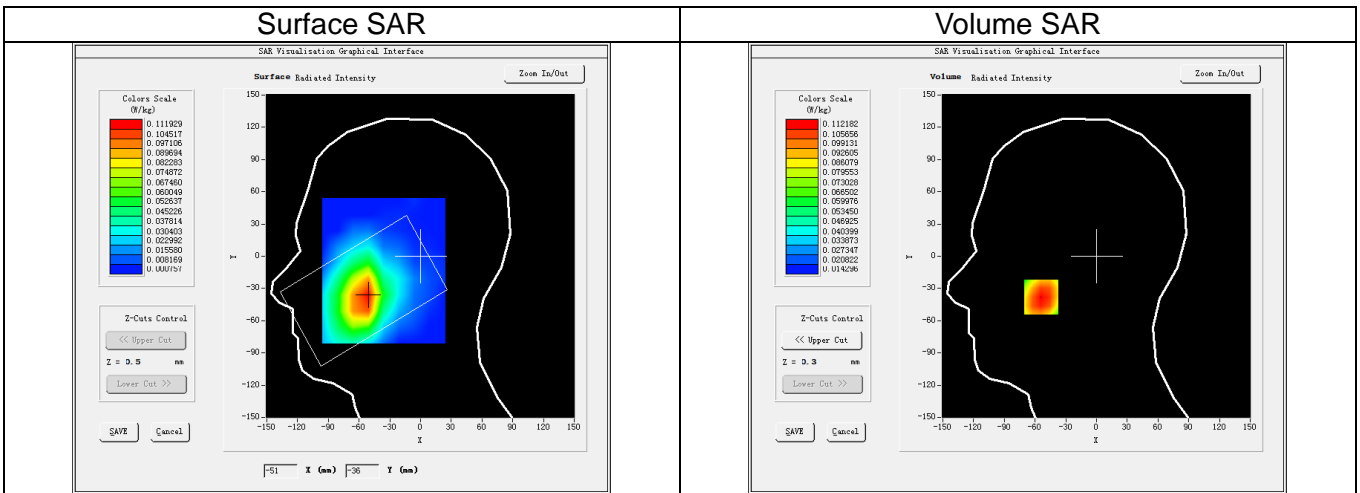

3D screen shot

Hot spot position

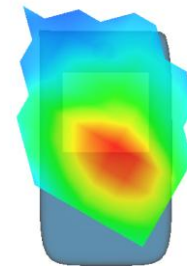
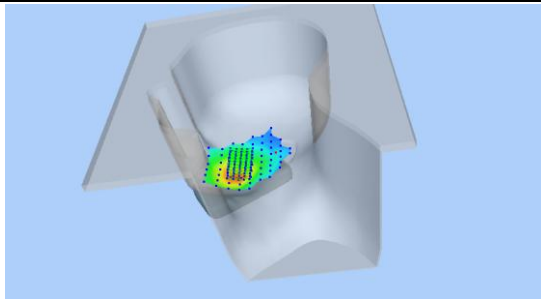

Maximum location: X=-54.00, Y=-38.00  
SAR Peak: 0.14 W/kg

SAR 1g (W/Kg)		0.109					
SAR 10g (W/Kg)		0.083					
Power Drift (±5%):		-0.66					
Z (mm)	0.00	4.00	9.00	14.00	19.00	24.00	29.00
SAR (W/Kg)	0.1327	0.1122	0.0922	0.0765	0.0616	0.0514	0.0394

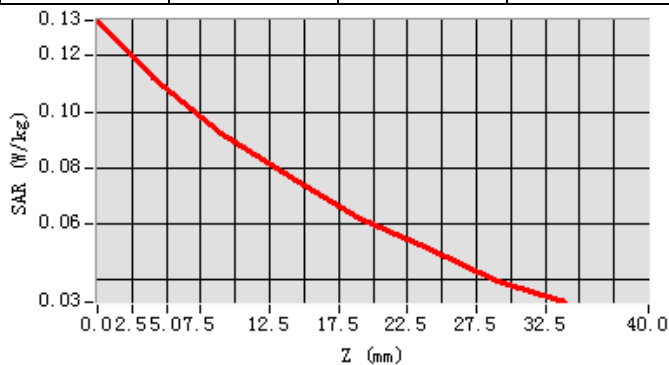

**WCDMA Band V\_RMC 12.2Kbps\_Ch4233\_Back Side\_10mm**

Date of measurement:	Apr. 22, 2017
Signal:	Communication System: WCDMA-FDD(WCDMA); Frequency: 846.60MHz; Duty Cycle: 1:1.00
ConvF:	1.59
Liquid Parameters:	Relative permittivity (real part): 55.29; Conductivity (S/m): 0.99;
Device Position:	Body
Area Scan:	dx=15mm dy=15mm, h=5.00mm
Zoom Scan:	5x5x7, dx=8mm dy=8mm dz=5mm, h=5.00mm

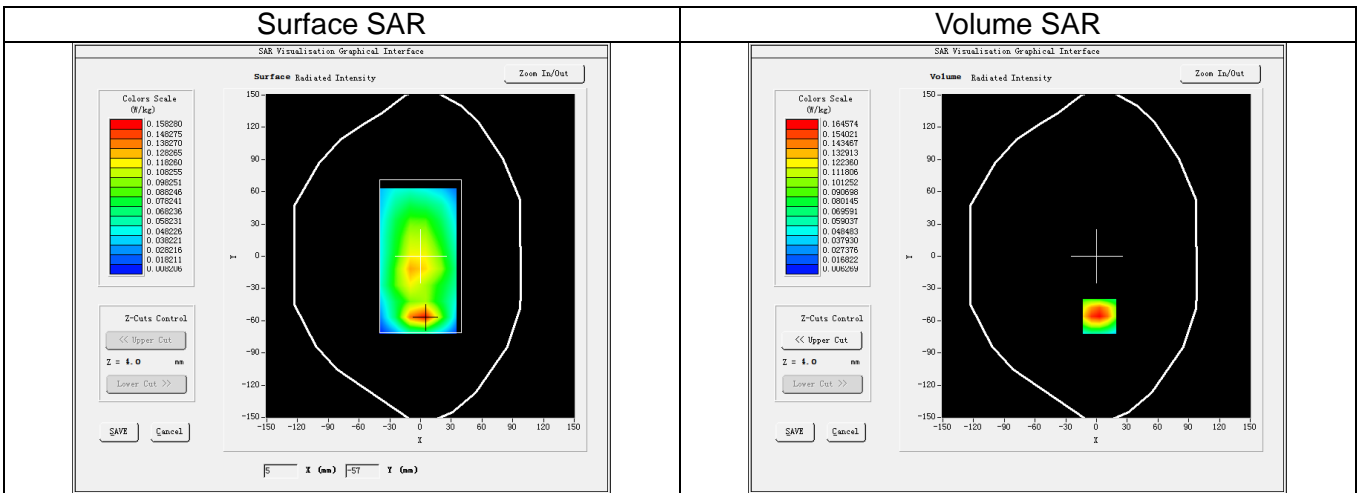

3D screen shot

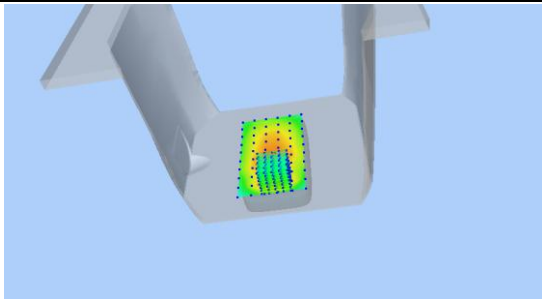

Hot spot position

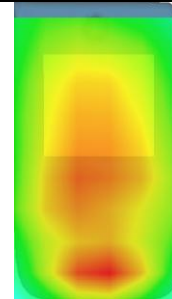

Maximum location: X=3.00, Y=-56.00  
SAR Peak: 0.25 W/kg

SAR 1g (W/Kg)		0.158					
SAR 10g (W/Kg)		0.091					
Power Drift (±5%):		0.78					
Z (mm)	0.00	4.00	9.00	14.00	19.00	24.00	29.00
SAR (W/Kg)	0.2374	0.1646	0.1032	0.0658	0.0423	0.0280	0.0187

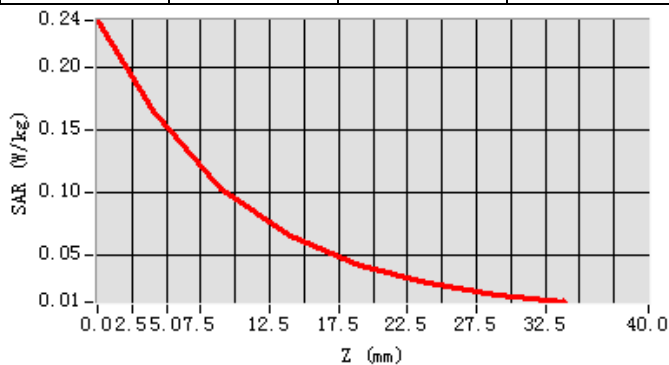

**WCDMA Band II\_RMC 12.2Kbps\_Ch9400\_Right Cheek**

Date of measurement:	Apr. 25, 2017
Signal:	Communication System: WCDMA-FDD(WCDMA); Frequency: 1880.00MHz; Duty Cycle: 1:1.00
ConvF:	1.94
Liquid Parameters:	Relative permittivity (real part): 39.43; Conductivity (S/m): 1.42;
Device Position:	Cheek
Area Scan:	dx=15mm dy=15mm, h=5.00mm
Zoom Scan:	5x5x7, dx=8mm dy=8mm dz=5mm, h=5.00mm

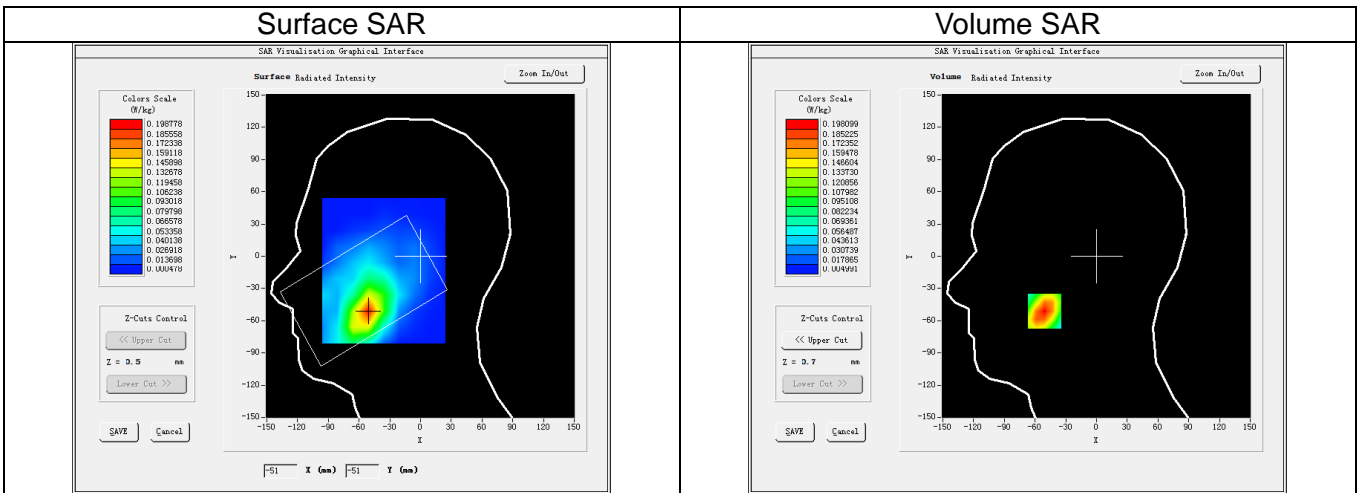

3D screen shot

Hot spot position

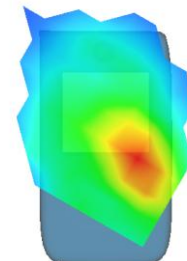
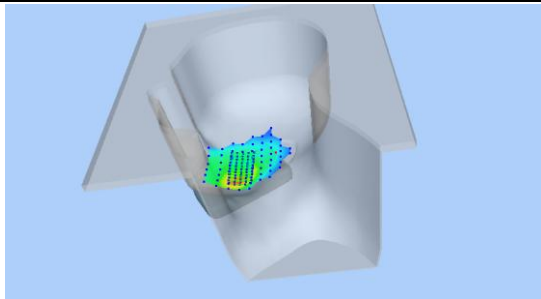

Maximum location: X=-51.00, Y=-51.00  
SAR Peak: 0.27 W/kg

SAR 1g (W/Kg)		0.190					
SAR 10g (W/Kg)		0.116					
Power Drift (±5%):		2.25					
Z (mm)	0.00	4.00	9.00	14.00	19.00	24.00	29.00
SAR (W/Kg)	0.2703	0.1981	0.1328	0.0918	0.0613	0.0424	0.0297

