

FCC Radio Test Report

FCC ID: 2ADQS-107001333

Report No. : BTL-FCCP-2-2411T019
Equipment : Portable Bluetooth Speaker
Model Name : ROCKSTER CROSS 2
Brand Name : **Teufel**
Applicant : Lautsprecher Teufel GmbH
Address : Budapester Str. 44, 10787 Berlin, Germany
Radio Function : Bluetooth Low Energy
FCC Rule Part(s) : FCC CFR Title 47, Part 15, Subpart C (15.247)
Measurement Procedure(s) : ANSI C63.10-2013
Date of Receipt : 2024/11/4
Date of Test : 2024/11/12 ~ 2024/11/25
Issued Date : 2025/2/14

The above equipment has been tested and found in compliance with the requirement of the above standards by BTL Inc.

Prepared by : Brett Shen
Brett Shen, Engineer

Approved by : Jerry Chuang
Jerry Chuang, Supervisor

**BTL Inc.**

No.18, Ln. 171, Sec. 2, Jiuzong Rd., Neihu Dist., Taipei City 114, Taiwan

Tel: +886-2-2657-3299 Fax: +886-2-2657-3331 Web: www.newbtl.com Service mail: btl_qa@newbtl.com

Declaration

BTL represents to the client that testing is done in accordance with standard procedures as applicable and that test instruments used has been calibrated with standards traceable to international standard(s) and/or national standard(s).

BTL's reports apply only to the specific samples tested under conditions. It is manufacture's responsibility to ensure that additional production units of this model are manufactured with the identical electrical and mechanical components. **BTL** assumes no responsibility for the data provided by the Customer, any statements, inferences or generalizations drawn by the customer or others from the reports issued by **BTL**.

This report is the confidential property of the client. As a mutual protection to the clients, the public and ourselves, the test report shall not be reproduced, except in full, without our written approval.

BTL's laboratory quality assurance procedures are in compliance with the **ISO/IEC 17025** requirements, and accredited by the conformity assessment authorities listed in this test report.

BTL is not responsible for the sampling stage, so the results only apply to the sample as received.

The information, data and test plan are provided by manufacturer which may affect the validity of results, so it is manufacturer's responsibility to ensure that the apparatus meets the essential requirements of applied standards and in all the possible configurations as representative of its intended use.

Limitation

For the use of the authority's logo is limited unless the Test Standard(s)/Scope(s)/Item(s) mentioned in this test report is (are) included in the conformity assessment authorities acceptance respective.

Please note that the measurement uncertainty is provided for informational purpose only and are not use in determining the Pass/Fail results.

CONTENTS

REVISION HISTORY	5
1 SUMMARY OF TEST RESULTS	6
1.1 TEST FACILITY	7
1.2 MEASUREMENT UNCERTAINTY	7
1.3 TEST ENVIRONMENT CONDITIONS	7
1.4 DUTY CYCLE	8
2 GENERAL INFORMATION	9
2.1 DESCRIPTION OF EUT	9
2.2 TEST MODES	12
2.3 BLOCK DIAGRAM SHOWING THE CONFIGURATION OF SYSTEM TESTED	13
2.4 SUPPORT UNITS	14
3 AC POWER LINE CONDUCTED EMISSIONS TEST	15
3.1 LIMIT	15
3.2 TEST PROCEDURE	15
3.3 DEVIATION FROM TEST STANDARD	16
3.4 TEST SETUP	16
3.5 EUT OPERATION CONDITIONS	16
3.6 TEST RESULT	16
4 RADIATED EMISSIONS TEST	17
4.1 LIMIT	17
4.2 TEST PROCEDURE	18
4.3 DEVIATION FROM TEST STANDARD	18
4.4 TEST SETUP	18
4.5 EUT OPERATING CONDITIONS	19
4.6 TEST RESULT – 9 KHZ TO 30 MHZ	20
4.7 TEST RESULT – 30 MHZ TO 1 GHZ	20
4.8 TEST RESULT – ABOVE 1 GHZ	20
5 BANDWIDTH TEST	21
5.1 APPLIED PROCEDURES / LIMIT	21
5.2 TEST PROCEDURE	21
5.3 DEVIATION FROM STANDARD	21
5.4 TEST SETUP	21
5.5 EUT OPERATION CONDITIONS	21
5.6 TEST RESULTS	21
6 OUTPUT POWER TEST	22
6.1 APPLIED PROCEDURES / LIMIT	22
6.2 TEST PROCEDURE	22
6.3 DEVIATION FROM STANDARD	22
6.4 TEST SETUP	22
6.5 EUT OPERATION CONDITIONS	22
6.6 TEST RESULTS	22
7 POWER SPECTRAL DENSITY TEST	23
7.1 APPLIED PROCEDURES / LIMIT	23
7.2 TEST PROCEDURE	23
7.3 DEVIATION FROM STANDARD	23
7.4 TEST SETUP	23
7.5 EUT OPERATION CONDITIONS	23

7.6	TEST RESULTS	23
8	ANTENNA CONDUCTED SPURIOUS EMISSION	24
8.1	APPLIED PROCEDURES / LIMIT	24
8.2	TEST PROCEDURE	24
8.3	DEVIATION FROM STANDARD	24
8.4	TEST SETUP	24
8.5	EUT OPERATION CONDITIONS	24
8.6	TEST RESULTS	24
9	LIST OF MEASURING EQUIPMENTS	25
10	EUT TEST PHOTO	27
11	EUT PHOTOS	27
APPENDIX A	AC POWER LINE CONDUCTED EMISSIONS	28
APPENDIX B	RADIATED EMISSIONS - 9 KHZ TO 30 MHZ	33
APPENDIX C	RADIATED EMISSIONS - 30 MHZ TO 1 GHZ	38
APPENDIX D	RADIATED EMISSIONS - ABOVE 1 GHZ	41
APPENDIX E	BANDWIDTH	60
APPENDIX F	OUTPUT POWER	63
APPENDIX G	POWER SPECTRAL DENSITY TEST	65
APPENDIX H	ANTENNA CONDUCTED SPURIOUS EMISSION	68

REVISION HISTORY

Report No.	Version	Description	Issued Date	Note
BTL-FCCP-2-2411T019	R00	Original Report.	2025/2/14	Valid

1 SUMMARY OF TEST RESULTS

Test procedures according to the technical standards.

Standard(s) Section	Description	Test Result	Judgement	Remark
15.207	AC Power Line Conducted Emissions	APPENDIX A	Pass	-----
15.205 15.209 15.247(d)	Radiated Emissions	APPENDIX B APPENDIX C APPENDIX D	Pass	-----
15.247(a)(2)	Bandwidth	APPENDIX E	Pass	-----
15.247(b)(3)	Output Power	APPENDIX F	Pass	-----
15.247(e)	Power Spectral Density	APPENDIX G	Pass	-----
15.247(d)	Antenna conducted Spurious Emission	APPENDIX H	Pass	-----
15.203	Antenna Requirement	-----	Pass	-----

Statement of Conformity

The statement of conformity is based on the binary decision rule according to IEC Guide 115 and ILAC G8 "simple acceptance" principle. Without considering measurement uncertainty, its specific risk is less than 50% PFA. (PFA: Probability of False Accept)

NOTE:

- (1) "N/A" denotes test is not applicable in this Test Report.
- (2) The report format version is TP.1.1.1.

1.1 TEST FACILITY

The test locations stated below are under the TAF Accreditation Number 0659.

The test location(s) used to collect the test data in this report are:

No. 68-1, Ln. 169, Sec. 2, Datong Rd., Xizhi Dist., New Taipei City 221, Taiwan
(FCC DN: TW0659)

C05 CB08 CB11 SR10 SR11

No. 72, Ln. 169, Sec. 2, Datong Rd., Xizhi Dist., New Taipei City 221, Taiwan
(FCC DN: TW0659)

C06 CB21 CB22

1.2 MEASUREMENT UNCERTAINTY

The reported uncertainty of measurement $y \pm U$, where expanded uncertainty U is based on a standard uncertainty multiplied by a coverage factor of $k = 2$, providing a level of confidence of approximately **95 %**.

A. AC power line conducted emissions test:

Test Site	Method	Measurement Frequency Range	U (dB)
C05	CISPR	150 kHz ~ 30MHz	3.44

B. Radiated emissions test :

Test Site	Measurement Frequency Range	U (dB)
CB21	0.03 GHz ~ 0.2 GHz	4.17
	0.2 GHz ~ 1 GHz	4.72
	1 GHz ~ 6 GHz	5.21
	6 GHz ~ 18 GHz	5.51
	18 GHz ~ 26 GHz	3.69
	26 GHz ~ 40 GHz	4.23

C. Conducted test :

Test Item	U (dB)
Occupied Bandwidth	0.5334
Output power	0.3669
Power Spectral Density	0.6591
Conducted Spurious emissions	0.5416
Conducted Band edges	0.5348

NOTE:

Unless specifically mentioned, the uncertainty of measurement has not been taken into account to declare the compliance or non-compliance to the specification.

1.3 TEST ENVIRONMENT CONDITIONS

Test Item	Environment Condition	Test Voltage	Tested by
AC Power Line Conducted Emissions	23 °C, 64 %	AC 120V	Ken Lan
Radiated emissions below 1 GHz	25 °C, 60 %	AC 120V	Emily Chang
Radiated emissions above 1 GHz	25 °C, 60 %	AC 120V	Emily Chang
Bandwidth	22 °C, 54 %	AC 120V	Easton Tsai
Output Power	22 °C, 54 %	AC 120V	Easton Tsai
Power Spectral Density	22 °C, 54 %	AC 120V	Easton Tsai
Antenna conducted Spurious Emission	22 °C, 54 %	AC 120V	Easton Tsai

1.4 DUTY CYCLE

If duty cycle is $\geq 98\%$, duty factor is not required.
 If duty cycle is $< 98\%$, duty factor shall be considered.

Remark	Delta 2			Delta 3	On Time/Period	10 log(1/Duty Cycle)
Mode	ON (ms)	Numbers (ON)	On Time (B) (ms)	Period (ON+OFF) (ms)	Duty Cycle (%)	Duty Factor (dB)
BLE 5.2 (1 Mbps)	2.130	1	2.130	2.514	84.73%	0.72
BLE 5.2 (2 Mbps)	1.062	1	1.062	1.254	84.69%	0.72

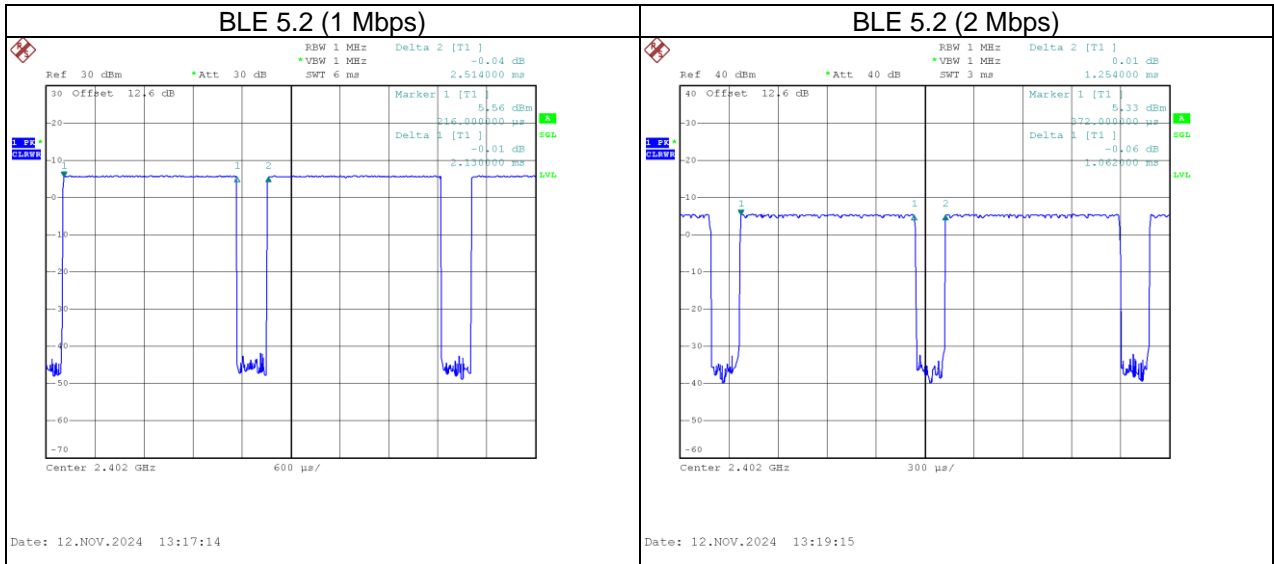

2 GENERAL INFORMATION

2.1 DESCRIPTION OF EUT

Equipment	Portable Bluetooth Speaker
Model Name	ROCKSTER CROSS 2
Brand Name	Teufel
Model Difference	N/A
Power Source	#1 Supplied from Type-C port. #2 Supplied from battery.
Power Rating	#1 DC 5/9/12/15/20V #2 DC 7.4V / 5510mAh
Products Covered	1 * Type-C USB cable 1 * Strap
HW Version	Main-V4/ IO-V3 / Key_LED-V4
AE Version	Same as current Rockster Cross 2018
ME Version	Released DV2 3D
FW Version	EEPROM:V1.3 BT:V0.8.02
Operation Band	2400 MHz ~ 2483.5 MHz
Operation Frequency	2402 MHz ~ 2480 MHz
Modulation Technology	GFSK
Transfer Rate	1 Mbps, 2 Mbps
Output Power Max.	1 Mbps: 6.65 dBm (0.0046 W) 2 Mbps: 6.57 dBm (0.0045 W)
Test Software Version	BT FCC Tool V2.25
Test Model	ROCKSTER CROSS 2
Sample Status	Engineering Sample
EUT Modification(s)	N/A

NOTE:

(1) The above EUT information is declared by manufacturer and for more detailed features description, please refers to the manufacturer's specifications or user's manual.

(2) Channel List:

Channel	Frequency (MHz)	Channel	Frequency (MHz)
00	2402	20	2442
01	2404	21	2444
02	2406	22	2446
03	2408	23	2448
04	2410	24	2450
05	2412	25	2452
06	2414	26	2454
07	2416	27	2456
08	2418	28	2458
09	2420	29	2460
10	2422	30	2462
11	2424	31	2464
12	2426	32	2466
13	2428	33	2468
14	2430	34	2470
15	2432	35	2472
16	2434	36	2474
17	2436	37	2476
18	2438	38	2478

19	2440	39	2480
----	------	----	------

(3) Table for Filed Antenna:

Antenna	Manufacture	Model Name	Type	Connector	Frequency (MHz)	Gain (dBi)
1		YD-S01	PCB	N/A	2400-2480	2.57

(4) The above Antenna information are derived from the antenna data sheet provided by manufacturer and for more detailed features description, please refer to the manufacturer's specifications, the laboratory shall not be held responsible.

2.2 TEST MODES

Test Items	Test mode	Channel	Note
AC power line conducted emissions	Normal/Idle	-	-
Transmitter Radiated Emissions (below 1GHz)	1 Mbps	39	-
Transmitter Radiated Emissions (above 1GHz)	1/2 Mbps	00/39	Bandedge
	1/2 Mbps	00/19/39	Harmonic
Transmitter Radiated Emissions (above 18GHz)	1 Mbps	39	-
Bandwidth	1/2 Mbps	00/19/39	-
Output Power	1/2 Mbps	00/19/39	-
Power Spectral Density	1/2 Mbps	00/19/39	-
Antenna conducted Spurious Emission	1/2 Mbps	00/19/39	-

NOTE:

- (1) For radiated emission band edge test, both Vertical and Horizontal are evaluated, but only the worst case (Horizontal) is recorded.
- (2) All X, Y and Z axes are evaluated, but only the worst case (X axis) is recorded.
- (3) The EUT supports both BLE 4.0 and 5.3, we will pick BLE 5.3 for testing.

2.3 BLOCK DIAGRAM SHOWING THE CONFIGURATION OF SYSTEM TESTED

Equipment letters and Cable numbers refer to item numbers described in the tables of clause 2.4.

AC power line conducted emissions

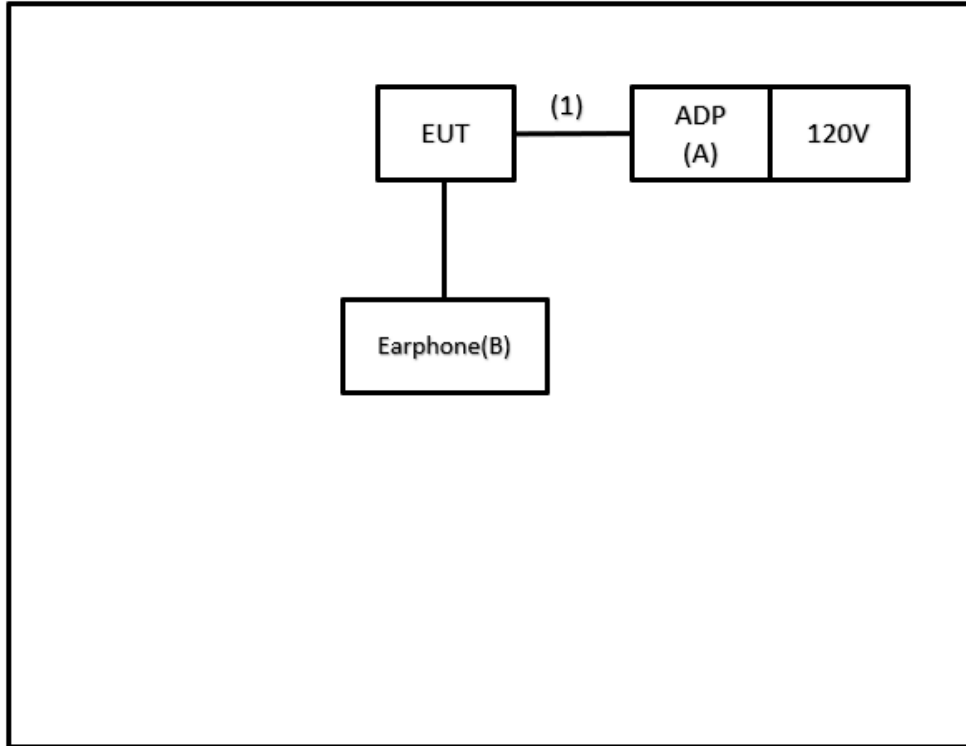

Radiated Emissions

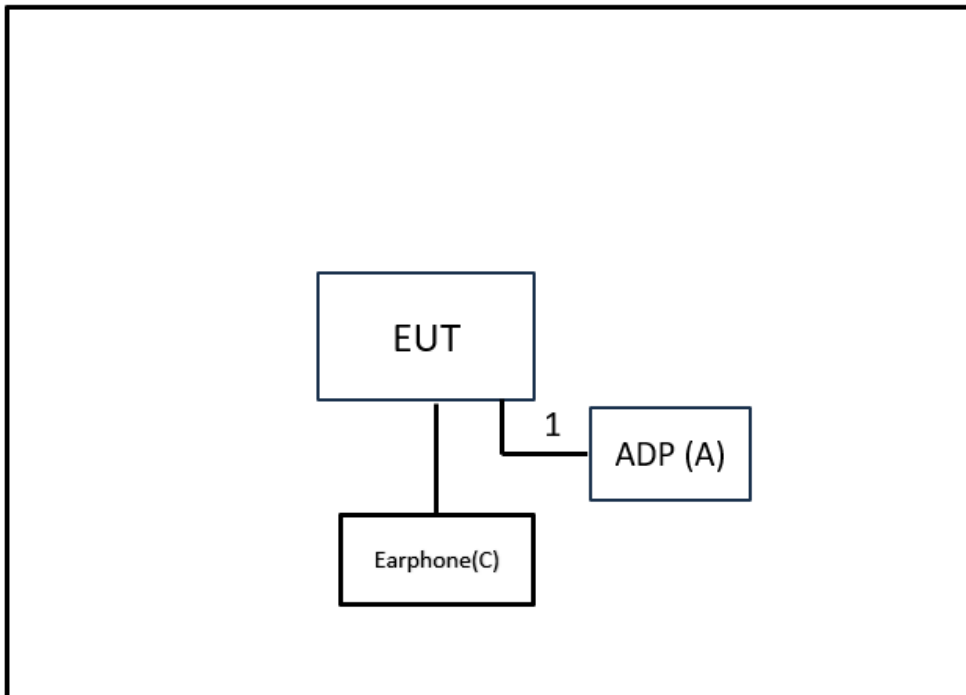

2.4 SUPPORT UNITS

Item	Equipment	Brand	Model No.	Series No.	Remarks
A	ADP	N/A	N/A	N/A	Supplied by test requester
B	Earphone	N/A	N/A	N/A	Furnished by test lab.
C	Earphone	N/A	N/A	N/A	Furnished by test lab.

Item	Shielded	Ferrite Core	Length	Cable Type	Remarks
1	N/A	N/A	1m	Type C to Type C	Supplied by test requester

3 AC POWER LINE CONDUCTED EMISSIONS TEST

3.1 LIMIT

Frequency (MHz)	Limit (dB μ V)	
	Quasi-peak	Average
0.15 - 0.5	66 - 56 *	56 - 46 *
0.50 - 5.0	56	46
5.0 - 30.0	60	50

NOTE:

- (1) The tighter limit applies at the band edges.
- (2) The limit of " * " marked band means the limitation decreases linearly with the logarithm of the frequency in the range.
- (3) The test result calculated as following:
 Measurement Value = Reading Level + Correct Factor
 Correct Factor = Insertion Loss + Cable Loss + Attenuator Factor (if use)
 Margin Level = Measurement Value – Limit Value
 Calculation example:

Reading Level (dB μ V)		Correct Factor (dB)		Measurement Value (dB μ V)
38.22	+	3.45	=	41.67

Measurement Value (dB μ V)		Limit Value (dB μ V)		Margin Level (dB)
41.67	-	60	=	-18.33

The following table is the setting of the receiver.

Receiver Parameter	Setting
Attenuation	10 dB
Start Frequency	0.15 MHz
Stop Frequency	30 MHz
IF Bandwidth	9 KHz

3.2 TEST PROCEDURE

- a. The EUT was placed 0.8 m above the horizontal ground plane with the EUT being connected to the power mains through a line impedance stabilization network (LISN).
 All other support equipment were powered from an additional LISN(s).
 The LISN provides 50 Ohm/50uH of impedance for the measuring instrument.
- b. Interconnecting cables that hang closer than 40 cm to the ground plane shall be folded back and forth in the center forming a bundle to keep the cable above 40 cm.
- c. Excess I/O cables that are not connected to a peripheral shall be bundled in the center.
 The end of the cable will be terminated, using the correct terminating impedance.
 The overall length shall not exceed 1 m.
- d. The LISN is spaced at least 80 cm from the nearest part of the EUT chassis.
- e. For the actual test configuration, please refer to the related Item – EUT TEST PHOTO.

NOTE:

- (1) In the results, each reading is marked as Peak, QP or AVG per the detector used.
 BW=9 kHz (6 dB Bandwidth)
- (2) All readings are Peak unless otherwise stated QP or AVG in column of Note. Both the QP and the AVG readings must be less than the limit for compliance.

3.3 DEVIATION FROM TEST STANDARD

No deviation.

3.4 TEST SETUP

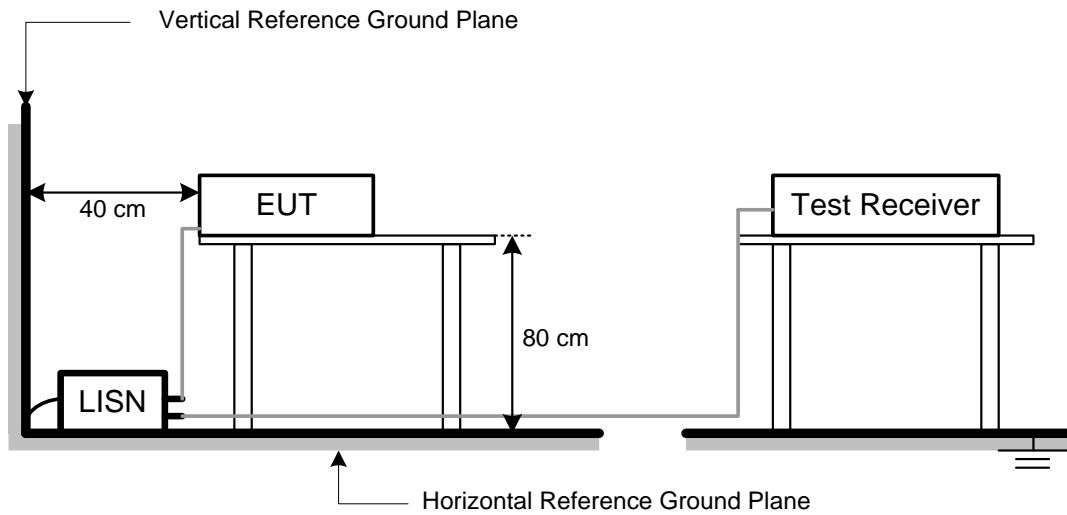

3.5 EUT OPERATION CONDITIONS

The EUT was configured for testing in a typical function (as a customer would normally use it), EUT was programmed to be in continuously transmitting/receiving data or hopping on mode.

3.6 TEST RESULT

Please refer to the APPENDIX A.

4 RADIATED EMISSIONS TEST

4.1 LIMIT

In case the emission fall within the restricted band specified on 15.205, then the 15.209 limit in the table below has to be followed.

LIMITS OF RADIATED EMISSIONS MEASUREMENT (9 kHz to 1000 MHz)

Frequency (MHz)	Field Strength (microvolts/meter)	Measurement Distance (meters)
0.009~0.490	2400/F(KHz)	300
0.490~1.705	24000/F(KHz)	30
1.705~30.0	30	30
30~88	100	3
88~216	150	3
216~960	200	3
960~1000	500	3

LIMITS OF RADIATED EMISSIONS MEASUREMENT (Above 1000 MHz)

Frequency (MHz)	Radiated Emissions (dBuV/m)		Measurement Distance (meters)
	Peak	Average	
Above 1000	74	54	3

NOTE:

- The limit for radiated test was performed according to FCC CFR Title 47, Part 15, Subpart C.
- The tighter limit applies at the band edges.
- Emission level (dBuV/m)=20log Emission level (uV/m).
- The test result calculated as following:

Measurement Value = Reading Level + Correct Factor

Correct Factor = Antenna Factor + Cable Loss - Amplifier Gain(if use)

Margin Level = Measurement Value - Limit Value

Calculation example:

Reading Level (dBuV)		Correct Factor (dB/m)		Measurement Value (dBuV/m)
41.91	+	-8.36	=	33.55

Measurement Value (dBuV/m)		Limit Value (dBuV/m)		Margin Level (dB)
33.55	-	43.50	=	-9.95

Spectrum Parameter	Setting
Attenuation	Auto
Start Frequency	1000 MHz
Stop Frequency	10th carrier harmonic
RBW / VBW (Emission in restricted band)	1MHz / 3MHz for Peak, 1MHz / 1/T for Average

Spectrum Parameter	Setting
Attenuation	Auto
Start ~ Stop Frequency	9KHz~90KHz for PK/AVG detector
Start ~ Stop Frequency	90KHz~110KHz for QP detector
Start ~ Stop Frequency	110KHz~490KHz for PK/AVG detector
Start ~ Stop Frequency	490KHz~30MHz for QP detector
Start ~ Stop Frequency	30MHz~1000MHz for QP detector

4.2 TEST PROCEDURE

- a. The measuring distance of 1 m shall be used for measurements. The EUT was placed on the top of a rotating table 0.8 meter above the ground at a 3 meter semi-anechoic chamber. The table was rotated 360 degrees to determine the position of the highest radiation.(below 30MHz)
- b. The measuring distance of 3 m shall be used for measurements. The EUT was placed on the top of a rotating table 0.8 meter above the ground at a 3 meter semi-anechoic chamber. The table was rotated 360 degrees to determine the position of the highest radiation.(below 1GHz)
- c. The measuring distance of 3 m shall be used for measurements. The EUT was placed on the top of a rotating table 1.5 meter above the ground at a 3 meter semi-anechoic chamber. The table was rotated 360 degrees to determine the position of the highest radiation.(above 1GHz)
- d. The height of the equipment or of the substitution antenna shall be 0.8 m or 1.5 m, the height of the test antenna shall vary between 1 m to 4 m. Both horizontal and vertical polarizations of the antenna are set to make the measurement.
- e. For each suspected emission, the EUT was arranged to its worst case and then the antenna was tuned to heights find the maximum reading (used Bore sight function).
- f. The receiver system was set to peak and average detect function and specified bandwidth with maximum hold mode when the test frequency is above 1GHz.
- g. The initial step in collecting radiated emission data is a receiver peak detector mode pre-scanning the measurement frequency range. Significant peaks are then marked and then Quasi Peak detector mode re-measured.
- h. All readings are Peak unless otherwise stated QP in column of Note. Peak denotes that the Peak reading compliance with the QP Limits and then QP Mode measurement didn't perform. (below 1GHz)
- i. All readings are Peak Mode value unless otherwise stated AVG in column of Note. If the Peak Mode Measured value compliance with the Peak Limits and lower than AVG Limits, the EUT shall be deemed to meet both Peak & AVG Limits and then only Peak Mode was measured, but AVG Mode didn't perform. (above 1GHz)
- j. For the actual test configuration, please refer to the related Item – EUT TEST PHOTO.

4.3 DEVIATION FROM TEST STANDARD

No deviation.

4.4 TEST SETUP

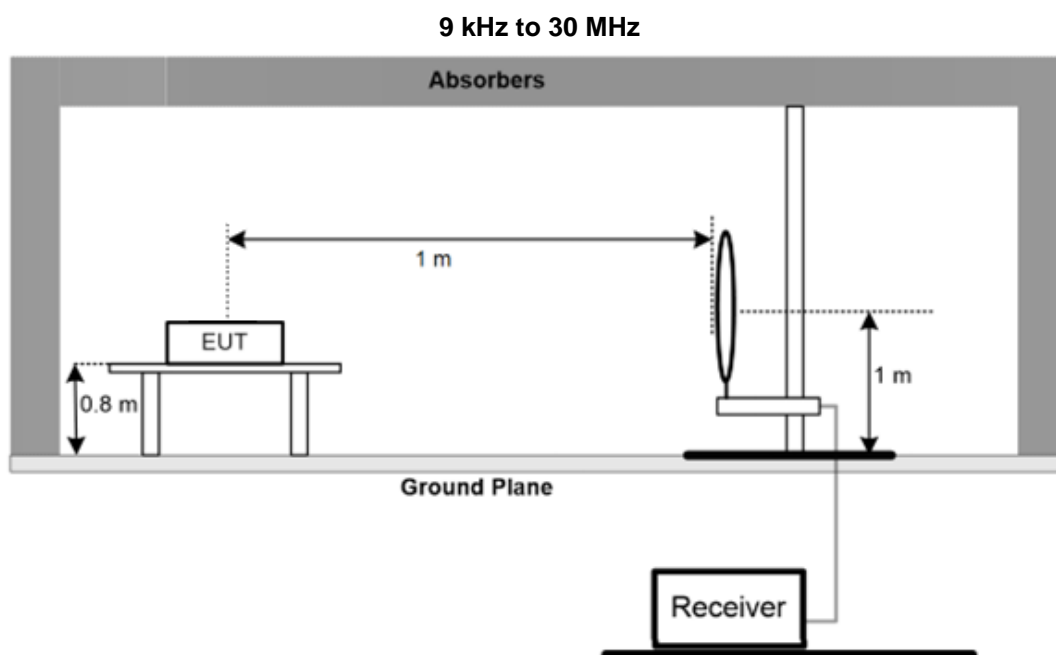

30 MHz to 1 GHz

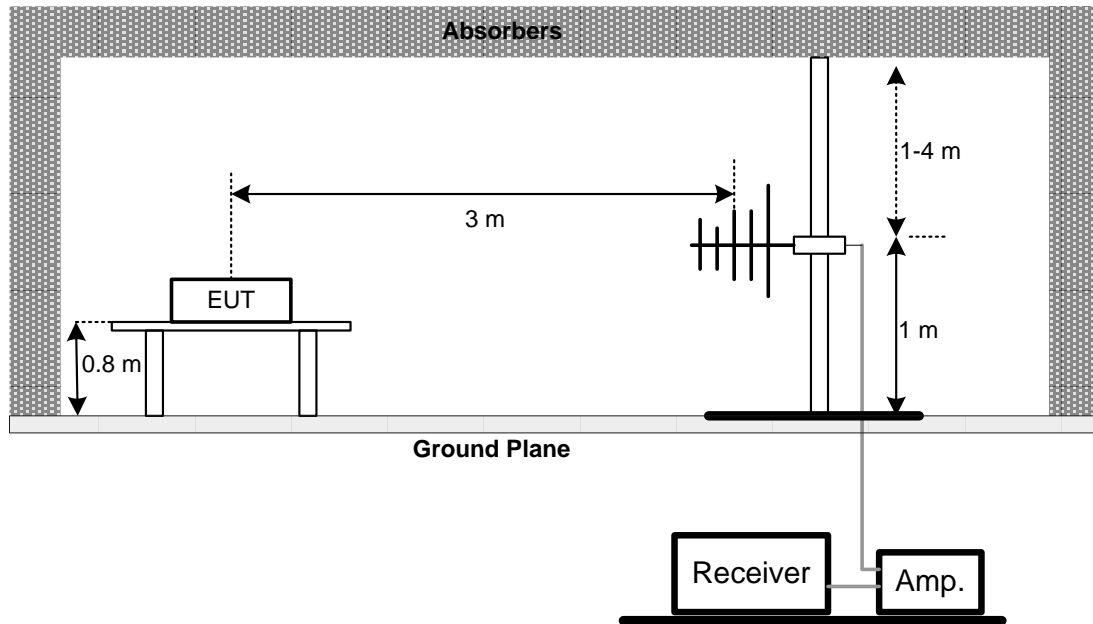

Above 1 GHz

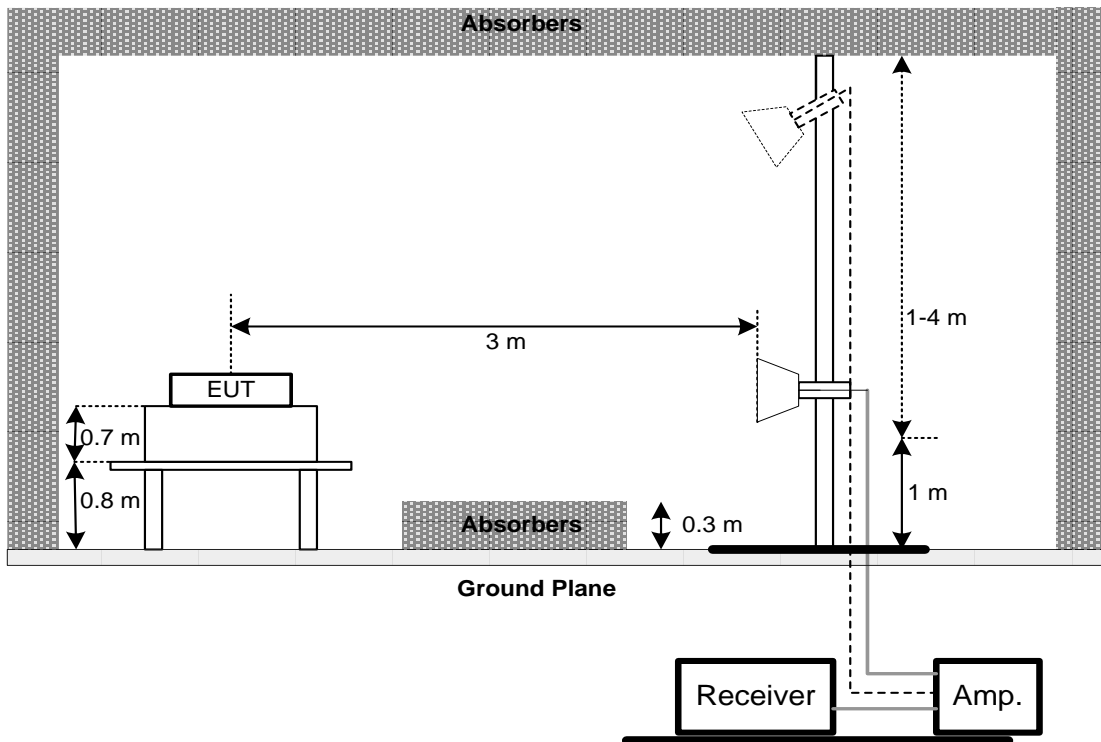

4.5 EUT OPERATING CONDITIONS

The EUT was programmed to be in continuously transmitting mode.

4.6 TEST RESULT – 9 KHZ TO 30 MHZ

Please refer to the APPENDIX B.

4.7 TEST RESULT – 30 MHZ TO 1 GHZ

Please refer to the APPENDIX C.

4.8 TEST RESULT – ABOVE 1 GHZ

Please refer to the APPENDIX D.

NOTE:

- (1) No limit: This is fundamental signal, the judgment is not applicable.
For fundamental signal judgment was referred to Peak output test.

5 BANDWIDTH TEST

5.1 APPLIED PROCEDURES / LIMIT

Section	Test Item	Limit	Frequency Range (MHz)	Result
15.247(a)(2)	Bandwidth	$\geq 500\text{KHz}$ (6dB bandwidth)	2400-2483.5	PASS

5.2 TEST PROCEDURE

- a. The EUT was directly connected to the spectrum analyzer and antenna output port as show in the block diagram below,
- b. Spectrum Setting : RBW= 100KHz, VBW=300KHz, Sweep time = 2.5 ms.

5.3 DEVIATION FROM STANDARD

No deviation.

5.4 TEST SETUP

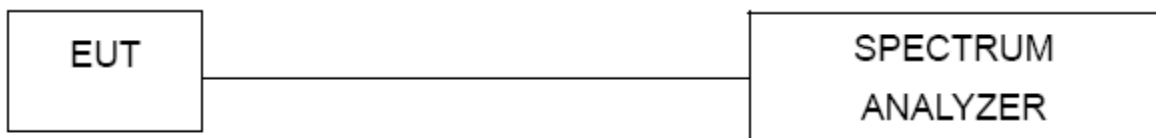

5.5 EUT OPERATION CONDITIONS

The EUT tested system was configured as the statements of 3.5 unless otherwise a special operating condition is specified in the follows during the testing.

5.6 TEST RESULTS

Please refer to the APPENDIX E.

6 OUTPUT POWER TEST

6.1 APPLIED PROCEDURES / LIMIT

Section	Test Item	Limit	Frequency Range (MHz)	Result
15.247(b)(3)	Maximum Output Power	1 watt or 30dBm	2400-2483.5	PASS

6.2 TEST PROCEDURE

- a. The EUT was directly connected to the power meter and antenna output port as show in the block diagram below,
- b. The maximum peak conducted output power was performed in accordance with FCC KDB 558074 D01 15.247 Meas Guidance.

6.3 DEVIATION FROM STANDARD

No deviation.

6.4 TEST SETUP

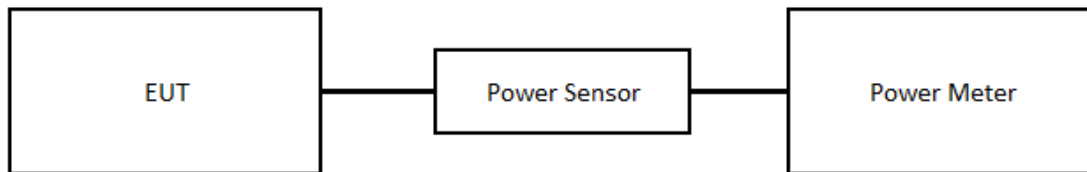

6.5 EUT OPERATION CONDITIONS

The EUT tested system was configured as the statements of 3.5 unless otherwise a special operating condition is specified in the follows during the testing.

6.6 TEST RESULTS

Please refer to the APPENDIX F.

7 POWER SPECTRAL DENSITY TEST

7.1 APPLIED PROCEDURES / LIMIT

Section	Test Item	Limit	Frequency Range (MHz)	Result
15.247(e)	Power Spectral Density	8 dBm (in any 3KHz)	2400-2483.5	PASS

7.2 TEST PROCEDURE

- a. The EUT was directly connected to the spectrum analyzer and antenna output port as show in the block diagram below,
- b. Spectrum Setting: RBW=3KHz, VBW=10 KHz, Sweep time = auto.

7.3 DEVIATION FROM STANDARD

No deviation.

7.4 TEST SETUP



7.5 EUT OPERATION CONDITIONS

The EUT tested system was configured as the statements of 3.5 unless otherwise a special operating condition is specified in the follows during the testing.

7.6 TEST RESULTS

Please refer to the APPENDIX G.

8 ANTENNA CONDUCTED SPURIOUS EMISSION

8.1 APPLIED PROCEDURES / LIMIT

In any 100 kHz bandwidth outside the frequency band in which the spread spectrum or digitally modulated device is operating, the RF power that is produced shall be at least 20 dB below that in the 100 kHz bandwidth within the band that contains the highest level of the desired power, based on either an RF conducted or a radiated measurement, provided that the transmitter demonstrates compliance with the peak conducted power limits.

8.2 TEST PROCEDURE

- a. The EUT was directly connected to the spectrum analyzer and antenna output port as show in the block diagram below,
- b. Spectrum Setting : RBW= 100KHz, VBW=300KHz, Sweep time = 10 ms.

8.3 DEVIATION FROM STANDARD

No deviation.

8.4 TEST SETUP



8.5 EUT OPERATION CONDITIONS

The EUT tested system was configured as the statements of 3.5 unless otherwise a special operating condition is specified in the follows during the testing.

8.6 TEST RESULTS

Please refer to the APPENDIX H.

9 LIST OF MEASURING EQUIPMENTS

AC Power Line Conducted Emissions						
Item	Kind of Equipment	Manufacturer	Type No.	Serial No.	Calibrated Date	Calibrated Until
1	TWO-LINE V-NETWORK	R&S	ENV216	101521	2024/9/5	2025/9/4
2	Test Cable	EMCI	EMCCFD300-BM-BMR-5000	220331	2024/3/30	2025/3/29
3	EMI Test Receiver	R&S	ESR3	102950	2024/4/12	2025/4/11
4	Measurement Software	EZ	EZ EMC (Version NB-03A1-01)	N/A	N/A	N/A

Radiated Emissions						
Item	Kind of Equipment	Manufacturer	Type No.	Serial No.	Calibrated Date	Calibrated Until
1	Preamplifier	EMCI	EMC330N	980850	2024/9/5	2025/9/4
2	Preamplifier	EMCI	EMC118A45SE	980819	2024/3/6	2025/3/5
3	Pre-Amplifier	EMCI	EMC184045SE	980907	2024/9/4	2025/9/3
4	Preamplifier	EMCI	EMC001340	980579	2024/9/4	2025/9/3
5	Test Cable	EMCI	EMC104-SM-1000	180809	2024/3/8	2025/3/7
6	Test Cable	EMCI	EMC104-SM-SM-3000	220322	2024/3/8	2025/3/7
7	Test Cable	EMCI	EMC104-SM-SM-7000	220324	2024/3/8	2025/3/7
8	EXA Signal Analyzer	keysight	N9020B	MY57120120	2024/2/23	2025/2/22
9	Loop Ant	Electro-Metrics	EMCI-LPA600	273	2024/7/31	2025/7/30
10	Horn Antenna	RFSPIN	DRH18-E	211202A18EN	2024/5/9	2025/5/8
11	Horn Ant	Schwarzbeck	BBHA 9170D	1136	2024/5/17	2025/5/16
12	Log-bicon Antenna	Schwarzbeck	VULB9168	1369	2024/6/14	2025/6/13
13	6dB Attenuator	EMCI	EMCI-N-6-06	AT-06001	2024/6/14	2025/6/13
14	Test Cable	EMCI	EMC101G-KM-KM-3000	220329	2024/3/13	2025/3/12
15	Test Cable	EMCI	EMC102-KM-KM-1000	220327	2024/3/13	2025/3/12
16	Measurement Software	EZ	EZ EMC (Version NB-03A1-01)	N/A	N/A	N/A

Bandwidth						
Item	Kind of Equipment	Manufacturer	Type No.	Serial No.	Calibrated Date	Calibrated Until
1	Spectrum Analyzer	R&S	FSP 40	100129	2024/3/27	2025/3/26

Output Power						
Item	Kind of Equipment	Manufacturer	Type No.	Serial No.	Calibrated Date	Calibrated Until
1	Power Meter	Anritsu	ML2495A	1128008	2024/5/11	2025/5/10
2	Power Sensor	Anritsu	MA2411B	1126001	2024/5/11	2025/5/10

Power Spectral Density						
Item	Kind of Equipment	Manufacturer	Type No.	Serial No.	Calibrated Date	Calibrated Until
1	Spectrum Analyzer	R&S	FSP 40	100129	2024/3/27	2025/3/26

Antenna conducted Spurious Emission						
Item	Kind of Equipment	Manufacturer	Type No.	Serial No.	Calibrated Date	Calibrated Until
1	Spectrum Analyzer	R&S	FSP 40	100129	2024/3/27	2025/3/26

Remark: "N/A" denotes no model name, no serial no. or no calibration specified.
All calibration period of equipment list is one year.

10 EUT TEST PHOTO

Please refer to document Appendix No.: TP-2411T019-FCCP-1 (APPENDIX-TEST PHOTOS).

11 EUT PHOTOS

Please refer to document Appendix No.: EP-2411T019-2 (APPENDIX-EUT PHOTOS).

APPENDIX A AC POWER LINE CONDUCTED EMISSIONS

Test Mode	Normal	Tested Date	2024/11/12
Test Frequency	-	Phase	Line

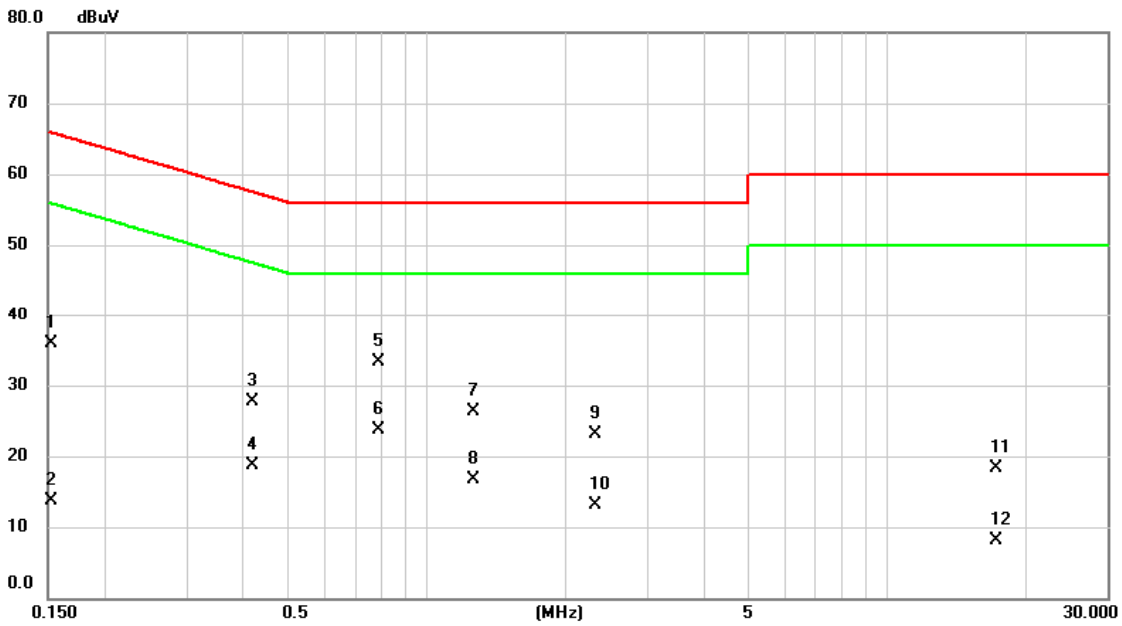

No.	Mk.	Freq. MHz	Reading Level dBuV	Correct Factor dB	Measure- ment dBuV	Limit dBuV	Margin dB	Detector	Comment
1		0.1522	26.17	9.68	35.85	65.88	-30.03	QP	
2		0.1522	4.01	9.68	13.69	55.88	-42.19	AVG	
3		0.4200	18.06	9.58	27.64	57.45	-29.81	QP	
4		0.4200	9.05	9.58	18.63	47.45	-28.82	AVG	
5		0.7845	23.79	9.56	33.35	56.00	-22.65	QP	
6	*	0.7845	14.13	9.56	23.69	46.00	-22.31	AVG	
7		1.2593	16.67	9.56	26.23	56.00	-29.77	QP	
8		1.2593	7.07	9.56	16.63	46.00	-29.37	AVG	
9		2.3213	13.46	9.57	23.03	56.00	-32.97	QP	
10		2.3213	3.63	9.57	13.20	46.00	-32.80	AVG	
11		17.1938	8.59	9.73	18.32	60.00	-41.68	QP	
12		17.1938	-1.56	9.73	8.17	50.00	-41.83	AVG	

REMARKS:

(1) Measurement Value = Reading Level + Correct Factor.

(2) Margin Level = Measurement Value - Limit Value.

Test Mode	Normal	Tested Date	2024/11/12
Test Frequency	-	Phase	Neutral

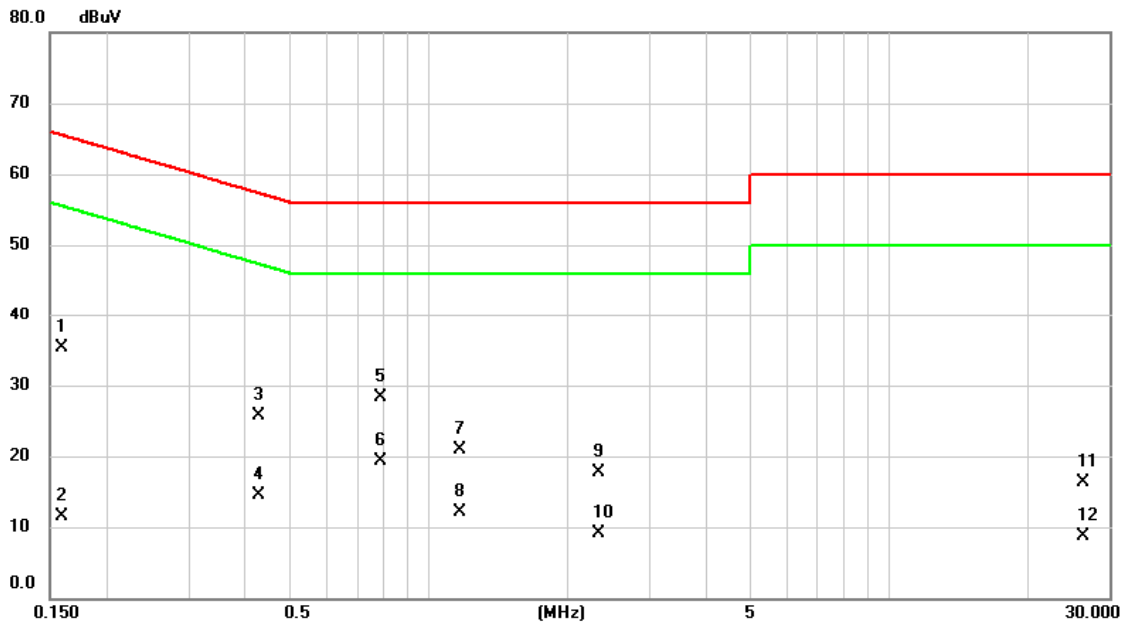

No.	Mk.	Freq. MHz	Reading Level dBuV	Correct Factor dB	Measure- ment dBuV	Limit dBuV	Margin dB	Detector	Comment
1		0.1598	25.74	9.66	35.40	65.47	-30.07	QP	
2		0.1598	1.88	9.66	11.54	55.47	-43.93	AVG	
3		0.4290	16.04	9.57	25.61	57.27	-31.66	QP	
4		0.4290	4.90	9.57	14.47	47.27	-32.80	AVG	
5		0.7867	18.67	9.55	28.22	56.00	-27.78	QP	
6	*	0.7867	9.81	9.55	19.36	46.00	-26.64	AVG	
7		1.1692	11.43	9.55	20.98	56.00	-35.02	QP	
8		1.1692	2.65	9.55	12.20	46.00	-33.80	AVG	
9		2.3258	8.21	9.59	17.80	56.00	-38.20	QP	
10		2.3258	-0.47	9.59	9.12	46.00	-36.88	AVG	
11		26.3693	6.52	9.76	16.28	60.00	-43.72	QP	
12		26.3693	-1.13	9.76	8.63	50.00	-41.37	AVG	

REMARKS:

(1) Measurement Value = Reading Level + Correct Factor.

(2) Margin Level = Measurement Value - Limit Value.

Test Mode	Idle	Tested Date	2024/11/12
Test Frequency	-	Phase	Line

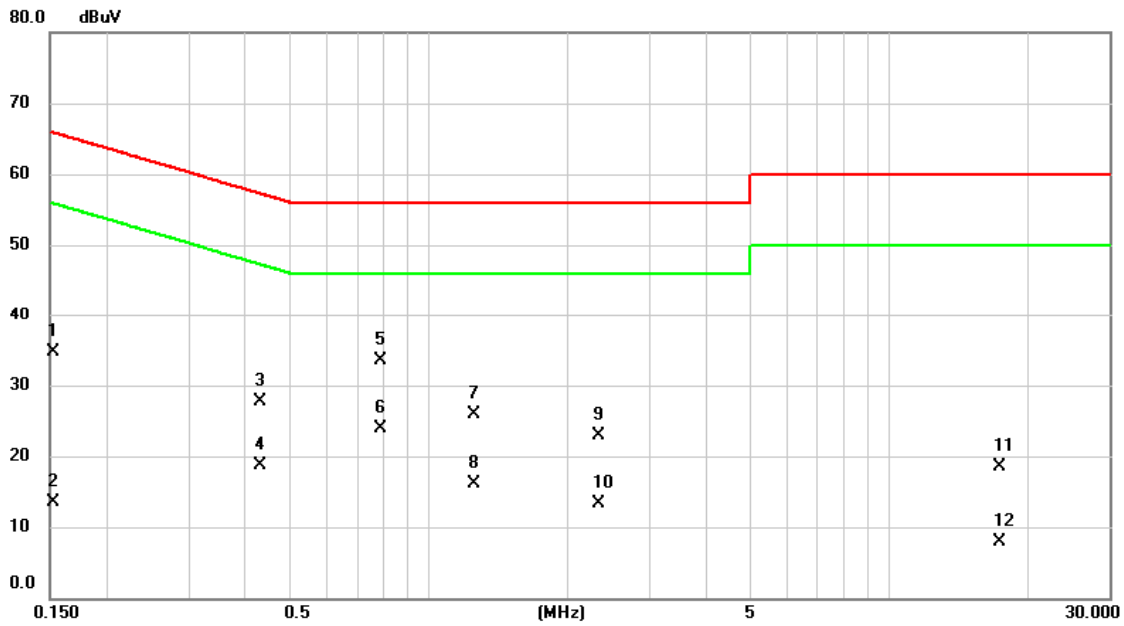

No.	Mk.	Freq.	Reading Level	Correct Factor	Measurement	Limit	Margin	Detector	Comment
		MHz	dBuV	dB	dBuV	dBuV	dB		
1		0.1522	25.02	9.68	34.70	65.88	-31.18	QP	
2		0.1522	3.78	9.68	13.46	55.88	-42.42	AVG	
3		0.4312	18.06	9.58	27.64	57.23	-29.59	QP	
4		0.4312	9.03	9.58	18.61	47.23	-28.62	AVG	
5		0.7867	23.94	9.56	33.50	56.00	-22.50	QP	
6	*	0.7867	14.36	9.56	23.92	46.00	-22.08	AVG	
7		1.2548	16.36	9.56	25.92	56.00	-30.08	QP	
8		1.2548	6.57	9.56	16.13	46.00	-29.87	AVG	
9		2.3258	13.37	9.57	22.94	56.00	-33.06	QP	
10		2.3258	3.78	9.57	13.35	46.00	-32.65	AVG	
11		17.3220	8.76	9.73	18.49	60.00	-41.51	QP	
12		17.3220	-1.75	9.73	7.98	50.00	-42.02	AVG	

REMARKS:

- (1) Measurement Value = Reading Level + Correct Factor.
- (2) Margin Level = Measurement Value - Limit Value.

Test Mode	Idle	Tested Date	2024/11/12
Test Frequency	-	Phase	Neutral

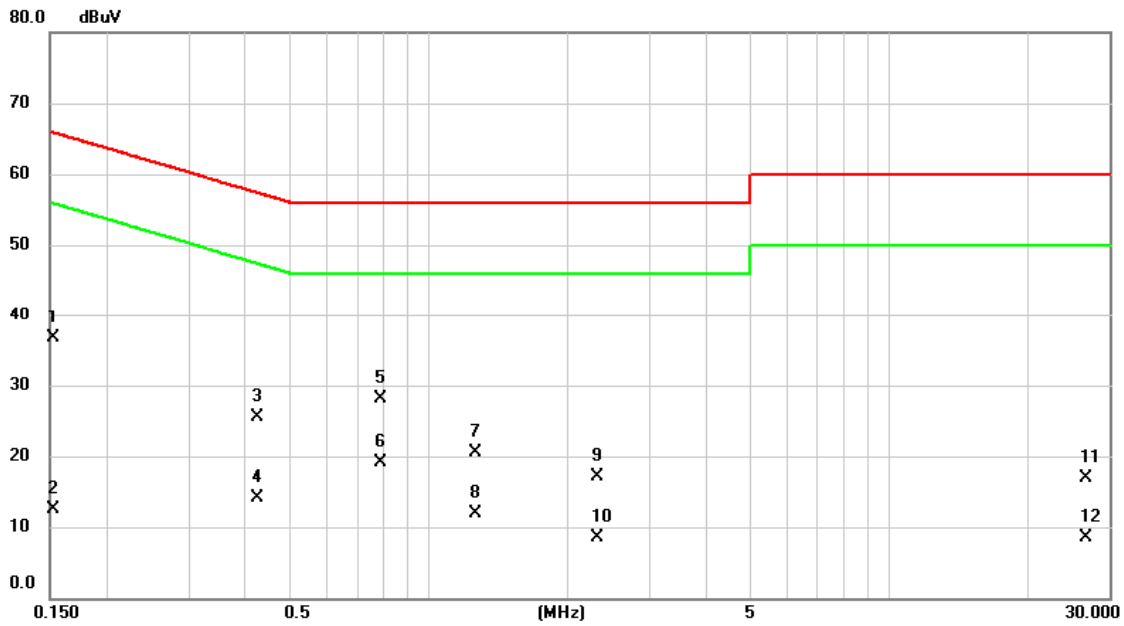

No.	Mk.	Freq. MHz	Reading Level dBuV	Correct Factor dB	Measure- ment dBuV	Limit dBuV	Margin dB	Detector	Comment
1		0.1522	27.05	9.66	36.71	65.88	-29.17	QP	
2		0.1522	2.83	9.66	12.49	55.88	-43.39	AVG	
3		0.4245	15.88	9.57	25.45	57.36	-31.91	QP	
4		0.4245	4.51	9.57	14.08	47.36	-33.28	AVG	
5		0.7845	18.58	9.55	28.13	56.00	-27.87	QP	
6	*	0.7845	9.57	9.55	19.12	46.00	-26.88	AVG	
7		1.2660	10.93	9.56	20.49	56.00	-35.51	QP	
8		1.2660	2.35	9.56	11.91	46.00	-34.09	AVG	
9		2.3145	7.55	9.59	17.14	56.00	-38.86	QP	
10		2.3145	-1.01	9.59	8.58	46.00	-37.42	AVG	
11		26.6303	7.06	9.75	16.81	60.00	-43.19	QP	
12		26.6303	-1.28	9.75	8.47	50.00	-41.53	AVG	

REMARKS:

(1) Measurement Value = Reading Level + Correct Factor.

(2) Margin Level = Measurement Value - Limit Value.

APPENDIX B RADIATED EMISSIONS - 9 KHZ TO 30 MHZ

Test Mode	BLE 5.3 (1 Mbps)	Test Date	2024/11/25
Test Frequency	2480MHz	Polarization	Vertical
Temp	25°C	Hum.	60%

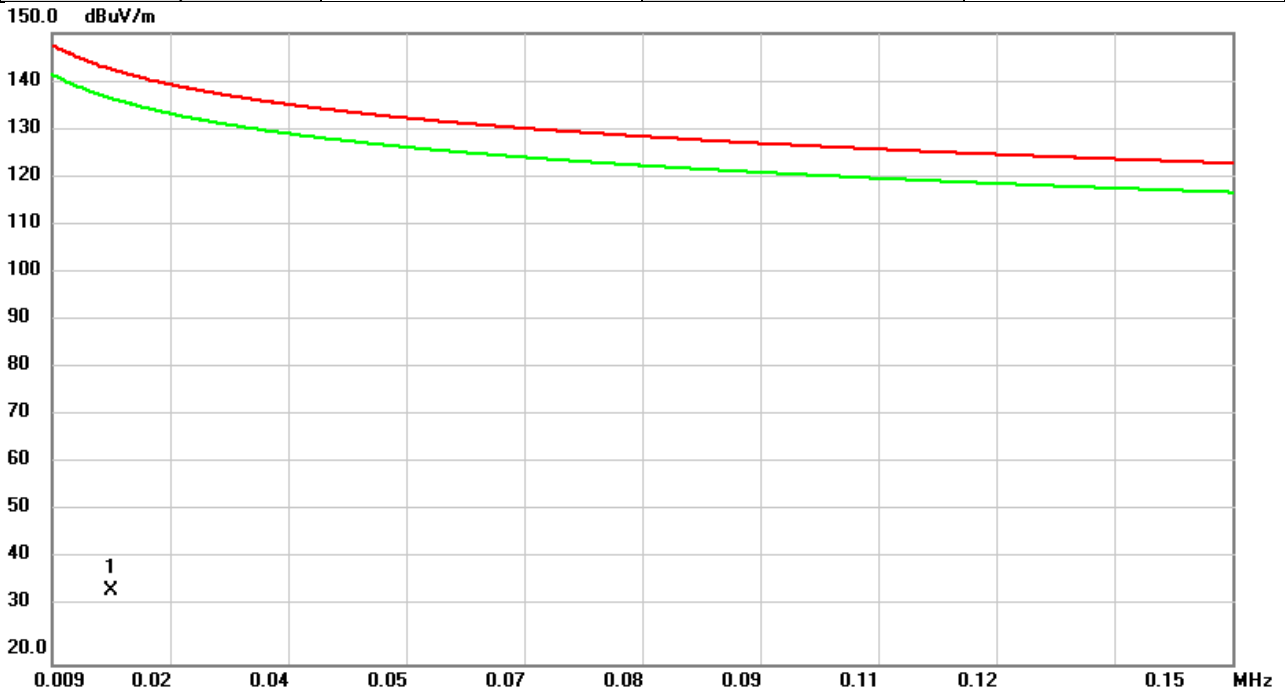

No.	Mk.	Freq.	Reading Level	Correct Factor	Measurement	Limit	Over	Detector	Comment
		MHz	dBuV	dB	dBuV/m	dBuV/m	dB		
1	*	0.0160	1.77	33.45	35.22	142.60	-107.38	AVG	

REMARKS:

- (1) Measurement Value = Reading Level + Correct Factor.
- (2) Margin Level = Measurement Value - Limit Value.

Test Mode	BLE 5.3 (1 Mbps)	Test Date	2024/11/25
Test Frequency	2480MHz	Polarization	Vertical
Temp	25°C	Hum.	60%

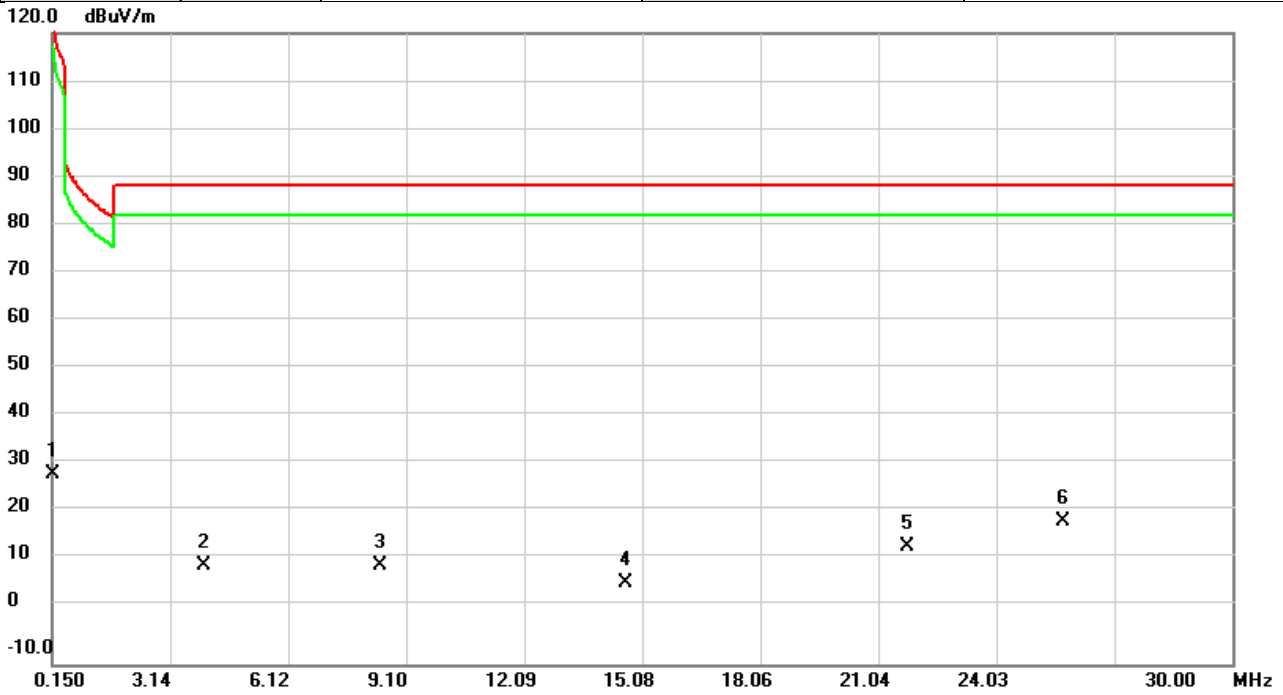

No.	Mk.	Freq.	Reading Level	Correct Factor	Measurement	Limit	Over	Detector	Comment
		MHz	dBuV	dB	dBuV/m	dBuV/m	dB		
1		0.1500	15.23	13.96	29.19	123.16	-93.97	AVG	
2		3.9907	14.34	-4.08	10.26	88.62	-78.36	QP	
3		8.4612	13.63	-3.44	10.19	88.62	-78.43	QP	
4		14.6621	10.22	-3.47	6.75	88.62	-81.87	QP	
5		21.7753	17.73	-3.63	14.10	88.62	-74.52	QP	
6	*	25.7165	22.31	-2.86	19.45	88.62	-69.17	QP	

REMARKS:

- (1) Measurement Value = Reading Level + Correct Factor.
- (2) Margin Level = Measurement Value - Limit Value.

Test Mode	BLE 5.3 (1 Mbps)	Test Date	2024/11/25
Test Frequency	2480MHz	Polarization	Horizontal
Temp	25°C	Hum.	60%

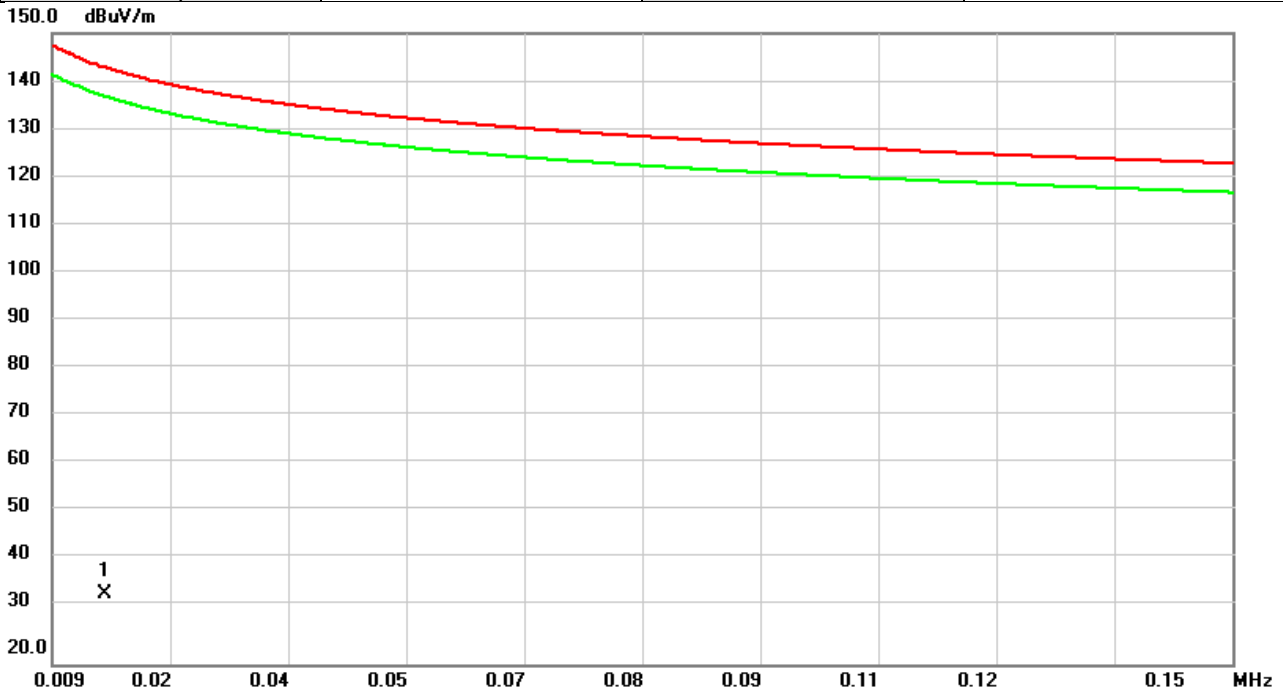

No.	Mk.	Freq.	Reading Level	Correct Factor	Measurement	Limit	Over	Detector	Comment
		MHz	dBuV	dB	dBuV/m	dBuV/m	dB		
1	*	0.0153	0.78	33.70	34.48	142.99	-108.51	AVG	

REMARKS:

- (1) Measurement Value = Reading Level + Correct Factor.
- (2) Margin Level = Measurement Value - Limit Value.

Test Mode	BLE 5.3 (1 Mbps)	Test Date	2024/11/25
Test Frequency	2480MHz	Polarization	Horizontal
Temp	25°C	Hum.	60%

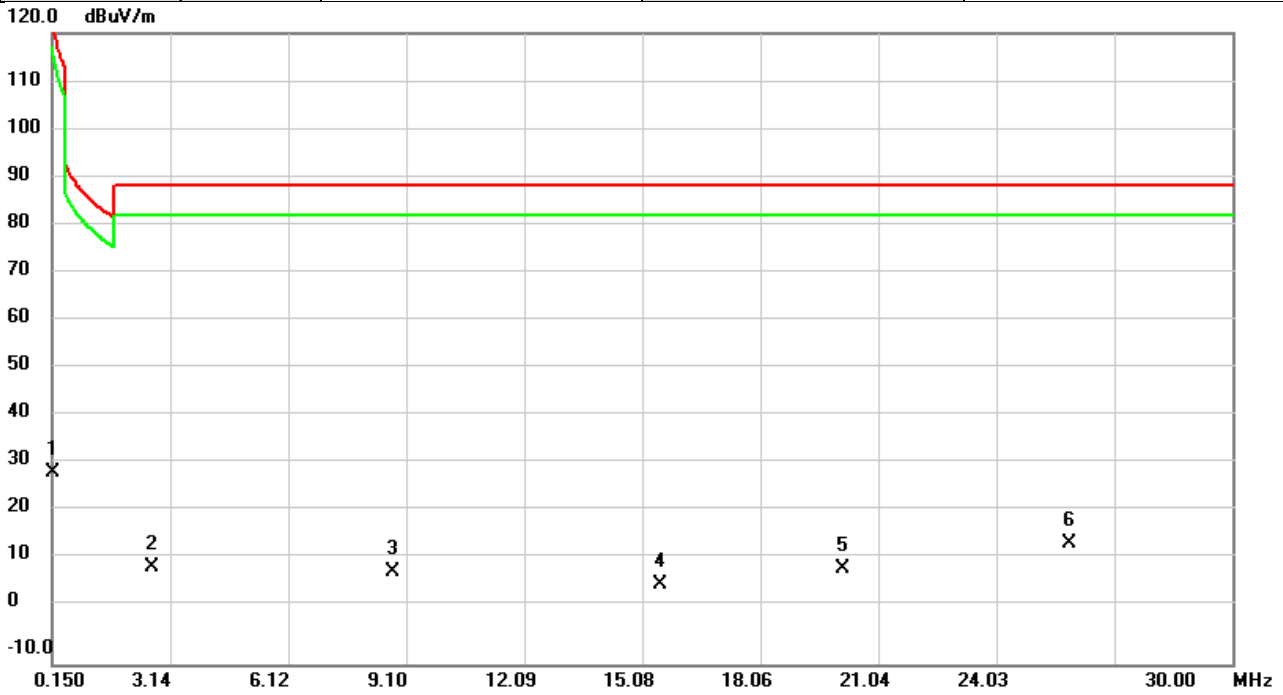

No.	Mk.	Freq.	Reading Level	Correct Factor	Measurement	Limit	Over	Detector	Comment
		MHz	dBuV	dB	dBuV/m	dBuV/m	dB		
1		0.1500	15.52	13.96	29.48	123.16	-93.68	AVG	
2		2.6753	13.06	-3.12	9.94	88.62	-78.68	QP	
3		8.7587	12.35	-3.35	9.00	88.62	-79.62	QP	
4		15.5357	9.82	-3.55	6.27	88.62	-82.35	QP	
5		20.1545	13.67	-3.95	9.72	88.62	-78.90	QP	
6	*	25.8907	17.71	-2.83	14.88	88.62	-73.74	QP	

REMARKS:

- (1) Measurement Value = Reading Level + Correct Factor.
- (2) Margin Level = Measurement Value - Limit Value.

APPENDIX C RADIATED EMISSIONS - 30 MHZ TO 1 GHZ

Test Mode	BLE 5.3 (1 Mbps)	Test Date	2024/11/25
Test Frequency	2480MHz	Polarization	Vertical
Temp	25°C	Hum.	60%

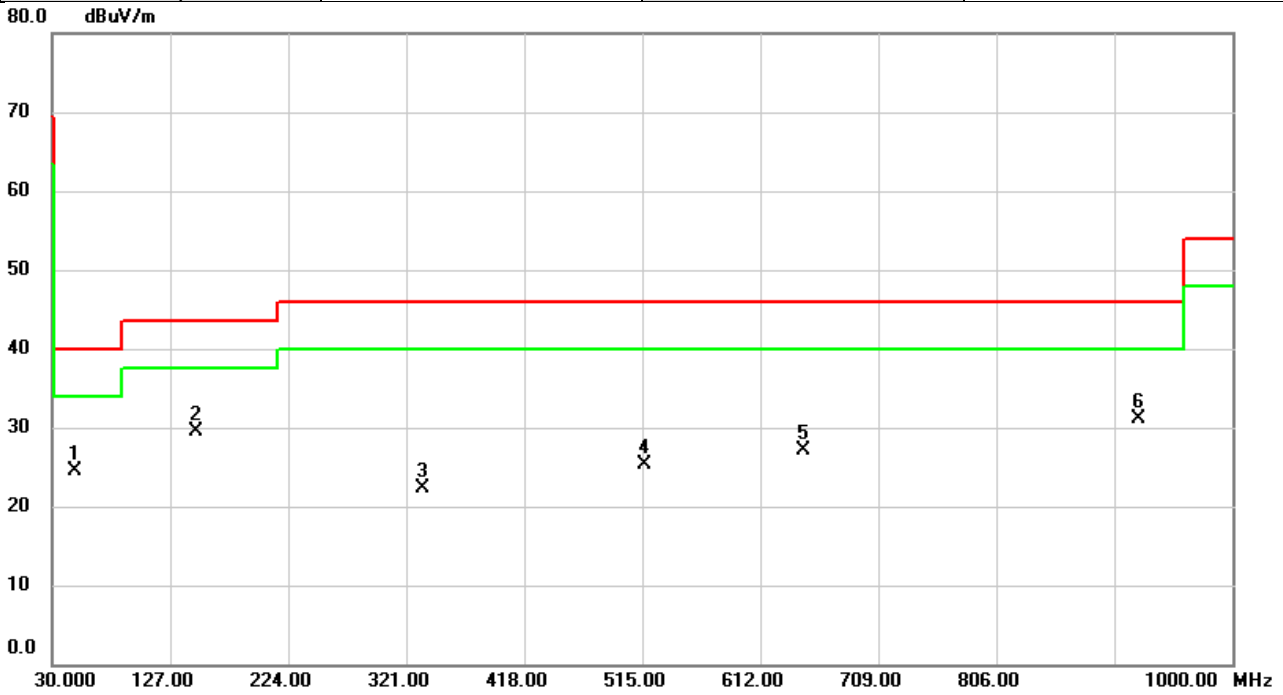

No.	Mk.	Freq.	Reading Level	Correct Factor	Measurement	Limit	Over	Detector	Comment
		MHz	dBuV	dB	dBuV/m	dBuV/m	dB		
1		49.1412	36.18	-11.67	24.51	40.00	-15.49	peak	
2	*	148.3723	41.53	-11.96	29.57	43.50	-13.93	peak	
3		334.1597	32.96	-10.71	22.25	46.00	-23.75	peak	
4		517.3927	31.57	-6.31	25.26	46.00	-20.74	peak	
5		647.4697	30.60	-3.42	27.18	46.00	-18.82	peak	
6		922.9497	30.82	0.33	31.15	46.00	-14.85	peak	

REMARKS:

- (1) Measurement Value = Reading Level + Correct Factor.
- (2) Margin Level = Measurement Value - Limit Value.

Test Mode	BLE 5.3 (1 Mbps)	Test Date	2024/11/25
Test Frequency	2480MHz	Polarization	Horizontal
Temp	25°C	Hum.	60%

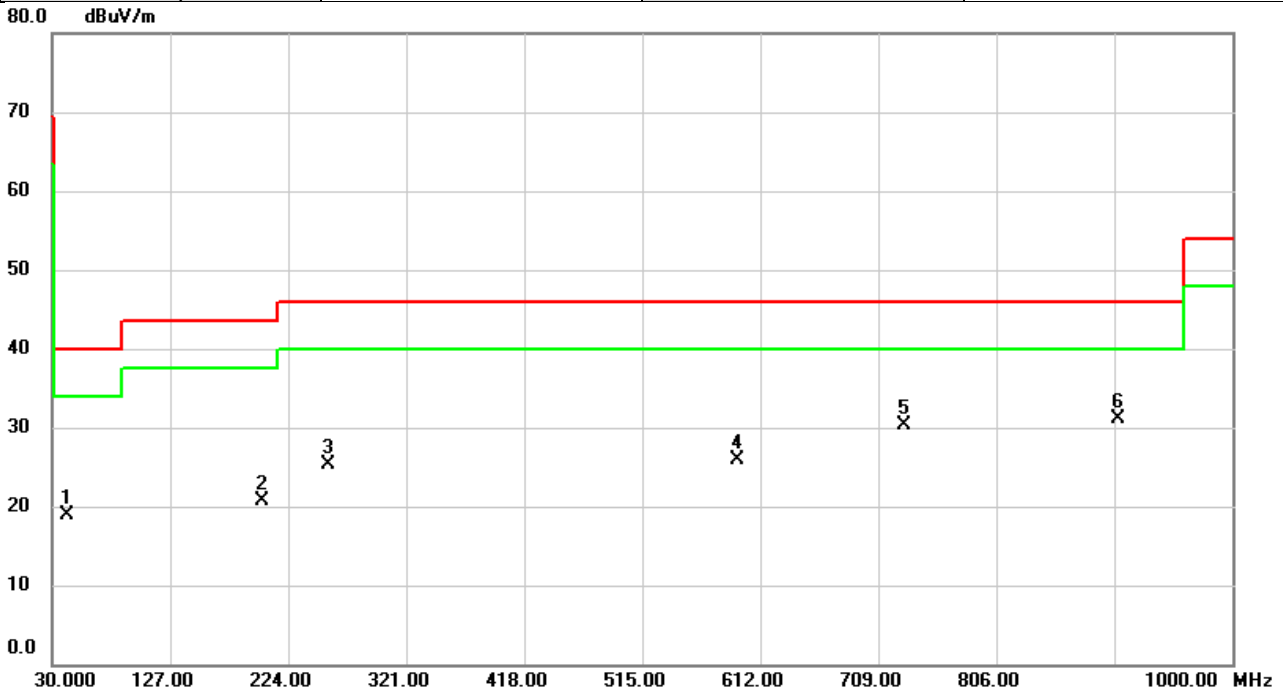

No.	Mk.	Freq.	Reading Level	Correct Factor	Measurement	Limit	Over	Detector	Comment
		MHz	dBuV	dB	dBuV/m	dBuV/m	dB		
1		42.9333	30.84	-11.97	18.87	40.00	-21.13	peak	
2		202.8863	36.14	-15.36	20.78	43.50	-22.72	peak	
3		257.1740	38.43	-13.07	25.36	46.00	-20.64	peak	
4		593.7963	30.28	-4.45	25.83	46.00	-20.17	peak	
5		730.3723	32.52	-2.13	30.39	46.00	-15.61	peak	
6	*	906.6536	31.06	0.04	31.10	46.00	-14.90	peak	

REMARKS:

- (1) Measurement Value = Reading Level + Correct Factor.
- (2) Margin Level = Measurement Value - Limit Value.

APPENDIX D RADIATED EMISSIONS - ABOVE 1 GHZ

Test Mode	BLE 5.3 (1 Mbps)	Test Date	2024/11/25
Test Frequency	2402MHz	Polarization	Horizontal
Temp	25°C	Hum.	60%

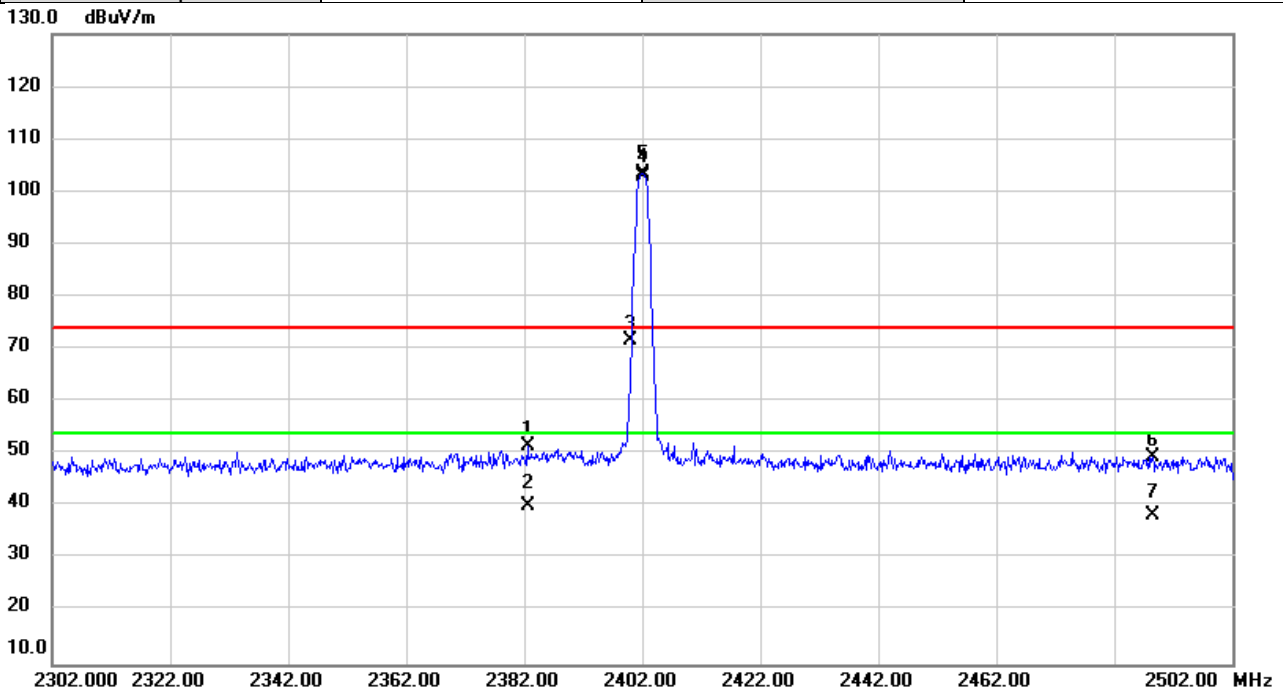

No.	Mk.	Freq.	Reading Level	Correct Factor	Measurement	Limit	Over	Detector	Comment
		MHz	dBuV	dB	dBuV/m	dBuV/m	dB		
1		2382.553	56.66	-5.01	51.65	74.00	-22.35	peak	
2		2382.553	45.20	-5.01	40.19	54.00	-13.81	AVG	
3		2400.000	76.69	-4.99	71.70	74.00	-2.30	peak	NoLimit
4	X	2402.000	108.53	-5.00	103.53	74.00	29.53	peak	NoLimit
5	*	2402.000	107.82	-5.00	102.82	54.00	48.82	AVG	NoLimit
6		2488.527	54.35	-4.88	49.47	74.00	-24.53	peak	
7		2488.527	43.12	-4.88	38.24	54.00	-15.76	AVG	

REMARKS:

- (1) Measurement Value = Reading Level + Correct Factor.
- (2) Margin Level = Measurement Value - Limit Value.

Test Mode	BLE 5.3 (1 Mbps)	Test Date	2024/11/25
Test Frequency	2480MHz	Polarization	Horizontal
Temp	25°C	Hum.	60%

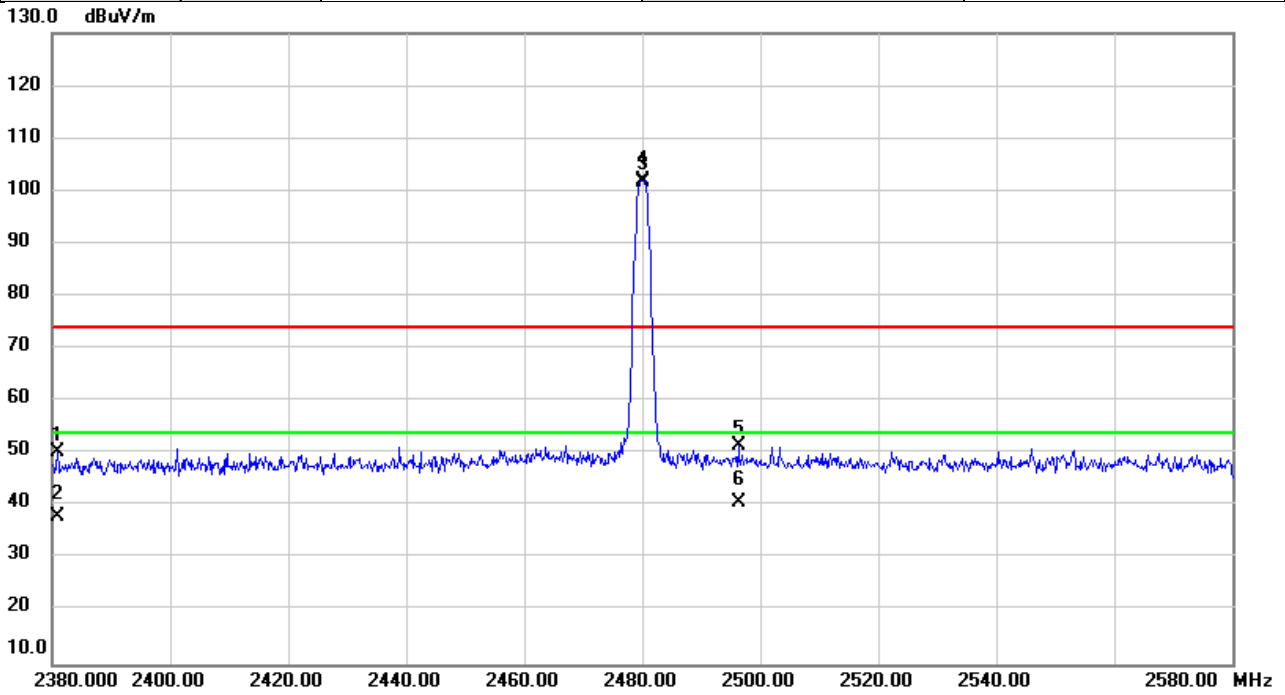

No.	Mk.	Freq.	Reading Level	Correct Factor	Measurement	Limit	Over	Detector	Comment
		MHz	dBuV	dB	dBuV/m	dBuV/m	dB		
1		2380.833	55.48	-5.02	50.46	74.00	-23.54	peak	
2		2380.833	43.05	-5.02	38.03	54.00	-15.97	AVG	
3	X	2480.000	106.99	-4.89	102.10	74.00	28.10	peak	NoLimit
4	*	2480.000	106.43	-4.89	101.54	54.00	47.54	AVG	NoLimit
5		2496.327	56.52	-4.87	51.65	74.00	-22.35	peak	
6		2496.327	45.68	-4.87	40.81	54.00	-13.19	AVG	

REMARKS:

- (1) Measurement Value = Reading Level + Correct Factor.
- (2) Margin Level = Measurement Value - Limit Value.

Test Mode	BLE 5.3 (2 Mbps)	Test Date	2024/11/25
Test Frequency	2402MHz	Polarization	Horizontal
Temp	25°C	Hum.	60%

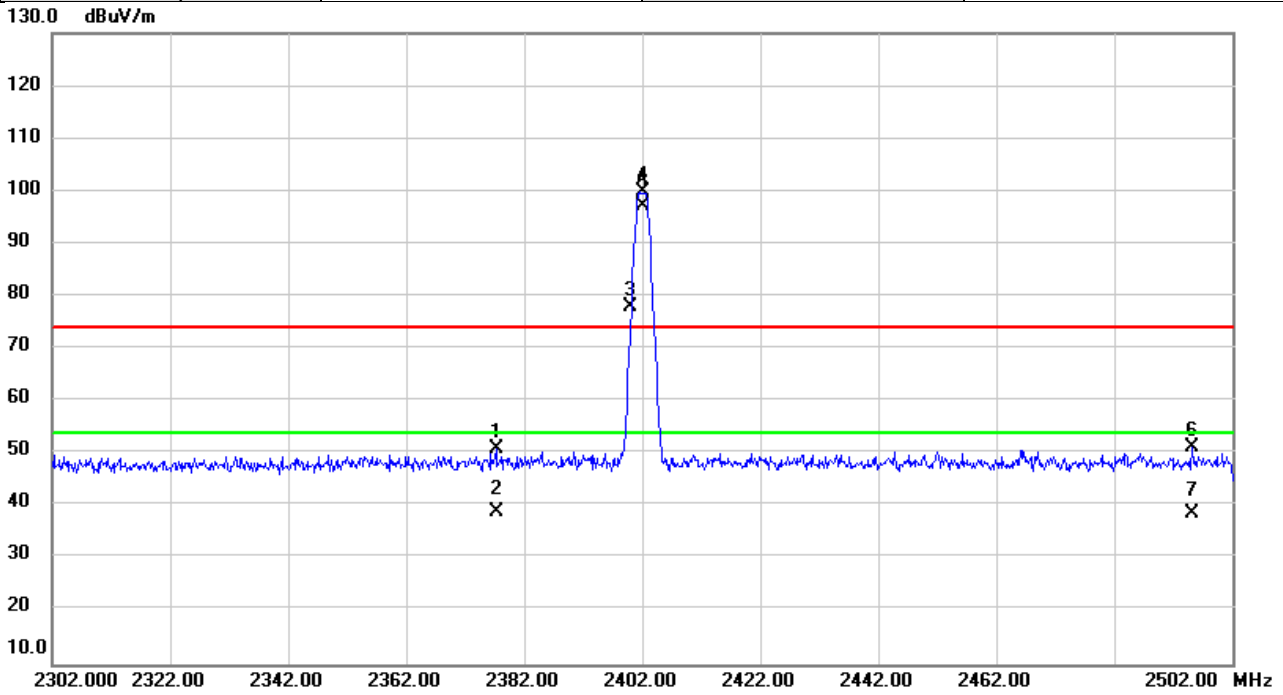

No.	Mk.	Freq.	Reading Level	Correct Factor	Measurement	Limit	Over	Detector	Comment
		MHz	dBuV	dB	dBuV/m	dBuV/m	dB		
1		2377.307	55.86	-5.02	50.84	74.00	-23.16	peak	
2		2377.307	44.09	-5.02	39.07	54.00	-14.93	AVG	
3	X	2400.000	82.90	-4.99	77.91	74.00	3.91	peak	NoLimit
4	X	2402.000	104.80	-5.00	99.80	74.00	25.80	peak	NoLimit
5	*	2402.000	102.19	-5.00	97.19	54.00	43.19	AVG	NoLimit
6		2495.200	56.26	-4.87	51.39	74.00	-22.61	peak	
7		2495.200	43.45	-4.87	38.58	54.00	-15.42	AVG	

REMARKS:

- (1) Measurement Value = Reading Level + Correct Factor.
- (2) Margin Level = Measurement Value - Limit Value.

Test Mode	BLE 5.3 (2 Mbps)	Test Date	2024/11/25
Test Frequency	2480MHz	Polarization	Horizontal
Temp	25°C	Hum.	60%

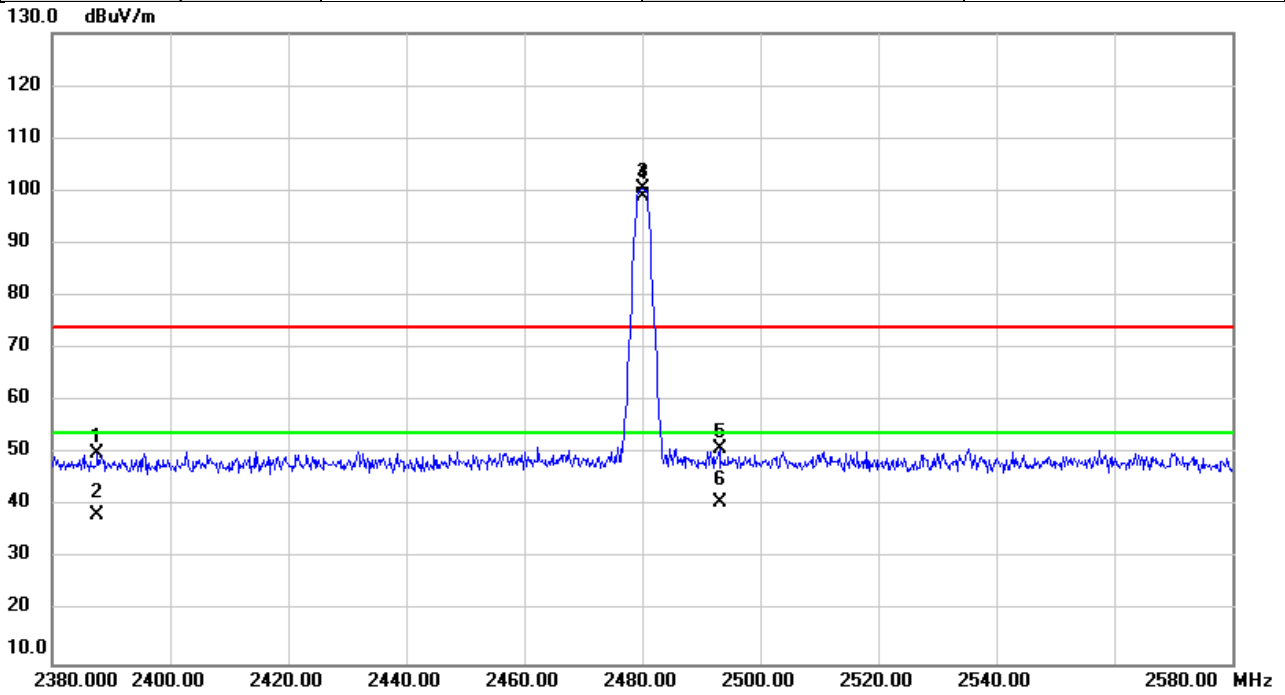

No.	Mk.	Freq.	Reading Level	Correct Factor	Measurement	Limit	Over	Detector	Comment
		MHz	dBuV	dB	dBuV/m	dBuV/m	dB		
1		2387.733	54.93	-5.01	49.92	74.00	-24.08	peak	
2		2387.733	43.42	-5.01	38.41	54.00	-15.59	AVG	
3	X	2480.000	105.31	-4.89	100.42	74.00	26.42	peak	NoLimit
4	*	2480.000	103.75	-4.89	98.86	54.00	44.86	AVG	NoLimit
5		2493.100	55.94	-4.87	51.07	74.00	-22.93	peak	
6		2493.100	45.47	-4.87	40.60	54.00	-13.40	AVG	

REMARKS:

- (1) Measurement Value = Reading Level + Correct Factor.
- (2) Margin Level = Measurement Value - Limit Value.

Test Mode	BLE 5.3 (1 Mbps)	Test Date	2024/11/25
Test Frequency	2402MHz	Polarization	Vertical
Temp	25°C	Hum.	60%

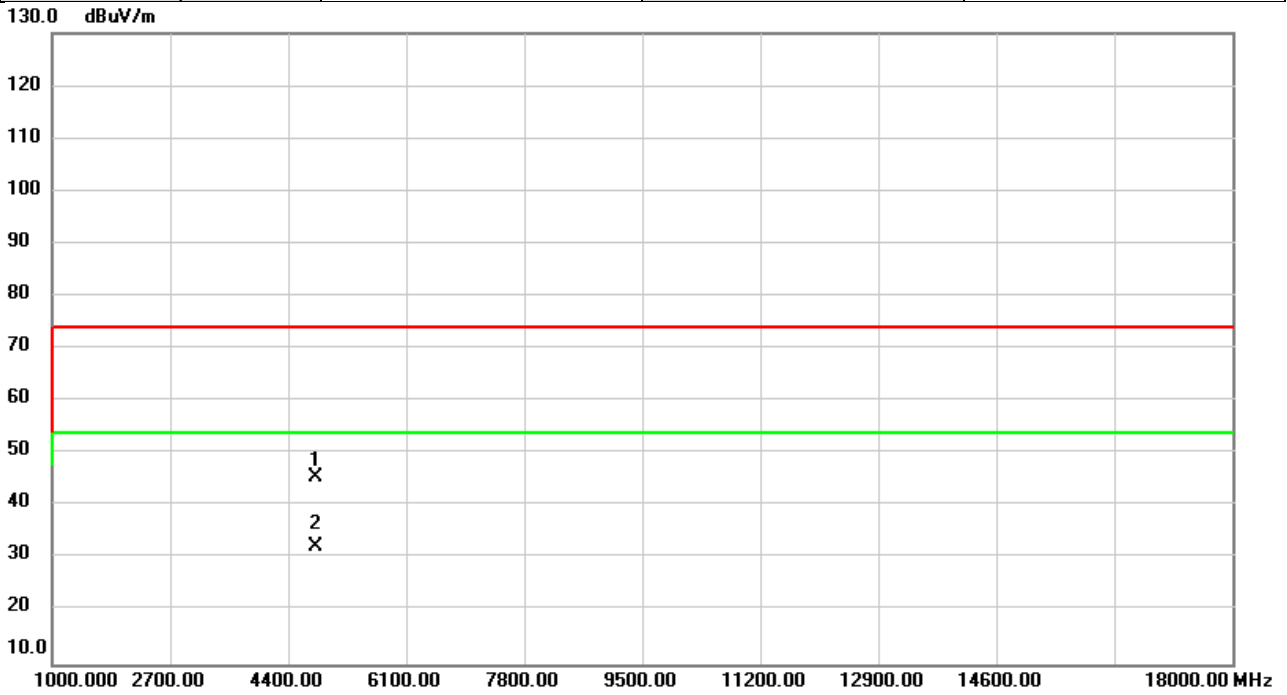

No.	Mk.	Freq. MHz	Reading Level dBuV	Correct Factor dB	Measure- ment dBuV/m	Limit dBuV/m	Over dB	Detector	Comment
1		4804.000	44.56	0.88	45.44	74.00	-28.56	peak	
2	*	4804.000	31.37	0.88	32.25	54.00	-21.75	AVG	

REMARKS:

- (1) Measurement Value = Reading Level + Correct Factor.
- (2) Margin Level = Measurement Value - Limit Value.

Test Mode	BLE 5.3 (1 Mbps)	Test Date	2024/11/25
Test Frequency	2402MHz	Polarization	Horizontal
Temp	25°C	Hum.	60%

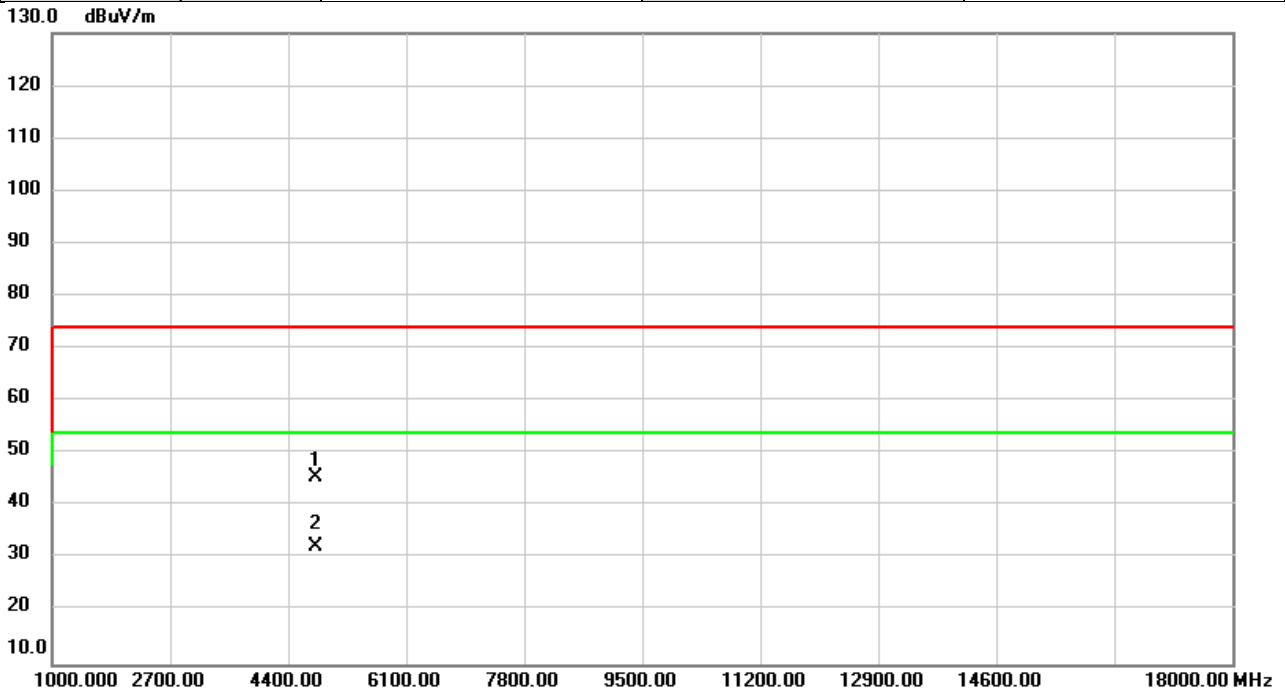

No.	Mk.	Freq. MHz	Reading Level dBuV	Correct Factor dB	Measure- ment dBuV/m	Limit dBuV/m	Over dB	Detector	Comment
1		4804.000	44.73	0.88	45.61	74.00	-28.39	peak	
2	*	4804.000	31.46	0.88	32.34	54.00	-21.66	AVG	

REMARKS:

- (1) Measurement Value = Reading Level + Correct Factor.
- (2) Margin Level = Measurement Value - Limit Value.

Test Mode	BLE 5.3 (1 Mbps)	Test Date	2024/11/25
Test Frequency	2440MHz	Polarization	Vertical
Temp	25°C	Hum.	60%

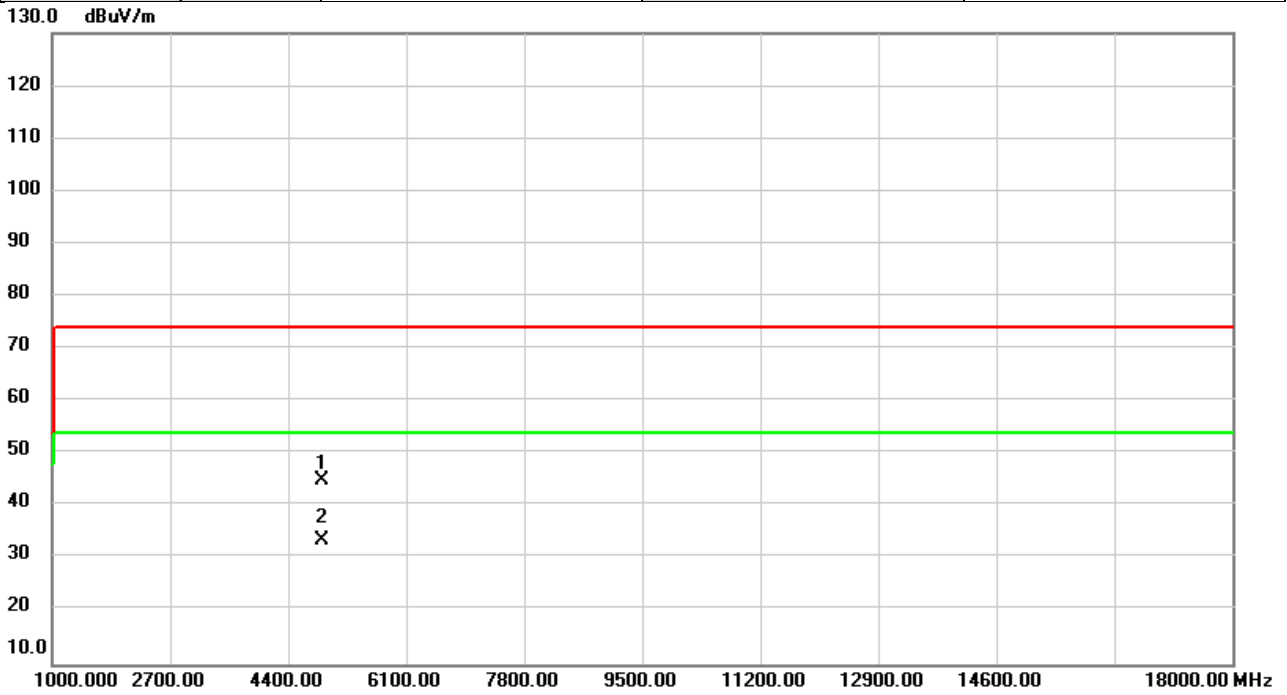

No.	Mk.	Freq. MHz	Reading Level dBuV	Correct Factor dB	Measure- ment dBuV/m	Limit dBuV/m	Over dB	Detector	Comment
1		4880.000	44.02	1.03	45.05	74.00	-28.95	peak	
2	*	4880.000	32.49	1.03	33.52	54.00	-20.48	AVG	

REMARKS:

- (1) Measurement Value = Reading Level + Correct Factor.
- (2) Margin Level = Measurement Value - Limit Value.

Test Mode	BLE 5.3 (1 Mbps)	Test Date	2024/11/25
Test Frequency	2440MHz	Polarization	Horizontal
Temp	25°C	Hum.	60%

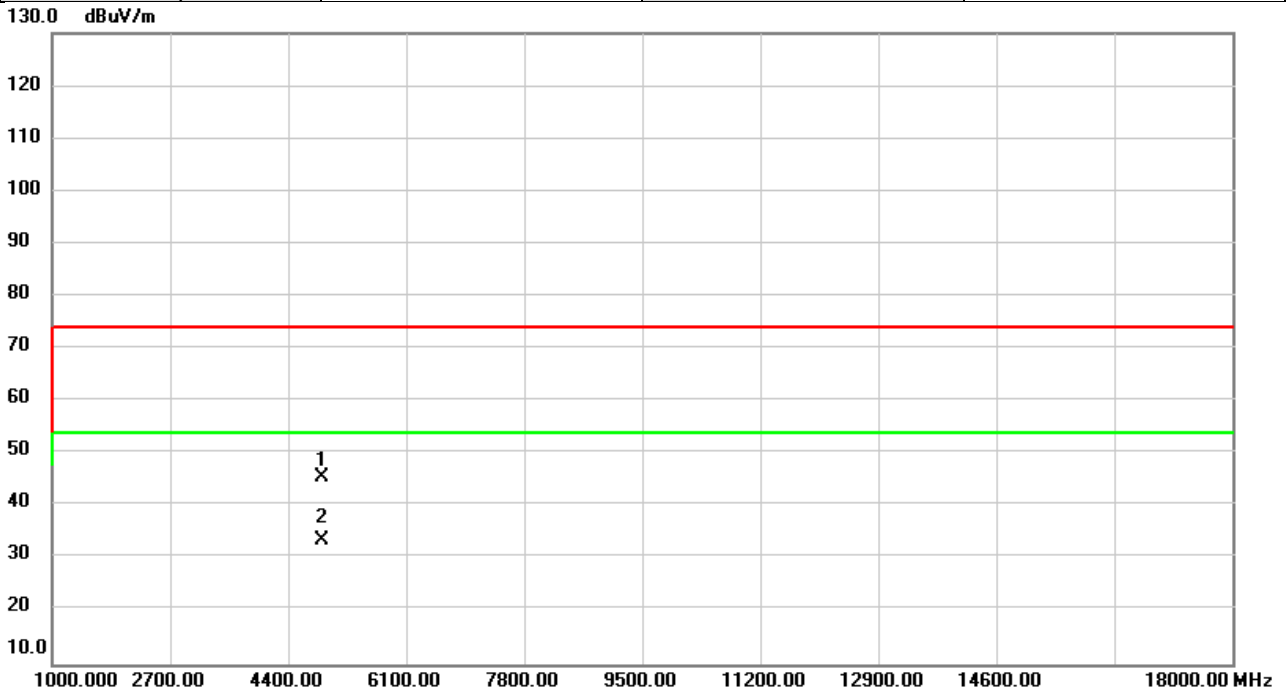

No.	Mk.	Freq. MHz	Reading Level dBuV	Correct Factor dB	Measure- ment dBuV/m	Limit dBuV/m	Over dB	Detector	Comment
1		4880.000	44.51	1.03	45.54	74.00	-28.46	peak	
2	*	4880.000	32.59	1.03	33.62	54.00	-20.38	AVG	

REMARKS:

- (1) Measurement Value = Reading Level + Correct Factor.
- (2) Margin Level = Measurement Value - Limit Value.

Test Mode	BLE 5.3 (1 Mbps)	Test Date	2024/11/25
Test Frequency	2480MHz	Polarization	Vertical
Temp	25°C	Hum.	60%

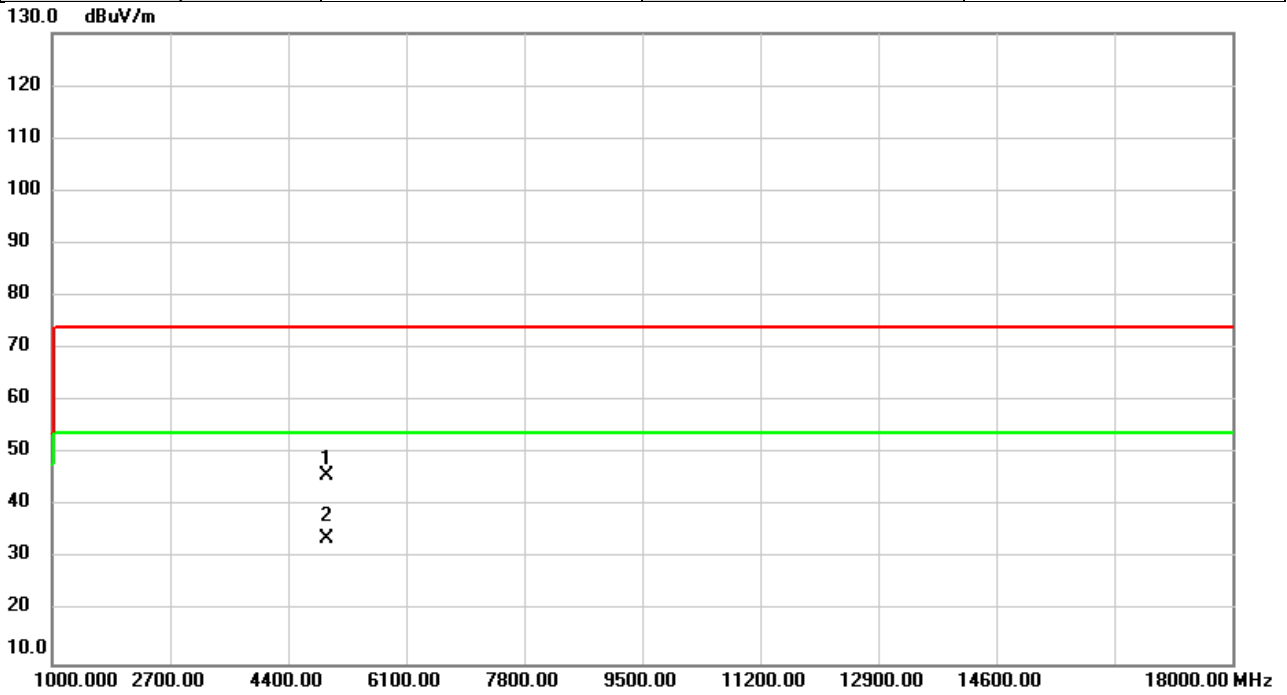

No.	Mk.	Freq. MHz	Reading Level dBuV	Correct Factor dB	Measure- ment dBuV/m	Limit dBuV/m	Over dB	Detector	Comment
1		4960.000	44.73	1.21	45.94	74.00	-28.06	peak	
2	*	4960.000	32.58	1.21	33.79	54.00	-20.21	AVG	

REMARKS:

- (1) Measurement Value = Reading Level + Correct Factor.
- (2) Margin Level = Measurement Value - Limit Value.

Test Mode	BLE 5.3 (1 Mbps)	Test Date	2024/11/25
Test Frequency	2480MHz	Polarization	Horizontal
Temp	25°C	Hum.	60%

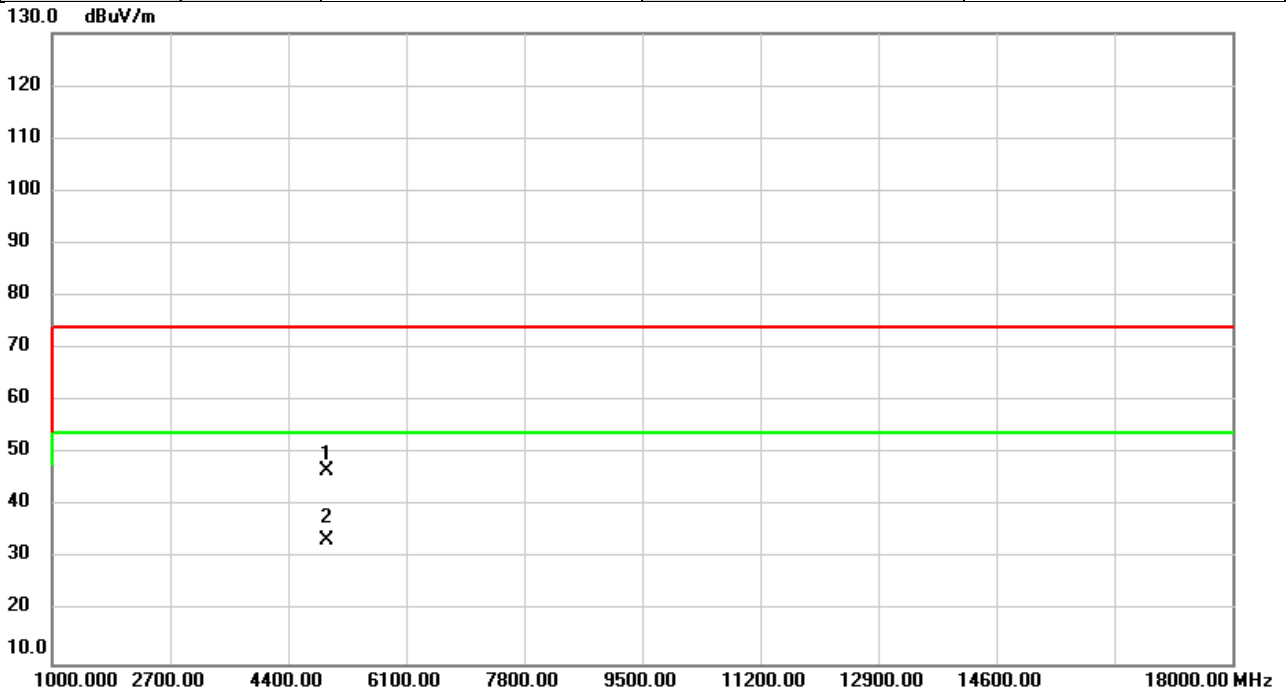

No.	Mk.	Freq. MHz	Reading Level dBuV	Correct Factor dB	Measure- ment dBuV/m	Limit dBuV/m	Over dB	Detector	Comment
1		4960.000	45.69	1.21	46.90	74.00	-27.10	peak	
2	*	4960.000	32.44	1.21	33.65	54.00	-20.35	AVG	

REMARKS:

- (1) Measurement Value = Reading Level + Correct Factor.
- (2) Margin Level = Measurement Value - Limit Value.

Test Mode	BLE 5.3 (2 Mbps)	Test Date	2024/11/25
Test Frequency	2402MHz	Polarization	Vertical
Temp	25°C	Hum.	60%

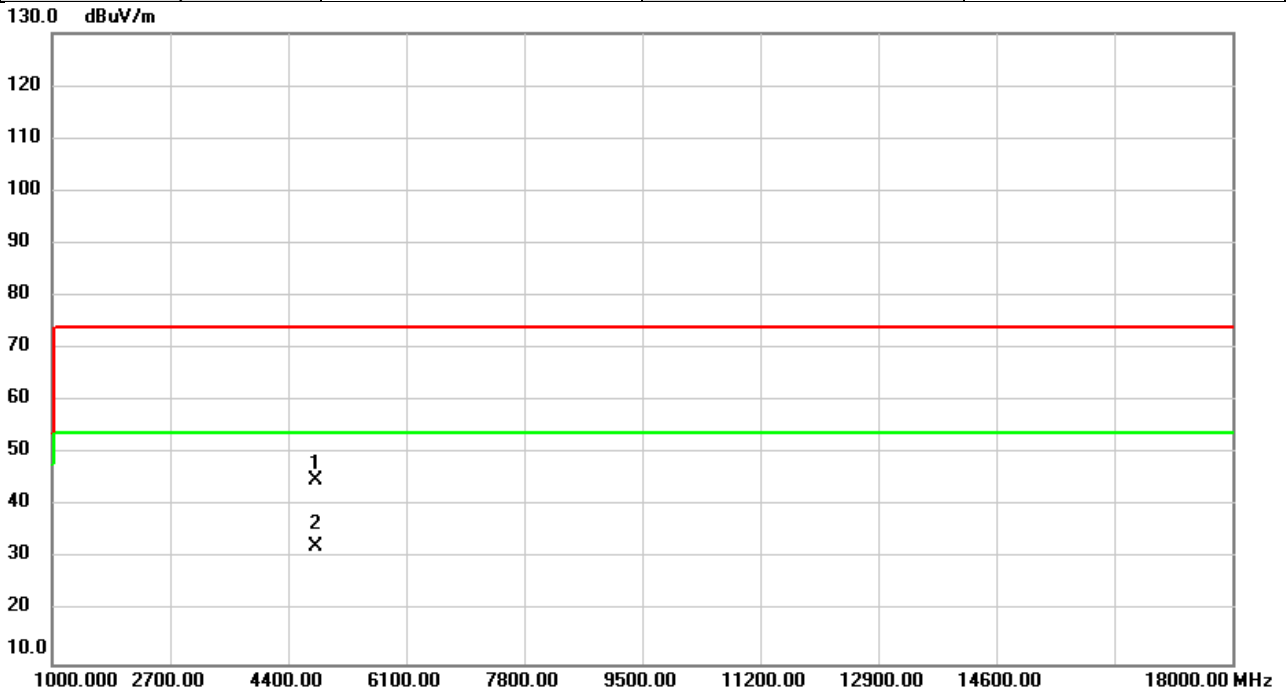

No.	Mk.	Freq. MHz	Reading Level dBuV	Correct Factor dB	Measure- ment dBuV/m	Limit dBuV/m	Over dB	Detector	Comment
1		4804.000	44.21	0.88	45.09	74.00	-28.91	peak	
2	*	4804.000	31.37	0.88	32.25	54.00	-21.75	AVG	

REMARKS:

- (1) Measurement Value = Reading Level + Correct Factor.
- (2) Margin Level = Measurement Value - Limit Value.

Test Mode	BLE 5.3 (2 Mbps)	Test Date	2024/11/25
Test Frequency	2402MHz	Polarization	Horizontal
Temp	25°C	Hum.	60%

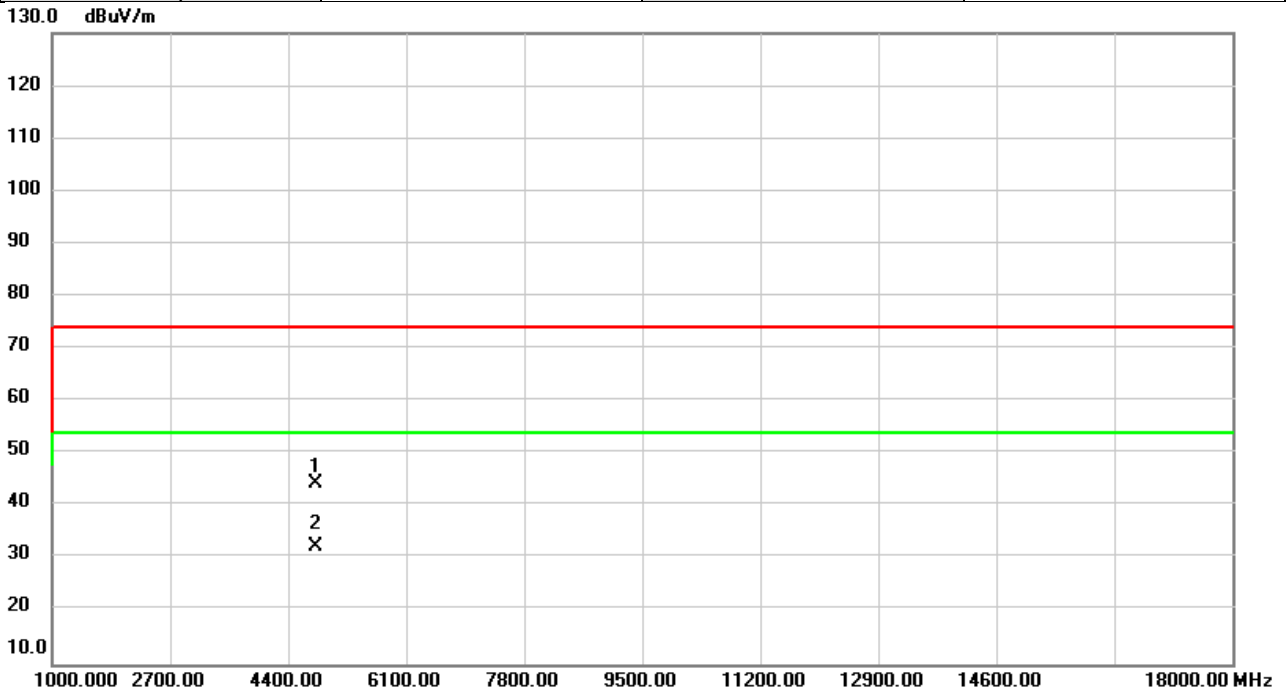

No.	Mk.	Freq. MHz	Reading Level dBuV	Correct Factor dB	Measure- ment dBuV/m	Limit dBuV/m	Over dB	Detector	Comment
1		4804.000	43.54	0.88	44.42	74.00	-29.58	peak	
2	*	4804.000	31.41	0.88	32.29	54.00	-21.71	AVG	

REMARKS:

- (1) Measurement Value = Reading Level + Correct Factor.
- (2) Margin Level = Measurement Value - Limit Value.

Test Mode	BLE 5.3 (2 Mbps)	Test Date	2024/11/25
Test Frequency	2440MHz	Polarization	Vertical
Temp	25°C	Hum.	60%

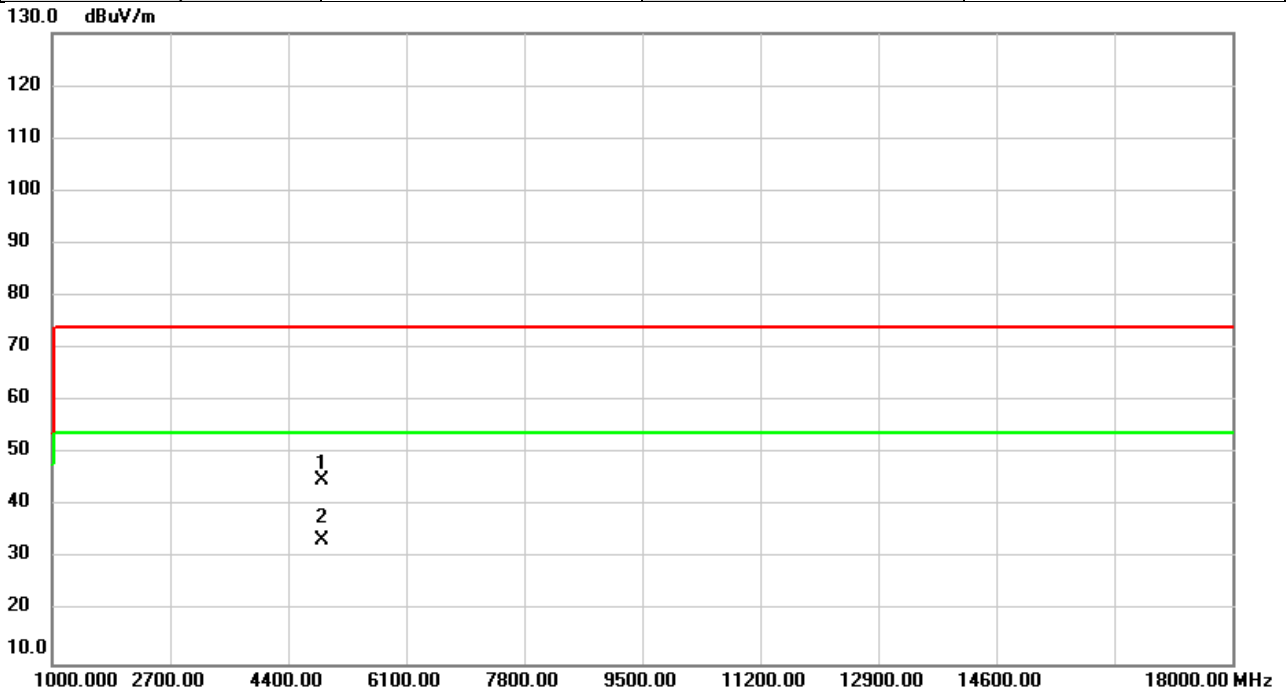

No.	Mk.	Freq. MHz	Reading Level dBuV	Correct Factor dB	Measure- ment dBuV/m	Limit dBuV/m	Over dB	Detector	Comment
1		4880.000	44.00	1.03	45.03	74.00	-28.97	peak	
2	*	4880.000	32.38	1.03	33.41	54.00	-20.59	AVG	

REMARKS:

- (1) Measurement Value = Reading Level + Correct Factor.
- (2) Margin Level = Measurement Value - Limit Value.

Test Mode	BLE 5.3 (2 Mbps)	Test Date	2024/11/25
Test Frequency	2440MHz	Polarization	Horizontal
Temp	25°C	Hum.	60%

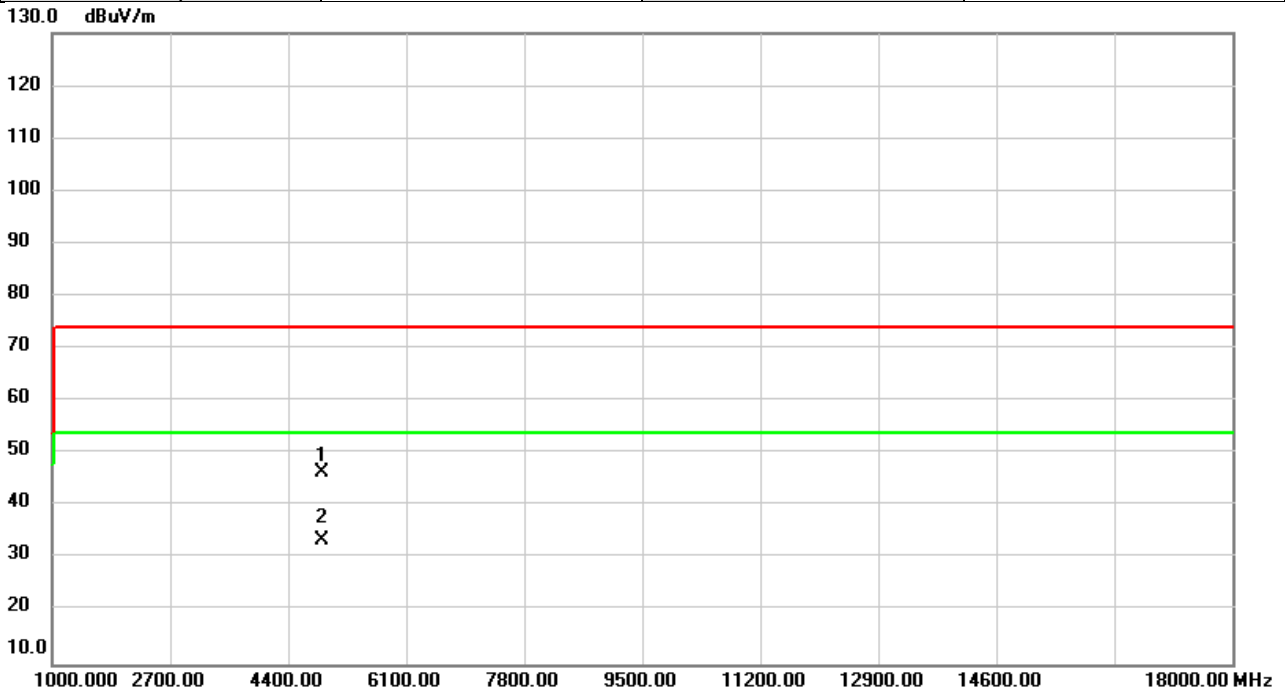

No.	Mk.	Freq. MHz	Reading Level dBuV	Correct Factor dB	Measure- ment dBuV/m	Limit dBuV/m	Over dB	Detector	Comment
1		4880.000	45.44	1.03	46.47	74.00	-27.53	peak	
2	*	4880.000	32.42	1.03	33.45	54.00	-20.55	AVG	

REMARKS:

- (1) Measurement Value = Reading Level + Correct Factor.
- (2) Margin Level = Measurement Value - Limit Value.

Test Mode	BLE 5.3 (2 Mbps)	Test Date	2024/11/25
Test Frequency	2480MHz	Polarization	Vertical
Temp	25°C	Hum.	60%

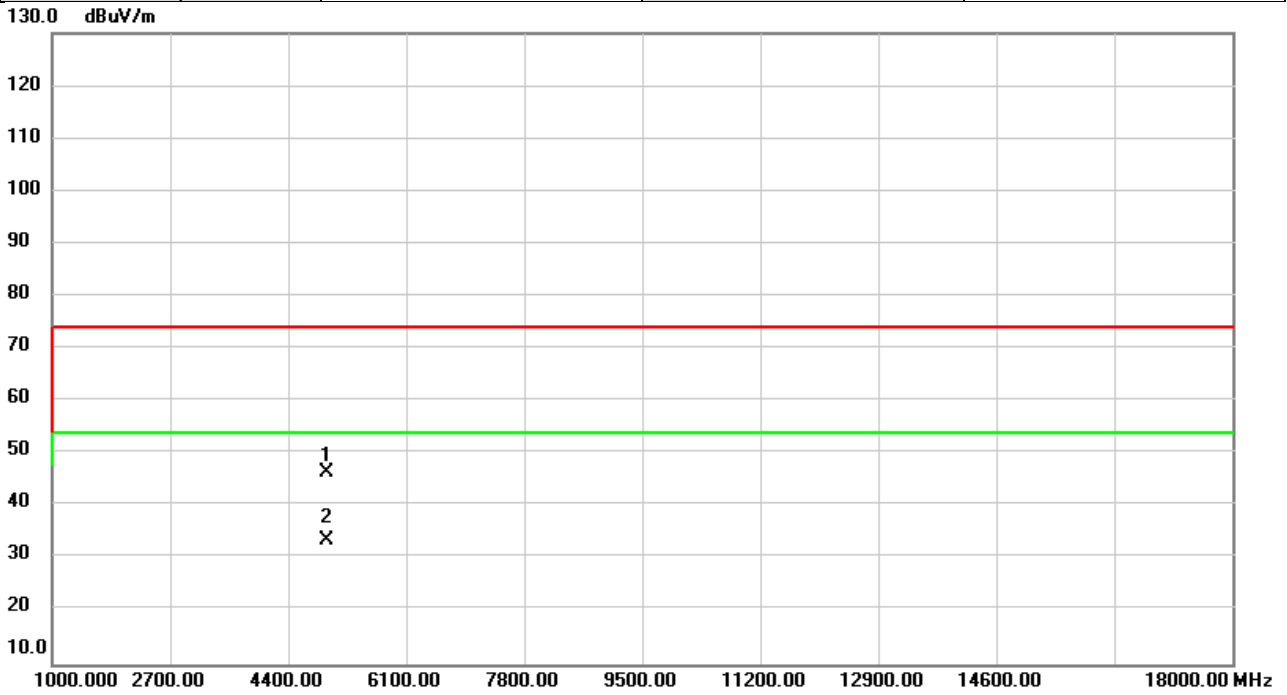

No.	Mk.	Freq. MHz	Reading Level dBuV	Correct Factor dB	Measure- ment dBuV/m	Limit dBuV/m	Over dB	Detector	Comment
1		4960.000	45.14	1.21	46.35	74.00	-27.65	peak	
2	*	4960.000	32.47	1.21	33.68	54.00	-20.32	AVG	

REMARKS:

- (1) Measurement Value = Reading Level + Correct Factor.
- (2) Margin Level = Measurement Value - Limit Value.

Test Mode	BLE 5.3 (2 Mbps)	Test Date	2024/11/25
Test Frequency	2480MHz	Polarization	Horizontal
Temp	25°C	Hum.	60%

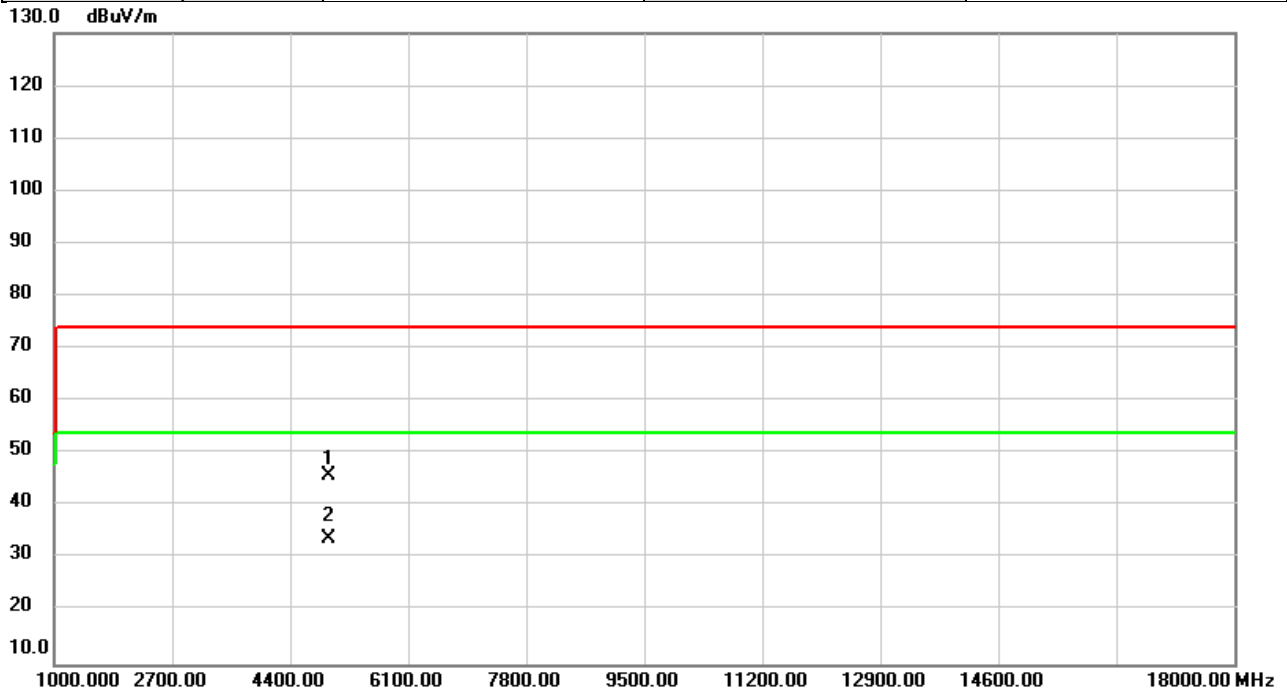

No.	Mk.	Freq.	Reading Level	Correct Factor	Measurement	Limit	Over	Detector	Comment
		MHz	dBuV	dB	dBuV/m	dBuV/m	dB		
1		4960.000	44.70	1.21	45.91	74.00	-28.09	peak	
2	*	4960.000	32.51	1.21	33.72	54.00	-20.28	AVG	

REMARKS:

- (1) Measurement Value = Reading Level + Correct Factor.
- (2) Margin Level = Measurement Value - Limit Value.

Test Mode	BLE 5.3 (1 Mbps)	Test Date	2024/11/25
Test Frequency	2480MHz	Polarization	Vertical
Temp	25°C	Hum.	60%

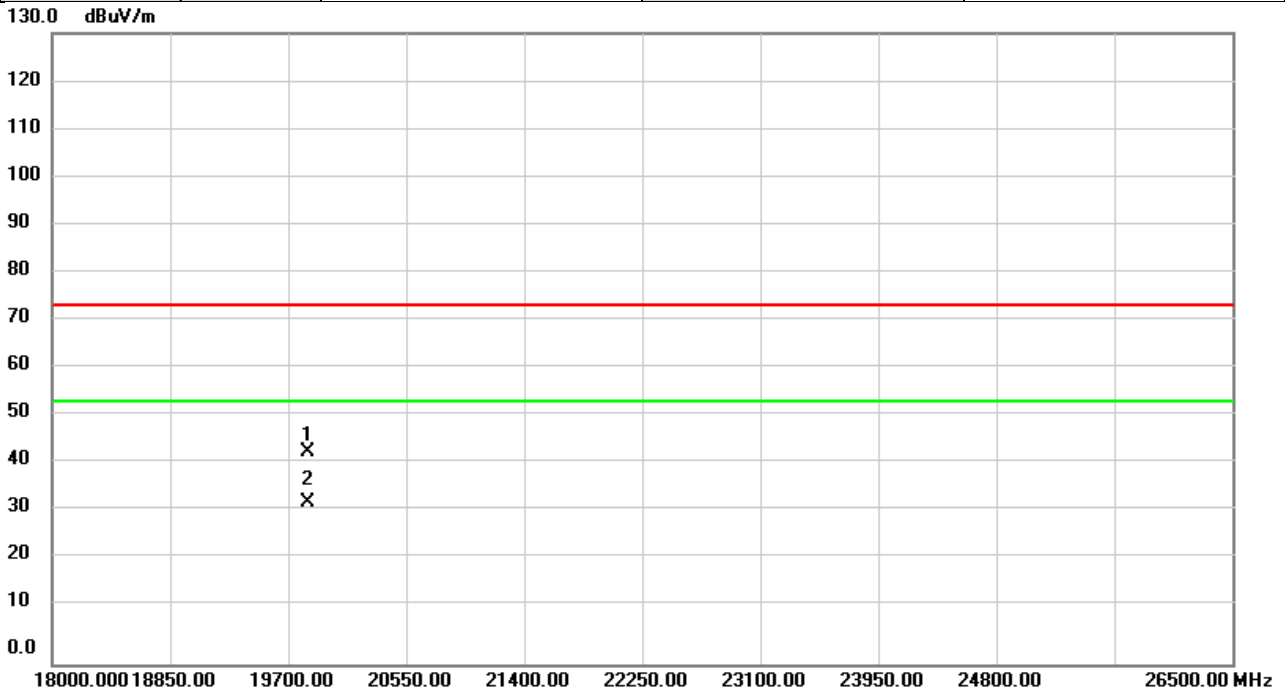

No.	Mk.	Freq. MHz	Reading Level dBuV	Correct Factor dB	Measure- ment dBuV/m	Limit dBuV/m	Over dB	Detector	Comment
1		19840.00	50.65	-6.85	43.80	74.00	-30.20	peak	
2	*	19840.00	40.26	-6.85	33.41	54.00	-20.59	AVG	

REMARKS:

- (1) Measurement Value = Reading Level + Correct Factor.
- (2) Margin Level = Measurement Value - Limit Value.

Test Mode	BLE 5.3 (1 Mbps)	Test Date	2024/11/25
Test Frequency	2480MHz	Polarization	Horizontal
Temp	25°C	Hum.	60%

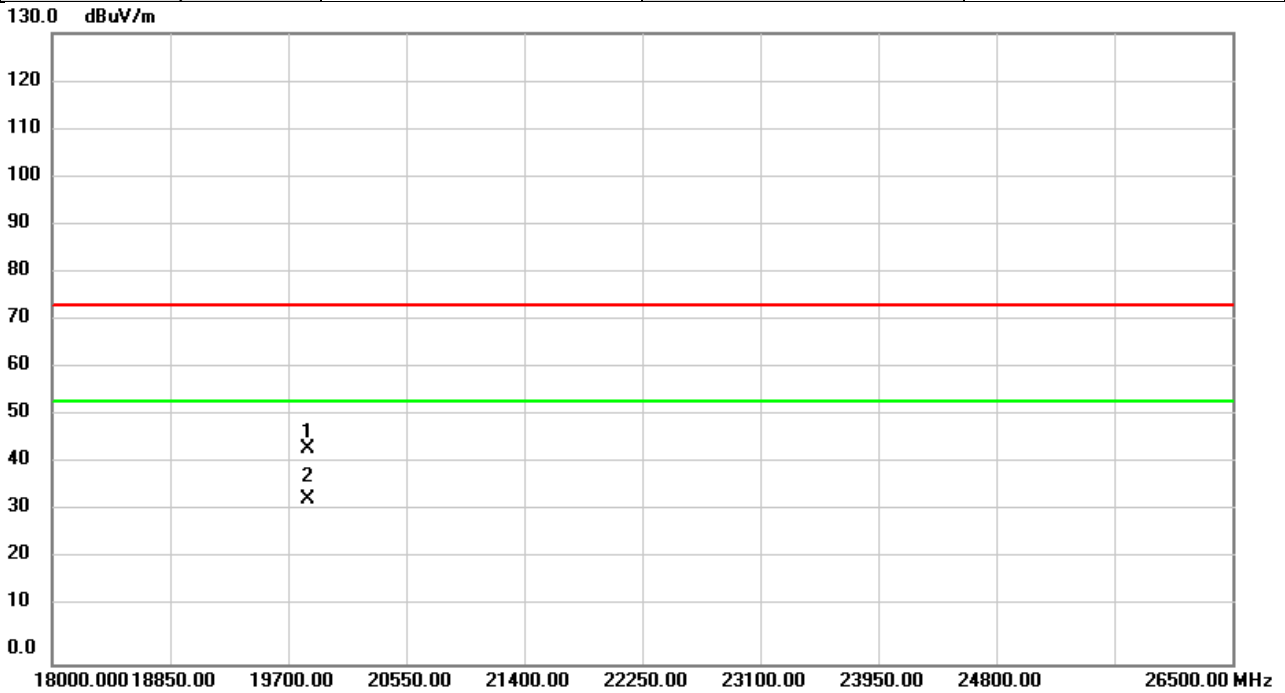

No.	Mk.	Freq. MHz	Reading Level dBuV	Correct Factor dB	Measure- ment dBuV/m	Limit dBuV/m	Over dB	Detector	Comment
1		19840.00	51.37	-6.85	44.52	74.00	-29.48	peak	
2	*	19840.00	40.81	-6.85	33.96	54.00	-20.04	AVG	

REMARKS:

- (1) Measurement Value = Reading Level + Correct Factor.
- (2) Margin Level = Measurement Value - Limit Value.

APPENDIX E BANDWIDTH

Test Mode:	1Mbps
------------	-------

Frequency (MHz)	6dB Bandwidth (MHz)	99% Occupied BW (MHz)	Min. Limit (kHz)	Test Result
2402	0.71	1.03	500	Pass
2440	0.70	1.03	500	Pass
2480	0.71	1.03	500	Pass

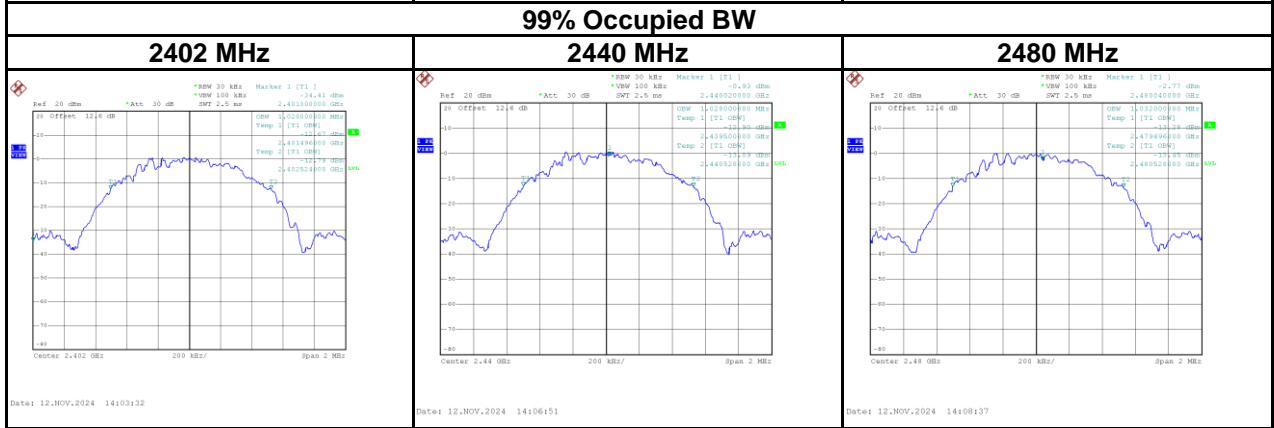
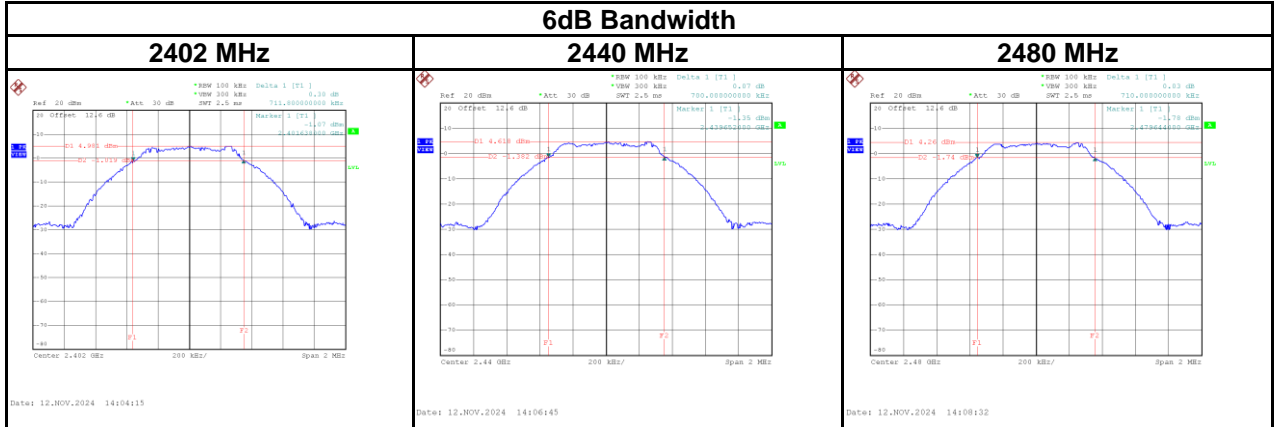

Test Mode:	2Mbps
------------	-------

Frequency (MHz)	6dB Bandwidth (MHz)	99% Occupied BW (MHz)	Min. Limit (kHz)	Test Result
2402	1.18	1.98	500	Pass
2440	1.17	1.98	500	Pass
2480	1.17	1.98	500	Pass

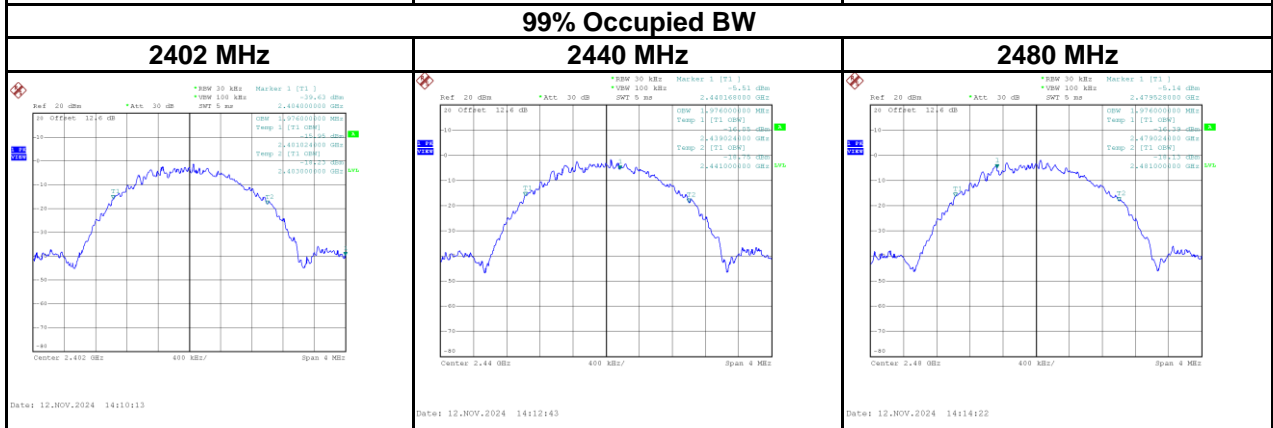
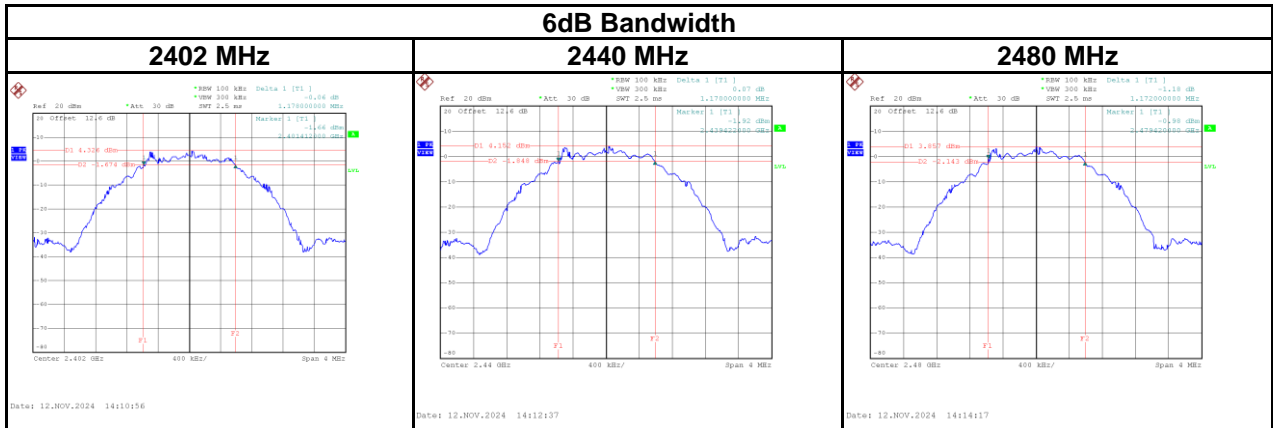

APPENDIX F OUTPUT POWER

Test Mode :	1Mbps	Tested Date	2024/11/12
-------------	-------	-------------	------------

Frequency (MHz)	Conducted Power (dBm)	Conducted Power (W)	Max. Limit (dBm)	Max. Limit (W)	Test Result
2402	6.65	0.0046	30.00	1.0000	Pass
2440	6.36	0.0043	30.00	1.0000	Pass
2480	5.95	0.0039	30.00	1.0000	Pass

Test Mode :	2Mbps	Tested Date	2024/11/12
-------------	-------	-------------	------------

Frequency (MHz)	Conducted Power (dBm)	Conducted Power (W)	Max. Limit (dBm)	Max. Limit (W)	Test Result
2402	6.57	0.0045	30.00	1.0000	Pass
2440	6.27	0.0042	30.00	1.0000	Pass
2480	5.86	0.0039	30.00	1.0000	Pass

APPENDIX G POWER SPECTRAL DENSITY TEST

Test Mode : 1Mbps

Frequency (MHz)	Power Density (dBm/3kHz)	Max. Limit (dBm/3kHz)	Test Result
2402	-10.54	8	Pass
2440	-10.20	8	Pass
2480	-10.75	8	Pass

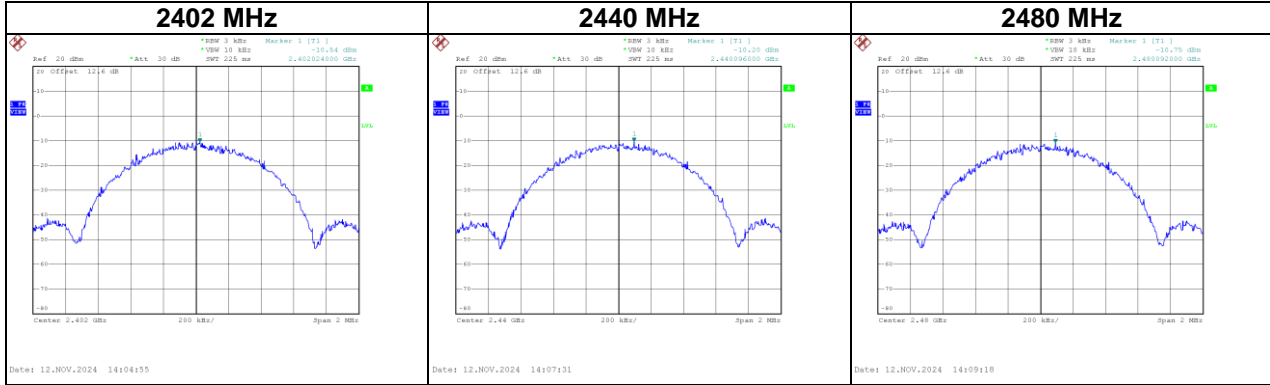

Test Mode : 2Mbps

Frequency (MHz)	Power Density (dBm/3kHz)	Max. Limit (dBm/3kHz)	Test Result
2402	-14.55	8	Pass
2440	-13.88	8	Pass
2480	-13.98	8	Pass

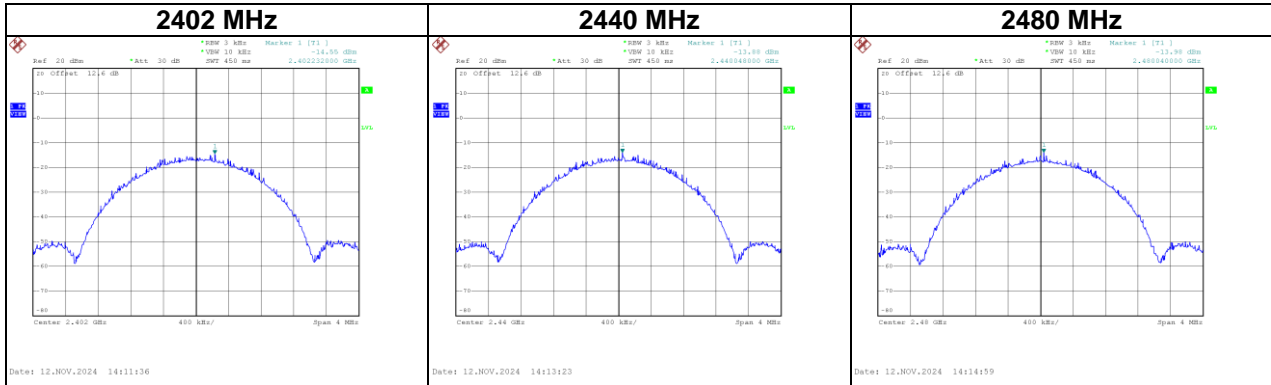

APPENDIX H ANTENNA CONDUCTED SPURIOUS EMISSION

Test Mode : 1Mbps

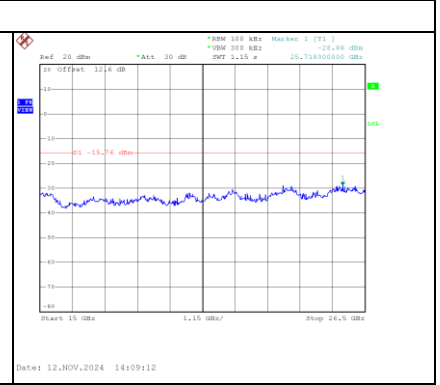
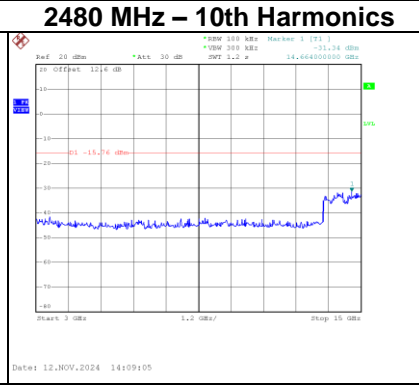
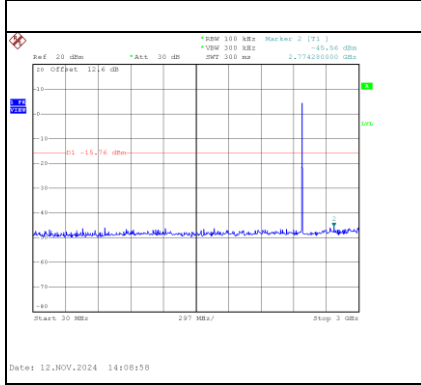
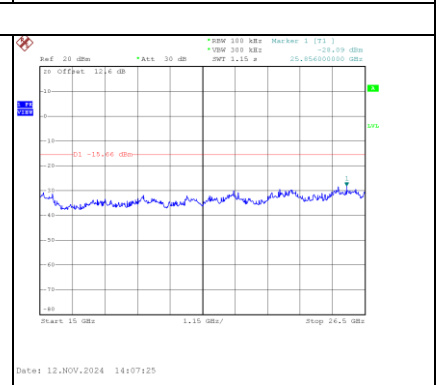
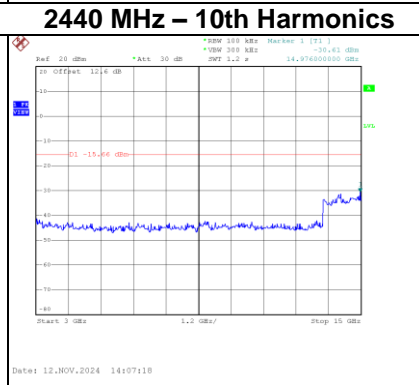
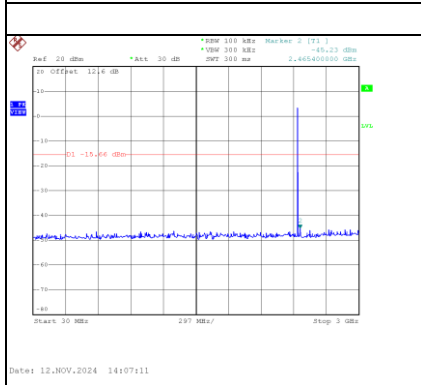
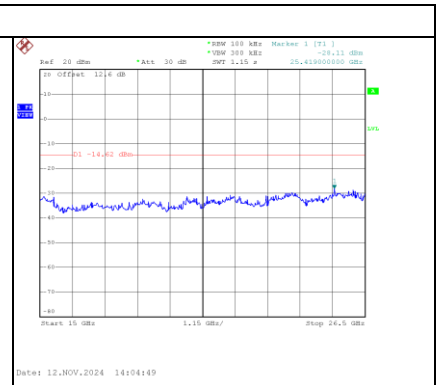
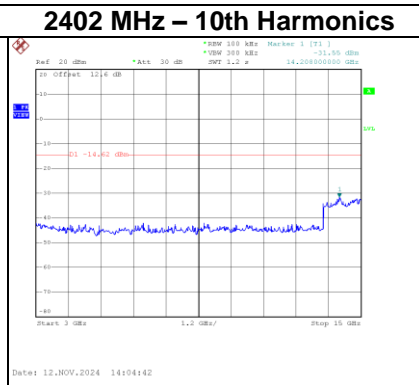
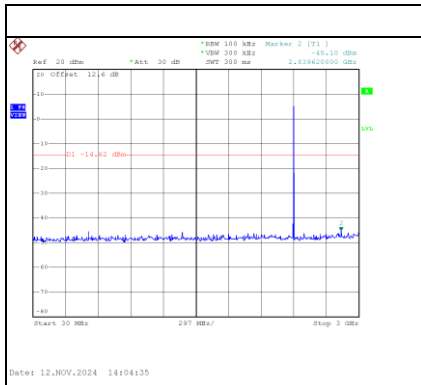
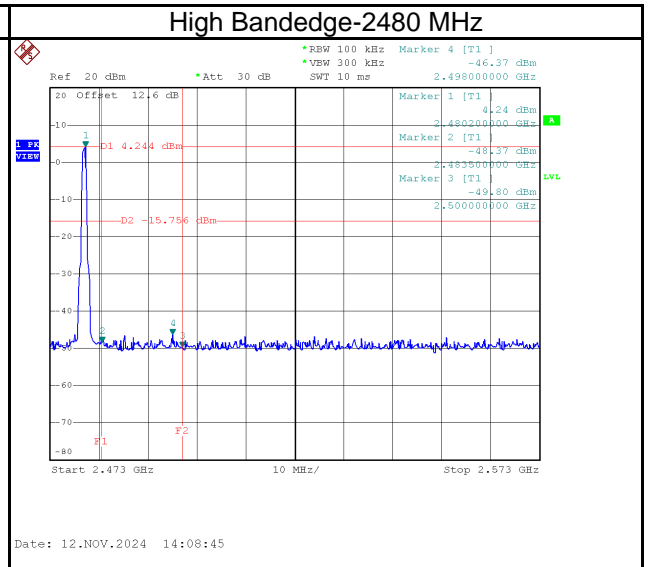
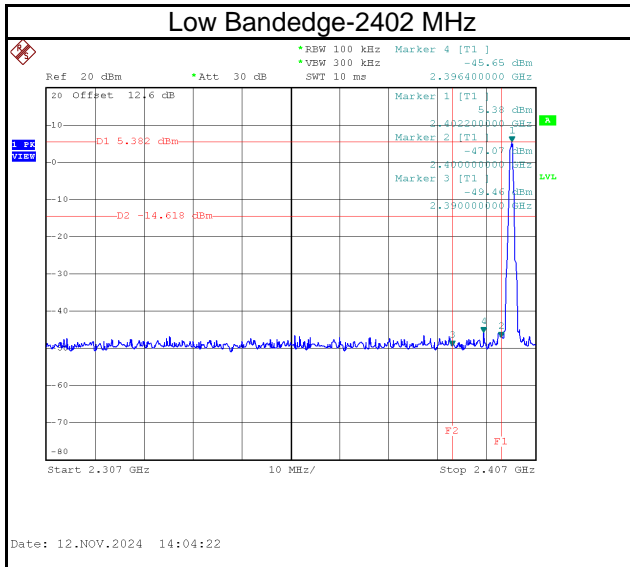

Test Mode : 2Mbps

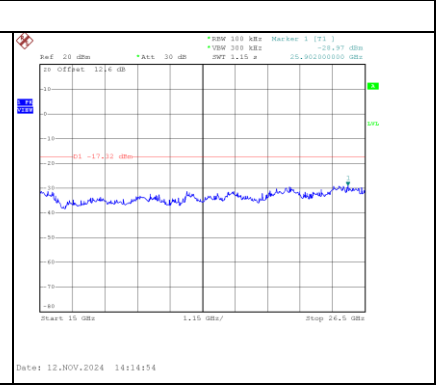
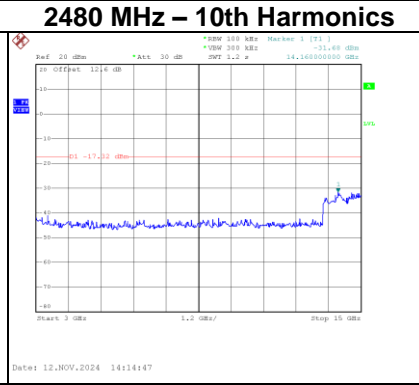
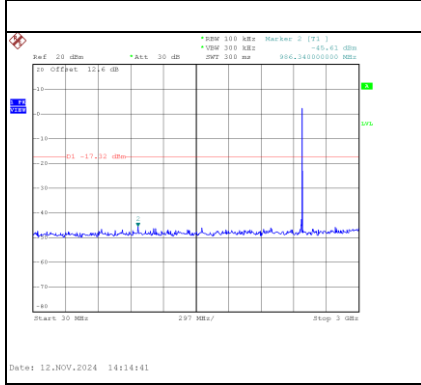
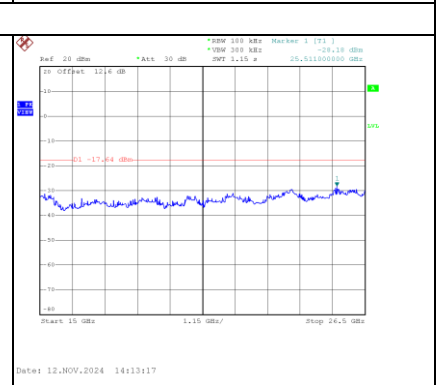
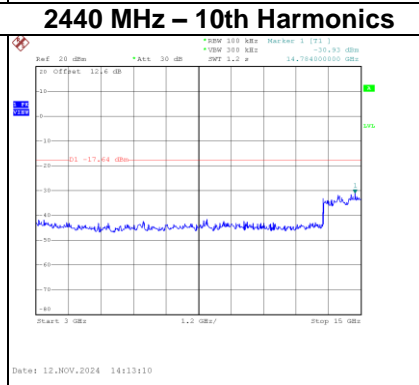
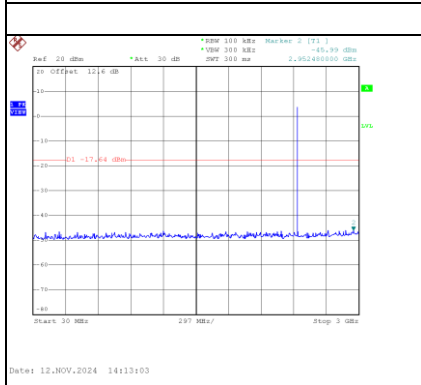
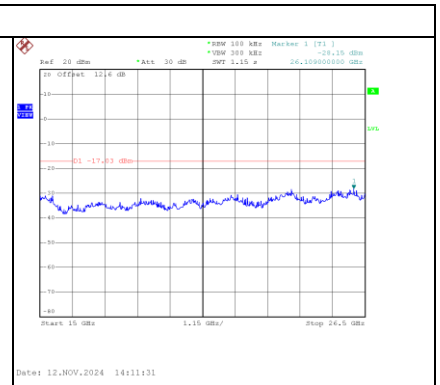
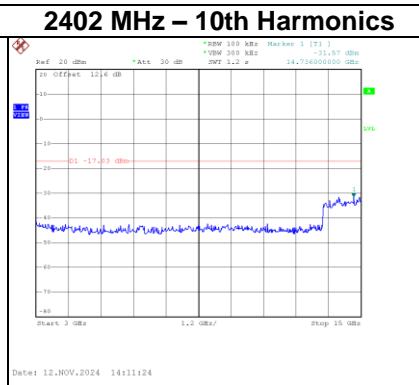
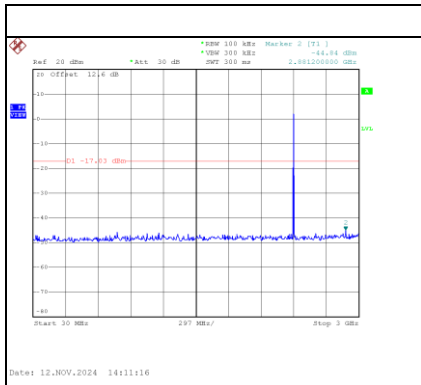
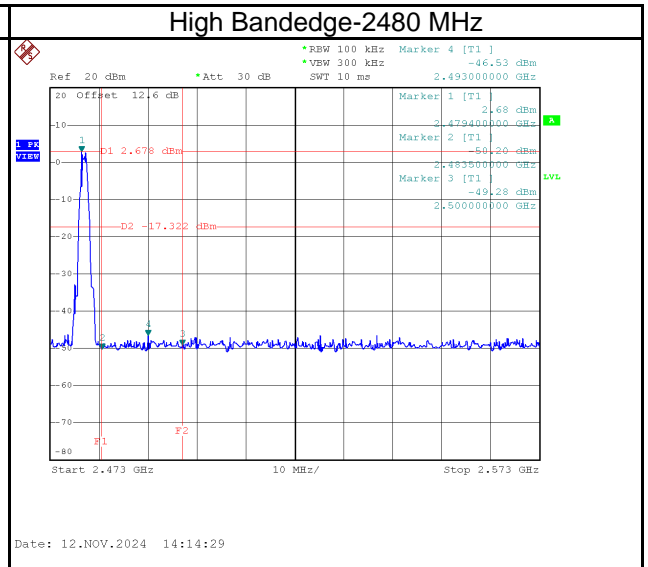
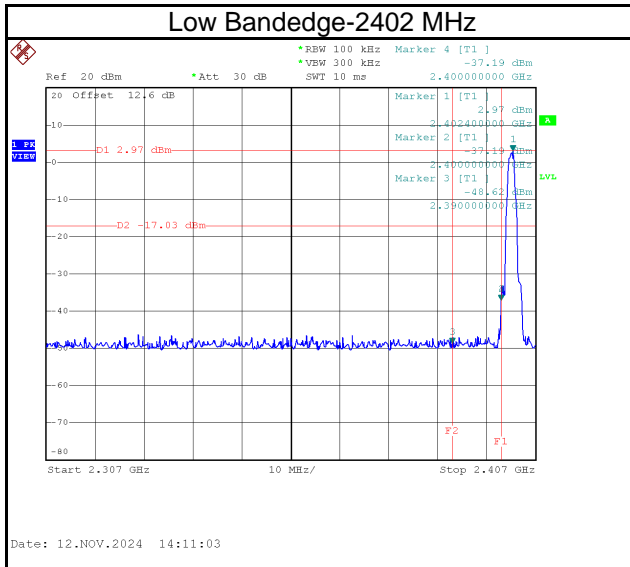

End of Test Report