

Harxon

a *BDStar* company

eRadio

User Guide

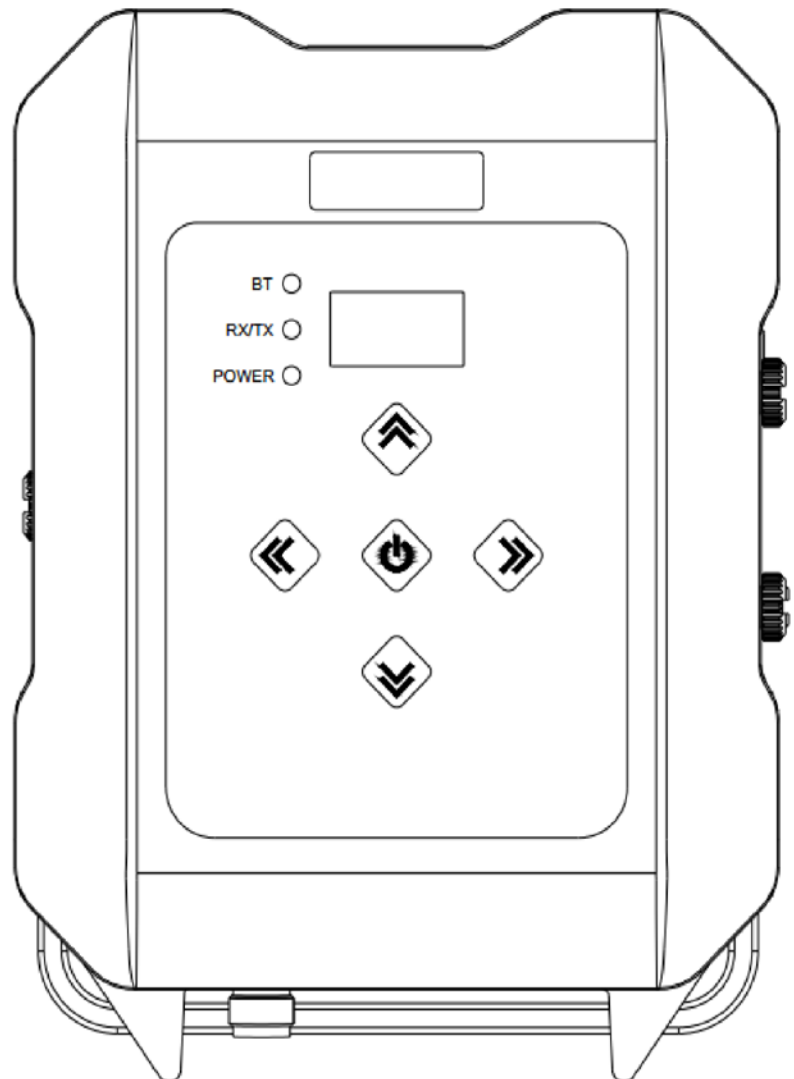

Version/Warranty/Repair/Copyright

Version Information

- Version Number: V1.0
- Version Date: August 30, 2018

Warranty Period

- eRadio: 1 year

Instruction of Returning to the Factory

If something is wrong with the product, it should be returned to the factory, please [contact us](#).

Copyright Information

The operation guide of this product and all involving software are protected by Shenzhen Harxon Antenna Technology Co., Ltd (hereinafter referred to as Harxon). All rights reserved. All rights of this manual, including copyright, are exclusively owned by Harxon. Unless the copyright owner permits, this manual is prohibited from being copied by the means of printing, duplicating or recording, etc..

Disclaimer

During the compilation, this manual strives for the accuracy and completeness of contents, but Harxon assumes no responsibility for any possible error or omission. Due to continuous development of the technology, Harxon is entitled to change the technical specifications or functions of its products without informing users in written form.

Contents

Version/Warranty/Repair/Copyright	2
Warranty Period	2
Instruction of Returning to the Factory	2
Copyright Information	2
Disclaimer	2
Contents.....	3
Diagram Index.....	5
Table Index	6
Notice	7
Meanings of Signs in This Manual	7
Information of Certification Passed by This Product	7
English Abbreviation A-Z in This Manual	7
User Service.....	8
Common Problem Analysis	8
Record Information.....	8
Contact Us.....	8
1 Introduction	9
1.1 Product Features	10
1.2 Convention.....	10
2 Interface and Component	11
2.1 Interface of Serial Port Data Cable	11
2.2 Radio Frequency Interface	11
2.3 Instruction of Indicator Lights	11
2.4 Bluetooth Module	12
2.5 Network Module	12
3 Functions and Operation Instruction	13
3.1 Startup & Shutdown Button	13
3.2 Left and Right Buttons.....	13
3.3 Up and Down Buttons	13
3.4 Data Transmitting-receiving Indicator Light	13
3.5 3G/4G and Bluetooth Operating Condition	13
3.6 Instruction of Radio Startup and Power Indicator Light Conditions.....	14
3.7 Device Menu.....	14
3.7.1 Device Information	15
3.7.2 Transmitting/Receiving Channel and Frequency.....	15
3.7.3 Data Protocol.....	15
3.7.4 RF Baud Rate	16
3.7.5 Transmitting/Receiving Mode	16
3.7.6 Transmitting Power.....	16
3.7.7 Serial Port Baud Rate	17
3.7.8 Serial Port Baud Rate Self-adaption.....	17
3.7.9 OLED Sleep Mode	18
3.7.10 Interference Detection	18
3.7.11 Language	19
3.8 Use of Radio Configuration Software	19
3.8.1 Configuration Environment.....	19
3.8.2 Configuration Tool Installation.....	20
3.8.3 Radio Parameter Query.....	21
3.8.4 Radio Parameter Configuration.....	23
3.9 Firmware Upgrade	24
Appendix A Technical Indexes.....	28

A.1 Specifications and Parameters of Data Transmission Radio.....	28
A.2 Bluetooth Parameters.....	29
A.3 Network Parameters.....	29
A.4 eRadio Suite Parts.....	30
A.4.1 Radio Configuration Cable (HJ394) (Optional).....	30
A.4.2 Power Cable (HJ379).....	31
Appendix B Command.....	33
Appendix C eRadio SIM Setup.....	38
Appendix D eRadio FAQ.....	39
FCC Compliance Statement.....	40

Diagram Index

Figure 1 eRadio.....	9
Figure 2 Diagram of eRadio Data Interface.....	11



Table Index

Table 1 Meanings of Signs in This Manual	7
Table 2 Information of Certification Passed by This Product (supplemented to be complete)	7
Table 3 eRadio Data Interface Definition.....	11
Table 4 Specifications and Parameters of Radio	28
Table 5 Specifications and Parameters of Bluetooth Module	29
Table 6 Specifications and Parameters of Network Module②	29
Table 7 List of Radio Configuration Cable HJ394 Parts	30
Table 8 Definition of HJ394 Data Cable B Port①.....	31
Table 9 List of Power Cable HJ379 Parts	32
Table 10 eRadio Background Configuration Mode Command Format.....	33
Table 11 List of eRadio Background Configuration Mode Commands	34

Notice

Meanings of Signs in This Manual

Table 1 Meanings of Signs in This Manual

Sign	Meaning	Remarks
	Indicate there are notes in the page for this index/matter	When there are multiple notes in one page, the number in the sign will increase.
	Some matters requiring users' attention	

Information of Certification Passed by This Product

Table 2 Information of Certification Passed by This Product

Standard	Remarks
FCC	Rules and Regulations: FCC Part 15B/15C/22H/24E/27L, Part90
CE	RED Article3.2 Radio RED Article3.1(b) EMC RED Article3.1(a) Safety RED Article3.1(a) Health
RoHS	RoHS Directive 2011/65/EU and its amendment directives –XRF screening test and Wet Chemical Testing (Lead, Cadmium, Mercury, Hexavalent Chromium, PBBs & PBDEs content)
REACH	One hundred and seventy three (173) substances in the Candidate List of Substances of Very High Concern (SVHC) for authorization published by European Chemicals Agency (ECHA) on and before January 12, 2017 regarding Regulation (EC) No 1907/2006 concerning the REACH
IP67	

English Abbreviation A-Z in This Manual

APN	Access Point Name
ASCII	American Standard Code for Information Interchange
BT	Bluetooth
GPS	Global Positioning System
IP	Internet Protocol

User Service

Common Problem Analysis

If you encounter some technical problems, refer to Section [eRadio FAQ](#) in this manual. This part describes the phenomena, causes and solutions of some common problems.

Record Information

If the technical problems you encounter are not recorded in the manual, make a record of the operating environment, use procedure, problem phenomenon before and after device abnormality, as well as information such as product model, product hardware version and firmware version.

Product model, product hardware version and firmware version can be queried through eRadio configuration tools.

Contact Us

Please contact us for more help.

Service Hotline: +86-755-26989948 (8:30-12:00 13:30-18:00)

Sale Hotline: +86-755-86578389 (8:30-12:00 13:30-18:00)

Company Fax: +86-755-26989994

Company Email: sales@harxon.com

1 Introduction

As a type of external transmitting-receiving data radio, eRadio supports many options of transmitting power, with waterproofing grade up to IP67 and sturdy and durable structure, applicable for outdoor use under all weather conditions.

eRadio is equipped with 3 bi-color indicator lights (①Wireless transmitting-receiving indicator light: green while receiving, red while transmitting; ②Power indicator light: green for normal supply, red for under-voltage; ③3G/4G and Bluetooth indicator light: green indicator light links to 3G/4G, red indicator light links to Bluetooth), one OLED display and five buttons, convenient for human-computer interaction.



Figure 1 eRadio

1.1 Product Features

Main features of eRadio:

- Full-band support, with the frequency point range of 410MHz -470MHz
- Many options of transmitting power
- Self-adaptive function of serial port baud rate
- OLED display
- 5 user buttons
- One-way RS232 interface
- Bluetooth module^①
- 3G/4G module^①
- 3 bi-color status indicator lights
- IP67 protection



^① *Optional component.*

1.2 Convention

The following conventions are used in this manual:

- The characters following 0x are hexadecimal digits
- The characters used by transmitted commands are case insensitive

2 Interface and Component

2.1 Interface of Serial Port Data Cable

The interface of serial port data cable uses the asynchronous serial communication RS232 standard.

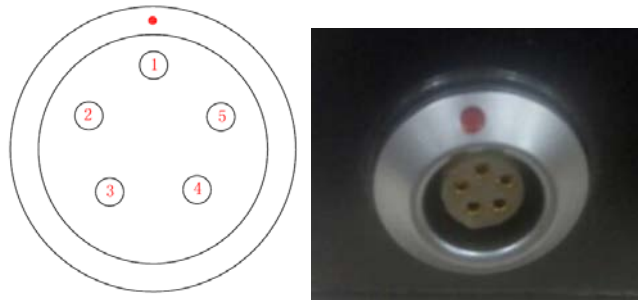

Figure 2 Diagram of eRadio Data Interface

Table 33 eRadio Data Interface Definition

Pin	Name	Description	Remarks
1	VCC	Power output	DC9-16V
2	GND1	Power Ground	
3	RXD	Serial port data receiving	RS232 Level
4	GND2	Signal Ground	
5	TXD	Serial port data transmitting	RS232 Level

2.2 Radio Frequency Interface

The eRadio radio frequency interface uses 50 OHM TNC negative connector.

2.3 Instruction of Indicator Lights

- 3G/4G/BT is 3G/4G and Bluetooth red and green indicator light, red indicator light represents 3G/4G module and green one represents Bluetooth module;
- RX/TX is data transmitting-receiving red and green indicator light, green indicator light represents data receiving, red indicator light represents data transmitting;
- PWR/ALM is bi-color indicator light for normal power supply and under-voltage, green indicator light represents normal power supply, red indicator light represents abnormal voltage;

2.4 Bluetooth Module

If the current radio supports Bluetooth, users can configure and query the radio parameters by the means of Bluetooth, Bluetooth V5.0 is supported;

2.5 Network Module

If the current radio supports network data transmission, users can transmit their data via network, now radio can be used as CORS station, without the need of RTK device, thus saving cost and simplifying outdoor operation. In addition, network module supports 3G/4G.

3 Functions and Operation Instruction

3.1 Startup & Shutdown Button

The startup & shutdown button (power button) can be used to control radio power-on and power-off, with specific functions as follows:

- Short press the startup button for about 1 second to power on, the green power indicator light illuminates in the case of successful power-on (under the condition of normal power supply).
- Under the condition of power-on, long press the startup button for 3 seconds to power off, the power indicator light goes out and the display is closed.
- The function of menu parameter confirmation

3.2 Left and Right Buttons

You can switch over various function menus through the left and right buttons.

3.3 Up and Down Buttons

In the current menu, you can select the corresponding menu item through the up and down buttons.

3.4 Data Transmitting-receiving Indicator Light

While transmitting data, the red RX/TX indicator light illuminates; while receiving data, the green RX/TX indicator light illuminates.

3.5 3G/4G and Bluetooth Operating Condition

Include various operating conditions of the 3G/4G module and Bluetooth module shown as below, if any module is abnormal, this condition can be convenient for users to locating the problem:

- If 3G/4G enters the condition of network data transmission successfully, the green indicator light illuminates constantly;
- If 3G/4G does not detect SIM card, the green indicator light flickers once in one second;
- If 3G/4G does not access network successfully, the green indicator light flickers twice in one second;
- If 3G/4G does not connect to the Base station or server successfully, the green indicator light flickers three times in one second;

- If Bluetooth matches successfully, the red BT illuminates and the Bluetooth icon appears in the condition, if the offline icon disappears, the BT indicator light goes out.

3.6 Instruction of Radio Startup and Power Indicator Light Conditions

Normal radio startup & shutdown has memory function, abnormal radio startup & shutdown has memoryless function, with specific functions as follows:

- In the case of abnormal shutdown for the last time, power on again after outage, the radio powers on automatically;
- In the case of normal shutdown for the last time, only by short pressing for about 1 second can the radio power on after powering;
- If the voltage is lower than the **under-voltage threshold value** (11.8V by default, depending on the user's actual setting value), the red power indicator light flickers twice in one second;
- If the voltage is lower than the **forbidden threshold value** (11.5V by default, depending on the user's actual setting value), the red power indicator light flickers once in one second;
- If the voltage is higher than the **under-voltage threshold value** (11.8V by default, depending on the user's actual setting value), the green power indicator light illuminates constantly;
- When the voltage alarm appears, if it is under-voltage alarm, you need add 0.3V based on the under-voltage threshold value to resume to the normal voltage operating condition (the green power indicator light illuminates constantly);

Notes:

- ① Abnormal shutdown means you do not power off by long pressing the power button, for example, directly disconnecting power;
- ② Normal shutdown refers to power-off by long pressing the power button;

3.7 Device Menu

It is categorized into two types of menus altogether: Basic radio parameter menu and other features/functions menu.

3.7.1 Device Information

In the information column, the current channel number, current transmitting frequency, current receiving frequency, current protocol, current transmitting power, battery condition, device model, firmware version, hardware version and serial number are displayed.



3.7.2 Transmitting/Receiving Channel and Frequency

In this menu column, you can set up the current transmitting/receiving frequency, select required communication frequency through up and down buttons, and press the OK key to select this frequency as the current communication frequency point, the character of "*" will appear after selection.

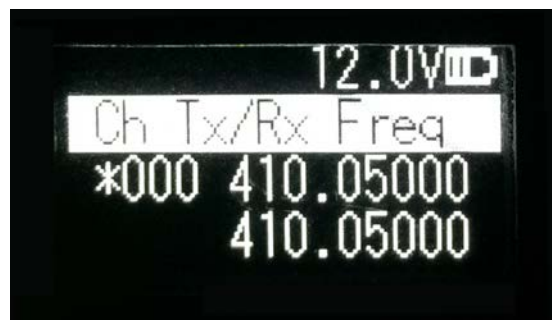

3.7.3 Data Protocol

In this menu column, you can set up the current communication protocols such as TRANSEOT, TRIMTALK and TRIMMK3. Select required communication protocol through up and down buttons, and press the OK key to select this protocol as the current communication protocol, the character of "*" will appear after selection.



Note: After changing the protocol, you need reselect the RF baud rate supported by the current protocol in the menu of “wireless link rate”;

3.7.4 RF Baud Rate

In this menu column, you can set up the current communication RF baud rate. Different protocols support different types of RF baud rates. For example, TRANSEOT supports 4800,9600, while TRIMMK3 supports 19200. Select required RF baud rate through up and down buttons, and press the OK key to select this RF baud rate as the current communication RF baud rate, the character of“*” will appear after selection.



3.7.5 Transmitting/Receiving Mode

In this menu column, you can set up the current radio transmitting/receiving mode. Now, four types of transmitting/receiving modes are supported: transmitting-receiving, single transmitting, single receiving and relaying mode. Select required transmitting/receiving mode through up and down buttons, and press the OK key to select this transmitting/receiving mode as the current communication transmitting/receiving mode, the character of“*”will appear after selection.



3.7.6 Transmitting Power

In this menu column, you can set up the current wireless transmitting power level. Now, three levels of power, high, medium and low, are supported, these three levels of power values can be customized according to the demands of users. Select required transmitting power through up and down buttons, and press the OK key to select this transmitting power as the current communication transmitting power, the character of“*” will appear after selection.



3.7.7 Serial Port Baud Rate

In this menu column, you can set up the current serial port communication baud rate. Now, there are the following baud rates: 9600, 19200, 38400, 57600, 115200. Select required serial port communication baud rate through up and down buttons, and press the OK key to select this serial port communication baud rate as the serial port communication baud rate of the current communication, the character of "*" will appear after selection.

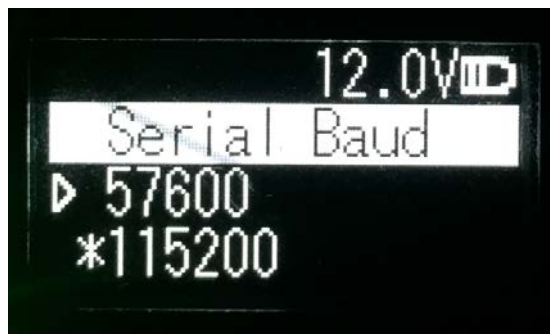

3.7.8 Serial Port Baud Rate Self-adaption

In this menu column, there are two options: self-adaptive master switch and triggering enabling. The former has memory function, if turning on the switch, ON is displayed on the menu; if off, then OFF is displayed; self-adaptive triggering enabling does not have memory function, the system remains in the startup condition after power-on; only if the self-adaptive master switch has been turned on can the adaptive function of serial port baud rate work normally.

If the serial port baud rate is successfully self-adaptive, a message box pops up indicating successful self-adaptive matching, meanwhile, self-adaptive triggering enabling stops automatically. If the serial port baud rate is not successfully self-adaptive, this function is always operating.



3.7.9 OLED Sleep Mode

Set up whether the OLED display enters sleep, only if the “Function” switch is in the “On” mode can the OLED display enter the sleep mode, sleep time has the following levels: 1min, 5min, 10min, 15min, 20min, 25min, 30min.



 **Note:**

After the OLED display enters sleep, you can awaken it through button and pop-up window message.

3.7.10 Interference Detection

Detect whether there is any interference in the current channel. You can modify the detection channel number manually and press the OK key for detection, there are three levels of detection result: superior, moderate, poor.

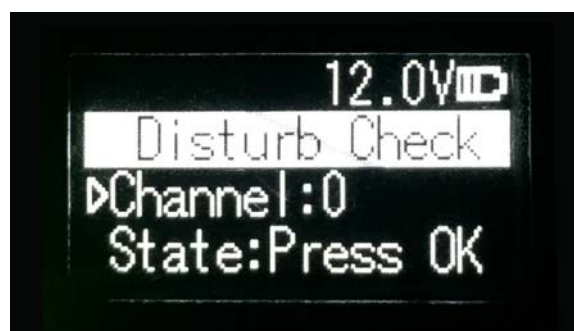

3.7.11 Language

Set up the display language of device fonts, Chinese and English are supported for this terminal.



3.8 Use of Radio Configuration Software

Multiple forms of configuring radio parameters are supported. Users can change and query the current radio parameters by the means of background mode, user interface mode and PC configuration tool. The use methods of the PC configuration tool are introduced as below.

The procedures of radio parameters include:

- Communication link establishment
- Configuration tool installation
- Radio parameter query
- Radio parameter configuration

3.8.1 Configuration Environment

Firstly, build up the radio parameter configuration environment, devices needed include: Power supply (12V), power cable (integration of power cable and data cable), radio, PC. And then, assemble related components according to [Figure 3](#)

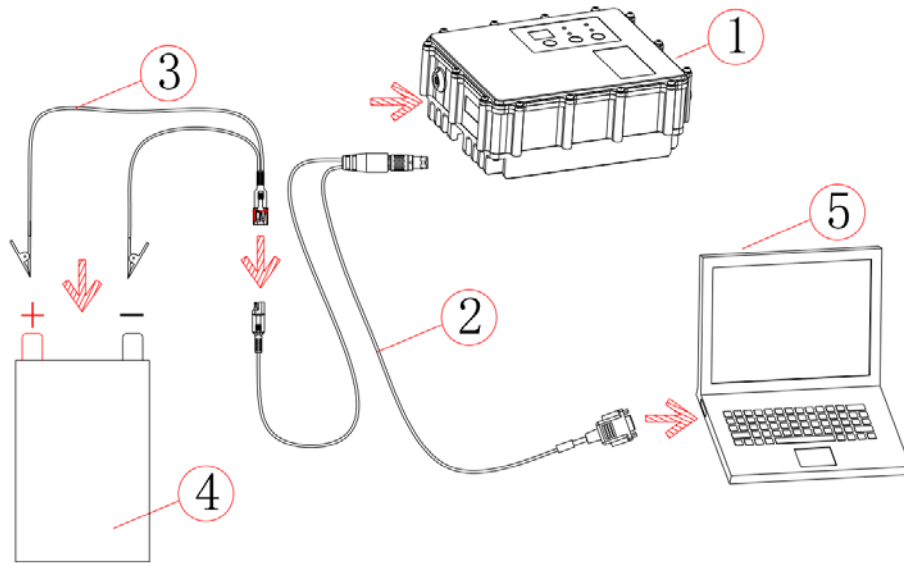

Figure 3 Installation Instruction

3.8.2 Configuration Tool Installation

Open the configuration tool installation file and click “Next” until installation is completed. In the end, one shortcut appears on the desktop. During the radio configuration later, you can directly open this shortcut to operate the radio, as shown in [Figure 4](#).

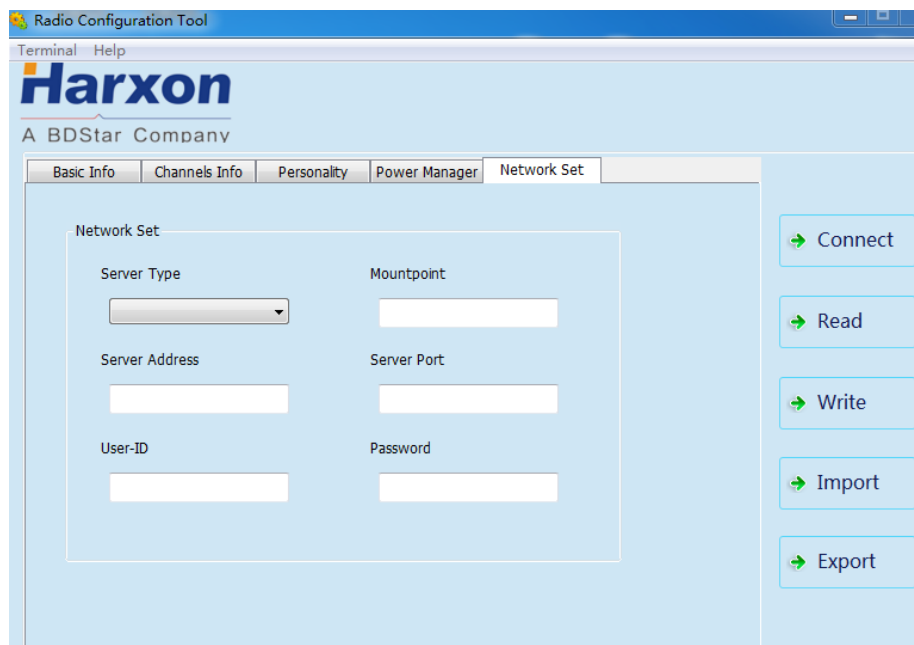

Figure 4 Radio Query/Configuration Software Interface

Note:

During the use of the configuration tool for radio parameter configuration and query, radio is not allowed to enter the background parameter configuration mode.

3.8.3 Radio Parameter Query

Firstly, click “Read”, and select the right serial port number and the current operating radio serial port baud rate in the dialog box popped up, click “Connect” and “Read” in the end, now you can begin to read the radio configuration parameters.

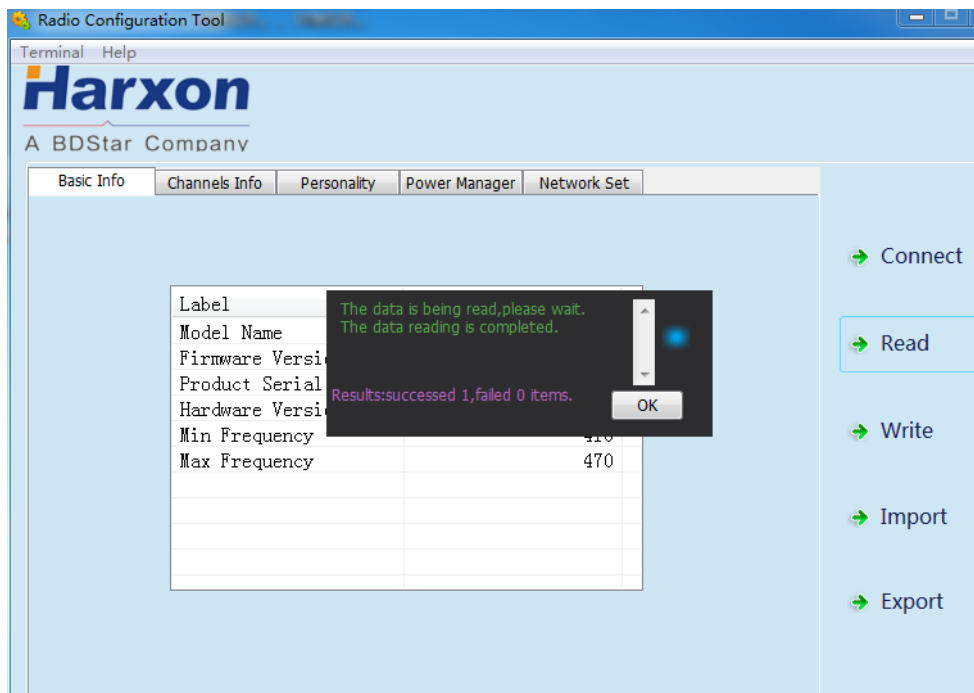
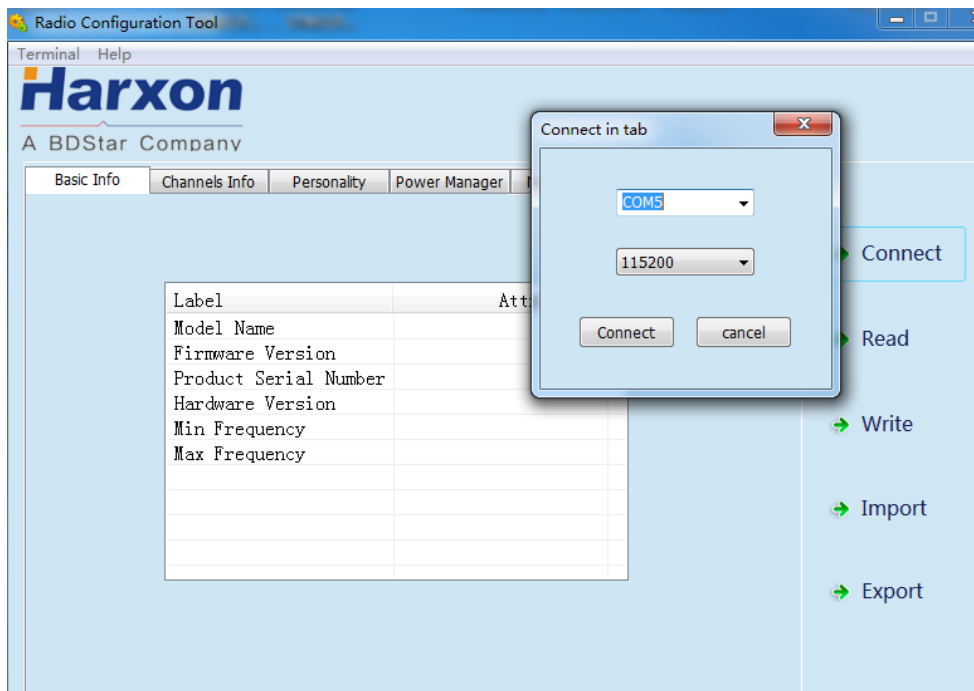

Radio Configuration Tool

Terminal Help

Harxon

A BDStar Company

Basic Info Channels Info Personality Power Manager Network Set

Channels	TX(MHZ)	RX(MHZ)	BandWidth	-	+
<input checked="" type="radio"/> 000	410.05000	410.05000	25.0K	-	+
<input type="radio"/> 001	411.05000	411.05000	25.0K	-	+
<input type="radio"/> 002	412.05000	412.05000	25.0K	-	+
<input type="radio"/> 003	413.05000	413.05000	25.0K	-	+
<input type="radio"/> 004	414.05000	414.05000	25.0K	-	+
<input type="radio"/> 005	415.05000	415.05000	25.0K	-	+
<input type="radio"/> 006	416.05000	416.05000	25.0K	-	+
<input type="radio"/> 007	417.05000	417.05000	25.0K	-	+
<input type="radio"/> 008	418.05000	418.05000	25.0K	-	+
<input type="radio"/> 009	419.05000	419.05000	25.0K	-	+
<input type="radio"/> 010	410.05000	410.05000	25.0K	-	+
<input type="radio"/> 011	453.55000	453.55000	25.0K	-	+
<input type="radio"/> 012	455.55000	455.55000	25.0K	-	+
<input type="radio"/> 013	457.55000	457.55000	25.0K	-	+
<input type="radio"/> 014	459.55000	459.55000	25.0K	-	+
<input type="radio"/> 015	461.55000	461.55000	25.0K	-	+

→ Connect

→ Read

→ Write

→ Import

→ Export

Radio Configuration Tool

Terminal Help

Harxon

A BDStar Company

Basic Info Channels Info Personality Power Manager Network Set

Personality

Protocol Type: TRIMTALK

Link Rate: 9600

Uart Rate: 115200

TX Power Level: Low

Radio Mode: Transceiver

→ Connect

→ Read

→ Write

→ Import

→ Export

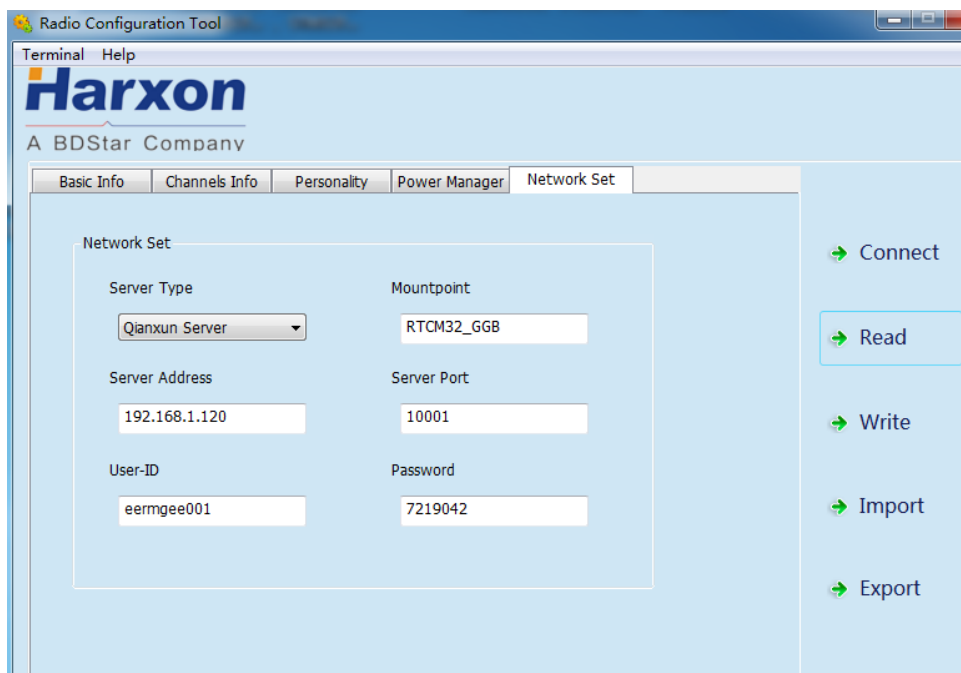

3.8.4 Radio Parameter Configuration

- In the basic information column, only radio information can be queried, settings are not supported;
- In the channel information column, the frequency point range set up is between 410~470MHz, signs '-' and '+' can be used to increase and delete or reduce.

- In the personalization setting column, users can set up communication protocol, RF baud rate, serial port baud rate, transmitting power level and transmitting/receiving mode;
- In the power management column, users can set up the low-voltage alarm threshold value for radio operation and wireless data transmission voltage;
- In the network setting column, users can select the corresponding server type and set up related information such as IP address, port number and mounting point;

 **Note:**

If the radio does not support GPRS, the settings of related parameters in the network setting column are invalid; if the operating voltage of the radio is lower than the low-voltage alarm threshold value, the red power indicator light flickers twice in one second; if the operating voltage of the radio is lower than wireless data transmission voltage, the radio stops transmitting user data; when setting up, the low-voltage alarm threshold value must be larger than wireless data transmission voltage.

3.9 Firmware Upgrade

If the radio runs under the normal operating mode (data transmission mode), online upgrade for serial port is supported, with the firmware upgrade procedures as follows:

1. Firstly, use the designated power cable to connect to the big radio, with the power supply of 9-16V; use the serial port cable (USB to RS232 serial port cable) to connect to the power cable terminal RS232 male connector, power on for powering the radio, if the radio has not been powered on, long press the power button for 3 seconds before power-on, until the system enters into the normal operating mode

 **Note:**

"RS232" is 232 level, not TTL level. Use USB to serial port cable or RS232 serial port cable and PC to establish connection.

2. Find the upgrade tool  eRadio Update Tool.exe and open the software.

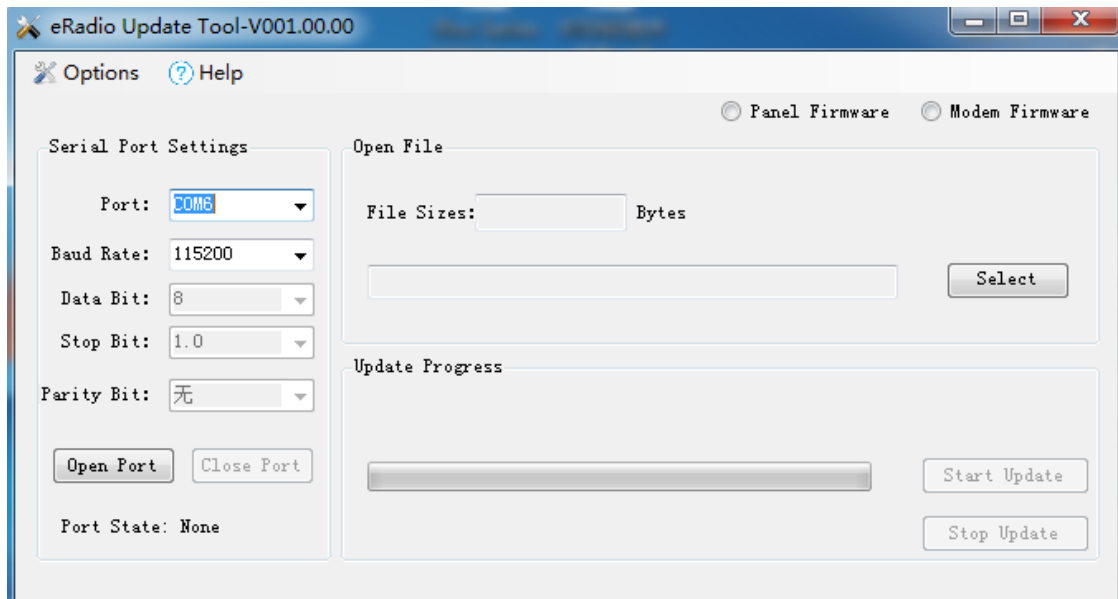

3. Select right serial port number and baud rate, open the serial port and select internally installed radio, as shown in [Figure 5](#).

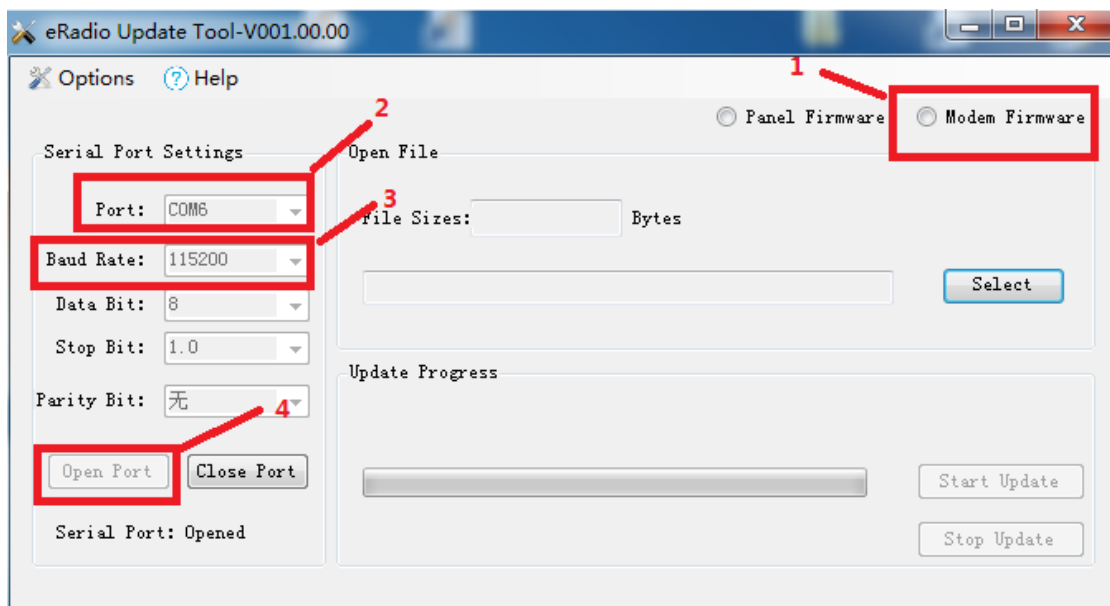
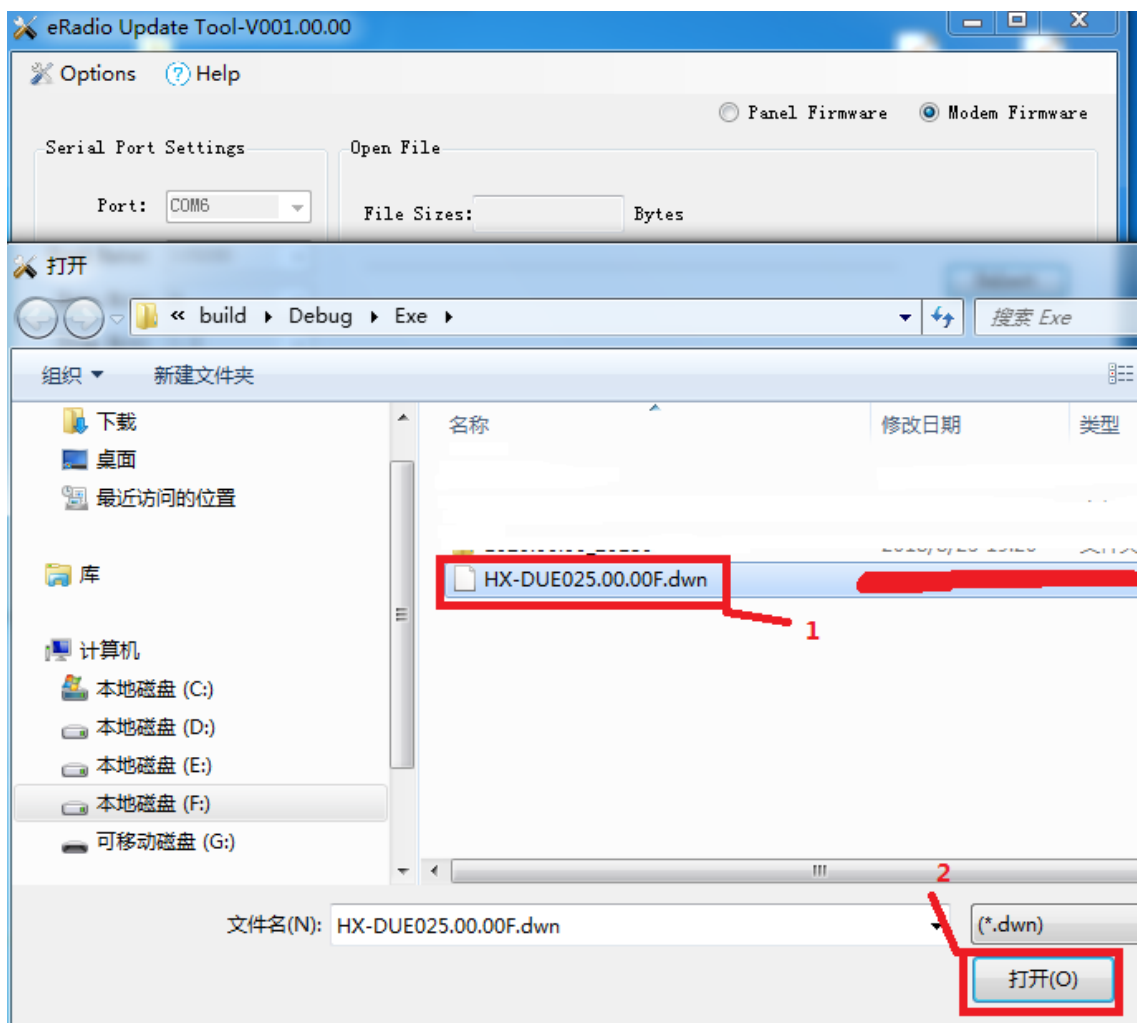
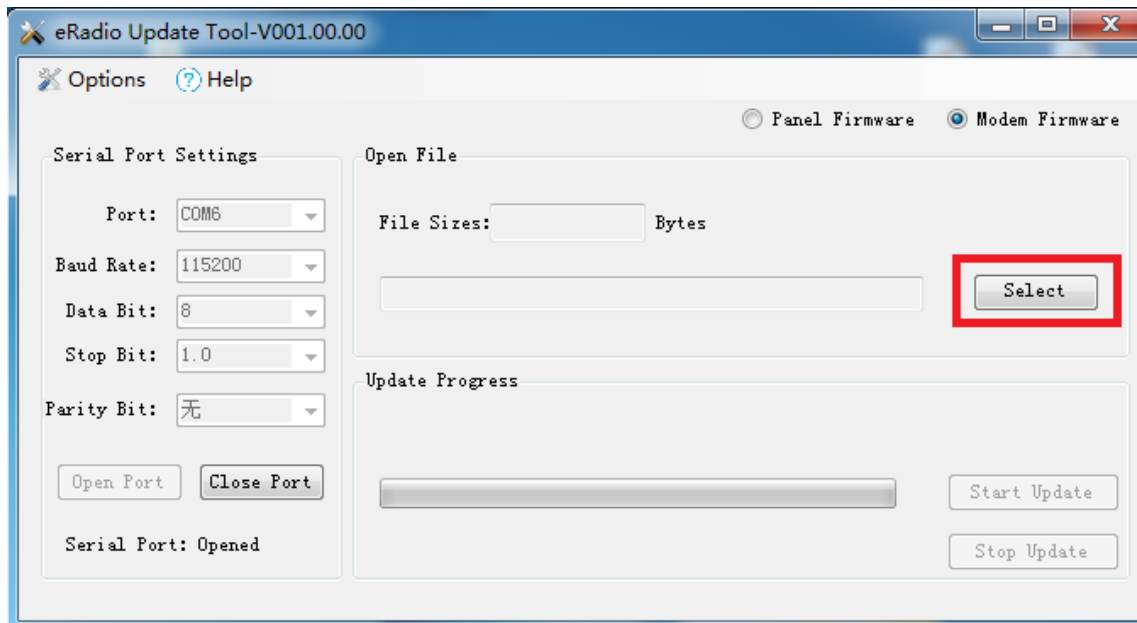
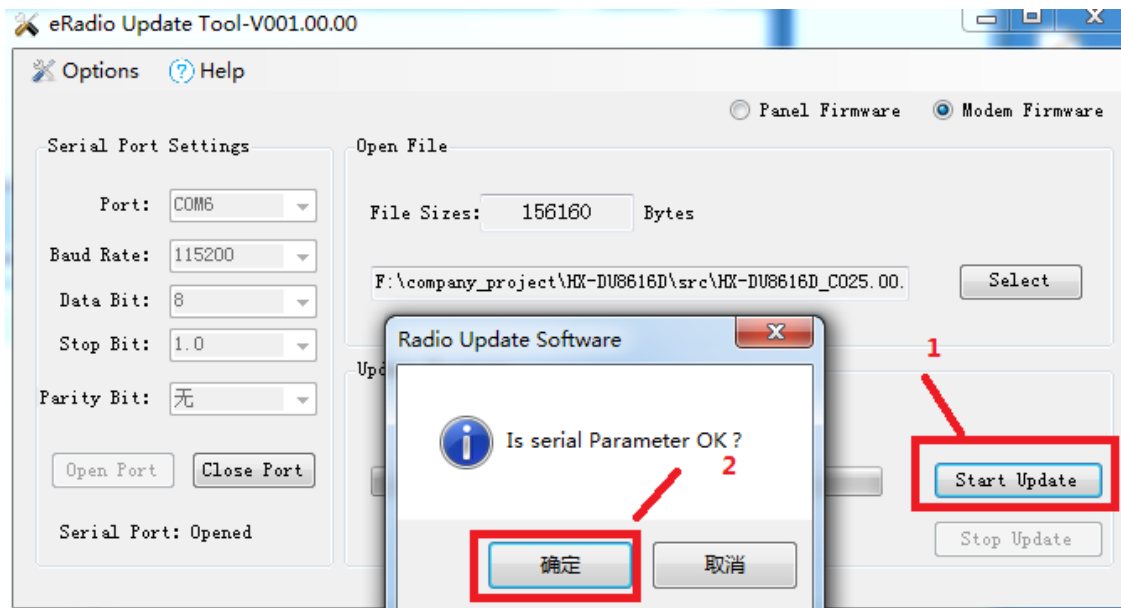

Figure 5 Internally Installed Radio Firmware Upgrade Software Connection

4. Select the file requiring upgrade (e.g.***.***F.dwn)



5. Click the “Begin to Update” button (when you click the “Begin to Update” button, one prompt dialog box pops up indicating whether a parameter is correct, now users are required to click OK; after that, the system enters into the upgrade condition immediately)



6. After upgrade, the prompt pops up indicating successful upgrade, click OK for completion of upgrade this time;

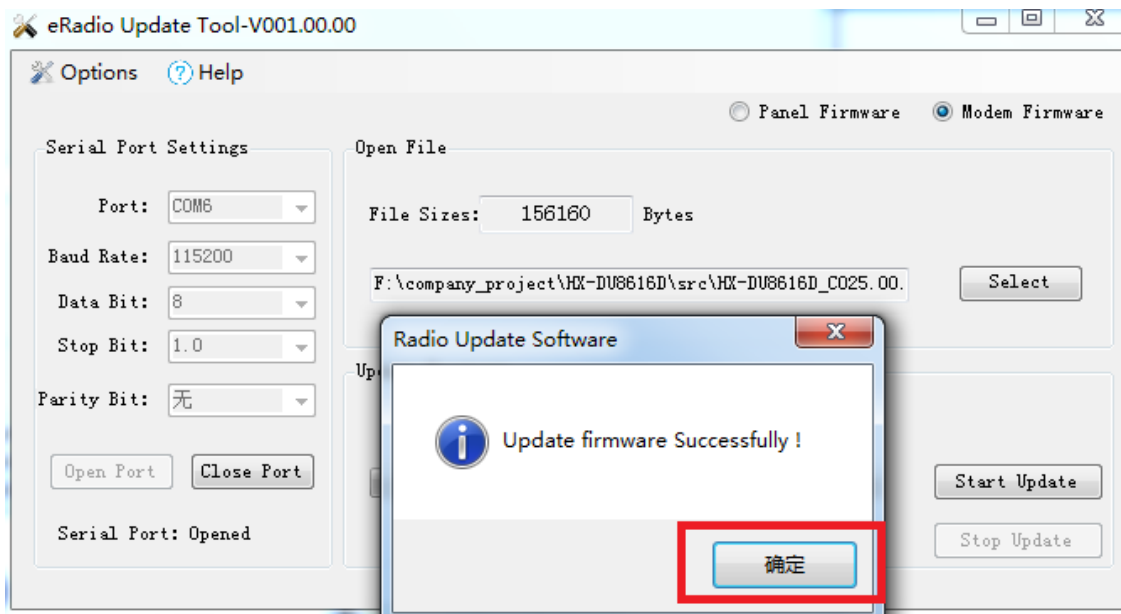

7. The system powers off before powering on again, if the radio has not been powered on, short press the power button for 1 second before power-on;

Appendix A Technical Indexes

A.1 Specifications and Parameters of Data Transmission Radio

Table 4 Specifications and Parameters of Radio4

Overall Performance Specification		
Specification Name	Specification Requirement	
Frequency Range	410~470MHz	
Operating Mode	Transmitting-receiving, single transmitting, single receiving, radio relaying and network relaying	
Channel Interval	12.5KHz	
Modulation Mode	GMSK, 4FSK	
Number of Channels	200 editable channels supported	
Operating Voltage	9-16V	
Power Consumption (Typical Value)	High transmitting power (35W)	12V DC
	Medium transmitting power (22W)	
	Low transmitting power (5W)	
	Standby	
Frequency Stability	<±1ppm	
Level of Three Proofings	IP67	
Dimension	175(L)X130(W)X86.5(H)mm	
Weight	About 2.0KG	
Operating Temperature	-40~+65°C	
Storage Temperature	-50~+85°C	
Antenna Interface	TNC, female connector	
Antenna Interface Impedance	50ohm	
Data Interface	LEMO 5pin	
Transmitter Performance Specification		
Specification Name	Specification Requirement	
RF Output Power	High transmitting power (35W)	45.5±0.5dBm@DC 12V
	Medium transmitting power (22W)	43.5±0.5dBm@DC 12V
	Low transmitting power (5W)	37±1dBm@DC 12V
RF Power Stability	±1dB	
Adjacent Channel Power	>50dB	

Receiver Performance Specification	
Specification Name	Specification Requirement
Sensitivity	Superior than -115dBm@BER10 ⁻³ , 9600bps
Adjacent Channel Selectivity	>45dB@25KHz
Stray Disturbance Resistance	>45dB
Modem	
Specification Name	Specification Requirement
RF Rate	4800bps/9600bps/19200bps
Modulation Mode	GMSK, 4FSK

A.2 Bluetooth Parameters

Table 5 5Specifications and Parameters of Bluetooth Module

Parameter List	Value	Remarks
Version	5.0	Dual-mode Bluetooth
Default Username	Serial Number ^①	
Default Password	1234	
Transmission Distance	30m	Open environment
Operating Temperature	-40°C to +70°C	

A.3 Network Parameters

Table 6 Specifications and Parameters of Network Module6^②

Parameter List	Value	Remarks
3G frequency band	B2, B5	
4G frequency band	B2, B4, B5, B12, B13	

Note:

- ① The username should not be longer than 12 characters in length, the serial number here is different with the internal serial number of machine.
- ② Because communication network involves with multiple frequency bands, all frequency bands should not be covered for the same product, if the current parameters cannot meet your requirements, Please [contact us](#) for more help.

A.4 eRadio Suite Parts

A.4.1 Radio Configuration Cable (HJ394) (Optional)

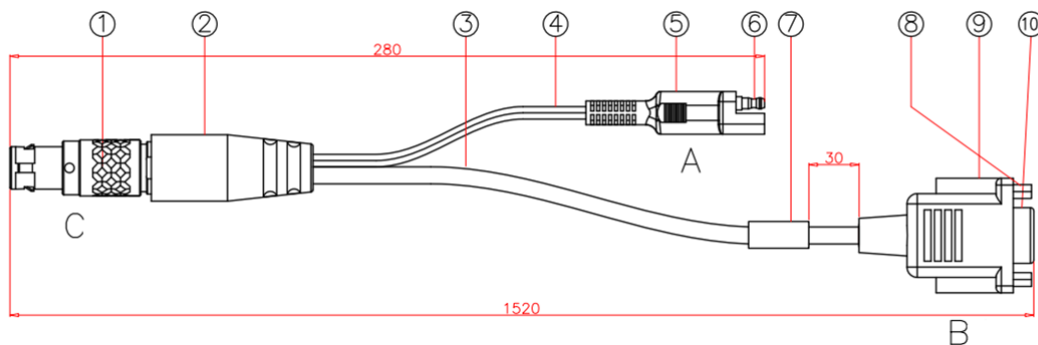

Figure 6 Structure and Dimension of External Data Transmission Radio Configuration Cable HJ394

Table 77 List of Radio Configuration Cable HJ394 Parts

Mark	Explanation	Remarks
1	Plug	1BHTN05P
2	Rubber Coating	Black
3	Cable	Black
4	Cable	Black
5	Rubber Coating	Black
6	Bullet Terminal	1 male connector and 1 female connector respectively
7	Label	MI-RD-HJ394 as the content
8	Screw with Internal Thread	
9	Rubber Coating	Black
10	Plug	DB9 female connector



Figure 7 HJ394 C Port Welding Surface View

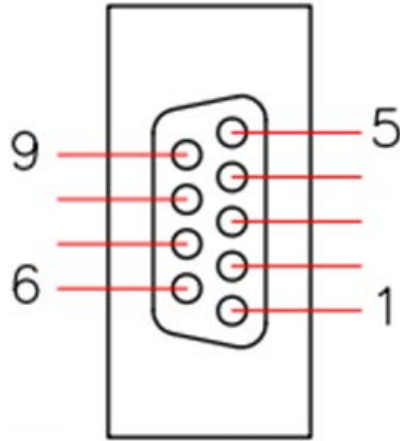

Figure 8 HJ394 B Port Welding Surface View

Table 88 Definition of HJ394 Data Cable B Port^①

Pin	Name	Description	Remarks
2	TXD	Output	
3	RXD	Input	
5	GND	GND	
1,4,6,7,8,9	RSV	Reserved	

Note:

① After connecting to the DB9 port on PC, this port can communicate normally.

A.4.2 Power Cable (HJ379)

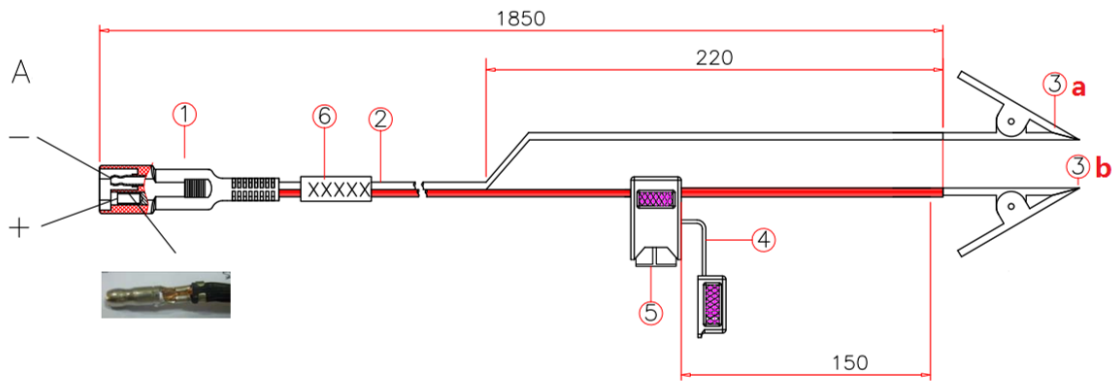

Figure 9 Structure and Dimension of Power Cable HJ379

Table 9 List of Power Cable9 HJ379 Parts

Mark	Explanation	Remarks
1	Bullet Terminal	1 male connector and 1 female connector respectively
2	Double-row cable	Black
3	a: Black alligator clip, b: Red alligator clip	
4	Fuse Support	1 male connector and 1 female connector respectively
5	Fuse	32V/15A
6	Label	MI-RD-HJ379 as the content

Appendix B Command

eRadio includes the following operating modes:

- Normal operating mode
- Background configuration mode
- Configuration tool configuration mode
- Upgrade firmware mode

1. Normal operating mode

Under the normal operating mode, the radio can carry out data transmission;

2. Background configuration mode

Firstly, the radio must run under the normal operating mode, and then send the command of entering into the background configuration mode (0x21 0x57 0x84 0x43 0x6c 0xa7 0x4e 0x5f) to enter into the configuration mode, send the command of exiting from the configuration mode (ATA\r\n) to exit from the configuration mode, return to the normal operating mode;

3. Configuration tool configuration mode

Firstly, the radio must run under the normal operating mode, and then configure and read the radio parameters with the matched upper computer configuration tool;

4. Firstly, the radio must run under the normal operating mode, and then upgrade the radio firmware with the matched upgrade software;

Under the background configuration mode, configure and query the command format of radio parameters; except the command of entering into configuration that does not end with“\r\n”, other commands must end with“\r\n”, the format of eRadio command is shown in Table 22:

Table 1010 eRadio Background Configuration Mode Command Format

1. Configure radio parameter format			
Command	Space Character (0x20)	Parameter	Ending Character
2. Response format			
Ending Character	PROGRAMMED OK	Ending Character	>
3. Query radio parameter format			
Command	Ending Character		

4. Response format

Ending Character	Command	Space Character	Query Result	Ending Character	>
------------------	---------	-----------------	--------------	------------------	---

For example, configure the current radio transmitting frequency point as 460.125MHz:

The format is shown as below: TX 460.0125\r\n; response format: \r\nPROGRAMMED OK \r\n>

Query the current radio transmitting frequency point:

The format is shown as below: TX\r\n; response format: \r\nTX 460.01250 MHz\r\n>

Table 1111 List of eRadio Background Configuration Mode Commands

Command Name	Command Format	Response Format	Explanation
Enter into the configuration mode	21 57 84 43 6c a7 4e 5f	\r\n into config\r\n	Indicate the radio has entered into the configuration mode, the command of entering is hexadecimal
Exit from the configuration mode	ATA\r\n	\r\n exit config\r\n	Exit from the configuration mode and enter into the normal operating mode
Query the current receiving frequency point	rx\r\n	\r\n RX receiving frequency point MHz\r\n> e.g.: \r\n\r\n RX 456.05000 MHz\r\n> Indicate the current receiving frequency point is 456.05MHz;	① One space character is between “RX” and “receiving frequency point” for separation; ② “receiving frequency point” has 9 characters in length; ③ One space character is between “receiving frequency point” and “MHz” for separation;
Set up the current receiving frequency point	rx receiving frequency point\r\n e.g.: rx 456.05\r\n Indicate setting up the current receiving frequency point as 456.05MHz;	\r\nPROGRAMMED OK\r\n> Indicate the current receiving frequency point is written successfully	① One space character is between the strings PROGRAMMED and OK for separation; ② Settable range of receiving frequency point is: 410 ≦ RX ≦ 470
Query the current transmitting frequency point	tx\r\n	\r\n TX transmitting frequency point MHz\r\n> e.g.: \r\n\r\n TX 456.05000 MHz\r\n> Indicate the current transmitting frequency	① One space character is between “TX” and “transmitting frequency point” for separation; ② “transmitting frequency point” has 9 characters in length; ③ One space character is between

Command Name	Command Format	Response Format	Explanation
		point is 456.05MHz;	“transmitting frequency point” and “MHz” for separation;
Set up the current transmitting frequency point	tx transmitting frequency point \r\n e.g.: tx 456.05\r\n Indicate setting up the current transmitting frequency point as 456.05MHz;	\r\nPROGRAMMED OK\r\n> Indicate the current transmitting frequency point is written successfully	① One space character is between the strings PROGRAMMED and OK for separation; ② Settable range of transmitting frequency point is: 410 ≦ TX ≦ 470
Current protocol query	prt\r\n	\r\n PRT protocol type\r\n> e.g.: \r\nPRT TRIMTALK\r\n> Indicate the current radio protocol is TRIMTALK	① While querying protocol, return the name of the current radio work protocol; ② Note: One space character is between the strings “PRT” and “protocol type” for separation; “protocol type” has 8 characters in length, if the name of the current protocol type has less than 8 characters in length, use space characters to fill; for example, for protocol SOUTH, there are 5 characters, 3 space characters are additionally needed;
Current protocol setting	prt protocol type\r\n e.g.: prt TRIMTALK \r\n Indicate setting up the current radio work protocol as TRIMTALK	\r\nPROGRAMMED OK\r\n> Indicate the current radio protocol is written successfully	Names of common protocols: TRANSEOT (equivalent to transparent), TT450S, TRIMTALK;
RF baud rate query	baud\r\n	\r\nBAUD RF baud rate\r\n> e.g.: \r\nBAUD 9600 \r\n> Indicate the current radio RF baud rate is 9600	① One space character is between “BAUD” and “RF baud rate” for separation;② “RF baud rate” has 6 characters in length, if the current RF baud rate has less than 6 characters in length, use space characters to fill; for example, for RF baud rate of 9600, there are only 4 characters, 2 space characters are additionally needed;

Command Name	Command Format	Response Format	Explanation
RF baud rate setting	baud protocol type\r\n e.g.: baud 9600\r\n Indicate setting up the current radio RF baud rate as 9600	\r\nPROGRAMMED OK\r\n> Indicate the current radio RF baud rate is written successfully	
Operating mode query	mode\r\n	\r\nMODE operating mode\r\n> e.g.: \r\nMODE DUPLEX\r\n> Indicate the current radio operating mode is transmitting-receiving	① One space character is between “MODE” and “operating mode” for separation; ② “operating mode” has 8 characters in length, if the operating mode currently displayed has less than 8 characters in length, use space characters to fill; for example, for operating mode of duplex, there are only 6 characters, 2 space characters are additionally needed;
Operating mode setting	Mode operating mode\r\n e.g.: mode duplex\r\n Indicate setting up the current radio operating mode as transmitting-receiving	\r\nPROGRAMMED OK\r\n> Indicate the current radio operating mode is written successfully	The operating modes supported are: DUPLEX (transmitting-receiving), TXONLY (single transmitting), RXONLY (single receiving), RPT (radio relaying mode), NETRPT (network relaying mode)
Transmitting power query	pwr\r\n	\r\nPWR power level\r\n> e.g.: \r\nPWR L\r\n> Indicate the current radio transmitting power is 5W	The corresponding relations among power levels: H-28W;M-22W;L3-5W; ① One space character is between “PWR” and “power level” for separation; ② “power level” has 1 characters in length
Transmitting power setting	pwr power level\r\n e.g.: pwr L\r\n Indicate setting up the current radio transmitting power as 5W	\r\nPROGRAMMED OK\r\n> Indicate the current radio transmitting power is written successfully	
Serial port baud rate query	sbaud\r\n	\r\nSBAUD serial port baud rate\r\n> e.g.: \r\nSBAUD 115200\r\n> Indicate the current radio serial port baud	The list of serial port baud rates supported is shown as below: 9600, 19200,38400,57600,115200; ① One space character is

Command Name	Command Format	Response Format	Explanation
		rate is 115200	between “SBAUD” and “serial port baud rate” for separation; ② “serial port baud rate” has 6 characters in length, if the serial port baud rate currently displayed has less than 6 characters in length, use space characters to fill; for example, for serial port baud rate of 9600, there are only 4 characters, 2 space characters are additionally needed;
Serial port baud rate setting	sbaud serial port baud rate\r\n e.g.: sbaud 115200\r\n Indicate setting up the current radio serial port baud rate as 115200	\r\nPROGRAMMED OK\r\n> Indicate the current radio serial port baud rate is written successfully	
Current work channel query	channel\r\n e.g.: channel 000\r\n Indicate the current work is done at Channel 0	\r\n channel channel number\r\n> e.g.: \r\n channel 000\r\n> Indicate the current work is done at Channel 0	The channel number has 3 characters in length
Current work channel setting	channel channel number\r\n e.g.: channel 0\r\n Indicate setting up current work at Channel 0	\r\nPROGRAMMED OK\r\n> Indicate the current channel number is written successfully	The channel number must be less than the number of maximum supported channels
Software version query	srev\r\n	\r\n software version\r\n e.g.: \r\n E025.00.00\r\n > Indicate the current radio software version: E025.00.00	“software version”; has 12 characters in length, fill with space characters for lacking of characters;

Appendix C eRadio SIM Setup



Appendix D eRadio FAQ

Failure Description	Cause Analysis	Solutions
Failing to power on	<ul style="list-style-type: none"> ① Unreliable power cable connection (external power supply); ② The positive and negative poles reversed (external power supply); ③ Battery exhausted if used 	<ul style="list-style-type: none"> ① If external power supply is used, connect to the power cable correctly, with the rated working voltage of DC12V; ② Wiring based on the correct positive and negative poles; ③ For battery power, charge in time; while powering on, long press the power button for 1 second or so
The configuration tool cannot read or set up parameters	<ul style="list-style-type: none"> ① Incorrect serial port parameter configuration; ② The existing serial port for communication occupied 	<ul style="list-style-type: none"> ① Select the serial port number, serial port baud rate, 8 data bits, 1 stop bit, no odd-even check, no data flow control correctly; ② Replace the existing serial port number
Failing to sending data	<ul style="list-style-type: none"> ① Inconsistent communication parameter configuration of the receiving/transmitting terminal; ② No external antenna for radio; ③ The battery voltage in the threshold value of forbidden voltage 	<ul style="list-style-type: none"> ① Make communication parameter configuration of the receiving/transmitting terminal consistent (receiving/transmitting frequency point, communication protocol, RF baud rate, operating mode); ② If the radio has no external antenna, select appropriate antenna according to the frequency band range; ③ Replace the battery
The red power indicator light flickers twice in one second	The current power voltage less than the threshold value of low-voltage alarm	Replace the battery
The red power indicator light flickers once in one second	The current power voltage less than the forbidden threshold value	Replace the battery
The red GPRS indicator light flickers twice in one second	<ul style="list-style-type: none"> ① Failing to insert the SIM card or insert it well; ② GPRS module abnormality 	<ul style="list-style-type: none"> ① Install the SIM card correctly; ② Report for repair

FCC Compliance Statement

This device complies with Part 15 of the FCC Rules. Operation is subject to the following two conditions: (1) this device may not cause harmful interference, and (2) this device must accept any interference received, including interference that may cause undesired operation.

Notes: This equipment has been tested and found to comply with the limits for a Class B digital device, pursuant to Part 15 of the FCC Rules. These limits are designed to provide reasonable protection against harmful interference in a residential installation. This equipment generates, uses and can radiate radio frequency energy and, if not installed and used in accordance with the instructions, may cause harmful interference to radio communications. However, there is no guarantee that interference will not occur in a particular installation.

If this equipment does cause harmful interference to radio or television reception, which can be determined by turning the equipment off and on, the user is encouraged to try to correct the interference by one or more of the following measures:

- Reorient or relocate the receiving antenna.
- Increase the separation between the equipment and receiver.
- Connect the equipment into an outlet on a circuit different from that to which the receiver is connected.
- Consult the dealer or an experienced radio/TV technician for help.

Cautions: changes or modifications not expressly approved by the party responsible for compliance could void the user's authority to operate the equipment.

This equipment complies with FCC radiation exposure limits set forth for an uncontrolled environment. This transmitter must not be co-located or operating in conjunction with any other antenna or transmitter. This equipment should be installed and operated with minimum distance 210cm between the radiator and your body.



HARXON CORPORATION

Add: 9/F, Block B, D3 Building, TCL InternationalE City, No.1001 Zhongshanyuan Road, NanshanDistrict, Shenzhen, 518055, PRC

Tel: +86 -755-26989948 Fax: +86 -755-26989994

E-mail: sales@harxon.com Web: www.harxon.com



Advanced Technology to Empower Your Applications