

FCC Test Report

| | |
|--------------|------------|
| Product Name | FLIC HUB |
| Model No. | FLIC HUB |
| FCC ID. | 2ACR9-FLHB |

| | |
|-----------|--|
| Applicant | Shortcut Labs AB |
| Address | Drottning Kristinas Vag 41, 11428, Stockholm, Sweden |

| | |
|-----------------|---------------------|
| Date of Receipt | Jan. 15, 2018 |
| Issued Date | Feb. 02, 2018 |
| Report No. | 1810194R-RFUSP01V00 |
| Report Version | V1.0 |



Testing Laboratory

3023

The test results relate only to the samples tested.

The test results shown in the test report are traceable to the national/international standard through the calibration report of the equipment and evaluated measurement uncertainty herein.

This report must not be used to claim product endorsement by TAF or any agency of the government.

The test report shall not be reproduced without the written approval of DEKRA Testing and Certification Co., Ltd..

Test Report

Issued Date: Feb. 02, 2018

Report No.: 1810194R-RFUSP01V00



| | |
|---------------------|---|
| Product Name | FLIC HUB |
| Applicant | Shortcut Labs AB |
| Address | Drottning Kristinas Vag 41, 11428, Stockholm, Sweden |
| Manufacturer | DEXATEK TECHNOLOGY |
| Model No. | FLIC HUB |
| FCC ID. | 2ACR9-FLHB |
| EUT Rated Voltage | DC 5V |
| EUT Test Voltage | AC 120V/60Hz |
| Trade Name | FLIC HUB |
| Applicable Standard | FCC CFR Title 47 Part 15 Subpart C: 2016 ANSI C63.4: 2014, ANSI C63.10: 2013 KDB 558074 D01 DTS Meas Guidance v04 |
| Test Result | Complied |

Documented By :

Rita Huang

(Senior Adm. Specialist / Rita Huang)

Tested By :

Tom chiu

(Engineer / Tom Chiu)

Approved By :

Vincent Lin

(Director / Vincent Lin)

TABLE OF CONTENTS

| Description | Page |
|--|-----------|
| 1. GENERAL INFORMATION | 4 |
| 1.1. EUT Description..... | 4 |
| 1.2. Operational Description..... | 7 |
| 1.3. Tested System Details..... | 8 |
| 1.4. Configuration of Tested System | 8 |
| 1.5. EUT Exercise Software | 8 |
| 1.6. Test Facility | 9 |
| 1.7. List of Test Equipment..... | 10 |
| 2. CONDUCTED EMISSION | 10 |
| 2.1. Test Setup | 11 |
| 2.2. Limits..... | 12 |
| 2.3. Test Procedure | 12 |
| 2.4. Uncertainty | 12 |
| 2.5. Test Result of Conducted Emission..... | 13 |
| 3. PEAK POWER OUTPUT | 15 |
| 3.1. Test Setup | 15 |
| 3.2. Limit | 15 |
| 3.3. Test Procedure | 15 |
| 3.4. Uncertainty | 15 |
| 3.5. Test Result of Peak Power Output..... | 16 |
| 4. RADIATED EMISSION | 17 |
| 4.1. Test Setup | 17 |
| 4.2. Limits..... | 19 |
| 4.3. Test Procedure | 20 |
| 4.4. Uncertainty | 20 |
| 4.5. Test Result of Radiated Emission..... | 21 |
| 5. RF ANTENNA CONDUCTED TEST | 25 |
| 5.1. Test Setup | 25 |
| 5.2. Limits..... | 25 |
| 5.3. Test Procedure | 25 |
| 5.4. Uncertainty | 25 |
| 5.5. Test Result of RF Antenna Conducted Test..... | 26 |
| 6. BAND EDGE | 27 |
| 6.1. Test Setup | 27 |
| 6.2. Limit | 28 |
| 6.3. Test Procedure | 28 |
| 6.4. Uncertainty | 28 |
| 6.5. Test Result of Band Edge | 29 |
| 7. 6DB BANDWIDTH | 33 |
| 7.1. Test Setup | 33 |
| 7.2. Limits..... | 33 |
| 7.3. Test Procedure | 33 |
| 7.4. Uncertainty | 33 |
| 7.5. Test Result of 6dB Bandwidth..... | 34 |
| 8. POWER DENSITY | 37 |
| 8.1. Test Setup | 37 |
| 8.2. Limits..... | 37 |
| 8.3. Test Procedure | 37 |
| 8.4. Uncertainty | 37 |
| 8.5. Test Result of Power Density | 38 |
| 9. EMI REDUCTION METHOD DURING COMPLIANCE TESTING | 41 |
| Attachment 1: EUT Test Photographs | |
| Attachment 2: EUT Detailed Photographs | |

1. GENERAL INFORMATION

1.1. EUT Description

| | |
|--------------------|-----------------------------------|
| Product Name | FLIC HUB |
| Trade Name | FLIC HUB |
| Model No. | FLIC HUB |
| FCC ID. | 2ACR9-FLHB |
| Frequency Range | 2402 – 2480MHz |
| Channel Number | V5.0: 40CH |
| Type of Modulation | V5.0: GFSK(1Mbps) |
| Antenna Type | Printed on PCB Antenna |
| Channel Control | Auto |
| Antenna Gain | Refer to the table “Antenna List” |
| Contain Module | Nordic / nRF52810 |

Antenna List

| No. | Manufacturer | Part No. | Antenna Type | Peak Gain |
|-----|--------------|----------|------------------------|----------------------|
| 1 | LYNwave | SA-7506 | Printed on PCB Antenna | 1.35 dBi for 2.4 GHz |

Note: The antenna of EUT is conforming to FCC 15.203.

Center Frequency of Each Channel: (For V5.0)

| | | | | | | | |
|-------------|-----------|-------------|-----------|-------------|-----------|-------------|-----------|
| Channel | Frequency | Channel | Frequency | Channel | Frequency | Channel | Frequency |
| Channel 00: | 2402 MHz | Channel 01: | 2404 MHz | Channel 02: | 2406 MHz | Channel 03: | 2408 MHz |
| Channel 04: | 2410 MHz | Channel 05: | 2412 MHz | Channel 06: | 2414 MHz | Channel 07: | 2416 MHz |
| Channel 08: | 2418 MHz | Channel 09: | 2420 MHz | Channel 10: | 2422 MHz | Channel 11: | 2424 MHz |
| Channel 12: | 2426 MHz | Channel 13: | 2428 MHz | Channel 14: | 2430 MHz | Channel 15: | 2432 MHz |
| Channel 16: | 2434 MHz | Channel 17: | 2436 MHz | Channel 18: | 2438 MHz | Channel 19: | 2440 MHz |
| Channel 20: | 2442 MHz | Channel 21: | 2444 MHz | Channel 22: | 2446 MHz | Channel 23: | 2448 MHz |
| Channel 24: | 2450 MHz | Channel 25: | 2452 MHz | Channel 26: | 2454 MHz | Channel 27: | 2456 MHz |
| Channel 28: | 2458 MHz | Channel 29: | 2460 MHz | Channel 30: | 2462 MHz | Channel 31: | 2464 MHz |
| Channel 32: | 2466 MHz | Channel 33: | 2468 MHz | Channel 34: | 2470 MHz | Channel 35: | 2472 MHz |
| Channel 36: | 2474 MHz | Channel 37: | 2476 MHz | Channel 38: | 2478 MHz | Channel 39: | 2480 MHz |

Duty Cycle:

| | |
|-----|-------|
| BLE | 63.20 |
|-----|-------|

*Duty cycle = Ton / (Ton + Toff)

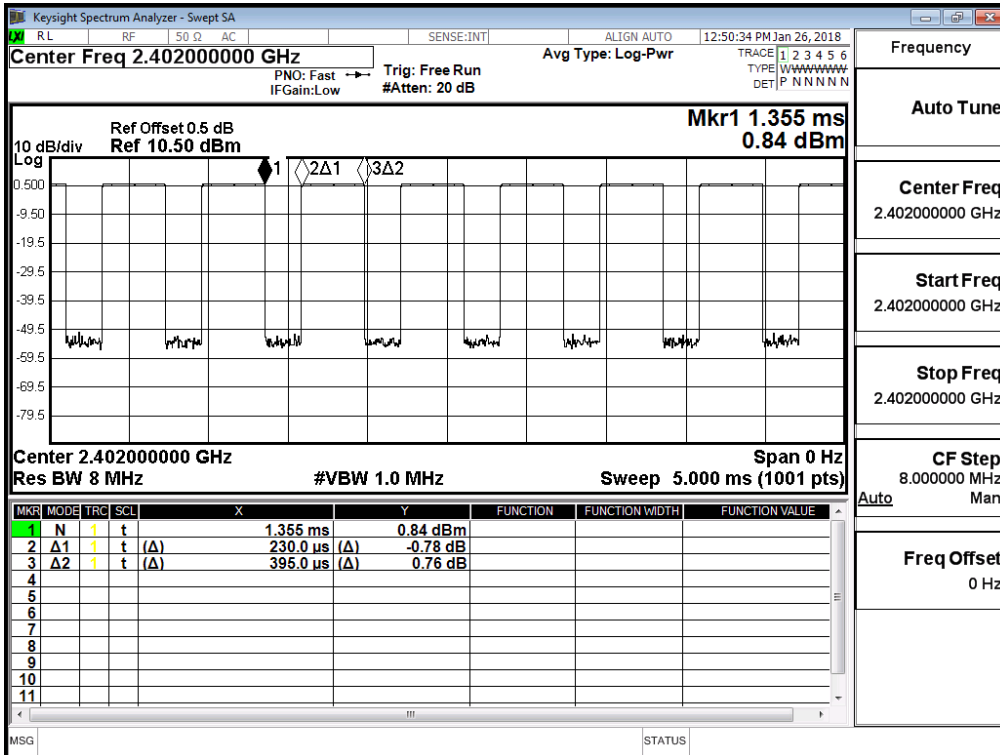

Note:

1. The EUT is a FLIC HUB with a built-in Bluetooth V5.0 transceiver, this report for Bluetooth V5.0.
2. These tests were conducted on a sample for the purpose of demonstrating compliance of Bluetooth transmitter with Part 15 Subpart C Paragraph 15.247 for spread spectrum devices.
3. Regarding to the operation frequency, the lowest, middle and highest frequency are selected to perform the test.
4. The radiation measurements are performed in X, Y, Z axis positioning. Only the worst case is shown in the report.

| | |
|-----------|-------------------------------|
| Test Mode | Mode 1: Transmit - BLE (GFSK) |
|-----------|-------------------------------|

1.3. Tested System Details

The types for all equipment, plus descriptions of all cables used in the tested system (including inserted cards) are:

| Product | Manufacturer | Model No. | Serial No. | Power Cord | |
|---------|--------------|-----------|----------------|------------|--------------------|
| 1 | Notebook PC | DELL | Latitude E5440 | 74BTK32 | Non-Shielded, 0.8m |
| 2 | Earphone | AIWA | N/A | N/A | N/A |
| 3 | IR Sensor | N/A | N/A | N/A | N/A |

| Signal Cable Type | Signal cable Description |
|-------------------|--------------------------|
| A | USB Cable |
| B | LAN Cable |
| C | Single Cable |
| D | Audio Cable |

1.4. Configuration of Tested System

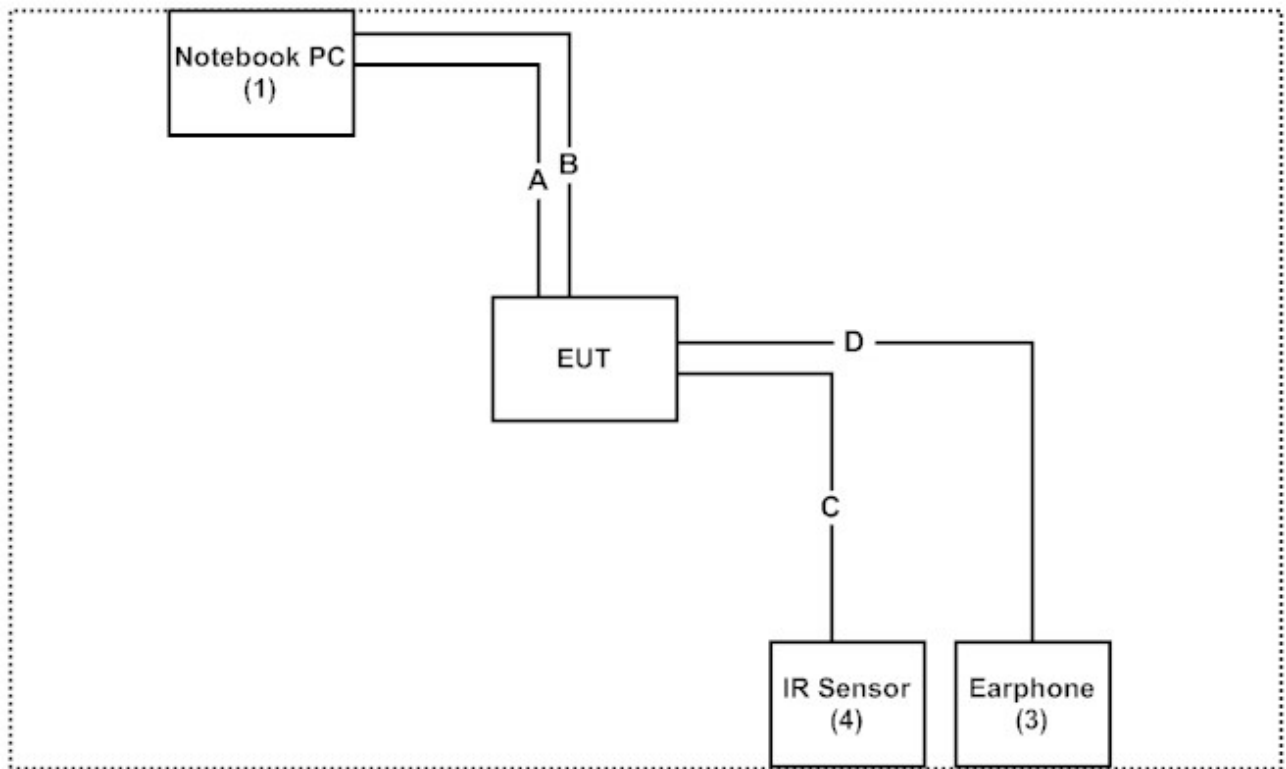

1.5. EUT Exercise Software

1. Setup the EUT as shown in Section 1.4.
2. Execute software "Putty V0.63" on the Notebook PC.
3. Configure the test mode, the test channel, and the data rate.
4. Press "OK" to start the continuous Transmit.
5. Verify that the EUT works properly.

1.6. Test Facility

Ambient conditions in the laboratory:

| Items | Required (IEC 68-1) | Actual |
|----------------------------|---------------------|----------|
| Temperature (°C) | 15-35 | 20-35 |
| Humidity (%RH) | 25-75 | 30-65 |
| Barometric pressure (mbar) | 860-1060 | 950-1000 |

The related certificate for our laboratories about the test site and management system can be downloaded from DEKRA Testing and Certification Co., Ltd. Web Site:

<http://www.dekra.com.tw/english/about/certificates.aspx?bval=5>

The address and introduction of DEKRA Testing and Certification Co., Ltd. laboratories can be founded in our Web site: http://www.dekra.com.tw/index_en.aspx

Site Description: Accredited by TAF
Accredited Number: 3023

Site Name: DEKRA Testing and Certification Co., Ltd
Site Address: No.5-22, Ruishukeng, Linkou Dist., New Taipei City 24451,
Taiwan, R.O.C.
TEL : 886-2-8601-3788 / FAX : 886-2-8601-3789
E-Mail : info.tw@dekra.com

FCC Accreditation Number: TW3023

1.7. List of Test Equipment

For Conducted measurements /CB3/SR8

| | Equipment | Manufacturer | Model No. | Serial No. | Cali. Date | Due. Date |
|---|---------------------|--------------|-----------|--------------|------------|------------|
| | Temperature Chamber | WIT GROUP | TH-1S-B | EQ-201-00146 | 2017/11/28 | 2018/11/27 |
| X | Spectrum Analyzer | Agilent | N9010A | MY48030495 | 2017/7/22 | 2018/7/21 |
| X | Power Meter | Anritsu | ML2495A | 6K00003357 | 2017/6/23 | 2018/6/22 |
| X | Pulse power sensor | Anritsu | MA2411B | 0846193 | 2017/6/23 | 2018/6/22 |
| X | EMI Test Receiver | R&S | ESCS 30 | 100369 | 2017/10/13 | 2018/10/12 |
| X | LISN | R&S | ESH3-Z5 | 836679/017 | 2018/1/18 | 2019/1/17 |
| X | LISN | R&S | ENV216 | 100097 | 2018/1/18 | 2019/1/17 |
| X | Coaxial Cable | QTK(Armist) | RG 400 | LC018-RG | 2017/6/25 | 2018/6/24 |

Note:

1. All equipments are calibrated every one year.
2. The test instruments marked with "X" are used to measure the final test results.
3. Test Software version : QuieTek Conduction Test System V8.0.113.

For Radiated measurements /Site3/CB8

| | Equipment | Manufacturer | Model No. | Serial No. | Cali. Date | Due. Date |
|---|-----------------------|--------------------|--------------|-------------|------------|-----------|
| X | Spectrum Analyzer | R&S | FSP40 | 100170 | 2018/1/18 | 2019/1/17 |
| X | Loop Antenna | Teseq | HLA6121 | 37133 | 2017/3/18 | 2018/3/17 |
| X | Bi-Log Antenna | Schaffner Chase | CBL6112B | 2707 | 2017/6/11 | 2018/6/10 |
| X | Horn Antenna | ETS-Lindgren | 3117 | 00135205 | 2017/4/6 | 2018/4/5 |
| X | Horn Antenna | Schwarzbeck | BBHA9170 | 9170430 | 2017/4/14 | 2018/4/13 |
| X | Pre-Amplifier | QTK | AP/0100A | CHM/0901069 | 2017/6/23 | 2018/6/22 |
| X | Pre-Amplifier | EMCI | EMC012630SE | 980210 | 2018/1/26 | 2018/1/24 |
| X | Pre-Amplifier | NARDA WE | DBL-1840N506 | 013 | 2017/9/30 | 2018/9/29 |
| X | Filter | MicroTRON | BRM50701 | 019 | 2017/11/2 | 2018/11/1 |
| X | Filter | Microwave Circuits | N0257881 | 36681 | 2018/1/3 | 2019/1/2 |
| X | EMI Test Receiver | R&S | ESR26 | 101385 | 2017/9/29 | 2018/9/28 |
| X | Coaxial Cable | QTK(Armist) | SUCOFLEX 106 | L1606-015C | 2017/6/23 | 2018/6/22 |
| X | EMI Test Receiver | R&S | ESCS 30 | 838251/001 | 2017/7/21 | 2018/7/20 |
| X | Coaxial Cable | QTK(Armist) | RG 214 | LC003-RG | 2017/6/16 | 2018/6/15 |
| X | Coaxial signal switch | Anritsu | MP59B | 6201415889 | 2017/6/16 | 2018/6/15 |

Note:

1. All equipments are calibrated every one year.
2. The test instruments marked with "X" are used to measure the final test results.
3. Test Software version : QuieTek EMI 2.0 V2.1.113.

2. Conducted Emission

2.1. Test Setup

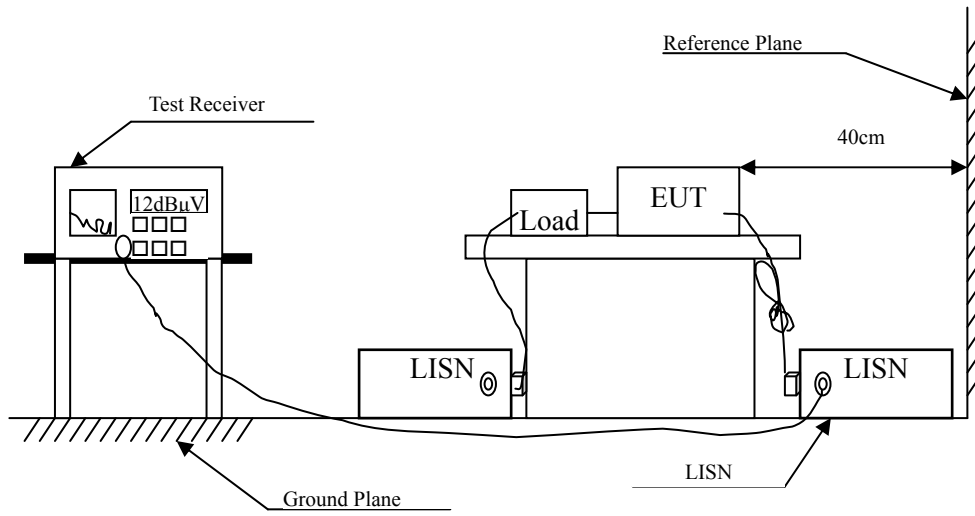

2.2. Limits

| FCC Part 15 Subpart C Paragraph 15.207 (dB μ V) Limit | | |
|---|--------|-------|
| Frequency MHz | Limits | |
| | QP | AV |
| 0.15 - 0.50 | 66-56 | 56-46 |
| 0.50-5.0 | 56 | 46 |
| 5.0 - 30 | 60 | 50 |

Remarks: In the above table, the tighter limit applies at the band edges.

2.3. Test Procedure

The EUT and Peripherals are connected to the main power through a line impedance stabilization network (L.I.S.N.). This provides a 50 ohm /50uH coupling impedance for the measuring equipment. The peripheral devices are also connected to the main power through a LISN that provides a 50ohm /50uH coupling impedance with 50ohm termination. (Please refer to the block diagram of the test setup and photographs.)

Both sides of A.C. line are checked for maximum conducted interference. In order to find the maximum emission, the relative positions of equipment and all the interface cables must be changed according to ANSI C63.4: 2014 on conducted measurement.

Conducted emissions were investigated over the frequency range from 0.15MHz to 30MHz using a receiver bandwidth of 9kHz.

The EUT was setup to ANSI C63.4, 2014; tested to DTS test procedure of FCC KDB-558074 for compliance to FCC 47CFR Subpart C requirements.

2.4. Uncertainty

± 2.26 dB

2.5. Test Result of Conducted Emission

Product : FLIC HUB
 Test Item : Conducted Emission Test
 Power Line : Line 1
 Test date : 2018/01/17
 Test Mode : Mode 1: Transmit - BLE (GFSK) (2440MHz)

| Frequency MHz | Correct Factor dB | Reading Level dB μ V | Measurement Level dB μ V | Margin dB | Limit dB μ V |
|-------------------|-------------------------|--------------------------------|------------------------------------|--------------|---------------------|
| LINE 1 | | | | | |
| Quasi-Peak | | | | | |
| 0.197 | 9.772 | 31.060 | 40.832 | -23.825 | 64.657 |
| 0.298 | 9.751 | 25.980 | 35.732 | -26.039 | 61.771 |
| 0.568 | 9.746 | 22.060 | 31.806 | -24.194 | 56.000 |
| 1.080 | 9.768 | 14.320 | 24.088 | -31.912 | 56.000 |
| 7.353 | 9.947 | 14.080 | 24.027 | -35.973 | 60.000 |
| 23.884 | 10.089 | 34.320 | 44.409 | -15.591 | 60.000 |
| Average | | | | | |
| 0.197 | 9.772 | 23.020 | 32.792 | -21.865 | 54.657 |
| 0.298 | 9.751 | 17.540 | 27.292 | -24.479 | 51.771 |
| 0.568 | 9.746 | 13.750 | 23.496 | -22.504 | 46.000 |
| 1.080 | 9.768 | 8.020 | 17.788 | -28.212 | 46.000 |
| 7.353 | 9.947 | 8.500 | 18.447 | -31.553 | 50.000 |
| 23.884 | 10.089 | 29.550 | 39.639 | -10.361 | 50.000 |

Note:

1. All Reading Levels are Quasi-Peak and average value.
2. "█" means the worst emission level.
3. Measurement Level = Reading Level + Correct Factor

Product : FLIC HUB
 Test Item : Conducted Emission Test
 Power Line : Line 2
 Test date : 2018/01/17
 Test Mode : Mode 1: Transmit - BLE (GFSK) (2440MHz)

| Frequency MHz | Correct Factor dB | Reading Level dB μ V | Measurement Level dB μ V | Margin dB | Limit dB μ V |
|-------------------|-------------------------|--------------------------------|------------------------------------|--------------|---------------------|
| LINE 2 | | | | | |
| Quasi-Peak | | | | | |
| 0.205 | 9.747 | 31.680 | 41.428 | -23.001 | 64.429 |
| 0.302 | 9.759 | 27.160 | 36.919 | -24.738 | 61.657 |
| 0.486 | 9.780 | 22.660 | 32.440 | -23.960 | 56.400 |
| 1.045 | 9.891 | 16.800 | 26.691 | -29.309 | 56.000 |
| 7.177 | 10.005 | 18.900 | 28.905 | -31.095 | 60.000 |
| 24.033 | 10.259 | 22.340 | 32.599 | -27.401 | 60.000 |
| Average | | | | | |
| 0.205 | 9.747 | 24.190 | 33.938 | -20.491 | 54.429 |
| 0.302 | 9.759 | 17.680 | 27.439 | -24.218 | 51.657 |
| 0.486 | 9.780 | 13.070 | 22.850 | -23.550 | 46.400 |
| 1.045 | 9.891 | 7.200 | 17.091 | -28.909 | 46.000 |
| 7.177 | 10.005 | 14.110 | 24.115 | -25.885 | 50.000 |
| 24.033 | 10.259 | 12.240 | 22.499 | -27.501 | 50.000 |

Note:

1. All Reading Levels are Quasi-Peak and average value.
2. "■" means the worst emission level.
3. Measurement Level = Reading Level + Correct Factor

3. Peak Power Output

3.1. Test Setup

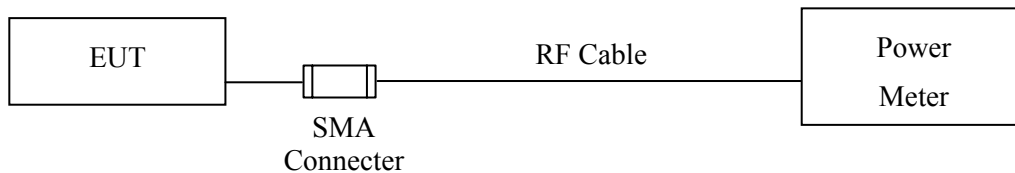

3.2. Limit

The maximum peak power shall be less 1Watt.

3.3. Test Procedure

Tested according to DTS test procedure of KDB 558074 for compliance to FCC 47CFR 15.247 requirements. The maximum peak conducted output power using KDB 558074 section 9.1.3 PKPM1 Peak power meter method.

3.4. Uncertainty

± 1.19 dB

3.5. Test Result of Peak Power Output

Product : FLIC HUB
Test Item : Peak Power Output
Test Site : No.3 OATS
Test date : 2018/01/24
Test Mode : Mode 1: Transmit - BLE (GFSK)

| Channel No. | Frequency (MHz) | Measurement (dBm) | Required Limit | Result |
|-------------|--------------------|----------------------|----------------|--------|
| Channel 00 | 2402.00 | 1.25 | 1 Watt= 30 dBm | Pass |
| Channel 19 | 2440.00 | 0.65 | 1 Watt= 30 dBm | Pass |
| Channel 39 | 2480.00 | -0.12 | 1 Watt= 30 dBm | Pass |

4. Radiated Emission

4.1. Test Setup

Under 30MHz

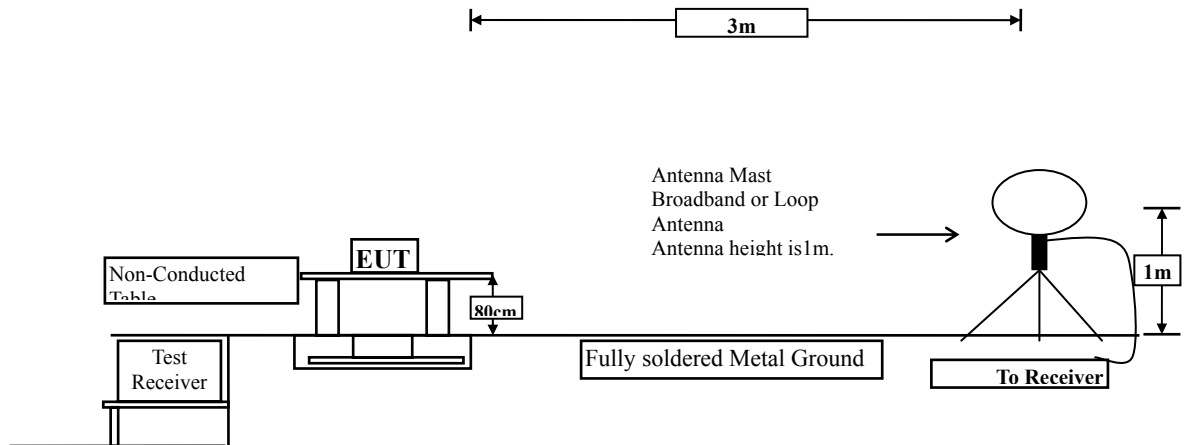

Below 1GHz

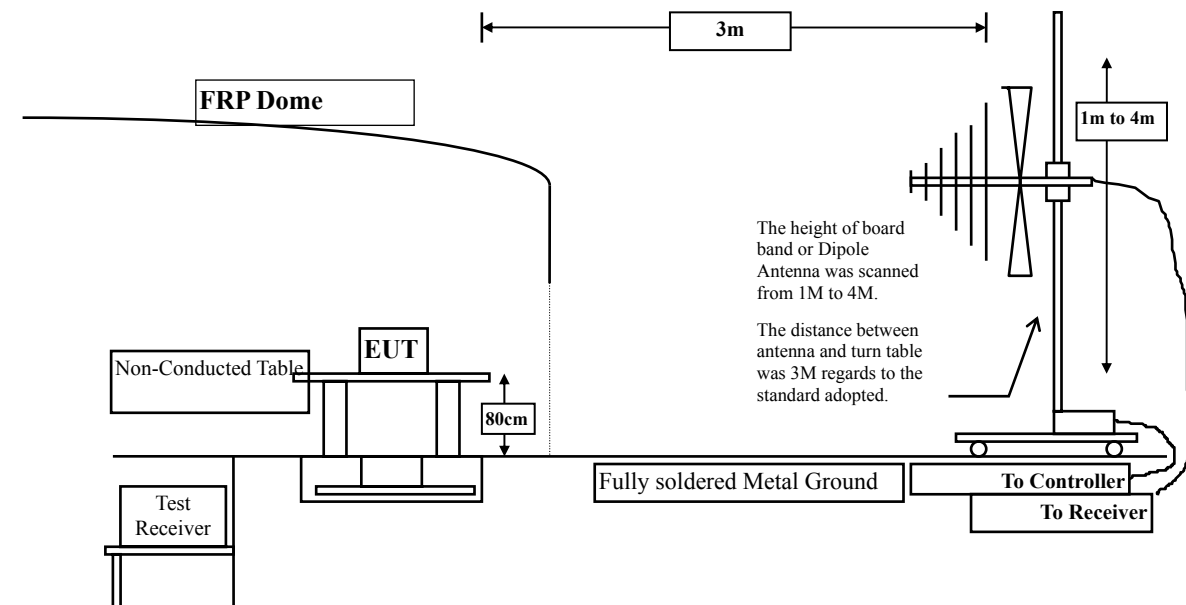

Above 1GHz

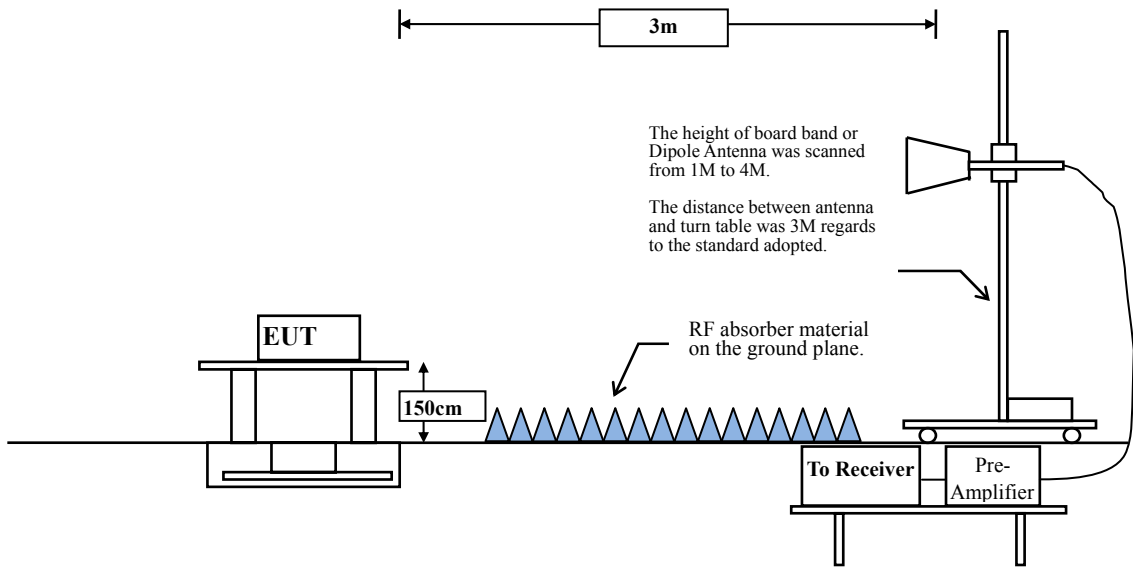

4.2. Limits

➤ General Radiated Emission Limits

Emissions radiated outside of the specified frequency bands, except for harmonics, shall be attenuated by at least 20dB below the level of the fundamental or to the general radiated emission limits in paragraph 15.209, whichever is the lesser attenuation.

| FCC Part 15 Subpart C Paragraph 15.209 Limits | | |
|--|--------------------------------------|---------------------------------|
| Frequency MHz | Field strength (microvolts/meter) | Measurement distance (meter) |
| 0.009-0.490 | 2400/F(kHz) | 300 |
| 0.490-1.705 | 24000/F(kHz) | 30 |
| 1.705-30 | 30 | 30 |
| 30-88 | 100 | 3 |
| 88-216 | 150 | 3 |
| 216-960 | 200 | 3 |
| Above 960 | 500 | 3 |

- Remarks:
1. RF Voltage (dB μ V) = 20 log RF Voltage (uV)
 2. In the Above Table, the tighter limit applies at the band edges.
 3. Distance refers to the distance in meters between the measuring instrument antenna and the closed point of any part of the device or system.

4.3. Test Procedure

The EUT was setup according to ANSI C63.10: 2013 and tested according to DTS test procedure of KDB558074 for compliance to FCC 47CFR 15.247 requirements.

Measuring the frequency range below 1GHz, the EUT is placed on a turn table which is 0.8 meter above ground, when measuring the frequency range above 1GHz, the EUT is placed on a turn table which is 1.5 meter above ground.

The turn table is rotated 360 degrees to determine the position of the maximum emission level.

The EUT was positioned such that the distance from antenna to the EUT was 3 meters.

The antenna is scanned between 1 meter and 4 meters to find out the maximum emission level. This is repeated for both horizontal and vertical polarization of the antenna. In order to find the maximum emission, all of the interface cables were manipulated according to ANSI C63.10: 2013 on radiated measurement.

The resolution bandwidth below 30MHz setting on the field strength meter is 9kHz and 30MHz~1GHz is 120kHz and above 1GHz is 1MHz.

Radiated emission measurements below 30MHz are made using Loop Antenna and 30MHz~1GHz are made using broadband Bilog antenna and above 1GHz are made using Horn Antennas.

The measurement is divided into the Preliminary Measurement and the Final Measurement.

The suspected frequencies are searched for in Preliminary Measurement with the measurement antenna kept pointed at the source of the emission both in azimuth and elevation, with the polarization of the antenna oriented for maximum response. The antenna is pointed at an angle towards the source of the emission, and the EUT is rotated in both height and polarization to maximize the measured emission. The emission is kept within the illumination area of the 3 dB bandwidth of the antenna.

The worst radiated emission is measured in the Open Area Test Site on the Final Measurement.

The measurement frequency range from 9kHz - 10th Harmonic of fundamental was investigated.

The average measurement tested according to KDB 558074 section 12.2.5.3. Reduced VBW averaging across on- and off-times of the EUT transmissions with max hold.

$VBW \geq 1/T$:

| Duty Cycle | T | 1/T | VBW Setting |
|------------|-----------|---------|-------------|
| 63.20 | 0.3950 ms | 2532 Hz | 3 KHz |

4.4. Uncertainty

± 4.08 dB above 1GHz

± 4.22 dB below 1GHz

4.5. Test Result of Radiated Emission

Product : FLIC HUB
 Test Item : Harmonic Radiated Emission
 Test Site : No.3 OATS
 Test date : 2018/01/16
 Test Mode : Mode 1: Transmit - BLE (GFSK)(2402MHz)

| Frequency MHz | Correct Factor dB | Reading Level dB μ V | Measurement Level dB μ V/m | Margin dB | Limit dB μ V/m |
|------------------------------|-------------------------|--------------------------------|--------------------------------------|--------------|-----------------------|
| Horizontal | | | | | |
| Peak Detector: | | | | | |
| 4804.000 | -9.896 | 49.031 | 39.135 | -34.865 | 74.000 |
| 7206.000 | -5.013 | 47.262 | 42.249 | -31.751 | 74.000 |
| 9608.000 | -1.472 | 40.983 | 39.512 | -34.488 | 74.000 |
| Average Detector: | | | | | |
| -- | | | | | |
| Vertical | | | | | |
| Peak Detector: | | | | | |
| 4804.000 | -6.585 | 47.378 | 40.793 | -33.207 | 74.000 |
| 7206.000 | -4.144 | 46.643 | 42.499 | -31.501 | 74.000 |
| 9608.000 | -1.075 | 41.189 | 40.115 | -33.885 | 74.000 |
| Average Detector: | | | | | |
| -- | | | | | |

Note:

- All Readings below 1GHz are Quasi-Peak, above 1GHz are performed with peak and/or average measurements as necessary.
- Peak measurements: RBW = 1MHz, VBW = 3 MHz, Sweep: Auto.
- Average measurements: RBW = 1MHz, VBW = 10 Hz, Sweep: Auto.
- Measurement Level = Reading Level + Correct Factor.
- Correct Factor = Antenna factor + Cable loss – Amplifier gain.
- The average measurement was not performed when the peak measured data under the limit of average detection.
- The emission levels of other frequencies are very lower than the limit and not show in test report.

Product : FLIC HUB
 Test Item : Harmonic Radiated Emission
 Test Site : No.3 OATS
 Test date : 2018/01/16
 Test Mode : Mode 1: Transmit - BLE (GFSK) (2440MHz)

| Frequency MHz | Correct Factor dB | Reading Level dB μ V | Measurement Level dB μ V/m | Margin dB | Limit dB μ V/m |
|------------------------------|-------------------------|--------------------------------|--------------------------------------|--------------|-----------------------|
| Horizontal | | | | | |
| Peak Detector: | | | | | |
| 4880.000 | -10.307 | 48.847 | 38.540 | -35.460 | 74.000 |
| 7320.000 | -3.857 | 46.925 | 43.068 | -30.932 | 74.000 |
| 9760.000 | -2.579 | 43.750 | 41.172 | -32.828 | 74.000 |
| Average Detector: | | | | | |
| -- | | | | | |
| Vertical | | | | | |
| Peak Detector: | | | | | |
| 4880.000 | -7.579 | 46.937 | 39.358 | -34.642 | 74.000 |
| 7320.000 | -2.987 | 46.453 | 43.466 | -30.534 | 74.000 |
| 9760.000 | -2.107 | 43.259 | 41.152 | -32.848 | 74.000 |
| Average Detector: | | | | | |
| -- | | | | | |

Note:

- All Readings below 1GHz are Quasi-Peak, above 1GHz are performed with peak and/or average measurements as necessary.
- Peak measurements: RBW = 1MHz, VBW = 3 MHz, Sweep: Auto.
- Average measurements: RBW = 1MHz, VBW = 10 Hz, Sweep: Auto.
- Measurement Level = Reading Level + Correct Factor.
- Correct Factor = Antenna factor + Cable loss – Amplifier gain.
- The average measurement was not performed when the peak measured data under the limit of average detection.
- The emission levels of other frequencies are very lower than the limit and not show in test report.

Product : FLIC HUB
 Test Item : Harmonic Radiated Emission
 Test Site : No.3 OATS
 Test date : 2018/01/16
 Test Mode : Mode 1: Transmit - BLE (GFSK) (2480MHz)

| Frequency MHz | Correct Factor dB | Reading Level dB μ V | Measurement Level dB μ V/m | Margin dB | Limit dB μ V/m |
|------------------------------|-------------------------|--------------------------------|--------------------------------------|--------------|-----------------------|
| Horizontal | | | | | |
| Peak Detector: | | | | | |
| 4960.000 | -10.666 | 52.657 | 41.992 | -32.008 | 74.000 |
| 7440.000 | -3.631 | 46.099 | 42.468 | -31.532 | 74.000 |
| 9920.000 | -2.397 | 44.811 | 42.414 | -31.586 | 74.000 |
| Average Detector: | | | | | |
| -- | | | | | |
| Vertical | | | | | |
| Peak Detector: | | | | | |
| 4960.000 | -7.869 | 47.978 | 40.110 | -33.890 | 74.000 |
| 7440.000 | -2.772 | 46.453 | 43.681 | -30.319 | 74.000 |
| 9920.000 | -1.895 | 43.596 | 41.701 | -32.299 | 74.000 |
| Average Detector: | | | | | |
| -- | | | | | |

Note:

1. All Readings below 1GHz are Quasi-Peak, above 1GHz are performed with peak and/or average measurements as necessary.
2. Peak measurements: RBW = 1MHz, VBW = 3 MHz, Sweep: Auto.
3. Average measurements: RBW = 1MHz, VBW = 10 Hz, Sweep: Auto.
4. Measurement Level = Reading Level + Correct Factor.
5. Correct Factor = Antenna factor + Cable loss – Amplifier gain.
6. The average measurement was not performed when the peak measured data under the limit of average detection.
7. The emission levels of other frequencies are very lower than the limit and not show in test report.

Product : FLIC HUB
 Test Item : General Radiated Emission
 Test Site : No.3 OATS
 Test date : 2018/01/17
 Test Mode : Mode 1: Transmit - BLE (GFSK) (2440MHz)

| Frequency MHz | Correct Factor dB | Reading Level dB μ V | Measurement Level dB μ V/m | Margin dB | Limit dB μ V/m |
|-------------------|-------------------------|--------------------------------|--------------------------------------|--------------|-----------------------|
| Horizontal | | | | | |
| 106.630 | -7.622 | 43.134 | 35.512 | -7.988 | 43.500 |
| 250.190 | -6.134 | 43.216 | 37.083 | -8.917 | 46.000 |
| 433.520 | 0.841 | 38.686 | 39.527 | -6.473 | 46.000 |
| 513.060 | 3.186 | 35.090 | 38.276 | -7.724 | 46.000 |
| 649.830 | 1.857 | 38.836 | 40.693 | -5.307 | 46.000 |
| 859.350 | 6.486 | 29.743 | 36.229 | -9.771 | 46.000 |
| Vertical | | | | | |
| 106.630 | -4.302 | 41.378 | 37.076 | -6.424 | 43.500 |
| 299.660 | -4.061 | 42.343 | 38.282 | -7.718 | 46.000 |
| 380.170 | 0.962 | 35.569 | 36.531 | -9.469 | 46.000 |
| 600.360 | 1.302 | 39.222 | 40.524 | -5.476 | 46.000 |
| 749.740 | 2.023 | 34.728 | 36.751 | -9.249 | 46.000 |
| 949.560 | 3.156 | 29.656 | 32.812 | -13.188 | 46.000 |

Note:

1. All Readings below 1GHz are Quasi-Peak, above 1GHz are performed with peak and/or average measurements as necessary.
2. Peak measurements: RBW = 1MHz, VBW = 3 MHz, Sweep: Auto.
3. Average measurements: RBW = 1MHz, VBW = 10 Hz, Sweep: Auto.
4. Measurement Level = Reading Level + Correct Factor.
5. Correct Factor = Antenna factor + Cable loss – Amplifier gain.
6. The average measurement was not performed when the peak measured data under the limit of average detection.
7. The emission levels of other frequencies are very lower than the limit and not show in test report.
8. No emission found between lowest internal used/generated frequency to 30MHz.

5. RF Antenna Conducted Test

5.1. Test Setup

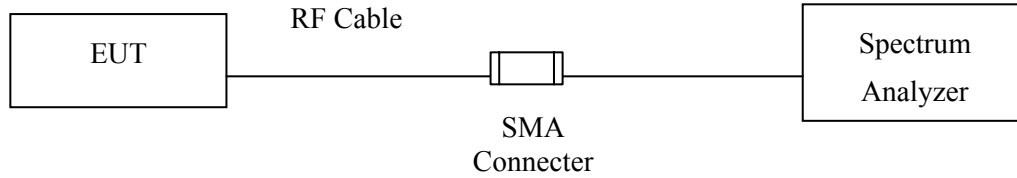

5.2. Limits

According to FCC Section 15.247(d). In any 100 kHz bandwidth outside the frequency band in which the spread spectrum or digitally modulated intentional radiator is operating, the radio frequency power that is produced by the intentional radiator shall be at least 20 dB below that in the 100 kHz bandwidth within the band that contains the highest level of the desired power, based on either an RF conducted or measurement, provided the transmitter demonstrates compliance with the peak conducted power limits. If the transmitter complies with the conducted power limits based on the use of RMS averaging over a time interval, the attenuation required under this paragraph shall be 30 dB instead of 20 dB.

5.3. Test Procedure

The EUT was tested according to DTS test procedure of KDB558074 for compliance to FCC 47CFR 15.247 requirements.

5.4. Uncertainty

$\pm 1.20\text{dB}$

5.5. Test Result of RF Antenna Conducted Test

Product : FLIC HUB
Test Item : RF Antenna Conducted Test
Test Site : No.3 OATS
Test date : 2018/01/17
Test Mode : Mode 1: Transmit - BLE (GFSK)

Figure Channel 00:

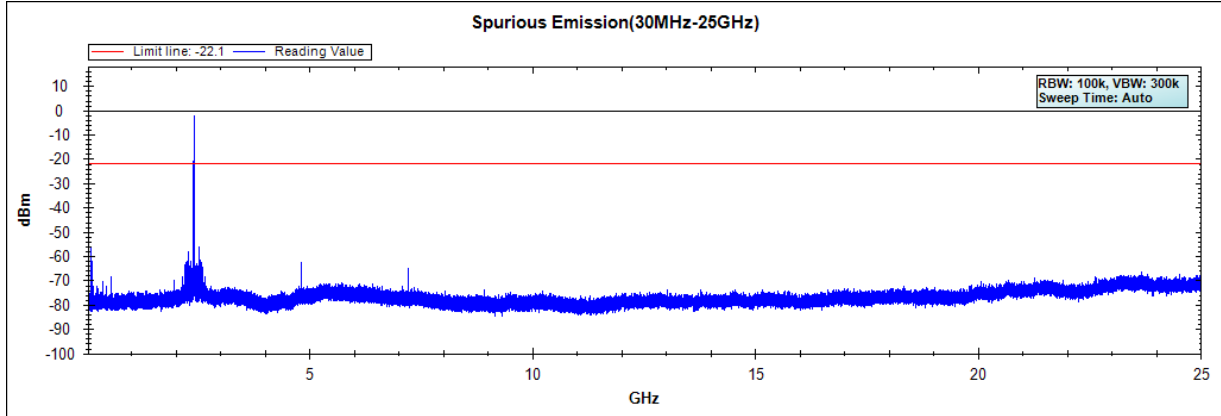

Figure Channel 19:

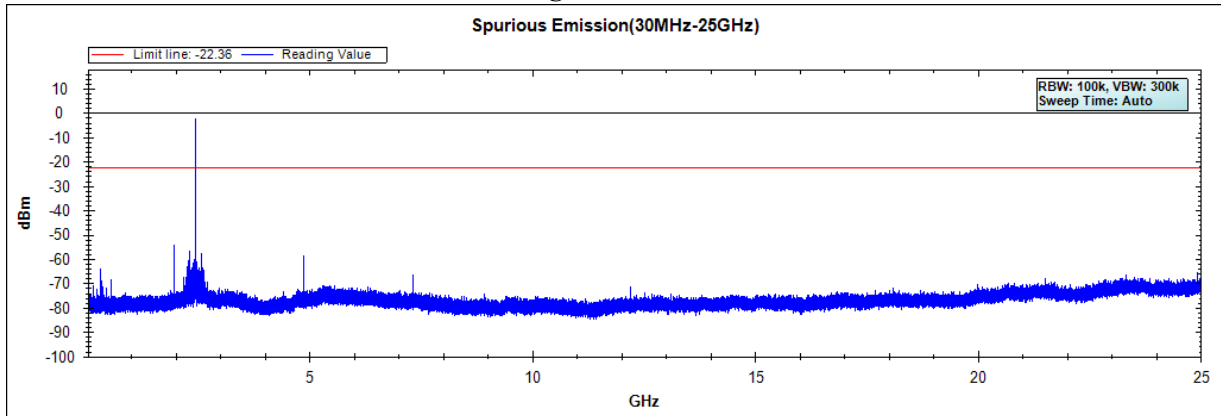
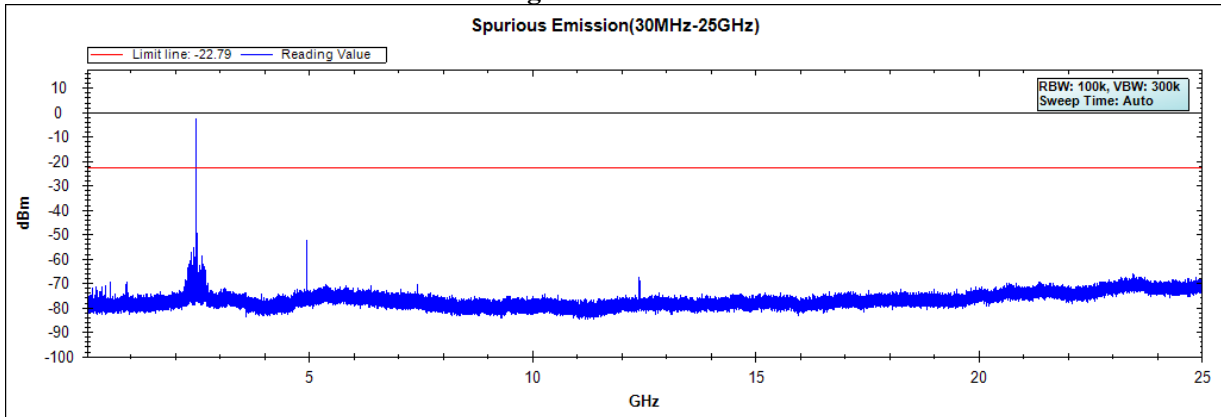

Figure Channel 39:



6. Band Edge

6.1. Test Setup

RF Conducted Measurement

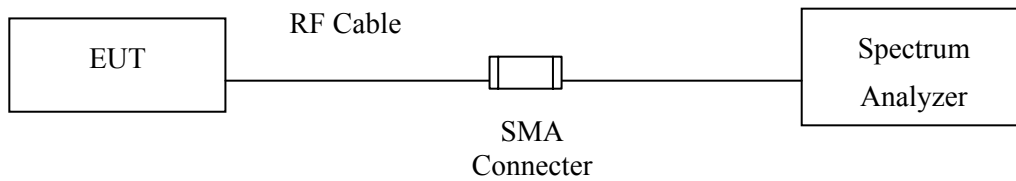

RF Radiated Measurement:

Above 1GHz

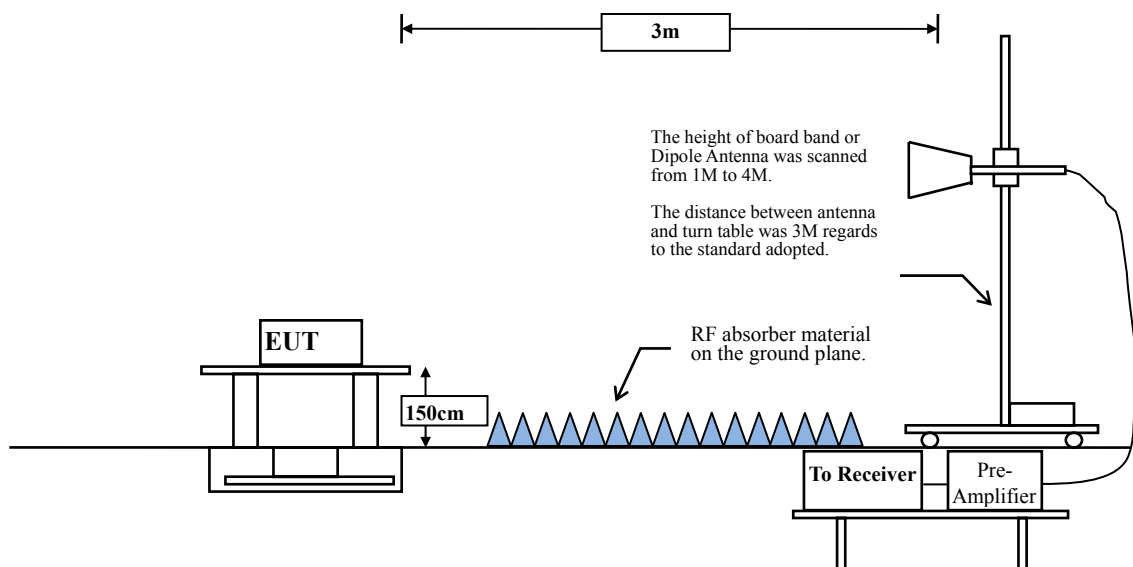

6.2. Limit

According to FCC Section 15.247(d). In any 100 kHz bandwidth outside the frequency band in which the spread spectrum or digitally modulated intentional radiator is operating, the radio frequency power that is produced by the intentional radiator shall be at least 20 dB below that in the 100 kHz bandwidth within the band that contains the highest level of the desired power, based on either an RF conducted or measurement, provided the transmitter demonstrates compliance with the peak conducted power limits. If the transmitter complies with the conducted power limits based on the use of RMS averaging over a time interval, the attenuation required under this paragraph shall be 30 dB instead of 20 dB. Attenuation below the general limits specified in Section 15.209(a) is not required. In addition, radiated emissions which fall in the restricted bands, as defined in Section 15.205(a), must also comply with the radiated emission limits specified in Section 15.209(a) (see Section 15.205(c)).

6.3. Test Procedure

The EUT was setup according to ANSI C63.10, 2013 and tested according to DTS test procedure of KDB558074 for compliance to FCC 47CFR 15.247 requirements.

The EUT is placed on a turn table which is 1.5 meter above ground. The turn table is rotated 360 degrees to determine the position of the maximum emission level. The EUT was positioned such that the distance from antenna to the EUT was 3 meters.

The antenna is scanned from 1 meter to 4 meters to find out the maximum emission level. This is repeated for both horizontal and vertical polarization of the antenna. In order to find the maximum emission, all of the interface cables were manipulated according to ANSI C63.10:2013 on radiated measurement.

The average measurement tested according to KDB 558074 section 12.2.5.3. Reduced VBW averaging across on- and off-times of the EUT transmissions with max hold.

VBW \geq 1/T:

| Duty Cycle | T | 1/T | VBW Setting |
|------------|-----------|---------|-------------|
| 63.20 | 0.3950 ms | 2532 Hz | 3 KHz |

6.4. Uncertainty

± 4.08 dB above 1GHz

± 4.22 dB below 1GHz

6.5. Test Result of Band Edge

Product : FLIC HUB
 Test Item : Band Edge
 Test Site : No.3 OATS
 Test date : 2018/01/16
 Test Mode : Mode 1: Transmit - BLE (GFSK)

RF Radiated Measurement (Horizontal):

| Channel No. | Frequency (MHz) | Correct Factor (dB) | Reading Level (dBμV) | Emission Level (dBμV/m) | Peak Limit (dBμV/m) | Average Limit (dBμV/m) | Result |
|--------------|-----------------|---------------------|----------------------|-------------------------|---------------------|------------------------|--------|
| 00 (Peak) | 2390.000 | 6.474 | 40.568 | 47.043 | 74.00 | 54.00 | Pass |
| 00 (Peak) | 2400.000 | 6.528 | 58.495 | 65.023 | 74.00 | 54.00 | Pass |
| 00 (Peak) | 2402.200 | 6.541 | 91.317 | 97.858 | -- | -- | -- |
| 00 (Average) | 2352.500 | 6.307 | 26.449 | 32.757 | 74.00 | 54.00 | Pass |
| 00 (Average) | 2390.000 | 6.474 | 24.975 | 31.450 | 74.00 | 54.00 | Pass |
| 00 (Average) | 2400.000 | 6.528 | 38.630 | 45.158 | -- | -- | -- |
| 00 (Average) | 2402.000 | 6.540 | 66.660 | 73.200 | -- | -- | -- |

Figure Channel 00: Horizontal (Peak)

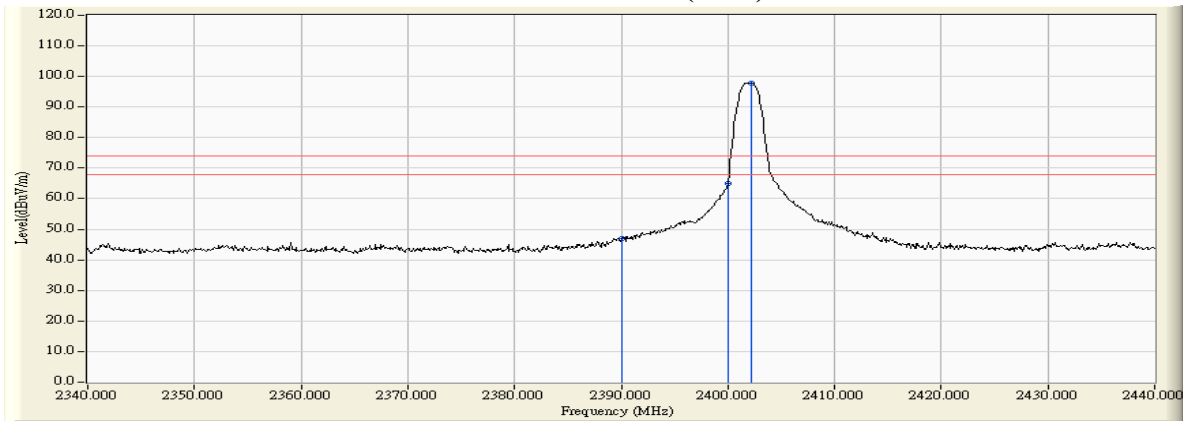
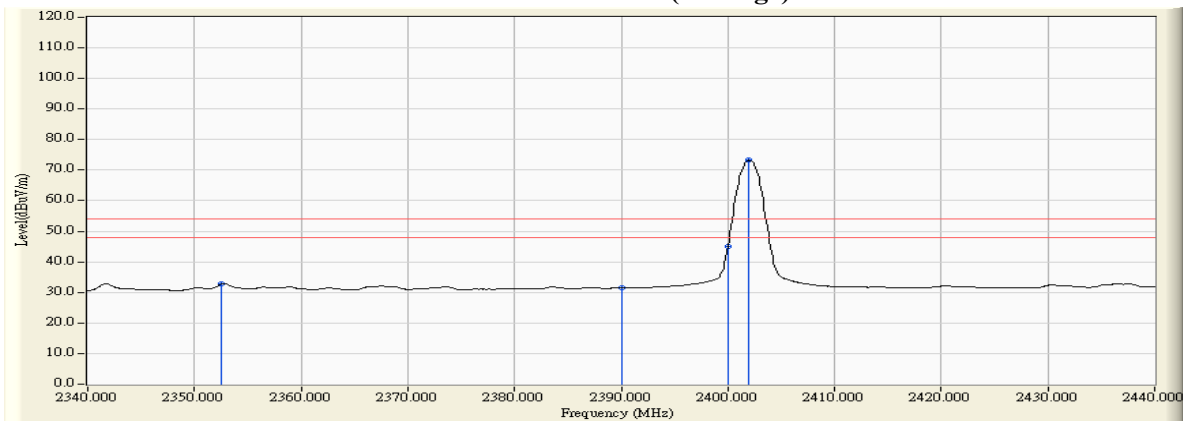

Figure Channel 00: Horizontal (Average)



Note:

1. All readings above 1GHz are performed with peak and/or average measurements as necessary.
2. Peak measurements: RBW = 1MHz, VBW = 3 MHz, Sweep: Auto.
3. Average measurements: RBW = 1MHz, VBW = 10 Hz, Sweep: Auto.
4. “ * ”, means this data is the worst emission level.
5. Measurement Level = Reading Level + Correct Factor.
6. The average measurement was not performed when the peak measured data under the limit of average detection.

Product : FLIC HUB
 Test Item : Band Edge
 Test Site : No.3 OATS
 Test date : 2018/01/16
 Test Mode : Mode 1: Transmit - BLE (GFSK)

RF Radiated Measurement (Vertical):

| Channel No. | Frequency (MHz) | Correct Factor (dB) | Reading Level (dBμV) | Emission Level (dBμV/m) | Peak Limit (dBμV/m) | Average Limit (dBμV/m) | Result |
|--------------|-----------------|---------------------|----------------------|-------------------------|---------------------|------------------------|--------|
| 00 (Peak) | 2390.000 | 5.880 | 37.350 | 43.231 | 74.00 | 54.00 | Pass |
| 00 (Peak) | 2400.000 | 5.879 | 53.215 | 59.094 | 74.00 | 54.00 | Pass |
| 00 (Peak) | 2402.200 | 5.884 | 86.067 | 91.951 | -- | -- | -- |
| 00 (Average) | 2390.000 | 5.880 | 24.713 | 30.594 | 74.00 | 54.00 | Pass |
| 00 (Average) | 2400.000 | 5.879 | 35.529 | 41.408 | 74.00 | 54.00 | Pass |
| 00 (Average) | 2402.000 | 5.884 | 63.327 | 69.211 | -- | -- | -- |

Figure Channel 00: Vertical (Peak)

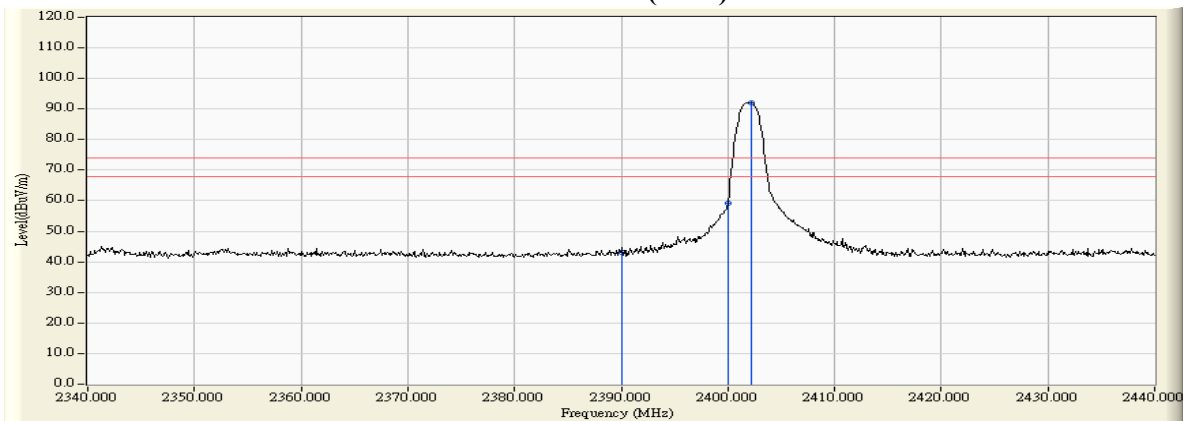
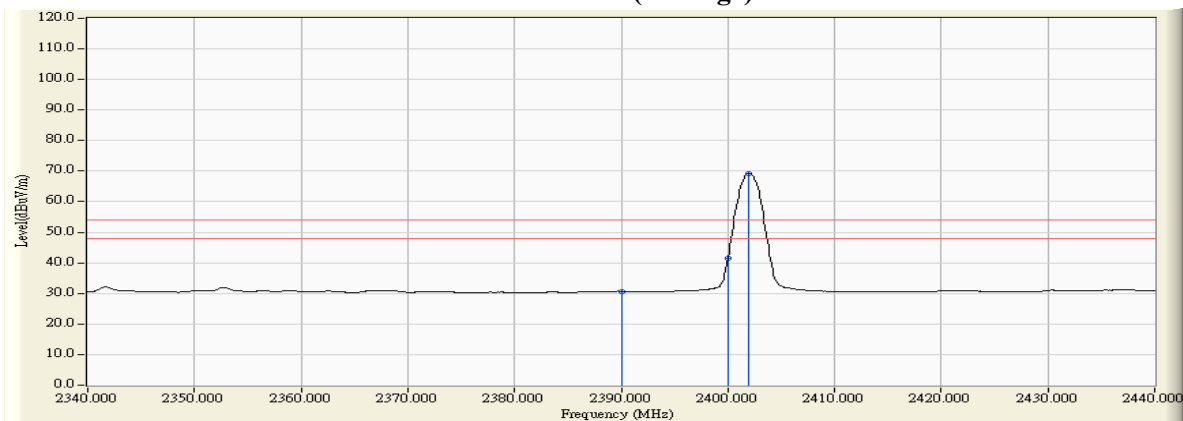

Figure Channel 00: Vertical (Average)



Note:

1. All readings above 1GHz are performed with peak and/or average measurements as necessary.
2. Peak measurements: RBW = 1MHz, VBW = 3 MHz, Sweep: Auto.
3. Average measurements: RBW = 1MHz, VBW = 10 Hz, Sweep: Auto.
4. “ * ”, means this data is the worst emission level.
5. Measurement Level = Reading Level + Correct Factor.
6. The average measurement was not performed when the peak measured data under the limit of average detection.

Product : FLIC HUB
 Test Item : Band Edge
 Test Site : No.3 OATS
 Test date : 2018/01/16
 Test Mode : Mode 1: Transmit - BLE (GFSK)

RF Radiated Measurement (Horizontal):

| Channel No. | Frequency (MHz) | Correct Factor (dB) | Reading Level (dBμV) | Emission Level (dBμV/m) | Peak Limit (dBμV/m) | Average Limit (dBμV/m) | Result |
|--------------|-----------------|---------------------|----------------------|-------------------------|---------------------|------------------------|--------|
| 39 (Peak) | 2479.700 | 7.084 | 90.947 | 98.030 | -- | -- | -- |
| 39 (Peak) | 2483.500 | 7.110 | 51.301 | 58.411 | 74.00 | 54.00 | Pass |
| 39 (Average) | 2480.000 | 7.085 | 66.584 | 73.669 | -- | -- | -- |
| 39 (Average) | 2483.500 | 7.110 | 27.878 | 34.988 | 74.00 | 54.00 | Pass |

Figure Channel 39: Horizontal (Peak)

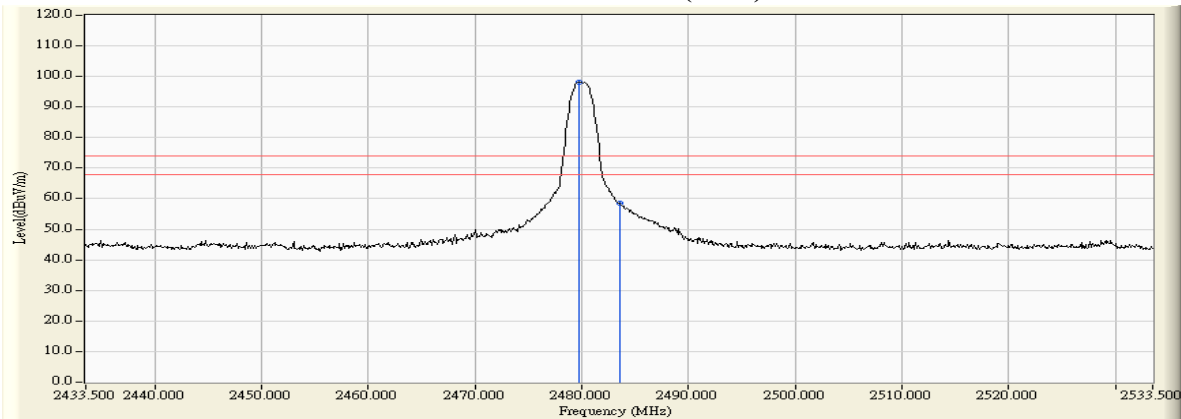
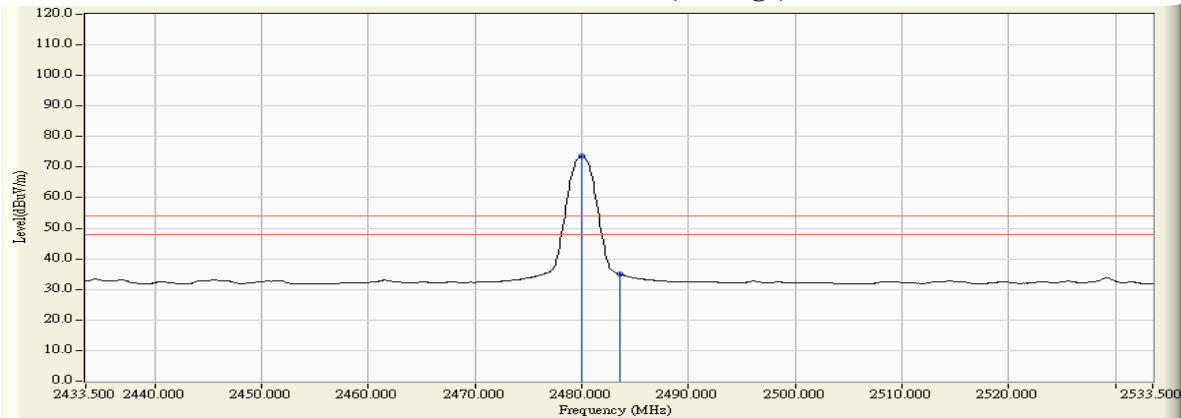

Figure Channel 39: Horizontal (Average)



Note:

1. All readings above 1GHz are performed with peak and/or average measurements as necessary.
2. Peak measurements: RBW = 1MHz, VBW = 3 MHz, Sweep: Auto.
3. Average measurements: RBW = 1MHz, VBW = 10 Hz, Sweep: Auto.
4. “ * ”, means this data is the worst emission level.
5. Measurement Level = Reading Level + Correct Factor.
6. The average measurement was not performed when the peak measured data under the limit of average detection.

Product : FLIC HUB
 Test Item : Band Edge
 Test Site : No.3 OATS
 Test date : 2018/01/16
 Test Mode : Mode 1: Transmit - BLE (GFSK)

RF Radiated Measurement (Vertical):

| Channel No. | Frequency (MHz) | Correct Factor (dB) | Reading Level (dBμV) | Emission Level (dBμV/m) | Peak Limit (dBμV/m) | Average Limit (dBμV/m) | Result |
|--------------|-----------------|---------------------|----------------------|-------------------------|---------------------|------------------------|--------|
| 39 (Peak) | 2479.700 | 6.340 | 85.981 | 92.320 | -- | -- | -- |
| 39 (Peak) | 2483.500 | 6.363 | 46.906 | 53.269 | 74.00 | 54.00 | Pass |
| 39 (Average) | 2480.000 | 6.342 | 63.387 | 69.728 | -- | -- | -- |
| 39 (Average) | 2483.500 | 6.363 | 26.142 | 32.505 | 74.00 | 54.00 | Pass |

Figure Channel 39: Vertical (Peak)

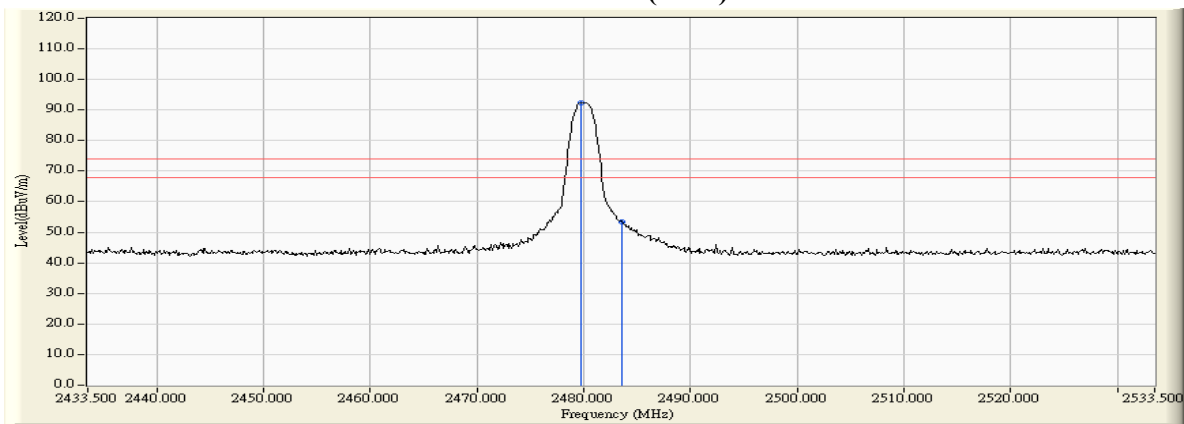
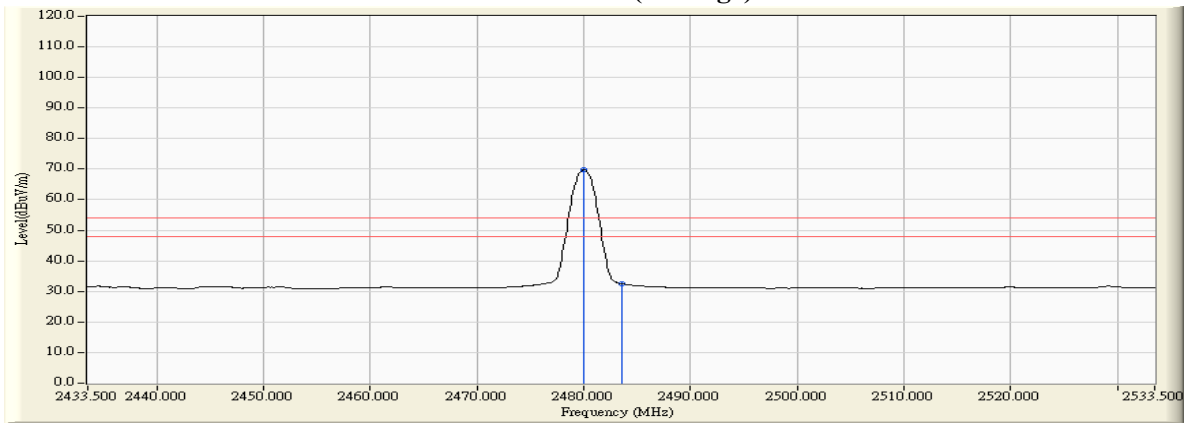

Figure Channel 39: Vertical (Average)



Note:

1. All readings above 1GHz are performed with peak and/or average measurements as necessary.
2. Peak measurements: RBW = 1MHz, VBW = 3 MHz, Sweep: Auto.
3. Average measurements: RBW = 1MHz, VBW = 10 Hz, Sweep: Auto.
4. “ * ”, means this data is the worst emission level.
5. Measurement Level = Reading Level + Correct Factor.
6. The average measurement was not performed when the peak measured data under the limit of average detection.

7. 6dB Bandwidth

7.1. Test Setup

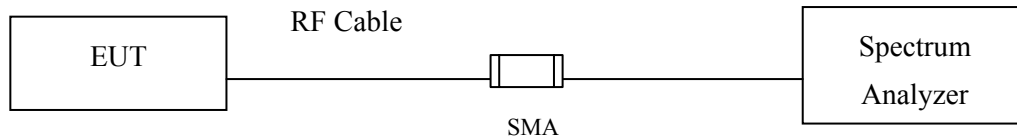

7.2. Limits

The minimum bandwidth shall be at least 500 kHz.

7.3. Test Procedure

The EUT was setup according to ANSI C63.10 2013; tested according to DTS test procedure of KDB558074 for compliance to FCC 47CFR 15.247 requirements.

Set RBW = 1-5% of the emission bandwidth, $VBW \geq 3 * RBW$

7.4. Uncertainty

$\pm 283\text{Hz}$

7.5. Test Result of 6dB Bandwidth

Product : FLIC HUB
 Test Item : 6dB Bandwidth Data
 Test Site : No.3 OATS
 Test Mode : Mode 1: Transmit - BLE (GFSK) (2402MHz)

| Channel No. | Frequency (MHz) | Measurement Level (kHz) | Required Limit (kHz) | Result |
|-------------|-----------------|-------------------------|----------------------|--------|
| 00 | 2402 | 730 | >500 | Pass |

Figure Channel 00:

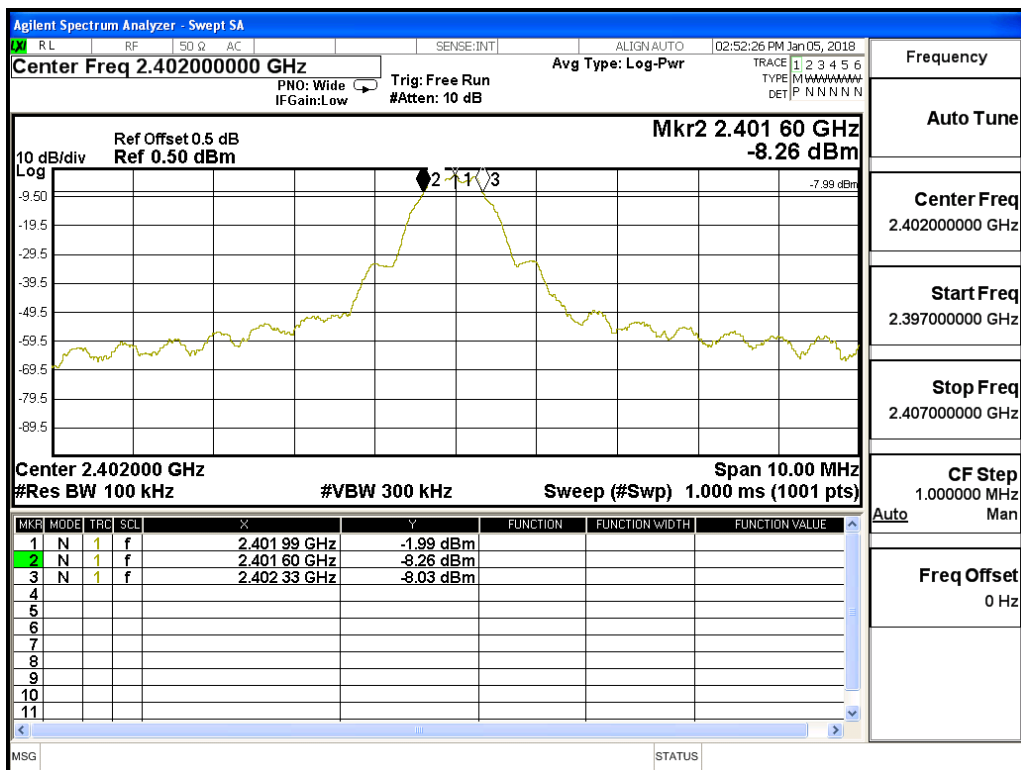

Product : FLIC HUB
 Test Item : 6dB Bandwidth Data
 Test Site : No.3 OATS
 Test Mode : Mode 1: Transmit - BLE (GFSK) (2440MHz)

| Channel No. | Frequency (MHz) | Measurement Level (kHz) | Required Limit (kHz) | Result |
|-------------|-----------------|-------------------------|----------------------|--------|
| 19 | 2440 | 740 | >500 | Pass |

Figure Channel 19:

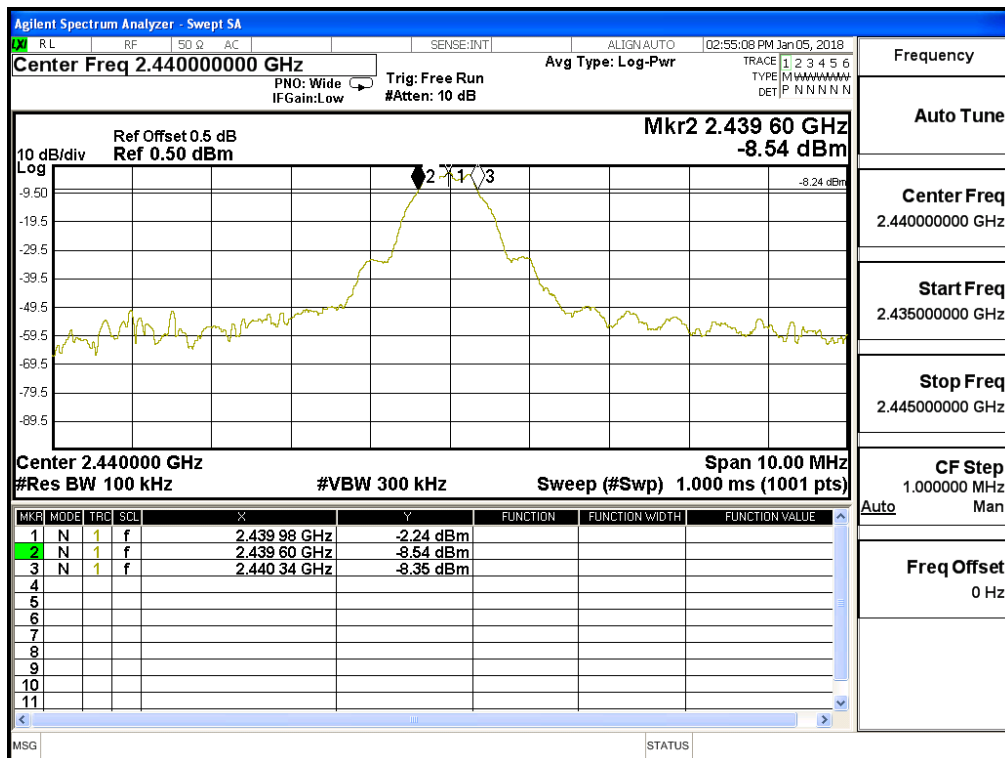

Product : FLIC HUB
 Test Item : 6dB Bandwidth Data
 Test Site : No.3 OATS
 Test Mode : Mode 1: Transmit - BLE (GFSK) (2480MHz)

| Channel No. | Frequency (MHz) | Measurement Level (kHz) | Required Limit (kHz) | Result |
|-------------|-----------------|-------------------------|----------------------|--------|
| 39 | 2480 | 740 | >500 | Pass |

Figure Channel 39:

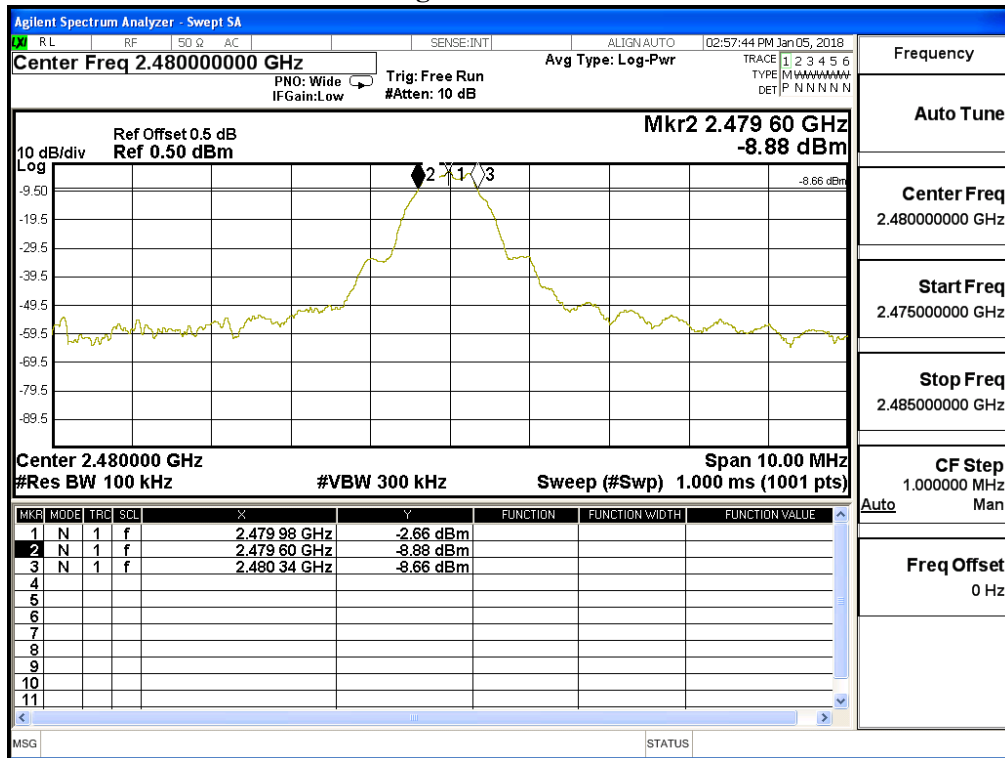

8. Power Density

8.1. Test Setup

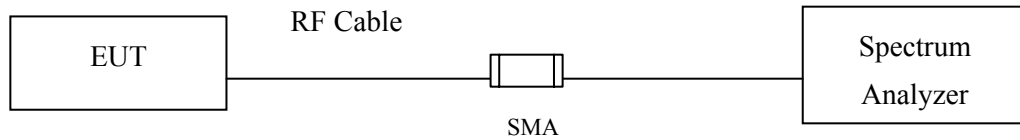

8.2. Limits

The transmitted power density averaged over any 1 second interval shall not be greater +8dBm in any 3kHz bandwidth.

8.3. Test Procedure

The EUT was setup according to ANSI C63.10: 2013, the maximum power spectral density using KDB 558074 section 10.2 PKPSD (peak PSD) method.

8.4. Uncertainty

± 1.20 dB

8.5. Test Result of Power Density

Product : FLIC HUB
 Test Item : Power Density Data
 Test Site : No.3 OATS
 Test Mode : Mode 1: Transmit - BLE (GFSK) (2402MHz)

| Channel No. | Frequency (MHz) | Measure Level (dBm) | Limit (dBm) | Result |
|-------------|-----------------|---------------------|-------------|--------|
| 00 | 2402 | -2.10 | ≤ 8dBm | Pass |

Figure Channel 00:

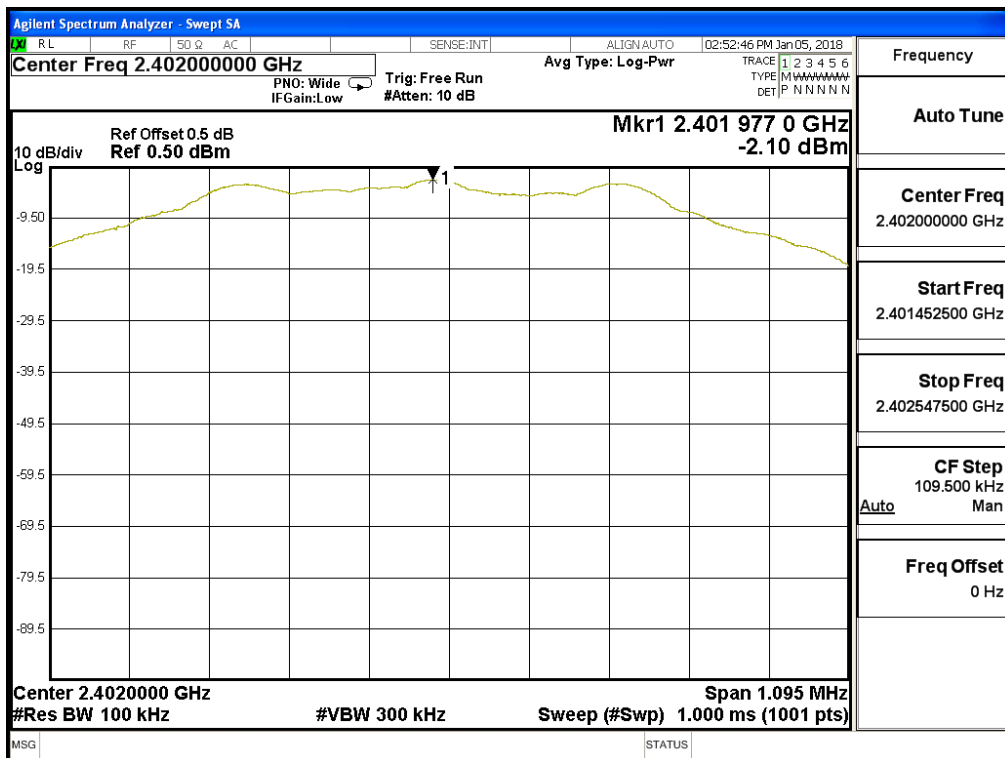

Product : FLIC HUB
 Test Item : Power Density Data
 Test Site : No.3OATS
 Test Mode : Mode 1: Transmit - BLE (GFSK) (2440MHz)

| Channel No. | Frequency (MHz) | Measurement Level (dBm) | Required Limit (dBm) | Result |
|-------------|-----------------|-------------------------|----------------------|--------|
| 19 | 2440 | -2.36 | ≤ 8dBm | Pass |

Figure Channel 19:

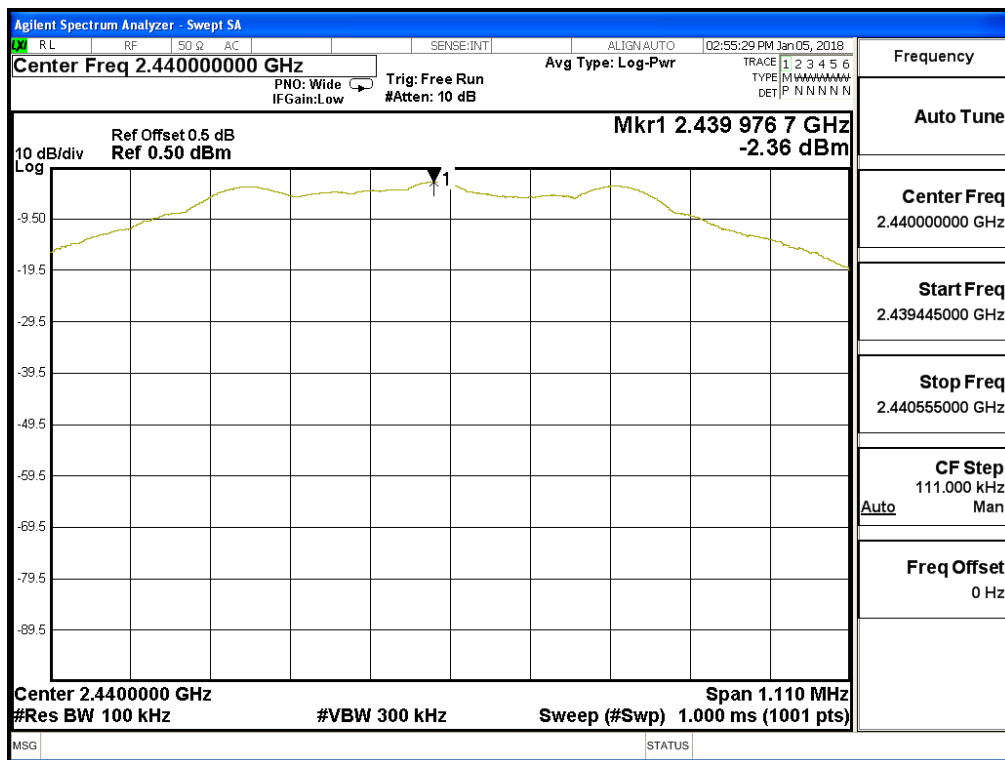

Product : FLIC HUB
 Test Item : Power Density Data
 Test Site : No.3 OATS
 Test Mode : Mode 1: Transmit - BLE (GFSK) (2480MHz)

| Channel No. | Frequency (MHz) | Measurement Level (dBm) | Required Limit (dBm) | Result |
|-------------|-----------------|-------------------------|----------------------|--------|
| 39 | 2480 | -2.79 | ≤ 8dBm | Pass |

Figure Channel 39:

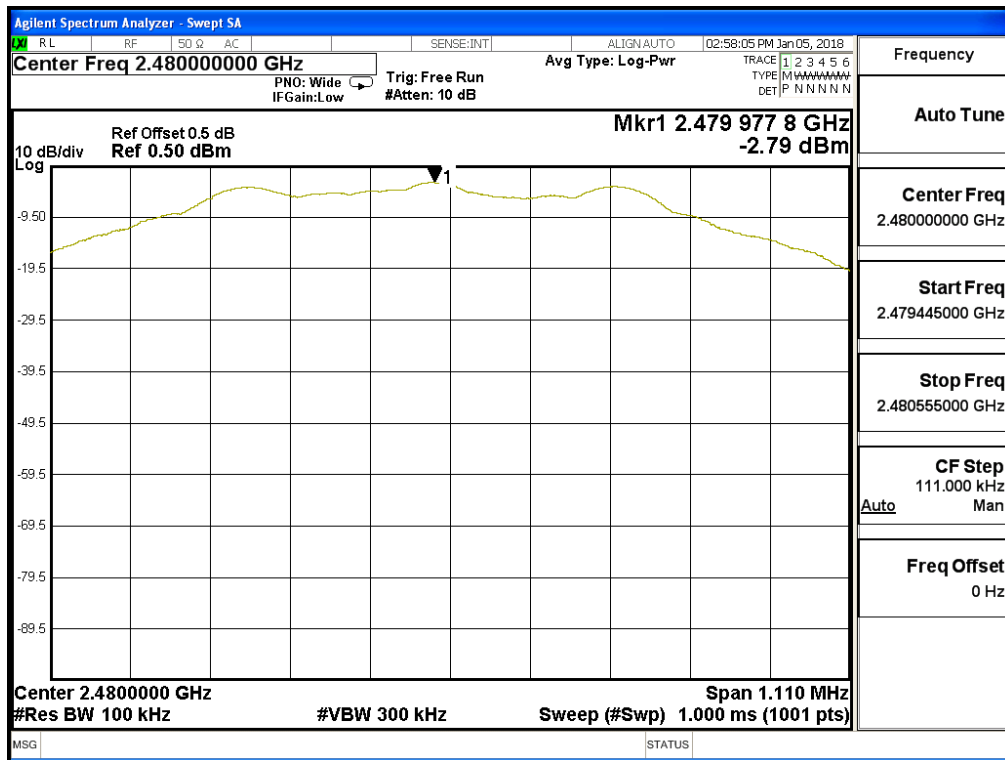

9. EMI Reduction Method During Compliance Testing

No modification was made during testing.