

Fig.62. Conducted spurious emission: 8DPSK, Channel 78, 3GHz - 10GHz

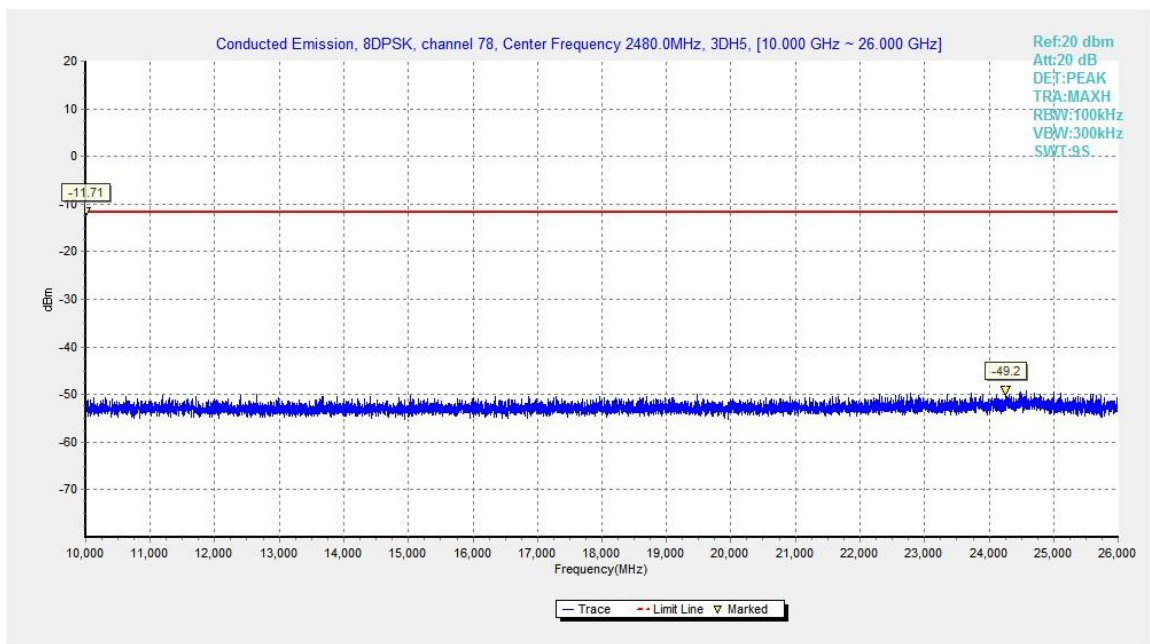

Fig.63. Conducted spurious emission: 8DPSK, Channel 78, 10GHz - 26GHz

## B.6. Transmitter Spurious Emission - Radiated

**Method of Measurement:** See ANSI C63.10-2013-clause 6.4 & 6.5 & 6.6

**Measurement Limit:**

Standard	Limit
FCC 47 CFR Part 15.247, 15.205, 15.209	20dB below peak output power

radiated emissions which fall in the restricted bands, as defined in § 15.205(a), must also comply with the radiated emission limits specified in § 15.209(a) (see § 15.205(c)).

**Limit in restricted band:**

Frequency (MHz)	Field strength( $\mu$ V/m)	Measurement distance (m)
0.009 - 0.490	2400/F(kHz)	300
0.490 - 1.705	24000/F(kHz)	30
1.705 – 30.0	30	30

Frequency of emission (MHz)	Field strength( $\mu$ V/m)	Field strength(dBuV/m)
30-88	100	40
88-216	150	43.5
216-960	200	46
Above 960	500	54

**Set up:**

Tabletop devices shall be placed on a nonconducting platform with nominal top surface dimensions 1 m by 1.5 m. For emissions testing at or below 1 GHz, the table height shall be 80 cm above the reference ground plane. For emission measurements above 1 GHz, the table height shall be 1.5 m

The EUT and transmitting antenna shall be centered on the turntable.

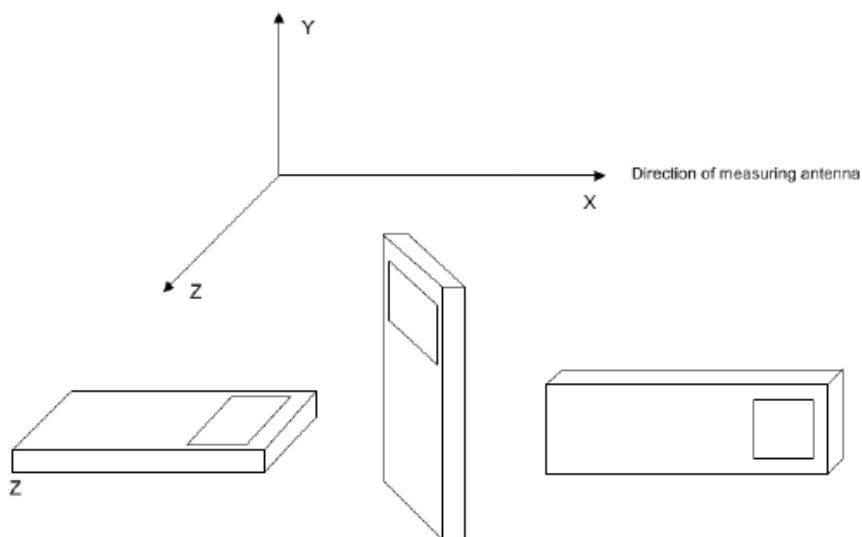
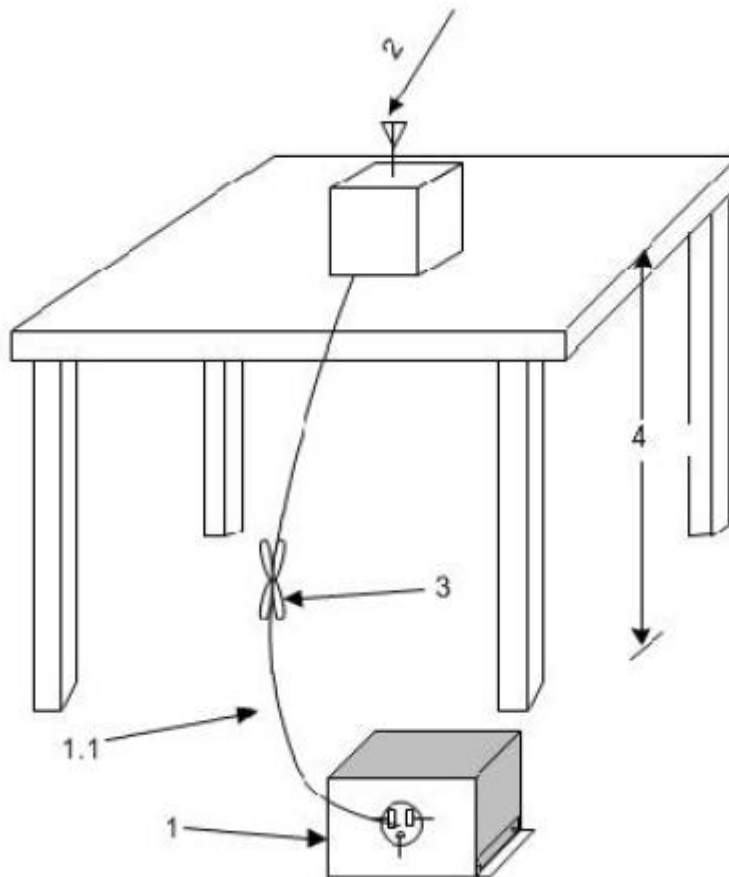

**Test Condition**

The EUT shall be tested 1 near top, 1 near middle, and 1 near bottom. Set the unlicensed wireless device to operate in continuous transmit mode. For unlicensed wireless devices unable to be configured for 100% duty cycle even in test mode, configure the system for the maximum duty cycle supported.

When required for unlicensed wireless devices, measurements of the variation of the input power or the radiated signal level of the fundamental frequency component of the emission, as appropriate, shall be performed with the supply voltage varied between 85% and 115% of the

nominal rated supply voltage.

### **Exploratory radiated emissions measurements**

Exploratory radiated measurements shall be performed at the measurement distance or at a closer distance than that specified for compliance to determine the emission characteristics of the EUT and, if applicable, the EUT configuration that produces the maximum level of emissions. The frequencies of maximum emission may be determined by manually positioning the antenna close to the EUT, and then moving the antenna over all sides of the EUT while observing a spectral display. It is advantageous to have prior knowledge of the frequencies of emissions, although this may be determined from such a near-field scan. The near-field scan shall only be used to determine the frequency but not the amplitude of the emissions. Where exploratory measurements are not adequate to determine the worst-case operating modes and are used only to identify the frequencies of the highest emissions, additional preliminary tests can be required.

For emissions from the EUT, the maximum level shall be determined by rotating the EUT and its antenna through 0° to 360°. For each mode of operation required to be tested, the frequency spectrum (based on findings from exploratory measurements) shall be monitored.

Broadband antennas and a spectrum analyzer or a radio-noise meter with a panoramic display are often useful in this type of test. If either antenna height or EUT azimuth are not fully measured during exploratory testing, then complete testing can be required at the OATS or semi-anechoic chamber when the final full spectrum testing is performed.

### **Final radiated emissions measurements**

The final measurements are using the orientation and equipment arrangement of the EUT based on the measurement results found during the preliminary (exploratory) measurements, the EUT arrangement, appropriate modulation, and modes of operation that produce the emissions that have the highest amplitude relative to the limit shall be selected for the final measurement.

For each mode of operation required to be tested, the frequency spectrum (based on findings from exploratory measurements) shall be monitored. The highest signal levels relative to the limit shall be determined by rotating the EUT from 0° to 360° and with varying the measurement antenna height between 1 m and 4 m in vertical and horizontal polarizations.

For each mode selected, record the frequency and amplitude of the highest fundamental emission (if applicable), as well as the frequency and amplitude of the six highest spurious emissions relative to the limit. Emissions more than 20 dB below the limit do not need to be reported.

This maximization process was repeated with the EUT positioned in each of its three orthogonal orientations.

#### **The receiver references:**

Frequency of emission (MHz)	RBW/VBW	Sweep Time(s)
30-1000	100KHz/300KHz	5
1000-4000	1MHz/3MHz	15
4000-18000	1MHz/3MHz	40
18000-26500	1MHz/3MHz	20

$P_{Mea}$  is the field strength recorded from the instrument.

The measurement results are obtained as described below:

Result=  $P_{Mea}$  + Cable Loss + Antenna Factor

Where:

$P_{Mea}$  field strength recorded from the instrument

### Average Measurement results

#### GFSK Ch 0

Frequency (MHz)	Measurement Result (dB $\mu$ V/m)	Cable loss (dB)	Antenna Factor (dB/m)	Receiver Reading (dB $\mu$ V)	Limit (dB $\mu$ V/m)	Margin (dB)	Antenna Pol. (H/V)
17990.0	46.3	-25.5	46.7	25.1	54	7.7	V
17998.0	46.3	-25.5	46.7	25.1	54	7.7	V
17955.0	46.2	-25.5	46.7	25.0	54	7.8	V
17963.0	46.1	-25.5	46.7	24.9	54	7.9	V
17974.5	46.1	-25.5	46.7	24.9	54	7.9	V
2385.0	41.3	-20.0	28.1	33.3	54	12.7	V

#### GFSK Ch 39

Frequency (MHz)	Measurement Result (dB $\mu$ V/m)	Cable loss (dB)	Antenna Factor (dB/m)	Receiver Reading (dB $\mu$ V)	Limit (dB $\mu$ V/m)	Margin (dB)	Antenna Pol. (H/V)
17971.5	46.5	-25.5	46.7	25.3	54	7.5	V
17970.5	46.3	-25.5	46.7	25.1	54	7.7	V
17969.0	46.2	-25.5	46.7	25.0	54	7.8	V
17980.5	46.2	-25.5	46.7	25.0	54	7.8	V
17975.5	46.1	-25.5	46.7	24.9	54	7.9	V
17990.5	46.1	-25.5	46.7	24.9	54	7.9	V

#### GFSK Ch 78

Frequency (MHz)	Measurement Result (dB $\mu$ V/m)	Cable loss (dB)	Antenna Factor (dB/m)	Receiver Reading (dB $\mu$ V)	Limit (dB $\mu$ V/m)	Margin (dB)	Antenna Pol. (H/V)
17975.0	46.2	-25.5	46.7	25.0	54	7.8	V
17970.0	46.1	-25.5	46.7	24.9	54	7.9	V
17941.0	46.0	-25.5	46.7	24.8	54	8.0	V
17955.0	46.0	-25.5	46.7	24.8	54	8.0	V
17968.0	46.0	-25.5	46.7	24.8	54	8.0	V
2499.0	41.3	-20.0	28.4	32.9	54	12.7	V

**$\pi/4$  DQPSK Ch 0**

Frequency (MHz)	Measurement Result (dB $\mu$ V/m)	Cable loss (dB)	Antenna Factor (dB/m)	Receiver Reading (dB $\mu$ V)	Limit (dB $\mu$ V/m)	Margin (dB)	Antenna Pol. (H/V)
17955.5	46.5	-25.5	46.7	25.3	54	7.5	V
17984.0	46.4	-25.5	46.7	25.2	54	7.6	V
17971.5	46.2	-25.5	46.7	25.0	54	7.8	V
17952.0	46.1	-25.5	46.7	24.9	54	7.9	V
17984.5	46.1	-25.5	46.7	24.9	54	7.9	V
2386.5	41.4	-20.0	28.1	33.4	54	12.6	V

 **$\pi/4$  DQPSK Ch 39**

Frequency (MHz)	Measurement Result (dB $\mu$ V/m)	Cable loss (dB)	Antenna Factor (dB/m)	Receiver Reading (dB $\mu$ V)	Limit (dB $\mu$ V/m)	Margin (dB)	Antenna Pol. (H/V)
17981.0	46.8	-25.5	46.7	25.6	54	7.2	V
17989.0	46.7	-25.5	46.7	25.5	54	7.3	V
17955.5	46.5	-25.5	46.7	25.3	54	7.5	V
17990.0	46.4	-25.5	46.7	25.2	54	7.6	V
17963.5	46.3	-25.5	46.7	25.1	54	7.7	V
17936.5	46.2	-25.5	46.7	25.0	54	7.8	V

 **$\pi/4$  DQPSK Ch 78**

Frequency (MHz)	Measurement Result (dB $\mu$ V/m)	Cable loss (dB)	Antenna Factor (dB/m)	Receiver Reading (dB $\mu$ V)	Limit (dB $\mu$ V/m)	Margin (dB)	Antenna Pol. (H/V)
17994.5	46.4	-25.5	46.7	25.2	54	7.6	V
17978.5	46.2	-25.5	46.7	25.0	54	7.8	V
17977.0	46.1	-25.5	46.7	24.9	54	7.9	V
17990.5	46.1	-25.5	46.7	24.9	54	7.9	V
17950.0	46.0	-25.5	46.7	24.8	54	8.0	V
2499.4	41.4	-20.0	28.4	33.0	54	12.6	V

**8DPSK Ch 0**

Frequency (MHz)	Measurement Result (dB $\mu$ V/m)	Cable loss (dB)	Antenna Factor (dB/m)	Receiver Reading (dB $\mu$ V)	Limit (dB $\mu$ V/m)	Margin (dB)	Antenna Pol. (H/V)
17954.5	46.3	-25.5	46.7	25.1	54	7.7	V
17972.0	46.3	-25.5	46.7	25.1	54	7.7	V
17964.0	46.2	-25.5	46.7	25.0	54	7.8	V
17943.5	46.1	-25.5	46.7	24.9	54	7.9	V
17948.5	46.1	-25.5	46.7	24.9	54	7.9	V
2382.0	41.4	-20.0	28.1	33.4	54	12.6	V

**8DPSK Ch 39**

Frequency (MHz)	Measurement Result (dB $\mu$ V/m)	Cable loss (dB)	Antenna Factor (dB/m)	Receiver Reading (dB $\mu$ V)	Limit (dB $\mu$ V/m)	Margin (dB)	Antenna Pol. (H/V)
17970.0	46.4	-25.5	46.7	25.2	54	7.6	V
17969.0	46.3	-25.5	46.7	25.1	54	7.7	V
17978.5	46.2	-25.5	46.7	25.0	54	7.8	V
17979.5	46.2	-25.5	46.7	25.0	54	7.8	V
17881.5	46.1	-25.5	46.7	24.9	54	7.9	V
17953.5	46.1	-25.5	46.7	24.9	54	7.9	V

**8DPSK Ch 78**

Frequency (MHz)	Measurement Result (dB $\mu$ V/m)	Cable loss (dB)	Antenna Factor (dB/m)	Receiver Reading (dB $\mu$ V)	Limit (dB $\mu$ V/m)	Margin (dB)	Antenna Pol. (H/V)
17985.0	46.3	-25.5	46.7	25.1	54	7.7	V
17975.5	46.2	-25.5	46.7	25.0	54	7.8	V
17949.5	46.1	-25.5	46.7	24.9	54	7.9	V
17964.0	46.1	-25.5	46.7	24.9	54	7.9	V
17994.0	46.1	-25.5	46.7	24.9	54	7.9	V
2499.6	41.5	-20.0	28.4	33.1	54	12.5	V

**Peak Measurement results**
**GFSK Ch 0**

Frequency (MHz)	Measurement Result (dB $\mu$ V/m)	Cable loss (dB)	Antenna Factor (dB/m)	Receiver Reading (dB $\mu$ V)	Limit (dB $\mu$ V/m)	Margin (dB)	Antenna Pol. (H/V)
17926.5	57.2	-25.5	46.7	36.0	74	16.8	V
17957.5	56.9	-25.5	46.7	35.7	74	17.1	V
17991.5	56.8	-25.5	46.7	35.6	74	17.2	V
17981.5	56.7	-25.5	46.7	35.5	74	17.3	V
17948.0	56.6	-25.5	46.7	35.4	74	17.4	V
2332.2	54.0	-20.1	28.0	46.1	74	20.0	H

**GFSK Ch 39**

Frequency (MHz)	Measurement Result (dB $\mu$ V/m)	Cable loss (dB)	Antenna Factor (dB/m)	Receiver Reading (dB $\mu$ V)	Limit (dB $\mu$ V/m)	Margin (dB)	Antenna Pol. (H/V)
17971.5	57.6	-25.5	46.7	36.4	74	16.4	V
17935.5	56.8	-25.5	46.7	35.6	74	17.2	V
17964.5	56.8	-25.5	46.7	35.6	74	17.2	V
17965.5	56.8	-25.5	46.7	35.6	74	17.2	V
17999.0	56.6	-25.5	46.7	35.4	74	17.4	V
17871.5	56.4	-25.5	46.7	35.2	74	17.6	V

**GFSK Ch 78**

Frequency (MHz)	Measurement Result (dB $\mu$ V/m)	Cable loss (dB)	Antenna Factor (dB/m)	Receiver Reading (dB $\mu$ V)	Limit (dB $\mu$ V/m)	Margin (dB)	Antenna Pol. (H/V)
17981.5	56.9	-25.5	46.7	35.7	74	17.1	V
17857.5	56.8	-25.5	46.7	35.6	74	17.2	V
17876.5	56.8	-25.5	46.7	35.6	74	17.2	V
17875.5	56.7	-25.5	46.7	35.5	74	17.3	V
17995.5	56.7	-25.5	46.7	35.5	74	17.3	V
2487.2	54.0	-20.0	28.3	45.7	74	20.0	H



**$\pi/4$  DQPSK Ch 0**

Frequency (MHz)	Measurement Result (dB $\mu$ V/m)	Cable loss (dB)	Antenna Factor (dB/m)	Receiver Reading (dB $\mu$ V)	Limit (dB $\mu$ V/m)	Margin (dB)	Antenna Pol. (H/V)
17902.5	57.4	-25.5	46.7	36.2	74	16.6	V
17962.0	56.9	-25.5	46.7	35.7	74	17.1	V
17980.5	56.8	-25.5	46.7	35.6	74	17.2	V
17987.5	56.7	-25.5	46.7	35.5	74	17.3	V
17972.5	56.6	-25.5	46.7	35.4	74	17.4	V
2386.1	53.9	-20.0	28.1	45.9	74	20.1	H

 **$\pi/4$  DQPSK Ch 39**

Frequency (MHz)	Measurement Result (dB $\mu$ V/m)	Cable loss (dB)	Antenna Factor (dB/m)	Receiver Reading (dB $\mu$ V)	Limit (dB $\mu$ V/m)	Margin (dB)	Antenna Pol. (H/V)
17582.0	57.2	-25.7	46.0	37.0	74	16.8	V
17992.5	57.0	-25.5	46.7	35.8	74	17.0	V
17778.0	56.9	-25.5	46.7	35.7	74	17.1	V
17851.5	56.8	-25.5	46.7	35.6	74	17.2	V
17939.5	56.8	-25.5	46.7	35.6	74	17.2	V
17946.0	56.7	-25.5	46.7	35.5	74	17.3	V

 **$\pi/4$  DQPSK Ch 78**

Frequency (MHz)	Measurement Result (dB $\mu$ V/m)	Cable loss (dB)	Antenna Factor (dB/m)	Receiver Reading (dB $\mu$ V)	Limit (dB $\mu$ V/m)	Margin (dB)	Antenna Pol. (H/V)
17996.5	57.2	-25.5	46.7	36.0	74	16.8	V
17919.0	57.1	-25.5	46.7	35.9	74	16.9	V
17974.5	57.1	-25.5	46.7	35.9	74	16.9	V
17953.0	56.9	-25.5	46.7	35.7	74	17.1	V
17893.5	56.6	-25.5	46.7	35.4	74	17.4	V
2493.0	53.9	-20.0	28.3	45.6	74	20.1	V

**8DPSK Ch 0**

Frequency (MHz)	Measurement Result (dB $\mu$ V/m)	Cable loss (dB)	Antenna Factor (dB/m)	Receiver Reading (dB $\mu$ V)	Limit (dB $\mu$ V/m)	Margin (dB)	Antenna Pol. (H/V)
17909.5	57.1	-25.5	46.7	35.9	74	16.9	V
17966.5	56.9	-25.5	46.7	35.7	74	17.1	V
17983.0	56.8	-25.5	46.7	35.6	74	17.2	V
17872.0	56.7	-25.5	46.7	35.5	74	17.3	V
17874.0	56.7	-25.5	46.7	35.5	74	17.3	V
2351.3	55.0	-20.1	28.0	47.1	74	19.0	V

**8DPSK Ch 39**

Frequency (MHz)	Measurement Result (dB $\mu$ V/m)	Cable loss (dB)	Antenna Factor (dB/m)	Receiver Reading (dB $\mu$ V)	Limit (dB $\mu$ V/m)	Margin (dB)	Antenna Pol. (H/V)
17976.0	57.4	-25.5	46.7	36.2	74	16.6	V
17927.0	57.3	-25.5	46.7	36.1	74	16.7	V
17827.0	56.9	-25.5	46.7	35.7	74	17.1	V
17981.5	56.9	-25.5	46.7	35.7	74	17.1	V
17871.0	56.8	-25.5	46.7	35.6	74	17.2	V
17958.5	56.5	-25.5	46.7	35.3	74	17.5	V

**8DPSK Ch 78**

Frequency (MHz)	Measurement Result (dB $\mu$ V/m)	Cable loss (dB)	Antenna Factor (dB/m)	Receiver Reading (dB $\mu$ V)	Limit (dB $\mu$ V/m)	Margin (dB)	Antenna Pol. (H/V)
17989.0	57.5	-25.5	46.7	36.3	74	16.5	V
17792.0	57.0	-25.5	46.7	35.8	74	17.0	V
17954.0	57.0	-25.5	46.7	35.8	74	17.0	V
17772.0	56.7	-25.5	46.7	35.5	74	17.3	V
17976.0	56.6	-25.5	46.7	35.4	74	17.4	V
2493.0	54.5	-20.0	28.3	46.2	74	19.5	V

**Conclusion: Pass**

## B.7. Time of Occupancy (Dwell Time)

**Method of Measurement: See ANSI C63.10-clause 7.8.4**

The EUT must have its hopping function enabled. Use the following spectrum analyzer settings:

- Span = zero span, centered on a hopping channel
- RBW = 1 MHz
- VBW  $\geq$  RBW
- Sweep = as necessary to capture the entire dwell time per hopping channel
- Detector function = peak
- Trace = max hold

Measure a pulse time in time domain at middle frequency and then count the hopping number in 31.6s(which equals with 0.4 multiply 79) of middle frequency ,then multiply the pulse time and hopping number and record them.

### Measurement Limit:

Standard	Limit (ms)
FCC 47 CFR Part 15.247(a) (1)(iii)	< 400

### Measurement Result:

#### For GFSK

Channel	Packet	Pulse time (ms)		Number of Transmissions		Dwell Time (ms)	Conclusion
		Fig.	Value	Fig.	Value		
39	DH1	Fig.64	0.38	Fig.65	319	121.22	P
	DH3	Fig.66	1.64	Fig.67	102	167.28	P
	DH5	Fig.68	2.89	Fig.69	70	202.3	P

#### For $\pi/4$ DQPSK

Channel	Packet	Pulse time (ms)		Number of Transmissions		Dwell Time (ms)	Conclusion
		Fig.	Value	Fig.	Value		
39	2DH1	Fig.70	0.39	Fig.71	319	124.41	P
	2DH3	Fig.72	1.64	Fig.73	101	165.64	P
	2DH5	Fig.74	2.89	Fig.75	53	153.17	P

**For 8DPSK**

Channel	Packet	Pulse time (ms)		Number of Transmissions		Dwell Time (ms)	Conclusion
		Fig.	Value	Fig.	Value		
39	3DH1	Fig.76	0.39	Fig.77	319	124.41	P
	3DH3	Fig.78	1.64	Fig.79	106	173.84	P
	3DH5	Fig.80	2.89	Fig.81	56	161.84	P

**Conclusion: PASS**

**Test graphs as below:**

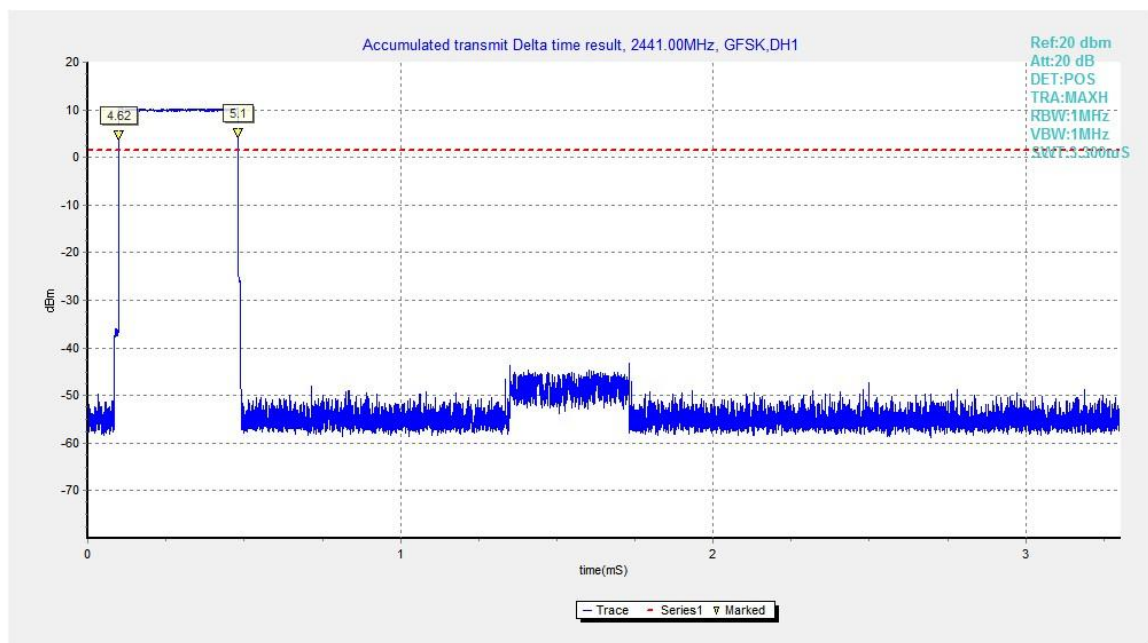

Fig.64. Time of occupancy (Dwell Time): Channel 39, Packet DH1

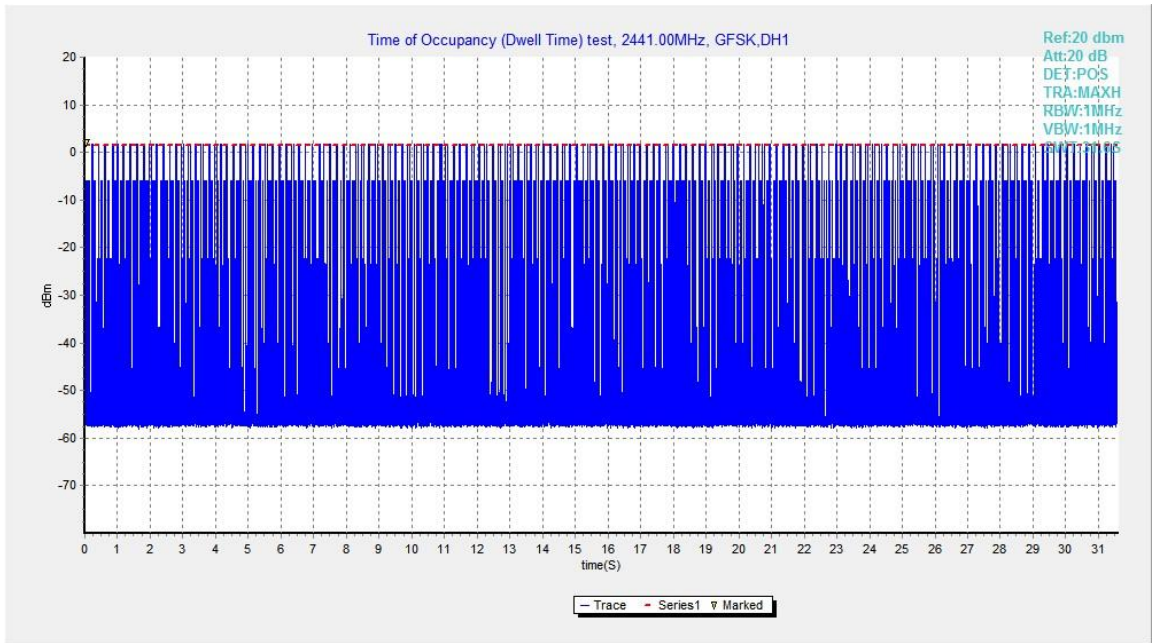

Fig.65. Number of Transmissions Measurement: Channel 39,Packet DH1

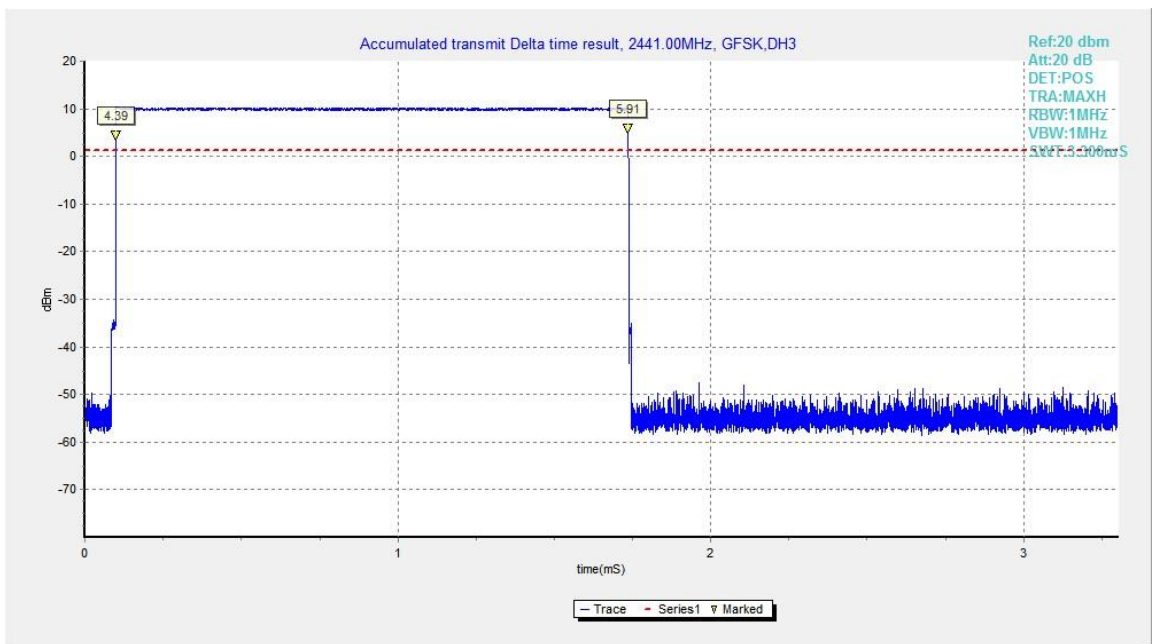

Fig.66. Time of occupancy (Dwell Time): Channel 39, Packet DH3

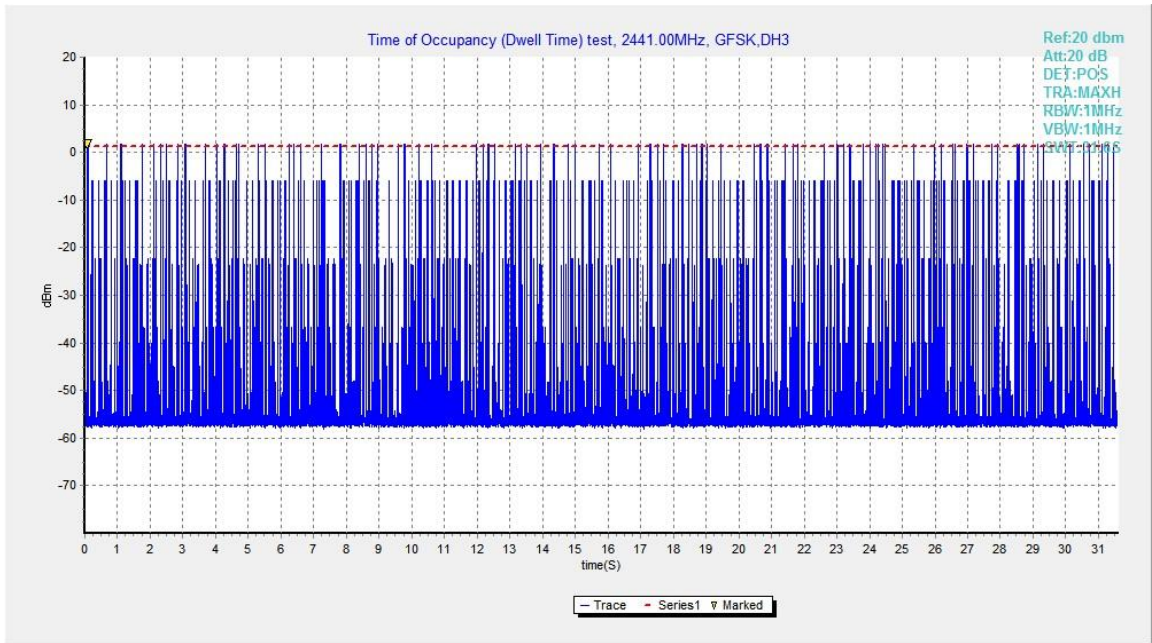

Fig.67. Number of Transmissions Measurement: Channel 39,Packet DH3

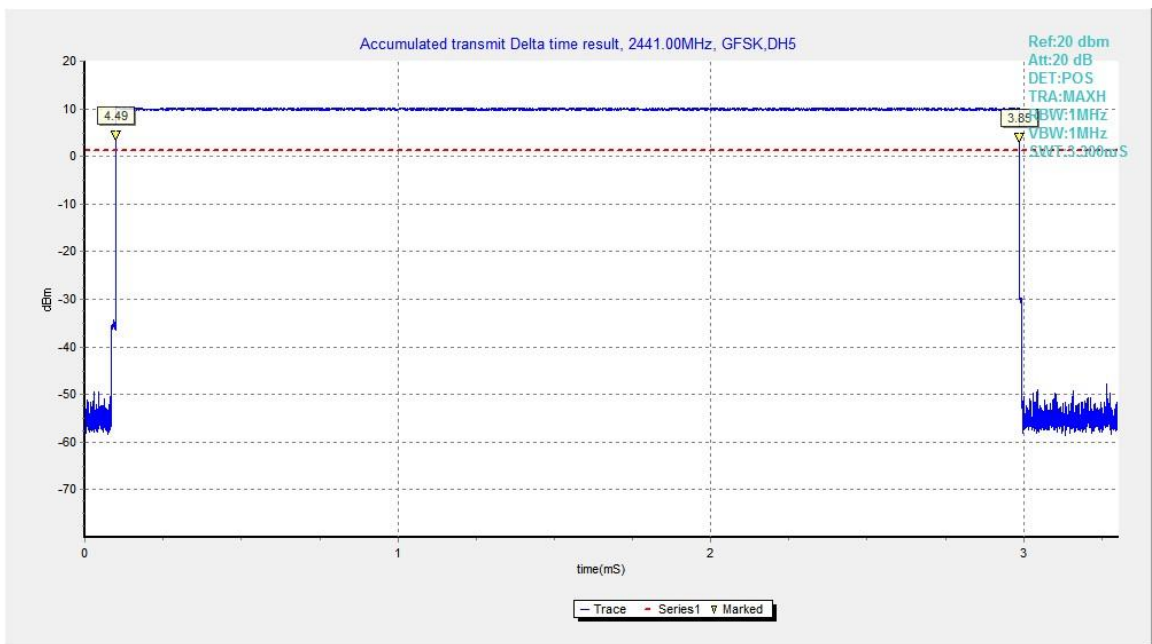

Fig.68. Time of occupancy (Dwell Time): Channel 39, Packet DH5

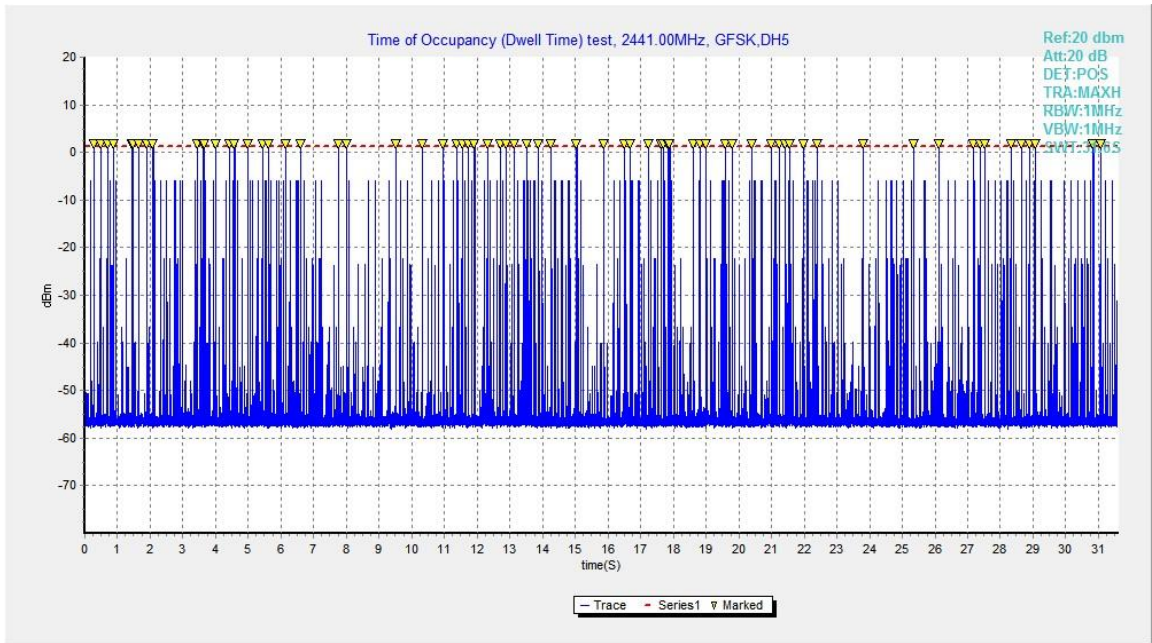

Fig.69. Number of Transmissions Measurement: Channel 39,Packet DH5

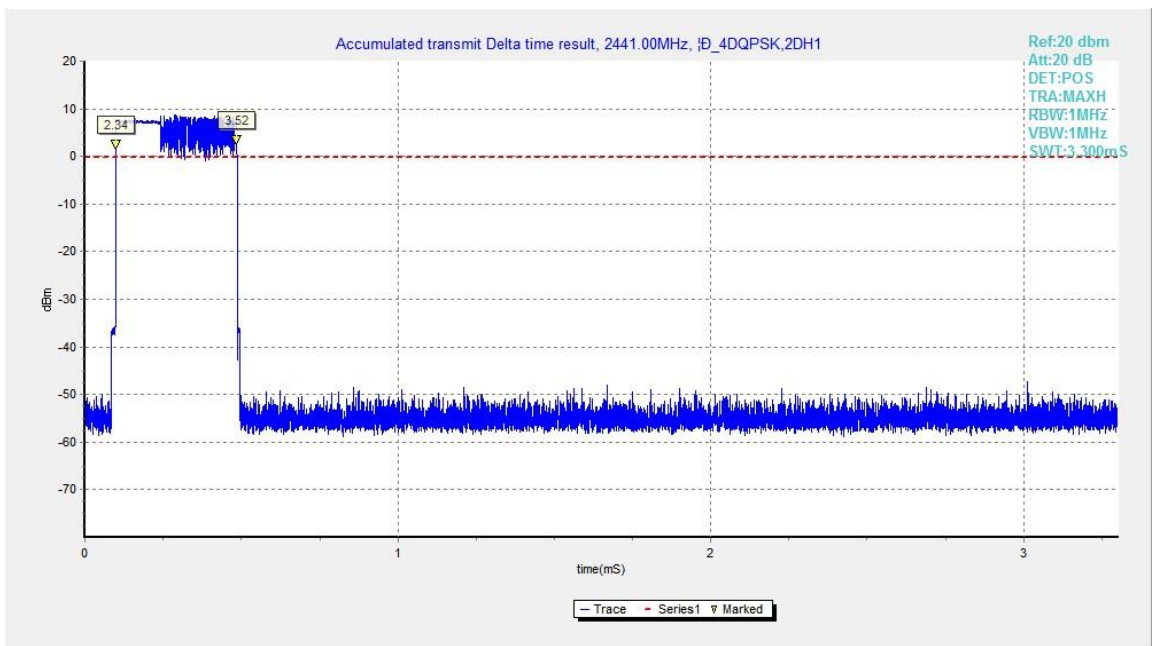

Fig.70. Time of occupancy (Dwell Time): Channel 39, Packet 2-DH1

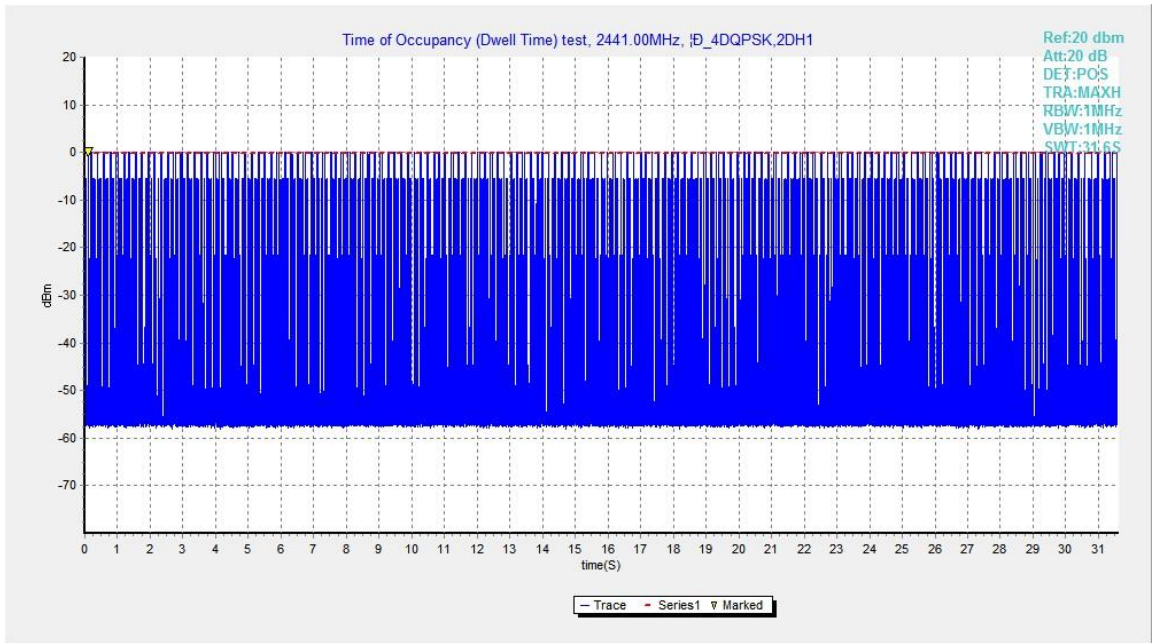

Fig.71. Number of Transmissions Measurement: Channel 39,Packet 2-DH1

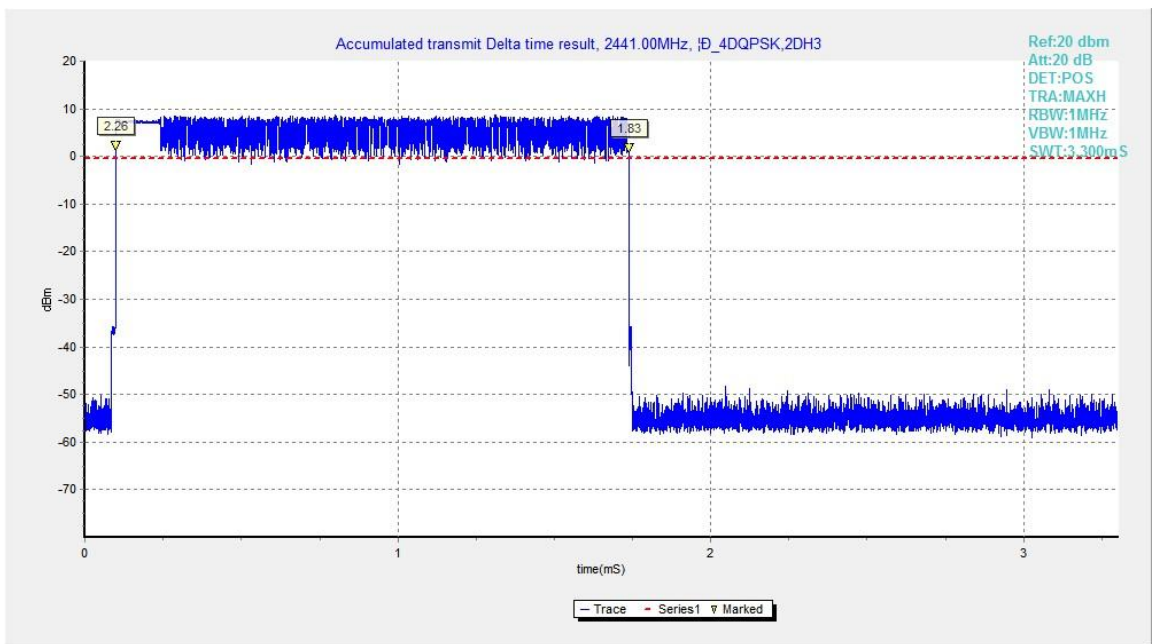

Fig.72. Time of occupancy (Dwell Time): Channel 39, Packet 2-DH3



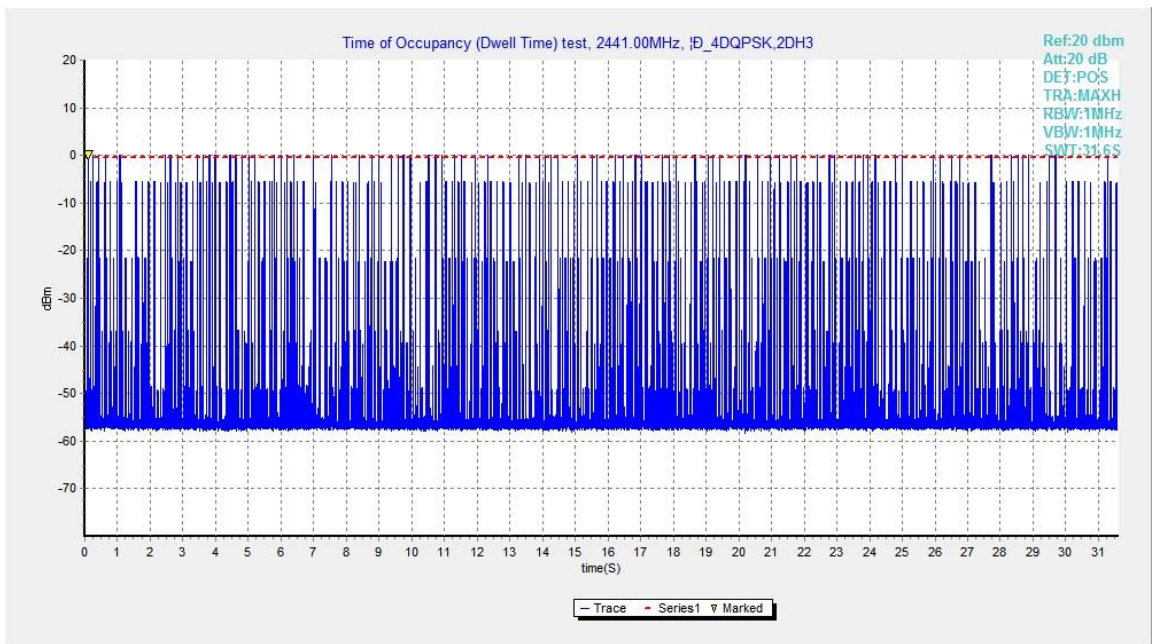

Fig.73. Number of Transmissions Measurement: Channel 39, Packet 2-DH3

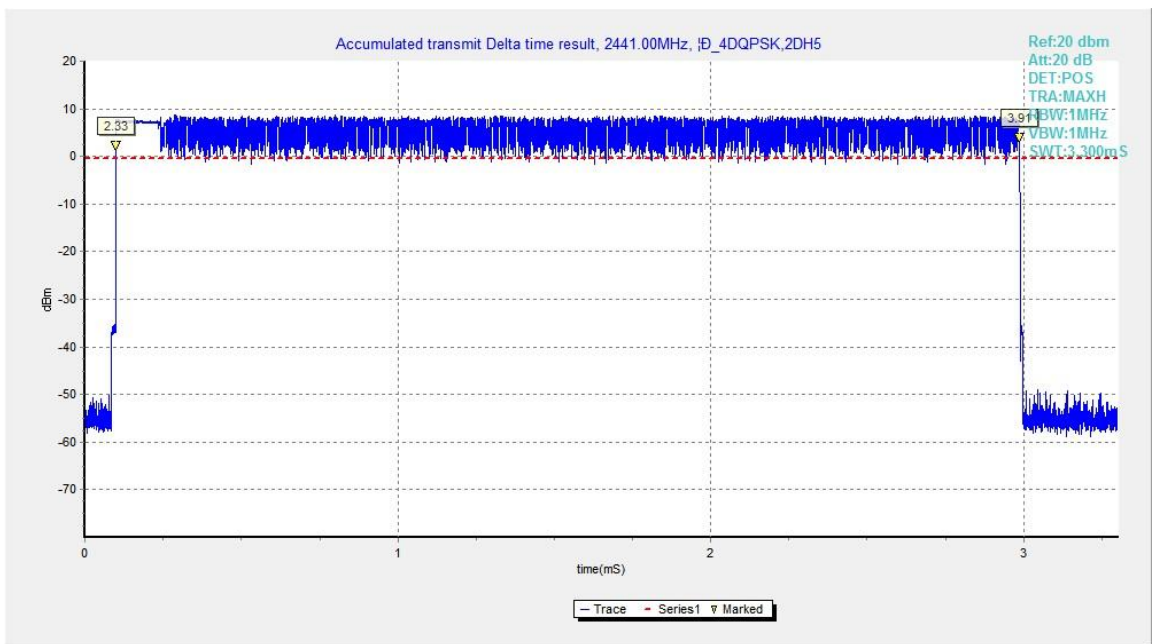

Fig.74. Time of occupancy (Dwell Time): Channel 39, Packet 2-DH5

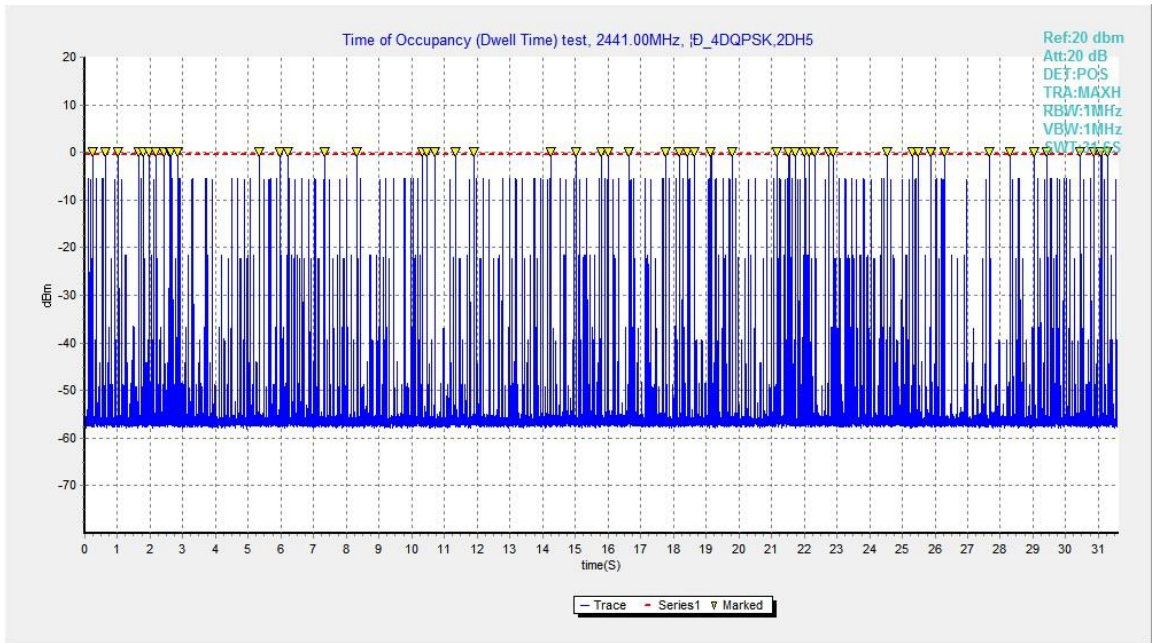

Fig.75. Number of Transmissions Measurement: Channel 39,Packet 2-DH5

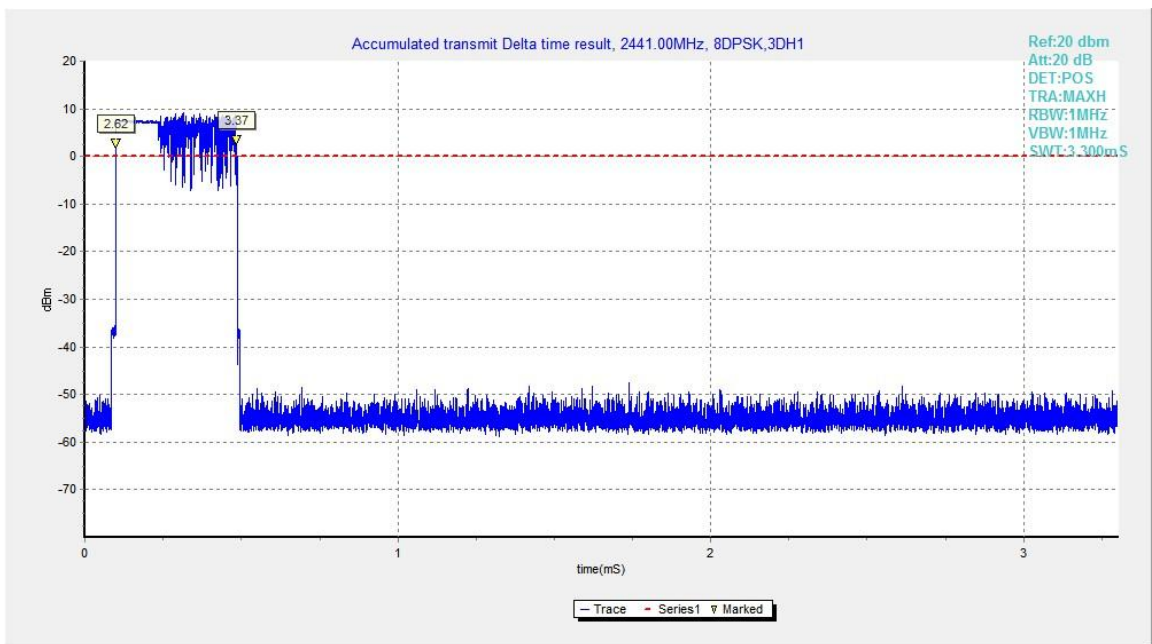

Fig.76. Time of occupancy (Dwell Time): Channel 39, Packet 3-DH1

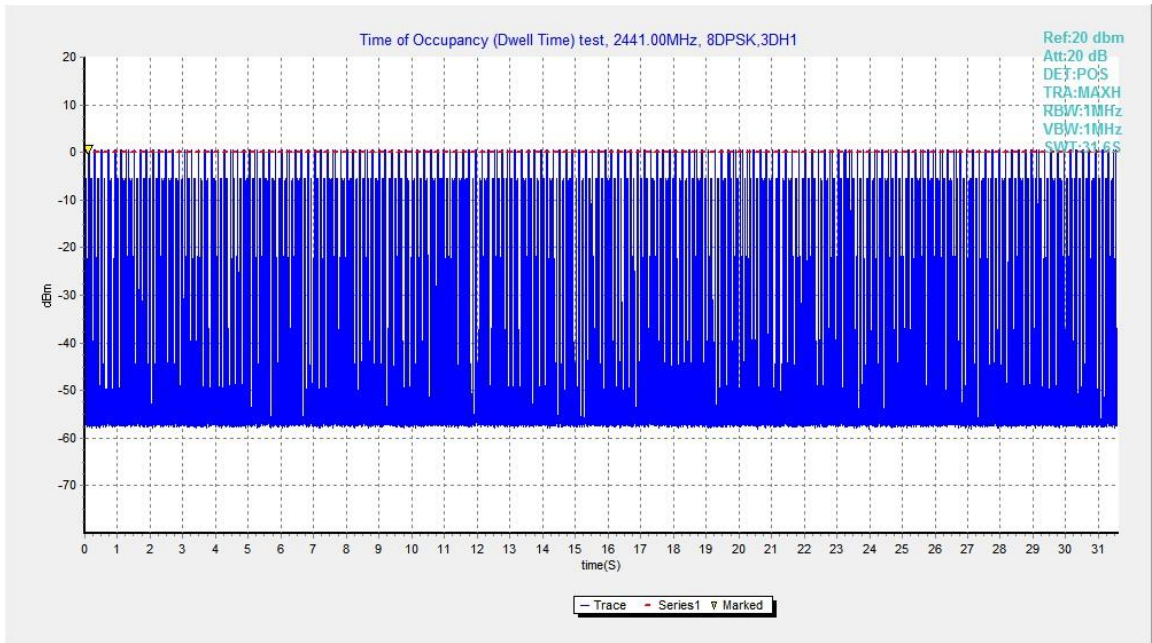

Fig.77. Number of Transmissions Measurement: Channel 39,Packet 3-DH1

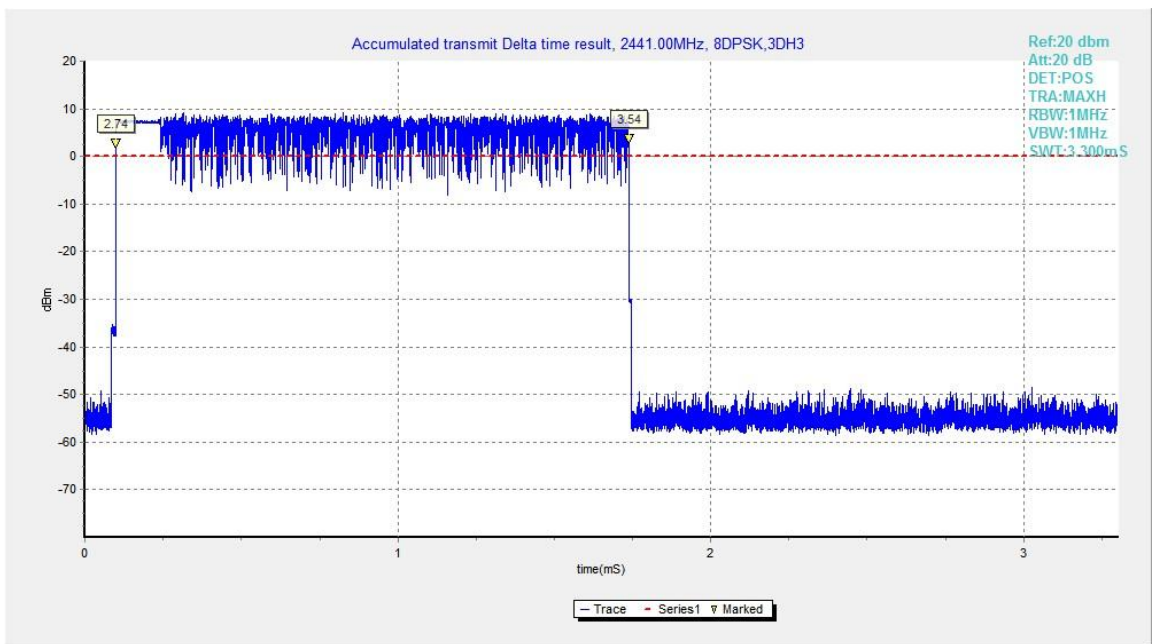

Fig.78. Time of occupancy (Dwell Time): Channel 39, Packet 3-DH3

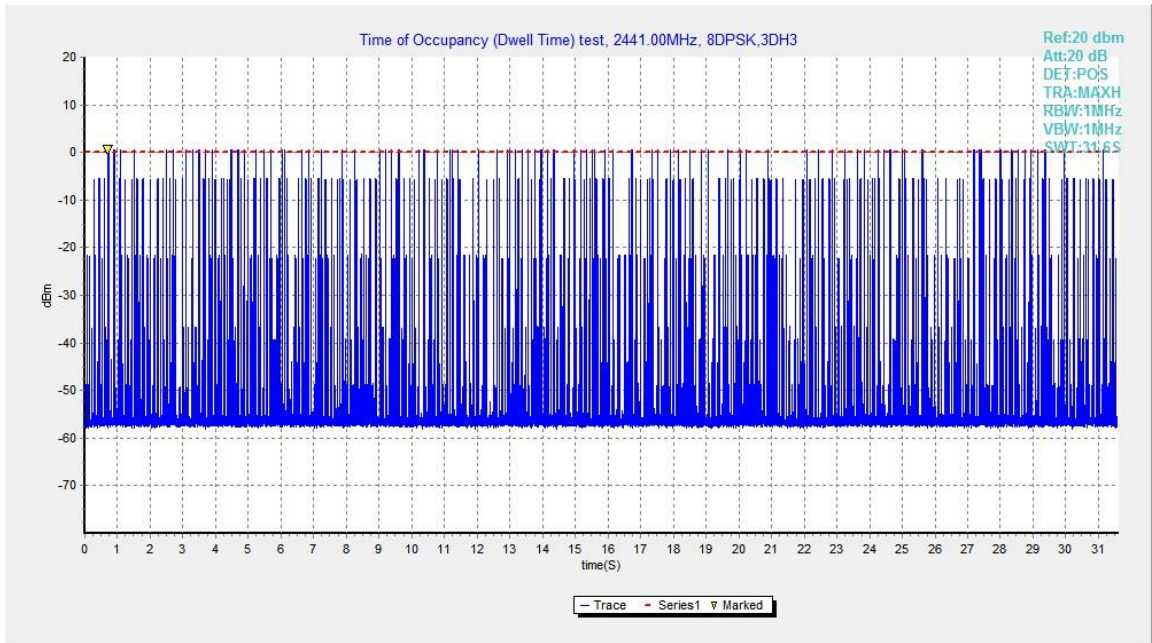

Fig.79. Number of Transmissions Measurement: Channel 39,Packet 3-DH3

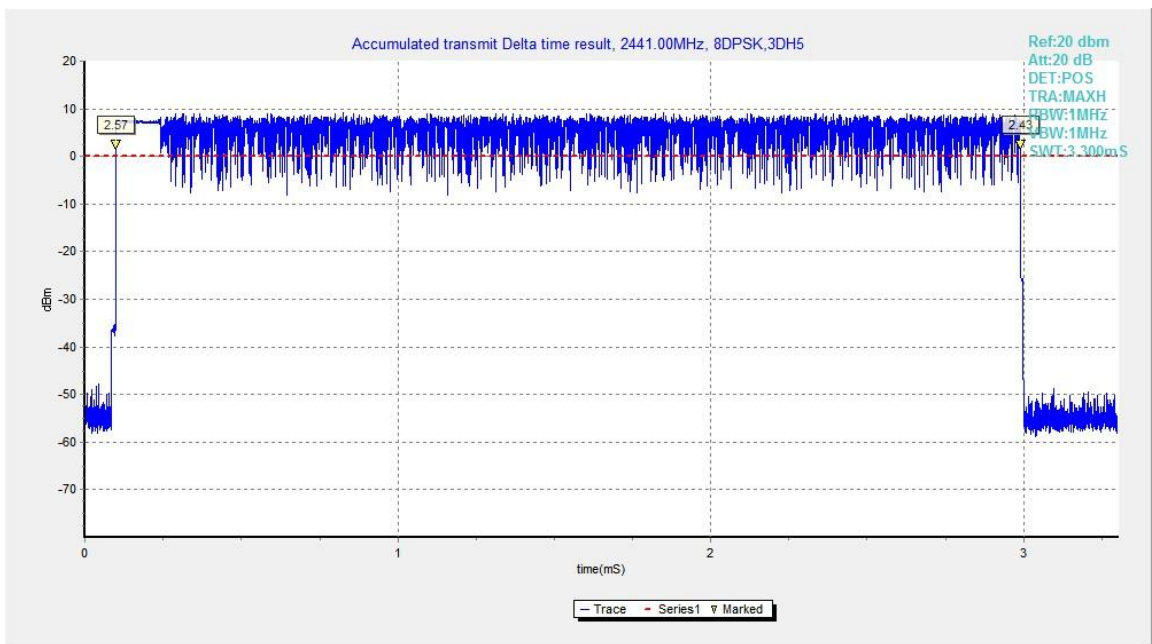

Fig.80. Time of occupancy (Dwell Time): Channel 39, Packet 3-DH5

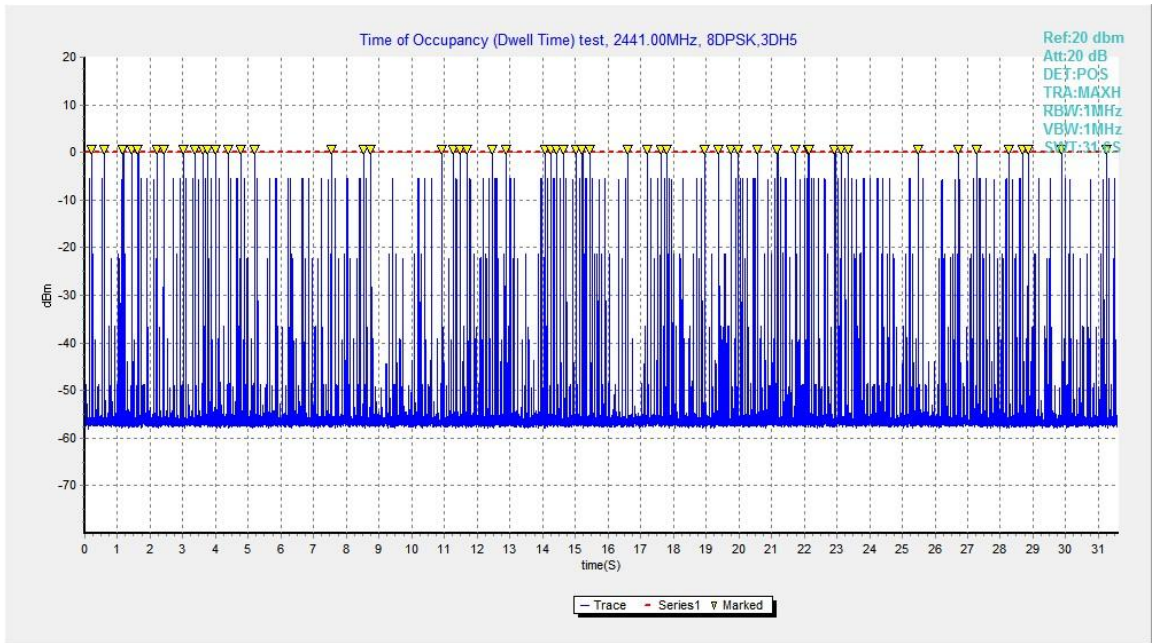

Fig.81. Number of Transmissions Measurement: Channel 39,Packet 3-DH5

## B.8. 20dB Bandwidth

**Method of Measurement: See ANSI C63.10-clause 6.9.2**

Measurement Procedure - Unwanted Emissions

1. Set RBW = 30kHz.
2. Set VBW = 100 kHz.
3. Set span to 3MHz
4. Detector = peak.
5. Trace Mode = max hold.
6. Sweep = auto couple.
7. Allow the trace to stabilize (this may take some time, depending on the extent of the span).

### Measurement Limit:

Standard	Limit
FCC 47 CFR Part 15.247(a)(1)	NA *

Use NdB Down function of the SA to measure the 20dB Bandwidth

\* Comment: This test case is not required according to the latest FCC 47 CFR Part 15.247. But the test results are necessary for “carrier frequency separation” test case, in Annex A.8.

### Measurement Results:

#### For GFSK

Channel	20dB Bandwidth (kHz)		Conclusion
0	Fig.82	933.00	NA
39	Fig.83	925.50	NA
78	Fig.84	921.00	NA

#### For $\pi/4$ DQPSK

Channel	20dB Bandwidth (kHz)		Conclusion
0	Fig.85	1312.50	NA
39	Fig.86	1281.00	NA
78	Fig.87	1309.50	NA

#### For 8DPSK

Channel	20dB Bandwidth (kHz)		Conclusion
0	Fig.88	1278.00	NA
39	Fig.89	1276.50	NA
78	Fig.90	1280.25	NA

**Conclusion: NA**

**Test graphs as below:**

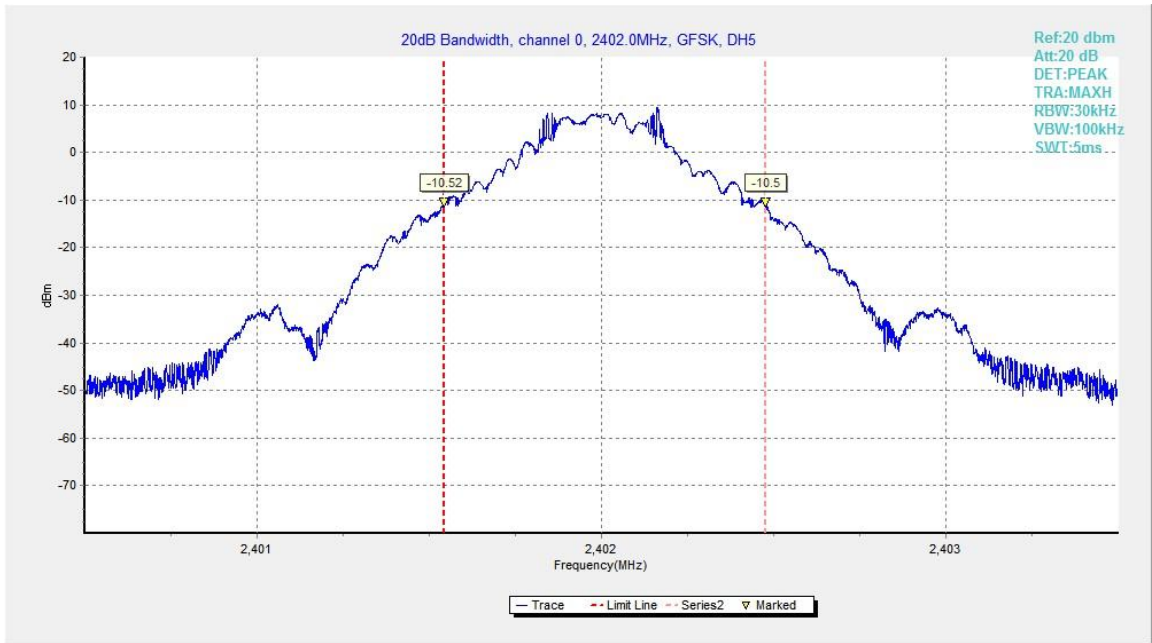

Fig.82. 20dB Bandwidth: GFSK, Channel 0

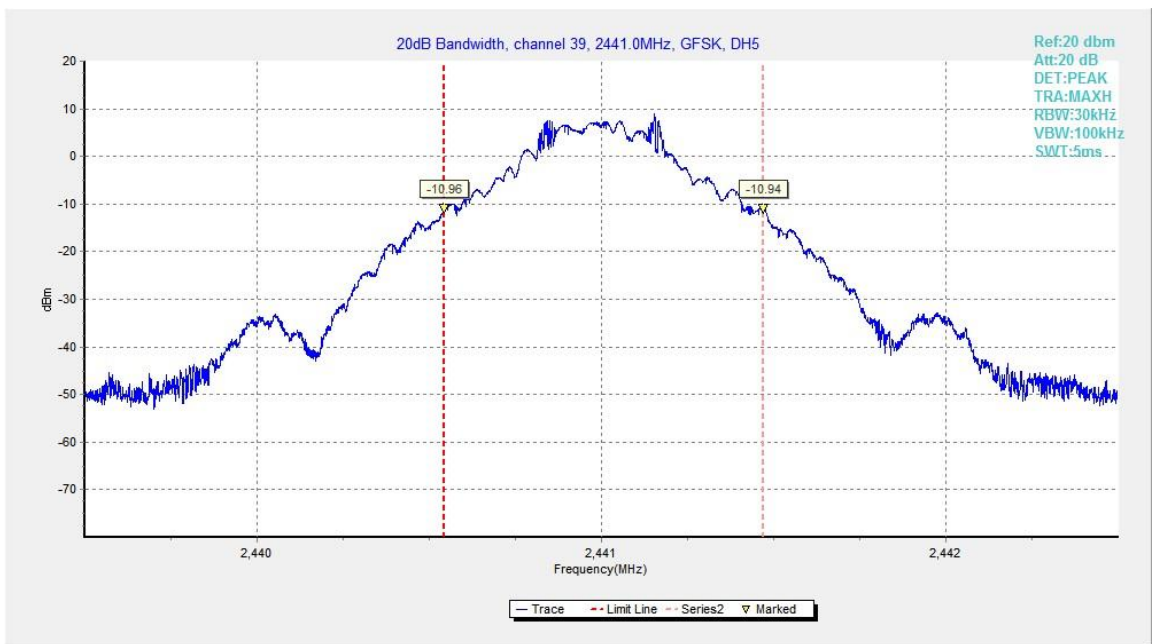

Fig.83. 20dB Bandwidth: GFSK, Channel 39

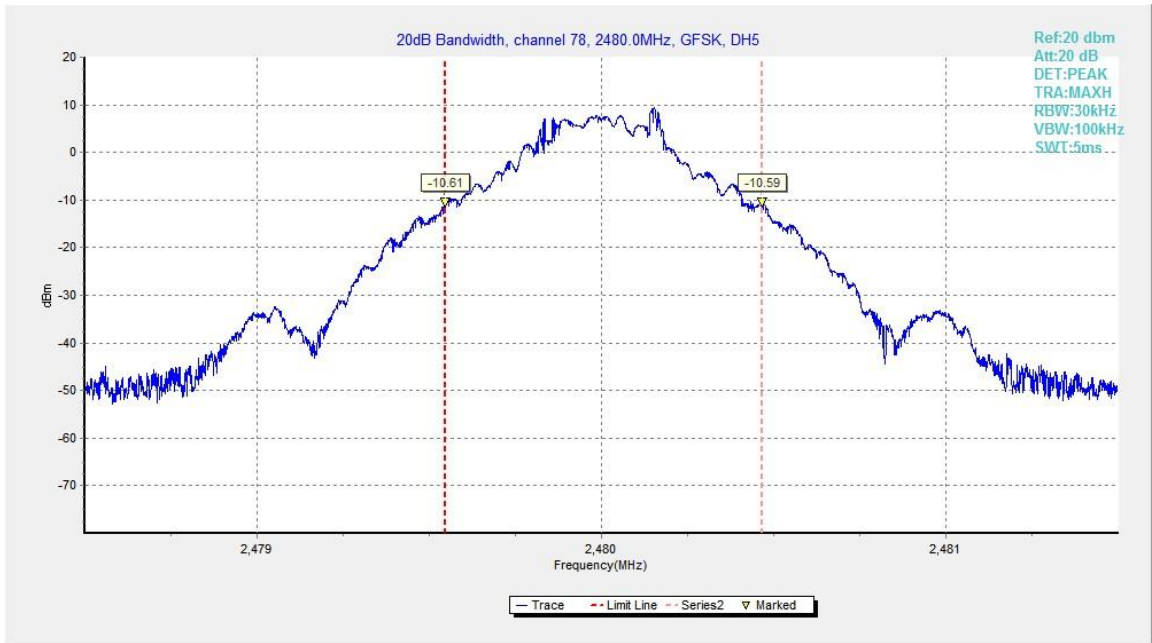

Fig.84. 20dB Bandwidth: GFSK, Channel 78

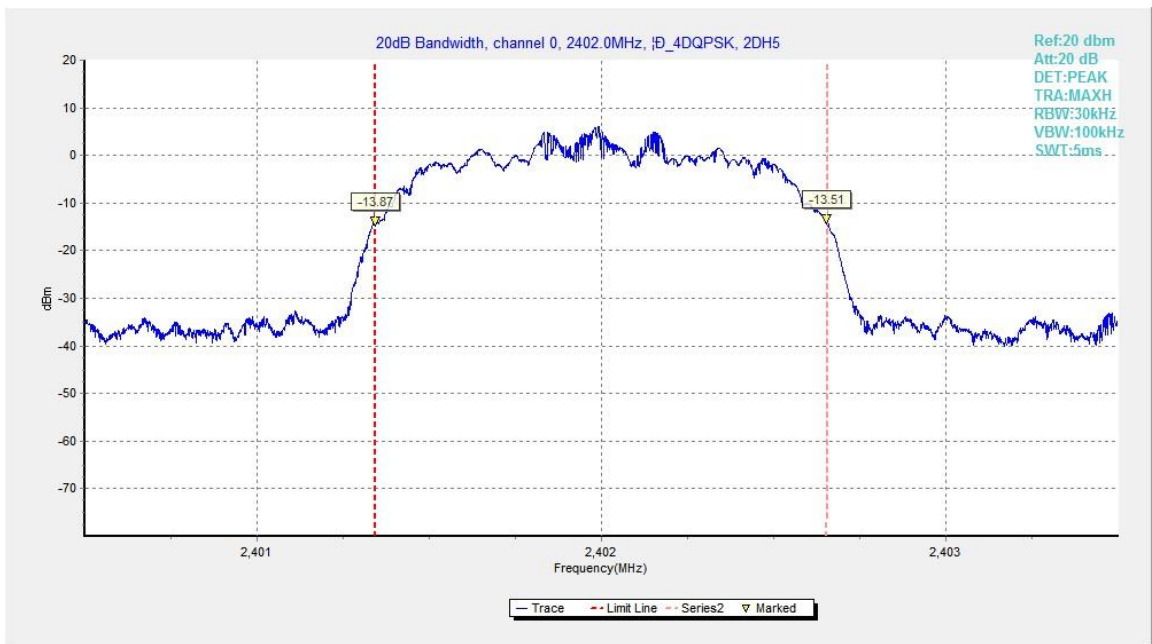

Fig.85. 20dB Bandwidth:  $\pi/4$  DQPSK, Channel 0



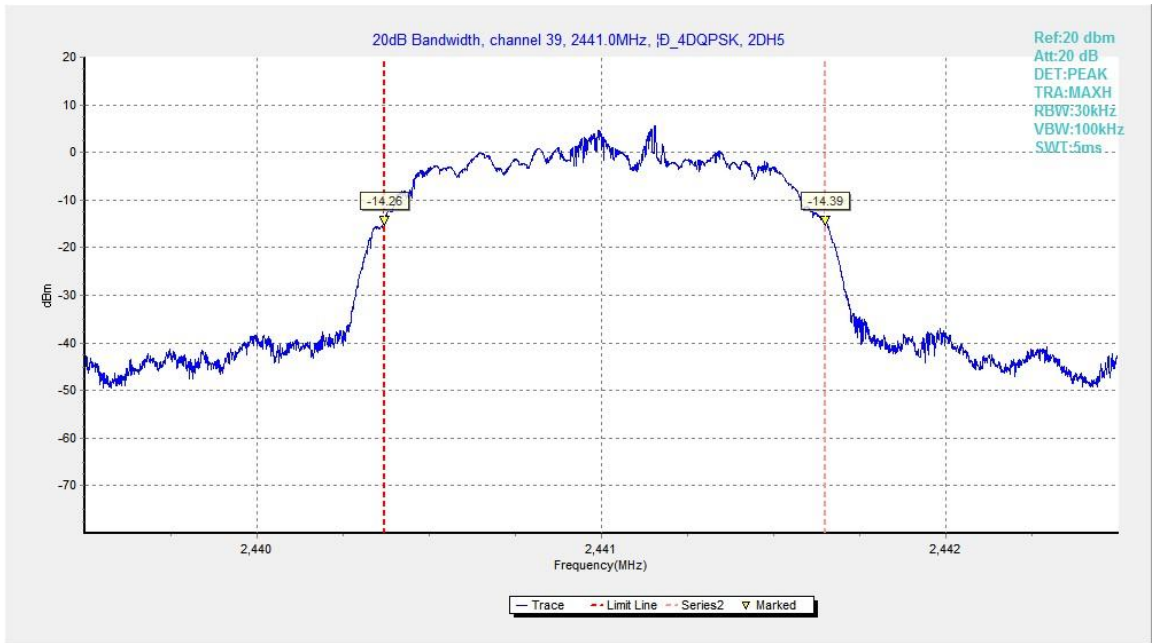

Fig.86. 20dB Bandwidth:  $\pi/4$  DQPSK, Channel 39

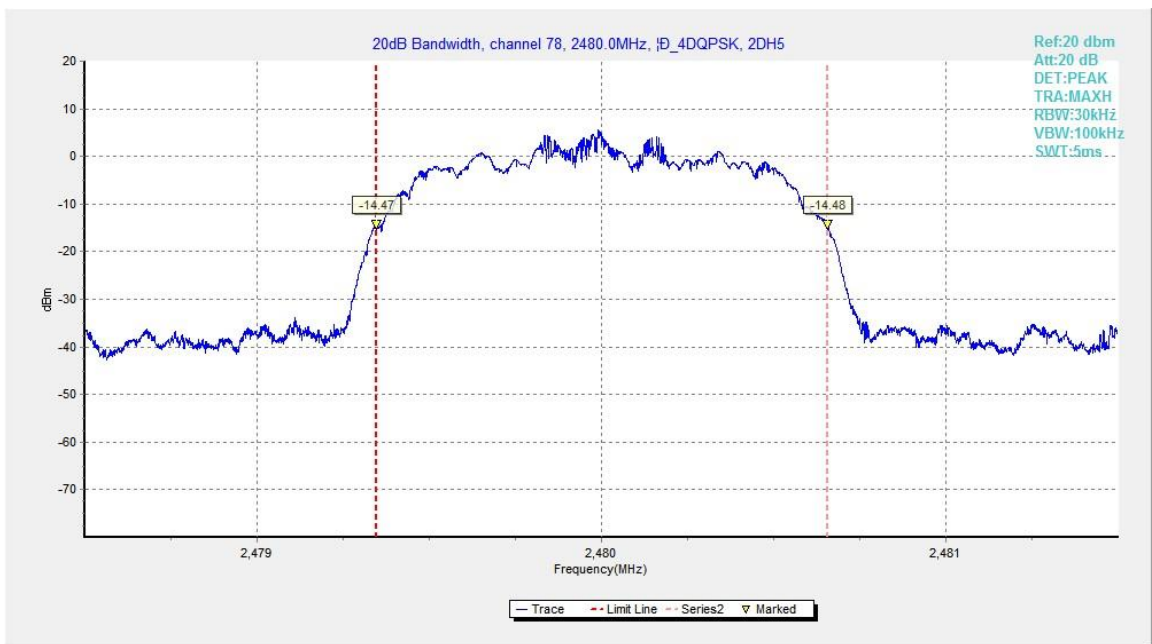

Fig.87. 20dB Bandwidth:  $\pi/4$  DQPSK, Channel 78

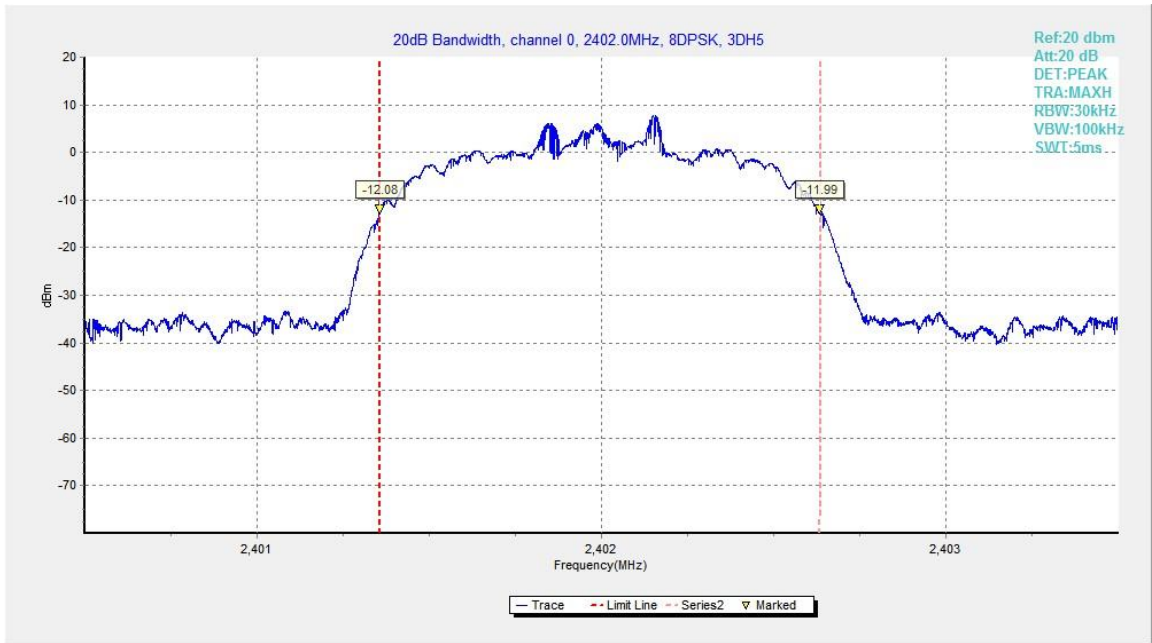

Fig.88. 20dB Bandwidth: 8DPSK, Channel 0

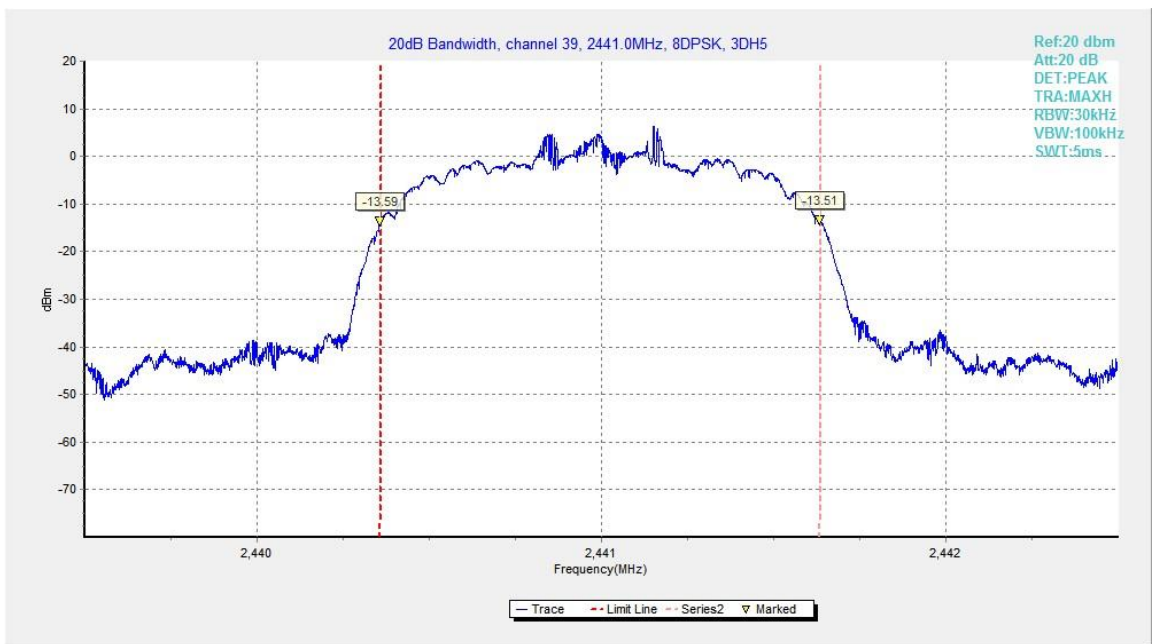

Fig.89. 20dB Bandwidth: 8DPSK, Channel 39

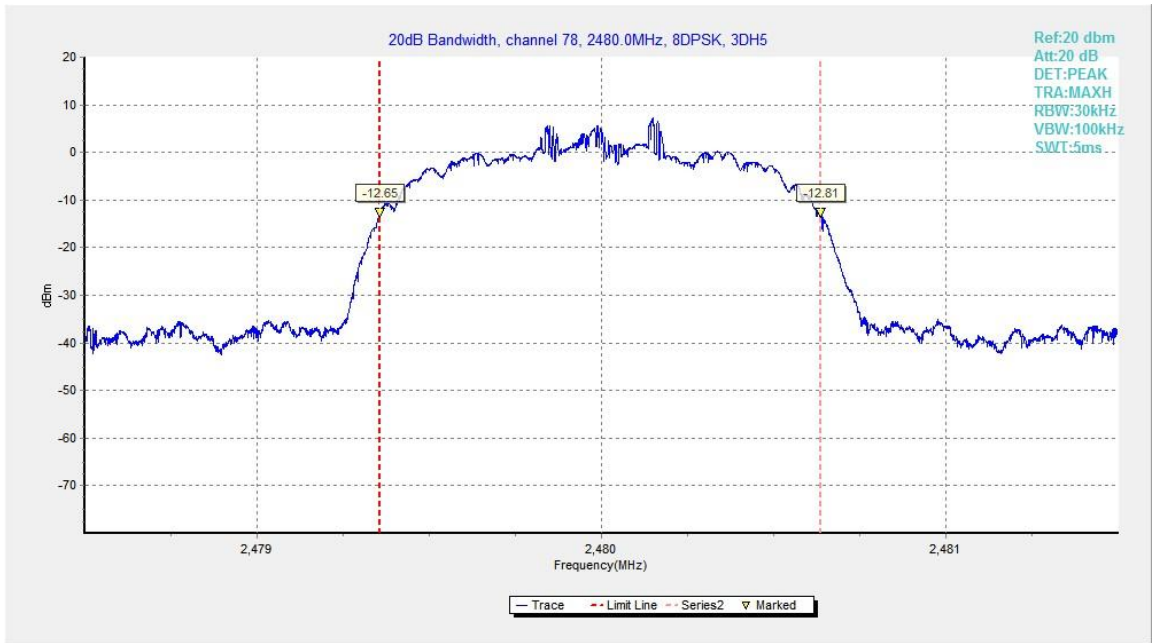

Fig.90. 20dB Bandwidth: 8DPSK, Channel 78

## B.9. Carrier Frequency Separation

**Method of Measurement: See ANSI C63.10-clause 7.8.2**

The EUT must have its hopping function enabled. Use the following spectrum analyzer settings:

- Span = 3MHz
- RBW=300kHz
- VBW=300kHz
- Sweep = auto
- Detector function = peak
- Trace = max hold
- Allow the trace to stabilize

Search the peak marks of the middle frequency and adjacent channel, then record the separation between them.

\* Comment: This limit should be over 25 kHz or  $(2/3) * 20\text{dB}$  bandwidth, whichever is greater.

### Measurement Limit:

Standard	Limit(kHz)
FCC 47 CFR Part 15.247(a)(1)	over 25 kHz or $(2/3) * 20\text{dB}$ bandwidth

### Measurement Result:

#### For GFSK

Channel	Carrier frequency separation (kHz)	Conclusion	
39	Fig.91	1022.25	P

#### For $\pi/4$ DQPSK

Channel	Carrier frequency separation (kHz)	Conclusion	
39	Fig.92	1153.50	P

#### For 8DPSK

Channel	Carrier frequency separation (kHz)	Conclusion	
39	Fig.93	1142.25	P

**Conclusion: PASS**

**Test graphs as below:**

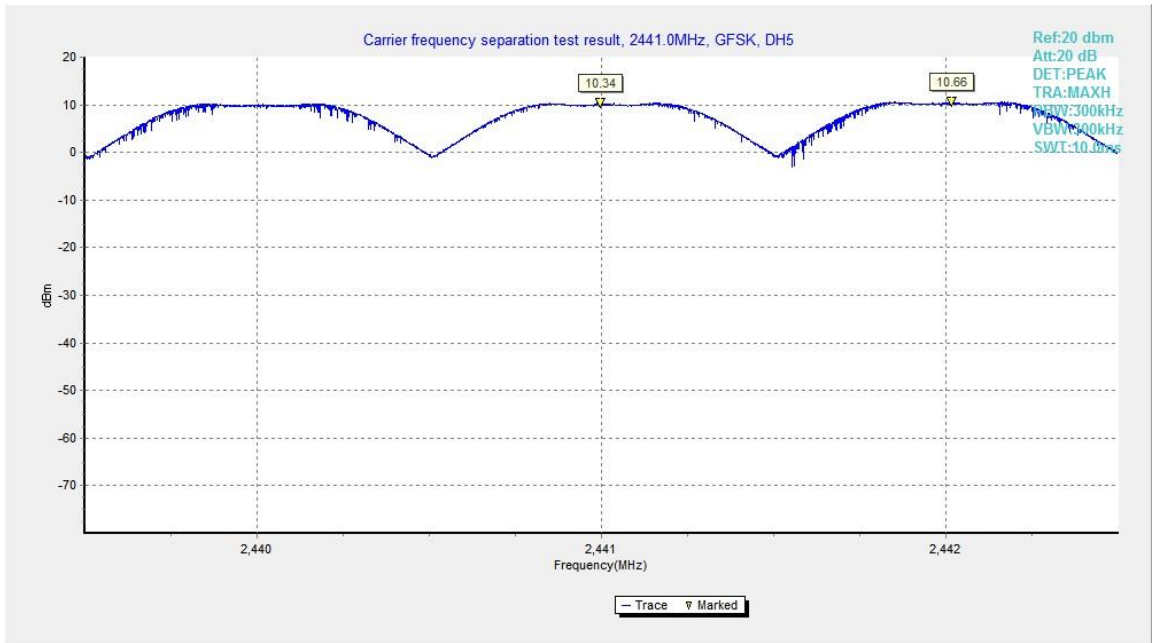

Fig.91. Carrier frequency separation measurement: GFSK, Channel 39

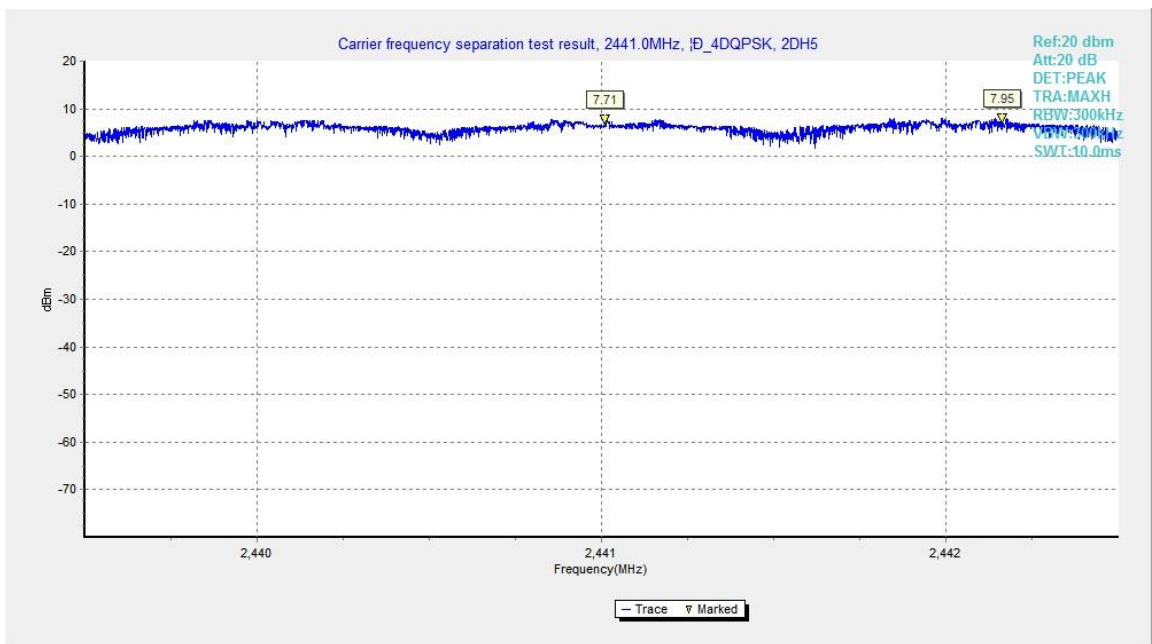

Fig.92. Carrier frequency separation measurement:  $\pi/4$  DQPSK, Channel 39

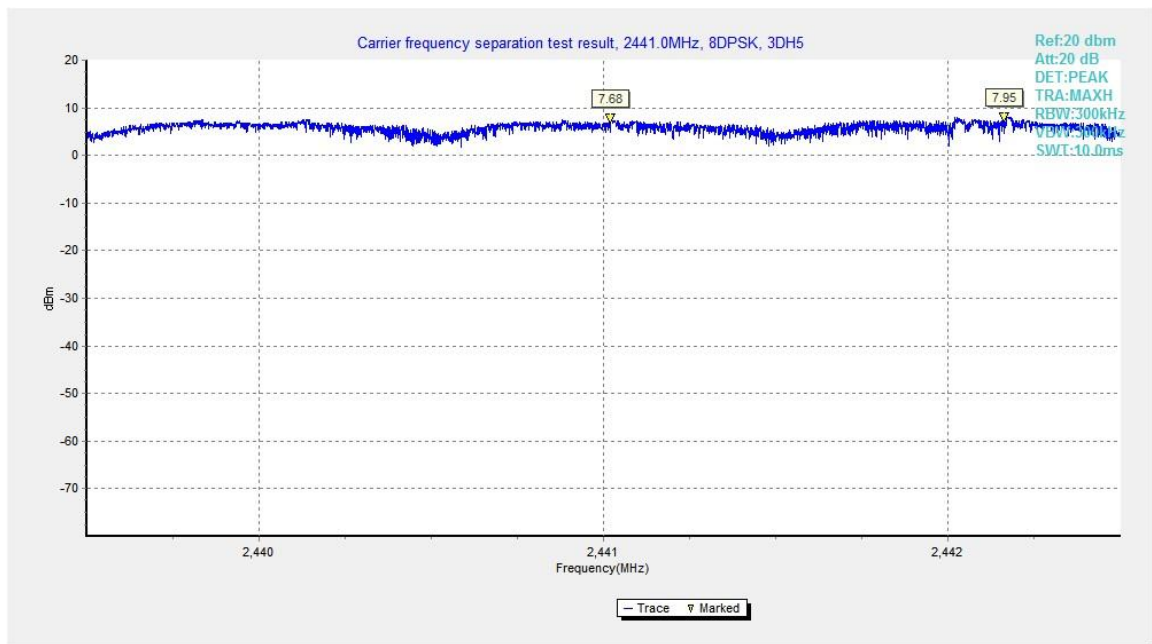

Fig.93. Carrier frequency separation measurement: 8DPSK, Channel 39

## B.10. Number of Hopping Channels

**Method of Measurement: See ANSI C63.10-clause 7.8.3**

The EUT must have its hopping function enabled. Use the following spectrum analyzer settings:

- Span = the frequency band of operation
- RBW = 500kHz
- VBW = 500kHz
- Sweep = auto
- Detector function = peak
- Trace = max hold
- Allow the trace to stabilize

It might prove necessary to break the span up into subranges to show clearly all of the hopping frequencies. Compliance of an EUT with the appropriate regulatory limit shall be determined for the number of hopping channels. A plot of the data shall be included in the test report.

### Measurement Limit:

Standard	Limit
FCC 47 CFR Part 15.247(a) (1)(iii)	At least 15 non-overlapping channels

### Measurement Result:

#### For GFSK

Channel	Number of hopping channels	Conclusion
0~39	Fig.94	79 P
40~78	Fig.95	

#### For $\pi/4$ DQPSK

Channel	Number of hopping channels	Conclusion
0~39	Fig.96	79 P
40~78	Fig.97	

#### For 8DPSK

Channel	Number of hopping channels	Conclusion
0~39	Fig.98	79 P
40~78	Fig.99	

**Conclusion: PASS**

**Test graphs as below:**

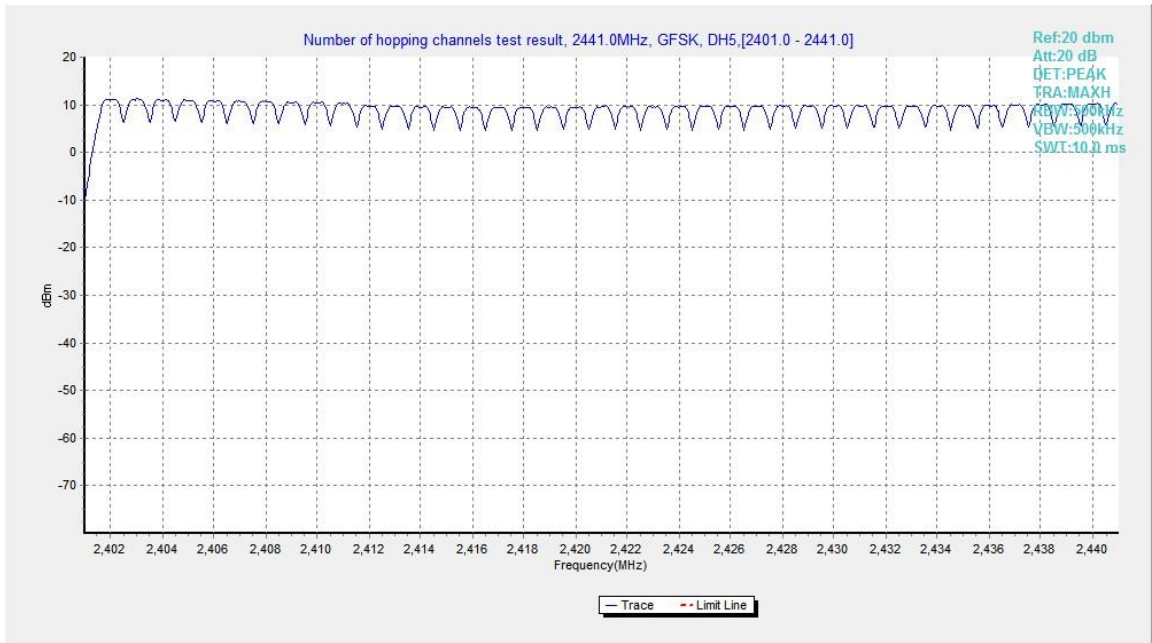

Fig.94. Number of hopping frequencies: GFSK, Channel 0 - 39

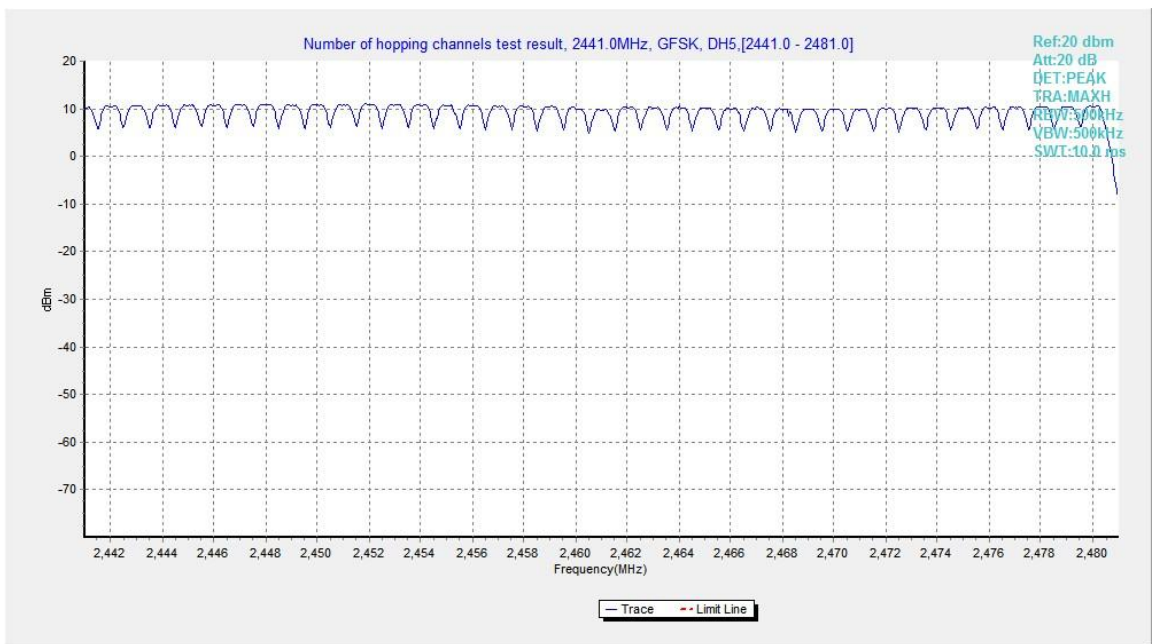

Fig.95. Number of hopping frequencies: GFSK, Channel 40 - 78



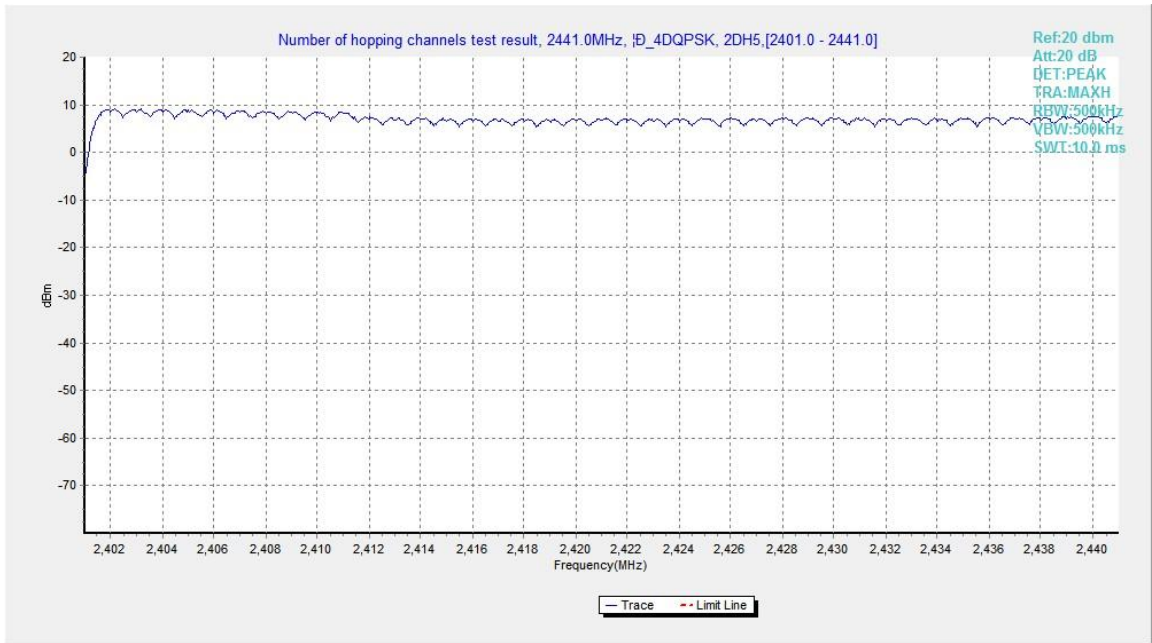

Fig.96. Number of hopping frequencies:  $\pi/4$  DQPSK, Channel 0 - 39

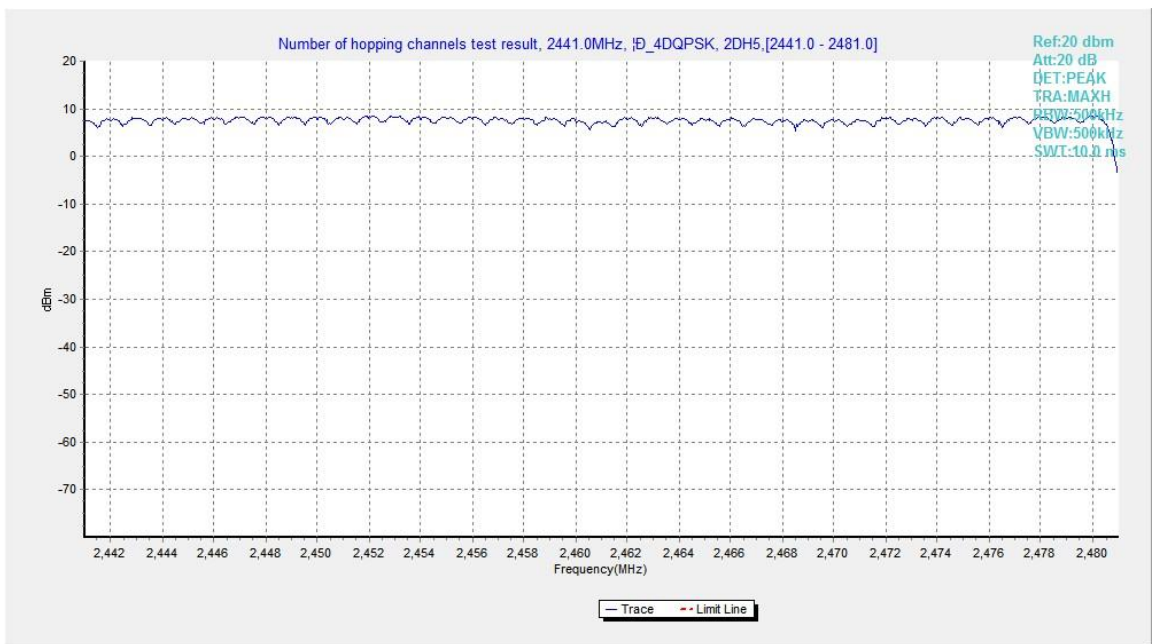

Fig.97. Number of hopping frequencies:  $\pi/4$  DQPSK, Channel 40 - 78

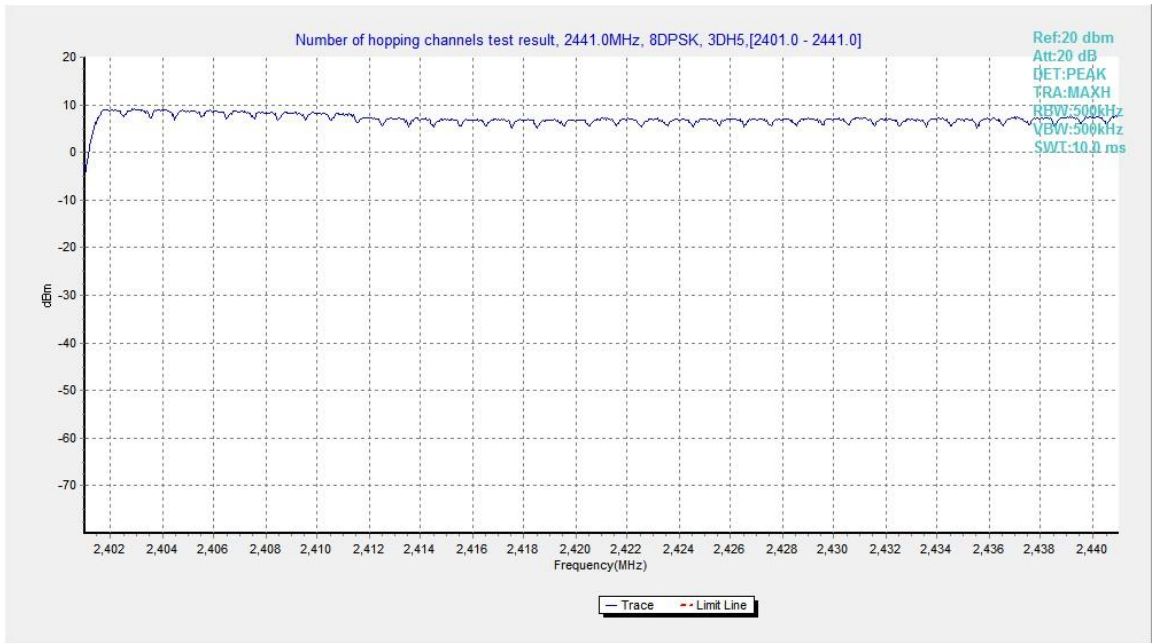

Fig.98. Number of hopping frequencies: 8DPSK, Channel 0 - 39

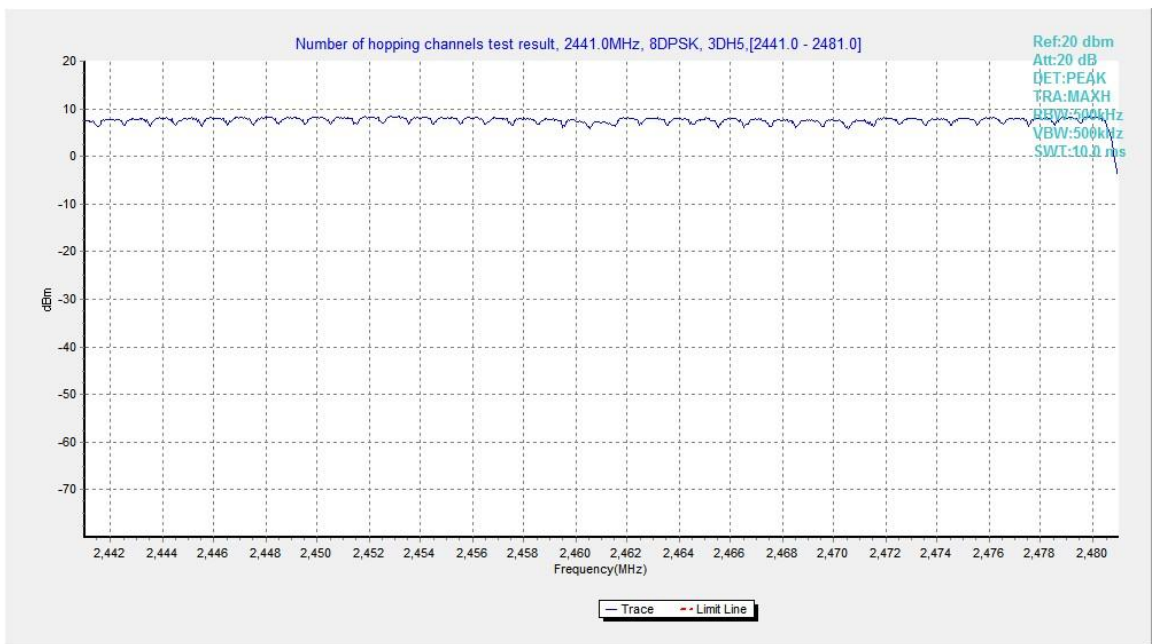

Fig.99. Number of hopping frequencies: 8DPSK, Channel 40 - 78

## B.11. AC Powerline Conducted Emission

**Method of Measurement: See ANSI C63.10-clause 6.2**

### Setup:

A stand-alone EUT shall be placed in the center along the back edge of the tabletop. For multiunit tabletop systems, the EUT shall be centered laterally (left to right facing the tabletop) on the tabletop and its rear shall be flush with the rear of the table.

Accessories that are part of an EUT system tested on a tabletop shall be placed in a test arrangement on one or both sides of the host with a 10 cm separation between the nearest points of the cabinets. The rear of the host and accessories shall be flush with the back of the supporting tabletop unless that would not be typical of normal use. If more than two accessories are present, then an equipment test arrangement shall be chosen that maintains 10 cm spacing between cabinets unless the equipment is normally located closer together.

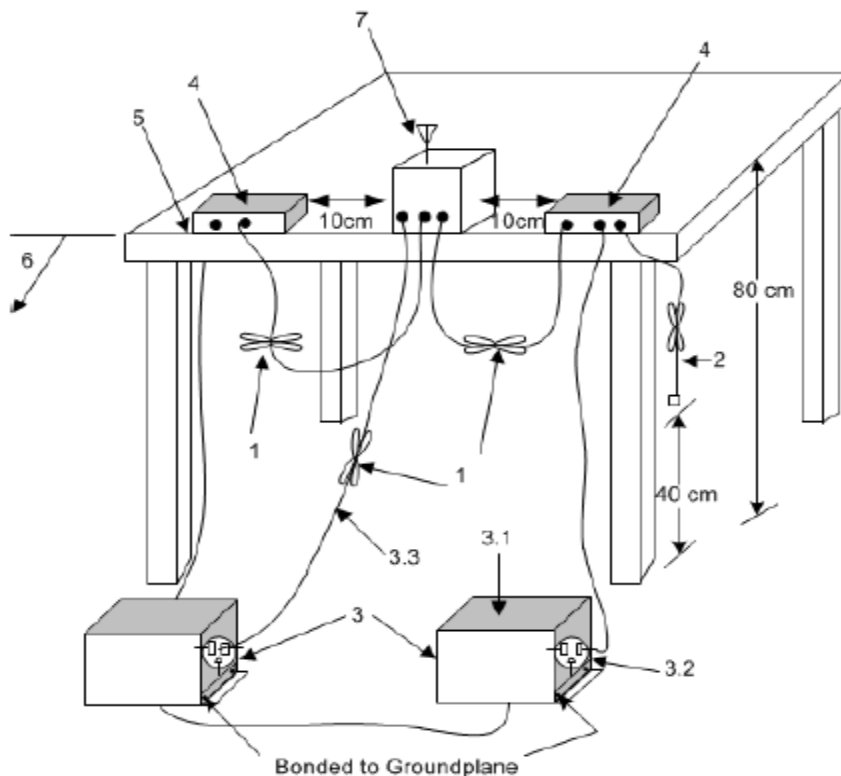

### Exploratory ac power-line conducted emission measurements

Exploratory measurements shall be used to identify the frequency of the emission that has the highest amplitude relative to the limit by operating the EUT in a range of typical modes of operation, cable positions, and with a typical system equipment configuration and arrangement. For each mode of operation and for each ac power current-carrying conductor, cable manipulation shall be performed within the range of likely configurations. For this measurement or series of measurements, the frequency spectrum of interest shall be monitored looking for the emission that has the highest amplitude relative to the limit. Once that emission is found for each current-carrying conductor of each power cord associated with the EUT (but not the cords associated with non-EUT equipment in the overall system), the one configuration and arrangement and mode of operation that produces the emission closest to the limit over all of the

measured conductors shall be recorded.

### Final ac power-line conducted emission measurements

Based on the exploratory tests of the EUT, the one EUT cable configuration and arrangement and mode of operation that produced the emission with the highest amplitude relative to the limit is selected for the final measurement, while applying the appropriate modulating signal to the EUT. If the EUT is relocated from an exploratory test site to a final test site, the highest emissions shall be remaximized at the final test location before final ac power-line conducted emission measurements are performed. The final test on all current-carrying conductors of all of the power cords to the equipment that comprises the EUT (but not the cords associated with other non-EUT equipment in the system) is then performed for the full frequency range for which the EUT is being tested for compliance without further variation of the EUT arrangement, cable positions, or EUT mode of operation. If the EUT is composed of equipment units that have their own separate ac power connections (e.g., floor-standing equipment with independent power cords for each shelf that are able to connect directly to the ac power network), then each current-carrying conductor of one unit is measured while the other units are connected to a second (or more) LISN(s). All units shall be measured separately. If a power strip is provided by the manufacturer, to supply all of the units making up the EUT, only the conductors in the power cord of the power strip shall be measured.

#### Test Condition:

Voltage (V)	Frequency (Hz)
120	60

#### Measurement Result and limit:

EUT ID: EUT1

Bluetooth (Quasi-peak Limit)

Frequency range (MHz)	Quasi-peak Limit (dB $\mu$ V)	Result (dB $\mu$ V)		Conclusion
		With charger		
		bluetooth	Idle	
0.15 to 0.5	66 to 56	Fig.B.11.1	Fig.B.11.2	<b>P</b>
0.5 to 5	56			
5 to 30	60			

NOTE: The limit decreases linearly with the logarithm of the frequency in the range 0.15 MHz to 0.5 MHz.

Bluetooth (Average Limit)

Frequency range (MHz)	Average Limit (dB $\mu$ V)	Result (dB $\mu$ V)		Conclusion
		With charger		
		bluetooth	Idle	
0.15 to 0.5	56 to 46	Fig.B.11.1	Fig.B.11.2	<b>P</b>
0.5 to 5	46			
5 to 30	50			

NOTE: The limit decreases linearly with the logarithm of the frequency in the range 0.15 MHz to 0.5 MHz.

**Conclusion: Pass**

Test graphs as below:

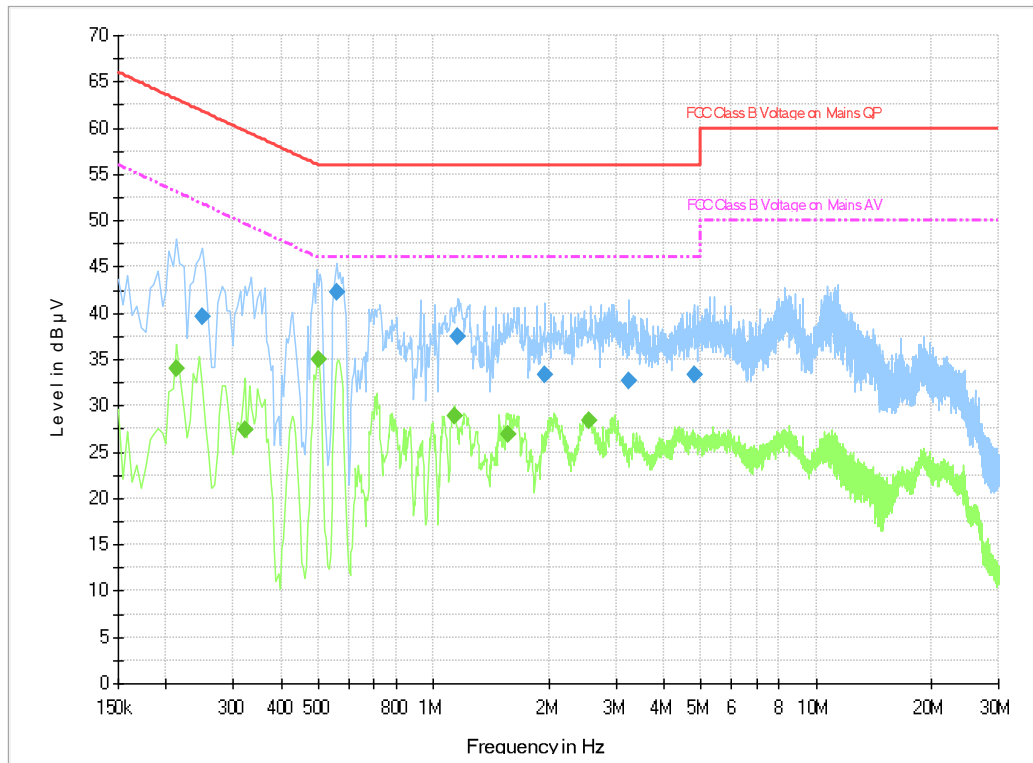

**Fig.B.11.1 AC Powerline Conducted Emission- bluetooth**

Note: The graphic result above is the maximum of the measurements for both phase line and neutral line.

**Final Result 1**

Frequency (MHz)	QuasiPeak (dBµV)	Meas. Time (ms)	Bandwidth (kHz)	Line	Corr. (dB)	Margin (dB)	Limit (dBµV)
0.249000	39.6	1000.	9.000	L1	19.6	19.6	22.2
0.559500	42.2	1000.	9.000	N	19.5	19.5	13.8
1.158000	37.5	1000.	9.000	L1	19.6	19.6	18.5
1.950000	33.4	1000.	9.000	N	19.5	19.5	22.6
3.246000	32.6	1000.	9.000	L1	19.7	19.7	23.4
4.789500	33.4	1000.	9.000	L1	19.8	19.8	22.6

**Final Result 2**

Frequency (MHz)	Average (dBµV)	Meas. Time (ms)	Bandwidth (kHz)	Line	Corr. (dB)	Margin (dB)	Limit (dBµV)
0.213000	34.0	1000.0	9.000	N	19.6	19.6	19.1
0.321000	27.4	1000.0	9.000	L1	19.6	19.6	22.3
0.501000	34.9	1000.0	9.000	N	19.6	19.6	11.1
1.135500	28.9	1000.0	9.000	L1	19.6	19.6	17.1
1.563000	26.9	1000.0	9.000	L1	19.6	19.6	19.1
2.539500	28.4	1000.0	9.000	N	19.6	19.6	17.6

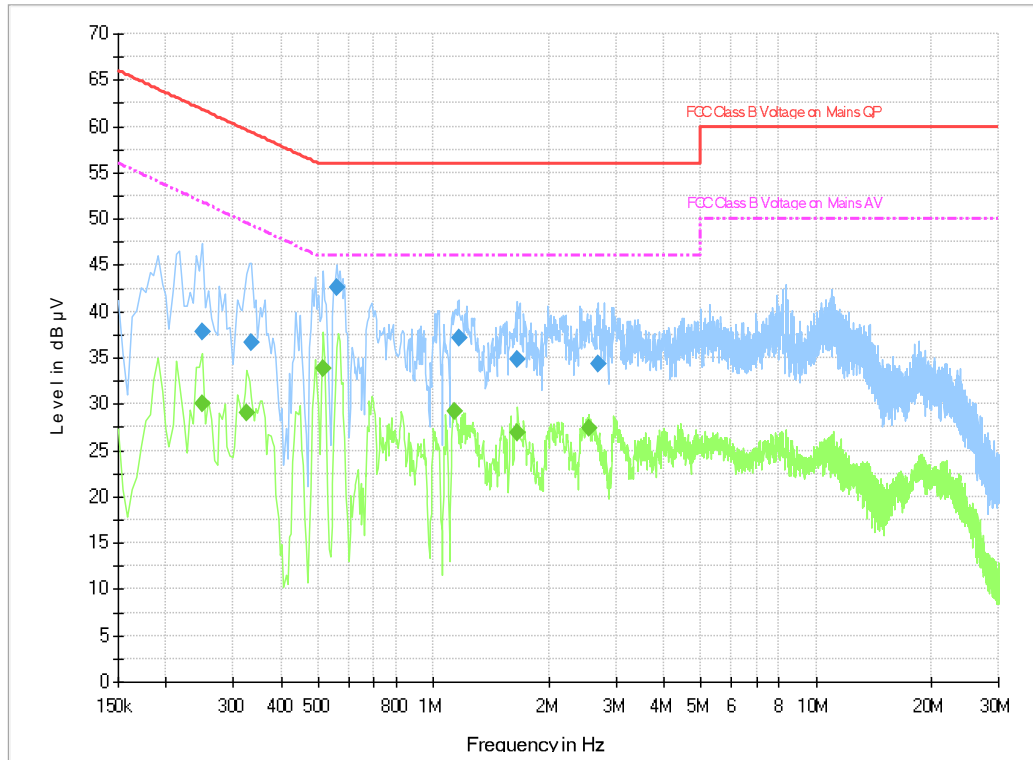

**Fig.B.11.2 AC Powerline Conducted Emission-Idle**

Note: The graphic result above is the maximum of the measurements for both phase line and neutral line.

**Final Result 1**

Frequency (MHz)	QuasiPeak (dBµV)	Meas. Time (ms)	Bandwidth (kHz)	Line	Corr. (dB)	Margin (dB)	Limit (dBµV)
0.249000	37.8	1000.	9.000	L1	19.6	19.6	24.0
0.334500	36.7	1000.	9.000	L1	19.6	19.6	22.7
0.559500	42.5	1000.	9.000	N	19.5	19.5	13.5
1.162500	37.2	1000.	9.000	L1	19.6	19.6	18.8
1.657500	34.9	1000.	9.000	N	19.6	19.6	21.1
2.701500	34.4	1000.	9.000	N	19.6	19.6	21.6

**Final Result 2**

Frequency (MHz)	Average (dBµV)	Meas. Time (ms)	Bandwidth (kHz)	Line	Corr. (dB)	Margin (dB)	Limit (dBµV)
0.249000	30.1	1000.0	9.000	L1	19.6	19.6	21.7
0.325500	29.1	1000.0	9.000	L1	19.6	19.6	20.5
0.514500	33.9	1000.0	9.000	N	19.5	19.5	12.1
1.140000	29.1	1000.0	9.000	L1	19.6	19.6	16.9
1.662000	26.9	1000.0	9.000	L1	19.6	19.6	19.1
2.553000	27.4	1000.0	9.000	N	19.6	19.6	18.6

**ANNEX C: Accreditation Certificate**

United States Department of Commerce  
National Institute of Standards and Technology

**NVLAP**® 

---

**Certificate of Accreditation to ISO/IEC 17025:2017**

---

NVLAP LAB CODE: 600118-0

**Telecommunication Technology Labs, CAICT**  
Beijing  
China

*is accredited by the National Voluntary Laboratory Accreditation Program for specific services,  
listed on the Scope of Accreditation, for:*

**Electromagnetic Compatibility & Telecommunications**

*This laboratory is accredited in accordance with the recognized International Standard ISO/IEC 17025:2017.  
This accreditation demonstrates technical competence for a defined scope and the operation of a laboratory quality  
management system (refer to joint ISO-ILAC-IAF Communique dated January 2009).*

2020-09-29 through 2021-09-30  
*Effective Dates*

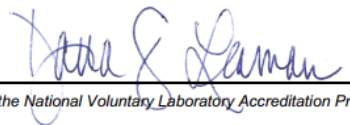

  
*For the National Voluntary Laboratory Accreditation Program*

\*\*\*END OF REPORT\*\*\*