

ANNEX A Graph Results

GSM850_CH128 Right Tilt GPRS(3tx)

Date: 1/11/2024

Electronics: DAE4 Sn1601

Medium: head 835 MHz

Medium parameters used: $f = 824.2$; $\sigma = 0.888$ mho/m; $\epsilon_r = 40.93$; $\rho = 1000$ kg/m³

Ambient Temperature: 22.5°C, Liquid Temperature: 22.3°C

Communication System: GSM850 824.2 Duty Cycle: 1:2.67

Probe: EX3DV4 – SN3846 ConvF(8.50,9.01,9.47)

Area Scan (71x121x1): Interpolated grid: dx=1.500 mm, dy=1.500 mm

Maximum value of SAR (interpolated) = 1.06 W/kg

Zoom Scan (7x7x7)/Cube 0: Measurement grid: dx=8mm, dy=8mm, dz=5mm

Reference Value = 25.1 V/m; Power Drift = -0.10dB

Peak SAR (extrapolated) = 1.52 W/kg

SAR(1 g) = 0.719 W/kg; SAR(10 g) = 0.393 W/kg

Maximum value of SAR (measured) = 0.771 W/kg

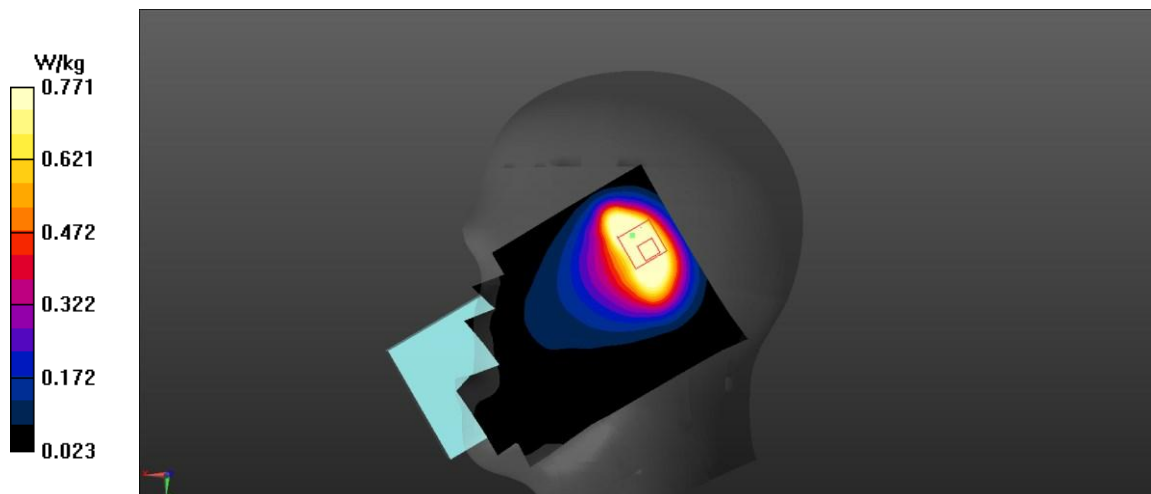

Fig A.1

GSM850_CH190 Top Edge GPRS(3tx) 10mm

Date: 1/11/2024

Electronics: DAE4 Sn1601

Medium: head 835 MHz

Medium parameters used: $f = 836.6$; $\sigma = 0.966$ mho/m; $\epsilon_r = 55.65$; $\rho = 1000$ kg/m³

Ambient Temperature: 22.5°C, Liquid Temperature: 22.3°C

Communication System: GSM850 836.6 Duty Cycle: 1:2.67

Probe: EX3DV4 – SN3846 ConvF(8.50,9.01,9.47)

Area Scan (71x121x1): Interpolated grid: $dx=1.500$ mm, $dy=1.500$ mm

Maximum value of SAR (interpolated) = 0.375 W/kg

Zoom Scan (7x7x7)/Cube 0: Measurement grid: $dx=8$ mm, $dy=8$ mm, $dz=5$ mm

Reference Value = 19.59 V/m; Power Drift = -0.11 dB

Peak SAR (extrapolated) = 0.649 W/kg

SAR(1 g) = 0.356 W/kg; SAR(10 g) = 0.192 W/kg

Maximum value of SAR (measured) = 0.396W/kg

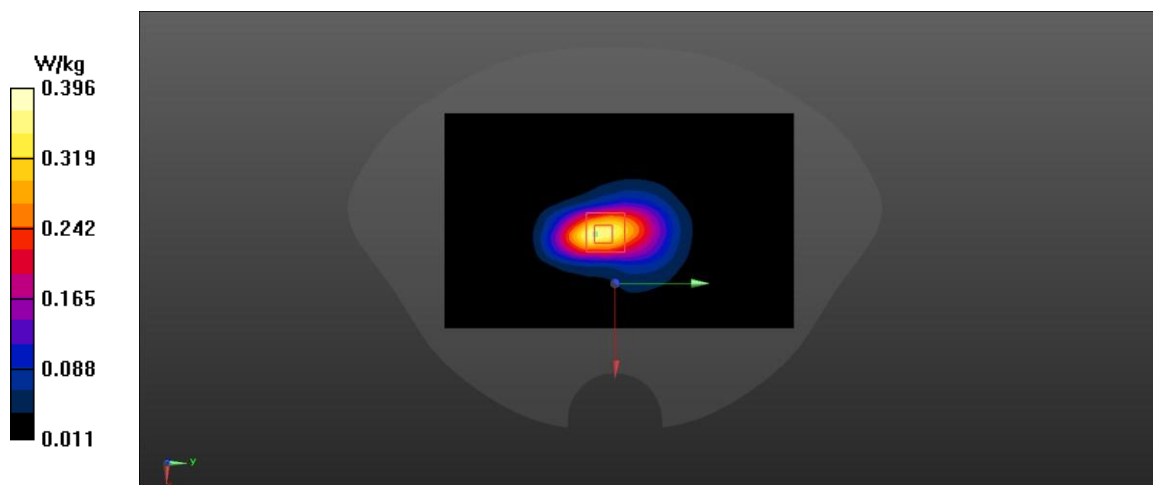

Fig A.2

PCS1900_CH810 Left Cheek GPRS (2TX)

Date: 1/13/2024

Electronics: DAE4 Sn1601

Medium: head 1900 MHz

Medium parameters used: $f = 1909.8$; $\sigma = 1.418$ mho/m; $\epsilon_r = 40.73$; $\rho = 1000$ kg/m³

Ambient Temperature: 22.5°C, Liquid Temperature: 22.3°C

Communication System: PCS1900 1909.8 Duty Cycle: 1:4

Probe: EX3DV4 – SN3846 ConvF(7.27,7.55,8.11)

Area Scan (71x121x1): Interpolated grid: dx=1.500 mm, dy=1.500 mm

Maximum value of SAR (interpolated) = 0.769 W/kg

Zoom Scan (7x7x7)/Cube 0: Measurement grid: dx=8mm, dy=8mm, dz=5mm

Reference Value = 9.736 V/m; Power Drift = 0.20 dB

Peak SAR (extrapolated) = 0.892 W/kg

SAR(1 g) = 0.472 W/kg; SAR(10 g) = 0.262 W/kg

Maximum value of SAR (measured) = 0.529W/kg

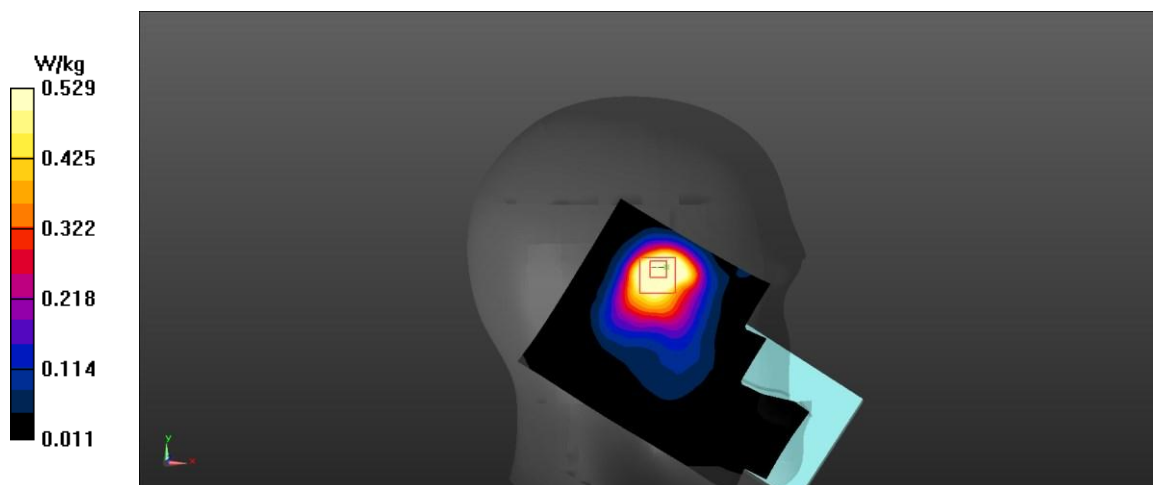

Fig A.3

PCS1900_CH512 Right Edge GPRS(2TX) 10mm

Date: 1/13/2024

Electronics: DAE4 Sn1601

Medium: head 1900 MHz

Medium parameters used: $f = 1850.2$; $\sigma = 1.467$ mho/m; $\epsilon_r = 52.54$; $\rho = 1000$ kg/m³

Ambient Temperature: 22.5°C, Liquid Temperature: 22.3°C

Communication System: PCS1900 1850.2 Duty Cycle: 1:4

Probe: EX3DV4 – SN3846 ConvF(7.27,7.55,8.11)

Area Scan (71x121x1): Interpolated grid: dx=1.500 mm, dy=1.500 mm

Maximum value of SAR (interpolated) = 0.195 W/kg

Zoom Scan (7x7x7)/Cube 0: Measurement grid: dx=8mm, dy=8mm, dz=5mm

Reference Value = 13.4 V/m; Power Drift = 0.11 dB

Peak SAR (extrapolated) = 0.305 W/kg

SAR(1 g) = 0.172 W/kg; SAR(10 g) = 0.093 W/kg

Maximum value of SAR (measured) = 0.195 W/kg

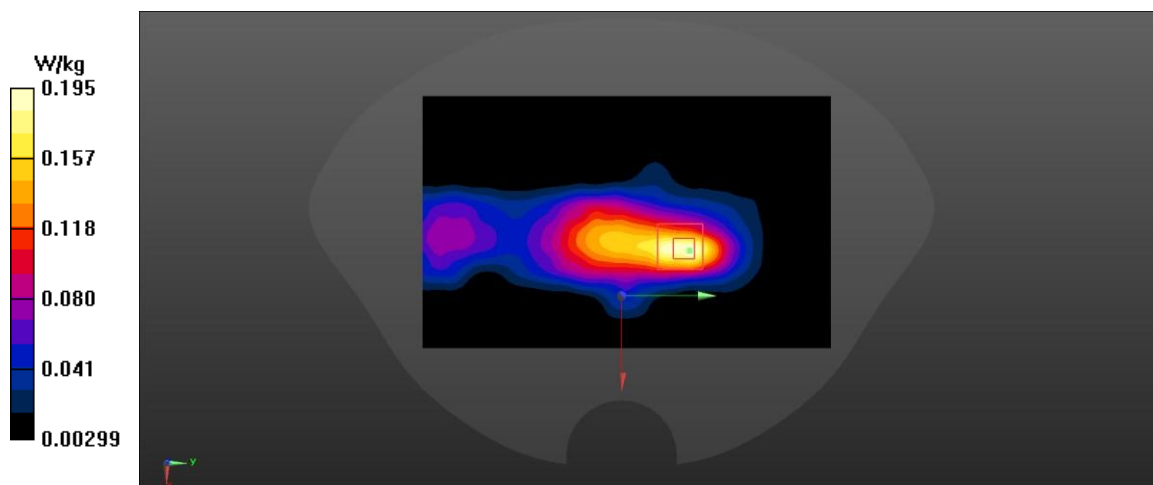

Fig A.4

WCDMA1900-BII_CH9262 Left Cheek

Date: 1/13/2024

Electronics: DAE4 Sn1601

Medium: head 1900 MHz

Medium parameters used: $f = 1852.4$; $\sigma = 1.362$ mho/m; $\epsilon_r = 40.8$; $\rho = 1000$ kg/m³

Ambient Temperature: 22.5°C, Liquid Temperature: 22.3°C

Communication System: WCDMA1900-BII 1852.4 Duty Cycle: 1:1

Probe: EX3DV4 – SN3846 ConvF(7.27,7.55,8.11)

Area Scan (71x121x1): Interpolated grid: dx=1.500 mm, dy=1.500 mm

Maximum value of SAR (interpolated) = 1.6 W/kg

Zoom Scan (7x7x7)/Cube 0: Measurement grid: dx=8mm, dy=8mm, dz=5mm

Reference Value = 12.43 V/m; Power Drift = 0.28 dB

Peak SAR (extrapolated) = 1.86 W/kg

SAR(1 g) = 0.98 W/kg; SAR(10 g) = 0.529 W/kg

Maximum value of SAR (measured) = 1.09 W/kg

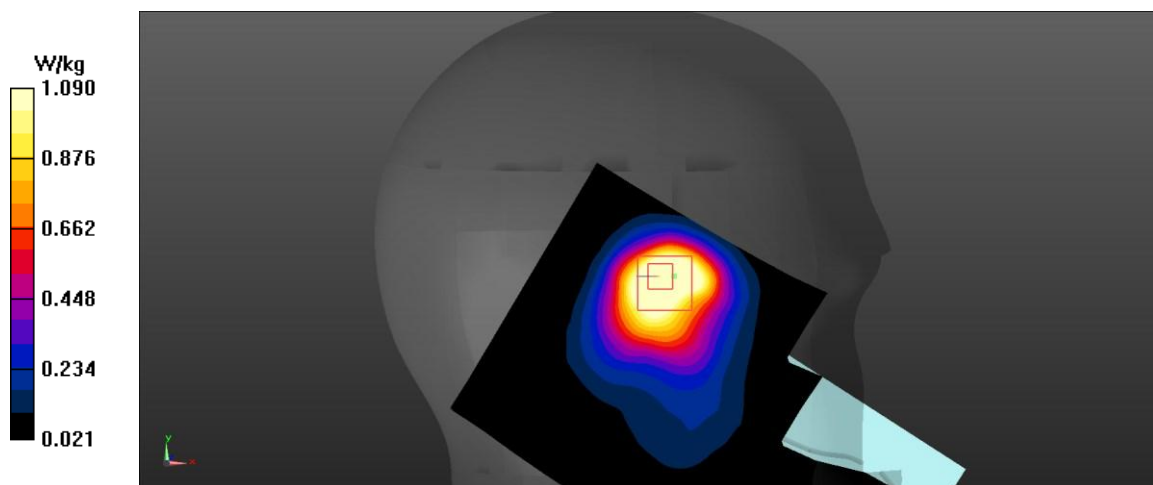

Fig A.5

WCDMA1900-BII_CH9538 Right Edge 10mm

Date: 1/13/2024

Electronics: DAE4 Sn1601

Medium: head 1900 MHz

Medium parameters used: $f = 1907.6$; $\sigma = 1.523$ mho/m; $\epsilon_r = 52.47$; $\rho = 1000$ kg/m³

Ambient Temperature: 22.5°C, Liquid Temperature: 22.3°C

Communication System: WCDMA1900-BII 1907.6 Duty Cycle: 1:1

Probe: EX3DV4 – SN3846 ConvF(7.27,7.55,8.11)

Area Scan (71x121x1): Interpolated grid: dx=1.500 mm, dy=1.500 mm

Maximum value of SAR (interpolated) = 0.836 W/kg

Zoom Scan (7x7x7)/Cube 0: Measurement grid: dx=8mm, dy=8mm, dz=5mm

Reference Value = 22.93 V/m; Power Drift = 0.30 dB

Peak SAR (extrapolated) = 1.36 W/kg

SAR(1 g) = 0.776 W/kg; SAR(10 g) = 0.425 W/kg

Maximum value of SAR (measured) = 0.870 W/kg

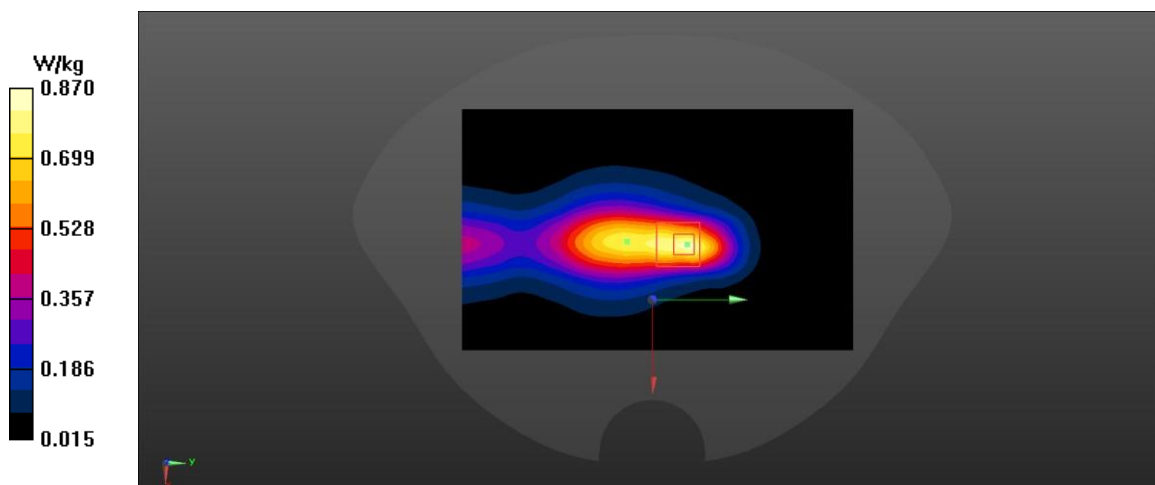

Fig A.6

WCDMA1700-BIV_CH1412 Left Cheek

Date: 1/12/2024

Electronics: DAE4 Sn1601

Medium: head 1750 MHz

Medium parameters used: $f = 1732.4$; $\sigma = 1.341$ mho/m; $\epsilon_r = 39.71$; $\rho = 1000$ kg/m³

Ambient Temperature: 22.5°C, Liquid Temperature: 22.3°C

Communication System: WCDMA1700-BIV 1732.4 Duty Cycle: 1:1

Probe: EX3DV4 – SN3846 ConvF(7.47,7.79,8.45)

Area Scan (71x121x1): Interpolated grid: dx=1.500 mm, dy=1.500 mm

Maximum value of SAR (interpolated) = 1.17 W/kg

Zoom Scan (7x7x7)/Cube 0: Measurement grid: dx=8mm, dy=8mm, dz=5mm

Reference Value = 11.21 V/m; Power Drift = -0.24 dB

Peak SAR (extrapolated) = 1.28 W/kg

SAR(1 g) = 0.713 W/kg; SAR(10 g) = 0.407 W/kg

Maximum value of SAR (measured) = 0.781 W/kg

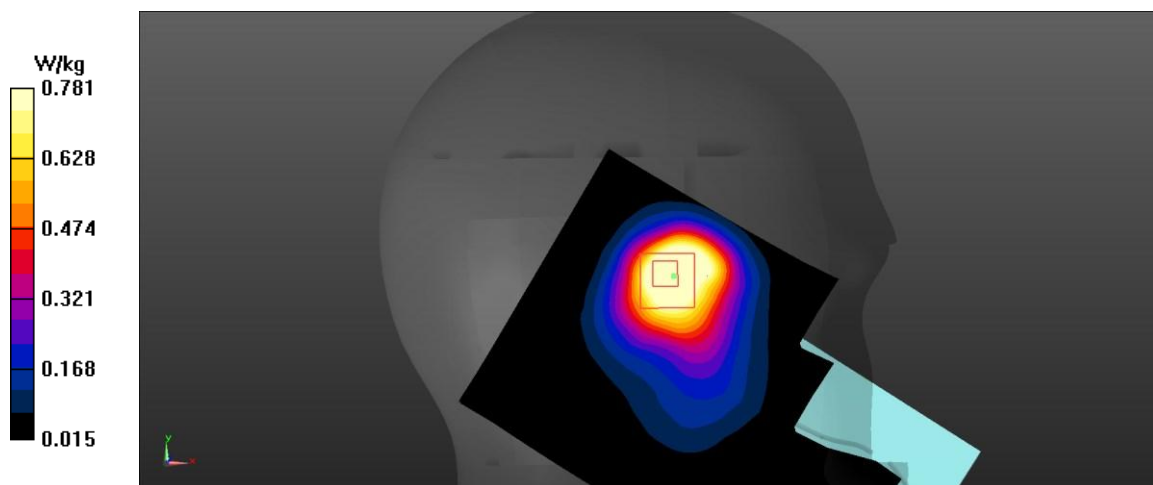

Fig A.7

WCDMA1700-BIV_CH1412 Right Edge 10mm

Date: 1/12/2024

Electronics: DAE4 Sn1601

Medium: head 1750 MHz

Medium parameters used: $f = 1732.5$; $\sigma = 1.483$ mho/m; $\epsilon_r = 52.54$; $\rho = 1000$ kg/m³

Ambient Temperature: 22.5°C, Liquid Temperature: 22.3°C

Communication System: WCDMA1700-BIV 1732.5 Duty Cycle: 1:1

Probe: EX3DV4 – SN3846 ConvF(7.47,7.79,8.45)

Area Scan (71x121x1): Interpolated grid: dx=1.500 mm, dy=1.500 mm

Maximum value of SAR (interpolated) = 0.381 W/kg

Zoom Scan (7x7x7)/Cube 0: Measurement grid: dx=8mm, dy=8mm, dz=5mm

Reference Value = 16.42 V/m; Power Drift = -0.06 dB

Peak SAR (extrapolated) = 0.566 W/kg

SAR(1 g) = 0.351 W/kg; SAR(10 g) = 0.21 W/kg

Maximum value of SAR (measured) = 0.385W/kg

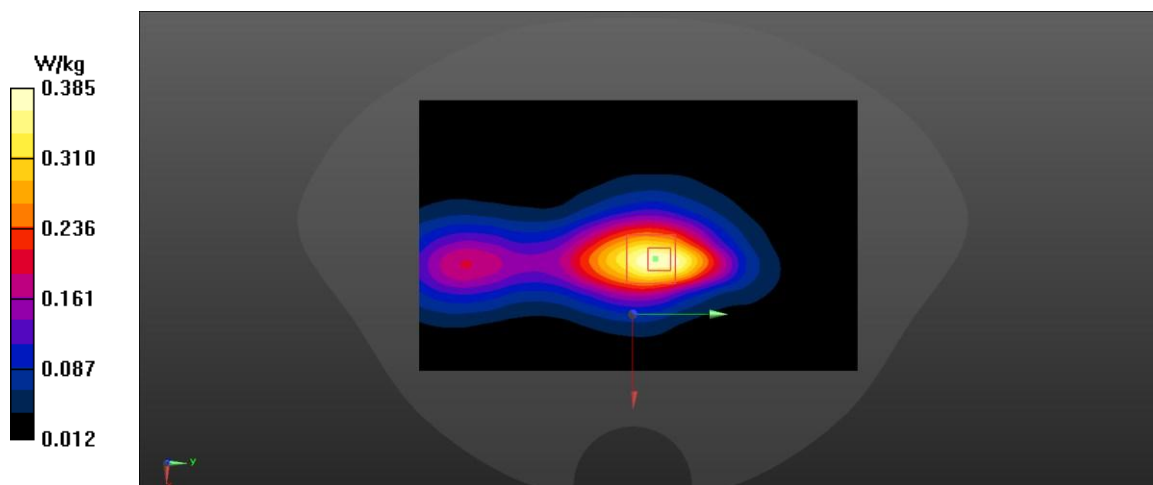

Fig A.8

WCDMA850-BV_CH4183 Right Tilt

Date: 1/11/2024

Electronics: DAE4 Sn1601

Medium: head 835 MHz

Medium parameters used: $f = 836.6$; $\sigma = 0.9$ mho/m; $\epsilon_r = 40.92$; $\rho = 1000$ kg/m³

Ambient Temperature: 22.5°C, Liquid Temperature: 22.3°C

Communication System: WCDMA850-BV 836.6 Duty Cycle: 1:1

Probe: EX3DV4 – SN3846 ConvF(8.50,9.01,9.47)

Area Scan (71x121x1): Interpolated grid: dx=1.500 mm, dy=1.500 mm

Maximum value of SAR (interpolated) = 0.711 W/kg

Zoom Scan (7x7x7)/Cube 0: Measurement grid: dx=8mm, dy=8mm, dz=5mm

Reference Value = 20.68 V/m; Power Drift = 0.15 dB

Peak SAR (extrapolated) = 1.12 W/kg

SAR(1 g) = 0.495 W/kg; SAR(10 g) = 0.264 W/kg

Maximum value of SAR (measured) = 0.536W/kg

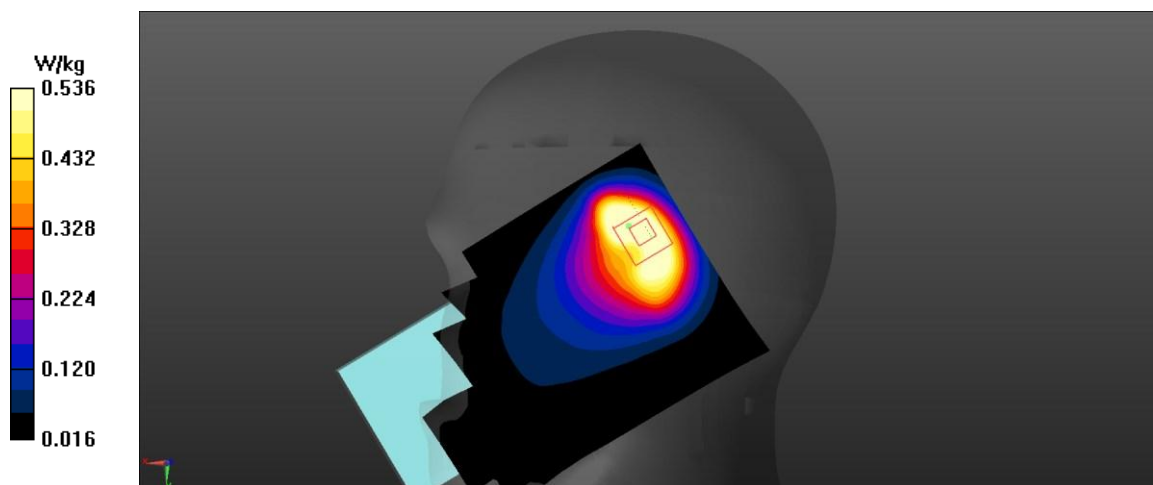

Fig A.9

WCDMA850-BV_CH4183 Top Edge 10mm

Date: 1/11/2024

Electronics: DAE4 Sn1601

Medium: head 835 MHz

Medium parameters used: $f = 836.6$; $\sigma = 0.966$ mho/m; $\epsilon_r = 55.65$; $\rho = 1000$ kg/m³

Ambient Temperature: 22.5°C, Liquid Temperature: 22.3°C

Communication System: WCDMA850-BV 836.6 Duty Cycle: 1:1

Probe: EX3DV4 – SN3846 ConvF(8.50,9.01,9.47)

Area Scan (71x121x1): Interpolated grid: $dx=1.500$ mm, $dy=1.500$ mm

Maximum value of SAR (interpolated) = 0.386 W/kg

Zoom Scan (7x7x7)/Cube 0: Measurement grid: $dx=8$ mm, $dy=8$ mm, $dz=5$ mm

Reference Value = 17.34 V/m; Power Drift = 0.02dB

Peak SAR (extrapolated) = 0.644 W/kg

SAR(1 g) = 0.345 W/kg; SAR(10 g) = 0.186 W/kg

Maximum value of SAR (measured) = 0.382 W/kg

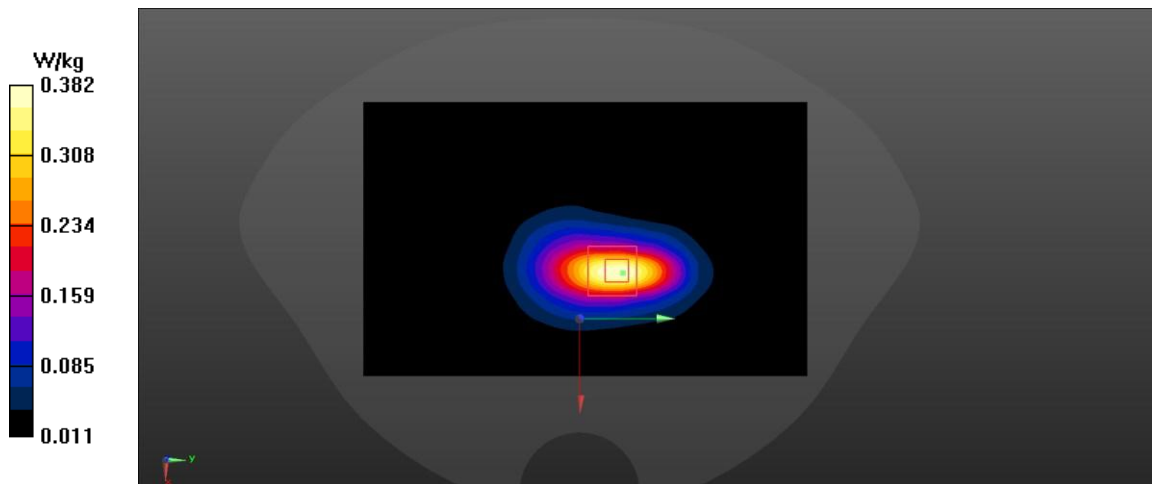

Fig A.10

LTE1900-FDD2_CH19100 Right Cheek 50RB-High

Date: 1/13/2024

Electronics: DAE4 Sn1601

Medium: head 1900 MHz

Medium parameters used: $f = 1900$; $\sigma = 1.408$ mho/m; $\epsilon_r = 40.74$; $\rho = 1000$ kg/m³

Ambient Temperature: 22.5°C, Liquid Temperature: 22.3°C

Communication System: LTE1900-FDD2 1900 MHz Duty Cycle: 1:1

Probe: EX3DV4 – SN3846 ConvF(7.27,7.55,8.11)

Area Scan (71x121x1): Interpolated grid: dx=1.500 mm, dy=1.500 mm

Maximum value of SAR (interpolated) = 0.402 W/kg

Zoom Scan (7x7x7)/Cube 0: Measurement grid: dx=8mm, dy=8mm, dz=5mm

Reference Value = 6.567 V/m; Power Drift = -0.03 dB

Peak SAR (extrapolated) = 0.471 W/kg

SAR(1 g) = 0.308 W/kg; SAR(10 g) = 0.193 W/kg

Maximum value of SAR (measured) = 0.337 W/kg

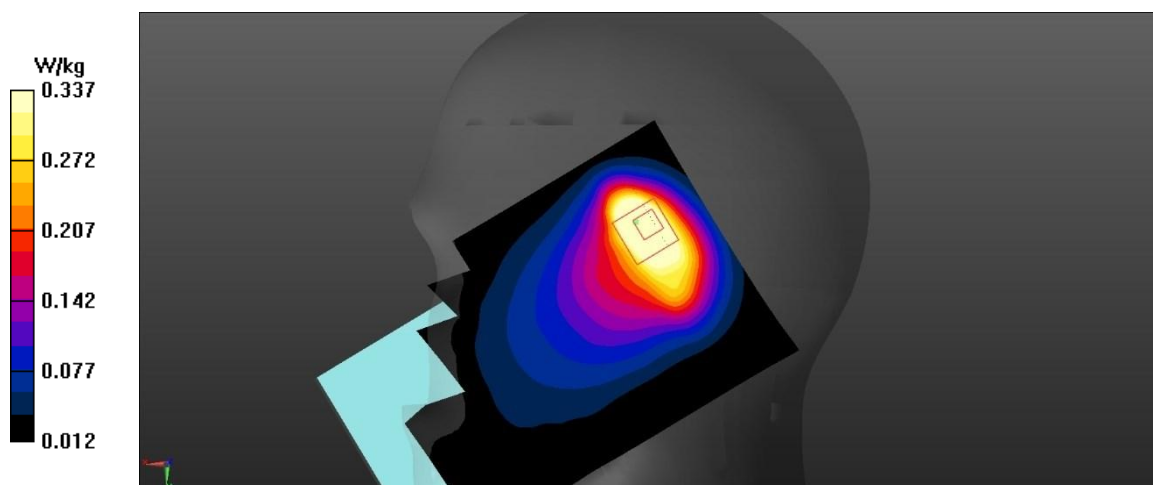

Fig A.11

LTE1900-FDD2_CH19100 Bottom Edge 1RB-High 10mm

Date: 1/13/2024

Electronics: DAE4 Sn1601

Medium: head 1900 MHz

Medium parameters used: $f = 1900$; $\sigma = 1.515$ mho/m; $\epsilon_r = 52.48$; $\rho = 1000$ kg/m³

Ambient Temperature: 22.5°C, Liquid Temperature: 22.3°C

Communication System: LTE1900-FDD2 1900 MHz Duty Cycle: 1:1

Probe: EX3DV4 – SN3846 ConvF(7.27,7.55,8.11)

Area Scan (71x121x1): Interpolated grid: $dx=1.500$ mm, $dy=1.500$ mm

Maximum value of SAR (interpolated) = 0.83 W/kg

Zoom Scan (7x7x7)/Cube 0: Measurement grid: $dx=8$ mm, $dy=8$ mm, $dz=5$ mm

Reference Value = 23.54 V/m; Power Drift = -0.3 dB

Peak SAR (extrapolated) = 1.17 W/kg

SAR(1 g) = 0.73 W/kg; SAR(10 g) = 0.423 W/kg

Maximum value of SAR (measured) = 0.803 W/kg

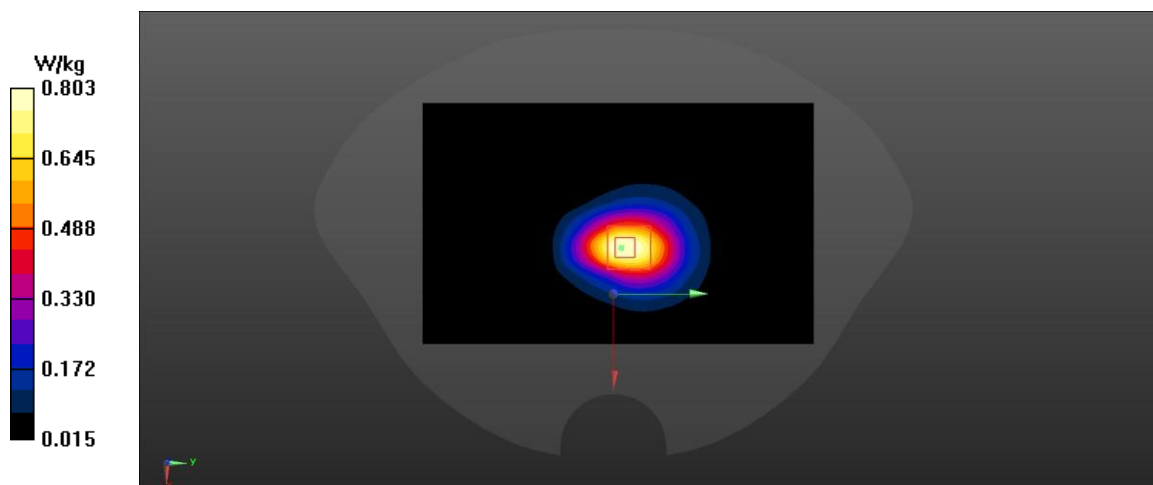

Fig A.12

LTE1900-FDD2_CH19100 Rear 1RB-High 15mm

Date: 1/13/2024

Electronics: DAE4 Sn1601

Medium: head 1900 MHz

Medium parameters used: $f = 1900$; $\sigma = 1.515$ mho/m; $\epsilon_r = 52.48$; $\rho = 1000$ kg/m³

Ambient Temperature: 22.5°C, Liquid Temperature: 22.3°C

Communication System: LTE1900-FDD2 1900 MHz Duty Cycle: 1:1

Probe: EX3DV4 – SN3846 ConvF(7.27,7.55,8.11)

Area Scan (71x121x1): Interpolated grid: dx=1.500 mm, dy=1.500 mm

Maximum value of SAR (interpolated) = 0.966 W/kg

Zoom Scan (7x7x7)/Cube 0: Measurement grid: dx=8mm, dy=8mm, dz=5mm

Reference Value = 10.9 V/m; Power Drift = 0.12 dB

Peak SAR (extrapolated) = 1.32 W/kg

SAR(1 g) = 0.73 W/kg; SAR(10 g) = 0.383 W/kg

Maximum value of SAR (measured) = 0.926W/kg

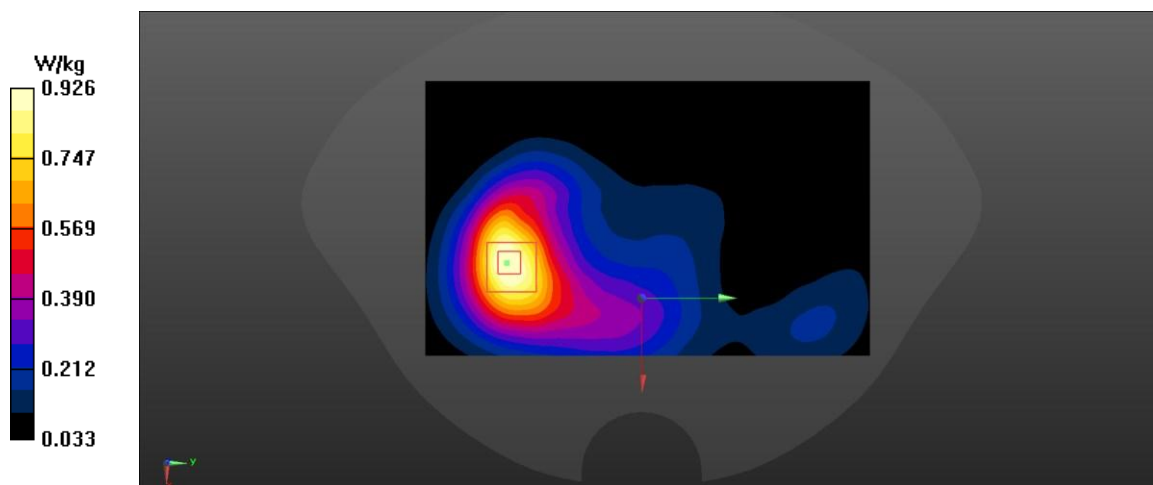

Fig A.13

LTE2500-FDD7_CH21100 Right Cheek

Date: 1/14/2024

Electronics: DAE4 Sn1601

Medium: head 2600 MHz

Medium parameters used: $f = 2535$; $\sigma = 1.937$ mho/m; $\epsilon_r = 39.08$; $\rho = 1000$ kg/m³

Ambient Temperature: 22.5°C, Liquid Temperature: 22.3°C

Communication System: LTE2500-FDD7 2535 MHz Duty Cycle: 1:1

Probe: EX3DV4 – SN3846 ConvF(6.72,7.04,7.50)

Area Scan (71x121x1): Interpolated grid: dx=1.200 mm, dy=1.200 mm

Maximum value of SAR (interpolated) = 1.78 W/kg

Zoom Scan (7x7x7)/Cube 0: Measurement grid: dx=5mm, dy=5mm, dz=5mm

Reference Value = 7.077 V/m; Power Drift = 0.22 dB

Peak SAR (extrapolated) = 2.06 W/kg

SAR(1 g) = 0.973 W/kg; SAR(10 g) = 0.47 W/kg

Maximum value of SAR (measured) = 1.100 W/kg

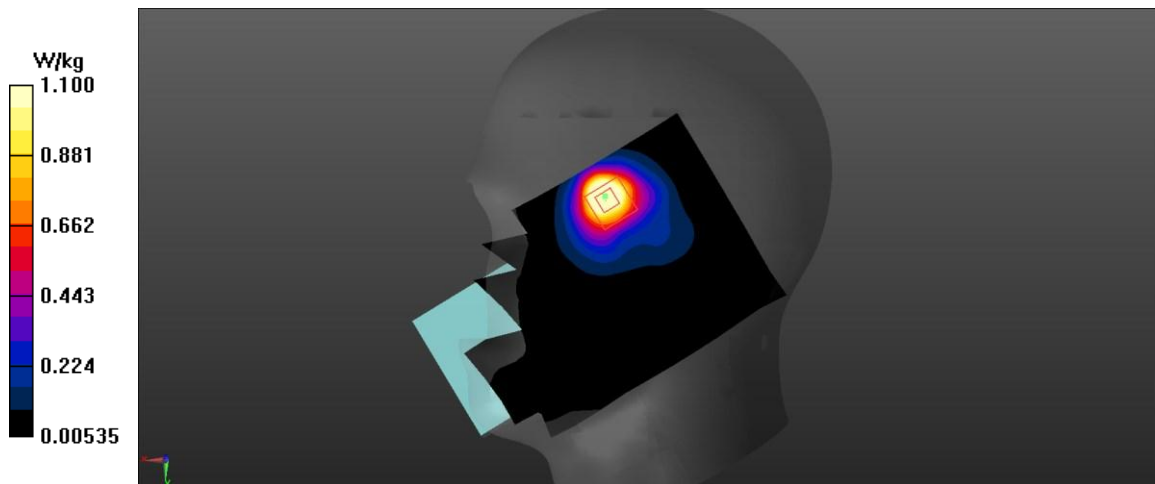

Fig A.14

LTE2500-FDD7_CH21375 Rear 1RB-High 10mm

Date: 1/14/2024

Electronics: DAE4 Sn1601

Medium: head 2600 MHz

Medium parameters used: $f = 2535$; $\sigma = 2.11$ mho/m; $\epsilon_r = 52.37$; $\rho = 1000$ kg/m³

Ambient Temperature: 22.5°C, Liquid Temperature: 22.3°C

Communication System: LTE2500-FDD7 2562.5 MHz Duty Cycle: 1:1

Probe: EX3DV4 – SN3846 ConvF(6.72,7.04,7.50)

Area Scan (71x121x1): Interpolated grid: dx=1.200 mm, dy=1.200 mm

Maximum value of SAR (interpolated) = 0.644 W/kg

Zoom Scan (7x7x7)/Cube 0: Measurement grid: dx=5mm, dy=5mm, dz=5mm

Reference Value = 5.529 V/m; Power Drift = -0.02 dB

Peak SAR (extrapolated) = 1.08 W/kg

SAR(1 g) = 0.555 W/kg; SAR(10 g) = 0.105 W/kg

Maximum value of SAR (measured) = 0.623 W/kg

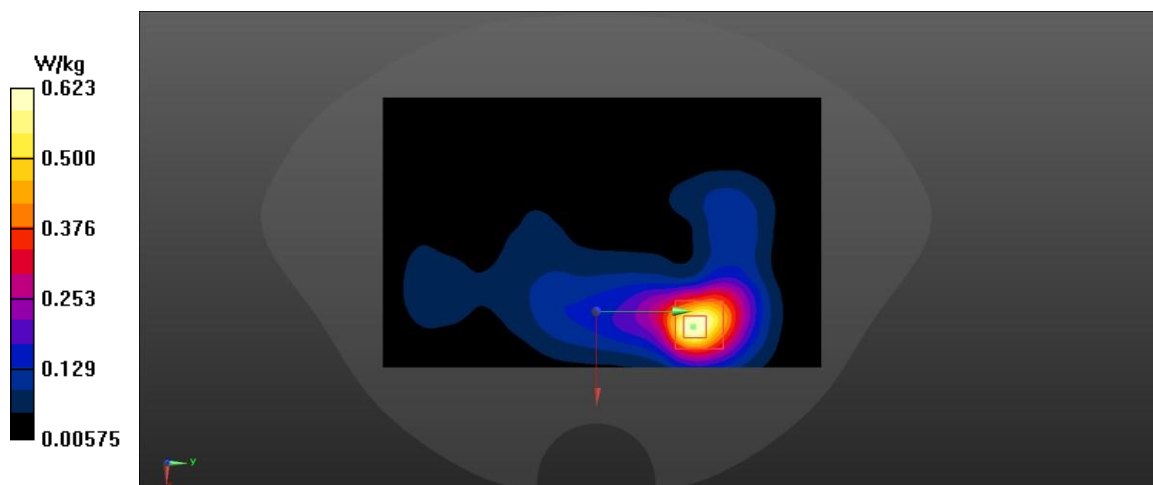

Fig A.15

LTE2500-FDD7_CH20850 Rear 50RB-High

Date: 1/14/2024

Electronics: DAE4 Sn1601

Medium: head 2600 MHz

Medium parameters used: $f = 2510$; $\sigma = 2.06$ mho/m; $\epsilon_r = 52.43$; $\rho = 1000$ kg/m³

Ambient Temperature: 22.5°C, Liquid Temperature: 22.3°C

Communication System: LTE2500-FDD7 2510 MHz Duty Cycle: 1:1

Probe: EX3DV4 – SN3846 ConvF(6.72,7.04,7.50)

Area Scan (71x121x1): Interpolated grid: dx=1.200 mm, dy=1.200 mm

Maximum value of SAR (interpolated) = 0.409 W/kg

Zoom Scan (7x7x7)/Cube 0: Measurement grid: dx=5mm, dy=5mm, dz=5mm

Reference Value = 8.199 V/m; Power Drift = -0.11 dB

Peak SAR (extrapolated) = 0.657 W/kg

SAR(1 g) = 0.358 W/kg; SAR(10 g) = 0.193 W/kg

Maximum value of SAR (measured) = 0.385 W/kg

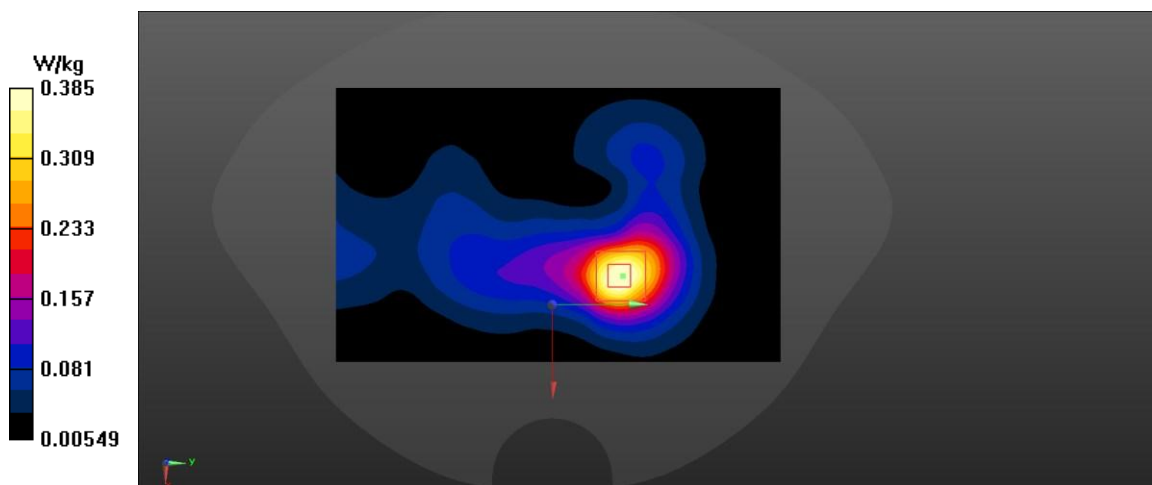

Fig A.16

LTE700-FDD12_CH23095 Right Tilt 1RB-High

Date: 1/10/2024

Electronics: DAE4 Sn1601

Medium: head 750 MHz

Medium parameters used: $f = 707.5$; $\sigma = 0.85$ mho/m; $\epsilon_r = 41.33$; $\rho = 1000$ kg/m³

Ambient Temperature: 22.5°C, Liquid Temperature: 22.3°C

Communication System: LTE700-FDD12 707.5 MHz Duty Cycle: 1:1

Probe: EX3DV4 – SN3846 ConvF(8.98,8.99,10.08)

Area Scan (71x121x1): Interpolated grid: $dx=1.500$ mm, $dy=1.500$ mm

Maximum value of SAR (interpolated) = 1.05 W/kg

Zoom Scan (7x7x7)/Cube 0: Measurement grid: $dx=8$ mm, $dy=8$ mm, $dz=5$ mm

Reference Value = 21.59 V/m; Power Drift = 0.24 dB

Peak SAR (extrapolated) = 1.38 W/kg

SAR(1 g) = 0.609 W/kg; SAR(10 g) = 0.329 W/kg

Maximum value of SAR (measured) = 0.657W/kg

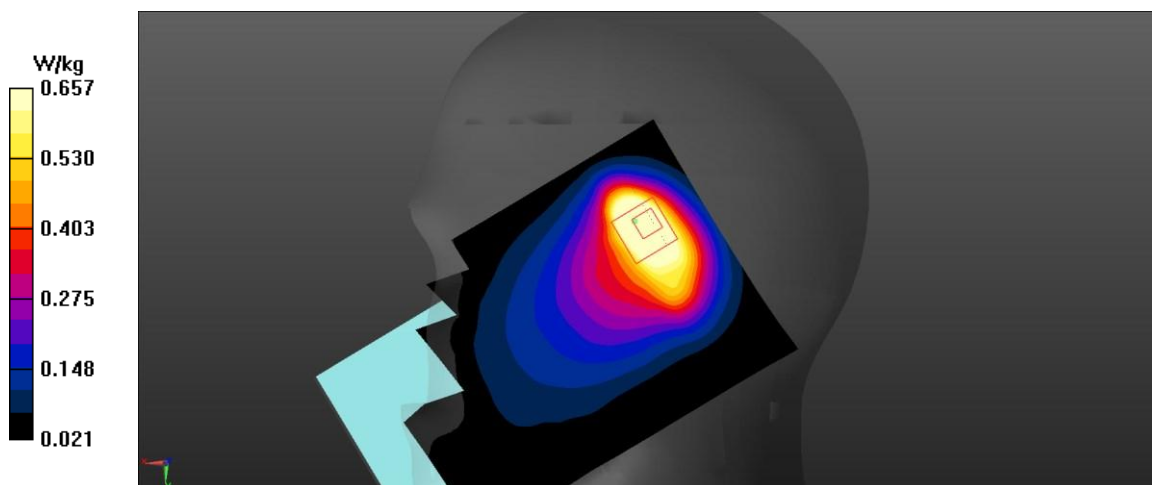

Fig A.17

LTE700-FDD12_CH23095 Left Edge 1RB-High 10mm

Date: 1/10/2024

Electronics: DAE4 Sn1601

Medium: head 750 MHz

Medium parameters used: $f = 707.5$; $\sigma = 0.916$ mho/m; $\epsilon_r = 56.18$; $\rho = 1000$ kg/m³

Ambient Temperature: 22.5°C, Liquid Temperature: 22.3°C

Communication System: LTE700-FDD12 707.5 MHz Duty Cycle: 1:1

Probe: EX3DV4 – SN3846 ConvF(8.98,8.99,10.08)

Area Scan (71x121x1): Interpolated grid: dx=1.200 mm, dy=1.200 mm

Maximum value of SAR (interpolated) = 0.373 W/kg

Zoom Scan (7x7x7)/Cube 0: Measurement grid: dx=8mm, dy=8mm, dz=5mm

Reference Value = 18.65 V/m; Power Drift = -0.16 dB

Peak SAR (extrapolated) = 0.494 W/kg

SAR(1 g) = 0.355 W/kg; SAR(10 g) = 0.251 W/kg

Maximum value of SAR (measured) = 0.375 W/kg

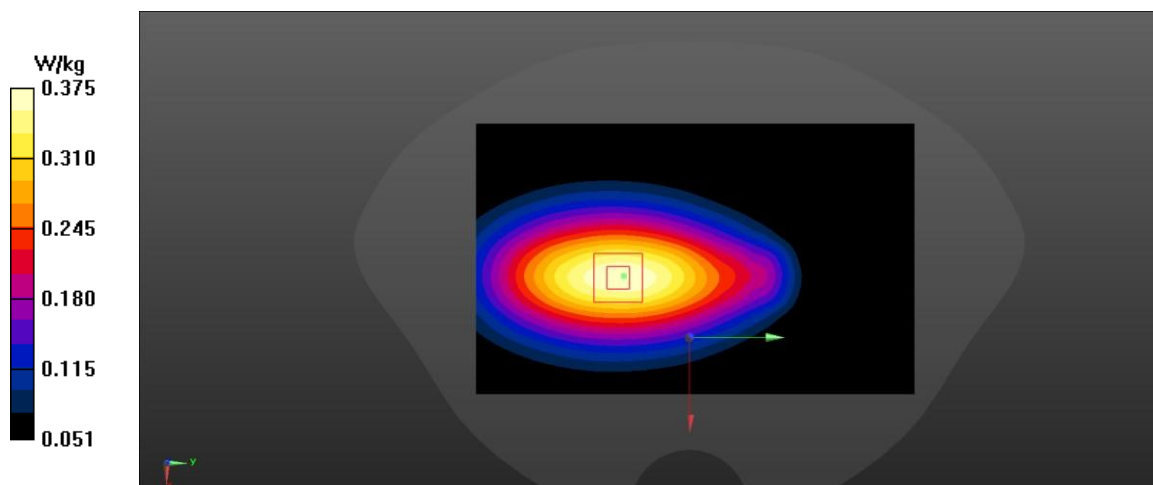

Fig A.18

LTE750-FDD13_CH23230 Right Tilt 1RB-High

Date: 1/10/2024

Electronics: DAE4 Sn1601

Medium: head 750 MHz

Medium parameters used: $f = 782$; $\sigma = 0.92$ mho/m; $\epsilon_r = 41.24$; $\rho = 1000$ kg/m³

Ambient Temperature: 22.5°C, Liquid Temperature: 22.3°C

Communication System: LTE750-FDD13 782 MHz Duty Cycle: 1:1

Probe: EX3DV4 – SN3846 ConvF(8.98,8.99,10.08)

Area Scan (71x121x1): Interpolated grid: dx=1.500 mm, dy=1.500 mm

Maximum value of SAR (interpolated) = 1.09 W/kg

Zoom Scan (7x7x7)/Cube 0: Measurement grid: dx=8mm, dy=8mm, dz=5mm

Reference Value = 22.51 V/m; Power Drift = 0.06 dB

Peak SAR (extrapolated) = 1.46 W/kg

SAR(1 g) = 0.656 W/kg; SAR(10 g) = 0.353 W/kg

Maximum value of SAR (measured) = 0.688 W/kg

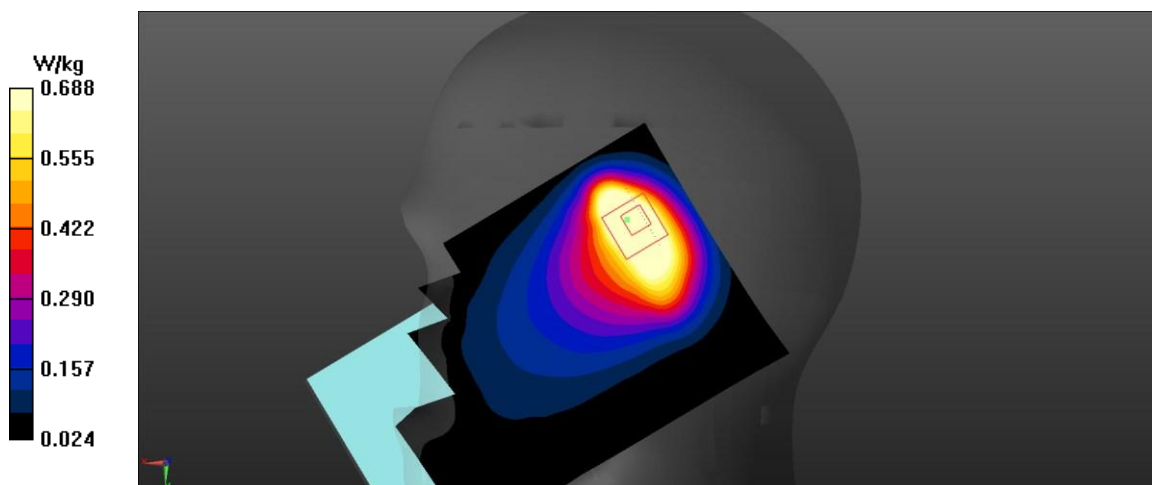

Fig A.19

LTE750-FDD13_CH23230 Left Edge 1RB-High 10mm

Date: 1/10/2024

Electronics: DAE4 Sn1601

Medium: head 750 MHz

Medium parameters used: $f = 782$; $\sigma = 0.986$ mho/m; $\epsilon_r = 56.09$; $\rho = 1000$ kg/m³

Ambient Temperature: 22.5°C, Liquid Temperature: 22.3°C

Communication System: LTE750-FDD13 782 MHz Duty Cycle: 1:1

Probe: EX3DV4 – SN3846 ConvF(8.98,8.99,10.08)

Area Scan (71x121x1): Interpolated grid: dx=1.500 mm, dy=1.500 mm

Maximum value of SAR (interpolated) = 0.522 W/kg

Zoom Scan (7x7x7)/Cube 0: Measurement grid: dx=8mm, dy=8mm, dz=5mm

Reference Value = 19.81 V/m; Power Drift = 0.06 dB

Peak SAR (extrapolated) = 0.691 W/kg

SAR(1 g) = 0.498 W/kg; SAR(10 g) = 0.349 W/kg

Maximum value of SAR (measured) = 0.529 W/kg

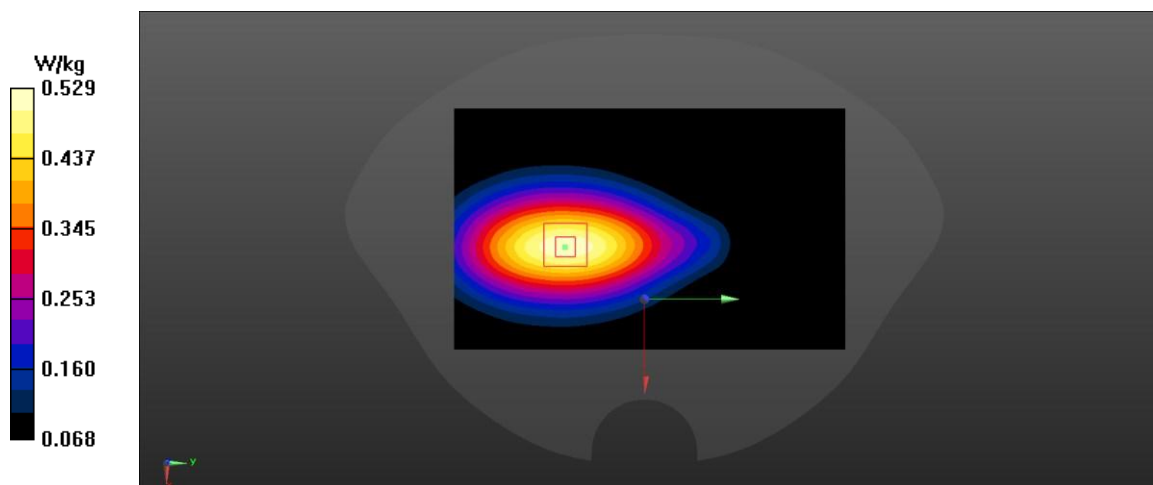

Fig A.20

LTE1900-FDD25_CH26365 Left Cheek 50RB-Middle

Date: 1/13/2024

Electronics: DAE4 Sn1601

Medium: head 1900 MHz

Medium parameters used: $f = 1882.5$; $\sigma = 1.391$ mho/m; $\epsilon_r = 40.76$; $\rho = 1000$ kg/m³

Ambient Temperature: 22.5°C, Liquid Temperature: 22.3°C

Communication System: LTE1900-FDD25 1882.5 MHz Duty Cycle: 1:1

Probe: EX3DV4 – SN3846 ConvF(7.27,7.55,8.11)

Area Scan (71x121x1): Interpolated grid: dx=1.500 mm, dy=1.500 mm

Maximum value of SAR (interpolated) = 1.12 W/kg

Zoom Scan (7x7x7)/Cube 0: Measurement grid: dx=8mm, dy=8mm, dz=5mm

Reference Value = 9.112 V/m; Power Drift = -0.27 dB

Peak SAR (extrapolated) = 1.09 W/kg

SAR(1 g) = 0.591 W/kg; SAR(10 g) = 0.331 W/kg

Maximum value of SAR (measured) = 0.654W/kg

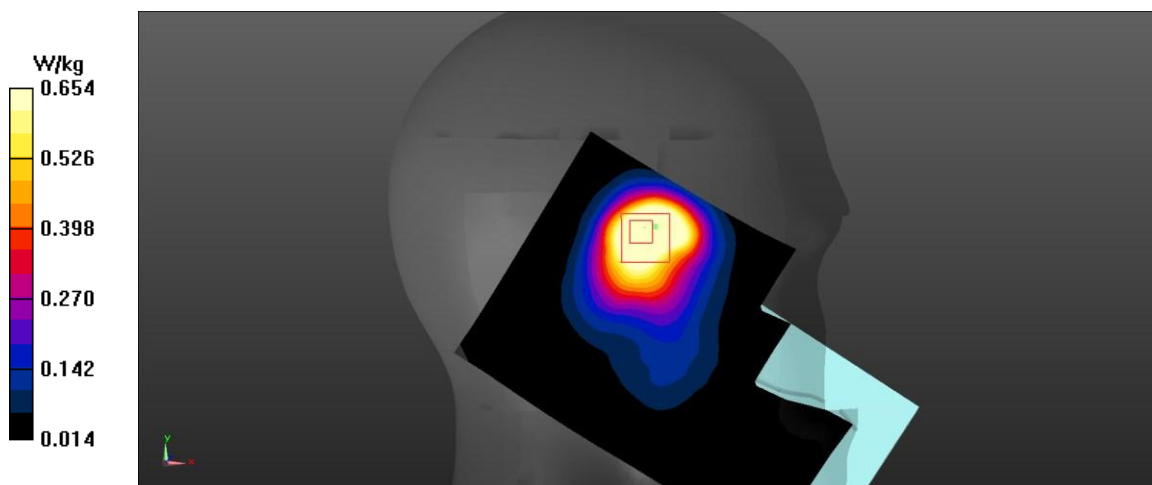

Fig A.21

LTE1900-FDD25_CH26365 Right Edge 1RB-Middle 10mm

Date: 1/13/2024

Electronics: DAE4 Sn1601

Medium: head 1900 MHz

Medium parameters used: $f = 1882.5$; $\sigma = 1.498$ mho/m; $\epsilon_r = 52.5$; $\rho = 1000$ kg/m³

Ambient Temperature: 22.5°C, Liquid Temperature: 22.3°C

Communication System: LTE1900-FDD25 1882.5 MHz Duty Cycle: 1:1

Probe: EX3DV4 – SN3846 ConvF(7.27,7.55,8.11)

Area Scan (71x121x1): Interpolated grid: dx=1.500 mm, dy=1.500 mm

Maximum value of SAR (interpolated) = 0.649 W/kg

Zoom Scan (7x7x7)/Cube 0: Measurement grid: dx=8mm, dy=8mm, dz=5mm

Reference Value = 20.34 V/m; Power Drift = -0.08dB

Peak SAR (extrapolated) = 1.03 W/kg

SAR(1 g) = 0.59 W/kg; SAR(10 g) = 0.328 W/kg

Maximum value of SAR (measured) = 0.666 W/kg

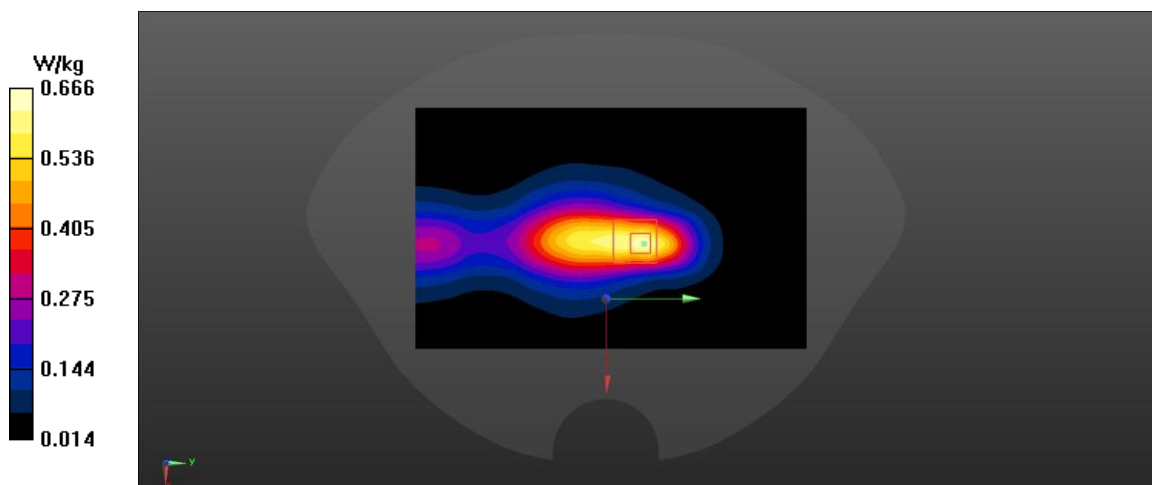

Fig A.22

LTE1900-FDD25_CH26140 Rear 50RB-Middle 15mm

Date: 1/13/2024

Electronics: DAE4 Sn1601

Medium: head 1900 MHz

Medium parameters used: $f = 1860$; $\sigma = 1.477$ mho/m; $\epsilon_r = 52.53$; $\rho = 1000$ kg/m³

Ambient Temperature: 22.5°C, Liquid Temperature: 22.3°C

Communication System: LTE1900-FDD25 1860 MHz Duty Cycle: 1:1

Probe: EX3DV4 – SN3846 ConvF(7.27,7.55,8.11)

Area Scan (71x121x1): Interpolated grid: dx=1.500 mm, dy=1.500 mm

Maximum value of SAR (interpolated) = 0.321 W/kg

Zoom Scan (7x7x7)/Cube 0: Measurement grid: dx=8mm, dy=8mm, dz=5mm

Reference Value = 11.81 V/m; Power Drift = -0.17 dB

Peak SAR (extrapolated) = 0.472 W/kg

SAR(1 g) = 0.287 W/kg; SAR(10 g) = 0.172 W/kg

Maximum value of SAR (measured) = 0.311 W/kg

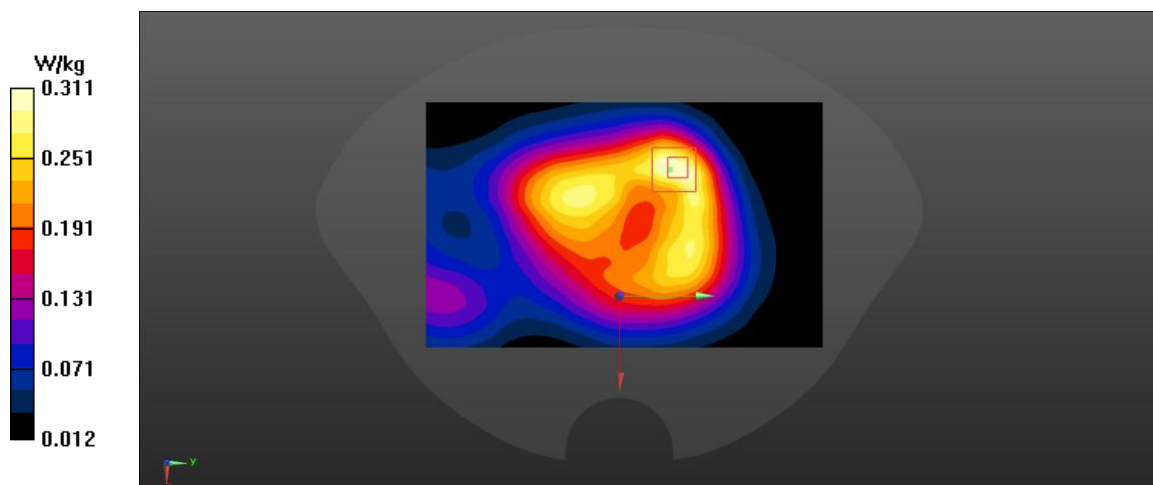

Fig A.23

LTE850-FDD26_CH26865 Right Tilt 1RB-Low

Date: 1/11/2024

Electronics: DAE4 Sn1601

Medium: head 835 MHz

Medium parameters used: $f = 831.5$; $\sigma = 0.895$ mho/m; $\epsilon_r = 40.92$; $\rho = 1000$ kg/m³

Ambient Temperature: 22.5°C, Liquid Temperature: 22.3°C

Communication System: LTE850-FDD26 831.5 MHz Duty Cycle: 1:1

Probe: EX3DV4 – SN3846 ConvF(8.50,9.01,9.47)

Area Scan (71x121x1): Interpolated grid: dx=1.500 mm, dy=1.500 mm

Maximum value of SAR (interpolated) = 1.19 W/kg

Zoom Scan (7x7x7)/Cube 0: Measurement grid: dx=8mm, dy=8mm, dz=5mm

Reference Value = 24.28 V/m; Power Drift = -0.11 dB

Peak SAR (extrapolated) = 1.73 W/kg

SAR(1 g) = 0.757 W/kg; SAR(10 g) = 0.397 W/kg

Maximum value of SAR (measured) = 0.846 W/kg

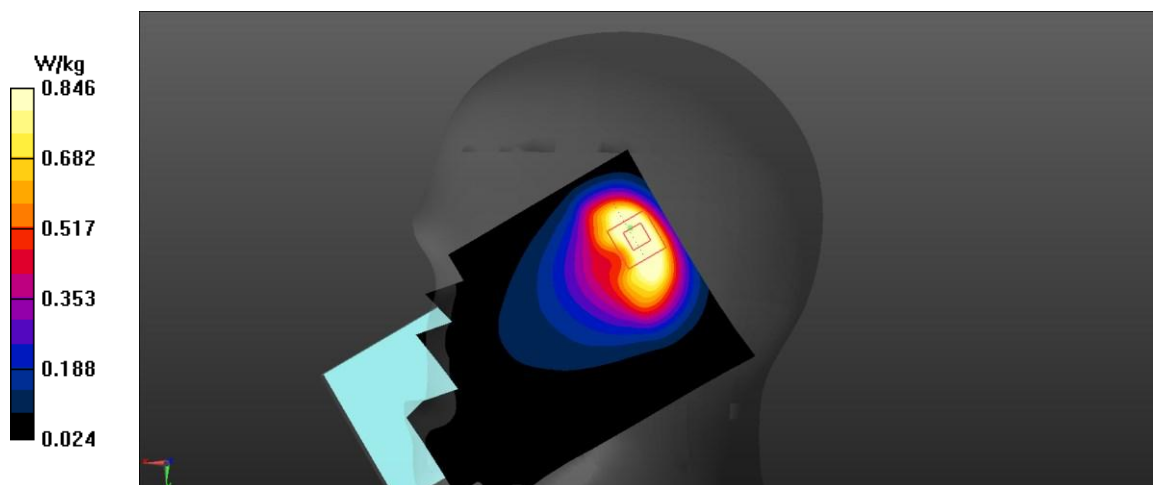

Fig A.24

LTE850-FDD26_CH26775 Top Edge 1RB-Low 10mm

Date: 1/11/2024

Electronics: DAE4 Sn1601

Medium: head 835 MHz

Medium parameters used: $f = 822.5$; $\sigma = 0.952$ mho/m; $\epsilon_r = 55.67$; $\rho = 1000$ kg/m³

Ambient Temperature: 22.5°C, Liquid Temperature: 22.3°C

Communication System: LTE850-FDD26 822.5 MHz Duty Cycle: 1:1

Probe: EX3DV4 – SN3846 ConvF(8.50,9.01,9.47)

Area Scan (71x121x1): Interpolated grid: dx=1.500 mm, dy=1.500 mm

Maximum value of SAR (interpolated) = 0.52 W/kg

Zoom Scan (7x7x7)/Cube 0: Measurement grid: dx=8mm, dy=8mm, dz=5mm

Reference Value = 23.35 V/m; Power Drift = -0.06 dB

Peak SAR (extrapolated) = 0.933 W/kg

SAR(1 g) = 0.499 W/kg; SAR(10 g) = 0.27 W/kg

Maximum value of SAR (measured) = 0.561 W/kg

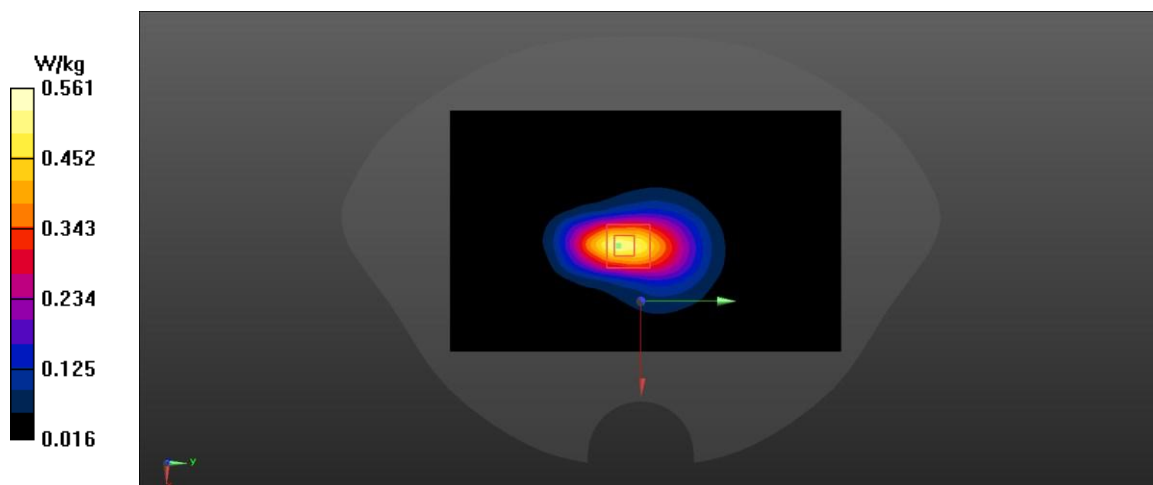

Fig A.25

LTE2600-TDD41 CH40185 Right Cheek 1RB-High

Date: 1/14/2024

Electronics: DAE4 Sn1601

Medium: head 2600 MHz

Medium parameters used: $f = 2549.5$; $\sigma =$ mho/m; $\epsilon_r =$; $\rho = 1000 \text{ kg/m}^3$

Ambient Temperature: 22.5°C, Liquid Temperature: 22.3°C

Communication System: Max 2549.5 Duty Cycle: 1:1.58

Probe: EX3DV4 – SN3846 ConvF(6.72,7.04,7.50)

Area Scan (71x121x1): Interpolated grid: $dx=1.200 \text{ mm}$, $dy=1.200 \text{ mm}$

Maximum value of SAR (interpolated) = 0.937 W/kg

Zoom Scan (7x7x7)/Cube 0: Measurement grid: $dx=5\text{mm}$, $dy=5\text{mm}$, $dz=5\text{mm}$

Reference Value = 5.212 V/m; Power Drift = 0.05dB

Peak SAR (extrapolated) = 1.14 W/kg

SAR(1 g) = 0.533 W/kg; SAR(10 g) = 0.256 W/kg

Maximum value of SAR (measured) = 0.609 W/kg

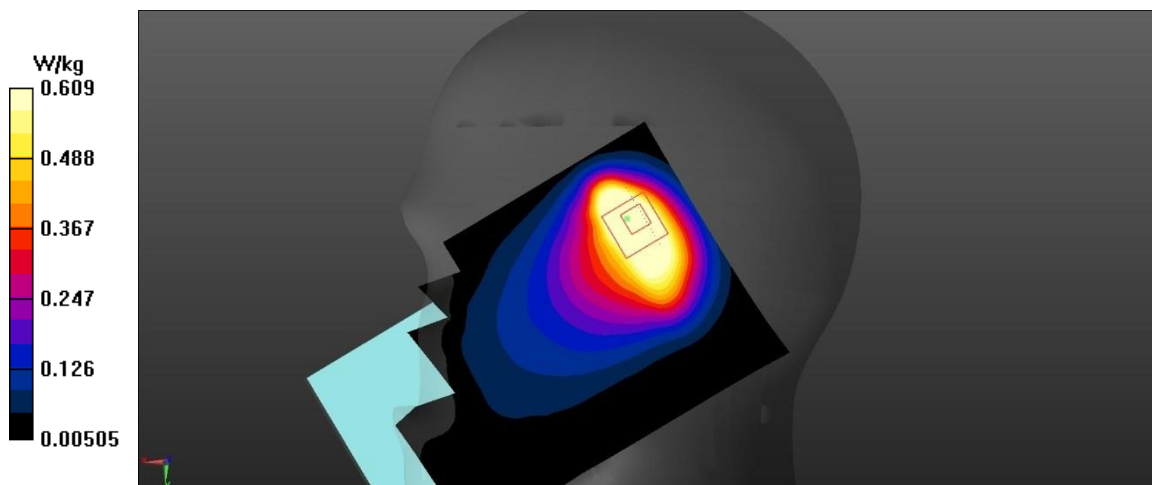

Fig A.26

LTE2600-TDD41 CH39750 Rear 1RB-Low 10mm

Date: 1/14/2024

Electronics: DAE4 Sn1601

Medium: head 2600 MHz

Medium parameters used: $f = 2506$; $\sigma =$ mho/m; $\epsilon_r =$; $\rho = 1000 \text{ kg/m}^3$

Ambient Temperature: 22.5°C, Liquid Temperature: 22.3°C

Communication System: Max 2506 Duty Cycle: 1:1.58

Probe: EX3DV4 – SN3846 ConvF(6.72,7.04,7.50)

Area Scan (71x121x1): Interpolated grid: $dx=1.200 \text{ mm}$, $dy=1.200 \text{ mm}$

Maximum value of SAR (interpolated) = 0.487 W/kg

Zoom Scan (7x7x7)/Cube 0: Measurement grid: $dx=5\text{mm}$, $dy=5\text{mm}$, $dz=5\text{mm}$

Reference Value = 7.043 V/m; Power Drift = 0.01dB

Peak SAR (extrapolated) = 0.8 W/kg

SAR(1 g) = 0.414 W/kg; SAR(10 g) = 0.213 W/kg

Maximum value of SAR (measured) = 0.453 W/kg

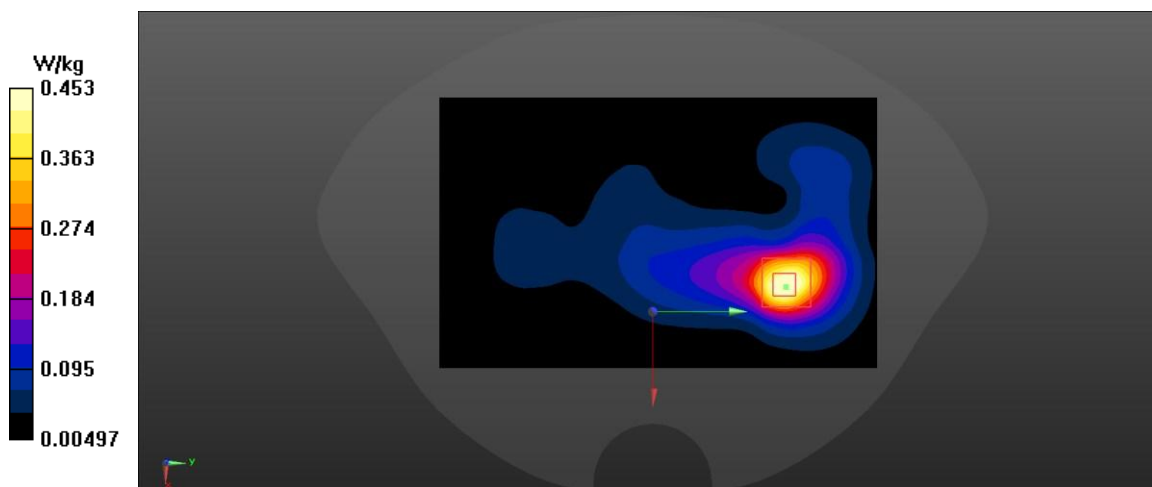

Fig A.27

LTE2600-TDD41 CH39750 Rear 1RB-Low 15mm

Date: 1/14/2024

Electronics: DAE4 Sn1601

Medium: head 2600 MHz

Medium parameters used: $f = 2506$; $\sigma =$ mho/m; $\epsilon_r =$; $\rho = 1000 \text{ kg/m}^3$

Ambient Temperature: 22.5°C, Liquid Temperature: 22.3°C

Communication System: Max 2506 Duty Cycle: 1:1.58

Probe: EX3DV4 – SN3846 ConvF(6.72,7.04,7.50)

Area Scan (71x121x1): Interpolated grid: $dx=1.200 \text{ mm}$, $dy=1.200 \text{ mm}$

Maximum value of SAR (interpolated) = 0.267 W/kg

Zoom Scan (7x7x7)/Cube 0: Measurement grid: $dx=5\text{mm}$, $dy=5\text{mm}$, $dz=5\text{mm}$

Reference Value = 6.645 V/m; Power Drift = -0.17 dB

Peak SAR (extrapolated) = 0.499 W/kg

SAR(1 g) = 0.243 W/kg; SAR(10 g) = 0.135 W/kg

Maximum value of SAR (measured) = 0.263 W/kg

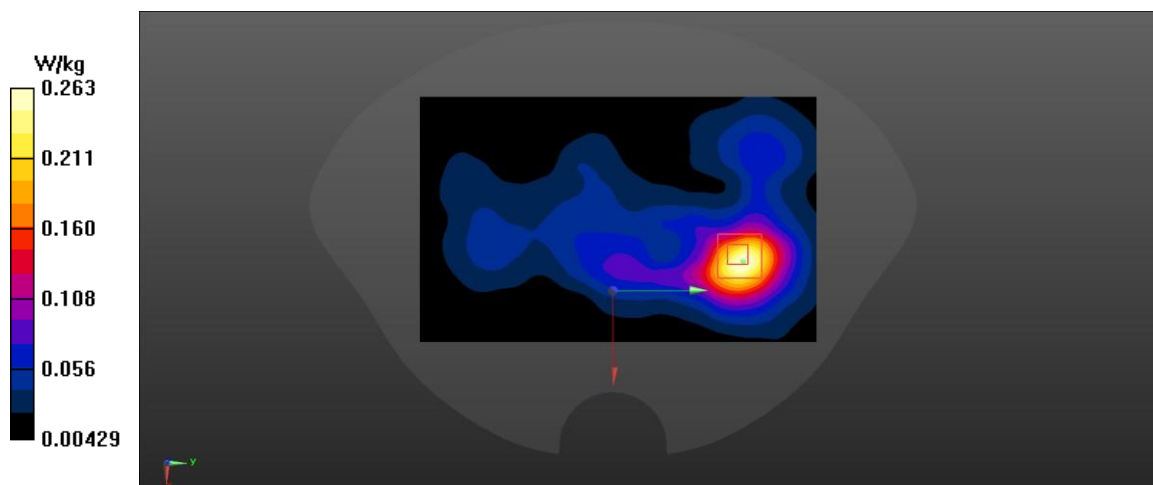

Fig A.28

LTE2600-TDD41 CH39750 Right Cheek 50RB-Low

Date: 1/14/2024

Electronics: DAE4 Sn1601

Medium: head 2600 MHz

Medium parameters used: $f = 2506$; $\sigma =$ mho/m; $\epsilon_r =$; $\rho = 1000 \text{ kg/m}^3$

Ambient Temperature: 22.5°C, Liquid Temperature: 22.3°C

Communication System: Max 2506 Duty Cycle: 1:1.58

Probe: EX3DV4 – SN3846 ConvF(6.72,7.04,7.50)

Area Scan (71x121x1): Interpolated grid: $dx=1.200 \text{ mm}$, $dy=1.200 \text{ mm}$

Maximum value of SAR (interpolated) = 1.12 W/kg

Zoom Scan (7x7x7)/Cube 0: Measurement grid: $dx=5\text{mm}$, $dy=5\text{mm}$, $dz=5\text{mm}$

Reference Value = 5.605 V/m; Power Drift = 0.17 dB

Peak SAR (extrapolated) = 1.34 W/kg

SAR(1 g) = 0.633 W/kg; SAR(10 g) = 0.306 W/kg

Maximum value of SAR (measured) = 0.721 W/kg

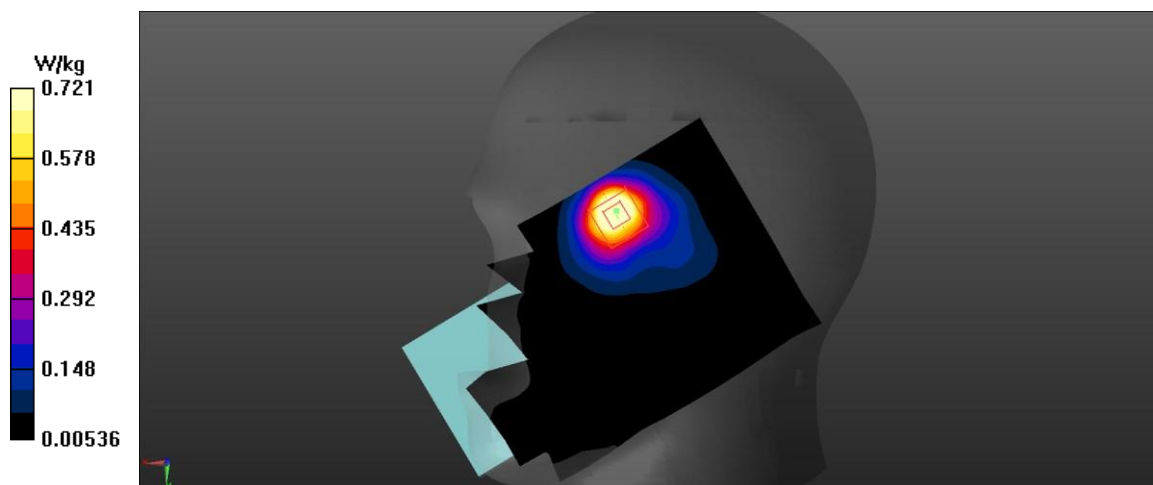

Fig A.29

LTE2600-TDD41 CH39750 Rear 50RB-Low 10mm

Date: 1/14/2024

Electronics: DAE4 Sn1601

Medium: head 2600 MHz

Medium parameters used: $f = 2506$; $\sigma =$ mho/m; $\epsilon_r =$; $\rho = 1000 \text{ kg/m}^3$

Ambient Temperature: 22.5°C, Liquid Temperature: 22.3°C

Communication System: Max 2506 Duty Cycle: 1:1.58

Probe: EX3DV4 – SN3846 ConvF(6.72,7.04,7.50)

Area Scan (71x121x1): Interpolated grid: $dx=1.200 \text{ mm}$, $dy=1.200 \text{ mm}$

Maximum value of SAR (interpolated) = 0.563 W/kg

Zoom Scan (7x7x7)/Cube 0: Measurement grid: $dx=5\text{mm}$, $dy=5\text{mm}$, $dz=5\text{mm}$

Reference Value = 7.566 V/m; Power Drift = -0.07 dB

Peak SAR (extrapolated) = 0.965 W/kg

SAR(1 g) = 0.507 W/kg; SAR(10 g) = 0.264 W/kg

Maximum value of SAR (measured) = 0.554 W/kg

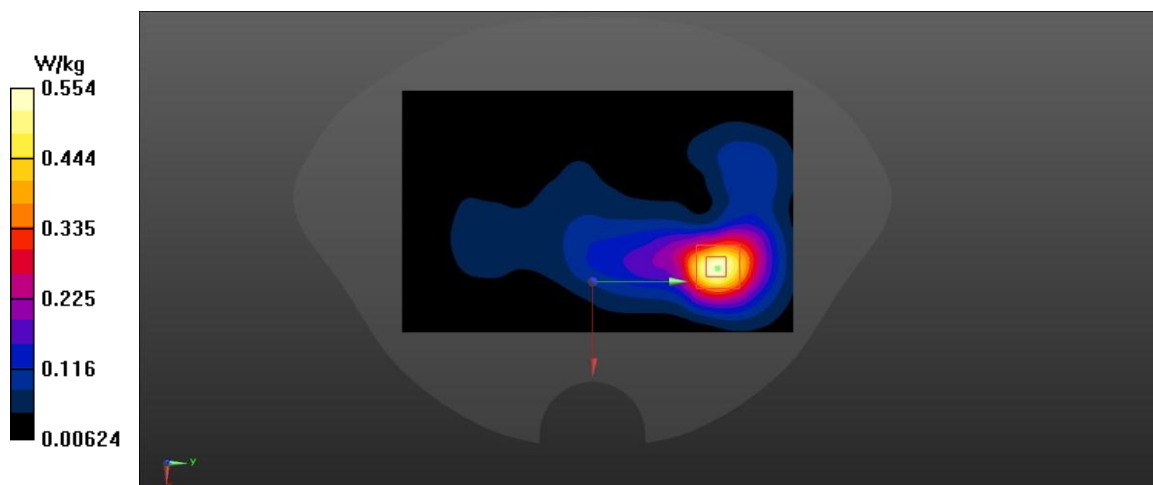

Fig A.30

LTE2600-TDD41 CH40620 Rear 50RB-Low 15mm

Date: 1/14/2024

Electronics: DAE4 Sn1601

Medium: head 2600 MHz

Medium parameters used: $f = 2593$; $\sigma =$ mho/m; $\epsilon_r =$; $\rho = 1000 \text{ kg/m}^3$

Ambient Temperature: 22.5°C, Liquid Temperature: 22.3°C

Communication System: Max 2593 Duty Cycle: 1:1.58

Probe: EX3DV4 – SN3846 ConvF(6.72,7.04,7.50)

Area Scan (71x121x1): Interpolated grid: $dx=1.200 \text{ mm}$, $dy=1.200 \text{ mm}$

Maximum value of SAR (interpolated) = 0.422 W/kg

Zoom Scan (7x7x7)/Cube 0: Measurement grid: $dx=5\text{mm}$, $dy=5\text{mm}$, $dz=5\text{mm}$

Reference Value = 7.379 V/m; Power Drift = 0.10dB

Peak SAR (extrapolated) = 0.7 W/kg

SAR(1 g) = 0.385 W/kg; SAR(10 g) = 0.21 W/kg

Maximum value of SAR (measured) = 0.417 W/kg

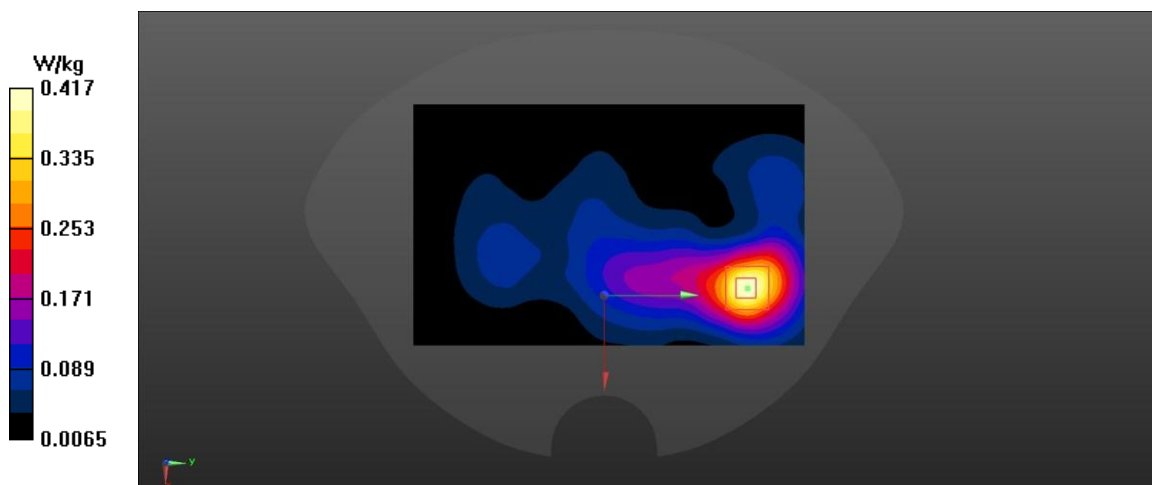

Fig A.31

LTE1700-FDD66_CH132072 Left Cheek 1RB-Low

Date: 1/12/2024

Electronics: DAE4 Sn1601

Medium: head 1750 MHz

Medium parameters used: $f = 1720$; $\sigma = 2.159$ mho/m; $\epsilon_r = 38.68$; $\rho = 1000$ kg/m³

Ambient Temperature: 22.5°C, Liquid Temperature: 22.3°C

Communication System: LTE1700-FDD66 2593 Duty Cycle: 1:1

Probe: EX3DV4 – SN3846 ConvF(7.47,7.79,8.45)

Area Scan (71x121x1): Interpolated grid: dx=1.500 mm, dy=1.500 mm

Maximum value of SAR (interpolated) = 1.21 W/kg

Zoom Scan (7x7x7)/Cube 0: Measurement grid: dx=8mm, dy=8mm, dz=5mm

Reference Value = 12.17 V/m; Power Drift = -0.25 dB

Peak SAR (extrapolated) = 1.23 W/kg

SAR(1 g) = 0.691 W/kg; SAR(10 g) = 0.405 W/kg

Maximum value of SAR (measured) = 0.747 W/kg

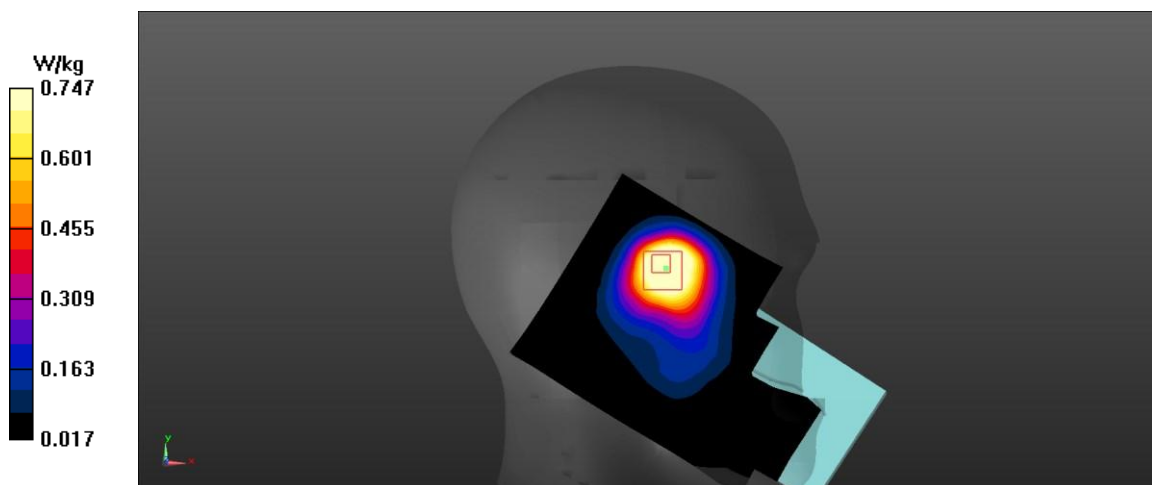

Fig A.32

LTE1700-FDD66_CH132072 Right Edge 50RB-Low 10mm

Date: 1/12/2024

Electronics: DAE4 Sn1601

Medium: head 1750 MHz

Medium parameters used: $f = 1720$; $\sigma = 2.301$ mho/m; $\epsilon_r = 51.51$; $\rho = 1000$ kg/m³

Ambient Temperature: 22.5°C, Liquid Temperature: 22.3°C

Communication System: LTE1700-FDD66 2593 Duty Cycle: 1:1

Probe: EX3DV4 – SN3846 ConvF(7.47,7.79,8.45)

Area Scan (71x121x1): Interpolated grid: dx=1.500 mm, dy=1.500 mm

Maximum value of SAR (interpolated) = 0.41 W/kg

Zoom Scan (7x7x7)/Cube 0: Measurement grid: dx=8mm, dy=8mm, dz=5mm

Reference Value = 15.44 V/m; Power Drift = 0.15 dB

Peak SAR (extrapolated) = 0.641 W/kg

SAR(1 g) = 0.374 W/kg; SAR(10 g) = 0.216 W/kg

Maximum value of SAR (measured) = 0.414 W/kg

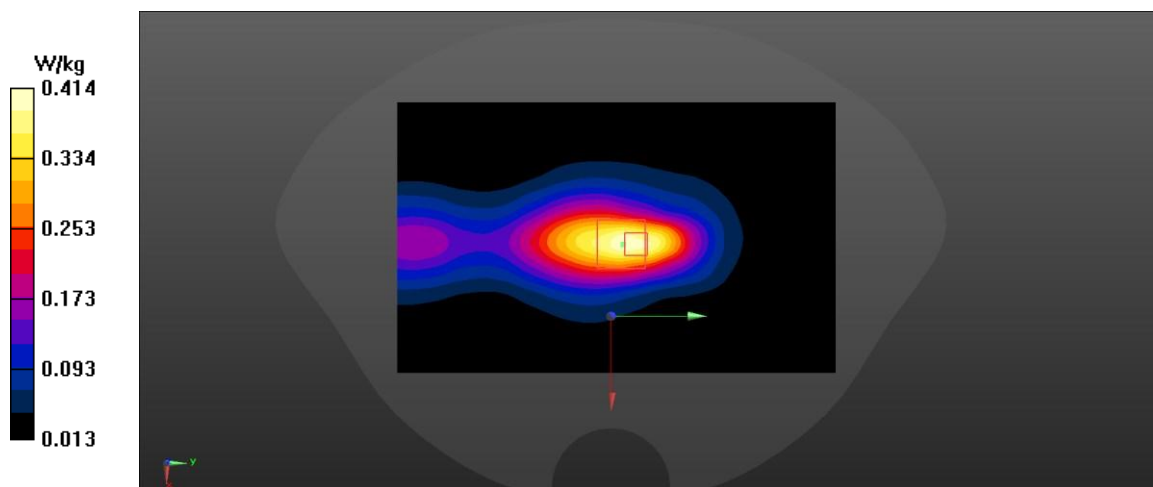

Fig A.33

LTE1700-FDD66_CH132572 Front 50RB-Middle 15mm

Date: 1/12/2024

Electronics: DAE4 Sn1601

Medium: head 1750 MHz

Medium parameters used: $f = 1770$; $\sigma = 2.301$ mho/m; $\epsilon_r = 51.51$; $\rho = 1000$ kg/m³

Ambient Temperature: 22.5°C, Liquid Temperature: 22.3°C

Communication System: LTE1700-FDD66 2593 Duty Cycle: 1:1

Probe: EX3DV4 – SN3846 ConvF(7.47,7.79,8.45)

Area Scan (71x121x1): Interpolated grid: dx=1.500 mm, dy=1.500 mm

Maximum value of SAR (interpolated) = 0.226 W/kg

Zoom Scan (7x7x7)/Cube 0: Measurement grid: dx=8mm, dy=8mm, dz=5mm

Reference Value = 12.53 V/m; Power Drift = 0.06 dB

Peak SAR (extrapolated) = 0.301 W/kg

SAR(1 g) = 0.212 W/kg; SAR(10 g) = 0.148 W/kg

Maximum value of SAR (measured) = 0.225 W/kg

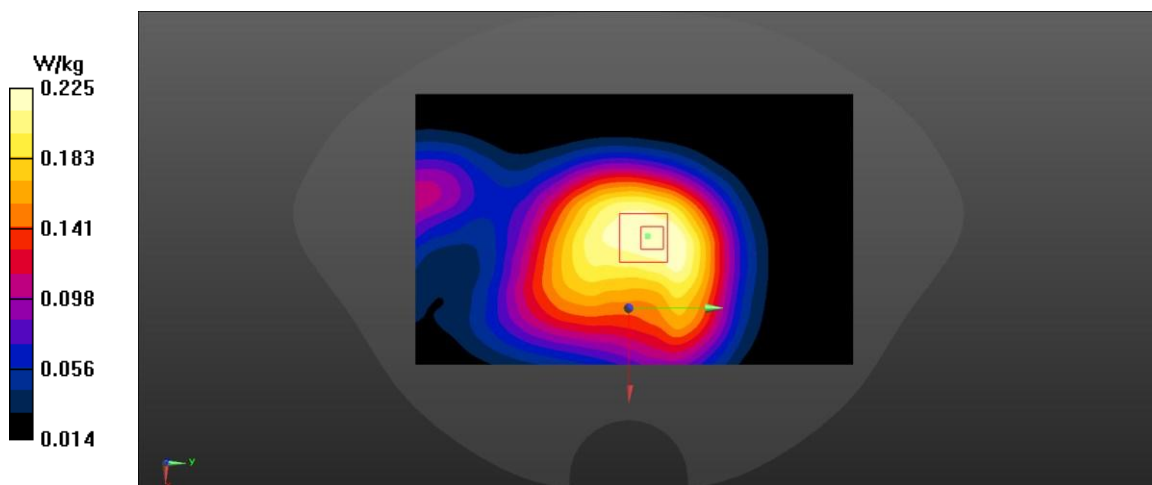

Fig A.34

LTE1700-FDD66_CH132322 Right Cheek 1RB-Middle

Date: 1/12/2024

Electronics: DAE4 Sn1601

Medium: head 1750 MHz

Medium parameters used: $f = 1745$; $\sigma = 2.159$ mho/m; $\epsilon_r = 38.68$; $\rho = 1000$ kg/m³

Ambient Temperature: 22.5°C, Liquid Temperature: 22.3°C

Communication System: LTE1700-FDD66 2593 Duty Cycle: 1:1

Probe: EX3DV4 – SN3846 ConvF(7.47,7.79,8.45)

Area Scan (71x121x1): Interpolated grid: dx=1.500 mm, dy=1.500 mm

Maximum value of SAR (interpolated) = 0.17 W/kg

Zoom Scan (7x7x7)/Cube 0: Measurement grid: dx=8mm, dy=8mm, dz=5mm

Reference Value = 5.366 V/m; Power Drift = 0.25 dB

Peak SAR (extrapolated) = 0.236 W/kg

SAR(1 g) = 0.164 W/kg; SAR(10 g) = 0.108 W/kg

Maximum value of SAR (measured) = 0.176 W/kg

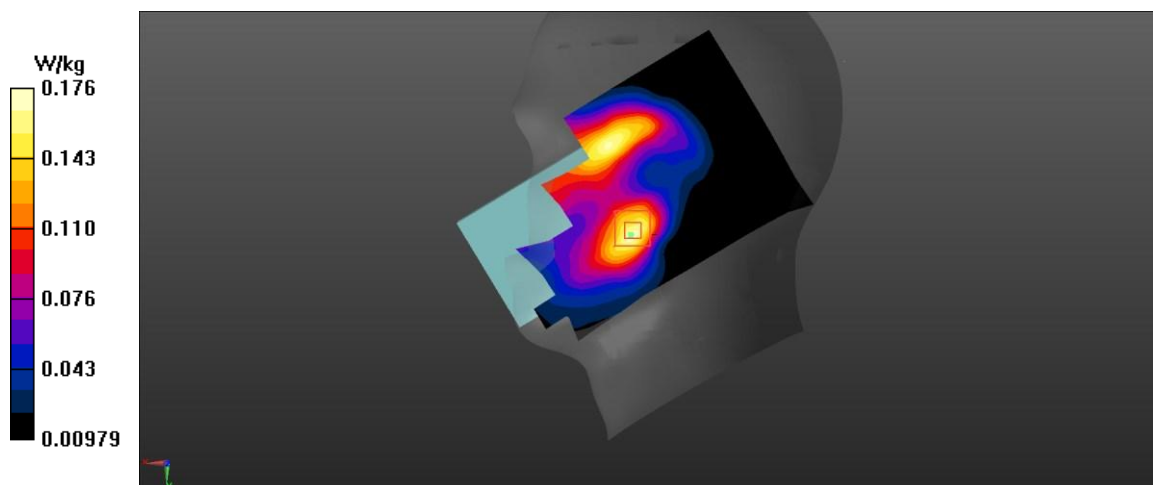

Fig A.35

LTE1700-FDD66_CH132322 Bottom Edge 50RB-Middle 10mm

Date: 1/12/2024

Electronics: DAE4 Sn1601

Medium: head 1750 MHz

Medium parameters used: $f = 1745$; $\sigma = 2.301$ mho/m; $\epsilon_r = 51.51$; $\rho = 1000$ kg/m³

Ambient Temperature: 22.5°C, Liquid Temperature: 22.3°C

Communication System: LTE1700-FDD66 2593 Duty Cycle: 1:1

Probe: EX3DV4 – SN3846 ConvF(7.47,7.79,8.45)

Area Scan (71x121x1): Interpolated grid: dx=1.500 mm, dy=1.500 mm

Maximum value of SAR (interpolated) = 0.107 W/kg

Zoom Scan (7x7x7)/Cube 0: Measurement grid: dx=8mm, dy=8mm, dz=5mm

Reference Value = 8.741 V/m; Power Drift = -0.04dB

Peak SAR (extrapolated) = 0.149 W/kg

SAR(1 g) = 0.093 W/kg; SAR(10 g) = 0.053 W/kg

Maximum value of SAR (measured) = 0.102 W/kg

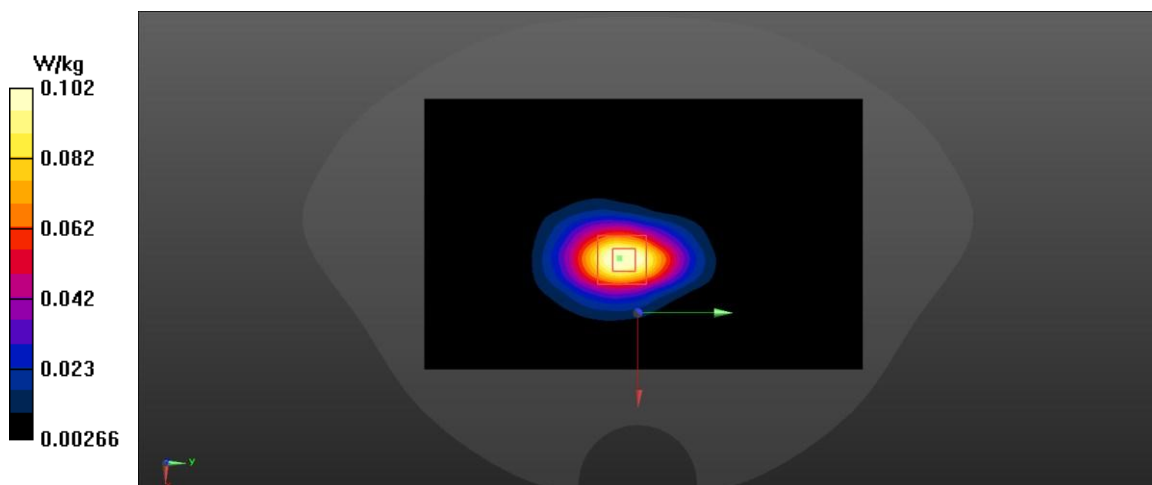

Fig A.36

LTE1700-FDD66_CH132322 Rear 50RB-High 15mm

Date: 1/12/2024

Electronics: DAE4 Sn1601

Medium: head 1750 MHz

Medium parameters used: $f = 1745$; $\sigma = 2.301$ mho/m; $\epsilon_r = 51.51$; $\rho = 1000$ kg/m³

Ambient Temperature: 22.5°C, Liquid Temperature: 22.3°C

Communication System: LTE1700-FDD66 2593 Duty Cycle: 1:1

Probe: EX3DV4 – SN3846 ConvF(7.47,7.79,8.45)

Area Scan (71x121x1): Interpolated grid: dx=1.500 mm, dy=1.500 mm

Maximum value of SAR (interpolated) = 0.288 W/kg

Zoom Scan (7x7x7)/Cube 0: Measurement grid: dx=8mm, dy=8mm, dz=5mm

Reference Value = 4.429 V/m; Power Drift = 0.03 dB

Peak SAR (extrapolated) = 0.438 W/kg

SAR(1 g) = 0.288 W/kg; SAR(10 g) = 0.175 W/kg

Maximum value of SAR (measured) = 0.315 W/kg

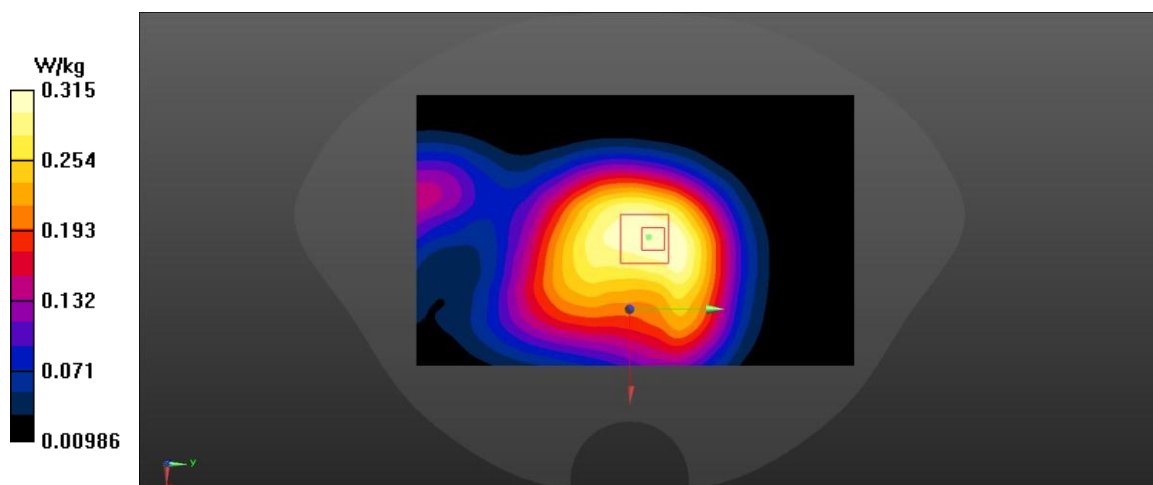

Fig A.37

LTE700-FDD71_CH133372 Right Tilt 1RB-Middle

Date: 1/10/2024

Electronics: DAE4 Sn1601

Medium: head 750 MHz

Medium parameters used: $f = 688$; $\sigma = 2.641$ mho/m; $\epsilon_r = 39.07$; $\rho = 1000$ kg/m³

Ambient Temperature: 22.5°C, Liquid Temperature: 22.3°C

Communication System: LTE700-FDD71 2593 Duty Cycle: 1:1

Probe: EX3DV4 – SN3846 ConvF(8.98,8.99,10.08)

Area Scan (71x121x1): Interpolated grid: dx=1.500 mm, dy=1.500 mm

Maximum value of SAR (interpolated) = 0.865 W/kg

Zoom Scan (7x7x7)/Cube 0: Measurement grid: dx=8mm, dy=8mm, dz=5mm

Reference Value = 19.23 V/m; Power Drift = -0.24 dB

Peak SAR (extrapolated) = 1.02 W/kg

SAR(1 g) = 0.45 W/kg; SAR(10 g) = 0.247 W/kg

Maximum value of SAR (measured) = 0.457 W/kg

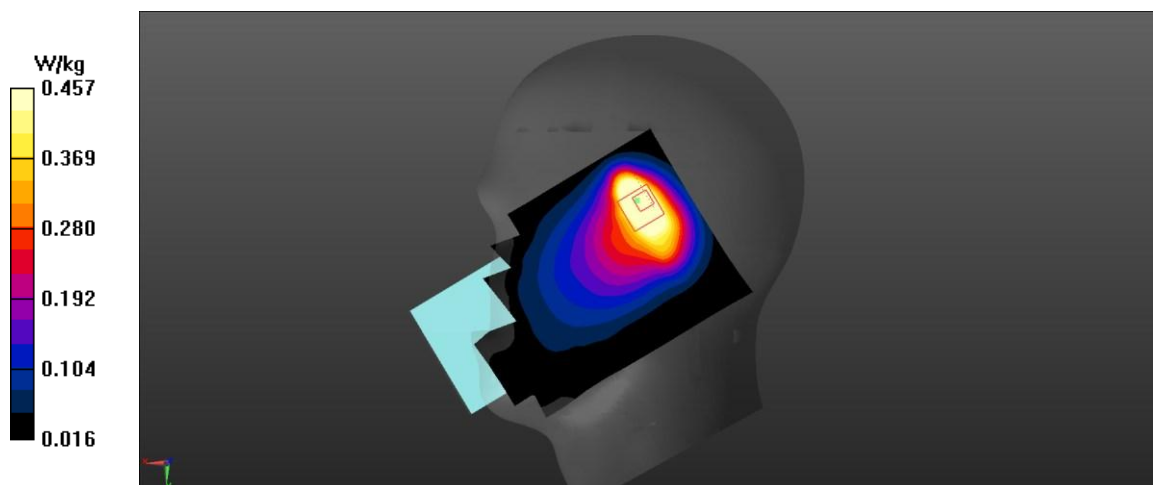

Fig A.38

LTE700-FDD71_CH133372 Left Edge 1RB-Middle 10mm

Date: 1/10/2024

Electronics: DAE4 Sn1601

Medium: head 750 MHz

Medium parameters used: $f = 688$; $\sigma = 2.707$ mho/m; $\epsilon_r = 53.92$; $\rho = 1000$ kg/m³

Ambient Temperature: 22.5°C, Liquid Temperature: 22.3°C

Communication System: LTE700-FDD71 2593 Duty Cycle: 1:1

Probe: EX3DV4 – SN3846 ConvF(8.98,8.99,10.08)

Area Scan (71x121x1): Interpolated grid: dx=1.500 mm, dy=1.500 mm

Maximum value of SAR (interpolated) = 0.377 W/kg

Zoom Scan (7x7x7)/Cube 0: Measurement grid: dx=8mm, dy=8mm, dz=5mm

Reference Value = 19.31 V/m; Power Drift = 0.03 dB

Peak SAR (extrapolated) = 0.49 W/kg

SAR(1 g) = 0.355 W/kg; SAR(10 g) = 0.253 W/kg

Maximum value of SAR (measured) = 0.378 W/kg

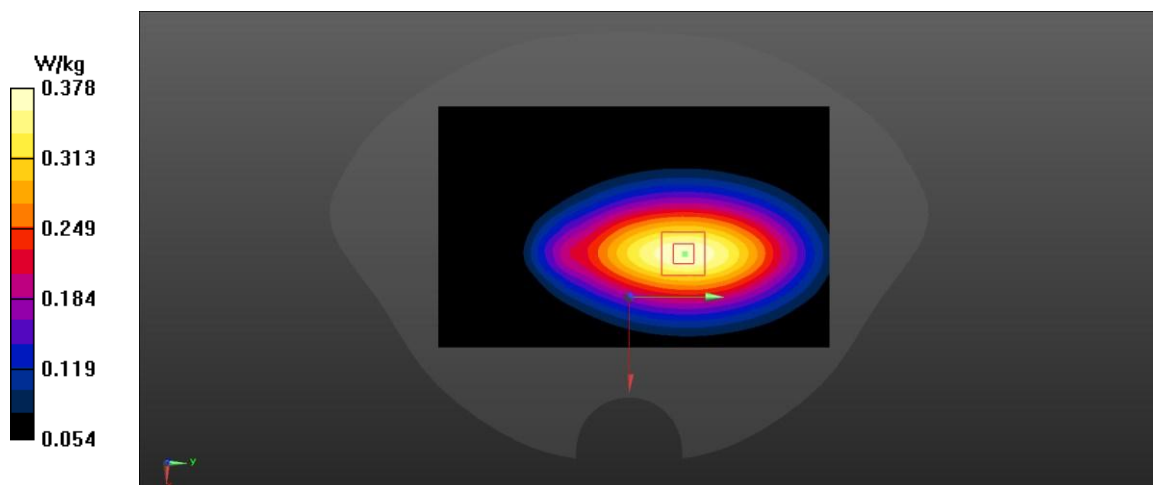

Fig A.39

n25 ANT2_CH381000 Left Cheek

Date: 1/17/2024

Electronics: DAE4 Sn1601

Medium: head 1900 MHz

Medium parameters used: $f = 1905$; $\sigma = 1.409$ mho/m; $\epsilon_r = 39.35$; $\rho = 1000$ kg/m³

Ambient Temperature: 22.5°C, Liquid Temperature: 22.3°C

Communication System: PCS1900 1905 Duty Cycle: 1:1

Probe: EX3DV4 – SN3846 ConvF(7.27,7.55,8.11)

Area Scan (71x121x1): Interpolated grid: dx=1.500 mm, dy=1.500 mm

Maximum value of SAR (interpolated) = 1.27 W/kg

Zoom Scan (7x7x7)/Cube 0: Measurement grid: dx=8mm, dy=8mm, dz=5mm

Reference Value = 11.64 V/m; Power Drift = -0.12 dB

Peak SAR (extrapolated) = 1.73 W/kg

SAR(1 g) = 0.876 W/kg; SAR(10 g) = 0.473 W/kg

Maximum value of SAR (measured) = 1.38W/kg

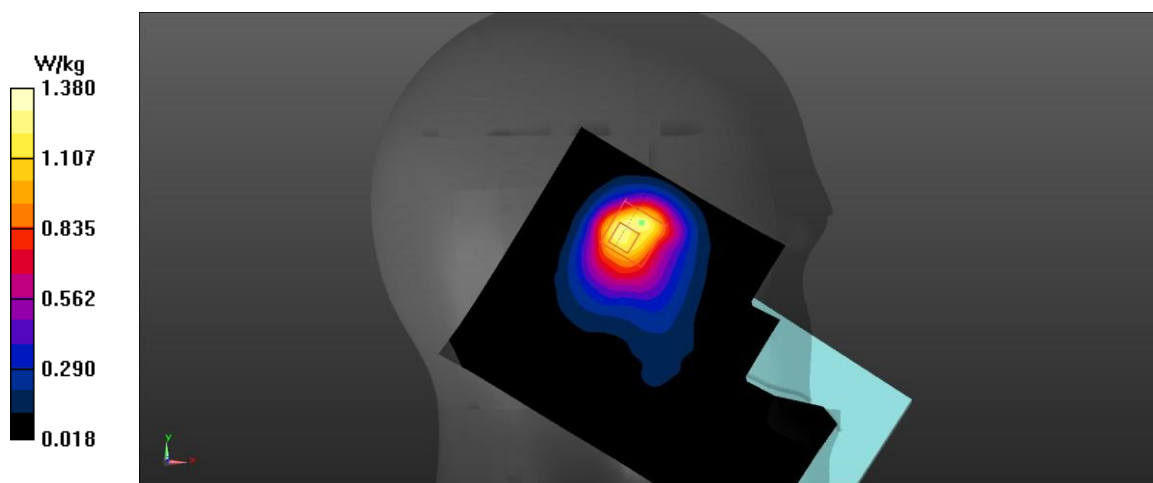

Fig A.40

n25 ANT2_CH370500 Right Edge 10mm

Date: 1/17/2024

Electronics: DAE4 Sn1601

Medium: head 1900 MHz

Medium parameters used: $f = 1852.5$; $\sigma = 1.45$ mho/m; $\epsilon_r = 54$; $\rho = 1000$ kg/m³

Ambient Temperature: 22.5°C, Liquid Temperature: 22.3°C

Communication System: PCS1900 1852.5 Duty Cycle: 1:1

Probe: EX3DV4 – SN3846 ConvF(7.27,7.55,8.11)

Area Scan (71x121x1): Interpolated grid: dx=1.500 mm, dy=1.500 mm

Maximum value of SAR (interpolated) = 0.572 W/kg

Zoom Scan (7x7x7)/Cube 0: Measurement grid: dx=8mm, dy=8mm, dz=5mm

Reference Value = 19.02 V/m; Power Drift = -0.26 dB

Peak SAR (extrapolated) = 0.891 W/kg

SAR(1 g) = 0.519 W/kg; SAR(10 g) = 0.286 W/kg

Maximum value of SAR (measured) = 0.577 W/kg

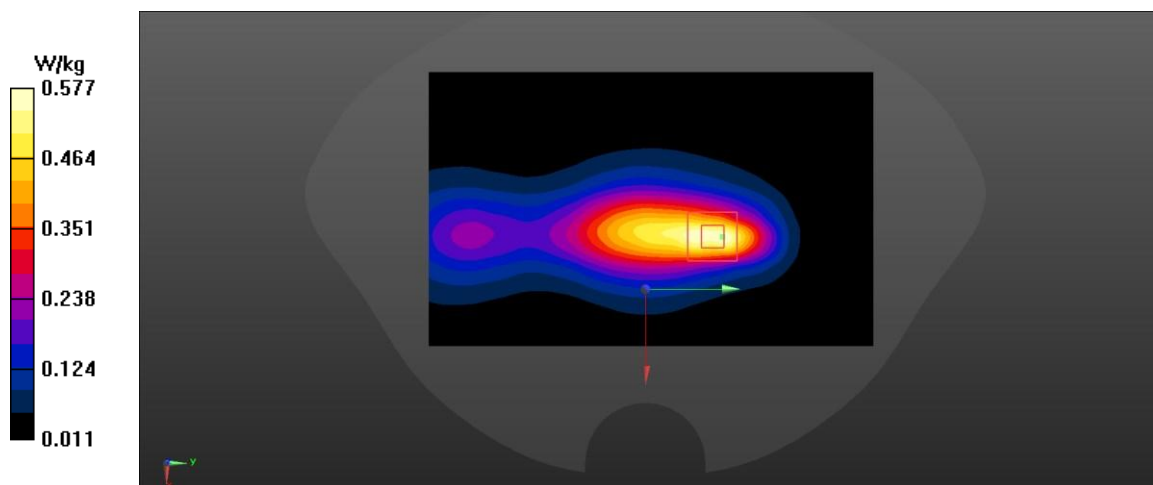

Fig A.41

n25 ANT2_CH370500 Rear 15mm

Date: 1/17/2024

Electronics: DAE4 Sn1601

Medium: head 1900 MHz

Medium parameters used: $f = 1852.5$; $\sigma = 1.45$ mho/m; $\epsilon_r = 54$; $\rho = 1000$ kg/m³

Ambient Temperature: 22.5°C, Liquid Temperature: 22.3°C

Communication System: PCS1900 1852.5 Duty Cycle: 1:1

Probe: EX3DV4 – SN3846 ConvF(7.27,7.55,8.11)

Area Scan (71x121x1): Interpolated grid: dx=1.500 mm, dy=1.500 mm

Maximum value of SAR (interpolated) = 0.336 W/kg

Zoom Scan (7x7x7)/Cube 0: Measurement grid: dx=8mm, dy=8mm, dz=5mm

Reference Value = 10.46 V/m; Power Drift = 0.07 dB

Peak SAR (extrapolated) = 0.51 W/kg

SAR(1 g) = 0.295 W/kg; SAR(10 g) = 0.168 W/kg

Maximum value of SAR (measured) = 0.316 W/kg

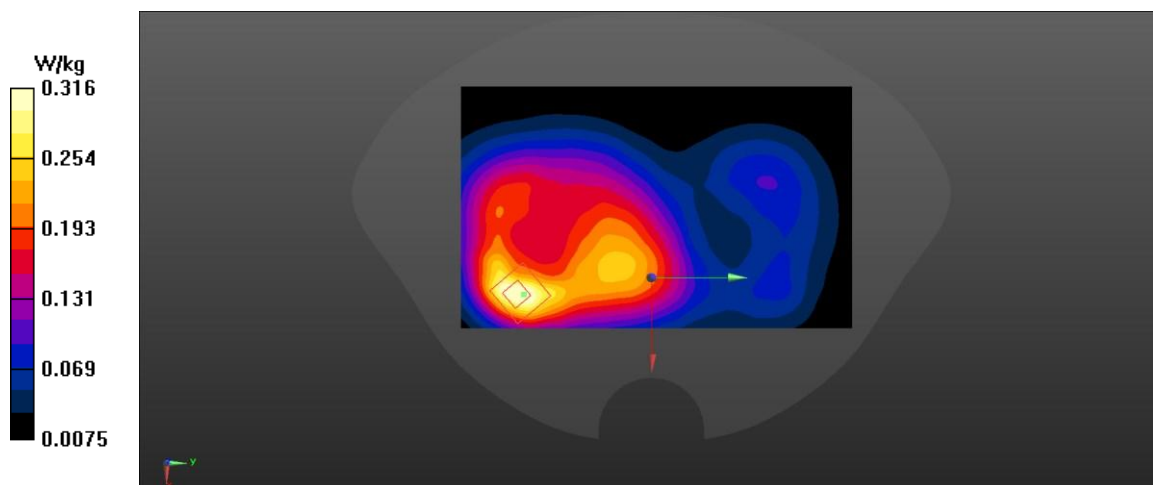

Fig A.42

n41(PC2) ANT1_CH528000 Right Cheek

Date: 1/18/2024

Electronics: DAE4 Sn1601

Medium: head 2600 MHz

Medium parameters used: $f = 2640$; $\sigma = 1.824$ mho/m; $\epsilon_r = 38.842$; $\rho = 1000$ kg/m³

Ambient Temperature: 22.5°C, Liquid Temperature: 22.3°C

Communication System: LTE2500-FDD7 53225 MHz Duty Cycle: 1:1

Probe: EX3DV4 – SN3846 ConvF(6.72,7.04,7.50)

Area Scan (71x121x1): Interpolated grid: dx=1.200 mm, dy=1.200 mm

Maximum value of SAR (interpolated) = 0.281 W/kg

Zoom Scan (7x7x7)/Cube 0: Measurement grid: dx=5mm, dy=5mm, dz=5mm

Reference Value = 2.418 V/m; Power Drift = 0.07 dB

Peak SAR (extrapolated) = 0.301 W/kg

SAR(1 g) = 0.17 W/kg; SAR(10 g) = 0.084 W/kg

Maximum value of SAR (measured) = 0.190 W/kg

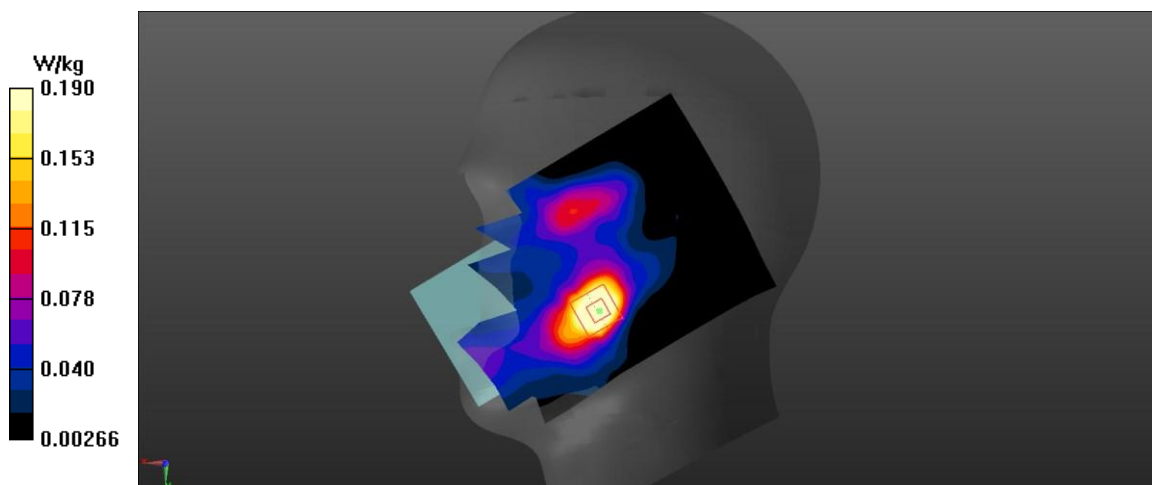

Fig A.43

n41(PC2) ANT1_CH527799 Rear 10mm

Date: 1/18/2024

Electronics: DAE4 Sn1601

Medium: head 2600 MHz

Medium parameters used: $f = 2639$; $\sigma = 1.968$ mho/m; $\epsilon_r = 38.712$; $\rho = 1000$ kg/m³

Ambient Temperature: 22.5°C, Liquid Temperature: 22.3°C

Communication System: LTE2500-FDD7 53204.9 MHz Duty Cycle: 1:1

Probe: EX3DV4 – SN3846 ConvF(6.72,7.04,7.50)

Area Scan (71x121x1): Interpolated grid: dx=1.200 mm, dy=1.200 mm

Maximum value of SAR (interpolated) = 0.166 W/kg

Zoom Scan (7x7x7)/Cube 0: Measurement grid: dx=5mm, dy=5mm, dz=5mm

Reference Value = 1.862 V/m; Power Drift = -0.21 dB

Peak SAR (extrapolated) = 0.308 W/kg

SAR(1 g) = 0.16 W/kg; SAR(10 g) = 0.084 W/kg

Maximum value of SAR (measured) = 0.176 W/kg

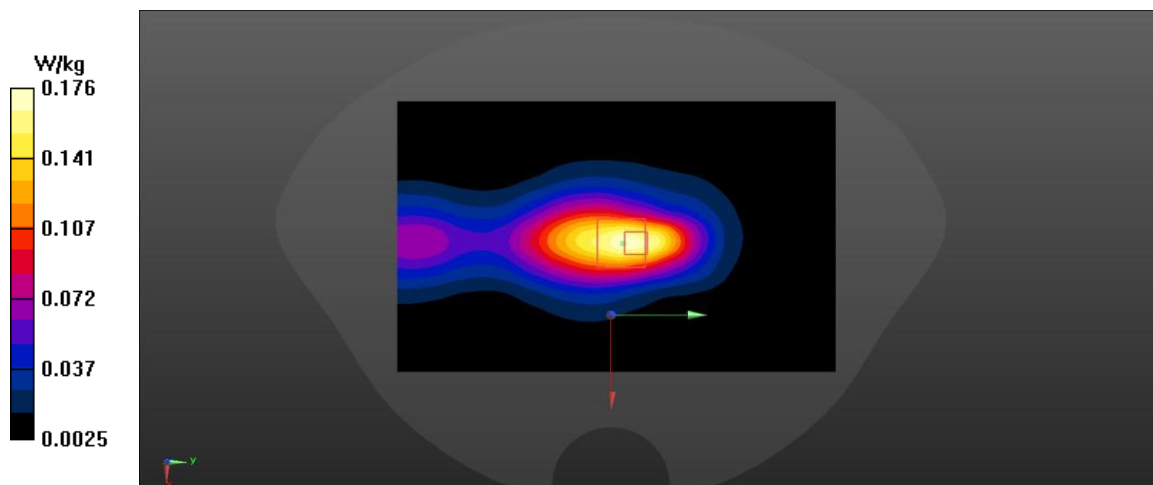

Fig A.44

n41(PC2) ANT1_CH528000 Rear 15mm

Date: 1/18/2024

Electronics: DAE4 Sn1601

Medium: head 2600 MHz

Medium parameters used: $f = 2640$; $\sigma = 1.46$ mho/m; $\epsilon_r = 39.6$; $\rho = 1000$ kg/m³

Ambient Temperature: 22.5°C, Liquid Temperature: 22.3°C

Communication System: LTE2500-FDD7 53225 MHz Duty Cycle: 1:1

Probe: EX3DV4 – SN3846 ConvF(6.72,7.04,7.50)

Area Scan (71x121x1): Interpolated grid: dx=1.200 mm, dy=1.200 mm

Maximum value of SAR (interpolated) = 0.231 W/kg

Zoom Scan (7x7x7)/Cube 0: Measurement grid: dx=5mm, dy=5mm, dz=5mm

Reference Value = 3.689 V/m; Power Drift = -0.1 dB

Peak SAR (extrapolated) = 0.39 W/kg

SAR(1 g) = 0.214 W/kg; SAR(10 g) = 0.118 W/kg

Maximum value of SAR (measured) = 0.235 W/kg

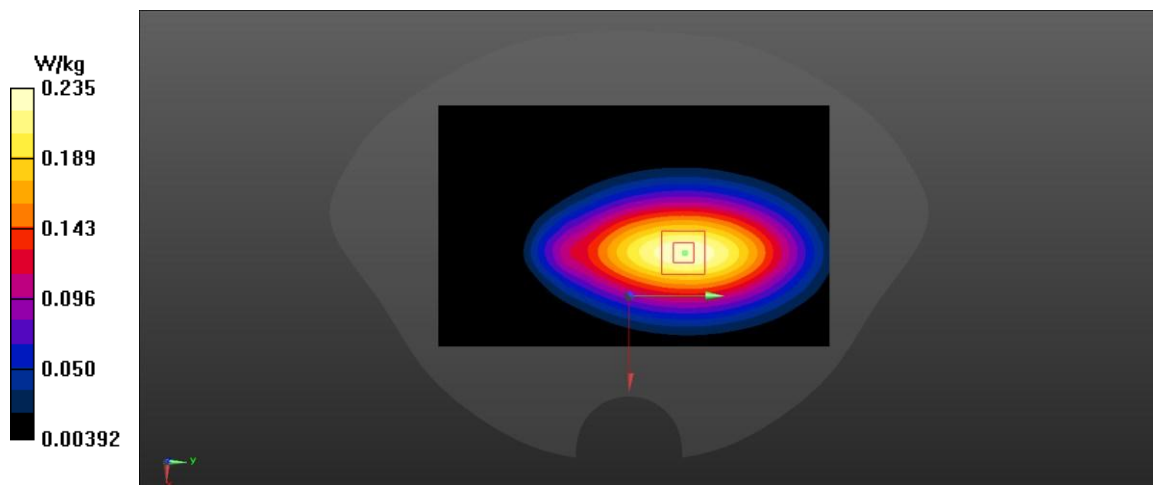

Fig A.45

n41(PC2) ANT4_CH537000 Right Cheek

Date: 1/18/2024

Electronics: DAE4 Sn1601

Medium: head 2600 MHz

Medium parameters used: $f = 2685$; $\sigma = 1.929$ mho/m; $\epsilon_r = 38.761$; $\rho = 1000$ kg/m³

Ambient Temperature: 22.5°C, Liquid Temperature: 22.3°C

Communication System: LTE2500-FDD7 54125 MHz Duty Cycle: 1:1

Probe: EX3DV4 – SN3846 ConvF(6.72,7.04,7.50)

Area Scan (71x121x1): Interpolated grid: dx=1.200 mm, dy=1.200 mm

Maximum value of SAR (interpolated) = 1.46 W/kg

Zoom Scan (7x7x7)/Cube 0: Measurement grid: dx=5mm, dy=5mm, dz=5mm

Reference Value = 6.297 V/m; Power Drift = 0.01 dB

Peak SAR (extrapolated) = 1.71 W/kg

SAR(1 g) = 0.826 W/kg; SAR(10 g) = 0.39 W/kg

Maximum value of SAR (measured) = 0.906 W/kg

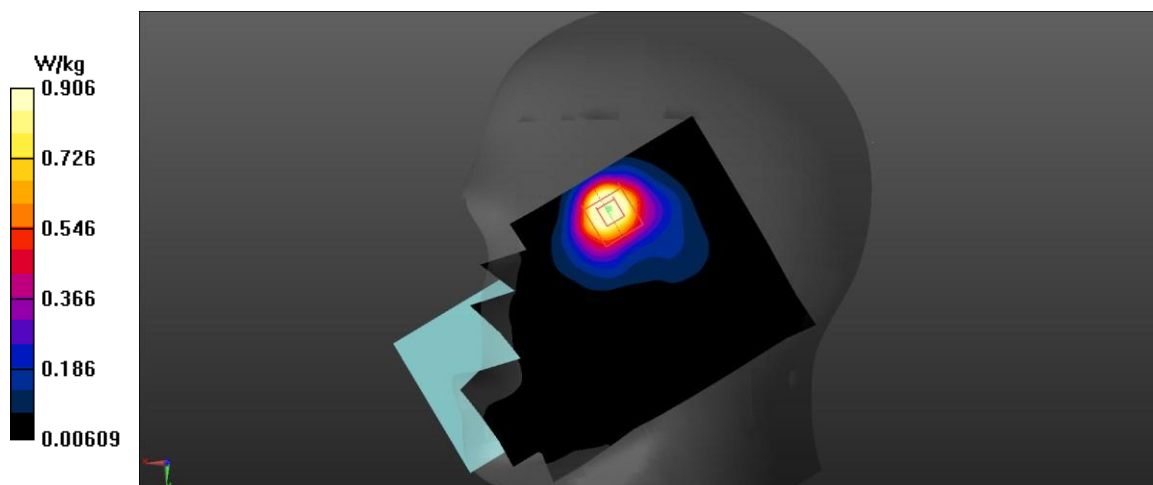

Fig A.46

n41(PC2) ANT4_CH518598 Left Edge 10mm

Date: 1/18/2024

Electronics: DAE4 Sn1601

Medium: head 2600 MHz

Medium parameters used: $f = 2592.99$; $\sigma = 1.968$ mho/m; $\epsilon_r = 38.712$; $\rho = 1000$ kg/m³

Ambient Temperature: 22.5°C, Liquid Temperature: 22.3°C

Communication System: LTE2500-FDD7 52284.8 MHz Duty Cycle: 1:1

Probe: EX3DV4 – SN3846 ConvF(6.72,7.04,7.50)

Area Scan (71x121x1): Interpolated grid: dx=1.200 mm, dy=1.200 mm

Maximum value of SAR (interpolated) = 0.68 W/kg

Zoom Scan (7x7x7)/Cube 0: Measurement grid: dx=5mm, dy=5mm, dz=5mm

Reference Value = 11.76 V/m; Power Drift = 0.01 dB

Peak SAR (extrapolated) = 1.12 W/kg

SAR(1 g) = 0.587 W/kg; SAR(10 g) = 0.361 W/kg

Maximum value of SAR (measured) = 0.650 W/kg

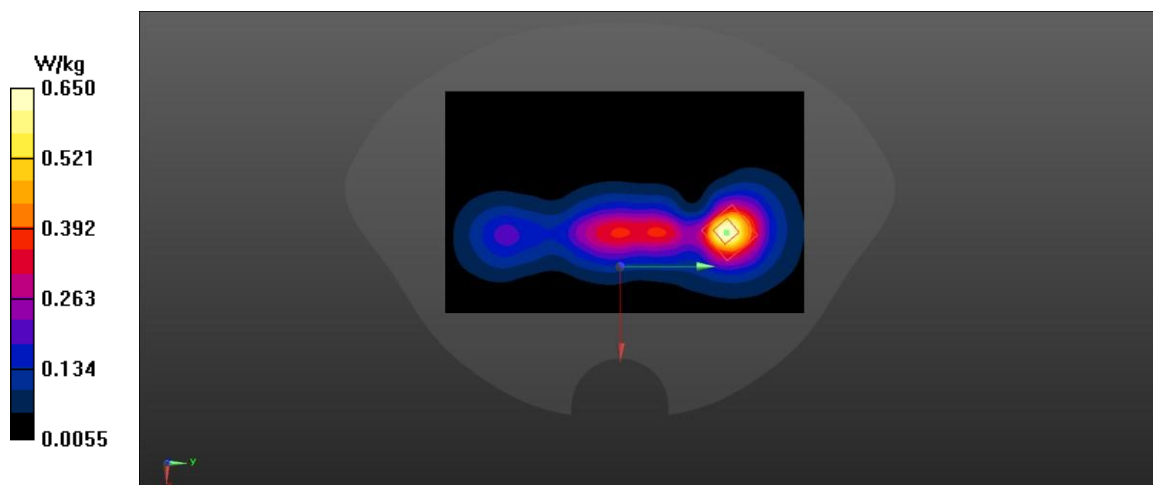

Fig A.47

n41(PC2) ANT4_CH537000 Rear 15mm

Date: 1/18/2024

Electronics: DAE4 Sn1601

Medium: head 2600 MHz

Medium parameters used: $f = 2685$; $\sigma = 1.46$ mho/m; $\epsilon_r = 39.6$; $\rho = 1000$ kg/m³

Ambient Temperature: 22.5°C, Liquid Temperature: 22.3°C

Communication System: LTE2500-FDD7 54125 MHz Duty Cycle: 1:1

Probe: EX3DV4 – SN3846 ConvF(6.72,7.04,7.50)

Area Scan (71x121x1): Interpolated grid: dx=1.200 mm, dy=1.200 mm

Maximum value of SAR (interpolated) = 0.404 W/kg

Zoom Scan (7x7x7)/Cube 0: Measurement grid: dx=5mm, dy=5mm, dz=5mm

Reference Value = 5.656 V/m; Power Drift = 0.26 dB

Peak SAR (extrapolated) = 0.661 W/kg

SAR(1 g) = 0.381 W/kg; SAR(10 g) = 0.209 W/kg

Maximum value of SAR (measured) = 0.394 W/kg

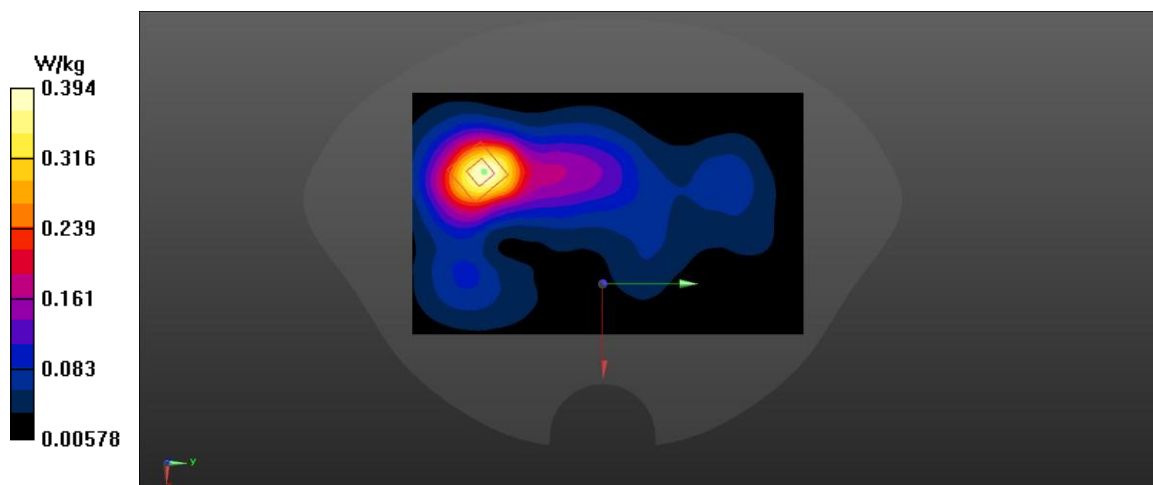

Fig A.48

n66 ANT2_CH346000 Left Cheek

Date: 1/16/2024

Electronics: DAE4 Sn1601

Medium: head 1750 MHz

Medium parameters used: $f = 1730$; $\sigma = 1.36$ mho/m; $\epsilon_r = 40.152$; $\rho = 1000$ kg/m³

Ambient Temperature: 22.5°C, Liquid Temperature: 22.3°C

Communication System: LTE1700-FDD66 54125 MHz Duty Cycle: 1:1

Probe: EX3DV4 – SN3846 ConvF(7.47,7.79,8.45)

Area Scan (71x121x1): Interpolated grid: dx=1.500 mm, dy=1.500 mm

Maximum value of SAR (interpolated) = 1.18 W/kg

Zoom Scan (7x7x7)/Cube 0: Measurement grid: dx=8mm, dy=8mm, dz=5mm

Reference Value = 11.93 V/m; Power Drift = 0.16 dB

Peak SAR (extrapolated) = 1.32 W/kg

SAR(1 g) = 0.761 W/kg; SAR(10 g) = 0.434 W/kg

Maximum value of SAR (measured) = 1.110 W/kg

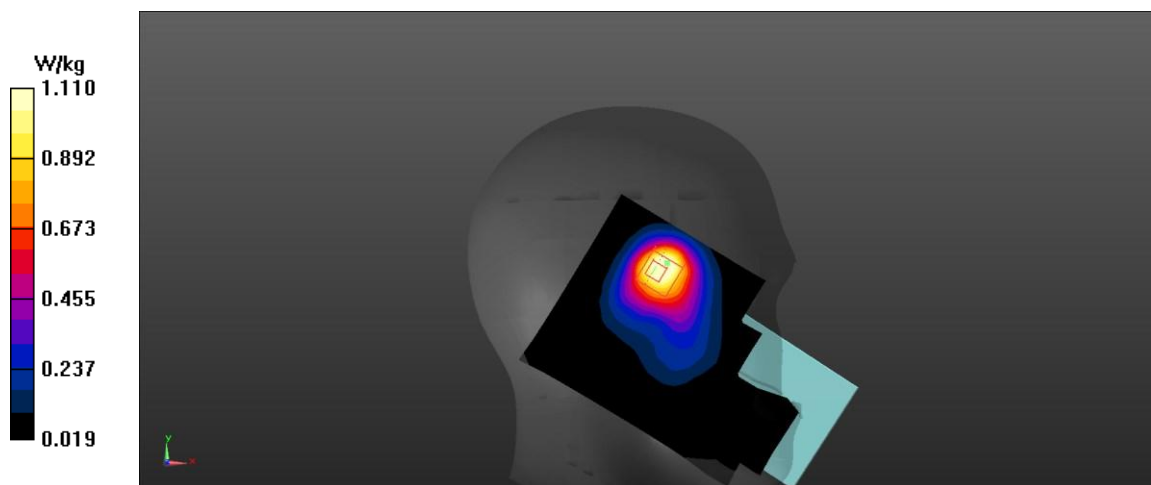

Fig A.49

n66 ANT2_CH346000 Right Edge 10mm

Date: 1/16/2024

Electronics: DAE4 Sn1601

Medium: head 1750 MHz

Medium parameters used: $f = 1730$; $\sigma = 1.336$ mho/m; $\epsilon_r = 39.899$; $\rho = 1000$ kg/m³

Ambient Temperature: 22.5°C, Liquid Temperature: 22.3°C

Communication System: LTE1700-FDD66 54125 MHz Duty Cycle: 1:1

Probe: EX3DV4 – SN3846 ConvF(7.47,7.79,8.45)

Area Scan (71x121x1): Interpolated grid: dx=1.500 mm, dy=1.500 mm

Maximum value of SAR (interpolated) = 0.3 W/kg

Zoom Scan (7x7x7)/Cube 0: Measurement grid: dx=8mm, dy=8mm, dz=5mm

Reference Value = 13.74 V/m; Power Drift = 0.21 dB

Peak SAR (extrapolated) = 0.416 W/kg

SAR(1 g) = 0.247 W/kg; SAR(10 g) = 0.148 W/kg

Maximum value of SAR (measured) = 0.267 W/kg

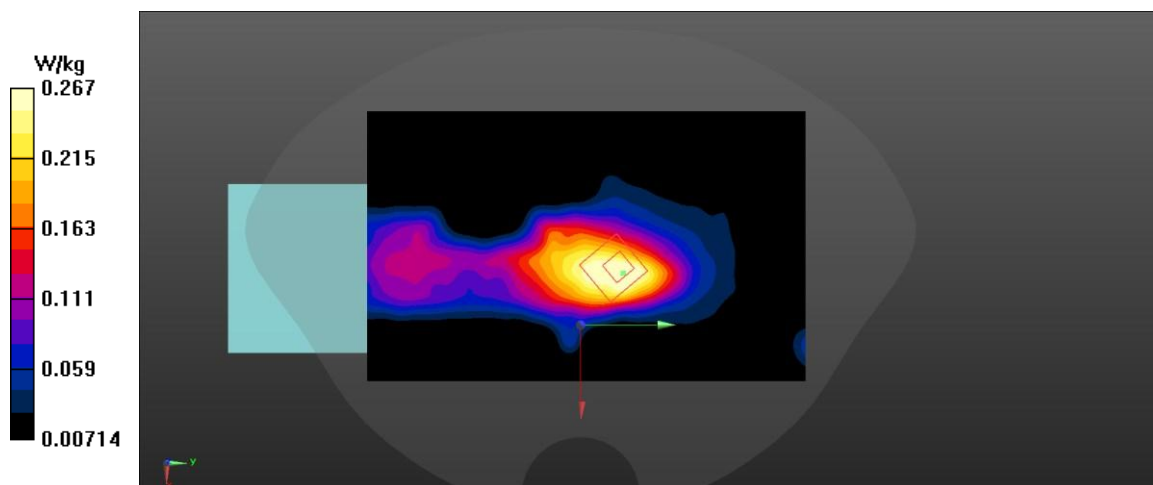

Fig A.50

n66 ANT2_CH342500 Front 15mm

Date: 1/16/2024

Electronics: DAE4 Sn1601

Medium: head 1750 MHz

Medium parameters used: $f = 1712.5$; $\sigma = 1.328$ mho/m; $\epsilon_r = 39.949$; $\rho = 1000$ kg/m³

Ambient Temperature: 22.5°C, Liquid Temperature: 22.3°C

Communication System: LTE1700-FDD66 54125 MHz Duty Cycle: 1:1

Probe: EX3DV4 – SN3846 ConvF(7.47,7.79,8.45)

Area Scan (71x121x1): Interpolated grid: dx=1.500 mm, dy=1.500 mm

Maximum value of SAR (interpolated) = 0.236 W/kg

Zoom Scan (7x7x7)/Cube 0: Measurement grid: dx=8mm, dy=8mm, dz=5mm

Reference Value = 8.832 V/m; Power Drift = 0.3 dB

Peak SAR (extrapolated) = 0.355 W/kg

SAR(1 g) = 0.219 W/kg; SAR(10 g) = 0.14 W/kg

Maximum value of SAR (measured) = 0.231 W/kg

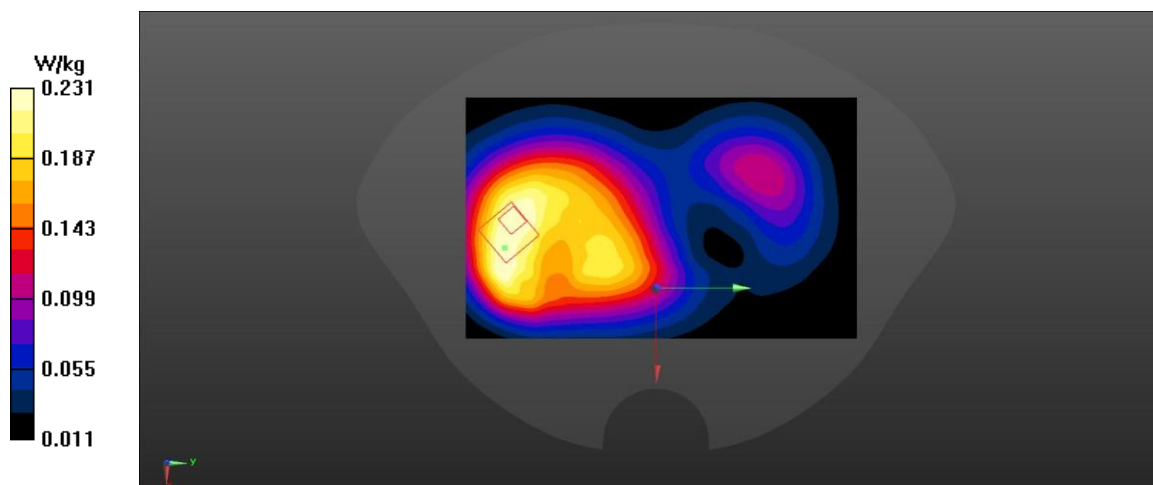

Fig A.51

n71 ANT0_CH137600 Right Tilt

Date: 1/15/2024

Electronics: DAE4 Sn1601

Medium: head 750 MHz

Medium parameters used: $f = 688$; $\sigma = 0.857$ mho/m; $\epsilon_r = 42.156$; $\rho = 1000$ kg/m³

Ambient Temperature: 22.5°C, Liquid Temperature: 22.3°C

Communication System: LTE700-FDD71 54125 MHz Duty Cycle: 1:1

Probe: EX3DV4 – SN3846 ConvF(8.98,8.99,10.08)

Area Scan (71x121x1): Interpolated grid: $dx=1.500$ mm, $dy=1.500$ mm

Maximum value of SAR (interpolated) = 0.546 W/kg

Zoom Scan (7x7x7)/Cube 0: Measurement grid: $dx=8$ mm, $dy=8$ mm, $dz=5$ mm

Reference Value = 16.84 V/m; Power Drift = 0.26 dB

Peak SAR (extrapolated) = 0.973 W/kg

SAR(1 g) = 0.415 W/kg; SAR(10 g) = 0.219 W/kg

Maximum value of SAR (measured) = 0.467 W/kg

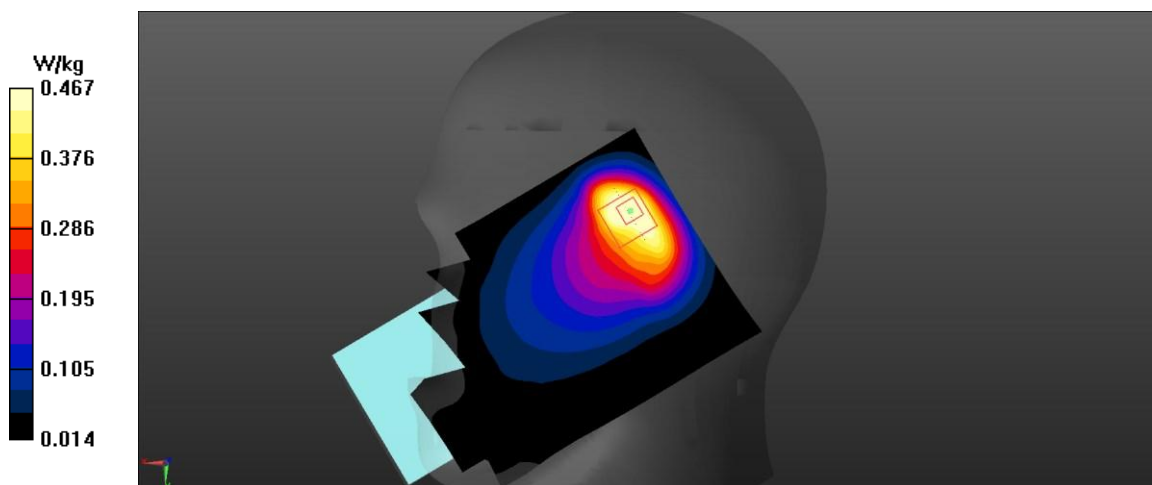

Fig A.52

n71 ANT0_CH134600 Left Edge 10mm

Date: 1/15/2024

Electronics: DAE4 Sn1601

Medium: head 750 MHz

Medium parameters used: $f = 673$; $\sigma = 0.862$ mho/m; $\epsilon_r = 42.121$; $\rho = 1000$ kg/m³

Ambient Temperature: 22.5°C, Liquid Temperature: 22.3°C

Communication System: LTE700-FDD71 54125 MHz Duty Cycle: 1:1

Probe: EX3DV4 – SN3846 ConvF(8.98,8.99,10.08)

Area Scan (71x121x1): Interpolated grid: dx=1.500 mm, dy=1.500 mm

Maximum value of SAR (interpolated) = 0.353 W/kg

Zoom Scan (7x7x7)/Cube 0: Measurement grid: dx=8mm, dy=8mm, dz=5mm

Reference Value = 24.23 V/m; Power Drift = 0.2 dB

Peak SAR (extrapolated) = 0.45 W/kg

SAR(1 g) = 0.326 W/kg; SAR(10 g) = 0.233 W/kg

Maximum value of SAR (measured) = 0.342 W/kg

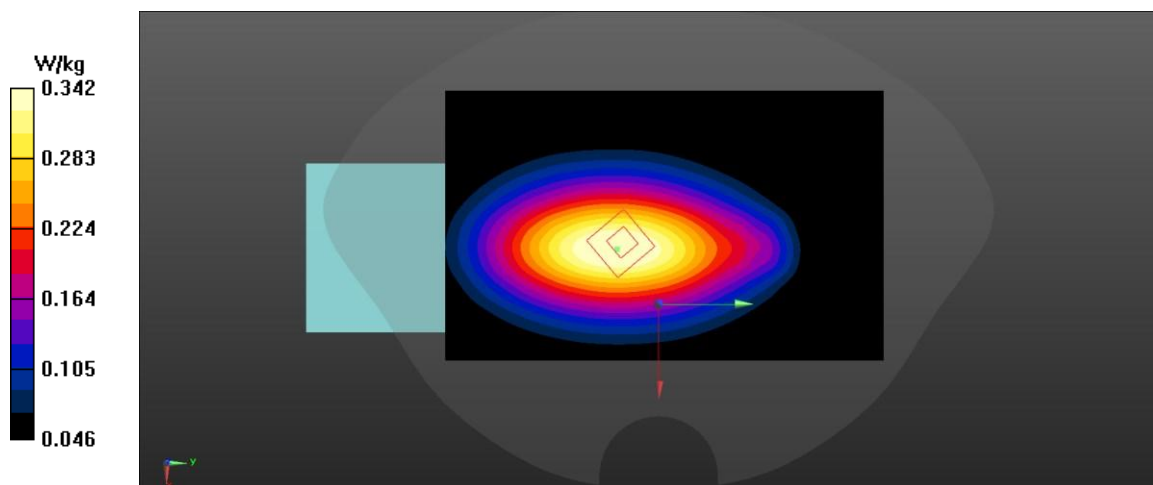

Fig A.53

n77 L ANT2_CH633334 Left Cheek

Date: 1/19/2024

Electronics: DAE4 Sn1601

Medium: head 3500 MHz

Medium parameters used: $f = 3500.01$; $\sigma = 2.653$ mho/m; $\epsilon_r = 37.179$; $\rho = 1000$ kg/m³

Ambient Temperature: 22.5°C, Liquid Temperature: 22.3°C

Communication System: LTE3500-TDD42 62574.4 MHz Duty Cycle: 1:1

Probe: EX3DV4 – SN3846 ConvF(6.50,6.78,7.20)

Area Scan (71x121x1): Interpolated grid: dx=1.000 mm, dy=1.000 mm

Maximum value of SAR (interpolated) = 0.749 W/kg

Zoom Scan (7x7x7)/Cube 0: Measurement grid: dx=4mm, dy=4mm, dz=1.4mm

Reference Value = 3.642 V/m; Power Drift = -0.3 dB

Peak SAR (extrapolated) = 1.05 W/kg

SAR(1 g) = 0.384 W/kg; SAR(10 g) = 0.141 W/kg

Maximum value of SAR (measured) = 0.785 W/kg

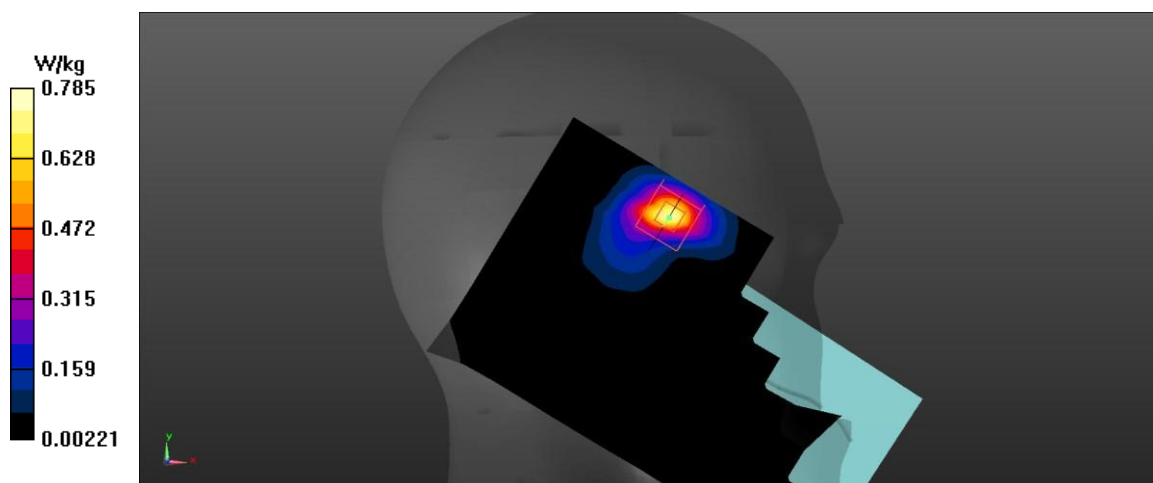

Fig A.54

n77 L ANT2_CH636000 Right Edge 10mm

Date: 1/19/2024

Electronics: DAE4 Sn1601

Medium: head 3500 MHz

Medium parameters used: $f = 3540$; $\sigma = 1.968$ mho/m; $\epsilon_r = 38.712$; $\rho = 1000$ kg/m³

Ambient Temperature: 22.5°C, Liquid Temperature: 22.3°C

Communication System: LTE3500-TDD42 62841 MHz Duty Cycle: 1:1

Probe: EX3DV4 – SN3846 ConvF(6.50,6.78,7.20)

Area Scan (71x121x1): Interpolated grid: dx=1.000 mm, dy=1.000 mm

Maximum value of SAR (interpolated) = 0.53 W/kg

Zoom Scan (7x7x7)/Cube 0: Measurement grid: dx=4mm, dy=4mm, dz=1.4mm

Reference Value = 5.78 V/m; Power Drift = 0.19 dB

Peak SAR (extrapolated) = 1.26 W/kg

SAR(1 g) = 0.516 W/kg; SAR(10 g) = 0.209 W/kg

Maximum value of SAR (measured) = 0.547 W/kg

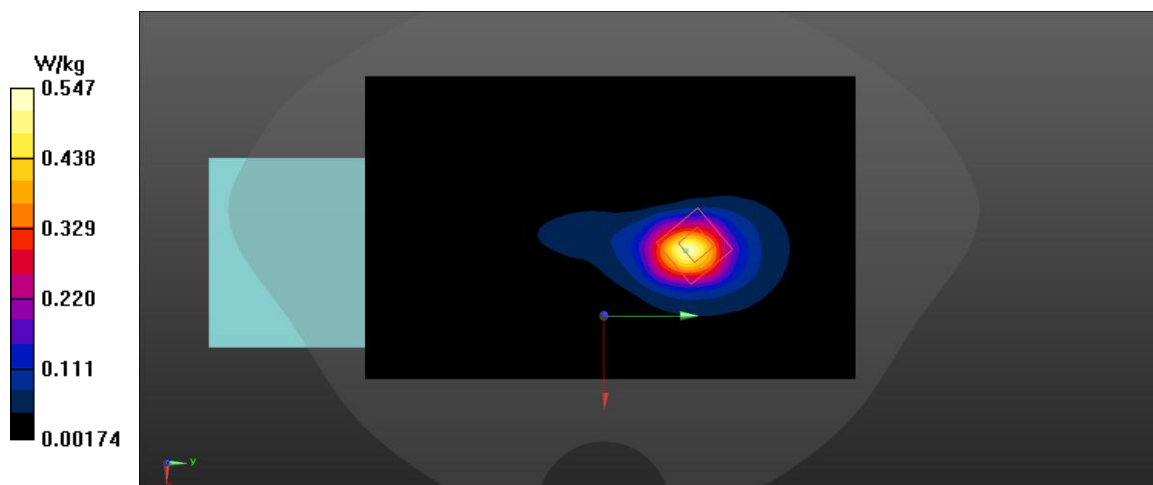

Fig A.55

n77 L ANT2_CH636000 Rear 15mm

Date: 1/19/2024

Electronics: DAE4 Sn1601

Medium: head 3500 MHz

Medium parameters used: $f = 3540$; $\sigma = 1.38$ mho/m; $\epsilon_r = 39.752$; $\rho = 1000$ kg/m³

Ambient Temperature: 22.5°C, Liquid Temperature: 22.3°C

Communication System: LTE3500-TDD42 62841 MHz Duty Cycle: 1:1

Probe: EX3DV4 – SN3846 ConvF(6.50,6.78,7.20)

Area Scan (71x121x1): Interpolated grid: dx=1.000 mm, dy=1.000 mm

Maximum value of SAR (interpolated) = 0.269 W/kg

Zoom Scan (7x7x7)/Cube 0: Measurement grid: dx=4mm, dy=4mm, dz=1.4mm

Reference Value = 3.526 V/m; Power Drift = 0.28 dB

Peak SAR (extrapolated) = 0.538 W/kg

SAR(1 g) = 0.242 W/kg; SAR(10 g) = 0.112 W/kg

Maximum value of SAR (measured) = 0.267 W/kg

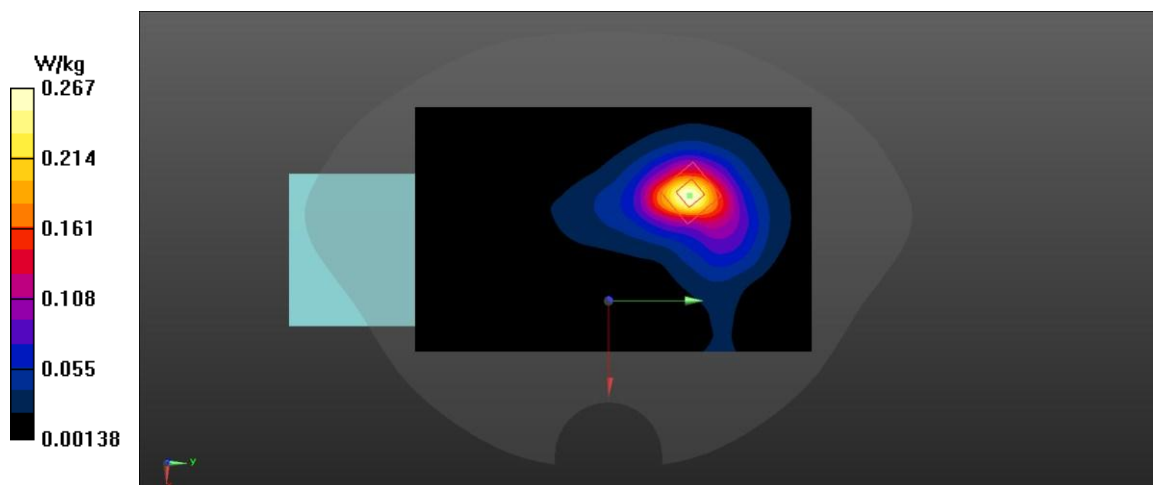

Fig A.56

n77 L ANT2_CH647334 Left Cheek

Date: 1/19/2024

Electronics: DAE4 Sn1601

Medium: head 3500 MHz

Medium parameters used: $f = 3710.01$; $\sigma = 2.653$ mho/m; $\epsilon_r = 37.179$; $\rho = 1000$ kg/m³

Ambient Temperature: 22.5°C, Liquid Temperature: 22.3°C

Communication System: LTE3500-TDD42 63974.4 MHz Duty Cycle: 1:1

Probe: EX3DV4 – SN3846 ConvF(6.50,6.78,7.20)

Area Scan (71x121x1): Interpolated grid: dx=1.000 mm, dy=1.000 mm

Maximum value of SAR (interpolated) = 0.94 W/kg

Zoom Scan (7x7x7)/Cube 0: Measurement grid: dx=4mm, dy=4mm, dz=1.4mm

Reference Value = 5.672 V/m; Power Drift = -0.23 dB

Peak SAR (extrapolated) = 1.38 W/kg

SAR(1 g) = 0.524 W/kg; SAR(10 g) = 0.207 W/kg

Maximum value of SAR (measured) = 0.980 W/kg

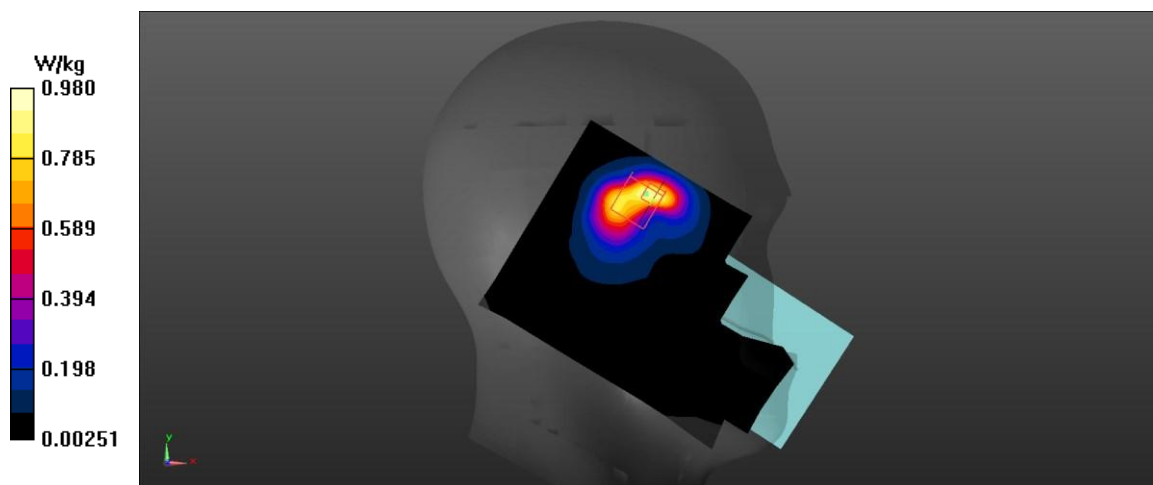

Fig A.57

n77 L ANT2_CH664666 Right Edge 10mm

Date: 1/19/2024

Electronics: DAE4 Sn1601

Medium: head 3500 MHz

Medium parameters used: $f = 3969.99$; $\sigma = 1.968$ mho/m; $\epsilon_r = 38.712$; $\rho = 1000$ kg/m³

Ambient Temperature: 22.5°C, Liquid Temperature: 22.3°C

Communication System: LTE3500-TDD42 65707.6 MHz Duty Cycle: 1:1

Probe: EX3DV4 – SN3846 ConvF(6.50,6.78,7.20)

Area Scan (71x121x1): Interpolated grid: dx=1.000 mm, dy=1.000 mm

Maximum value of SAR (interpolated) = 0.286 W/kg

Zoom Scan (7x7x7)/Cube 0: Measurement grid: dx=4mm, dy=4mm, dz=1.4mm

Reference Value = 5.585 V/m; Power Drift = 0.02 dB

Peak SAR (extrapolated) = 0.584 W/kg

SAR(1 g) = 0.245 W/kg; SAR(10 g) = 0.104 W/kg

Maximum value of SAR (measured) = 0.273 W/kg

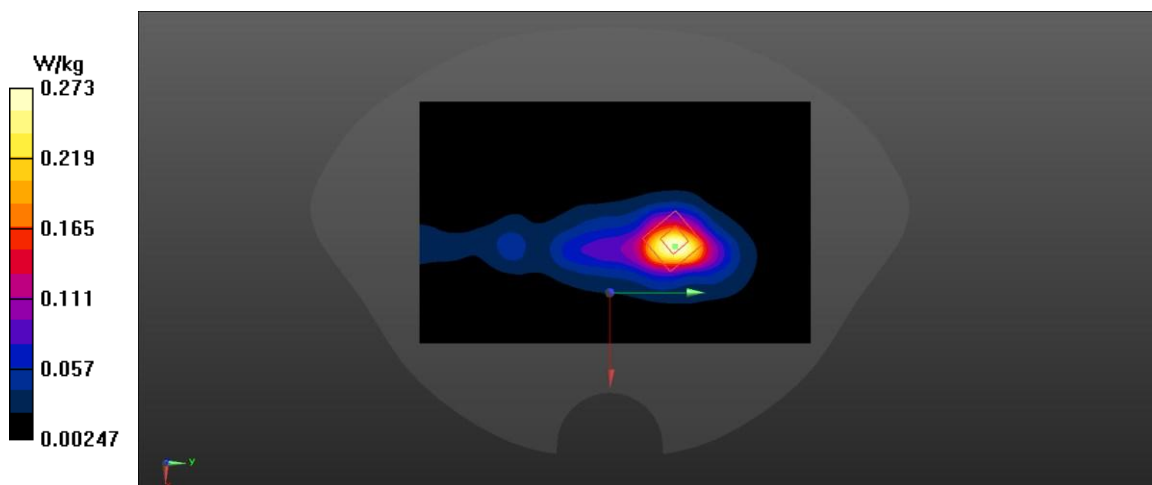

Fig A.58

n77 L ANT2_CH662000 Rear 15mm

Date: 1/19/2024

Electronics: DAE4 Sn1601

Medium: head 3500 MHz

Medium parameters used: $f = 3930$; $\sigma = 1.38$ mho/m; $\epsilon_r = 39.752$; $\rho = 1000$ kg/m³

Ambient Temperature: 22.5°C, Liquid Temperature: 22.3°C

Communication System: LTE3500-TDD42 65441 MHz Duty Cycle: 1:1

Probe: EX3DV4 – SN3846 ConvF(6.50,6.78,7.20)

Area Scan (71x121x1): Interpolated grid: dx=1.000 mm, dy=1.000 mm

Maximum value of SAR (interpolated) = 0.466 W/kg

Zoom Scan (7x7x7)/Cube 0: Measurement grid: dx=4mm, dy=4mm, dz=1.4mm

Reference Value = 4.755 V/m; Power Drift = 0.22 dB

Peak SAR (extrapolated) = 0.97 W/kg

SAR(1 g) = 0.422 W/kg; SAR(10 g) = 0.192 W/kg

Maximum value of SAR (measured) = 0.464 W/kg

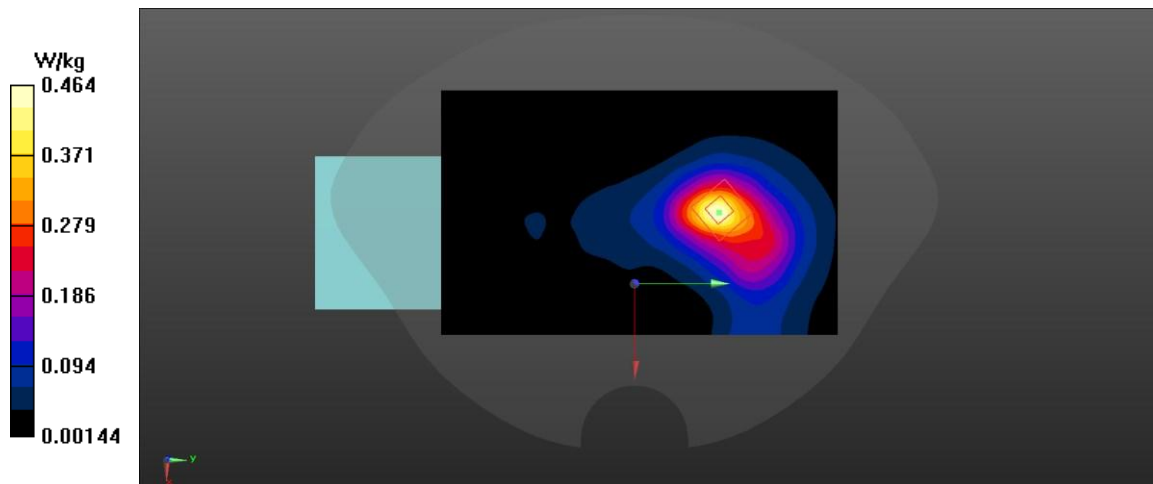

Fig A.59

n77 L(PC2) ANT6_CH636000 Right Cheek

Date: 1/19/2024

Electronics: DAE4 Sn1601

Medium: head 3500 MHz

Medium parameters used: $f = 3540$; $\sigma = 2.689$ mho/m; $\epsilon_r = 37.091$; $\rho = 1000$ kg/m³

Ambient Temperature: 22.5°C, Liquid Temperature: 22.3°C

Communication System: LTE3500-TDD42 62841 MHz Duty Cycle: 1:1

Probe: EX3DV4 – SN3846 ConvF(6.50,6.78,7.20)

Area Scan (71x121x1): Interpolated grid: dx=1.000 mm, dy=1.000 mm

Maximum value of SAR (interpolated) = 0.405 W/kg

Zoom Scan (7x7x7)/Cube 0: Measurement grid: dx=4mm, dy=4mm, dz=1.4mm

Reference Value = 3.504 V/m; Power Drift = -0.25 dB

Peak SAR (extrapolated) = 0.712 W/kg

SAR(1 g) = 0.279 W/kg; SAR(10 g) = 0.123 W/kg

Maximum value of SAR (measured) = 0.316 W/kg

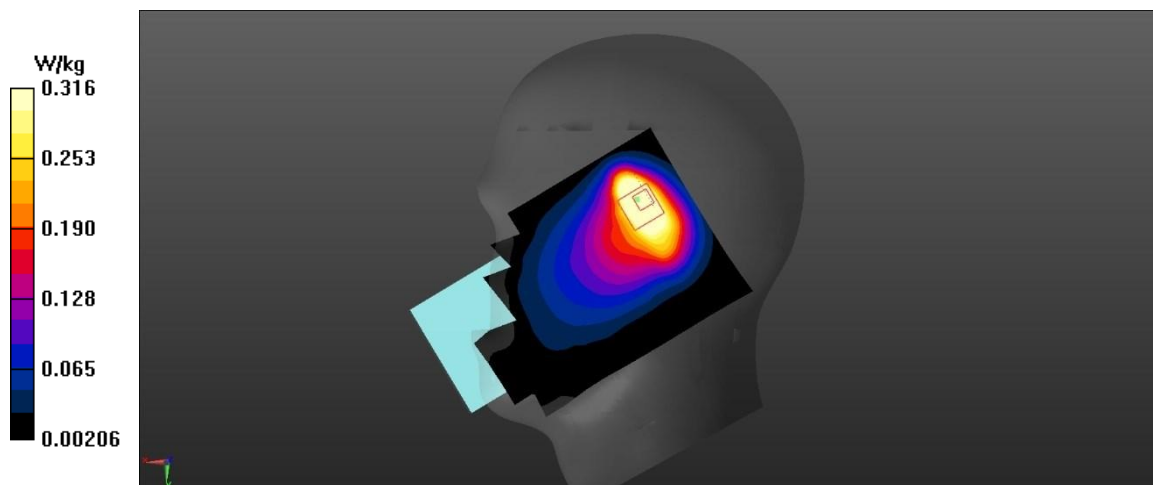

Fig A.60

n77 L(PC2) ANT6_CH633334 Left Edge 10mm

Date: 1/19/2024

Electronics: DAE4 Sn1601

Medium: head 3500 MHz

Medium parameters used: $f = 3500.01$; $\sigma = 2.653$ mho/m; $\epsilon_r = 37.179$; $\rho = 1000$ kg/m³

Ambient Temperature: 22.5°C, Liquid Temperature: 22.3°C

Communication System: LTE3500-TDD42 62574.4 MHz Duty Cycle: 1:1

Probe: EX3DV4 – SN3846 ConvF(6.50,6.78,7.20)

Area Scan (71x121x1): Interpolated grid: dx=1.000 mm, dy=1.000 mm

Maximum value of SAR (interpolated) = 0.286 W/kg

Zoom Scan (7x7x7)/Cube 0: Measurement grid: dx=4mm, dy=4mm, dz=1.4mm

Reference Value = 5.585 V/m; Power Drift = -0.11 dB

Peak SAR (extrapolated) = 0.584 W/kg

SAR(1 g) = 0.259 W/kg; SAR(10 g) = 0.115 W/kg

Maximum value of SAR (measured) = 0.273 W/kg

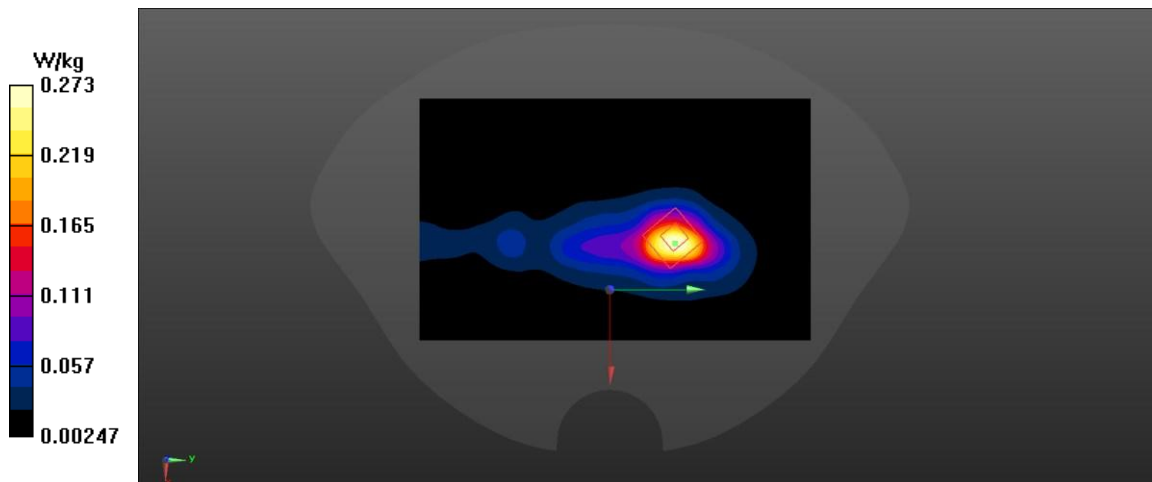

Fig A.61

n77 L(PC2) ANT6_CH630668 Rear 15mm

Date: 1/19/2024

Electronics: DAE4 Sn1601

Medium: head 3500 MHz

Medium parameters used: $f = 3460.02$; $\sigma = 1.38$ mho/m; $\epsilon_r = 39.752$; $\rho = 1000$ kg/m³

Ambient Temperature: 22.5°C, Liquid Temperature: 22.3°C

Communication System: LTE3500-TDD42 62307.8 MHz Duty Cycle: 1:1

Probe: EX3DV4 – SN3846 ConvF(6.50,6.78,7.20)

Area Scan (71x121x1): Interpolated grid: dx=1.000 mm, dy=1.000 mm

Maximum value of SAR (interpolated) = 0.0428 W/kg

Zoom Scan (7x7x7)/Cube 0: Measurement grid: dx=4mm, dy=4mm, dz=1.4mm

Reference Value = 2.349 V/m; Power Drift = 0.26 dB

Peak SAR (extrapolated) = 0.092 W/kg

SAR(1 g) = 0.042 W/kg; SAR(10 g) = 0.216 W/kg

Maximum value of SAR (measured) = 0.045 W/kg

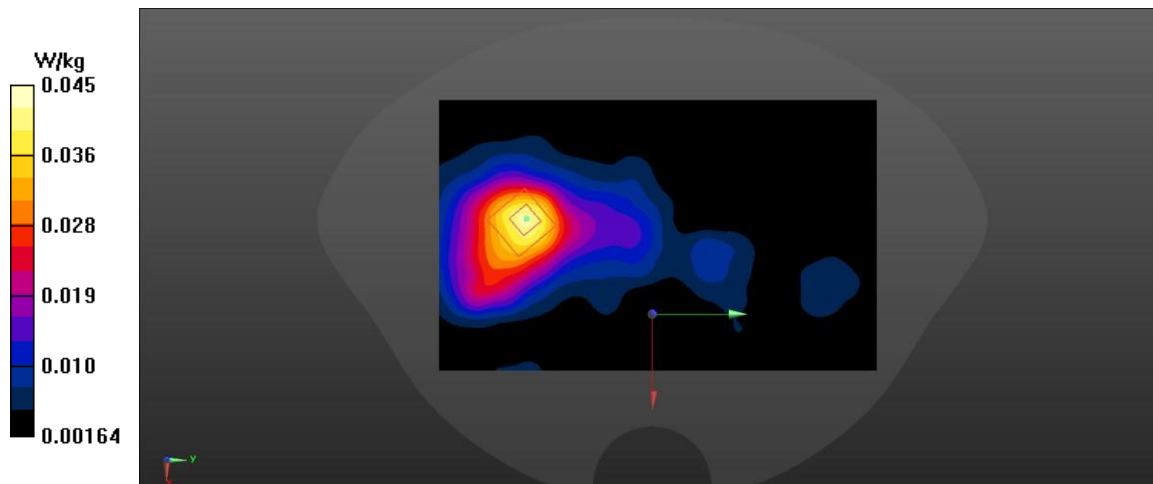

Fig A.62

n77(PC2) H ANT6_CH664666 Right Cheek

Date: 1/19/2024

Electronics: DAE4 Sn1601

Medium: head 3900 MHz

Medium parameters used: $f = 3969.99$; $\sigma = 2.689$ mho/m; $\epsilon_r = 37.091$; $\rho = 1000$ kg/m³

Ambient Temperature: 22.5°C, Liquid Temperature: 22.3°C

Communication System: LTE3500-TDD42 65707.6 MHz Duty Cycle: 1:1

Probe: EX3DV4 – SN3846 ConvF(6.36,6.63,7.02)

Area Scan (71x121x1): Interpolated grid: dx=1.000 mm, dy=1.000 mm

Maximum value of SAR (interpolated) = 0.542 W/kg

Zoom Scan (7x7x7)/Cube 0: Measurement grid: dx=4mm, dy=4mm, dz=1.4mm

Reference Value = 4.137 V/m; Power Drift = -0.29 dB

Peak SAR (extrapolated) = 0.818 W/kg

SAR(1 g) = 0.291 W/kg; SAR(10 g) = 0.122 W/kg

Maximum value of SAR (measured) = 0.321 W/kg

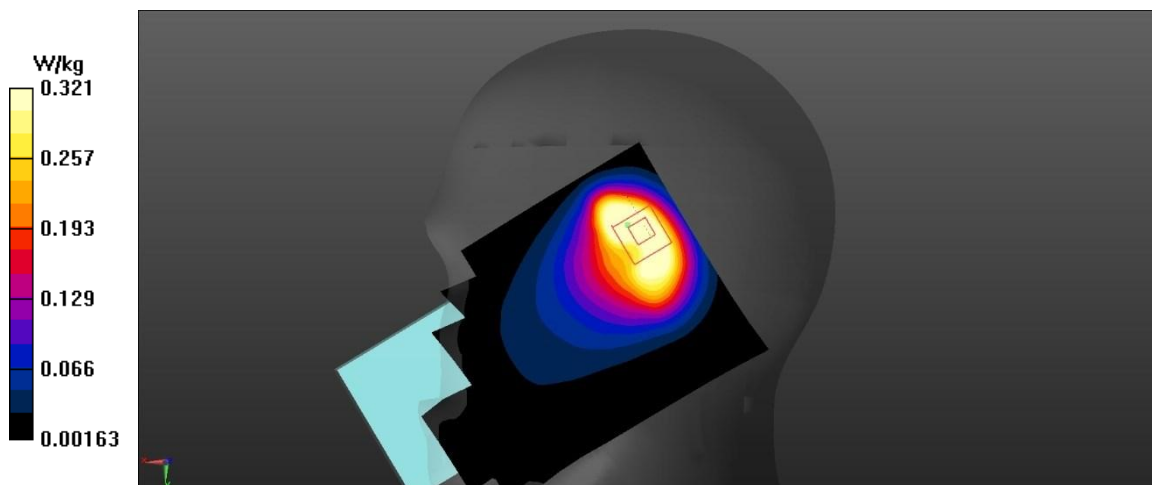

Fig A.63

n77(PC2) H ANT6_CH664666 Left Edge 10mm

Date: 1/19/2024

Electronics: DAE4 Sn1601

Medium: head 3900 MHz

Medium parameters used: $f = 3969.99$; $\sigma = 2.653$ mho/m; $\epsilon_r = 37.179$; $\rho = 1000$ kg/m³

Ambient Temperature: 22.5°C, Liquid Temperature: 22.3°C

Communication System: LTE3500-TDD42 65707.6 MHz Duty Cycle: 1:1

Probe: EX3DV4 – SN3846 ConvF(6.36,6.63,7.02)

Area Scan (71x121x1): Interpolated grid: dx=1.000 mm, dy=1.000 mm

Maximum value of SAR (interpolated) = 0.245 W/kg

Zoom Scan (7x7x7)/Cube 0: Measurement grid: dx=4mm, dy=4mm, dz=1.4mm

Reference Value = 4.991 V/m; Power Drift = 0.25 dB

Peak SAR (extrapolated) = 0.582 W/kg

SAR(1 g) = 0.22 W/kg; SAR(10 g) = 0.095 W/kg

Maximum value of SAR (measured) = 0.246 W/kg

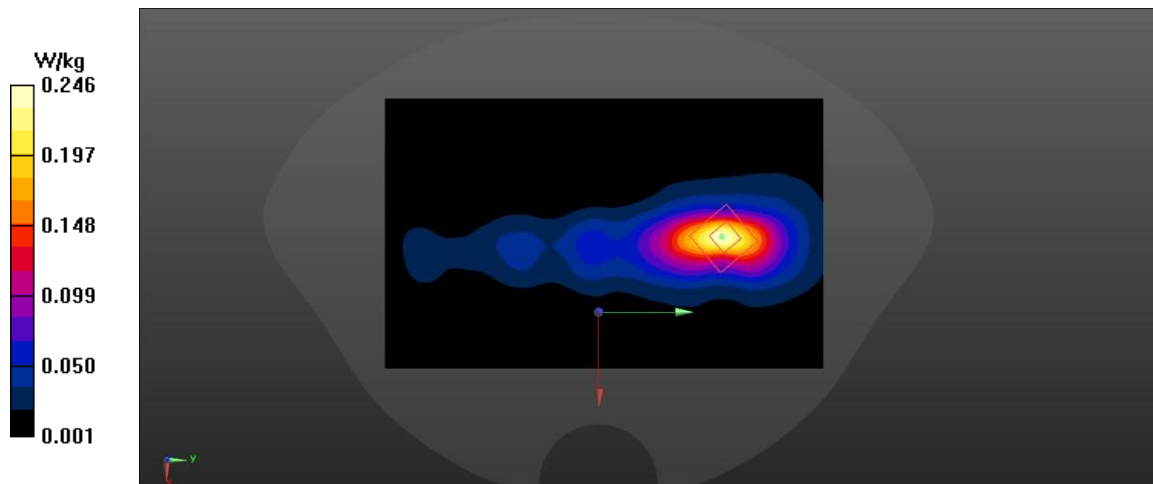

Fig A.64

n77(PC2) H ANT6_CH664666 Rear 15mm

Date: 1/19/2024

Electronics: DAE4 Sn1601

Medium: head 3900 MHz

Medium parameters used: $f = 3969.99$; $\sigma = 3.078$ mho/m; $\epsilon_r = 36.511$; $\rho = 1000$ kg/m³

Ambient Temperature: 22.5°C, Liquid Temperature: 22.3°C

Communication System: LTE3500-TDD42 65707.6 MHz Duty Cycle: 1:1

Probe: EX3DV4 – SN3846 ConvF(6.36,6.63,7.02)

Area Scan (71x121x1): Interpolated grid: dx=1.000 mm, dy=1.000 mm

Maximum value of SAR (interpolated) = 0.0787 W/kg

Zoom Scan (7x7x7)/Cube 0: Measurement grid: dx=4mm, dy=4mm, dz=1.4mm

Reference Value = 1.471 V/m; Power Drift = -0.23 dB

Peak SAR (extrapolated) = 0.523 W/kg

SAR(1 g) = 0.196 W/kg; SAR(10 g) = 0.077 W/kg

Maximum value of SAR (measured) = 0.219 W/kg

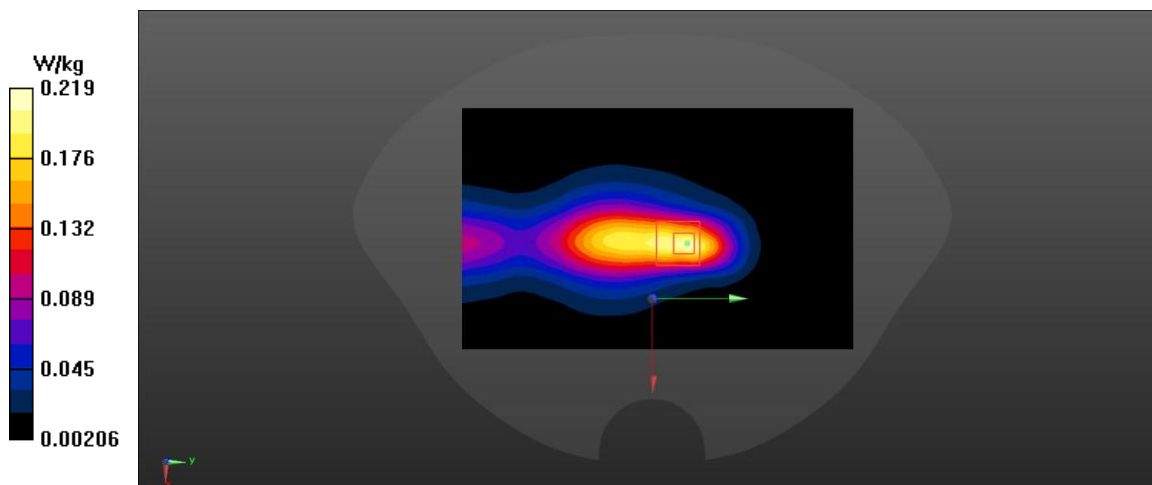

Fig A.65

WLAN2450_CH6 Left Cheek

Date: 1/23/2024

Electronics: DAE4 Sn1601

Medium: head 2450 MHz

Medium parameters used: $f = 2437$; $\sigma = 1.803$ mho/m; $\epsilon_r = 39.34$; $\rho = 1000$ kg/m³

Ambient Temperature: 22.5°C, Liquid Temperature: 22.3°C

Communication System: WLAN2450 2437 Duty Cycle: 1:1

Probe: EX3DV4 – SN3846 ConvF(6.80,7.06,7.55)

Area Scan (71x121x1): Interpolated grid: dx=1.200 mm, dy=1.200 mm

Maximum value of SAR (interpolated) = 1.18 W/kg

Zoom Scan (7x7x7)/Cube 0: Measurement grid: dx=5mm, dy=5mm, dz=5mm

Reference Value = 10.24 V/m; Power Drift = 0.16 dB

Peak SAR (extrapolated) = 1.26 W/kg

SAR(1 g) = 0.634 W/kg; SAR(10 g) = 0.322 W/kg

Maximum value of SAR (measured) = 0.693W/kg

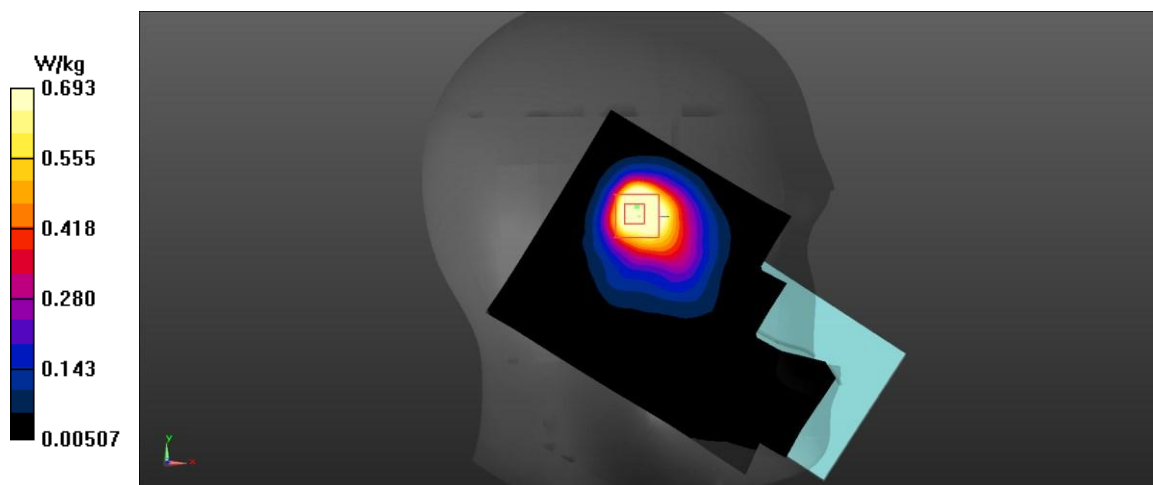

Fig A.66

WLAN2450_CH6 Right Edge 10mm

Date: 1/23/2024

Electronics: DAE4 Sn1601

Medium: head 2450 MHz

Medium parameters used: $f = 2437$; $\sigma = 1.941$ mho/m; $\epsilon_r = 52.28$; $\rho = 1000$ kg/m³

Ambient Temperature: 22.5°C, Liquid Temperature: 22.3°C

Communication System: WLAN2450 2437 Duty Cycle: 1:1

Probe: EX3DV4 – SN3846 ConvF(6.80,7.06,7.55)

Area Scan (71x121x1): Interpolated grid: dx=1.200 mm, dy=1.200 mm

Maximum value of SAR (interpolated) = 0.0842 W/kg

Zoom Scan (7x7x7)/Cube 0: Measurement grid: dx=5mm, dy=5mm, dz=5mm

Reference Value = 7.026 V/m; Power Drift = -0.16 dB

Peak SAR (extrapolated) = 0.131 W/kg

SAR(1 g) = 0.076 W/kg; SAR(10 g) = 0.043 W/kg

Maximum value of SAR (measured) = 0.081 W/kg

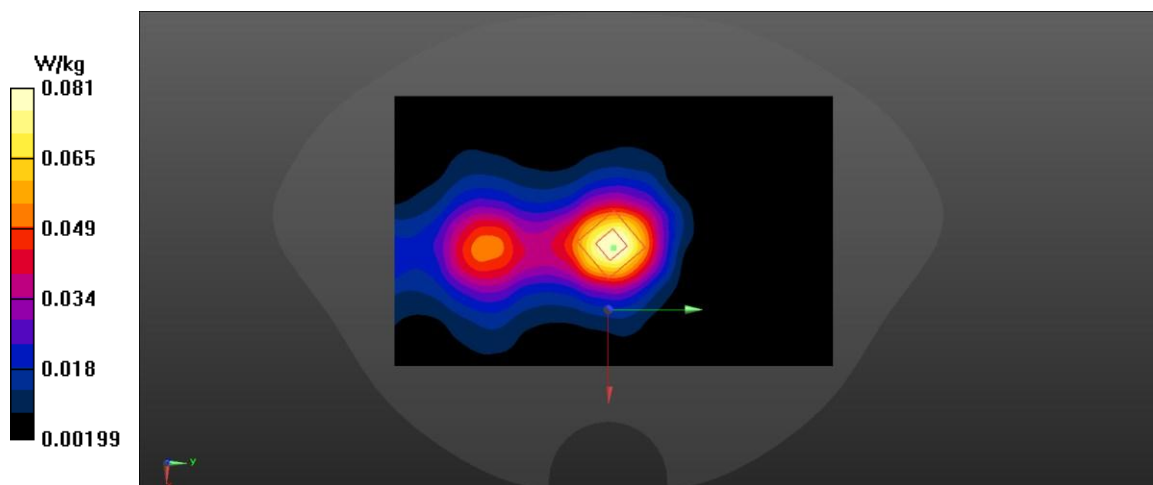

Fig A.67

WLAN2450_CH6 Right Edge

Date: 1/23/2024

Electronics: DAE4 Sn1601

Medium: head 2450 MHz

Medium parameters used: $f = 2437$; $\sigma = 1.941$ mho/m; $\epsilon_r = 52.28$; $\rho = 1000$ kg/m³

Ambient Temperature: 22.5°C, Liquid Temperature: 22.3°C

Communication System: WLAN2450 2437 Duty Cycle: 1:1

Probe: EX3DV4 – SN3846 ConvF(6.80,7.06,7.55)

Area Scan (71x121x1): Interpolated grid: dx=1.200 mm, dy=1.200 mm

Maximum value of SAR (interpolated) = 0.0842 W/kg

Zoom Scan (7x7x7)/Cube 0: Measurement grid: dx=5mm, dy=5mm, dz=5mm

Reference Value = 7.026 V/m; Power Drift = -0.13 dB

Peak SAR (extrapolated) = 0.131 W/kg

SAR(1 g) = 0.941 W/kg; SAR(10 g) = 0.402 W/kg

Maximum value of SAR (measured) = 0.081 W/kg

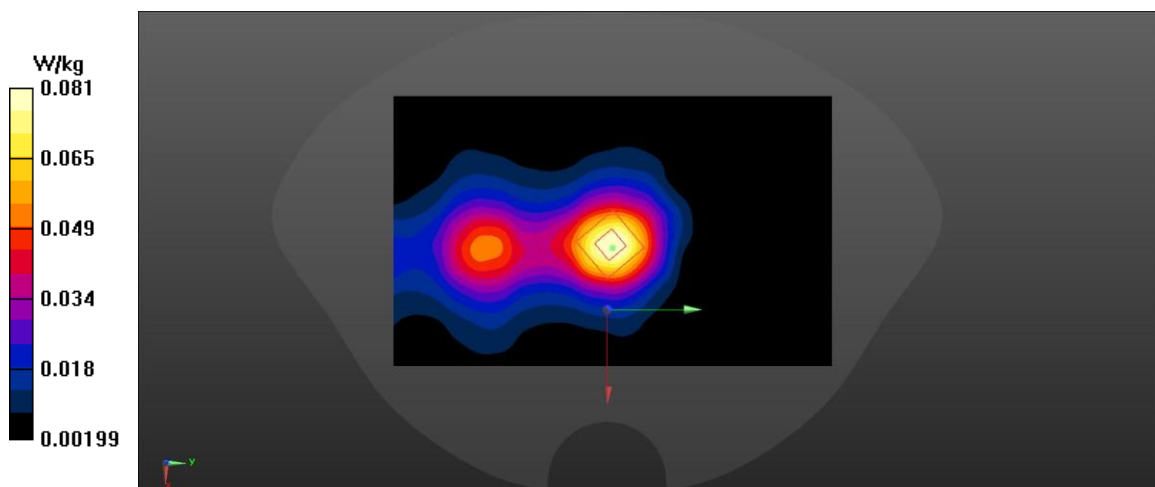

Fig A.68

WLAN2450_CH6 Front 15mm

Date: 1/23/2024

Electronics: DAE4 Sn1601

Medium: head 2450 MHz

Medium parameters used: $f = 2437$; $\sigma = 1.941$ mho/m; $\epsilon_r = 52.28$; $\rho = 1000$ kg/m³

Ambient Temperature: 22.5°C, Liquid Temperature: 22.3°C

Communication System: WLAN2450 2437 Duty Cycle: 1:1

Probe: EX3DV4 – SN3846 ConvF(6.80,7.06,7.55)

Area Scan (71x121x1): Interpolated grid: dx=1.200 mm, dy=1.200 mm

Maximum value of SAR (interpolated) = 0.222 W/kg

Zoom Scan (7x7x7)/Cube 0: Measurement grid: dx=5mm, dy=5mm, dz=5mm

Reference Value = 8.39 V/m; Power Drift = -0.04 dB

Peak SAR (extrapolated) = 0.353 W/kg

SAR(1 g) = 0.2 W/kg; SAR(10 g) = 0.114 W/kg

Maximum value of SAR (measured) = 0.215 W/kg

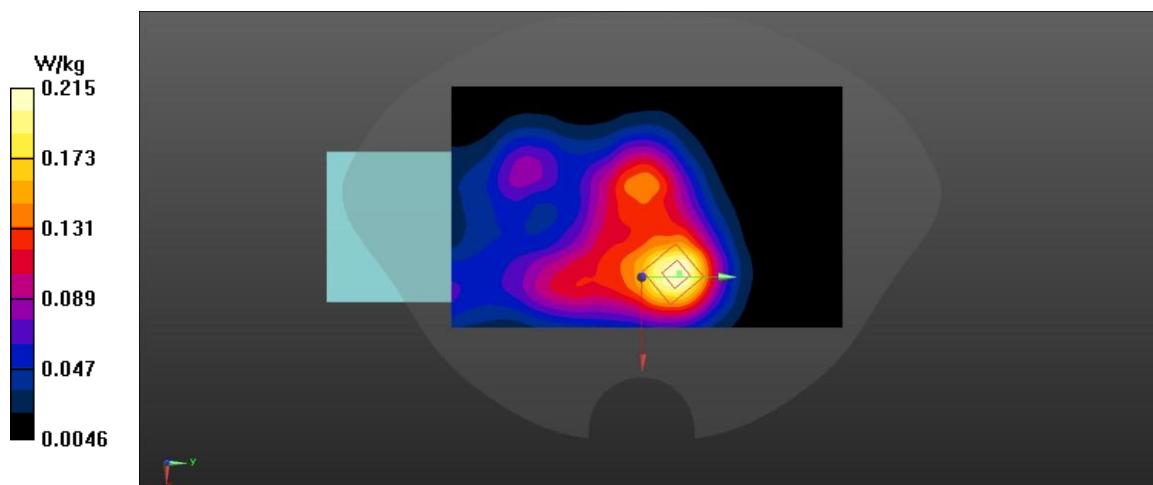

Fig A.69

WLAN2450_CH6 Left Cheek

Date: 1/23/2024

Electronics: DAE4 Sn1601

Medium: head 2450 MHz

Medium parameters used: $f = 2437$; $\sigma = 1.803$ mho/m; $\epsilon_r = 39.34$; $\rho = 1000$ kg/m³

Ambient Temperature: 22.5°C, Liquid Temperature: 22.3°C

Communication System: WLAN2450 2437 Duty Cycle: 1:1

Probe: EX3DV4 – SN3846 ConvF(6.80,7.06,7.55)

Area Scan (71x121x1): Interpolated grid: dx=1.200 mm, dy=1.200 mm

Maximum value of SAR (interpolated) = 0.293 W/kg

Zoom Scan (7x7x7)/Cube 0: Measurement grid: dx=5mm, dy=5mm, dz=5mm

Reference Value = 4.845 V/m; Power Drift = 0.28 dB

Peak SAR (extrapolated) = 0.304 W/kg

SAR(1 g) = 0.151 W/kg; SAR(10 g) = 0.076 W/kg

Maximum value of SAR (measured) = 0.166 W/kg

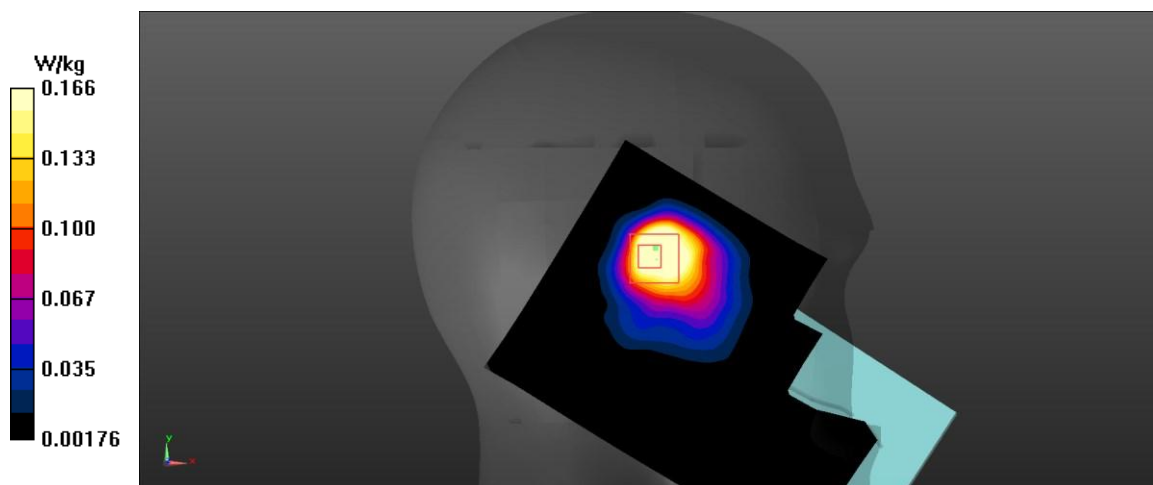

Fig A.70

WLAN2450_CH6 Front 15mm

Date: 1/23/2024

Electronics: DAE4 Sn1601

Medium: head 2450 MHz

Medium parameters used: $f = 2437$; $\sigma = 1.941$ mho/m; $\epsilon_r = 52.28$; $\rho = 1000$ kg/m³

Ambient Temperature: 22.5°C, Liquid Temperature: 22.3°C

Communication System: WLAN2450 2437 Duty Cycle: 1:1

Probe: EX3DV4 – SN3846 ConvF(6.80,7.06,7.55)

Area Scan (71x121x1): Interpolated grid: $dx=1.200$ mm, $dy=1.200$ mm

Maximum value of SAR (interpolated) = 0.0305 W/kg

Zoom Scan (7x7x7)/Cube 0: Measurement grid: $dx=5$ mm, $dy=5$ mm, $dz=5$ mm

Reference Value = 3.279 V/m; Power Drift = 0.3 dB

Peak SAR (extrapolated) = 0.055 W/kg

SAR(1 g) = 0.03 W/kg; SAR(10 g) = 0.017 W/kg

Maximum value of SAR (measured) = 0.031 W/kg

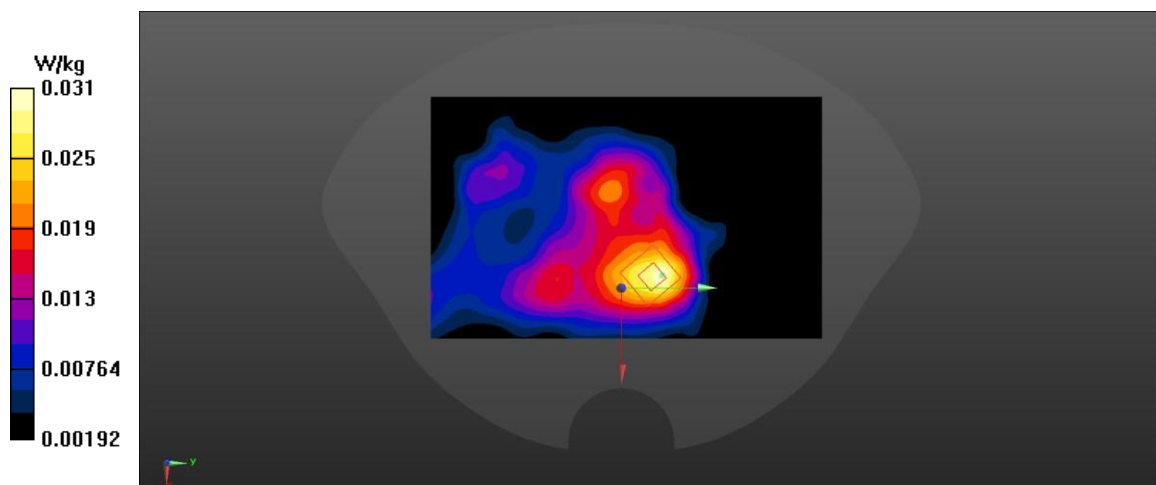

Fig A.71

WLAN5G_CH149 Left Cheek

Date: 1/26/2024

Electronics: DAE4 Sn1601

Medium: head 5750 MHz

Medium parameters used: $f = 5745$; $\sigma = 5.113$ mho/m; $\epsilon_r = 33.816$; $\rho = 1000$ kg/m³

Ambient Temperature: 22.5°C, Liquid Temperature: 22.3°C

Communication System: WLAN 5745 Duty Cycle: 1:1

Probe: EX3DV4 – SN3846 ConvF(4.54,4.76,4.98)

Area Scan (71x121x1): Interpolated grid: dx=1.000 mm, dy=1.000 mm

Maximum value of SAR (interpolated) = 1.05 W/kg

Zoom Scan (7x7x7)/Cube 0: Measurement grid: dx=4mm, dy=4mm, dz=1.4mm

Reference Value = 3.044 V/m; Power Drift = -0.04 dB

Peak SAR (extrapolated) = 2.31 W/kg

SAR(1 g) = 0.544 W/kg; SAR(10 g) = 0.175 W/kg

Maximum value of SAR (measured) = 0.548 W/kg

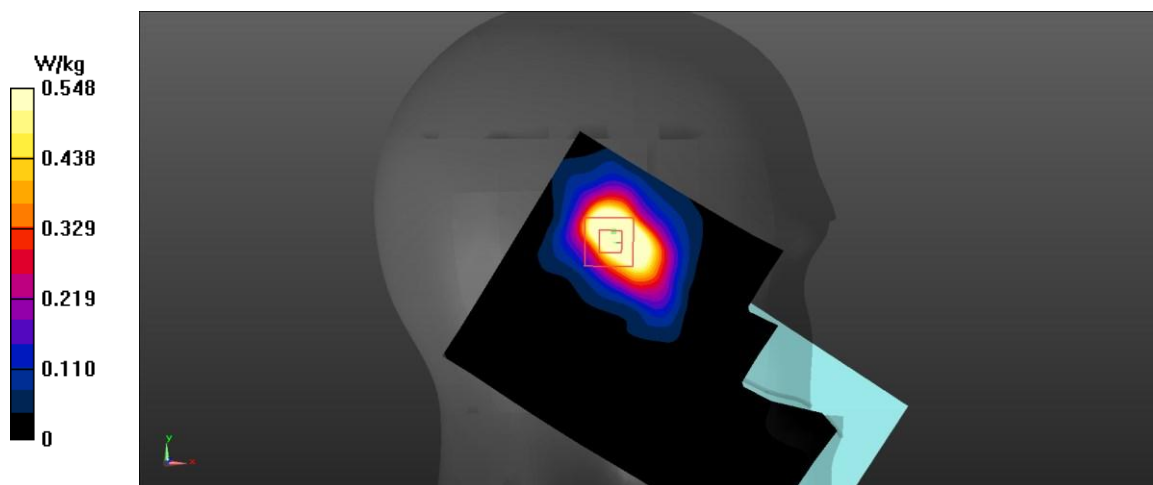

Fig A.72

WLAN5G_CH60 Rear 10mm

Date: 1/23/2024

Electronics: DAE4 Sn1601

Medium: head 5250 MHz

Medium parameters used: $f = 5300$; $\sigma = 4.45$ mho/m; $\epsilon_r = 34.378$; $\rho = 1000$ kg/m³

Ambient Temperature: 22.5°C, Liquid Temperature: 22.3°C

Communication System: WLAN 5300 Duty Cycle: 1:1

Probe: EX3DV4 – SN3846 ConvF(5.05,5.27,5.51)

Area Scan (71x121x1): Interpolated grid: dx=1.000 mm, dy=1.000 mm

Maximum value of SAR (interpolated) = 0.707 W/kg

Zoom Scan (7x7x7)/Cube 0: Measurement grid: dx=4mm, dy=4mm, dz=1.4mm

Reference Value = 7.696 V/m; Power Drift = -0.03 dB

Peak SAR (extrapolated) = 5.53 W/kg

SAR(1 g) = 0.03 W/kg; SAR(10 g) = 0.012 W/kg

Maximum value of SAR (measured) = 0.971 W/kg

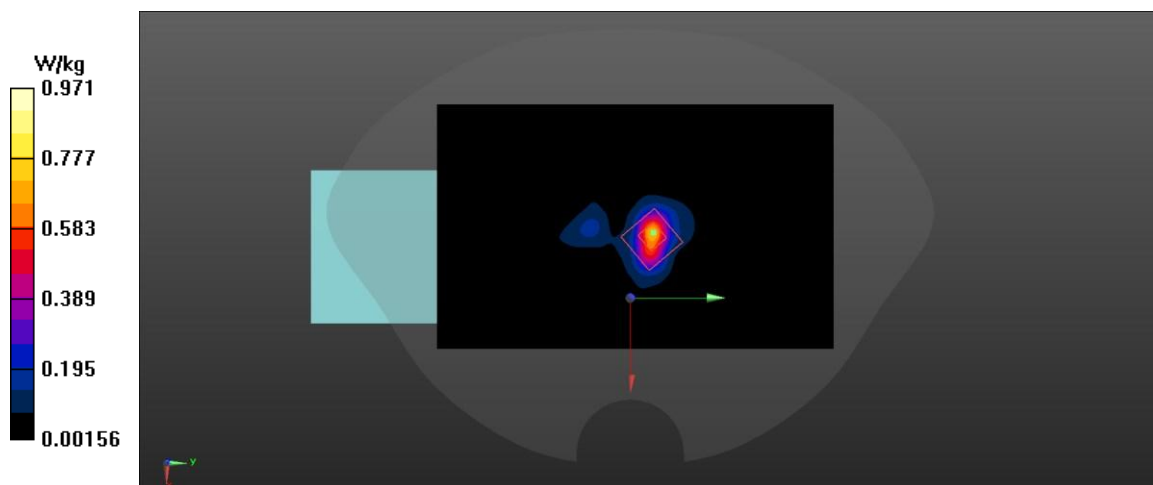

Fig A.73

WLAN5G_CH60 Rear 0mm

Date: 1/23/2024

Electronics: DAE4 Sn1601

Medium: head 5250 MHz

Medium parameters used: $f = 5300$; $\sigma = 4.45$ mho/m; $\epsilon_r = 34.378$; $\rho = 1000$ kg/m³

Ambient Temperature: 22.5°C, Liquid Temperature: 22.3°C

Communication System: WLAN 5300 Duty Cycle: 1:1

Probe: EX3DV4 – SN3846 ConvF(5.05,5.27,5.51)

Area Scan (71x121x1): Interpolated grid: dx=1.000 mm, dy=1.000 mm

Maximum value of SAR (interpolated) = 0.707 W/kg

Zoom Scan (7x7x7)/Cube 0: Measurement grid: dx=4mm, dy=4mm, dz=1.4mm

Reference Value = 7.696 V/m; Power Drift = 0.13 dB

Peak SAR (extrapolated) = 5.53 W/kg

SAR(1 g) = 0.984 W/kg; SAR(10 g) = 0.279 W/kg

Maximum value of SAR (measured) = 0.971 W/kg

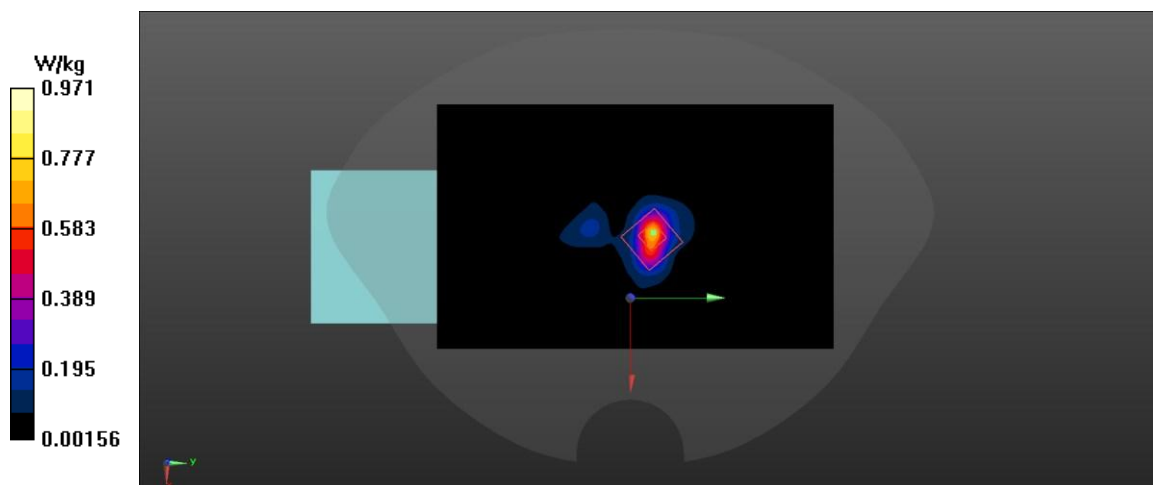

Fig A.74

WLAN5G_CH149 Rear 15mm

Date: 1/23/2024

Electronics: DAE4 Sn1601

Medium: head 5750 MHz

Medium parameters used: $f = 5745$; $\sigma = 5.113$ mho/m; $\epsilon_r = 33.816$; $\rho = 1000$ kg/m³

Ambient Temperature: 22.5°C, Liquid Temperature: 22.3°C

Communication System: WLAN 5745 Duty Cycle: 1:1

Probe: EX3DV4 – SN3846 ConvF(4.54,4.76,4.98)

Area Scan (71x121x1): Interpolated grid: dx=1.000 mm, dy=1.000 mm

Maximum value of SAR (interpolated) = 0.469 W/kg

Zoom Scan (7x7x7)/Cube 0: Measurement grid: dx=4mm, dy=4mm, dz=1.4mm

Reference Value = 1.411 V/m; Power Drift = -0.24 dB

Peak SAR (extrapolated) = 2.32 W/kg

SAR(1 g) = 0.529 W/kg; SAR(10 g) = 0.216 W/kg

Maximum value of SAR (measured) = 0.444 W/kg

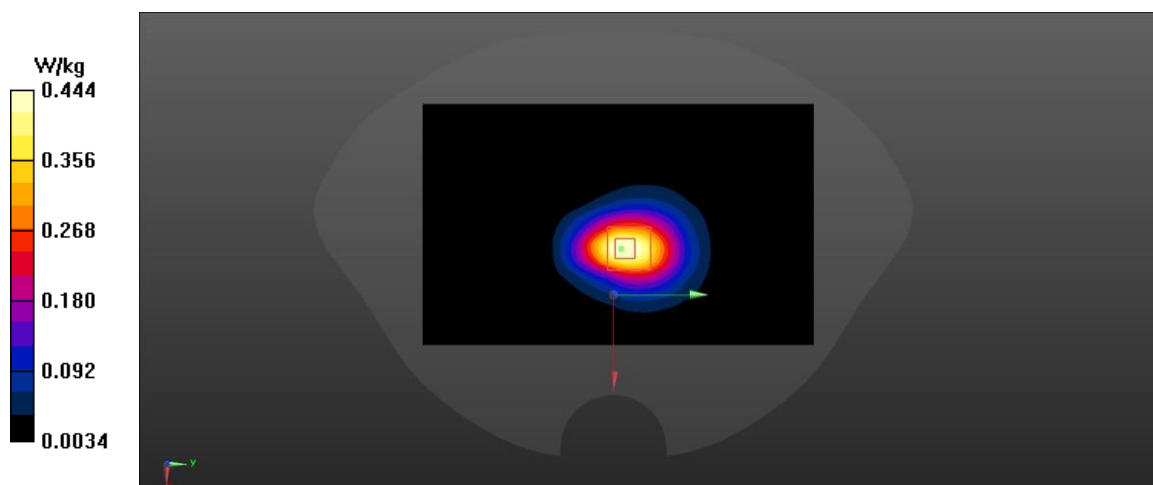

Fig A.75

WLAN5G_CH149 Left Cheek

Date: 1/26/2024

Electronics: DAE4 Sn1601

Medium: head 5750 MHz

Medium parameters used: $f = 5745$; $\sigma = 5.113$ mho/m; $\epsilon_r = 33.816$; $\rho = 1000$ kg/m³

Ambient Temperature: 22.5°C, Liquid Temperature: 22.3°C

Communication System: WLAN 5745 Duty Cycle: 1:1

Probe: EX3DV4 – SN3846 ConvF(4.54,4.76,4.98)

Area Scan (71x121x1): Interpolated grid: dx=1.000 mm, dy=1.000 mm

Maximum value of SAR (interpolated) = 0.539 W/kg

Zoom Scan (7x7x7)/Cube 0: Measurement grid: dx=4mm, dy=4mm, dz=1.4mm

Reference Value = 1.936 V/m; Power Drift = -0.06 dB

Peak SAR (extrapolated) = 0.81 W/kg

SAR(1 g) = 0.261 W/kg; SAR(10 g) = 0.089 W/kg

Maximum value of SAR (measured) = 0.323 W/kg

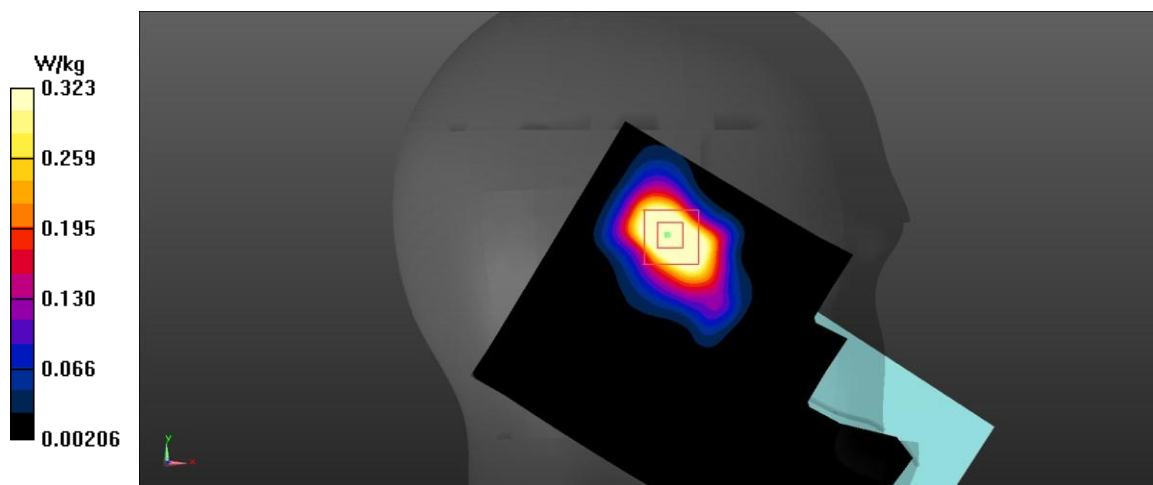

Fig A.76

WLAN5G_CH161 Rear 15mm

Date: 1/26/2024

Electronics: DAE4 Sn1601

Medium: head 5750 MHz

Medium parameters used: $f = 5805$; $\sigma = 5.102$ mho/m; $\epsilon_r = 33.44$; $\rho = 1000$ kg/m³

Ambient Temperature: 22.5°C, Liquid Temperature: 22.3°C

Communication System: WLAN 5805 Duty Cycle: 1:1

Probe: EX3DV4 – SN3846 ConvF(4.54,4.76,4.98)

Area Scan (71x121x1): Interpolated grid: dx=1.000 mm, dy=1.000 mm

Maximum value of SAR (interpolated) = 0.105 W/kg

Zoom Scan (7x7x7)/Cube 0: Measurement grid: dx=4mm, dy=4mm, dz=1.4mm

Reference Value = 1.219 V/m; Power Drift = 0.14 dB

Peak SAR (extrapolated) = 0.168 W/kg

SAR(1 g) = 0.053 W/kg; SAR(10 g) = 0.022 W/kg

Maximum value of SAR (measured) = 0.055 W/kg

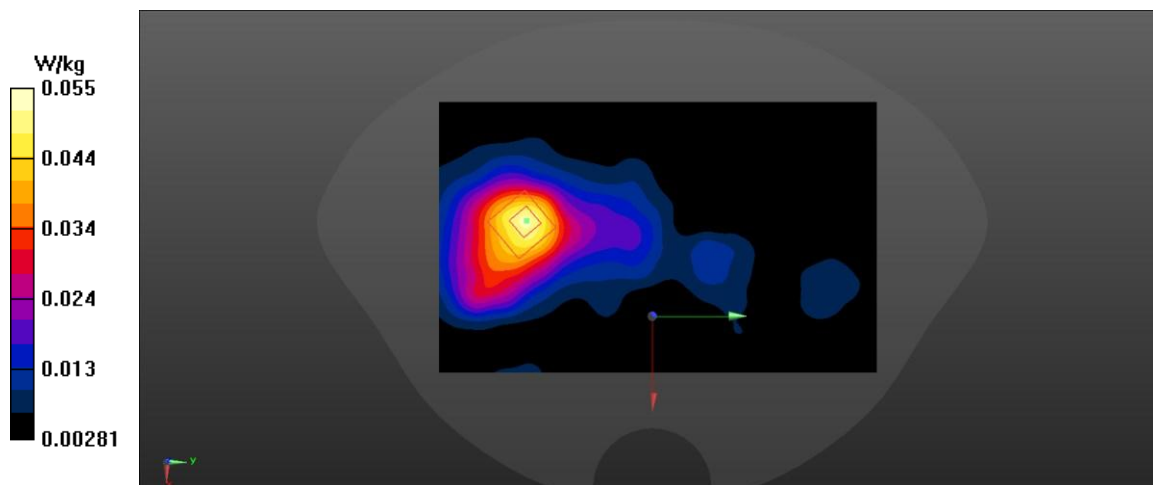

Fig A.77

ANNEX B System Verification Results

750 MHz

Date: 2024/1/10

Electronics: DAE4 Sn1601

Medium: Head 750 MHz

Medium parameters used: $f = 750$ MHz; $\sigma = 0.89$ mho/m; $\epsilon_r = 41.28$; $\rho = 1000$ kg/m³

Ambient Temperature: 22.5°C Liquid Temperature: 22.3°C

Communication System: CW Frequency: 750 MHz Duty Cycle: 1:1

Probe: EX3DV4 – SN3846 ConvF(8.98,8.99,10.08)

System Validation /Area Scan (81x191x1): Interpolated grid: dx=1.500 mm, dy=1.500 mm

Reference Value = 59.36 V/m; Power Drift = 0.02

Fast SAR: SAR(1 g) = 2.08 W/kg; SAR(10 g) = 1.37 W/kg

Maximum value of SAR (interpolated) = 2.78 W/kg

System Validation /Zoom Scan (7x7x7)/Cube 0: Measurement grid: dx=8mm, dy=8mm, dz=5mm

Reference Value = 59.36 V/m; Power Drift = 0.02 dB

Peak SAR (extrapolated) = 3.2 W/kg

SAR(1 g) = 2.08 W/kg; SAR(10 g) = 1.39 W/kg

Maximum value of SAR (measured) = 2.91 W/kg

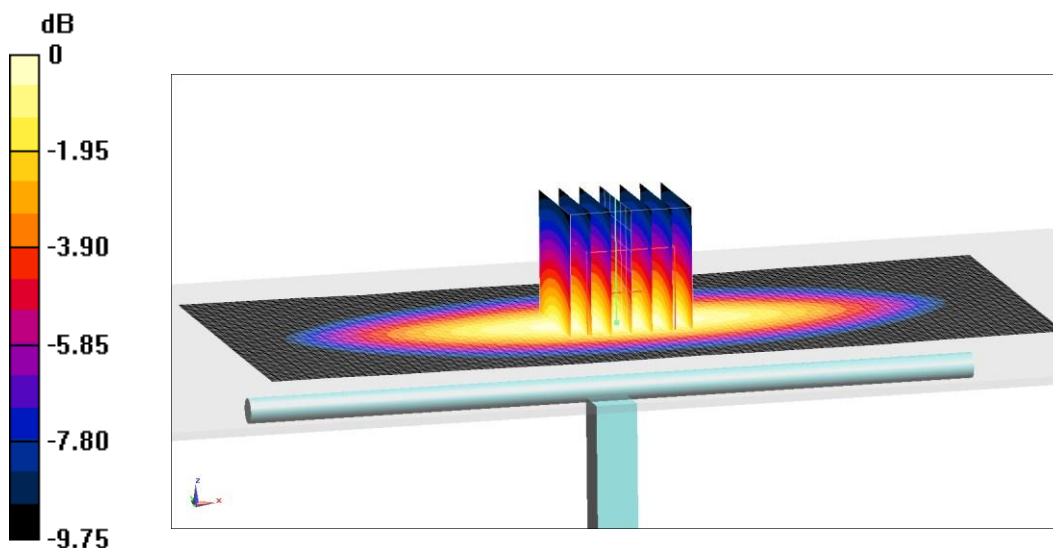

0 dB = 2.91 W/kg = 4.64 dB W/kg

Fig.B.1 validation 750 MHz 250mW

835 MHz

Date: 2024/1/11

Electronics: DAE4 Sn1601

Medium: Head 835 MHz

Medium parameters used: $f = 835 \text{ MHz}$; $\sigma = 0.898 \text{ mho/m}$; $\epsilon_r = 40.92$; $\rho = 1000 \text{ kg/m}^3$

Ambient Temperature: 22.5°C Liquid Temperature: 22.3°C

Communication System: CW Frequency: 835 MHz Duty Cycle: 1:1

Probe: EX3DV4 – SN3846 ConvF(8.50,9.01,9.47)

System Validation /Area Scan (81x191x1): Interpolated grid: $dx=1.500 \text{ mm}$, $dy=1.500 \text{ mm}$

Reference Value = 64.22 V/m ; Power Drift = -0.08

Fast SAR: SAR(1 g) = 2.4 W/kg ; SAR(10 g) = 1.55 W/kg

Maximum value of SAR (interpolated) = 3.23 W/kg

System Validation /Zoom Scan (7x7x7)/Cube 0: Measurement grid: $dx=8\text{mm}$, $dy=8\text{mm}$, $dz=5\text{mm}$

Reference Value = 64.22 V/m ; Power Drift = -0.08 dB

Peak SAR (extrapolated) = 3.64 W/kg

SAR(1 g) = 2.41 W/kg ; SAR(10 g) = 1.59 W/kg

Maximum value of SAR (measured) = 3.25 W/kg

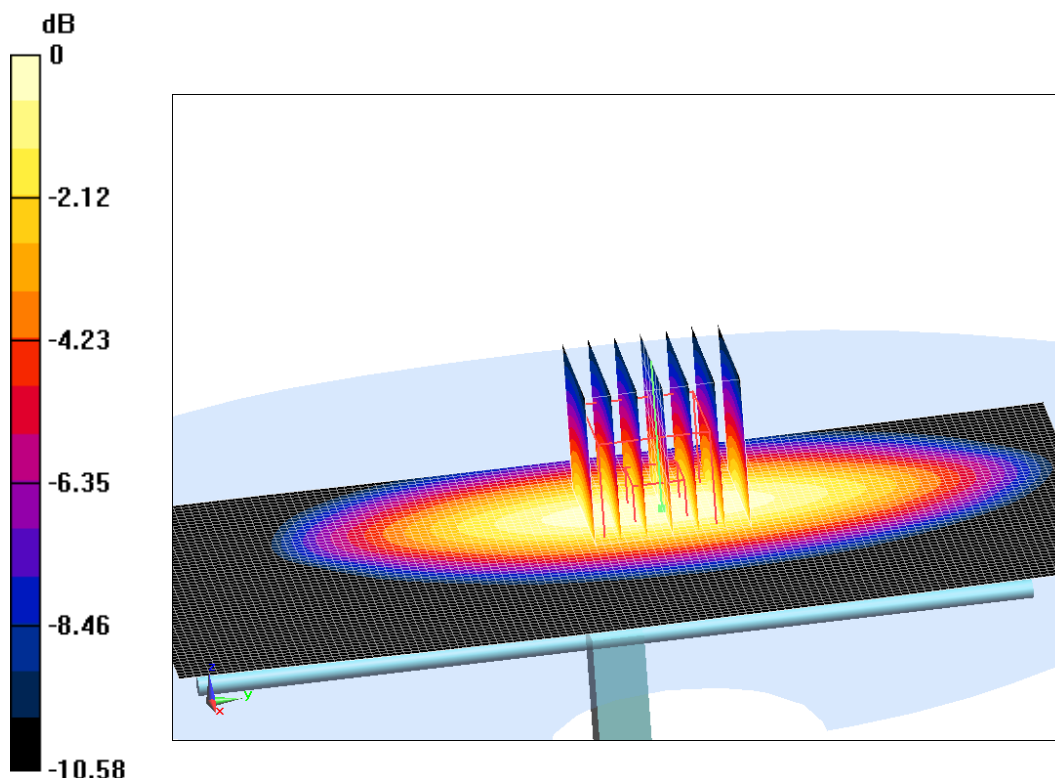

$0 \text{ dB} = 3.25 \text{ W/kg} = 5.12 \text{ dB W/kg}$



Fig.B.2 validation 835 MHz 250mW

1750 MHz

Date: 2024/1/12

Electronics: DAE4 Sn1601

Medium: Head 1750 MHz

Medium parameters used: $f = 1750$ MHz; $\sigma = 1.358$ mho/m; $\epsilon_r = 39.69$; $\rho = 1000$ kg/m³

Ambient Temperature: 22.5°C Liquid Temperature: 22.3°C

Communication System: CW Frequency: 1750 MHz Duty Cycle: 1:1

Probe: EX3DV4 – SN3846 ConvF(7.47,7.79,8.45)

System Validation /Area Scan (81x191x1): Interpolated grid: dx=1.500 mm, dy=1.500 mm

Reference Value = 104.11 V/m; Power Drift = 0.06

Fast SAR: SAR(1 g) = 9.04 W/kg; SAR(10 g) = 4.69 W/kg

Maximum value of SAR (interpolated) = 14.07 W/kg

System Validation /Zoom Scan (7x7x7)/Cube 0: Measurement grid: dx=8mm, dy=8mm, dz=5mm

Reference Value = 104.11 V/m; Power Drift = 0.06 dB

Peak SAR (extrapolated) = 16.62 W/kg

SAR(1 g) = 9.02 W/kg; SAR(10 g) = 4.79 W/kg

Maximum value of SAR (measured) = 14.34 W/kg

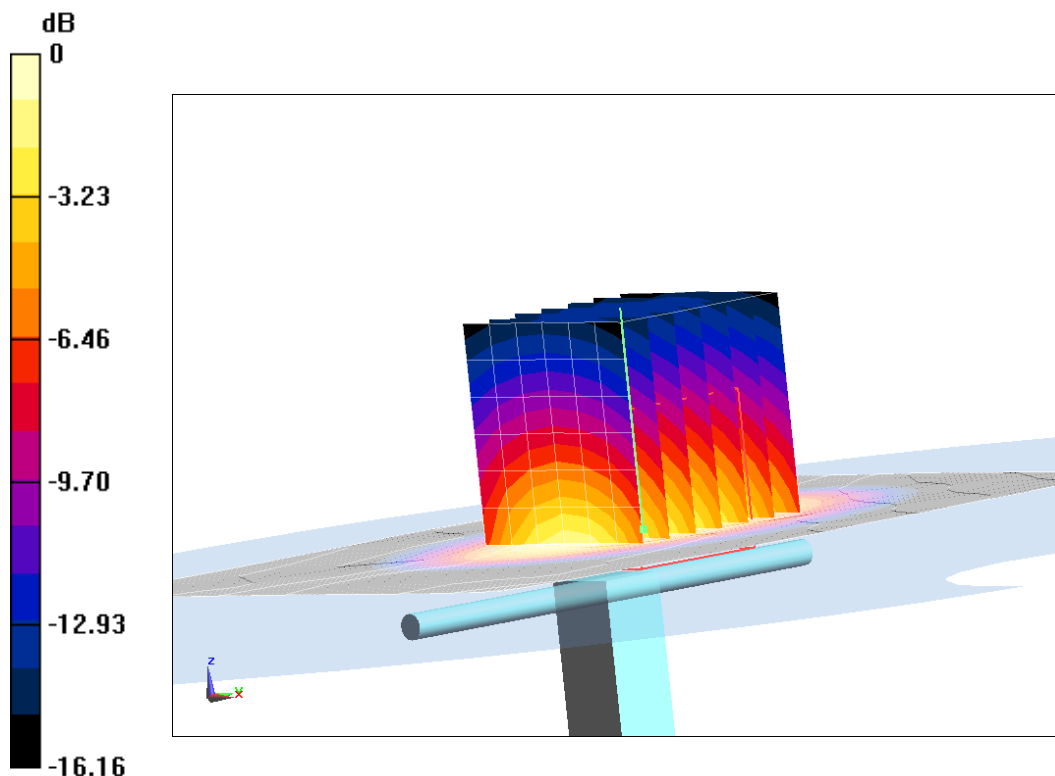

0 dB = 14.34 W/kg = 11.57 dB W/kg



Fig.B.3 validation 1750 MHz 250mW

1900 MHz

Date: 2024/1/13

Electronics: DAE4 Sn1601

Medium: Head 1900 MHz

Medium parameters used: $f = 1900$ MHz; $\sigma = 1.408$ mho/m; $\epsilon_r = 40.74$; $\rho = 1000$ kg/m³

Ambient Temperature: 22.5°C Liquid Temperature: 22.3°C

Communication System: CW Frequency: 1900 MHz Duty Cycle: 1:1

Probe: EX3DV4 – SN3846 ConvF(7.27,7.55,8.11)

System Validation /Area Scan (81x191x1): Interpolated grid: dx=1.500 mm, dy=1.500 mm

Reference Value = 110.74 V/m; Power Drift = -0.03

Fast SAR: SAR(1 g) = 10.1 W/kg; SAR(10 g) = 5.05 W/kg

Maximum value of SAR (interpolated) = 15.26 W/kg

System Validation /Zoom Scan (7x7x7)/Cube 0: Measurement grid: dx=8mm, dy=8mm, dz=5mm

Reference Value = 110.74 V/m; Power Drift = -0.03 dB

Peak SAR (extrapolated) = 18.19 W/kg

SAR(1 g) = 9.92 W/kg; SAR(10 g) = 5.16 W/kg

Maximum value of SAR (measured) = 15.41 W/kg

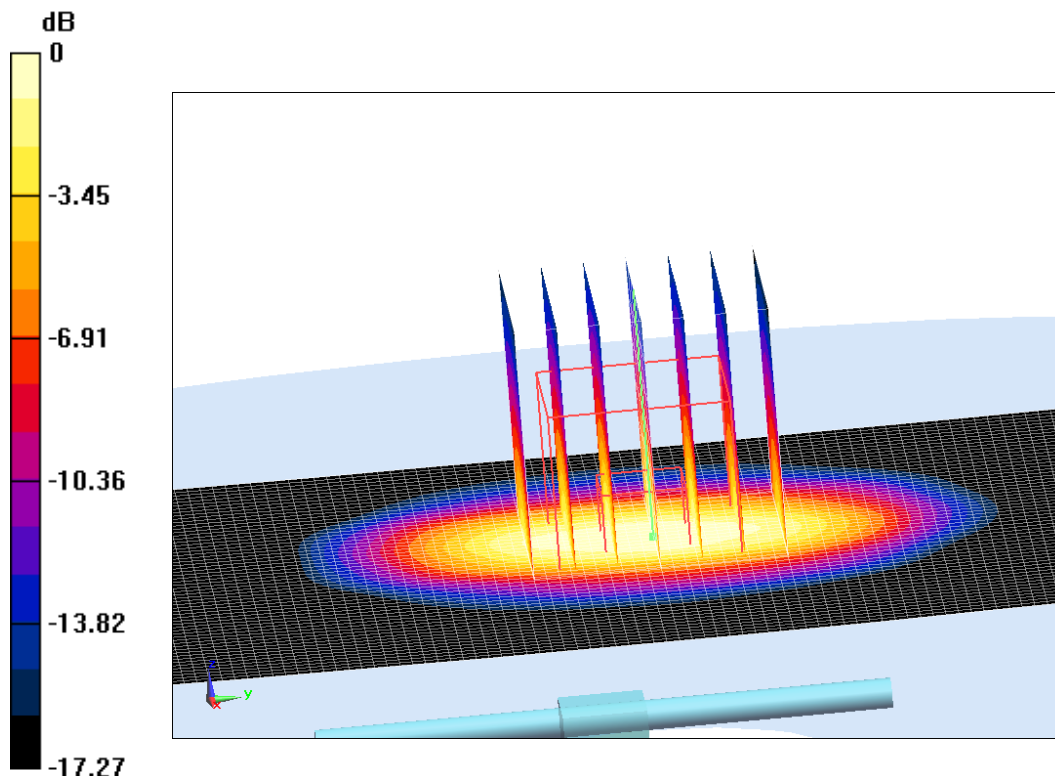

0 dB = 15.41 W/kg = 11.88 dB W/kg



Fig.B.4 validation 1900 MHz 250mW

2600 MHz

Date: 2024/1/14

Electronics: DAE4 Sn1601

Medium: Head 2600 MHz

Medium parameters used: $f = 2600$ MHz; $\sigma = 1.999$ mho/m; $\epsilon_r = 39$; $\rho = 1000$ kg/m³

Ambient Temperature: 22.5°C Liquid Temperature: 22.3°C

Communication System: CW Frequency: 2600 MHz Duty Cycle: 1:1

Probe: EX3DV4 – SN3846 ConvF(6.72,7.04,7.50)

System Validation /Area Scan (81x191x1): Interpolated grid: dx=1.200 mm, dy=1.200 mm

Reference Value = 122.15 V/m; Power Drift = -0.02

Fast SAR: SAR(1 g) = 14.21 W/kg; SAR(10 g) = 6.26 W/kg

Maximum value of SAR (interpolated) = 23.97 W/kg

System Validation /Zoom Scan (7x7x7)/Cube 0: Measurement grid: dx=5mm, dy=5mm, dz=5mm

Reference Value = 122.15 V/m; Power Drift = -0.02 dB

Peak SAR (extrapolated) = 29.67 W/kg

SAR(1 g) = 14.24 W/kg; SAR(10 g) = 6.42 W/kg

Maximum value of SAR (measured) = 24.21 W/kg

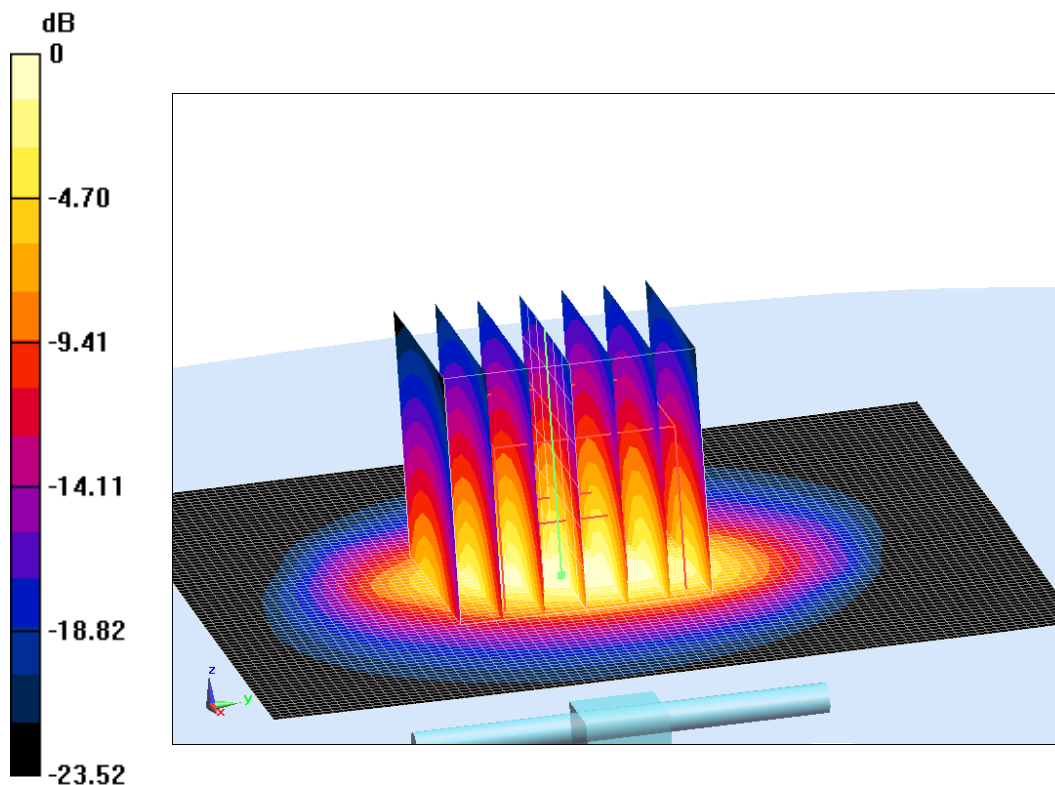

0 dB = 24.21 W/kg = 13.84 dB W/kg

Fig.B.5 validation 2600 MHz 250mW

750 MHz

Date: 2024/1/15

Electronics: DAE4 Sn1601

Medium: Head 750 MHz

Medium parameters used: $f = 750 \text{ MHz}$; $\sigma = 0.897 \text{ mho/m}$; $\epsilon_r = 42.07$; $\rho = 1000 \text{ kg/m}^3$

Ambient Temperature: 22.5°C Liquid Temperature: 22.3°C

Communication System: CW Frequency: 750 MHz Duty Cycle: 1:1

Probe: EX3DV4 – SN3846 ConvF(8.98,8.99,10.08)

System Validation /Area Scan (81x191x1): Interpolated grid: $dx=1.000 \text{ mm}$, $dy=1.000 \text{ mm}$

Reference Value = 58.99 V/m; Power Drift = -0.1

Fast SAR: SAR(1 g) = 2.08 W/kg; SAR(10 g) = 1.4 W/kg

Maximum value of SAR (interpolated) = 2.81 W/kg

System Validation /Zoom Scan (7x7x7)/Cube 0: Measurement grid: $dx=5\text{mm}$, $dy=5\text{mm}$, $dz=5\text{mm}$

Reference Value = 58.99 V/m; Power Drift = -0.1 dB

Peak SAR (extrapolated) = 3.3 W/kg

SAR(1 g) = 2.11 W/kg; SAR(10 g) = 1.4 W/kg

Maximum value of SAR (measured) = 2.92 W/kg

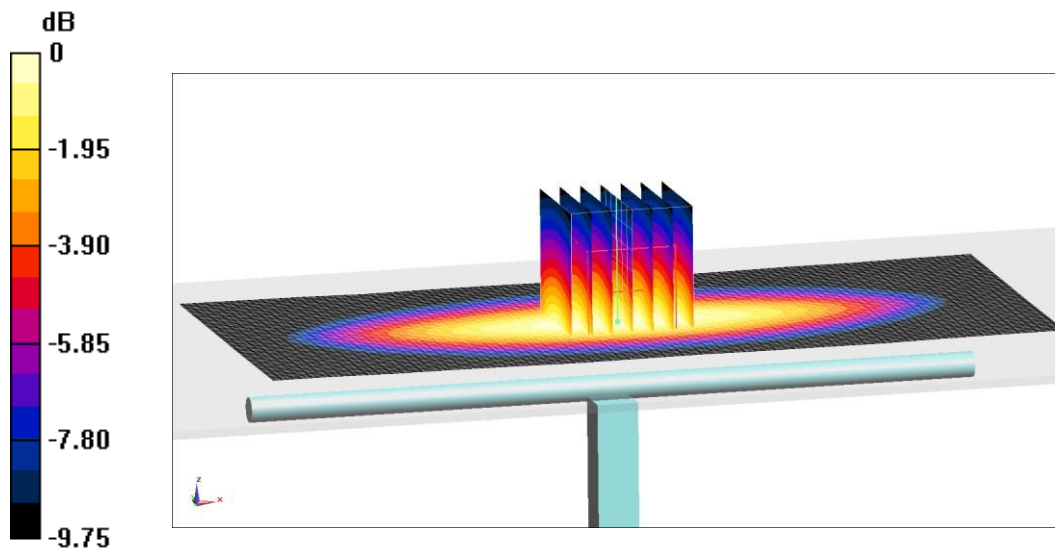

0 dB = 2.92 W/kg = 4.65 dB W/kg

Fig.B.6 validation 750 MHz 250mW

1750 MHz

Date: 2024/1/16

Electronics: DAE4 Sn1601

Medium: Head 1750 MHz

Medium parameters used: $f = 1750$ MHz; $\sigma = 1.346$ mho/m; $\epsilon_r = 40.03$; $\rho = 1000$ kg/m³

Ambient Temperature: 22.5°C Liquid Temperature: 22.3°C

Communication System: CW Frequency: 1750 MHz Duty Cycle: 1:1

Probe: EX3DV4 – SN3846 ConvF(7.47,7.79,8.45)

System Validation /Area Scan (81x191x1): Interpolated grid: dx=1.000 mm, dy=1.000 mm

Reference Value = 106.62 V/m; Power Drift = -0.05

Fast SAR: SAR(1 g) = 9.16 W/kg; SAR(10 g) = 4.85 W/kg

Maximum value of SAR (interpolated) = 14.15 W/kg

System Validation /Zoom Scan (7x7x7)/Cube 0: Measurement grid: dx=5mm, dy=5mm, dz=5mm

Reference Value =106.62 V/m; Power Drift = -0.05 dB

Peak SAR (extrapolated) = 17.02 W/kg

SAR(1 g) = 9.2 W/kg; SAR(10 g) = 4.73 W/kg

Maximum value of SAR (measured) = 13.88 W/kg

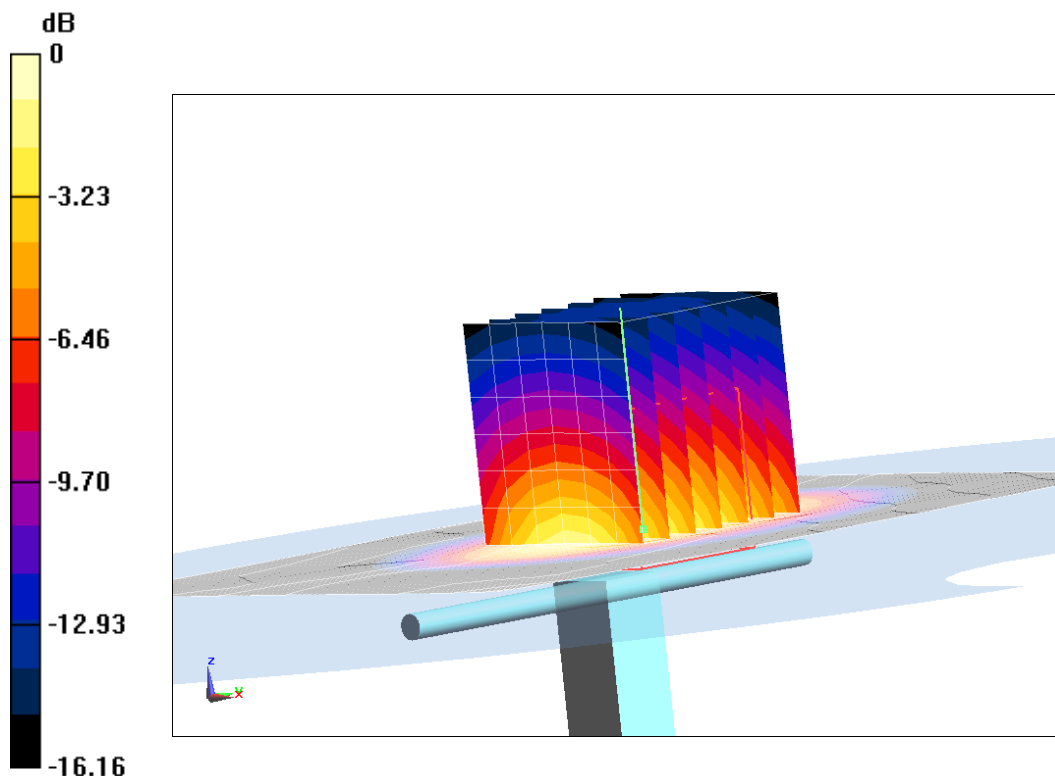

0 dB = 13.88 W/kg = 11.42 dB W/kg

Fig.B.7 validation 1750 MHz 250mW

1900 MHz

Date: 2024/1/17

Electronics: DAE4 Sn1601

Medium: Head 1900 MHz

Medium parameters used: $f = 1900 \text{ MHz}$; $\sigma = 1.404 \text{ mho/m}$; $\epsilon_r = 39.36$; $\rho = 1000 \text{ kg/m}^3$

Ambient Temperature: 22.5°C Liquid Temperature: 22.3°C

Communication System: CW Frequency: 1900 MHz Duty Cycle: 1:1

Probe: EX3DV4 – SN3846 ConvF(7.27,7.55,8.11)

System Validation /Area Scan (81x191x1): Interpolated grid: dx=1.000 mm, dy=1.000 mm

Reference Value = 107.96 V/m; Power Drift = -0.04

Fast SAR: SAR(1 g) = 10.09 W/kg; SAR(10 g) = 5.1 W/kg

Maximum value of SAR (interpolated) = 15.24 W/kg

System Validation /Zoom Scan (7x7x7)/Cube 0: Measurement grid: dx=5mm, dy=5mm, dz=5mm

Reference Value = 107.96 V/m; Power Drift = -0.04 dB

Peak SAR (extrapolated) = 18.06 W/kg

SAR(1 g) = 9.77 W/kg; SAR(10 g) = 5.13 W/kg

Maximum value of SAR (measured) = 15.33 W/kg

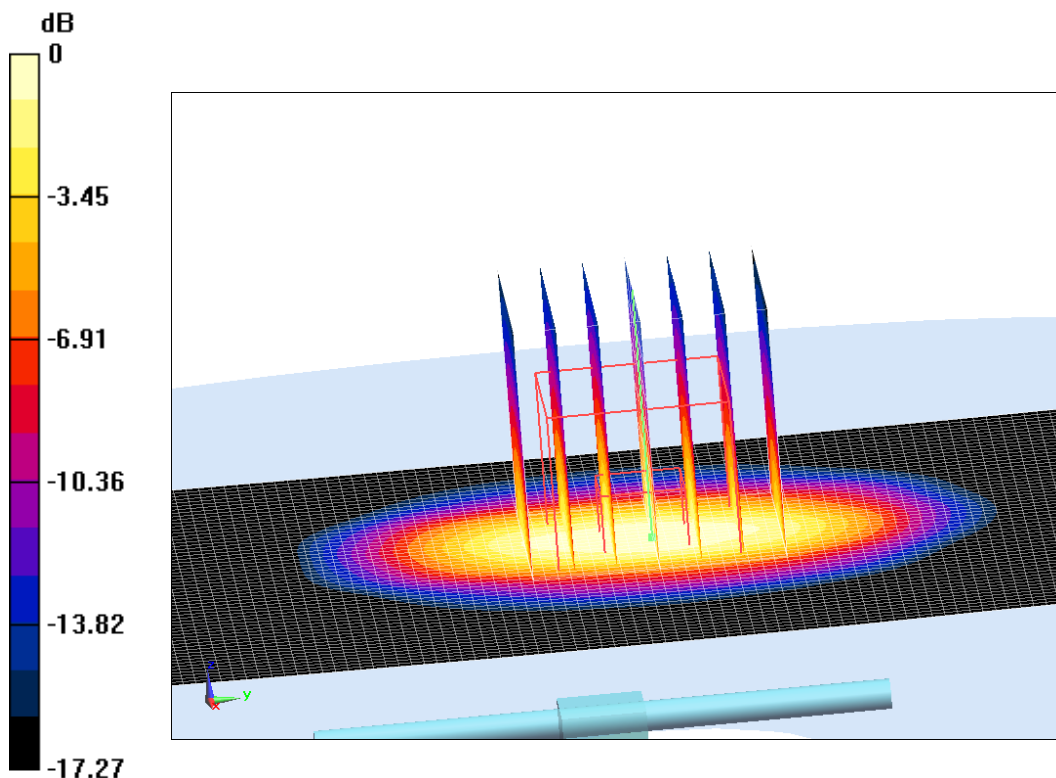



0 dB = 15.33 W/kg = 11.86 dB W/kg

Fig.B.8 validation 1900 MHz 250mW

2600 MHz

Date: 2024/1/18

Electronics: DAE4 Sn1601

Medium: Head 2600 MHz

Medium parameters used: $f = 2600$ MHz; $\sigma = 1.935$ mho/m; $\epsilon_r = 38.36$; $\rho = 1000$ kg/m³

Ambient Temperature: 22.5°C Liquid Temperature: 22.3°C

Communication System: CW Frequency: 2600 MHz Duty Cycle: 1:1

Probe: EX3DV4 – SN3846 ConvF(6.72,7.04,7.50)

System Validation /Area Scan (81x191x1): Interpolated grid: dx=1.000 mm, dy=1.000 mm

Reference Value = 123.17 V/m; Power Drift = 0.06

Fast SAR: SAR(1 g) = 14.33 W/kg; SAR(10 g) = 6.31 W/kg

Maximum value of SAR (interpolated) = 24.71 W/kg

System Validation /Zoom Scan (7x7x7)/Cube 0: Measurement grid: dx=5mm, dy=5mm, dz=5mm

Reference Value =123.17 V/m; Power Drift = 0.06 dB

Peak SAR (extrapolated) = 29.05 W/kg

SAR(1 g) = 14.28 W/kg; SAR(10 g) = 6.43 W/kg

Maximum value of SAR (measured) = 23.93 W/kg

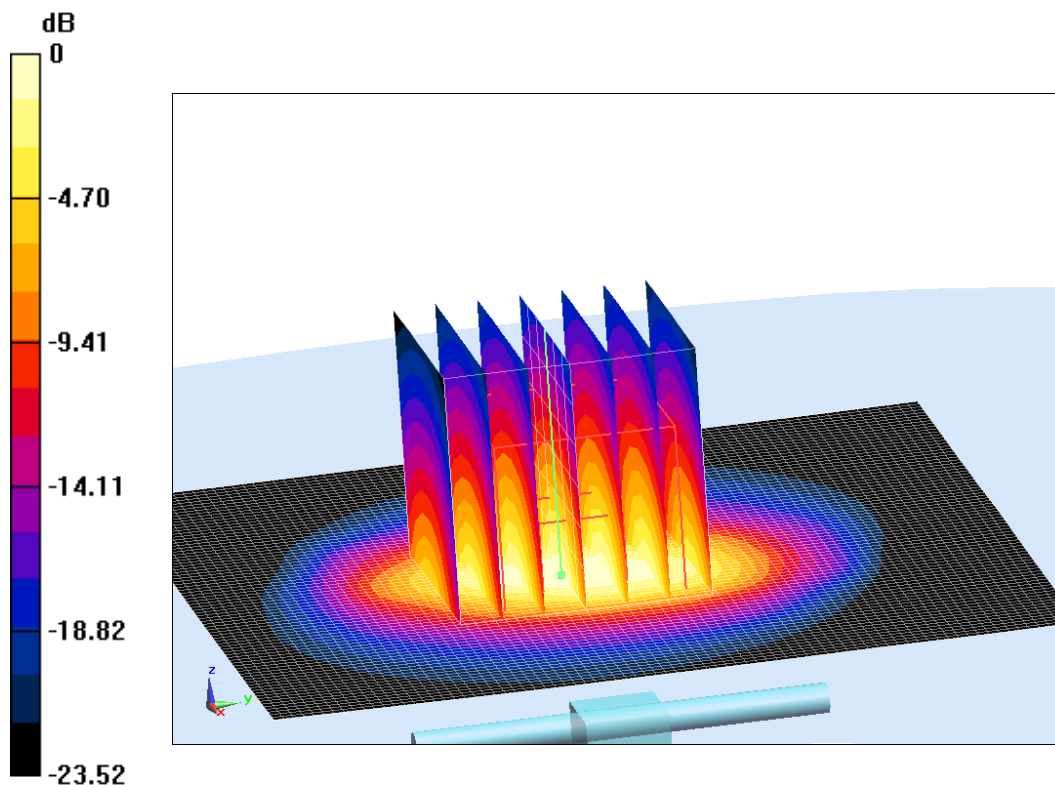

0 dB = 23.93 W/kg = 13.79 dB W/kg

Fig.B.9 validation 2600 MHz 250mW

3500MHz

Date: 2024/1/19

Electronics: DAE4 Sn1601

Medium: Head 3500 MHz

Medium parameters used: $f = 3500 \text{ MHz}$; $\sigma = 2.818 \text{ S/m}$; $\epsilon_r = 40.96$; $\rho = 1000 \text{ kg/m}^3$

Ambient Temperature: 23.3°C Liquid Temperature: 22.5°C

Communication System: CW (0) Frequency: 3500 MHz Duty Cycle: 1:1

Probe: EX3DV4 – SN3846 ConvF(6.50,6.78,7.20)

Area Scan (91x91x1): Interpolated grid: $dx=1.000 \text{ mm}$, $dy=1.000 \text{ mm}$

Maximum value of SAR (interpolated) = 13.2 W/kg

Zoom Scan (4x4x1.4mm, graded), $dist=1.4\text{mm}$ (8x8x8)/Cube 0: Measurement grid: $dx=4\text{mm}$, $dy=4\text{mm}$, $dz=1.4\text{mm}$

Reference Value = 71.26 V/m ; Power Drift = -0.02 dB

Peak SAR (extrapolated) = 18.0 W/kg

SAR(1 g) = 6.70 W/kg ; SAR(10 g) = 2.53 W/kg

Maximum value of SAR (measured) = 12.8 W/kg

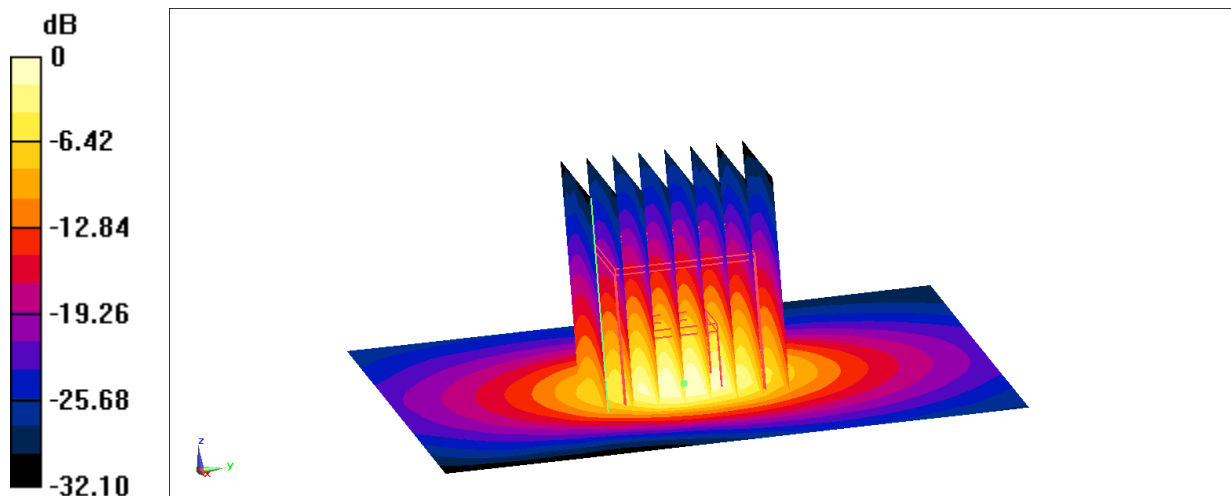

0 dB = $12.8 \text{ W/kg} = 11.07 \text{ dBW/kg}$

Fig.B.10 validation 3500 MHz 250mW

3700MHz

Date: 2024/1/19

Electronics: DAE4 Sn1601

Medium: head 3700 MHz

Medium parameters used: $f = 3700$ MHz; $\sigma = 2.653$ S/m; $\epsilon_r = 37.179$; $\rho = 1000$ kg/m³

Ambient Temperature: 23.3°C Liquid Temperature: 22.5°C

Communication System: CW (0) Frequency: 3700 MHz Duty Cycle: 1:1

Probe: EX3DV4 – SN3846 ConvF(6.79, 6.79, 6.79)

Area Scan (91x91x1): Interpolated grid: dx=1.000 mm, dy=1.000 mm

Maximum value of SAR (interpolated) = 13.6 W/kg

Zoom Scan (4x4x1.4mm, graded), dist=1.4mm (8x8x8)/Cube 0: Measurement grid: dx=4mm, dy=4mm, dz=1.4mm

Reference Value = 68.92 V/m; Power Drift = -0.07 dB

Peak SAR (extrapolated) = 18.7 W/kg

SAR(1 g) = 6.46 W/kg; SAR(10 g) = 2.49 W/kg

Maximum value of SAR (measured) = 12.9 W/kg

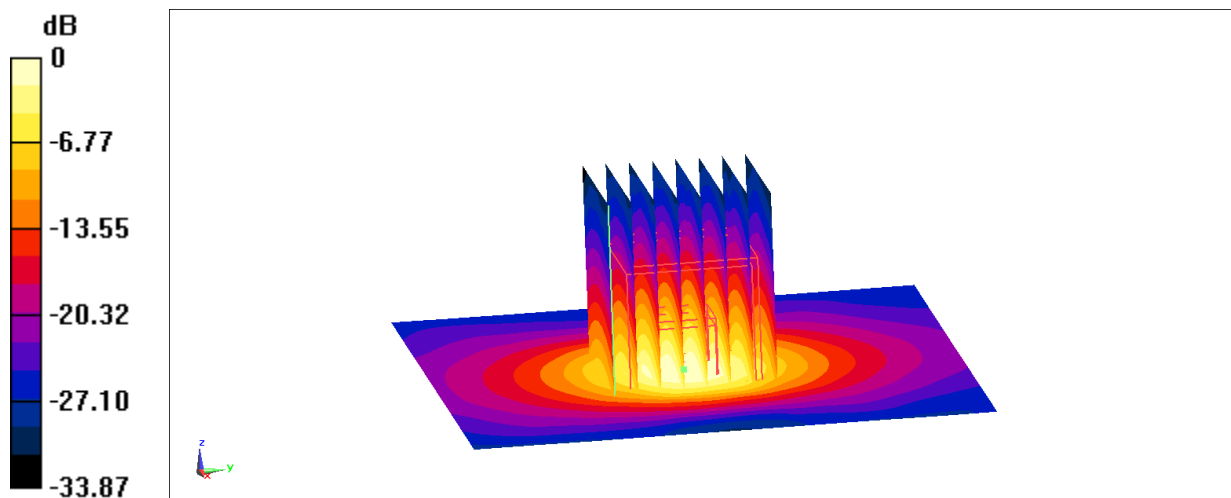

0 dB = 12.9 W/kg = 11.11 dBW/kg

Fig.B.11 validation 3700 MHz 250mW

3900MHz

Date: 2024/1/19

Electronics: DAE4 Sn1601

Medium: head 3900 MHz

Medium parameters used: $f = 3900 \text{ MHz}$; $\sigma = 3.196 \text{ S/m}$; $\epsilon_r = 39.4$; $\rho = 1000 \text{ kg/m}^3$

Ambient Temperature: 23.3°C Liquid Temperature: 22.5°C

Communication System: CW (0) Frequency: 3900 MHz Duty Cycle: 1:1

Probe: EX3DV4 – SN3846 ConvF(6.69, 6.69, 6.69)

Area Scan (91x91x1): Interpolated grid: $dx=1.000 \text{ mm}$, $dy=1.000 \text{ mm}$

Maximum value of SAR (interpolated) = 14.2 W/kg

Zoom Scan (4x4x1.4mm, graded), $dist=1.4\text{mm}$ (8x8x8)/Cube 0: Measurement grid: $dx=4\text{mm}$, $dy=4\text{mm}$, $dz=1.4\text{mm}$

Reference Value = 70.80 V/m; Power Drift = -0.05 dB

Peak SAR (extrapolated) = 19.8 W/kg

SAR(1 g) = 6.96 W/kg; SAR(10 g) = 2.41 W/kg

Maximum value of SAR (measured) = 13.6 W/kg

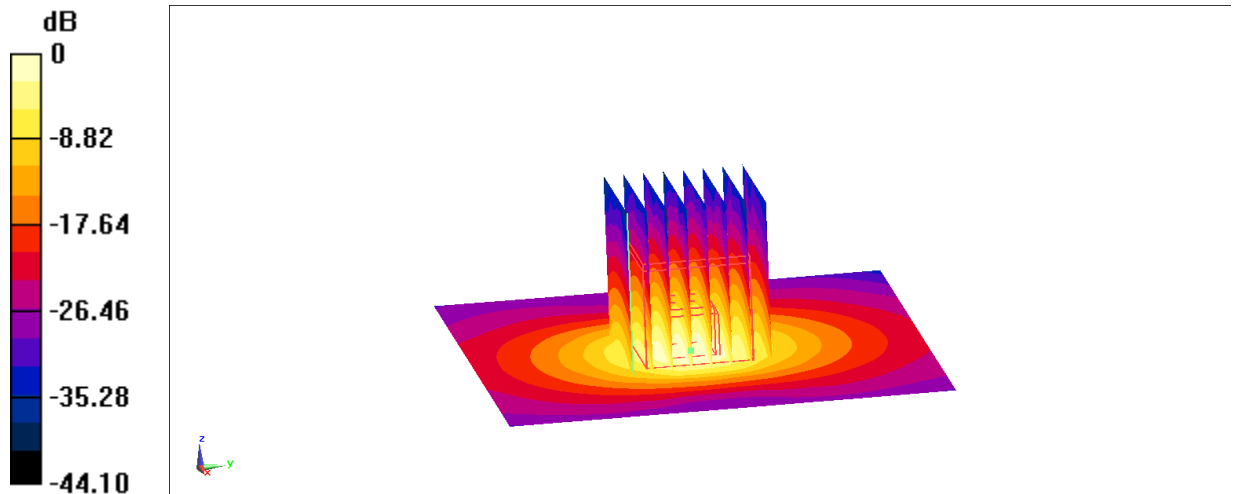

0 dB = 13.6 W/kg = 11.34 dBW/kg

Fig.B.12 validation 3900 MHz 250mW

2450 MHz

Date: 2024/1/23

Electronics: DAE4 Sn1601

Medium: Head 2450 MHz

Medium parameters used: $f = 2450$ MHz; $\sigma = 1.815$ mho/m; $\epsilon_r = 39.32$; $\rho = 1000$ kg/m³

Ambient Temperature: 22.5°C Liquid Temperature: 22.3°C

Communication System: CW Frequency: 2450 MHz Duty Cycle: 1:1

Probe: EX3DV4 – SN3846 ConvF(6.80,7.06,7.55)

System Validation /Area Scan (81x191x1): Interpolated grid: dx=1.000 mm, dy=1.000 mm

Reference Value = 117.26 V/m; Power Drift = -0.1

Fast SAR: SAR(1 g) = 12.89 W/kg; SAR(10 g) = 6.21 W/kg

Maximum value of SAR (interpolated) = 21.73 W/kg

System Validation /Zoom Scan (7x7x7)/Cube 0: Measurement grid: dx=5mm, dy=5mm, dz=5mm

Reference Value = 117.26 V/m; Power Drift = -0.1 dB

Peak SAR (extrapolated) = 26.53 W/kg

SAR(1 g) = 13.06 W/kg; SAR(10 g) = 6.22 W/kg

Maximum value of SAR (measured) = 22.19 W/kg

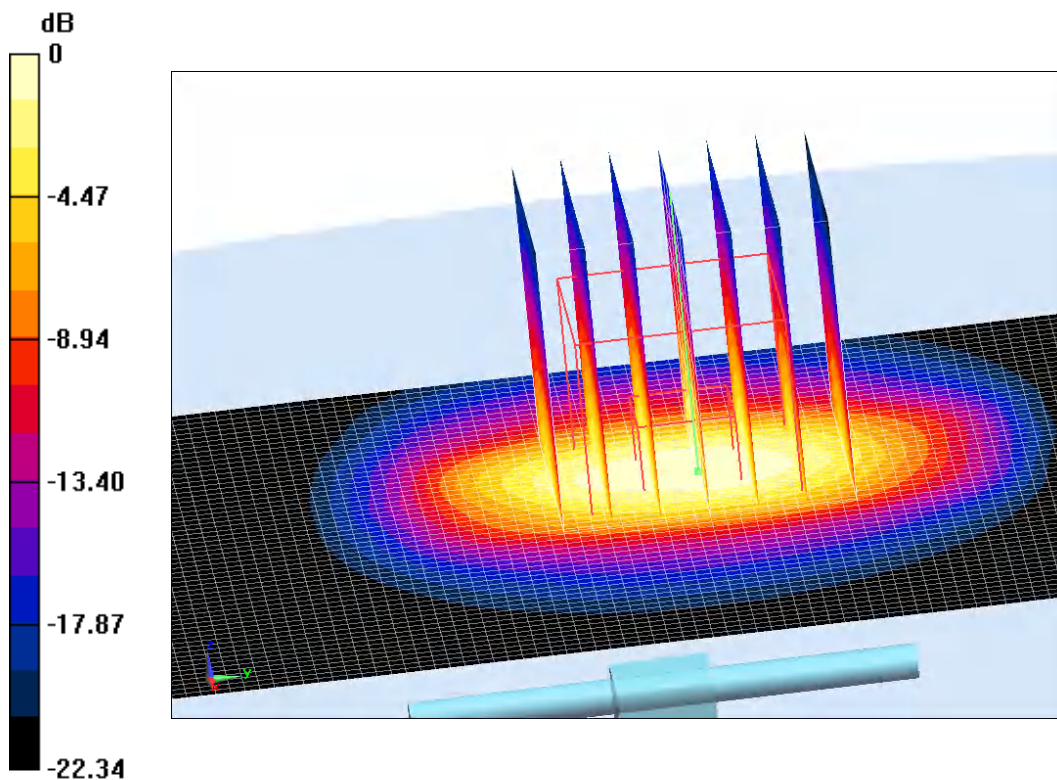



0 dB = 22.19 W/kg = 13.46 dB W/kg

Fig.B.13 validation 2450 MHz 250mW

5250 MHz

Date: 2024/1/24

Electronics: DAE4 Sn1601

Medium: Head 5250 MHz

Medium parameters used: $f = 5250 \text{ MHz}$; $\sigma = 4.626 \text{ mho/m}$; $\epsilon_r = 35.89$; $\rho = 1000 \text{ kg/m}^3$

Ambient Temperature: 22.5°C Liquid Temperature: 22.3°C

Communication System: CW Frequency: 5250 MHz Duty Cycle: 1:1

Probe: EX3DV4 – SN3846 ConvF(5.05,5.27,5.51)

System Validation /Area Scan (81x191x1): Interpolated grid: $dx=1.000 \text{ mm}$, $dy=1.000 \text{ mm}$

Reference Value = 79.46 V/m ; Power Drift = -0.05

System Validation /Zoom Scan (7x7x7)/Cube 0: Measurement grid: $dx=5\text{mm}$, $dy=5\text{mm}$, $dz=5\text{mm}$

Reference Value = 79.46 V/m ; Power Drift = -0.05 dB

Peak SAR (extrapolated) = 28.57 W/kg

SAR(1 g) = 20.28 W/kg ; SAR(10 g) = 5.67 W/kg

Maximum value of SAR (measured) = 18.11 W/kg

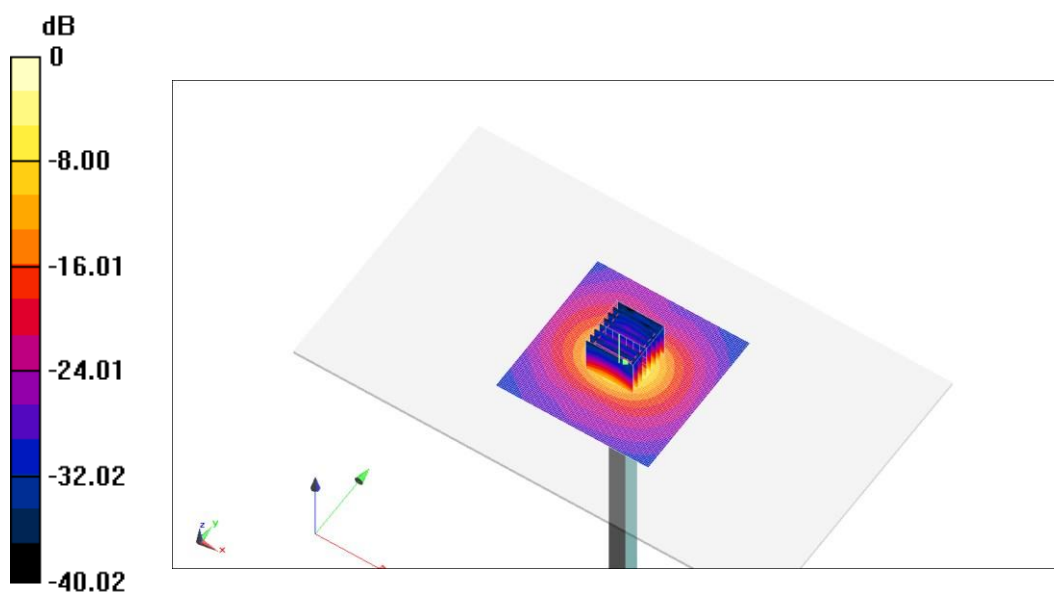

$0 \text{ dB} = 18.11 \text{ W/kg} = 12.58 \text{ dB W/kg}$

Fig.B.14 validation 5250 MHz 250mW

5600 MHz

Date: 2024/1/25

Electronics: DAE4 Sn1601

Medium: Head 5600 MHz

Medium parameters used: $f = 5600$ MHz; $\sigma = 5.085$ mho/m; $\epsilon_r = 34.97$; $\rho = 1000$ kg/m³

Ambient Temperature: 22.5°C Liquid Temperature: 22.3°C

Communication System: CW Frequency: 5600 MHz Duty Cycle: 1:1

Probe: EX3DV4 – SN3846 ConvF(4.274,47,4.7)

System Validation /Area Scan (81x191x1): Interpolated grid: dx=1.000 mm, dy=1.000 mm

Reference Value = 78.21 V/m; Power Drift = -0.04

System Validation /Zoom Scan (7x7x7)/Cube 0: Measurement grid: dx=5mm, dy=5mm, dz=5mm

Reference Value =78.21 V/m; Power Drift = -0.04 dB

Peak SAR (extrapolated) = 31.35 W/kg

SAR(1 g) = 20.54 W/kg; SAR(10 g) = 5.88 W/kg

Maximum value of SAR (measured) = 20.37 W/kg

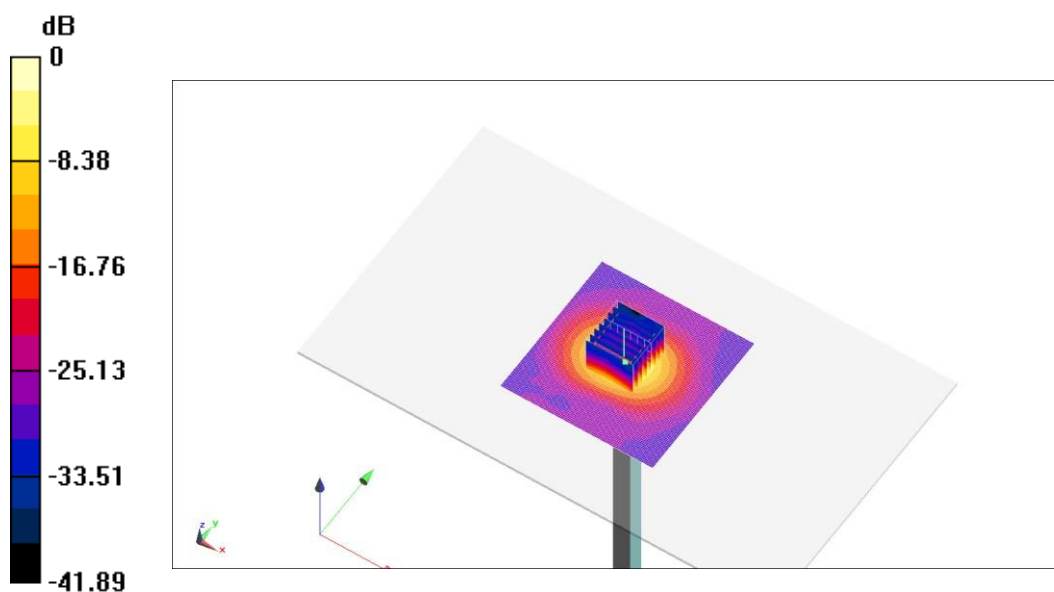

0 dB = 20.37 W/kg = 13.09 dB W/kg

Fig.B.15 validation 5600 MHz 250mW

5750 MHz

Date: 2024/1/26

Electronics: DAE4 Sn1601

Medium: Head 5750 MHz

Medium parameters used: $f = 5750 \text{ MHz}$; $\sigma = 5.154 \text{ mho/m}$; $\epsilon_r = 34.77$; $\rho = 1000 \text{ kg/m}^3$

Ambient Temperature: 22.5°C Liquid Temperature: 22.3°C

Communication System: CW Frequency: 5750 MHz Duty Cycle: 1:1

Probe: EX3DV4 – SN3846 ConvF(4.54,4.76,4.98)

System Validation /Area Scan (81x191x1): Interpolated grid: $dx=1.000 \text{ mm}$, $dy=1.000 \text{ mm}$

Reference Value = 76.92 V/m ; Power Drift = 0.06

System Validation /Zoom Scan (7x7x7)/Cube 0: Measurement grid: $dx=5\text{mm}$, $dy=5\text{mm}$, $dz=5\text{mm}$

Reference Value = 76.92 V/m ; Power Drift = 0.06 dB

Peak SAR (extrapolated) = 31.83 W/kg

SAR(1 g) = 20.15 W/kg ; SAR(10 g) = 5.77 W/kg

Maximum value of SAR (measured) = 19.52 W/kg

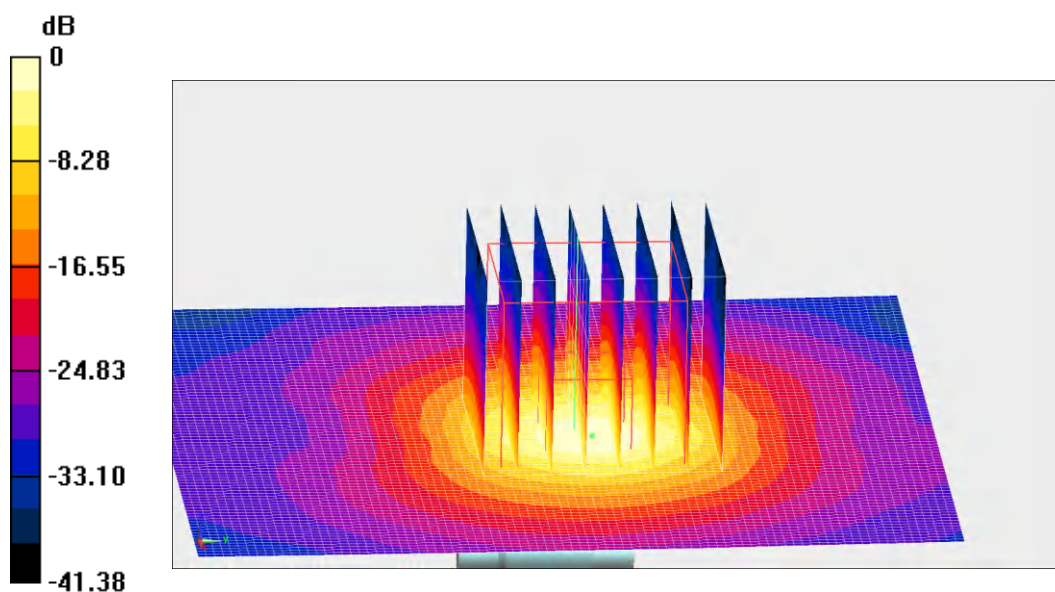

0 dB = $19.52 \text{ W/kg} = 12.9 \text{ dB W/kg}$

Fig.B.16 validation 5750 MHz 250mW

ANNEX C SAR Measurement Setup

C.1 Measurement Set-up

The Dasy4 or DASY5 system for performing compliance tests is illustrated above graphically. This system consists of the following items:

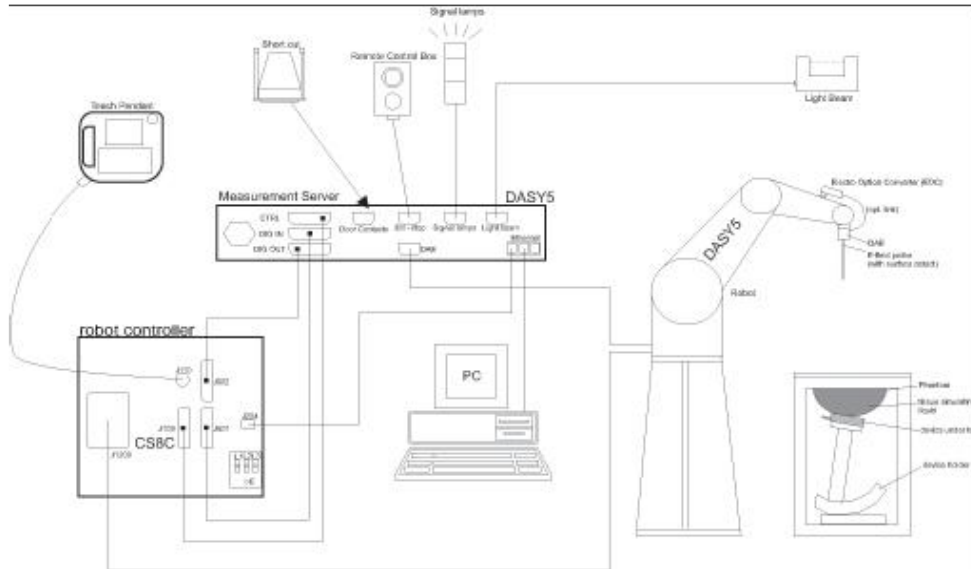

Picture C.1 SAR Lab Test Measurement Set-up

- A standard high precision 6-axis robot (StäubliTX=RX family) with controller, teach pendant and software. An arm extension for accommodating the data acquisition electronics (DAE).
- An isotropic field probe optimized and calibrated for the targeted measurement.
- A data acquisition electronics (DAE) which performs the signal amplification, signal multiplexing, AD-conversion, offset measurements, mechanical surface detection, collision detection, etc. The unit is battery powered with standard or rechargeable batteries. The signal is optically transmitted to the EOC.
- The Electro-optical converter (EOC) performs the conversion from optical to electrical signals for the digital communication to the DAE. To use optical surface detection, a special version of the EOC is required. The EOC signal is transmitted to the measurement server.
- The function of the measurement server is to perform the time critical tasks such as signal filtering, control of the robot operation and fast movement interrupts.
- The Light Beam used is for probe alignment. This improves the (absolute) accuracy of the probe positioning.
- A computer running WinXP and the DASY4 or DASY5 software.
- Remote control and teach pendant as well as additional circuitry for robot safety such as
- warning lamps, etc.
- The phantom, the device holder and other accessories according to the targeted measurement.

C.2 Dasy4 or DASY5 E-field Probe System

The SAR measurements were conducted with the dosimetric probe designed in the classical triangular configuration and optimized for dosimetric evaluation. The probe is constructed using the thick film technique; with printed resistive lines on ceramic substrates. The probe is equipped with an optical multifiber line ending at the front of the probe tip. It is connected to the EOC box on the robot arm and provides an automatic detection of the phantom surface. Half of the fibers are connected to a pulsed infrared transmitter, the other half to a synchronized receiver. As the probe approaches the surface, the reflection from the surface produces a coupling from the transmitting to the receiving fibers. This reflection increases first during the approach, reaches maximum and then decreases. If the probe is flatly touching the surface, the coupling is zero. The distance of the coupling maximum to the surface is independent of the surface reflectivity and largely independent of the surface to probe angle. The DASY4 or DASY5 software reads the reflection during a software approach and looks for the maximum using 2nd ord curve fitting. The approach is stopped at reaching the maximum.

Probe Specifications:

Model:	ES3DV3, EX3DV4
Frequency	10MHz — 6.0GHz(EX3DV4)
Range:	10MHz — 4GHz(ES3DV3)
Calibration:	In head and head simulating tissue at Frequencies from 835 up to 5800MHz
Linearity:	± 0.2 dB(30 MHz to 6 GHz) for EX3DV4 ± 0.2 dB(30 MHz to 4 GHz) for ES3DV3
DynamicRange:	10 mW/kg — 100W/kg
Probe Length:	330 mm
Probe Tip	
Length:	20 mm
Head Diameter:	12 mm
Tip Diameter:	2.5 mm (3.9 mm for ES3DV3)
Tip-Center:	1 mm (2.0mm for ES3DV3)
Application:	SAR Dosimetry Testing Compliance tests of mobile phones Dosimetry in strong gradient fields



Picture C.2Near-field Probe



Picture C.3E-field Probe

C.3 E-field Probe Calibration

Each E-Probe/Probe Amplifier combination has unique calibration parameters. A TEM cell calibration procedure is conducted to determine the proper amplifier settings to enter in the probe parameters. The amplifier settings are determined for a given frequency by subjecting the probe to a known E-field density (1 mW/cm²) using an RF Signal generator, TEM cell, and RF Power Meter.

The free space E-field from amplified probe outputs is determined in a test chamber. This calibration can be performed in a TEM cell if the frequency is below 1 GHz and inn a waveguide or

other methodologies above 1 GHz for free space. For the free space calibration, the probe is placed in the volumetric center of the cavity and at the proper orientation with the field. The probe is then rotated 360 degrees until the three channels show the maximum reading. The power density readings equates to 1 mW/cm².

E-field temperature correlation calibration is performed in a flat phantom filled with the appropriate simulated brain tissue. The E-field in the medium correlates with the temperature rise in the dielectric medium. For temperature correlation calibration a RF transparent thermistor-based temperature probe is used in conjunction with the E-field probe.

$$SAR = C \frac{\Delta T}{\Delta t}$$

Where:

Δt = Exposure time (30 seconds),

C = Heat capacity of tissue (brain or muscle),

ΔT = Temperature increase due to RF exposure.

$$SAR = \frac{|E|^2 \cdot \sigma}{\rho}$$

Where:

σ = Simulated tissue conductivity,

ρ = Tissue density (kg/m³).

C.4 Other Test Equipment

C.4.1 Data Acquisition Electronics(DAE)

The data acquisition electronics consist of a highly sensitive electrometer-grade preamplifier with auto-zeroing, a channel and gain-switching multiplexer, a fast 16 bit AD-converter and a command decoder with a control logic unit. Transmission to the measurement server is accomplished through an optical downlink for data and status information, as well as an optical uplink for commands and the clock.

The mechanical probe mounting device includes two different sensor systems for frontal and sideways probe contacts. They are used for mechanical surface detection and probe collision detection.

The input impedance of the DAE is 200 MOhm; the inputs are symmetrical and floating. Common mode rejection is above 80 dB.



PictureC.4: DAE

C.4.2 Robot

The SPEAG DASY system uses the high precision robots (DASY4: RX90XL; DASY5: RX160L) type from Stäubli SA (France). For the 6-axis controller system, the robot controller version from Stäubli is used. The Stäubli robot series have many features that are important for our application:

- High precision (repeatability 0.02mm)
- High reliability (industrial design)
- Low maintenance costs (virtually maintenance free due to direct drive gears; no belt drives)
- Jerk-free straight movements (brushless synchron motors; no stepper motors)
- Low ELF interference (motor control fields shielded via the closed metallic construction shields)



Picture C.5 DASY 4



Picture C.6 DASY 5

C.4.3 Measurement Server

The Measurement server is based on a PC/104 CPU board with CPU (dasy4: 166 MHz, Intel Pentium; DASY5: 400 MHz, Intel Celeron), chipdisk (DASY4: 32 MB; DASY5: 128MB), RAM (DASY4: 64 MB, DASY5: 128MB). The necessary circuits for communication with the DAE electronic box, as well as the 16 bit AD converter system for optical detection and digital I/O interface are contained on the DASY I/O board, which is directly connected to the PC/104 bus of the CPU board.

The measurement server performs all real-time data evaluation of field measurements and surface detection, controls robot movements and handles safety operation. The PC operating system cannot interfere with these time critical processes. All connections are supervised by a watchdog, and disconnection of any of the cables to the measurement server will automatically disarm the robot and disable all program-controlled robot movements. Furthermore, the measurement server is equipped with an expansion port which is reserved for future applications. Please note that this expansion port does not have a standardized pinout, and therefore only devices provided by SPEAG can be connected. Devices from any other supplier could seriously damage the measurement server.



Picture C.7 Server for DASY 4



Picture C.8 Server for DASY 5

C.4.4 Device Holder for Phantom

The SAR in the phantom is approximately inversely proportional to the square of the distance between the source and the liquid surface. For a source at 5mm distance, a positioning uncertainty of $\pm 0.5\text{mm}$ would produce a SAR uncertainty of $\pm 20\%$. Accurate device positioning is therefore crucial for accurate and repeatable measurements. The positions in which the devices must be measured are defined by the standards.

The DASY device holder is designed to cope with the different positions given in the standard. It has two scales for device rotation (with respect to the head axis) and device inclination (with respect to the line between the ear reference points). The rotation centers for both scales are the ear reference point (ERP). Thus the device needs no repositioning when changing the angles.

The DASY device holder is constructed of low-loss POM material having the following dielectric parameters: relative permittivity $\epsilon = 3$ and loss tangent $\delta = 0.02$. The amount of dielectric material has been reduced in the closest vicinity of the device, since measurements have suggested that the influence of the clamp on the test results could thus be lowered.

<Laptop Extension Kit>

The extension is lightweight and made of POM, acrylic glass and foam. It fits easily on the upper part of the Mounting Device in place of the phone positioner. The extension is fully compatible with the Twin-SAM and ELI phantoms.



Picture C.9-1: Device Holder

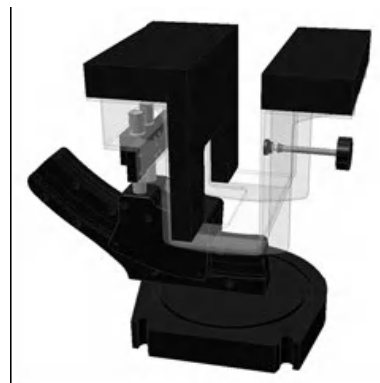

Picture C.9-2: Laptop Extension Kit

C.4.5 Phantom

The SAM Twin Phantom V4.0 is constructed of a fiberglass shell integrated in a table. The shape of the shell is based on data from an anatomical study designed to represent the 90th percentile of the population. The phantom enables the dissymmetric evaluation of SAR for both left and right handed handset usage, as well as head-worn usage using the flat phantom region. Reference markings on the Phantom allow the complete setup of all predefined phantom positions and measurement grids by manually teaching three points in the robot. The shell phantom has a 2mm shell thickness (except the ear region where shell thickness increases to 6 mm).

Shell Thickness: 2 ± 0.2 mm

Filling Volume: Approx. 25 liters

Dimensions: 810 x 1000 x 500 mm (H x L x W)

Available: Special



Picture C.10: SAM Twin Phantom

ANNEX D Position of the wireless device in relation to the phantom

D.1 General considerations

This standard specifies two handset test positions against the head phantom – the “cheek” position and the “tilt” position.

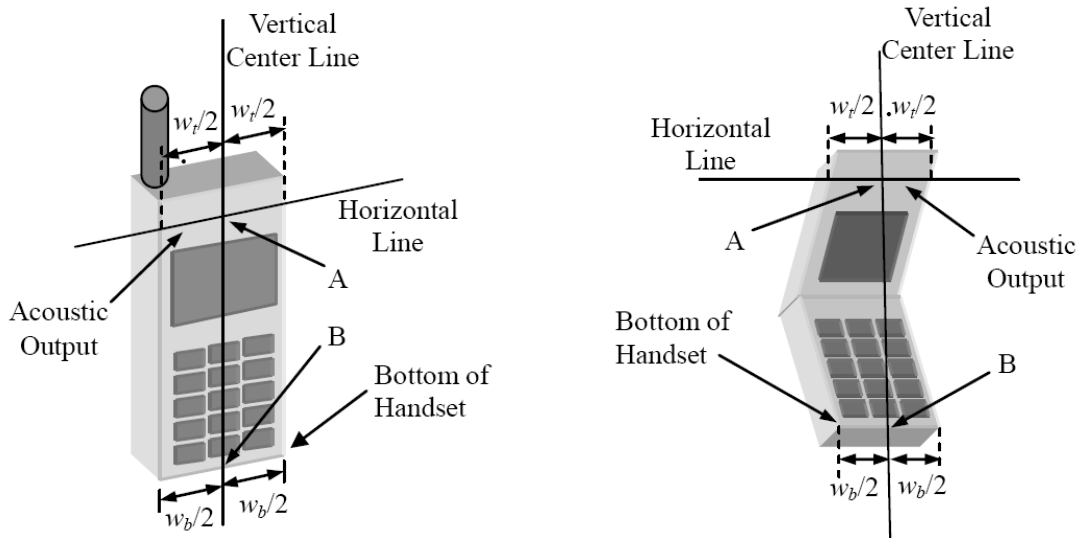

- w_t Width of the handset at the level of the acoustic
- w_b Width of the bottom of the handset
- A Midpoint of the width w_t of the handset at the level of the acoustic output
- B Midpoint of the width w_b of the bottom of the handset

Picture D.1-a Typical “fixed” case handset Picture D.1-b Typical “clam-shell” case handset

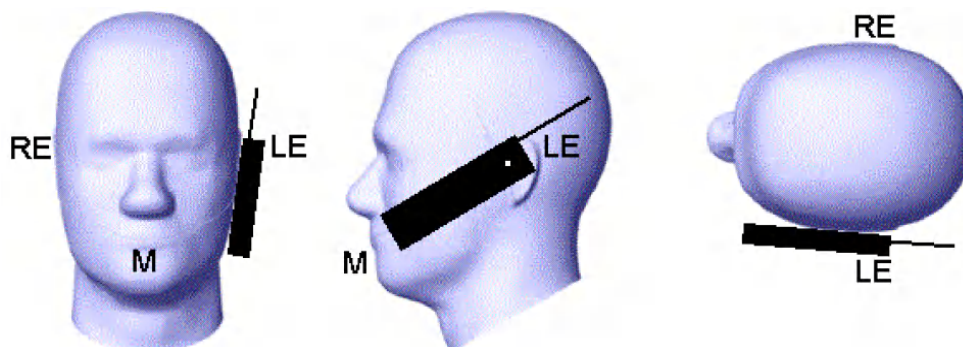

Picture D.2 Cheek position of the wireless device on the left side of SAM

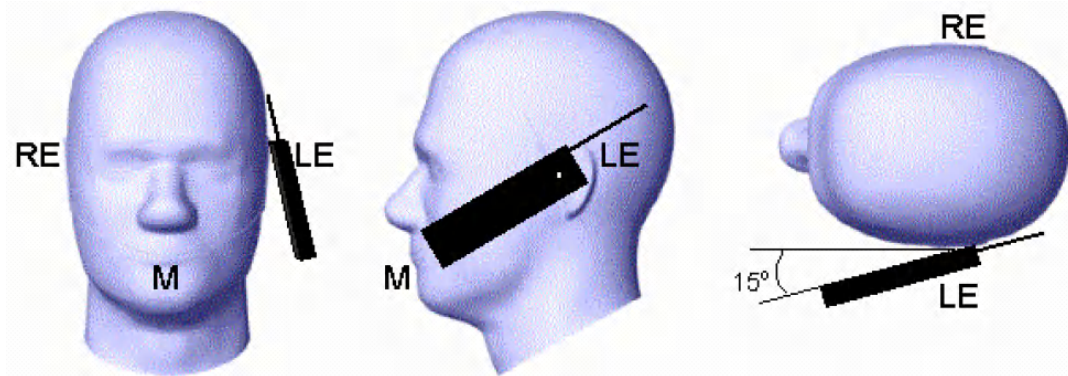

Picture D.3 Tilt position of the wireless device on the left side of SAM

D.2 Head-worn device

A typical example of a head-worn device is a mobile phone, wireless enabled PDA or other battery operated wireless device with the ability to transmit while mounted on a person's head using a carry accessory approved by the wireless device manufacturer.

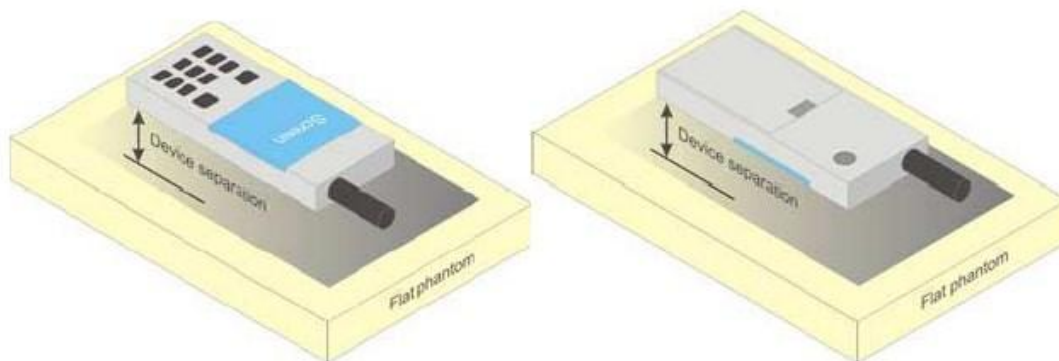

Picture D.4 Test positions for head-worn devices

D.3 Desktop device

A typical example of a desktop device is a wireless enabled desktop computer placed on a table or desk when used.

The DUT shall be positioned at the distance and in the orientation to the phantom that corresponds to the intended use as specified by the manufacturer in the user instructions. For devices that employ an external antenna with variable positions, tests shall be performed for all antenna positions specified. Picture 8.5 show positions for desktop device SAR tests. If the intended use is not specified, the device shall be tested directly against the flat phantom.

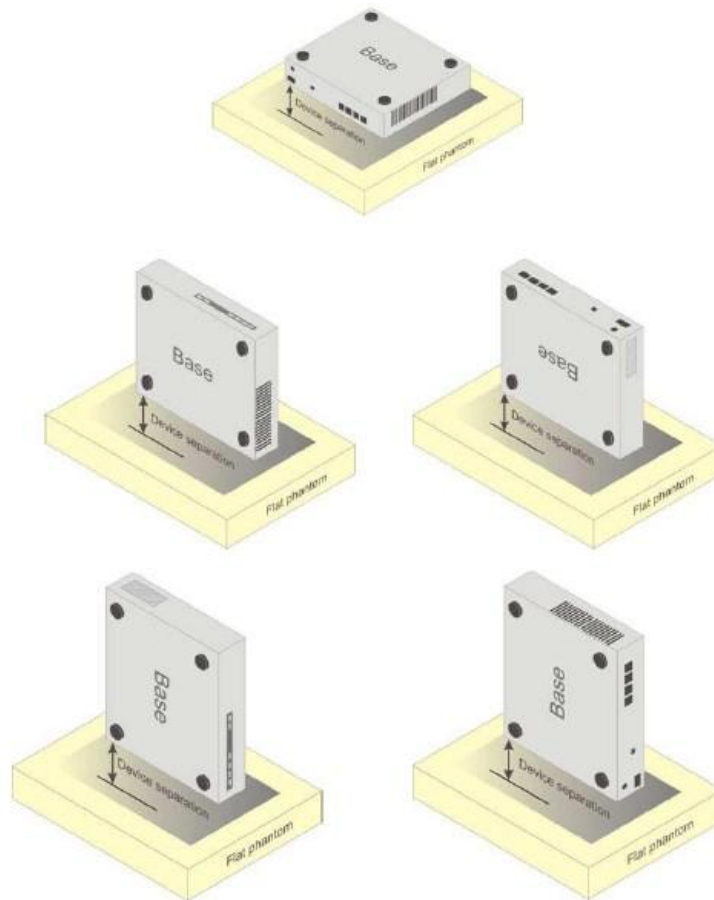

Picture D.5 Test positions for desktop devices

D.4 DUT Setup Photos



Picture D.6

ANNEX E Equivalent Media Recipes

The liquid used for the frequency range of 800-3000 MHz consisted of water, sugar, salt, preventol, glycol monobutyl and Cellulose. The liquid has been previously proven to be suited for worst-case. The Table E.1 shows the detail solution. It's satisfying the latest tissue dielectric parameters requirements proposed by the IEEE 1528 and IEC 62209.

TableE.1: Composition of the Tissue Equivalent Matter

Frequency (MHz)	835Head	835Head	1900 Head	1900 Head	2450 Head	2450 Head	5800 Head	5800 Head
Ingredients (% by weight)								
Water	41.45	52.5	55.242	69.91	58.79	72.60	65.53	65.53
Sugar	56.0	45.0	\	\	\	\	\	\
Salt	1.45	1.4	0.306	0.13	0.06	0.18	\	\
Preventol	0.1	0.1	\	\	\	\	\	\
Cellulose	1.0	1.0	\	\	\	\	\	\
Glycol Monobutyl	\	\	44.452	29.96	41.15	27.22	\	\
Diethylenglycol monohexylether	\	\	\	\	\	\	17.24	17.24
Triton X-100	\	\	\	\	\	\	17.24	17.24
Dielectric Parameters Target Value	$\epsilon=41.5$ $\sigma=0.90$	$\epsilon=55.2$ $\sigma=0.97$	$\epsilon=40.0$ $\sigma=1.40$	$\epsilon=53.3$ $\sigma=1.52$	$\epsilon=39.2$ $\sigma=1.80$	$\epsilon=52.7$ $\sigma=1.95$	$\epsilon=35.3$ $\sigma=5.27$	$\epsilon=48.2$ $\sigma=6.00$

Note: There are a little adjustment respectively for 750, 1750, 2600, 5200, 5300 and 5600 based on the recipe of closest frequency in table E.1.

ANNEX F System Validation

The SAR system must be validated against its performance specifications before it is deployed. When SAR probes, system components or software are changed, upgraded or recalibrated, these must be validated with the SAR system(s) that operates with such components.

Table F.1: System Validation for 3846

Probe SN.	Liquid name	Validation date	Frequency point	Status (OK or Not)
3846	Head 750MHz	July.10,2023	750 MHz	OK
3846	Head 900MHz	July.10,2023	900 MHz	OK
3846	Head 1450MHz	July.14,2023	1450 MHz	OK
3846	Head 1750MHz	July.14,2023	1750 MHz	OK
3846	Head 1810MHz	July.14,2023	1810 MHz	OK
3846	Head 1900MHz	July.15,2023	1900 MHz	OK
3846	Head 2000MHz	July.15,2023	2000 MHz	OK
3846	Head 2300MHz	July.15,2023	2300 MHz	OK
3846	Head 2450MHz	July.16,2023	2450 MHz	OK
3846	Head 2600MHz	July.16,2023	2600 MHz	OK
3846	Head 3300MHz	July.16,2023	3300 MHz	OK
3846	Head 3500MHz	July.17,2023	3500 MHz	OK
3846	Head 3700MHz	July.17,2023	3700 MHz	OK
3846	Head 4200MHz	July.17,2023	4200 MHz	OK
3846	Head 5250MHz	July.17,2023	5250 MHz	OK
3846	Head 5600MHz	July.18,2023	5600 MHz	OK
3846	Head 5750MHz	July.18,2023	5750 MHz	OK

ANNEX G Probe Calibration Certificate

Probe 3846 Calibration Certificate

Calibration Laboratory of
 Schmid & Partner
 Engineering AG
 Zeughausstrasse 43, 8004 Zurich, Switzerland



S Schweizerischer Kalibrierdienst
C Service suisse d'étalonnage
S Servizio svizzero di taratura
S Swiss Calibration Service

Accredited by the Swiss Accreditation Service (SAS)
 The Swiss Accreditation Service is one of the signatories to the EA
 Multilateral Agreement for the recognition of calibration certificates

Accreditation No.: **SCS 0108**

Client

CTTL
 Beijing

Certificate No.

EX-3846_May23

CALIBRATION CERTIFICATE

Object **EX3DV4 - SN:3846**

 Calibration procedure(s) **QA CAL-01.v10, QA CAL-12.v10, QA CAL-14.v7, QA CAL-23.v6,
 QA CAL-25.v8
 Calibration procedure for dosimetric E-field probes**

 Calibration date **May 31, 2023**

This calibration certificate documents the traceability to national standards, which realize the physical units of measurements (SI).
 The measurements and the uncertainties with confidence probability are given on the following pages and are part of the certificate.
 All calibrations have been conducted in the closed laboratory facility: environment temperature (22 ± 3) °C and humidity < 70%.
 Calibration Equipment used (M&TE critical for calibration)

Primary Standards	ID	Cal Date (Certificate No.)	Scheduled Calibration
Power meter NRP2	SN: 104778	30-Mar-23 (No. 217-03804/03805)	Mar-24
Power sensor NRP-Z91	SN: 103244	30-Mar-23 (No. 217-03804)	Mar-24
OCP DAK-3.5 (weighted)	SN: 1249	20-Oct-22 (OCP-DAK3.5-1249_Oct22)	Oct-23
OCP DAK-12	SN: 1016	20-Oct-22 (OCP-DAK12-1016_Oct22)	Oct-23
Reference 20 dB Attenuator	SN: CC2552 (20x)	30-Mar-23 (No. 217-03809)	Mar-24
DAE4	SN: 660	16-Mar-23 (No. DAE4-660_Mar23)	Mar-24
Reference Probe ES3DV2	SN: 3013	06-Jan-23 (No. ES3-3013_Jan23)	Jan-24

Secondary Standards	ID	Check Date (in house)	Scheduled Check
Power meter E4419B	SN: GB41293874	06-Apr-16 (in house check Jun-22)	In house check: Jun-24
Power sensor E4412A	SN: MY41498087	06-Apr-16 (in house check Jun-22)	In house check: Jun-24
Power sensor E4412A	SN: 000110210	06-Apr-16 (in house check Jun-22)	In house check: Jun-24
RF generator HP 8648C	SN: US3642U01700	04-Aug-99 (in house check Jun-22)	In house check: Jun-24
Network Analyzer E8358A	SN: US41080477	31-Mar-14 (in house check Oct-22)	In house check: Oct-24

	Name	Function	Signature
Calibrated by	Aidonia Georgiadou	Laboratory Technician	
Approved by	Sven Kühn	Technical Manager	

Issued: June 02, 2023

This calibration certificate shall not be reproduced except in full without written approval of the laboratory.

**Calibration Laboratory of
Schmid & Partner
Engineering AG**

Zeughausstrasse 43, 8004 Zurich, Switzerland

**S** Schweizerischer Kalibrierdienst
C Service suisse d'étalonnage
S Servizio svizzero di taratura
S Swiss Calibration ServiceAccredited by the Swiss Accreditation Service (SAS)
**The Swiss Accreditation Service is one of the signatories to the EA
Multilateral Agreement for the recognition of calibration certificates**Accreditation No.: **SCS 0108****Glossary**

TSL	tissue simulating liquid
NORM _{x,y,z}	sensitivity in free space
ConvF	sensitivity in TSL / NORM _{x,y,z}
DCP	diode compression point
CF	crest factor (1/duty_cycle) of the RF signal
A, B, C, D	modulation dependent linearization parameters
Polarization φ	φ rotation around probe axis
Polarization θ	θ rotation around an axis that is in the plane normal to probe axis (at measurement center), i.e., $\theta = 0$ is normal to probe axis
Connector Angle	information used in DASY system to align probe sensor X to the robot coordinate system

Calibration is Performed According to the Following Standards:

- IEC/IEEE 62209-1528, "Measurement Procedure For The Assessment Of Specific Absorption Rate Of Human Exposure To Radio Frequency Fields From Hand-Held And Body-Worn Wireless Communication Devices – Part 1528: Human Models, Instrumentation And Procedures (Frequency Range of 4 MHz to 10 GHz)", October 2020.
- KDB 865664, "SAR Measurement Requirements for 100 MHz to 6 GHz"

Methods Applied and Interpretation of Parameters:

- NORM_{x,y,z}**: Assessed for E-field polarization $\theta = 0$ ($f \leq 900$ MHz in TEM-cell; $f > 1800$ MHz: R22 waveguide). NORM_{x,y,z} are only intermediate values, i.e., the uncertainties of NORM_{x,y,z} does not affect the E²-field uncertainty inside TSL (see below ConvF).
- NORM(f)_{x,y,z} = NORM_{x,y,z} * frequency_response** (see Frequency Response Chart). This linearization is implemented in DASY4 software versions later than 4.2. The uncertainty of the frequency response is included in the stated uncertainty of ConvF.
- DCP_{x,y,z}**: DCP are numerical linearization parameters assessed based on the data of power sweep with CW signal. DCP does not depend on frequency nor media.
- PAR**: PAR is the Peak to Average Ratio that is not calibrated but determined based on the signal characteristics
- A_{x,y,z}; B_{x,y,z}; C_{x,y,z}; D_{x,y,z}; VR_{x,y,z}**: A, B, C, D are numerical linearization parameters assessed based on the data of power sweep for specific modulation signal. The parameters do not depend on frequency nor media. VR is the maximum calibration range expressed in RMS voltage across the diode.
- ConvF and Boundary Effect Parameters**: Assessed in flat phantom using E-field (or Temperature Transfer Standard for $f \leq 800$ MHz) and inside waveguide using analytical field distributions based on power measurements for $f > 800$ MHz. The same setups are used for assessment of the parameters applied for boundary compensation (alpha, depth) of which typical uncertainty values are given. These parameters are used in DASY4 software to improve probe accuracy close to the boundary. The sensitivity in TSL corresponds to NORM_{x,y,z} * ConvF whereby the uncertainty corresponds to that given for ConvF. A frequency dependent ConvF is used in DASY version 4.4 and higher which allows extending the validity from ± 50 MHz to ± 100 MHz.
- Spherical isotropy (3D deviation from isotropy)**: in a field of low gradients realized using a flat phantom exposed by a patch antenna.
- Sensor Offset**: The sensor offset corresponds to the offset of virtual measurement center from the probe tip (on probe axis). No tolerance required.
- Connector Angle**: The angle is assessed using the information gained by determining the NORM_x (no uncertainty required).

EX3DV4 - SN:3846

May 31, 2023

Parameters of Probe: EX3DV4 - SN:3846
Basic Calibration Parameters

	Sensor X	Sensor Y	Sensor Z	Unc (k = 2)
Norm ($\mu\text{V}/(\text{V}/\text{m})^2$) ^A	0.39	0.47	0.48	$\pm 10.1\%$
DCP (mV) ^B	101.0	101.5	101.5	$\pm 4.7\%$

Calibration Results for Modulation Response

UID	Communication System Name		A dB	B dB $\sqrt{\mu\text{V}}$	C	D dB	VR mV	Max dev.	Max Unc ^E k = 2
0	CW	X	0.00	0.00	1.00	0.00	140.1	$\pm 1.8\%$	$\pm 4.7\%$
		Y	0.00	0.00	1.00		148.9		
		Z	0.00	0.00	1.00		126.6		
10352	Pulse Waveform (200Hz, 10%)	X	20.00	89.81	20.09	10.00	60.0	$\pm 2.8\%$	$\pm 9.6\%$
		Y	20.00	90.89	21.02		60.0		
		Z	20.00	89.26	19.67		60.0		
10353	Pulse Waveform (200Hz, 20%)	X	20.00	91.30	19.76	6.99	80.0	$\pm 1.5\%$	$\pm 9.6\%$
		Y	20.00	90.93	19.73		80.0		
		Z	20.00	91.12	19.59		80.0		
10354	Pulse Waveform (200Hz, 40%)	X	20.00	95.59	20.50	3.98	95.0	$\pm 1.2\%$	$\pm 9.6\%$
		Y	20.00	91.21	18.30		95.0		
		Z	20.00	92.86	19.14		95.0		
10355	Pulse Waveform (200Hz, 60%)	X	20.00	101.33	21.82	2.22	120.0	$\pm 1.2\%$	$\pm 9.6\%$
		Y	20.00	90.19	16.42		120.0		
		Z	20.00	96.09	19.41		120.0		
10387	QPSK Waveform, 1 MHz	X	1.73	65.72	15.13	1.00	150.0	$\pm 2.3\%$	$\pm 9.6\%$
		Y	1.74	65.85	15.06		150.0		
		Z	1.80	66.67	15.50		150.0		
10388	QPSK Waveform, 10 MHz	X	2.32	68.34	15.86	0.00	150.0	$\pm 0.9\%$	$\pm 9.6\%$
		Y	2.35	68.57	15.78		150.0		
		Z	2.45	69.32	16.27		150.0		
10396	64-QAM Waveform, 100 kHz	X	3.42	72.59	19.56	3.01	150.0	$\pm 0.7\%$	$\pm 9.6\%$
		Y	3.37	71.20	18.88		150.0		
		Z	4.04	76.02	21.06		150.0		
10399	64-QAM Waveform, 40 MHz	X	3.54	67.15	15.81	0.00	150.0	$\pm 2.2\%$	$\pm 9.6\%$
		Y	3.59	67.40	15.85		150.0		
		Z	3.50	67.10	15.77		150.0		
10414	WLAN CCDF, 64-QAM, 40 MHz	X	4.93	65.48	15.46	0.00	150.0	$\pm 3.9\%$	$\pm 9.6\%$
		Y	5.04	65.88	15.64		150.0		
		Z	4.86	65.40	15.41		150.0		

Note: For details on UID parameters see Appendix

The reported uncertainty of measurement is stated as the standard uncertainty of measurement multiplied by the coverage factor k=2, which for a normal distribution corresponds to a coverage probability of approximately 95%.

^A The uncertainties of Norm X,Y,Z do not affect the E²-field uncertainty inside TSL (see Pages 5 to 7).

^B Linearization parameter uncertainty for maximum specified field strength.

^E Uncertainty is determined using the max. deviation from linear response applying rectangular distribution and is expressed for the square of the field value.



EX3DV4 - SN:3846

May 31, 2023

Parameters of Probe: EX3DV4 - SN:3846**Sensor Model Parameters**

	C1 fF	C2 fF	α V ⁻¹	T1 ms V ⁻²	T2 ms V ⁻¹	T3 ms	T4 V ⁻²	T5 V ⁻¹	T6
x	58.2	434.80	35.66	16.47	0.12	5.08	1.72	0.27	1.01
y	60.8	458.93	36.20	14.64	0.63	5.08	0.25	0.63	1.01
z	55.2	411.11	35.41	17.17	0.00	5.09	1.93	0.20	1.01

Other Probe Parameters

Sensor Arrangement	Triangular
Connector Angle	17.8°
Mechanical Surface Detection Mode	enabled
Optical Surface Detection Mode	disabled
Probe Overall Length	337 mm
Probe Body Diameter	10 mm
Tip Length	9 mm
Tip Diameter	2.5 mm
Probe Tip to Sensor X Calibration Point	1 mm
Probe Tip to Sensor Y Calibration Point	1 mm
Probe Tip to Sensor Z Calibration Point	1 mm
Recommended Measurement Distance from Surface	1.4 mm

Note: Measurement distance from surface can be increased to 3–4 mm for an *Area Scan* job.

EX3DV4 - SN:3846

May 31, 2023

Parameters of Probe: EX3DV4 - SN:3846
Calibration Parameter Determined in Head Tissue Simulating Media

f (MHz) ^C	Relative Permittivity ^F	Conductivity ^F (S/m)	ConvF X	ConvF Y	ConvF Z	Alpha ^G	Depth ^G (mm)	Unc (k = 2)
13	55.0	0.75	17.76	17.76	17.76	0.00	1.25	±13.3%
64	54.2	0.75	13.68	13.68	13.68	0.00	1.25	±13.3%
150	52.3	0.76	12.35	12.35	12.35	0.00	1.25	±13.3%
300	45.3	0.87	11.38	11.38	11.38	0.09	1.00	±13.3%
450	43.5	0.87	10.64	10.64	10.64	0.16	1.30	±13.3%
750	41.9	0.89	8.98	8.99	10.08	0.43	1.27	±12.0%
835	41.5	0.90	8.50	9.01	9.47	0.43	1.27	±12.0%
900	41.5	0.97	7.98	8.23	9.62	0.42	1.27	±12.0%
1450	40.5	1.20	7.49	7.73	8.40	0.53	1.27	±12.0%
1640	40.2	1.31	7.40	7.67	8.37	0.49	1.27	±12.0%
1750	40.1	1.37	7.47	7.79	8.45	0.31	1.27	±12.0%
1810	40.0	1.40	7.37	7.68	8.24	0.33	1.27	±12.0%
1900	40.0	1.40	7.27	7.55	8.11	0.33	1.27	±12.0%
2000	40.0	1.40	7.02	7.30	7.84	0.33	1.27	±12.0%
2100	39.8	1.49	6.97	7.28	7.79	0.33	1.27	±12.0%
2300	39.5	1.67	6.90	7.19	7.69	0.34	1.27	±12.0%
2450	39.2	1.80	6.80	7.06	7.55	0.34	1.27	±12.0%
2600	39.0	1.96	6.72	7.04	7.50	0.32	1.27	±12.0%
3300	38.2	2.71	6.48	6.85	7.25	0.38	1.27	±14.0%
3500	37.9	2.91	6.50	6.78	7.20	0.37	1.27	±14.0%
3700	37.7	3.12	6.38	6.68	7.11	0.37	1.27	±14.0%
3900	37.5	3.32	6.36	6.63	7.02	0.38	1.27	±14.0%
4100	37.2	3.53	6.31	6.59	6.98	0.38	1.27	±14.0%
4200	37.1	3.63	6.29	6.57	6.96	0.38	1.27	±14.0%
4400	36.9	3.84	6.22	6.52	6.88	0.41	1.27	±14.0%
4600	36.7	4.04	6.15	6.44	6.82	0.41	1.27	±14.0%
4800	36.4	4.25	6.11	6.41	6.76	0.41	1.27	±14.0%
4950	36.3	4.40	5.95	6.21	6.41	0.42	1.36	±14.0%

^C Frequency validity above 300 MHz of ±100 MHz only applies for DASY v4.4 and higher (see Page 2), else it is restricted to ±50 MHz. The uncertainty is the RSS of the ConvF uncertainty at calibration frequency and the uncertainty for the indicated frequency band. Frequency validity below 300 MHz is ±10, 25, 40, 50 and 70 MHz for ConvF assessments at 30, 64, 128, 150 and 220 MHz respectively. Validity of ConvF assessed at 6 MHz is 4–9 MHz, and ConvF assessed at 13 MHz is 9–19 MHz. Above 5 GHz frequency validity can be extended to ±110 MHz.

^F The probes are calibrated using tissue simulating liquids (TSL) that deviate for ϵ and σ by less than ±5% from the target values (typically better than ±3%) and are valid for TSL with deviations of up to ±10%. If TSL with deviations from the target of less than ±5% are used, the calibration uncertainties are 11.1% for 0.7 - 3 GHz and 13.1% for 3 - 6 GHz.

^G Alpha/Depth are determined during calibration. SPEAG warrants that the remaining deviation due to the boundary effect after compensation is always less than ±1% for frequencies below 3 GHz and below ±2% for frequencies between 3–6 GHz at any distance larger than half the probe tip diameter from the boundary.

EX3DV4 - SN:3846

May 31, 2023

Parameters of Probe: EX3DV4 - SN:3846
Calibration Parameter Determined in Head Tissue Simulating Media

f (MHz) ^C	Relative Permittivity ^F	Conductivity ^F (S/m)	ConvF X	ConvF Y	ConvF Z	Alpha ^G	Depth ^G (mm)	Unc (k = 2)
5200	36.0	4.66	5.20	5.41	5.66	0.40	1.51	±14.0%
5250	35.9	4.71	5.05	5.27	5.51	0.42	1.53	±14.0%
5300	35.9	4.76	4.98	5.21	5.33	0.41	1.55	±14.0%
5500	35.6	4.96	4.44	4.64	4.90	0.40	1.70	±14.0%
5600	35.5	5.07	4.27	4.47	4.70	0.39	1.75	±14.0%
5750	35.4	5.22	4.54	4.76	4.98	0.41	1.75	±14.0%
5800	35.3	5.27	4.45	4.64	4.88	0.40	1.78	±14.0%

^C Frequency validity above 300 MHz of ±100 MHz only applies for DASY v4.4 and higher (see Page 2), else it is restricted to ±50 MHz. The uncertainty is the RSS of the ConvF uncertainty at calibration frequency and the uncertainty for the indicated frequency band. Frequency validity below 300 MHz is ±10, 25, 40, 50 and 70 MHz for ConvF assessments at 30, 64, 128, 150 and 220 MHz respectively. Validity of ConvF assessed at 6 MHz is 4–9 MHz, and ConvF assessed at 13 MHz is 9–19 MHz. Above 5 GHz frequency validity can be extended to ±110 MHz.

^F The probes are calibrated using tissue simulating liquids (TSL) that deviate for ϵ and σ by less than ±5% from the target values (typically better than ±3%) and are valid for TSL with deviations of up to ±10%. If TSL with deviations from the target of less than ±5% are used, the calibration uncertainties are 11.1% for 0.7 - 3 GHz and 13.1% for 3 - 6 GHz.

^G Alpha/Depth are determined during calibration. SPEAG warrants that the remaining deviation due to the boundary effect after compensation is always less than ±1% for frequencies below 3 GHz and below ±2% for frequencies between 3–6 GHz at any distance larger than half the probe tip diameter from the boundary.



EX3DV4 - SN:3846

May 31, 2023

Parameters of Probe: EX3DV4 - SN:3846**Calibration Parameter Determined in Head Tissue Simulating Media**

f (MHz) ^C	Relative Permittivity ^F	Conductivity ^F (S/m)	ConvF X	ConvF Y	ConvF Z	Alpha ^G	Depth ^G (mm)	Unc (k = 2)
6500	34.5	6.07	5.15	5.59	5.71	0.20	2.00	±18.6%
7000	33.9	6.65	5.39	5.83	5.88	0.20	2.00	±18.6%

^C Frequency validity at 6.5 GHz is -600/+700 MHz, and ±700 MHz at or above 7 GHz. The uncertainty is the RSS of the ConvF uncertainty at calibration frequency and the uncertainty for the indicated frequency band.

^F The probes are calibrated using tissue simulating liquids (TSL) that deviate for ϵ and σ by less than ±10% from the target values (typically better than ±6%) and are valid for TSL with deviations of up to ±10%.

^G Alpha/Depth are determined during calibration. SPEAG warrants that the remaining deviation due to the boundary effect after compensation is always less than ±1% for frequencies below 3 GHz; below ±2% for frequencies between 3–6 GHz; and below ±4% for frequencies between 6–10 GHz at any distance larger than half the probe tip diameter from the boundary.

Frequency Response of E-Field

(TEM-Cell:ifi110 EXX, Waveguide:R22)

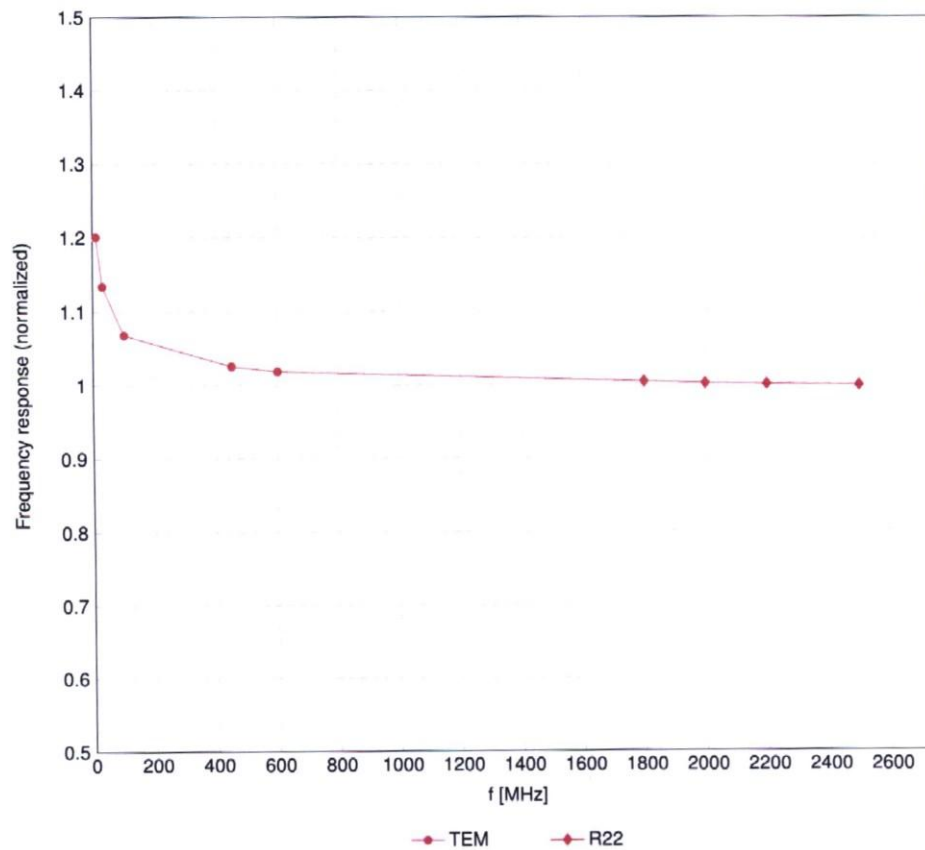

Uncertainty of Frequency Response of E-field: $\pm 6.3\%$ ($k=2$)

EX3DV4 - SN:3846

May 31, 2023

Receiving Pattern (ϕ), $\theta = 0^\circ$

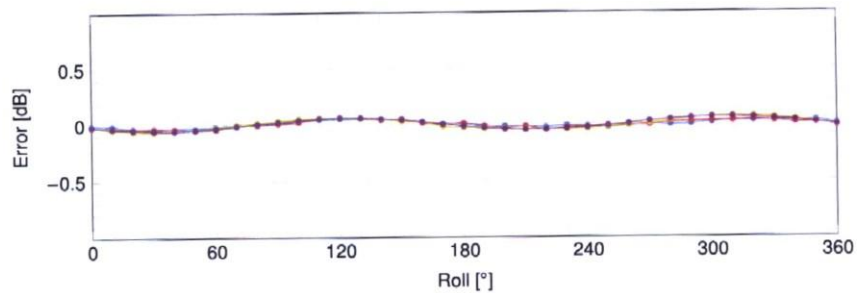
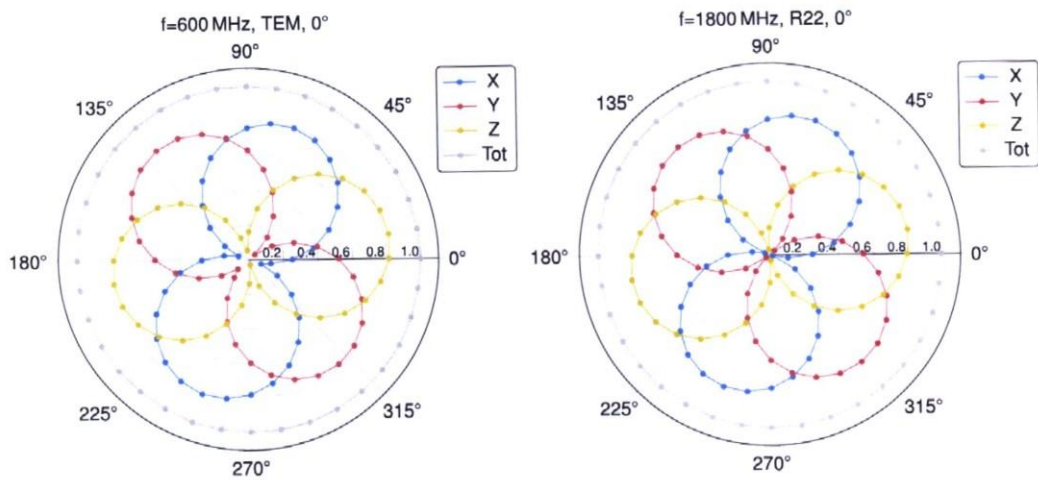

Uncertainty of Axial Isotropy Assessment: $\pm 0.5\%$ ($k=2$)

EX3DV4 - SN:3846

May 31, 2023

Dynamic Range f(SAR_{head})

(TEM cell, f_{eval} = 1900MHz)

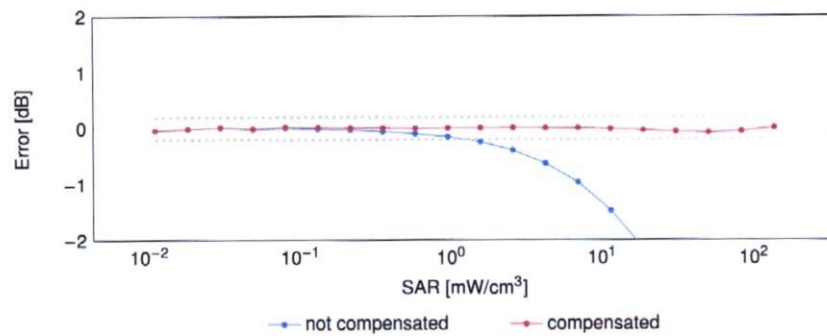
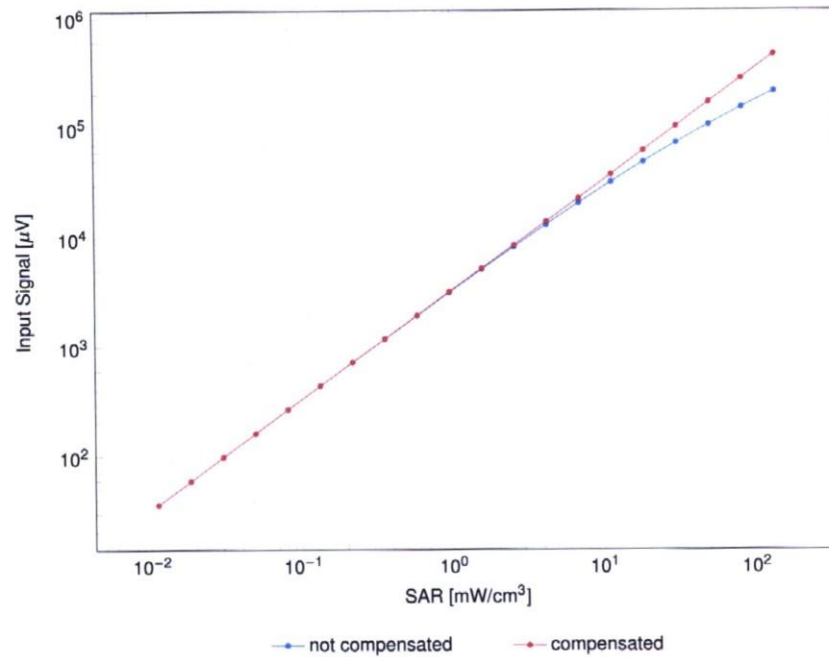

Uncertainty of Linearity Assessment: ±0.6% (k=2)

EX3DV4 - SN:3846

May 31, 2023

Conversion Factor Assessment

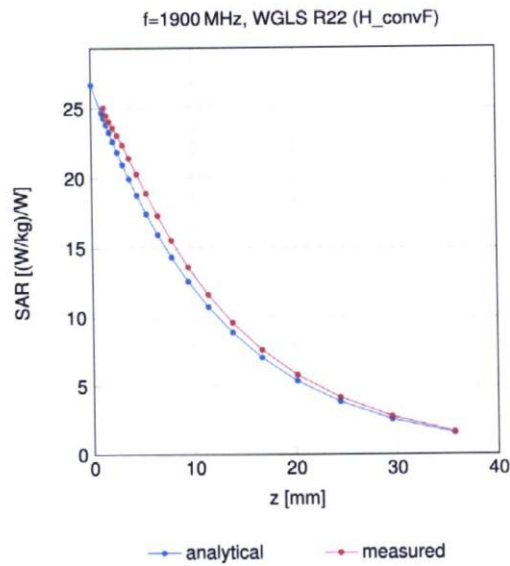

Deviation from Isotropy in Liquid

Error (ϕ, θ), f = 900 MHz

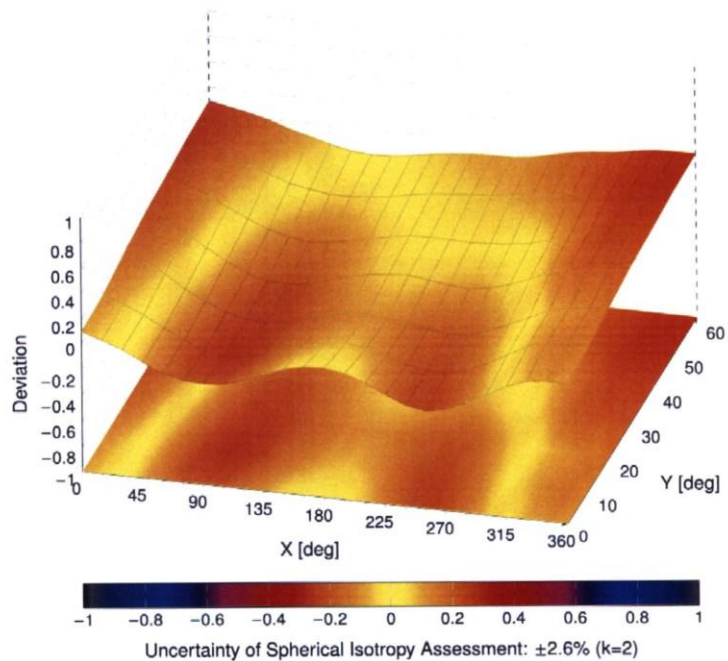



EX3DV4 - SN:3846

May 31, 2023

Appendix: Modulation Calibration Parameters

UID	Rev	Communication System Name	Group	PAR (dB)	Unc ^E k = 2
0		CW	CW	0.00	±4.7
10010	CAB	SAR Validation (Square, 100 ms, 10 ms)	Test	10.00	±9.6
10011	CAC	UMTS-FDD (WCDMA)	WCDMA	2.91	±9.6
10012	CAB	IEEE 802.11b WiFi 2.4 GHz (DSSS, 1 Mbps)	WLAN	1.87	±9.6
10013	CAB	IEEE 802.11g WiFi 2.4 GHz (DSSS-OFDM, 6 Mbps)	WLAN	9.46	±9.6
10021	DAC	GSM-FDD (TDMA, GMSK)	GSM	9.39	±9.6
10023	DAC	GPRS-FDD (TDMA, GMSK, TN 0)	GSM	9.57	±9.6
10024	DAC	GPRS-FDD (TDMA, GMSK, TN 0-1)	GSM	6.56	±9.6
10025	DAC	EDGE-FDD (TDMA, 8PSK, TN 0)	GSM	12.62	±9.6
10026	DAC	EDGE-FDD (TDMA, 8PSK, TN 0-1)	GSM	9.55	±9.6
10027	DAC	GPRS-FDD (TDMA, GMSK, TN 0-1-2)	GSM	4.80	±9.6
10028	DAC	GPRS-FDD (TDMA, GMSK, TN 0-1-2-3)	GSM	3.55	±9.6
10029	DAC	EDGE-FDD (TDMA, 8PSK, TN 0-1-2)	GSM	7.78	±9.6
10030	CAA	IEEE 802.15.1 Bluetooth (GFSK, DH1)	Bluetooth	5.30	±9.6
10031	CAA	IEEE 802.15.1 Bluetooth (GFSK, DH3)	Bluetooth	1.87	±9.6
10032	CAA	IEEE 802.15.1 Bluetooth (GFSK, DH5)	Bluetooth	1.16	±9.6
10033	CAA	IEEE 802.15.1 Bluetooth (PI/4-DQPSK, DH1)	Bluetooth	7.74	±9.6
10034	CAA	IEEE 802.15.1 Bluetooth (PI/4-DQPSK, DH3)	Bluetooth	4.53	±9.6
10035	CAA	IEEE 802.15.1 Bluetooth (PI/4-DQPSK, DH5)	Bluetooth	3.83	±9.6
10036	CAA	IEEE 802.15.1 Bluetooth (8-DPSK, DH1)	Bluetooth	8.01	±9.6
10037	CAA	IEEE 802.15.1 Bluetooth (8-DPSK, DH3)	Bluetooth	4.77	±9.6
10038	CAA	IEEE 802.15.1 Bluetooth (8-DPSK, DH5)	Bluetooth	4.10	±9.6
10039	CAB	CDMA2000 (1xRTT, RC1)	CDMA2000	4.57	±9.6
10042	CAB	IS-54 / IS-136 FDD (TDMA/FDM, PI/4-DQPSK, Halfrate)	AMPS	7.78	±9.6
10044	CAA	IS-91/EIA/TIA-553 FDD (FDMA, FM)	AMPS	0.00	±9.6
10048	CAA	DECT (TDD, TDMA/FDM, GFSK, Full Slot, 24)	DECT	13.80	±9.6
10049	CAA	DECT (TDD, TDMA/FDM, GFSK, Double Slot, 12)	DECT	10.79	±9.6
10056	CAA	UMTS-TDD (TD-SCDMA, 1.28 Mcps)	TD-SCDMA	11.01	±9.6
10058	DAC	EDGE-FDD (TDMA, 8PSK, TN 0-1-2-3)	GSM	6.52	±9.6
10059	CAB	IEEE 802.11b WiFi 2.4 GHz (DSSS, 2 Mbps)	WLAN	2.12	±9.6
10060	CAB	IEEE 802.11b WiFi 2.4 GHz (DSSS, 5.5 Mbps)	WLAN	2.83	±9.6
10061	CAB	IEEE 802.11b WiFi 2.4 GHz (DSSS, 11 Mbps)	WLAN	3.60	±9.6
10062	CAD	IEEE 802.11a/h WiFi 5 GHz (OFDM, 6 Mbps)	WLAN	8.68	±9.6
10063	CAD	IEEE 802.11a/h WiFi 5 GHz (OFDM, 9 Mbps)	WLAN	8.63	±9.6
10064	CAD	IEEE 802.11a/h WiFi 5 GHz (OFDM, 12 Mbps)	WLAN	9.09	±9.6
10065	CAD	IEEE 802.11a/h WiFi 5 GHz (OFDM, 18 Mbps)	WLAN	9.00	±9.6
10066	CAD	IEEE 802.11a/h WiFi 5 GHz (OFDM, 24 Mbps)	WLAN	9.38	±9.6
10067	CAD	IEEE 802.11a/h WiFi 5 GHz (OFDM, 36 Mbps)	WLAN	10.12	±9.6
10068	CAD	IEEE 802.11a/h WiFi 5 GHz (OFDM, 48 Mbps)	WLAN	10.24	±9.6
10069	CAD	IEEE 802.11a/h WiFi 5 GHz (OFDM, 54 Mbps)	WLAN	10.56	±9.6
10071	CAB	IEEE 802.11g WiFi 2.4 GHz (DSSS/OFDM, 9 Mbps)	WLAN	9.83	±9.6
10072	CAB	IEEE 802.11g WiFi 2.4 GHz (DSSS/OFDM, 12 Mbps)	WLAN	9.62	±9.6
10073	CAB	IEEE 802.11g WiFi 2.4 GHz (DSSS/OFDM, 18 Mbps)	WLAN	9.94	±9.6
10074	CAB	IEEE 802.11g WiFi 2.4 GHz (DSSS/OFDM, 24 Mbps)	WLAN	10.30	±9.6
10075	CAB	IEEE 802.11g WiFi 2.4 GHz (DSSS/OFDM, 36 Mbps)	WLAN	10.77	±9.6
10076	CAB	IEEE 802.11g WiFi 2.4 GHz (DSSS/OFDM, 48 Mbps)	WLAN	10.94	±9.6
10077	CAB	IEEE 802.11g WiFi 2.4 GHz (DSSS/OFDM, 54 Mbps)	WLAN	11.00	±9.6
10081	CAB	CDMA2000 (1xRTT, RC3)	CDMA2000	3.97	±9.6
10082	CAB	IS-54 / IS-136 FDD (TDMA/FDM, PI/4-DQPSK, Fullrate)	AMPS	4.77	±9.6
10090	DAC	GPRS-FDD (TDMA, GMSK, TN 0-4)	GSM	6.56	±9.6
10097	CAC	UMTS-FDD (HSDPA)	WCDMA	3.98	±9.6
10098	CAC	UMTS-FDD (HSUPA, Subtest 2)	WCDMA	3.98	±9.6
10099	DAC	EDGE-FDD (TDMA, 8PSK, TN 0-4)	GSM	9.55	±9.6
10100	CAF	LTE-FDD (SC-FDMA, 100% RB, 20 MHz, QPSK)	LTE-FDD	5.67	±9.6
10101	CAF	LTE-FDD (SC-FDMA, 100% RB, 20 MHz, 16-QAM)	LTE-FDD	6.42	±9.6
10102	CAF	LTE-FDD (SC-FDMA, 100% RB, 20 MHz, 64-QAM)	LTE-FDD	6.60	±9.6
10103	CAH	LTE-TDD (SC-FDMA, 100% RB, 20 MHz, QPSK)	LTE-TDD	9.29	±9.6
10104	CAH	LTE-TDD (SC-FDMA, 100% RB, 20 MHz, 16-QAM)	LTE-TDD	9.97	±9.6
10105	CAH	LTE-TDD (SC-FDMA, 100% RB, 20 MHz, 64-QAM)	LTE-TDD	10.01	±9.6
10108	CAH	LTE-FDD (SC-FDMA, 100% RB, 10 MHz, QPSK)	LTE-FDD	5.80	±9.6
10109	CAH	LTE-FDD (SC-FDMA, 100% RB, 10 MHz, 16-QAM)	LTE-FDD	6.43	±9.6
10110	CAH	LTE-FDD (SC-FDMA, 100% RB, 5 MHz, QPSK)	LTE-FDD	5.75	±9.6
10111	CAH	LTE-FDD (SC-FDMA, 100% RB, 5 MHz, 16-QAM)	LTE-FDD	6.44	±9.6

Certificate No: EX-3846_May23

Page 12 of 23



EX3DV4 - SN:3846

May 31, 2023

UID	Rev	Communication System Name	Group	PAR (dB)	Unc ^F k = 2
10112	CAH	LTE-FDD (SC-FDMA, 100% RB, 10 MHz, 64-QAM)	LTE-FDD	6.59	±9.6
10113	CAH	LTE-FDD (SC-FDMA, 100% RB, 5 MHz, 64-QAM)	LTE-FDD	6.62	±9.6
10114	CAD	IEEE 802.11n (HT Greenfield, 13.5 Mbps, BPSK)	WLAN	8.10	±9.6
10115	CAD	IEEE 802.11n (HT Greenfield, 81 Mbps, 16-QAM)	WLAN	8.46	±9.6
10116	CAD	IEEE 802.11n (HT Greenfield, 135 Mbps, 64-QAM)	WLAN	8.15	±9.6
10117	CAD	IEEE 802.11n (HT Mixed, 13.5 Mbps, BPSK)	WLAN	8.07	±9.6
10118	CAD	IEEE 802.11n (HT Mixed, 81 Mbps, 16-QAM)	WLAN	8.59	±9.6
10119	CAD	IEEE 802.11n (HT Mixed, 135 Mbps, 64-QAM)	WLAN	8.13	±9.6
10140	CAF	LTE-FDD (SC-FDMA, 100% RB, 15 MHz, 16-QAM)	LTE-FDD	6.49	±9.6
10141	CAF	LTE-FDD (SC-FDMA, 100% RB, 15 MHz, 64-QAM)	LTE-FDD	6.53	±9.6
10142	CAF	LTE-FDD (SC-FDMA, 100% RB, 3 MHz, QPSK)	LTE-FDD	5.73	±9.6
10143	CAF	LTE-FDD (SC-FDMA, 100% RB, 3 MHz, 16-QAM)	LTE-FDD	6.35	±9.6
10144	CAF	LTE-FDD (SC-FDMA, 100% RB, 3 MHz, 64-QAM)	LTE-FDD	6.65	±9.6
10145	CAG	LTE-FDD (SC-FDMA, 100% RB, 1.4 MHz, QPSK)	LTE-FDD	5.76	±9.6
10146	CAG	LTE-FDD (SC-FDMA, 100% RB, 1.4 MHz, 16-QAM)	LTE-FDD	6.41	±9.6
10147	CAG	LTE-FDD (SC-FDMA, 100% RB, 1.4 MHz, 64-QAM)	LTE-FDD	6.72	±9.6
10149	CAF	LTE-FDD (SC-FDMA, 50% RB, 20 MHz, 16-QAM)	LTE-FDD	6.42	±9.6
10150	CAF	LTE-FDD (SC-FDMA, 50% RB, 20 MHz, 64-QAM)	LTE-FDD	6.60	±9.6
10151	CAH	LTE-TDD (SC-FDMA, 50% RB, 20 MHz, QPSK)	LTE-TDD	9.28	±9.6
10152	CAH	LTE-TDD (SC-FDMA, 50% RB, 20 MHz, 16-QAM)	LTE-TDD	9.92	±9.6
10153	CAH	LTE-TDD (SC-FDMA, 50% RB, 20 MHz, 64-QAM)	LTE-TDD	10.05	±9.6
10154	CAH	LTE-FDD (SC-FDMA, 50% RB, 10 MHz, QPSK)	LTE-FDD	5.75	±9.6
10155	CAH	LTE-FDD (SC-FDMA, 50% RB, 10 MHz, 16-QAM)	LTE-FDD	6.43	±9.6
10156	CAH	LTE-FDD (SC-FDMA, 50% RB, 5 MHz, QPSK)	LTE-FDD	5.79	±9.6
10157	CAH	LTE-FDD (SC-FDMA, 50% RB, 5 MHz, 16-QAM)	LTE-FDD	6.49	±9.6
10158	CAH	LTE-FDD (SC-FDMA, 50% RB, 10 MHz, 64-QAM)	LTE-FDD	6.62	±9.6
10159	CAH	LTE-FDD (SC-FDMA, 50% RB, 5 MHz, 64-QAM)	LTE-FDD	6.56	±9.6
10160	CAF	LTE-FDD (SC-FDMA, 50% RB, 15 MHz, QPSK)	LTE-FDD	5.82	±9.6
10161	CAF	LTE-FDD (SC-FDMA, 50% RB, 15 MHz, 16-QAM)	LTE-FDD	6.43	±9.6
10162	CAF	LTE-FDD (SC-FDMA, 50% RB, 15 MHz, 64-QAM)	LTE-FDD	6.58	±9.6
10166	CAG	LTE-FDD (SC-FDMA, 50% RB, 1.4 MHz, QPSK)	LTE-FDD	5.46	±9.6
10167	CAG	LTE-FDD (SC-FDMA, 50% RB, 1.4 MHz, 16-QAM)	LTE-FDD	6.21	±9.6
10168	CAG	LTE-FDD (SC-FDMA, 50% RB, 1.4 MHz, 64-QAM)	LTE-FDD	6.79	±9.6
10169	CAF	LTE-FDD (SC-FDMA, 1 RB, 20 MHz, QPSK)	LTE-FDD	5.73	±9.6
10170	CAF	LTE-FDD (SC-FDMA, 1 RB, 20 MHz, 16-QAM)	LTE-FDD	6.52	±9.6
10171	AAF	LTE-FDD (SC-FDMA, 1 RB, 20 MHz, 64-QAM)	LTE-FDD	6.49	±9.6
10172	CAH	LTE-TDD (SC-FDMA, 1 RB, 20 MHz, QPSK)	LTE-TDD	9.21	±9.6
10173	CAH	LTE-TDD (SC-FDMA, 1 RB, 20 MHz, 16-QAM)	LTE-TDD	9.48	±9.6
10174	CAH	LTE-TDD (SC-FDMA, 1 RB, 20 MHz, 64-QAM)	LTE-TDD	10.25	±9.6
10175	CAH	LTE-FDD (SC-FDMA, 1 RB, 10 MHz, QPSK)	LTE-FDD	5.72	±9.6
10176	CAH	LTE-FDD (SC-FDMA, 1 RB, 10 MHz, 16-QAM)	LTE-FDD	6.52	±9.6
10177	CAJ	LTE-FDD (SC-FDMA, 1 RB, 5 MHz, QPSK)	LTE-FDD	5.73	±9.6
10178	CAH	LTE-FDD (SC-FDMA, 1 RB, 5 MHz, 16-QAM)	LTE-FDD	6.52	±9.6
10179	CAH	LTE-FDD (SC-FDMA, 1 RB, 10 MHz, 64-QAM)	LTE-FDD	6.50	±9.6
10180	CAH	LTE-FDD (SC-FDMA, 1 RB, 5 MHz, 64-QAM)	LTE-FDD	6.50	±9.6
10181	CAF	LTE-FDD (SC-FDMA, 1 RB, 15 MHz, QPSK)	LTE-FDD	5.72	±9.6
10182	CAF	LTE-FDD (SC-FDMA, 1 RB, 15 MHz, 16-QAM)	LTE-FDD	6.52	±9.6
10183	AAE	LTE-FDD (SC-FDMA, 1 RB, 15 MHz, 64-QAM)	LTE-FDD	6.50	±9.6
10184	CAF	LTE-FDD (SC-FDMA, 1 RB, 3 MHz, QPSK)	LTE-FDD	5.73	±9.6
10185	CAF	LTE-FDD (SC-FDMA, 1 RB, 3 MHz, 16-QAM)	LTE-FDD	6.51	±9.6
10186	AAF	LTE-FDD (SC-FDMA, 1 RB, 3 MHz, 64-QAM)	LTE-FDD	6.50	±9.6
10187	CAG	LTE-FDD (SC-FDMA, 1 RB, 1.4 MHz, QPSK)	LTE-FDD	5.73	±9.6
10188	CAG	LTE-FDD (SC-FDMA, 1 RB, 1.4 MHz, 16-QAM)	LTE-FDD	6.52	±9.6
10189	AAG	LTE-FDD (SC-FDMA, 1 RB, 1.4 MHz, 64-QAM)	LTE-FDD	6.50	±9.6
10193	CAD	IEEE 802.11n (HT Greenfield, 6.5 Mbps, BPSK)	WLAN	8.09	±9.6
10194	CAD	IEEE 802.11n (HT Greenfield, 39 Mbps, 16-QAM)	WLAN	8.12	±9.6
10195	CAD	IEEE 802.11n (HT Greenfield, 85 Mbps, 64-QAM)	WLAN	8.21	±9.6
10196	CAD	IEEE 802.11n (HT Mixed, 6.5 Mbps, BPSK)	WLAN	8.10	±9.6
10197	CAD	IEEE 802.11n (HT Mixed, 39 Mbps, 16-QAM)	WLAN	8.13	±9.6
10198	CAD	IEEE 802.11n (HT Mixed, 85 Mbps, 64-QAM)	WLAN	8.27	±9.6
10219	CAD	IEEE 802.11n (HT Mixed, 7.2 Mbps, BPSK)	WLAN	8.03	±9.6
10220	CAD	IEEE 802.11n (HT Mixed, 43.3 Mbps, 16-QAM)	WLAN	8.13	±9.6
10221	CAD	IEEE 802.11n (HT Mixed, 72.2 Mbps, 64-QAM)	WLAN	8.27	±9.6
10222	CAD	IEEE 802.11n (HT Mixed, 15 Mbps, BPSK)	WLAN	8.06	±9.6
10223	CAD	IEEE 802.11n (HT Mixed, 90 Mbps, 16-QAM)	WLAN	8.48	±9.6
10224	CAD	IEEE 802.11n (HT Mixed, 150 Mbps, 64-QAM)	WLAN	8.08	±9.6



EX3DV4 - SN:3846

May 31, 2023

UID	Rev	Communication System Name	Group	PAR (dB)	Unc ^E k = 2
10225	CAC	UMTS-FDD (HSPA+)	WCDMA	5.97	±9.6
10226	CAC	LTE-TDD (SC-FDMA, 1 RB, 1.4 MHz, 16-QAM)	LTE-TDD	9.49	±9.6
10227	CAC	LTE-TDD (SC-FDMA, 1 RB, 1.4 MHz, 64-QAM)	LTE-TDD	10.26	±9.6
10228	CAC	LTE-TDD (SC-FDMA, 1 RB, 1.4 MHz, QPSK)	LTE-TDD	9.22	±9.6
10229	CAE	LTE-TDD (SC-FDMA, 1 RB, 3 MHz, 16-QAM)	LTE-TDD	9.48	±9.6
10230	CAE	LTE-TDD (SC-FDMA, 1 RB, 3 MHz, 64-QAM)	LTE-TDD	10.25	±9.6
10231	CAE	LTE-TDD (SC-FDMA, 1 RB, 3 MHz, QPSK)	LTE-TDD	9.19	±9.6
10232	CAH	LTE-TDD (SC-FDMA, 1 RB, 5 MHz, 16-QAM)	LTE-TDD	9.48	±9.6
10233	CAH	LTE-TDD (SC-FDMA, 1 RB, 5 MHz, 64-QAM)	LTE-TDD	10.25	±9.6
10234	CAH	LTE-TDD (SC-FDMA, 1 RB, 5 MHz, QPSK)	LTE-TDD	9.21	±9.6
10235	CAH	LTE-TDD (SC-FDMA, 1 RB, 10 MHz, 16-QAM)	LTE-TDD	9.48	±9.6
10236	CAH	LTE-TDD (SC-FDMA, 1 RB, 10 MHz, 64-QAM)	LTE-TDD	10.25	±9.6
10237	CAH	LTE-TDD (SC-FDMA, 1 RB, 10 MHz, QPSK)	LTE-TDD	9.21	±9.6
10238	CAG	LTE-TDD (SC-FDMA, 1 RB, 15 MHz, 16-QAM)	LTE-TDD	9.48	±9.6
10239	CAG	LTE-TDD (SC-FDMA, 1 RB, 15 MHz, 64-QAM)	LTE-TDD	10.25	±9.6
10240	CAG	LTE-TDD (SC-FDMA, 1 RB, 15 MHz, QPSK)	LTE-TDD	9.21	±9.6
10241	CAC	LTE-TDD (SC-FDMA, 50% RB, 1.4 MHz, 16-QAM)	LTE-TDD	9.82	±9.6
10242	CAC	LTE-TDD (SC-FDMA, 50% RB, 1.4 MHz, 64-QAM)	LTE-TDD	9.86	±9.6
10243	CAC	LTE-TDD (SC-FDMA, 50% RB, 1.4 MHz, QPSK)	LTE-TDD	9.46	±9.6
10244	CAE	LTE-TDD (SC-FDMA, 50% RB, 3 MHz, 16-QAM)	LTE-TDD	10.06	±9.6
10245	CAE	LTE-TDD (SC-FDMA, 50% RB, 3 MHz, 64-QAM)	LTE-TDD	10.06	±9.6
10246	CAE	LTE-TDD (SC-FDMA, 50% RB, 3 MHz, QPSK)	LTE-TDD	9.30	±9.6
10247	CAH	LTE-TDD (SC-FDMA, 50% RB, 5 MHz, 16-QAM)	LTE-TDD	9.91	±9.6
10248	CAH	LTE-TDD (SC-FDMA, 50% RB, 5 MHz, 64-QAM)	LTE-TDD	10.09	±9.6
10249	CAH	LTE-TDD (SC-FDMA, 50% RB, 5 MHz, QPSK)	LTE-TDD	9.29	±9.6
10250	CAH	LTE-TDD (SC-FDMA, 50% RB, 10 MHz, 16-QAM)	LTE-TDD	9.81	±9.6
10251	CAH	LTE-TDD (SC-FDMA, 50% RB, 10 MHz, 64-QAM)	LTE-TDD	10.17	±9.6
10252	CAH	LTE-TDD (SC-FDMA, 50% RB, 10 MHz, QPSK)	LTE-TDD	9.24	±9.6
10253	CAG	LTE-TDD (SC-FDMA, 50% RB, 15 MHz, 16-QAM)	LTE-TDD	9.90	±9.6
10254	CAG	LTE-TDD (SC-FDMA, 50% RB, 15 MHz, 64-QAM)	LTE-TDD	10.14	±9.6
10255	CAG	LTE-TDD (SC-FDMA, 50% RB, 15 MHz, QPSK)	LTE-TDD	9.20	±9.6
10256	CAC	LTE-TDD (SC-FDMA, 100% RB, 1.4 MHz, 16-QAM)	LTE-TDD	9.96	±9.6
10257	CAC	LTE-TDD (SC-FDMA, 100% RB, 1.4 MHz, 64-QAM)	LTE-TDD	10.08	±9.6
10258	CAC	LTE-TDD (SC-FDMA, 100% RB, 1.4 MHz, QPSK)	LTE-TDD	9.34	±9.6
10259	CAE	LTE-TDD (SC-FDMA, 100% RB, 3 MHz, 16-QAM)	LTE-TDD	9.98	±9.6
10260	CAE	LTE-TDD (SC-FDMA, 100% RB, 3 MHz, 64-QAM)	LTE-TDD	9.97	±9.6
10261	CAE	LTE-TDD (SC-FDMA, 100% RB, 3 MHz, QPSK)	LTE-TDD	9.24	±9.6
10262	CAH	LTE-TDD (SC-FDMA, 100% RB, 5 MHz, 16-QAM)	LTE-TDD	9.83	±9.6
10263	CAH	LTE-TDD (SC-FDMA, 100% RB, 5 MHz, 64-QAM)	LTE-TDD	10.16	±9.6
10264	CAH	LTE-TDD (SC-FDMA, 100% RB, 5 MHz, QPSK)	LTE-TDD	9.23	±9.6
10265	CAH	LTE-TDD (SC-FDMA, 100% RB, 10 MHz, 16-QAM)	LTE-TDD	9.92	±9.6
10266	CAH	LTE-TDD (SC-FDMA, 100% RB, 10 MHz, 64-QAM)	LTE-TDD	10.07	±9.6
10267	CAH	LTE-TDD (SC-FDMA, 100% RB, 10 MHz, QPSK)	LTE-TDD	9.30	±9.6
10268	CAG	LTE-TDD (SC-FDMA, 100% RB, 15 MHz, 16-QAM)	LTE-TDD	10.06	±9.6
10269	CAG	LTE-TDD (SC-FDMA, 100% RB, 15 MHz, 64-QAM)	LTE-TDD	10.13	±9.6
10270	CAG	LTE-TDD (SC-FDMA, 100% RB, 15 MHz, QPSK)	LTE-TDD	9.58	±9.6
10274	CAC	UMTS-FDD (HSUPA, Subtest 5, 3GPP Rel8.10)	WCDMA	4.87	±9.6
10275	CAC	UMTS-FDD (HSUPA, Subtest 5, 3GPP Rel8.4)	WCDMA	3.96	±9.6
10277	CAA	PHS (QPSK)	PHS	11.81	±9.6
10278	CAA	PHS (QPSK, BW 884 MHz, Rolloff 0.5)	PHS	11.81	±9.6
10279	CAA	PHS (QPSK, BW 884 MHz, Rolloff 0.38)	PHS	12.18	±9.6
10290	AAB	CDMA2000, RC1, SO55, Full Rate	CDMA2000	3.91	±9.6
10291	AAB	CDMA2000, RC3, SO55, Full Rate	CDMA2000	3.46	±9.6
10292	AAB	CDMA2000, RC3, SO32, Full Rate	CDMA2000	3.39	±9.6
10293	AAB	CDMA2000, RC3, SO3, Full Rate	CDMA2000	3.50	±9.6
10295	AAB	CDMA2000, RC1, SO3, 1/8th Rate 25 fr.	CDMA2000	12.49	±9.6
10297	AAE	LTE-FDD (SC-FDMA, 50% RB, 20 MHz, QPSK)	LTE-FDD	5.81	±9.6
10298	AAE	LTE-FDD (SC-FDMA, 50% RB, 3 MHz, QPSK)	LTE-FDD	5.72	±9.6
10299	AAE	LTE-FDD (SC-FDMA, 50% RB, 3 MHz, 16-QAM)	LTE-FDD	6.39	±9.6
10300	AAE	LTE-FDD (SC-FDMA, 50% RB, 3 MHz, 64-QAM)	LTE-FDD	6.60	±9.6
10301	AAA	IEEE 802.16e WiMAX (29:18, 5 ms, 10 MHz, QPSK, PUSC)	WiMAX	12.03	±9.6
10302	AAA	IEEE 802.16e WiMAX (29:18, 5 ms, 10 MHz, QPSK, PUSC, 3 CTRL symbols)	WiMAX	12.57	±9.6
10303	AAA	IEEE 802.16e WiMAX (31:15, 5 ms, 10 MHz, 64QAM, PUSC)	WiMAX	12.52	±9.6
10304	AAA	IEEE 802.16e WiMAX (29:18, 5 ms, 10 MHz, 64QAM, PUSC)	WiMAX	11.86	±9.6
10305	AAA	IEEE 802.16e WiMAX (31:15, 10 ms, 10 MHz, 64QAM, PUSC, 15 symbols)	WiMAX	15.24	±9.6
10306	AAA	IEEE 802.16e WiMAX (29:18, 10 ms, 10 MHz, 64QAM, PUSC, 18 symbols)	WiMAX	14.67	±9.6