



**FCC PART 15C
TEST REPORT
No. I14Z47644-SRD01**

for

TCL Communication Ltd.

CDMA 1X/EVDO tri-band mobile phone

Model name: 4037V

With

FCC ID: 2ACCJB001

Hardware Version: VC

Software Version: V5HT3-5

Issued Date: 2014-09-30



Deutsche
Akkreditierungsstelle
D-PL-12123-01-01

FCC 2.948 Listed: No.733176

IC O.A.T.S listed: No.6629A-1

Note:The test results in this test report relate only to the devices specified in this report. This report shall not be reproduced except in full without the written approval of TMC Beijing.

Test Laboratory:

TMC Beijing, Telecommunication Metrology Center of Ministry of Industry and Information Technology

No. 52, Huayuan Bei Road, Haidian District, Beijing, P. R. China, 100191

Tel:+86(0)10-62304633-2046, Fax:+86(0)10-62304633-2063 Email:welcome@emcite.com. www.emcite.com

CONTENTS

CONTENTS	2
1. TEST LABORATORY	8
1.1. TESTING LOCATION.....	8
1.2. PROJECT DATA.....	8
1.3. SIGNATURE	8
2. CLIENT INFORMATION	9
2.1. APPLICANT INFORMATION.....	9
2.2. MANUFACTURER INFORMATION.....	9
3. EQUIPMENT UNDER TEST(EUT) AND ANCILLARY EQUIPMENT(AE)	10
3.1. ABOUT EUT	10
3.2. INTERNAL IDENTIFICATION OF EUT USED DURING THE TEST	10
3.3. INTERNAL IDENTIFICATION OF AE USED DURING THE TEST.....	10
3.4. GENERAL DESCRIPTION	10
4. REFERENCE DOCUMENTS	10
4.1. DOCUMENTS SUPPLIED BY APPLICANT	10
4.2. REFERENCE DOCUMENTS FOR TESTING	11
5. LABORATORY ENVIRONMENT	11
6. SUMMARY OF TEST RESULTS	11
6.1. SUMMARY OF TEST RESULTS	11
6.2. STATEMENTS.....	11
6.3. TEST CONDITIONS	12
7. TEST EQUIPMENTS UTILIZED	13
ANNEX A: MEASUREMENT RESULTS	14
A.1. MEASUREMENT METHOD	14
A.2. MAXIMUM OUTPUT POWER	15
A.2.1. PEAK OUTPUT POWER-CONDUCTED.....	15
A.2.2. AVERAGE OUTPUT POWER-CONDUCTED	16
A.3. PEAK POWER SPECTRAL DENSITY	17
FIG.A.3.1 POWER SPECTRAL DENSITY (802.11B, CH 1).....	18
FIG.A.3.2 POWER SPECTRAL DENSITY (802.11B, CH 6).....	18
FIG.A.3.3 POWER SPECTRAL DENSITY (802.11B, CH 11).....	19
FIG.A.3.4 POWER SPECTRAL DENSITY (802.11G, CH 1).....	19
FIG.A.3.5 POWER SPECTRAL DENSITY (802.11G, CH 6).....	20
FIG.A.3.6 POWER SPECTRAL DENSITY (802.11G, CH 11).....	20
FIG.A.3.7 POWER SPECTRAL DENSITY (802.11N-HT20, CH 1)	21
FIG.A.3.8 POWER SPECTRAL DENSITY (802.11N-HT20, CH 6)	21
FIG.A.3.9 POWER SPECTRAL DENSITY (802.11N-HT20, CH 11).....	22

A.4. DTS 6-DB SIGNAL BANDWIDTH.....	23
FIG.A.4.1 OCCUPIED 6DB BANDWIDTH (802.11B, CH 1)	24
FIG.A.4.2 OCCUPIED 6DB BANDWIDTH (802.11B, CH 6)	24
FIG.A.4.3 OCCUPIED 6DB BANDWIDTH (802.11B, CH 11).....	25
FIG.A.4.4 OCCUPIED 6DB BANDWIDTH (802.11G, CH 1)	25
FIG.A.4.5 OCCUPIED 6DB BANDWIDTH (802.11G, CH 6)	26
FIG.A.4.6 OCCUPIED 6DB BANDWIDTH (802.11G, CH 11).....	26
FIG.A.4.7 OCCUPIED 6DB BANDWIDTH (802.11N-20MHZ, CH 1).....	27
FIG.A.4.8 OCCUPIED 6DB BANDWIDTH (802.11N-HT20, CH 6)	27
FIG.A.4.9 OCCUPIED 6DB BANDWIDTH (802.11N-HT20, CH 11).....	28
A.5. BAND EDGES COMPLIANCE.....	29
FIG.A.5.1 BAND EDGES (802.11B, CH 1)	30
FIG.A.5.2 BAND EDGES (802.11B, CH 11).....	30
FIG.A.5.3 BAND EDGES (802.11G, CH 1)	31
FIG.A.5.4 BAND EDGES (802.11G, CH 11).....	31
FIG.A.5.5 BAND EDGES (802.11N-HT20, CH 1)	32
FIG.A.5.6 BAND EDGES (802.11N-HT20, CH 11)	32
A.6. TRANSMITTER SPURIOUS EMISSION	33
A.6.1 TRANSMITTER SPURIOUS EMISSION - CONDUCTED	33
FIG.A.6.1.1 TRANSMITTER SPURIOUS EMISSION - CONDUCTED (802.11B, CH1, CENTER FREQUENCY) 37	37
FIG.A.6.1.2 TRANSMITTER SPURIOUS EMISSION - CONDUCTED (802.11B, CH1, 30 MHZ-1 GHZ) 37	37
FIG.A.6.1.3 TRANSMITTER SPURIOUS EMISSION - CONDUCTED (802.11B, CH1, 1 GHZ-2.5 GHZ) 38	38
FIG.A.6.1.4 TRANSMITTER SPURIOUS EMISSION - CONDUCTED (802.11B, CH1, 2.5 GHZ-7.5 GHZ) 38	38
FIG.A.6.1.5 TRANSMITTER SPURIOUS EMISSION - CONDUCTED (802.11B, CH1, 7.5 GHZ-10 GHZ) 39	39
FIG.A.6.1.6 TRANSMITTER SPURIOUS EMISSION - CONDUCTED (802.11B, CH1, 10 GHZ-15 GHZ) 39	39
FIG.A.6.1.7 TRANSMITTER SPURIOUS EMISSION - CONDUCTED (802.11B, CH1, 15 GHZ-20 GHZ) 40	40
FIG.A.6.1.8 TRANSMITTER SPURIOUS EMISSION - CONDUCTED (802.11B, CH1, 20 GHZ-26 GHZ) 40	40
FIG.A.6.1.9 TRANSMITTER SPURIOUS EMISSION - CONDUCTED (802.11B, CH6, CENTER FREQUENCY) 41	41
FIG.A.6.1.10 TRANSMITTER SPURIOUS EMISSION - CONDUCTED (802.11B, CH6, 30 MHZ-1 GHZ) 41	41
FIG.A.6.1.11 TRANSMITTER SPURIOUS EMISSION - CONDUCTED (802.11B, CH6, 1 GHZ-2.5 GHZ) 42	42
FIG.A.6.1.12 TRANSMITTER SPURIOUS EMISSION - CONDUCTED (802.11B, CH6, 2.5 GHZ-7.5 GHZ) 42	42
FIG.A.6.1.13 TRANSMITTER SPURIOUS EMISSION - CONDUCTED (802.11B, CH6, 7.5 GHZ-10 GHZ)	

	43
FIG.A.6.1.14	TRANSMITTER SPURIOUS EMISSION - CONDUCTED (802.11B, CH6, 10 GHZ-15 GHZ)
	43
FIG.A.6.1.15	TRANSMITTER SPURIOUS EMISSION - CONDUCTED (802.11B, CH6, 15 GHZ-20 GHZ)
	44
FIG.A.6.1.16	TRANSMITTER SPURIOUS EMISSION - CONDUCTED (802.11B, CH6, 20 GHZ-26 GHZ)
	44
FIG.A.6.1.17	TRANSMITTER SPURIOUS EMISSION - CONDUCTED (802.11B, CH11, CENTER
FREQUENCY)	45
FIG.A.6.1.18	TRANSMITTER SPURIOUS EMISSION - CONDUCTED (802.11B, CH11, 30 MHZ-1 GHZ)
	45
FIG.A.6.1.19	TRANSMITTER SPURIOUS EMISSION - CONDUCTED (802.11B, CH11, 1 GHZ-2.5 GHZ)
	46
FIG.A.6.1.20	TRANSMITTER SPURIOUS EMISSION - CONDUCTED (802.11B, CH11, 2.5 GHZ-7.5
GHZ)	46
FIG.A.6.1.21	TRANSMITTER SPURIOUS EMISSION - CONDUCTED (802.11B, CH11, 7.5 GHZ-10
GHZ)	47
FIG.A.6.1.22	TRANSMITTER SPURIOUS EMISSION - CONDUCTED (802.11B, CH11, 10 GHZ-15 GHZ)
	47
FIG.A.6.1.23	TRANSMITTER SPURIOUS EMISSION - CONDUCTED (802.11B, CH11, 15 GHZ-20 GHZ)
	48
FIG.A.6.1.24	TRANSMITTER SPURIOUS EMISSION - CONDUCTED (802.11B, CH11, 20 GHZ-26 GHZ)
	48
FIG.A.6.1.25	TRANSMITTER SPURIOUS EMISSION - CONDUCTED (802.11G, CH1, CENTER
FREQUENCY)	49
FIG.A.6.1.26	TRANSMITTER SPURIOUS EMISSION - CONDUCTED (802.11G, CH1, 30 MHZ-1 GHZ)
	49
FIG.A.6.1.27	TRANSMITTER SPURIOUS EMISSION - CONDUCTED (802.11G, CH1, 1 GHZ-2.5 GHZ)
	50
FIG.A.6.1.28	TRANSMITTER SPURIOUS EMISSION - CONDUCTED (802.11G, CH1, 2.5 GHZ-7.5 GHZ)
	50
FIG.A.6.1.29	TRANSMITTER SPURIOUS EMISSION - CONDUCTED (802.11G, CH1, 7.5 GHZ-10 GHZ)
	51
FIG.A.6.1.30	TRANSMITTER SPURIOUS EMISSION - CONDUCTED (802.11G, CH1, 10 GHZ-15 GHZ)
	51
FIG.A.6.1.31	TRANSMITTER SPURIOUS EMISSION - CONDUCTED (802.11G, CH1, 15 GHZ-20 GHZ)
	52
FIG.A.6.1.32	TRANSMITTER SPURIOUS EMISSION - CONDUCTED (802.11G, CH1, 20 GHZ-26 GHZ)
	52
FIG.A.6.1.33	TRANSMITTER SPURIOUS EMISSION - CONDUCTED (802.11G, CH6, CENTER
FREQUENCY)	53
FIG.A.6.1.34	TRANSMITTER SPURIOUS EMISSION - CONDUCTED (802.11G, CH6, 30 MHZ-1 GHZ)
	53
FIG.A.6.1.35	TRANSMITTER SPURIOUS EMISSION - CONDUCTED (802.11G, CH6, 1 GHZ-2.5 GHZ)

	54
FIG.A.6.1.36	TRANSMITTER SPURIOUS EMISSION - CONDUCTED (802.11G, CH6, 2.5 GHZ-7.5 GHZ)
	54
FIG.A.6.1.37	TRANSMITTER SPURIOUS EMISSION - CONDUCTED (802.11G, CH6, 7.5 GHZ-10 GHZ)
	55
FIG.A.6.1.38	TRANSMITTER SPURIOUS EMISSION - CONDUCTED (802.11G, CH6, 10 GHZ-15 GHZ)
	55
FIG.A.6.1.39	TRANSMITTER SPURIOUS EMISSION - CONDUCTED (802.11G, CH6, 15 GHZ-20 GHZ)
	56
FIG.A.6.1.40	TRANSMITTER SPURIOUS EMISSION - CONDUCTED (802.11G, CH6, 20 GHZ-26 GHZ)
	56
FIG.A.6.1.41	TRANSMITTER SPURIOUS EMISSION - CONDUCTED (802.11G, CH11, CENTER
FREQUENCY)	57
FIG.A.6.1.42	TRANSMITTER SPURIOUS EMISSION - CONDUCTED (802.11G, CH11, 30 MHZ-1 GHZ)
	57
FIG.A.6.1.43	TRANSMITTER SPURIOUS EMISSION - CONDUCTED (802.11G, CH11, 1 GHZ-2.5 GHZ)
	58
FIG.A.6.1.44	TRANSMITTER SPURIOUS EMISSION - CONDUCTED (802.11G, CH11, 2.5 GHZ-7.5
GHZ)	58
FIG.A.6.1.45	TRANSMITTER SPURIOUS EMISSION - CONDUCTED (802.11G, CH11, 7.5 GHZ-10
GHZ)	59
FIG.A.6.1.46	TRANSMITTER SPURIOUS EMISSION - CONDUCTED (802.11G, CH11, 10 GHZ-15 GHZ)
	59
FIG.A.6.1.47	TRANSMITTER SPURIOUS EMISSION - CONDUCTED (802.11G, CH11, 15 GHZ-20 GHZ)
	60
FIG.A.6.1.48	TRANSMITTER SPURIOUS EMISSION - CONDUCTED (802.11G, CH11, 20 GHZ-26 GHZ)
	60
FIG.A.6.1.49	TRANSMITTER SPURIOUS EMISSION - CONDUCTED (802.11N-HT20, CH1, CENTER
FREQUENCY)	61
FIG.A.6.1.50	TRANSMITTER SPURIOUS EMISSION - CONDUCTED (802.11N-HT20, CH1, 30 MHZ-1
GHZ)	61
FIG.A.6.1.51	TRANSMITTER SPURIOUS EMISSION - CONDUCTED (802.11N-HT20, CH1, 1 GHZ-2.5
GHZ)	62
FIG.A.6.1.52	TRANSMITTER SPURIOUS EMISSION - CONDUCTED (802.11N-HT20, CH1, 2.5
GHZ-7.5 GHZ)	62
FIG.A.6.1.53	TRANSMITTER SPURIOUS EMISSION - CONDUCTED (802.11N-HT20, CH1, 7.5
GHZ-10 GHZ)	63
FIG.A.6.1.54	TRANSMITTER SPURIOUS EMISSION - CONDUCTED (802.11N-HT20, CH1, 10
GHZ-15 GHZ)	63
FIG.A.6.1.55	TRANSMITTER SPURIOUS EMISSION - CONDUCTED (802.11N-HT20, CH1, 15
GHZ-20 GHZ)	64
FIG.A.6.1.56	TRANSMITTER SPURIOUS EMISSION - CONDUCTED (802.11N-HT20, CH1, 20
GHZ-26 GHZ)	64
FIG.A.6.1.57	TRANSMITTER SPURIOUS EMISSION - CONDUCTED (802.11N-HT20, CH6, CENTER

FREQUENCY)	65
FIG.A.6.1.58 TRANSMITTER SPURIOUS EMISSION - CONDUCTED (802.11N-HT20, CH6, 30 MHz-1 GHz)	65
FIG.A.6.1.59 TRANSMITTER SPURIOUS EMISSION - CONDUCTED (802.11N-HT20, CH6, 1 GHz-2.5 GHz)	66
FIG.A.6.1.60 TRANSMITTER SPURIOUS EMISSION - CONDUCTED (802.11N-HT20, CH6, 2.5 GHz-7.5 GHz)	66
FIG.A.6.1.61 TRANSMITTER SPURIOUS EMISSION - CONDUCTED (802.11N-HT20, CH6, 7.5 GHz-10 GHz)	67
FIG.A.6.1.62 TRANSMITTER SPURIOUS EMISSION - CONDUCTED (802.11N-HT20, CH6, 10 GHz-15 GHz)	67
FIG.A.6.1.63 TRANSMITTER SPURIOUS EMISSION - CONDUCTED (802.11N-HT20, CH6, 15 GHz-20 GHz)	68
FIG.A.6.1.64 TRANSMITTER SPURIOUS EMISSION - CONDUCTED (802.11N-HT20, CH6, 20 GHz-26 GHz)	68
FIG.A.6.1.65 TRANSMITTER SPURIOUS EMISSION - CONDUCTED (802.11N-HT20, CH11, CENTER FREQUENCY)	69
FIG.A.6.1.66 TRANSMITTER SPURIOUS EMISSION - CONDUCTED (802.11N-HT20, CH11, 30 MHz-1 GHz)	69
FIG.A.6.1.67 TRANSMITTER SPURIOUS EMISSION - CONDUCTED (802.11N-HT20, CH11, 1 GHz-2.5 GHz)	70
FIG.A.6.1.68 TRANSMITTER SPURIOUS EMISSION - CONDUCTED (802.11N-HT20, CH11, 2.5 GHz-7.5 GHz)	70
FIG.A.6.1.69 TRANSMITTER SPURIOUS EMISSION - CONDUCTED (802.11N-HT20, CH11, 7.5 GHz-10 GHz)	71
FIG.A.6.1.70 TRANSMITTER SPURIOUS EMISSION - CONDUCTED (802.11N-HT20, CH11, 10 GHz-15 GHz)	71
FIG.A.6.1.71 TRANSMITTER SPURIOUS EMISSION - CONDUCTED (802.11N-HT20, CH11, 15 GHz-20 GHz)	72
FIG.A.6.1.72 TRANSMITTER SPURIOUS EMISSION - CONDUCTED (802.11N-HT20, CH11, 20 GHz-26 GHz)	72
A.6.2 TRANSMITTER SPURIOUS EMISSION - RADIATED	73
FIG.A.6.2.1 TRANSMITTER SPURIOUS EMISSION - RADIATED (POWER): 802.11B, CH1, 2.38 GHz – 2.45GHz	78
FIG.A.6.2.2 TRANSMITTER SPURIOUS EMISSION - RADIATED (802.11B, CH1, 1 GHz-3 GHz)....	78
FIG.A.6.2.3 TRANSMITTER SPURIOUS EMISSION - RADIATED (802.11B, CH1, 3 GHz-18 GHz)..	79
FIG.A.6.2.4 TRANSMITTER SPURIOUS EMISSION - RADIATED (802.11B, CH6, 30 MHz-1 GHz) .	79
FIG.A.6.2.5 TRANSMITTER SPURIOUS EMISSION - RADIATED (802.11B, CH6, 1 GHz-3 GHz)....	80
FIG.A.6.2.6 TRANSMITTER SPURIOUS EMISSION - RADIATED (802.11B, CH6, 3 GHz-18 GHz)..	80
FIG.A.6.2.7 TRANSMITTER SPURIOUS EMISSION - RADIATED (802.11B, CH6, 18GHz – 26.5GHz)	81
FIG.A.6.2.8 TRANSMITTER SPURIOUS EMISSION - RADIATED (POWER): 802.11B, CH11, 2.45 GHz - 2.50GHz	81
FIG.A.6.2.9 TRANSMITTER SPURIOUS EMISSION - RADIATED (802.11B, CH11, 1 GHz-3 GHz)..	82

FIG.A.6.2.10	TRANSMITTER SPURIOUS EMISSION - RADIATED (802.11B, CH11, 3 GHZ-18 GHZ)	83
FIG.A.6.2.11	TRANSMITTER SPURIOUS EMISSION - RADIATED (POWER): 802.11G, CH1, 2.38 GHZ - 2.45GHZ	83
FIG.A.6.2.12	TRANSMITTER SPURIOUS EMISSION - RADIATED (802.11G, CH1, 1 GHZ-3 GHZ)...	84
FIG.A.6.2.13	TRANSMITTER SPURIOUS EMISSION - RADIATED (802.11G, CH1, 3 GHZ-18 GHZ)..	84
FIG.A.6.2.14	TRANSMITTER SPURIOUS EMISSION - RADIATED (802.11G, CH6, 30 MHZ-1 GHZ)	.85
FIG.A.6.2.15	TRANSMITTER SPURIOUS EMISSION - RADIATED (802.11G, CH6, 1 GHZ-3 GHZ)...	85
FIG.A.6.2.16	TRANSMITTER SPURIOUS EMISSION - RADIATED (802.11G, CH6, 3 GHZ-18 GHZ)..	86
FIG.A.6.2.17	TRANSMITTER SPURIOUS EMISSION - RADIATED (POWER): 802.11G, CH11, 2.45 GHZ - 2.50GHZ	86
FIG.A.6.2.18	TRANSMITTER SPURIOUS EMISSION - RADIATED (802.11G, CH11, 1 GHZ-3 GHZ)..	87
FIG.A.6.2.19	TRANSMITTER SPURIOUS EMISSION - RADIATED (802.11G, CH11, 3 GHZ-18 GHZ)	87
FIG.A.6.2.20	TRANSMITTER SPURIOUS EMISSION - RADIATED (POWER): 802.11N-HT20, CH1, 2.38 GHZ - 2.45GHZ	87
FIG.A.6.2.21	TRANSMITTER SPURIOUS EMISSION - RADIATED (802.11N-HT20, CH1, 1 GHZ-3 GHZ)	88
FIG.A.6.2.22	TRANSMITTER SPURIOUS EMISSION - RADIATED (802.11N-HT20, CH1, 3 GHZ-18 GHZ)	89
FIG.A.6.2.23	TRANSMITTER SPURIOUS EMISSION - RADIATED (802.11N-HT20, CH6, 30 MHZ-1 GHZ)	89
FIG.A.6.2.24	TRANSMITTER SPURIOUS EMISSION - RADIATED (802.11N-HT20, CH6, 1 GHZ-3 GHZ)	90
FIG.A.6.2.25	TRANSMITTER SPURIOUS EMISSION - RADIATED (802.11N-HT20, CH6, 3 GHZ-18 GHZ)	90
FIG.A.6.2.26	TRANSMITTER SPURIOUS EMISSION - RADIATED (POWER): 802.11N-HT20, CH11, 2.45 GHZ - 2.50GHZ	91
FIG.A.6.2.27	TRANSMITTER SPURIOUS EMISSION - RADIATED (802.11N-HT20, CH11, 1 GHZ-3 GHZ)	91
FIG.A.6.2.28	TRANSMITTER SPURIOUS EMISSION - RADIATED (802.11N-HT20, CH11, 3 GHZ-18 GHZ)	91
A.7.	TRANSMITTER SPURIOUS EMISSION - RADIATED < 30MHZ.....	92
FIG.A.7.1	TRANSMITTER SPURIOUS EMISSION - RADIATED (802.11B, 9 KHZ ~30 MHZ)	92
A.8.	AC POWERLINE CONDUCTED EMISSION	93
FIG.A.8.1	AC POWERLINE CONDUCTED EMISSION-802.11B.....	94
FIG.A.8.2	AC POWERLINE CONDUCTED EMISSION-IDLE.....	95

1. TEST LABORATORY

1.1. Testing Location

Company Name: TMC Beijing, Telecommunication Metrology Center of MIIT
Address: Shouxiang Science Building, No 51, Xueyuan Road, Haidian District,
Beijing, P.R.China
Postal Code: 100191
Telephone: 00861062304633
Fax: 00861062304633-2504

1.2. Project Data

Testing Start Date: 2014-09-05
Testing End Date: 2014-09-28

1.3. Signature

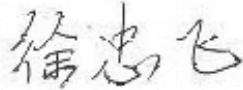

Xu Zhongfei

(Prepared this test report)

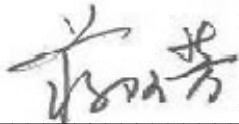

Jiang Afang

(Reviewed this test report)



Xiao Li

Deputy Director of the laboratory
(Approved this test report)

2. CLIENT INFORMATION

2.1. Applicant Information

Company Name: TCL Communication Ltd.
Address /Post: 12F/B, TCL Tower, Gaoxin Nanyi Road, Nanshan District, Shenzhen,
Guangdong,P.R. China
Contact Lv Meixian
Email meixian.lv@tcl.com
Telephone: 0086-755 33956929
Fax: 0086-755 36645072

2.2. Manufacturer Information

Company Name: TCL Communication Ltd.
Address /Post: 12F/B, TCL Tower, Gaoxin Nanyi Road, Nanshan District, Shenzhen,
Guangdong,P.R. China
Contact Lv Meixian
Email meixian.lv@tcl.com
Telephone: 0086-755 33956929
Fax: 0086-755 36645072

3. EQUIPMENT UNDER TEST(EUT) AND ANCILLARY

EQUIPMENT(AE)

3.1. About EUT

Description	CDMA 1X/EVDO tri-band mobile phone
Model Name	4037V
FCC ID	2ACCJB001
IC ID	/
With WLAN Function	Yes
Frequency Range	ISM 2400MHz~2483.5MHz
Type of Modulation	DSSS/CCK/OFDM
Number of Channels	11
Antenna	Integral Antenna
MAX Conducted Power	24.94dBm(CCK)
GPRS Class	/
GPRS operation mode	/
Power Supply	3.7V DC by Battery

3.2. Internal Identification of EUT Used During the Test

EUT ID*	MEID	HW Version	SW Version
EUT1	A100003BCFECE1	VC	V5HT3-5
EUT2	A100003BCFECEB	VC	V5HT3-5

*EUT ID: is used to identify the test sample in the lab internally.

3.3. Internal Identification of AE Used During the Test

AE ID*	Description	Type	SN
AE1	Battery	TLi014A1	/

*AE ID: is used to identify the test sample in the lab internally.

3.4. General Description

Equipment Under Test (EUT) is a model of CDMA 1X/EVDO tri-band mobile phone with integrated antenna. It consists of normal options: Battery and Charger.

Manual and specifications of the EUT were provided to fulfil the test.

Samples undergoing test were selected by the Client.

4. Reference Documents

4.1. Documents supplied by applicant

EUT feature information is supplied by the applicant or manufacturer, which is the basis of testing.

4.2. REFERENCE DOCUMENTS FOR TESTING

The following documents listed in this section are referred for testing.

Reference	Title	Version
FCC Part15	FCC CFR 47, Part 15, Subpart C: 15.205 Restricted bands of operation; 15.209 Radiated emission limits, general requirements; 15.247 Operation within the bands 902-928MHz, 2400-2483.5 MHz, and 5725-5850 MHz.	2013
ANSI C63.10	Methods of Measurement of Radio-Noise Emissions from Low-Voltage Electrical and Electronic Equipment in the Range of 9 kHz to 40 GHz	2009

5. LABORATORY ENVIRONMENT

Conducted RF performance testing is performed in shielding room.

EMC performance testing is performed in Semi-anechoic chamber.

6. SUMMARY OF TEST RESULTS

6.1. Summary of Test Results

SUMMARY OF MEASUREMENT RESULTS	Sub-clause of Part15C	Sub-clause of IC	Verdict
Maximum Peak Output Power	15.247 (b)	/	P
Peak Power Spectral Density	15.247 (e)	/	P
Occupied 6dB Bandwidth	15.247 (a)	/	P
Band Edges Compliance	15.247 (d)	/	P
Transmitter Spurious Emission - Conducted	15.247 (d)	/	P
Transmitter Spurious Emission - Radiated	15.247, 15.205, 15.209	/	P
AC Powerline Conducted Emission	15.107, 15.207	/	P

Please refer to **ANNEX A** for detail.

Terms used in Verdict column

P	Pass, The EUT complies with the essential requirements in the standard.
NP	Not Perform, The test was not performed by TMC
NA	Not Applicable, The test was not applicable
F	Fail, The EUT does not comply with the essential requirements in the standard

6.2. Statements

TMC has evaluated the test cases requested by the client/manufacturer as listed in section 6.1 of this report for the EUT specified in section 3 according to the standards or reference documents listed in section 4.1.

This report only deals with the WLAN function among the features described in section 3.

6.3. Test Conditions

For this report, all the test cases are tested under normal temperature and normal voltage, and also under norm humidity, the specific condition is shown as follows:

Temperature	26°C
Voltage	3.7V (By battery)

7. TEST EQUIPMENTS UTILIZED

Conducted test system

No.	Equipment	Model	Serial Number	Manufacturer	Calibration date	Calibration Due date
1	Vector Signal Analyzer	FSQ40	200089	Rohde & Schwarz	2014-07-08	2015-07-07
2	Test Receiver	ESS	847151/015	Rohde & Schwarz	2013-11-29	2014-11-28
3	LISN	ESH2-Z5	829991/012	Rohde & Schwarz	2014-4-15	2015-4-14
4	Shielding Room	S81	/	ETS-Lindgren	/	/

Radiated emission test system

No.	Equipment	Model	Serial Number	Manufacturer	Calibration date	Calibration Due date
1	Test Receiver	ESU26	100376	Rohde & Schwarz	2013-11-6	2014-11-5
2	BiLog Antenna	VULB9163	9163-514	Schwarzbeck	2011-11-11	2014-11-10
3	Dual-Ridge Waveguide Horn Antenna	3117	00119024	ETS-Lindgren	2012-4-20	2015-4-19
4	Dual-Ridge Waveguide Horn Antenna	3116	2661	EMCO	2012-7-1	2015-06-30
5	Loop antenna	HFH2-Z2	829324/007	Rohde & Schwarz	2011-12-21	2014-12-20
6	Semi-anechoic chamber	/	CT000332-1074	Frankonia German	/	/

ANNEX A: MEASUREMENT RESULTS

A.1. Measurement Method

A.1.1. Conducted Measurements

Connect the EUT to the test system as Fig.A.1.1.1 shows.

Set the EUT to the required work mode.

Set the EUT to the required channel.

Set the Vector Signal Analyzer and start measurement.

Record the values. Vector Signal Analyzer

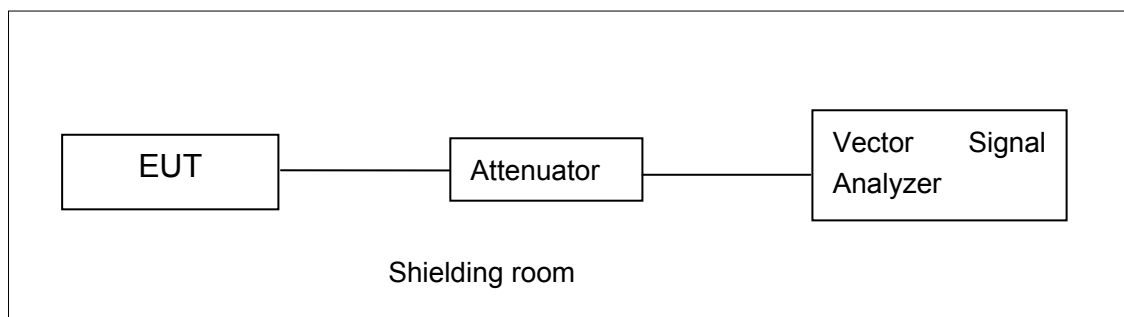

Fig.A.1.1.1: Test Setup Diagram for Conducted Measurements

A.1.2. Radiated Emission Measurements

In the case of radiated emission, the used settings are as follows,

Sweep frequency from 30 MHz to 1GHz, RBW = 100 kHz, VBW = 300 kHz;

Sweep frequency from 1 GHz to 26GHz, RBW = 1MHz, VBW = 10Hz;

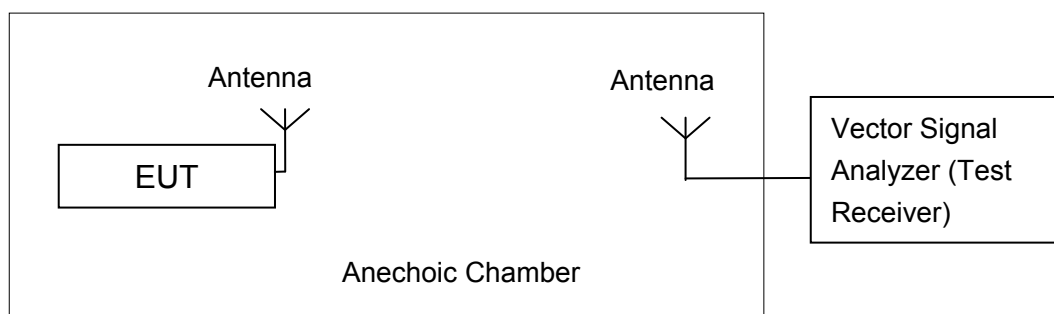

Fig.A.1.2.1: Test Setup Diagram for Radiated Measurements

A.2. Maximum Output Power

Measurement Limit and Method:

Standard	Limit (dBm)
FCC CRF Part 15.247(b)	< 30

Note: The Duty cycle of EUT is 98.9%, so all measurements of maximum conducted output power will be performed with the EUT transmitting continuously.

EUT ID: EUT2

A.2.1. Peak Output Power-conducted

Method of Measurement: See KDB558074 section 9.1.2.

Measurement Results:

802.11b/g mode

Mode	Data Rate (Mbps)	Test Result (dBm)		
		2412MHz (Ch1)	2437MHz (Ch6)	2462 MHz (Ch11)
802.11b	1	21.43	/	/
	2	21.62	/	/
	5.5	23.21	/	/
	11	24.63	24.86	24.94
802.11g	6	20.37	/	/
	9	20.42	/	/
	12	20.16	/	/
	18	20.15	/	/
	24	20.63	/	/
	36	20.61	/	/
	48	20.68	/	/
	54	20.77	21.09	21.13

The data rate 11Mbps and 54Mbps are selected as worse condition, and the following cases are performed with this condition.

802.11n-HT20 mode

Mode	Data Rate (Index)	Test Result (dBm)		
		2412MHz (Ch1)	2437MHz (Ch6)	2462 MHz (Ch11)
802.11n (20MHz)	MCS0	18.25	/	/
	MCS1	18.14	/	/
	MCS2	18.12	/	/
	MCS3	18.51	/	/
	MCS4	18.54	/	/
	MCS5	18.67	/	/
	MCS6	18.62	/	/
	MCS7	18.67	19.12	19.08

The data rate MCS7 is selected as worse condition, and the following cases are performed with this condition.

Conclusion: Pass

A.2.2. Average Output Power-conducted

Method of Measurement: See KDB558074 section 9.2.2.2.

802.11b/g mode

Mode	Test Result (dBm)		
	2412MHz (Ch1)	2437MHz (Ch6)	2462 MHz (Ch11)
802.11b	18.10	18.31	18.46
802.11g	11.86	12.21	12.16

802.11n-HT20 mode

Mode	Test Result (dBm)		
	2412MHz (Ch1)	2437MHz (Ch6)	2462 MHz (Ch11)
802.11n (20MHz)	9.73	10.21	10.01

Conclusion: Pass

Measurement Uncertainty:

Measurement Uncertainty	0.75dB
-------------------------	--------

A.3. Peak Power Spectral Density

Method of Measurement: See KDB558074 section 10.2.

Measurement Limit:

Standard	Limit
FCC CRF Part 15.247(e)	< 8 dBm/3 kHz

Modulation type and data rate tested:

802.11b	802.11g	802.11n-HT20
11Mbps(CCK)	54Mbps(OFDM)	MCS7(OFDM)

Measurement Results:

802.11b/g mode

Mode	Channel	Power Spectral Density (dBm/3 kHz)		Conclusion
802.11b	1	Fig.A.3.1	-4.92	P
	6	Fig.A.3.2	-4.61	P
	11	Fig.A.3.3	-4.22	P
802.11g	1	Fig.A.3.4	-13.41	P
	6	Fig.A.3.5	-12.62	P
	11	Fig.A.3.6	-11.88	P

802.11n-HT20 mode

Mode	Channel	Power Spectral Density (dBm/3 kHz)		Conclusion
802.11n (HT20)	1	Fig.A.3.7	-15.13	P
	6	Fig.A.3.8	-14.44	P
	11	Fig.A.3.9	-14.54	P

Conclusion: Pass

Measurement Uncertainty:

Measurement Uncertainty	0.75dB
-------------------------	--------

Test graphs as below:

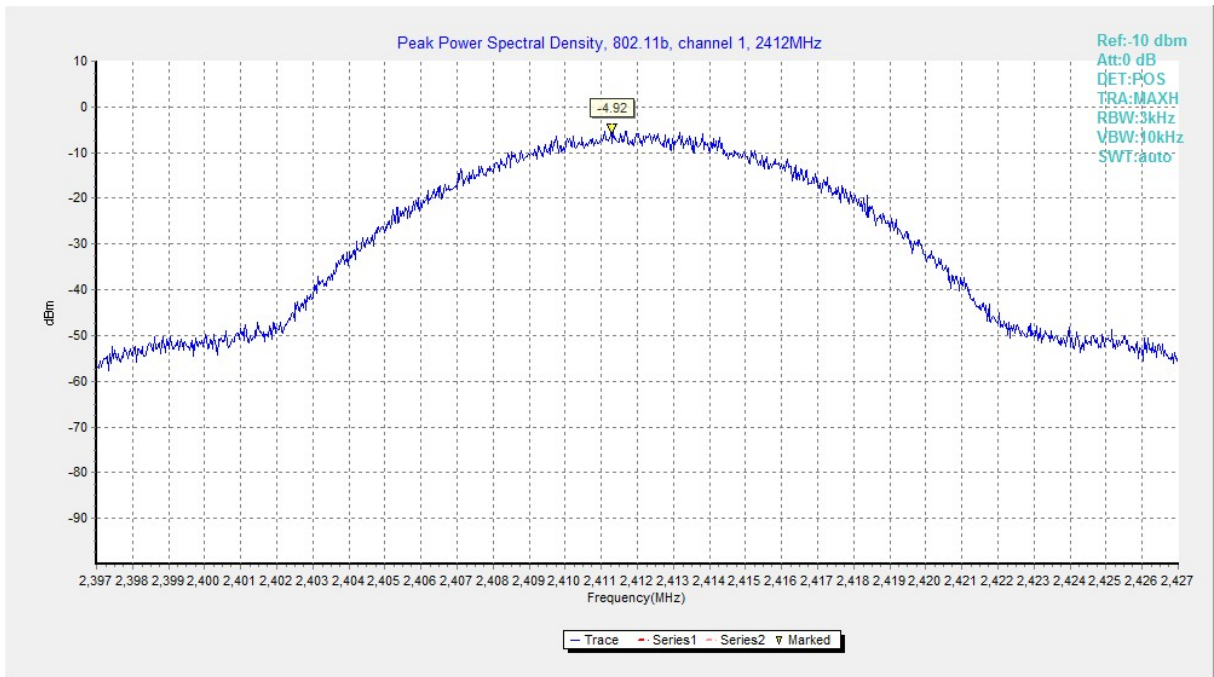

Fig.A.3.1 Power Spectral Density (802.11b, Ch 1)

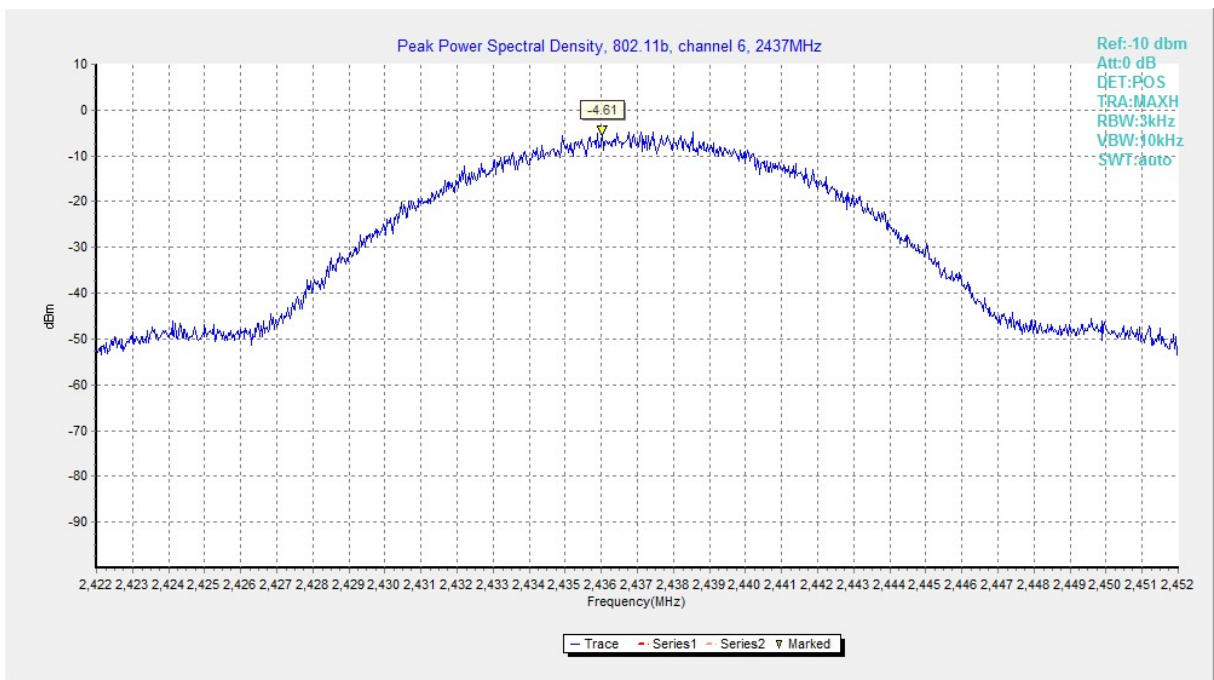

Fig.A.3.2 Power Spectral Density (802.11b, Ch 6)

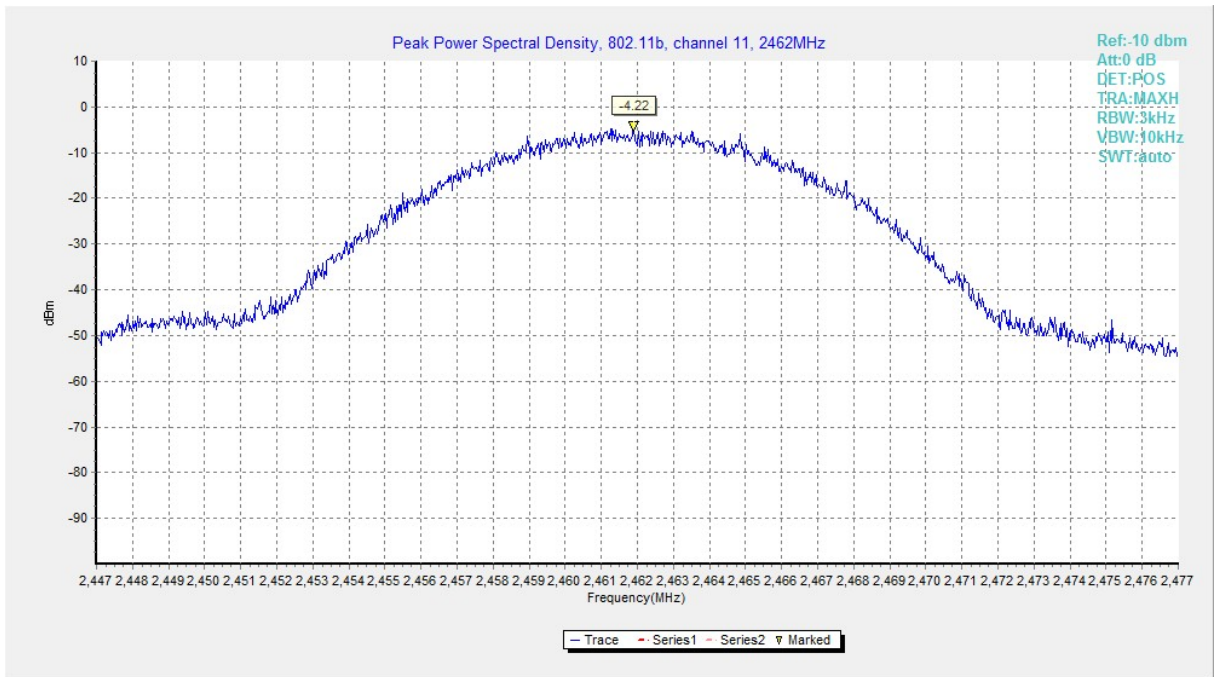

Fig.A.3.3 Power Spectral Density (802.11b, Ch 11)

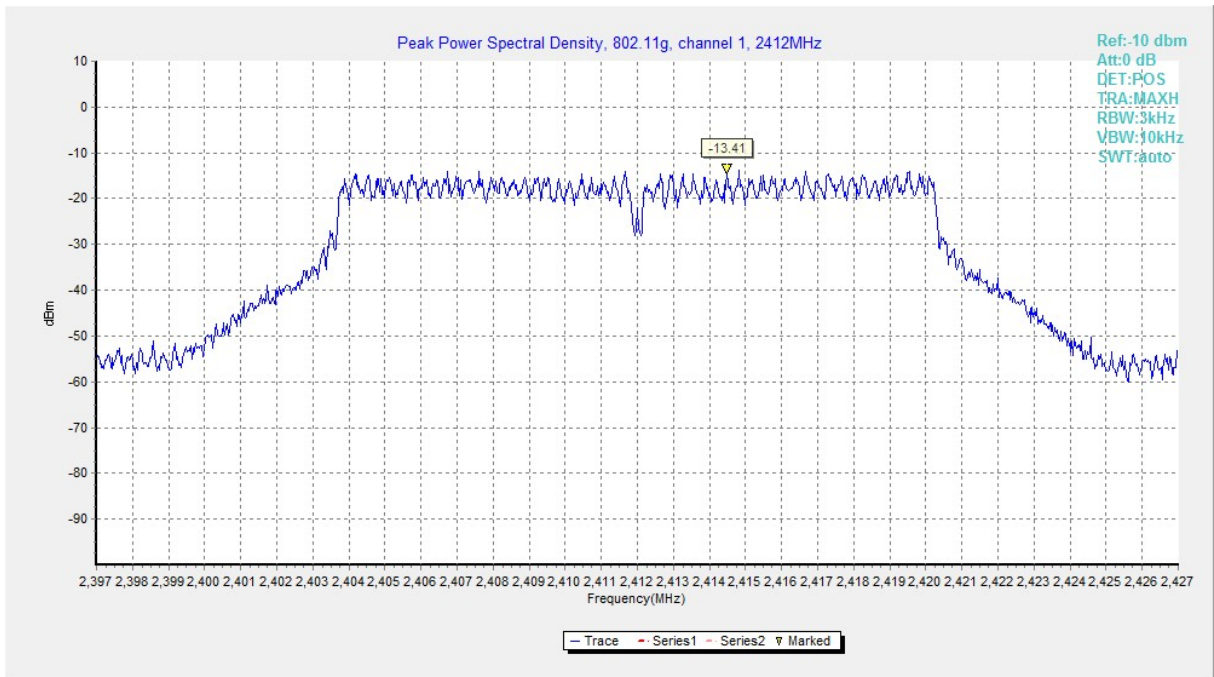

Fig.A.3.4 Power Spectral Density (802.11g, Ch 1)

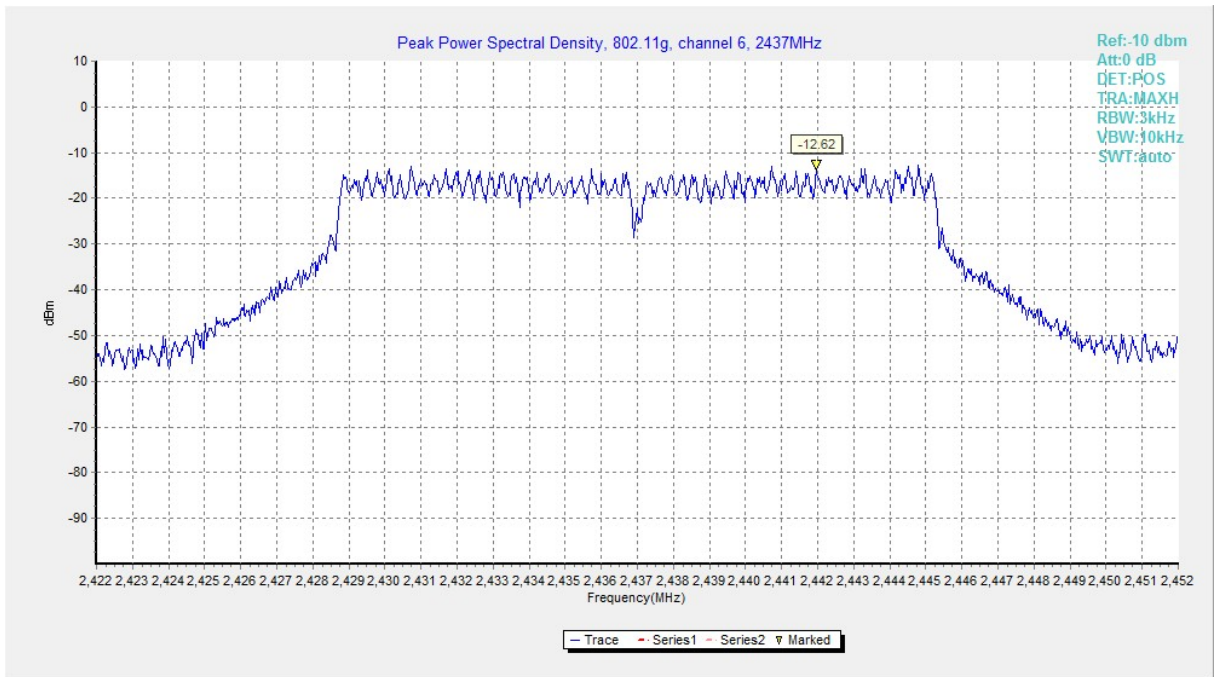

Fig.A.3.5 Power Spectral Density (802.11g, Ch 6)

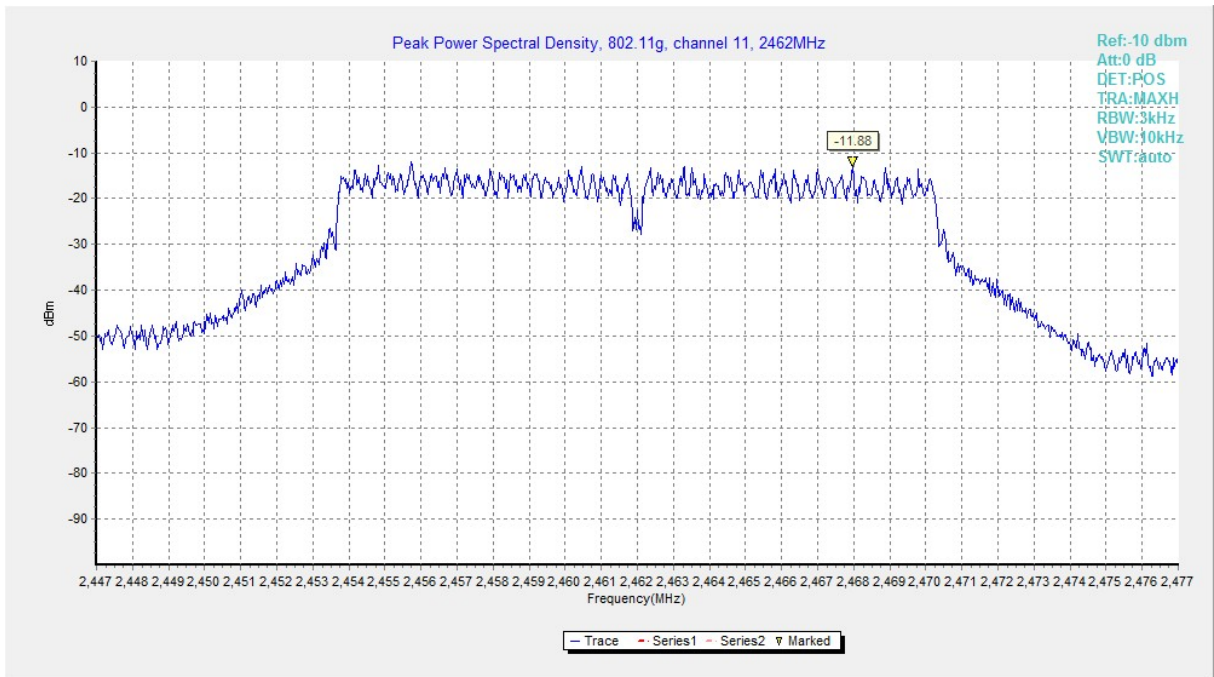

Fig.A.3.6 Power Spectral Density (802.11g, Ch 11)

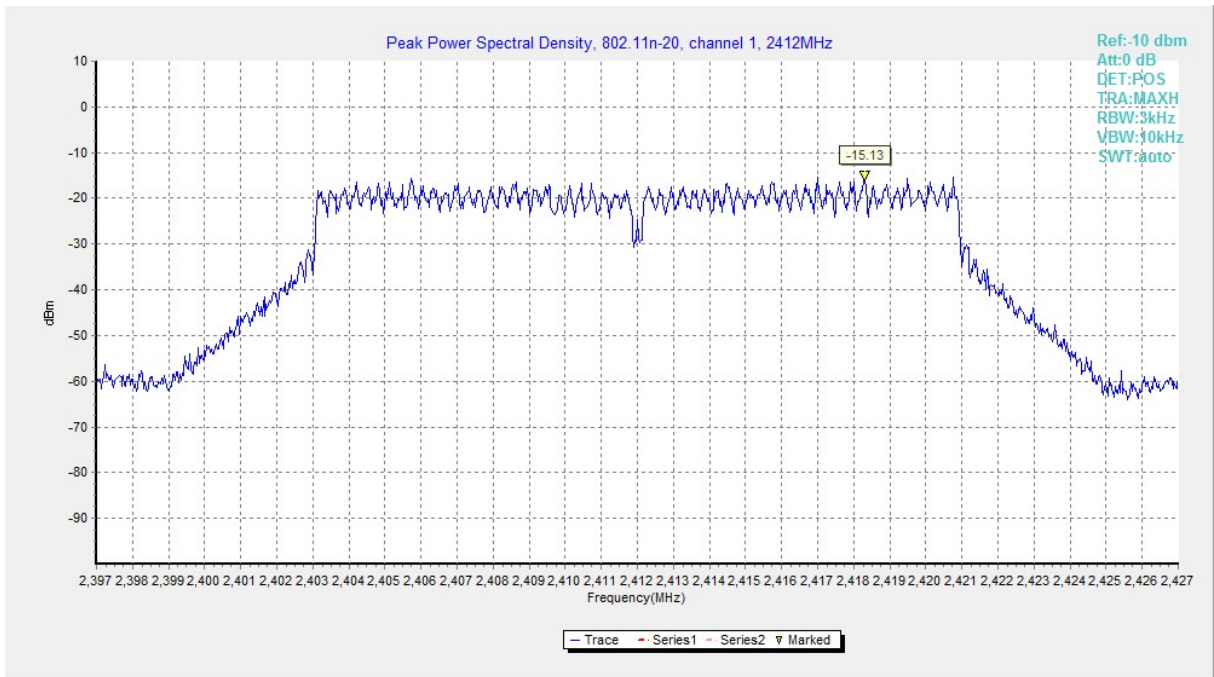

Fig.A.3.7 Power Spectral Density (802.11n-HT20, Ch 1)

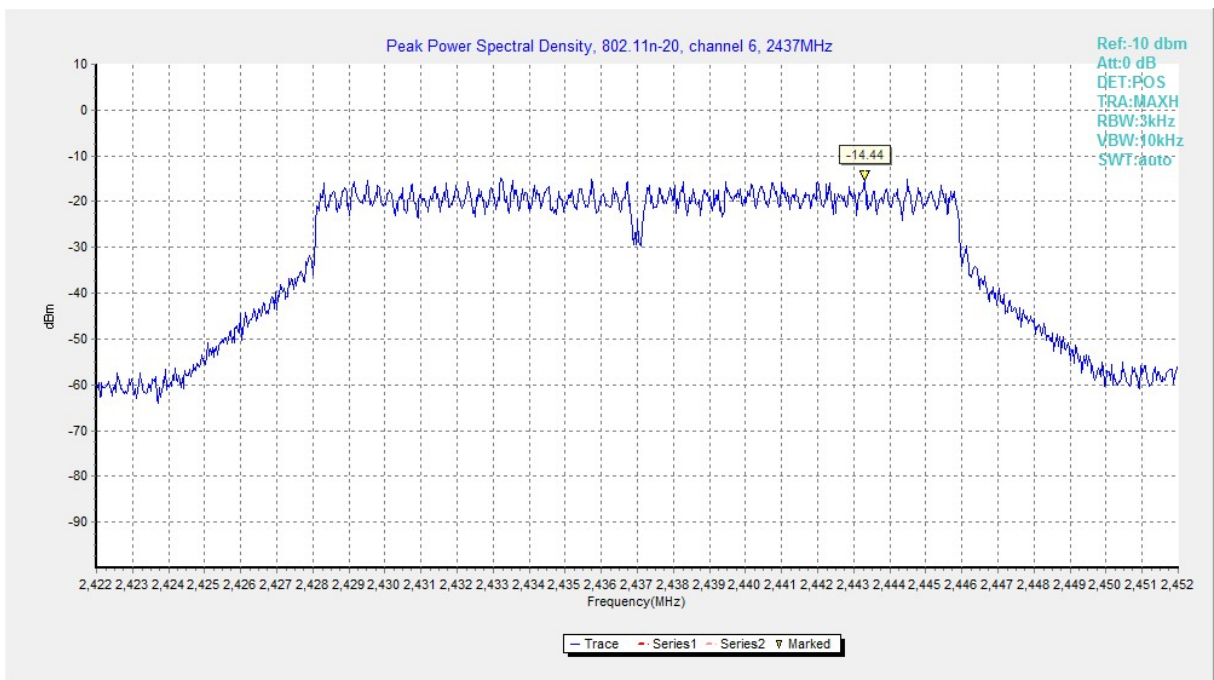

Fig.A.3.8 Power Spectral Density (802.11n-HT20, Ch 6)

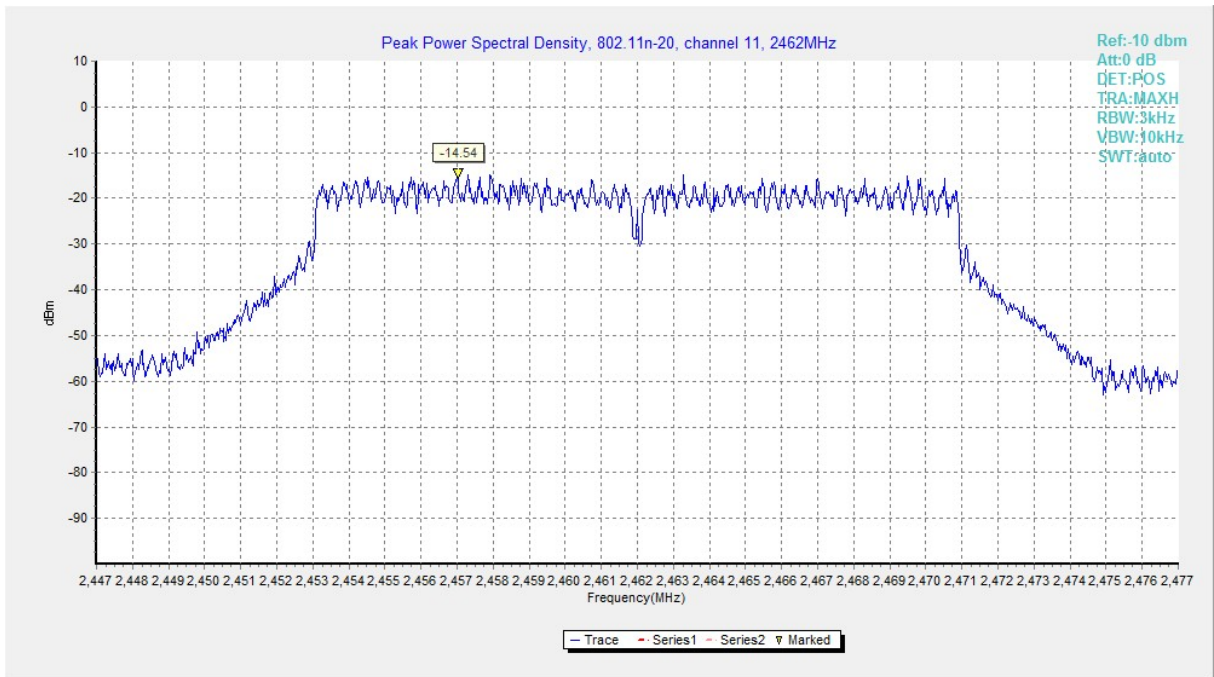

Fig.A.3.9 Power Spectral Density (802.11n-HT20, Ch 11)

A.4. DTS 6-dB Signal Bandwidth

Method of Measurement: See KDB558074 section 8.1 (Option 1).

Measurement Limit:

Standard	Limit (kHz)
FCC 47 CFR Part 15.247 (a)	≥ 500

EUT ID: EUT2

Modulation type and data rate tested:

802.11b	802.11g	802.11n-HT20
11Mbps(CCK)	54Mbps(OFDM)	MCS7(OFDM)

Measurement Result:

802.11b/g mode

Mode	Channel	Occupied 6dB Bandwidth (kHz)		conclusion
802.11b	1	Fig.A.4.1	7850	P
	6	Fig.A.4.2	7750	P
	11	Fig.A.4.3	7300	P
802.11g	1	Fig.A.4.4	16450	P
	6	Fig.A.4.5	16450	P
	11	Fig.A.4.6	16500	P

802.11n-HT20 mode

Mode	Channel	Occupied 6dB Bandwidth (kHz)		conclusion
802.11n (HT20)	1	Fig.A.4.7	17700	P
	6	Fig.A.4.8	17700	P
	11	Fig.A.4.9	17700	P

Conclusion: Pass

Measurement Uncertainty:

Measurement Uncertainty	60.80Hz
-------------------------	---------

Test graphs as below:

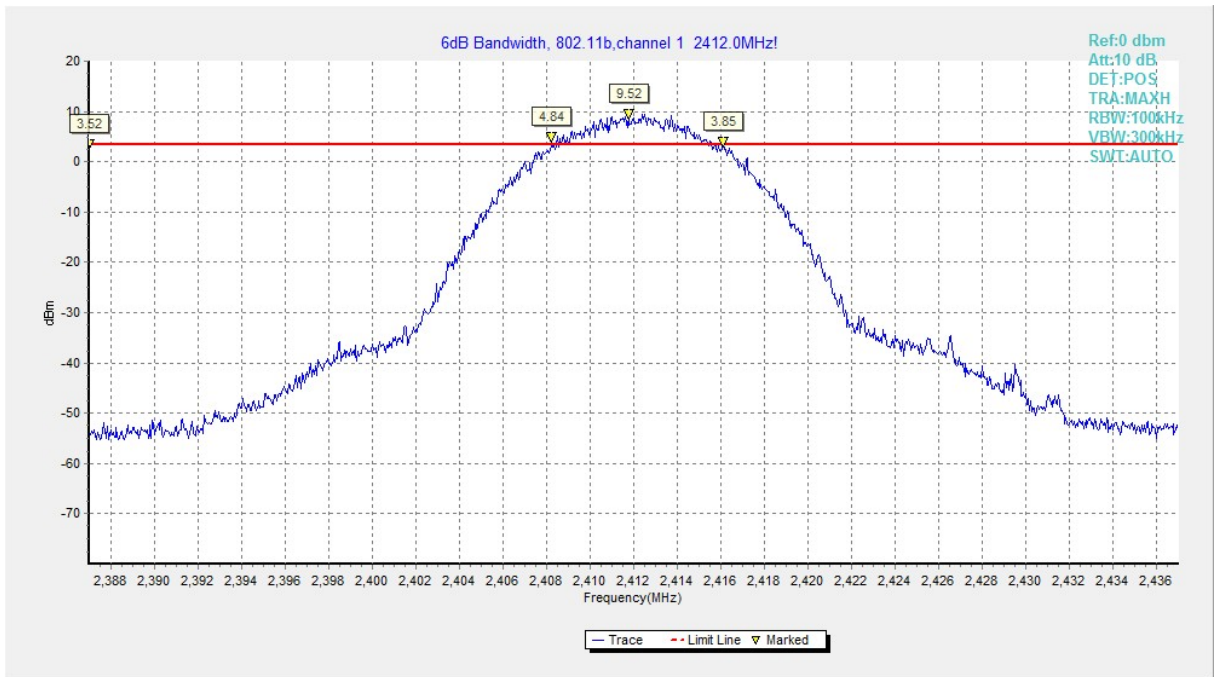

Fig.A.4.1 Occupied 6dB Bandwidth (802.11b, Ch 1)

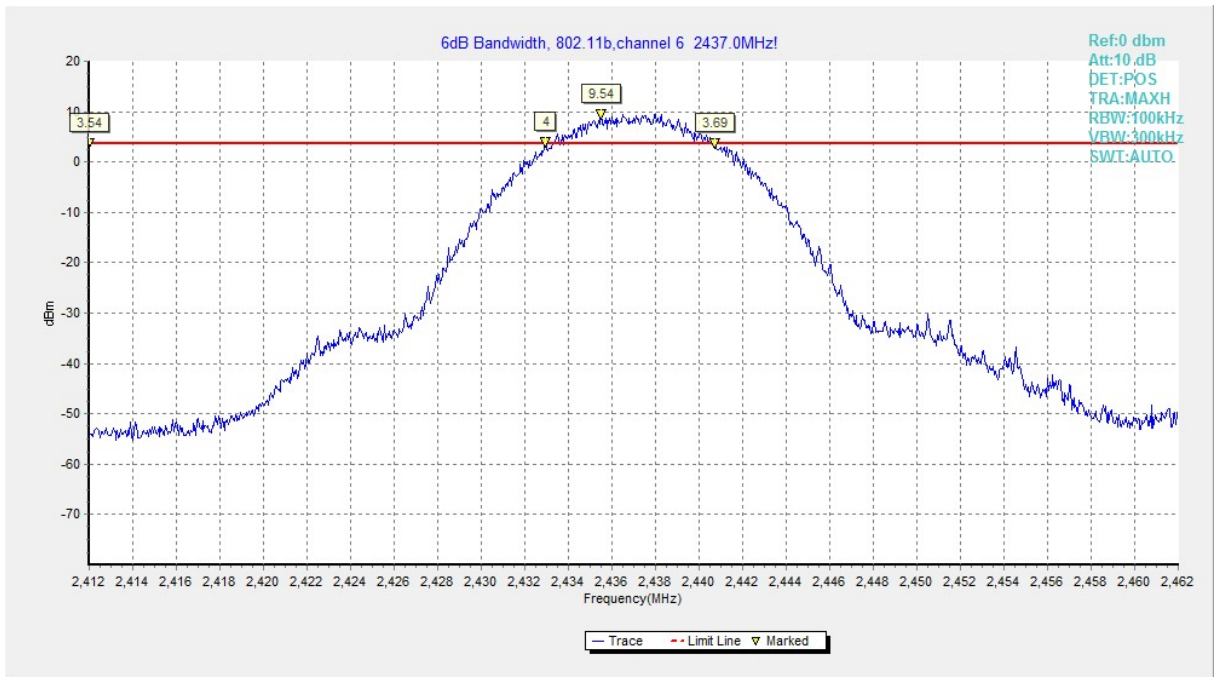

Fig.A.4.2 Occupied 6dB Bandwidth (802.11b, Ch 6)