



**FCC CFR47 PART 15 SUBPART C  
INDUSTRY CANADA RSS-247 ISSUE 1**

**BLUETOOTH LOW ENERGY  
CERTIFICATION TEST REPORT**

**FOR**

**BLE SMART MEASURE PRO**

**MODEL NUMBER: STHT77366**

**FCC ID: 2ACBG3000**

**IC ID: 11952A-3000**

**REPORT NUMBER: 15R21104-E1 REVISION A**

**ISSUE DATE: SEP 16, 2015**

*Prepared for*

**ikeGPS**

**1000 2<sup>nd</sup> Ave, Suite 1730**

**Seattle, WA 98104 U.S.A.**

*Prepared by*

**UL VERIFICATION SERVICES INC.**

**47173 BENICIA STREET**

**FREMONT, CA 94538, U.S.A.**

**TEL: (510) 771-1000**

**FAX: (510) 661-0888**



**NVLAP LAB CODE 200065-0**

Revision History

Rev.	Date	Revisions	Revised By
--	8/12/15	Initial Issue	P. ZHANG
A	9/16/15	Update 99% BW	P. ZHANG

## TABLE OF CONTENTS

<b>1. ATTESTATION OF TEST RESULTS .....</b>	<b>4</b>
<b>2. TEST METHODOLOGY .....</b>	<b>5</b>
<b>3. FACILITIES AND ACCREDITATION .....</b>	<b>5</b>
<b>4. CALIBRATION AND UNCERTAINTY .....</b>	<b>6</b>
4.1. <i>MEASURING INSTRUMENT CALIBRATION .....</i>	<i>6</i>
4.2. <i>SAMPLE CALCULATION .....</i>	<i>6</i>
4.3. <i>MEASUREMENT UNCERTAINTY.....</i>	<i>6</i>
<b>5. EQUIPMENT UNDER TEST .....</b>	<b>7</b>
5.1. <i>DESCRIPTION OF EUT .....</i>	<i>7</i>
5.2. <i>MAXIMUM OUTPUT POWER.....</i>	<i>7</i>
5.3. <i>DESCRIPTION OF AVAILABLE ANTENNAS .....</i>	<i>7</i>
5.4. <i>WORST-CASE CONFIGURATION AND MODE.....</i>	<i>8</i>
5.5. <i>DESCRIPTION OF TEST SETUP.....</i>	<i>9</i>
<b>6. TEST AND MEASUREMENT EQUIPMENT .....</b>	<b>12</b>
<b>7. SUMMARY .....</b>	<b>13</b>
<b>8. ANTENNA PORT TEST RESULTS .....</b>	<b>13</b>
8.1. <i>6 dB BANDWIDTH.....</i>	<i>14</i>
8.2. <i>99% BANDWIDTH.....</i>	<i>18</i>
8.3. <i>OUTPUT POWER.....</i>	<i>22</i>
8.4. <i>AVERAGE POWER.....</i>	<i>26</i>
8.5. <i>POWER SPECTRAL DENSITY .....</i>	<i>27</i>
8.6. <i>CONDUCTED SPURIOUS EMISSIONS.....</i>	<i>31</i>
<b>9. RADIATED TEST RESULTS.....</b>	<b>38</b>
9.1. <i>LIMITS AND PROCEDURE.....</i>	<i>38</i>
9.2. <i>TRANSMITTER ABOVE 1 GHz.....</i>	<i>39</i>
9.3. <i>WORST-CASE BELOW 1 GHz.....</i>	<i>52</i>
<b>10. AC POWER LINE CONDUCTED EMISSIONS .....</b>	<b>55</b>
<b>11. SETUP PHOTOS .....</b>	<b>60</b>

# 1. ATTESTATION OF TEST RESULTS

**COMPANY NAME:** ikeGPS  
**EUT DESCRIPTION:** BLE SMART MEASURE PRO  
**MODEL:** STHT77366  
**SERIAL NUMBER:** 2175294 (Conducted) ; 2175293 (Radiated)  
**DATE TESTED:** JULY 30 –AUGUST 10, 2015

APPLICABLE STANDARDS	
STANDARD	TEST RESULTS
CFR 47 Part 15 Subpart C	Pass
INDUSTRY CANADA RSS-247 ISSUE 1	Pass
INDUSTRY CANADA RSS-GEN ISSUE 4	Pass

UL Verification Services Inc. tested the above equipment in accordance with the requirements set forth in the above standards. All indications of Pass/Fail in this report are opinions expressed by UL Verification Services Inc. based on interpretations and/or observations of test results. Measurement Uncertainties were not taken into account and are published for informational purposes only. The test results show that the equipment tested is capable of demonstrating compliance with the requirements as documented in this report.

**Note:** The results documented in this report apply only to the tested sample, under the conditions and modes of operation as described herein. This document may not be altered or revised in any way unless done so by UL Verification Services Inc. and all revisions are duly noted in the revisions section. Any alteration of this document not carried out by UL Verification Services Inc. will constitute fraud and shall nullify the document. This report must not be used by the client to claim product certification, approval, or endorsement by NVLAP, NIST, any agency of the Federal Government, or any agency of any government.

Approved & Released For  
UL Verification Services Inc. By:



PENG ZHANG  
CONSUMER TECHNOLOGY DIVISION  
PROJECT LEAD  
UL VERIFICATION SERVICES INC

Tested By:



CHARLES VERGONIO  
CONSUMER TECHNOLOGY DIVISION  
LAB ENGINEER  
UL VERIFICATION SERVICES INC

## 2. TEST METHODOLOGY

The tests documented in this report were performed in accordance with FCC CFR 47 Part 2, FCC CFR 47 Part 15, KDB 558074 D01 v03r03, ANSI C63.10-2009 for FCC and ANSI C63.10-2013 for IC, RSS-GEN Issue 4, and RSS-247 Issue 1.

### ANSI C63.10-2009 Deviation

Radiated spurious emission above 1GHz EUT height is 1.5m not 0.8m.

## 3. FACILITIES AND ACCREDITATION

The test sites and measurement facilities used to collect data are located at 47173 and 47266 Benicia Street, Fremont, California, USA. Line conducted emissions are measured only at the 47173 address. The following table identifies which facilities were utilized for radiated emission measurements documented in this report. Specific facilities are also identified in the test results sections.

47173 Benicia Street	47266 Benicia Street
<input checked="" type="checkbox"/> Chamber A(IC: 2324B-1)	<input type="checkbox"/> Chamber D(IC: 2324B-4)
<input checked="" type="checkbox"/> Chamber B(IC: 2324B-2)	<input type="checkbox"/> Chamber E(IC: 2324B-5)
<input type="checkbox"/> Chamber C(IC: 2324B-3)	<input type="checkbox"/> Chamber F(IC: 2324B-6)
	<input type="checkbox"/> Chamber G(IC: 2324B-7)
	<input type="checkbox"/> Chamber H(IC: 2324B-8)

UL Verification Services Inc. is accredited by NVLAP, Laboratory Code 200065-0. The full scope of accreditation can be viewed at <http://ts.nist.gov/standards/scopes/2000650.htm>.

## 4. CALIBRATION AND UNCERTAINTY

### 4.1. MEASURING INSTRUMENT CALIBRATION

The measuring equipment utilized to perform the tests documented in this report has been calibrated in accordance with the manufacturer's recommendations, and is traceable to recognized national standards.

### 4.2. SAMPLE CALCULATION

Where relevant, the following sample calculation is provided:

$$\text{Field Strength (dBuV/m)} = \text{Measured Voltage (dBuV)} + \text{Antenna Factor (dB/m)} + \text{Cable Loss (dB)} - \text{Preamp Gain (dB)}$$

$$36.5 \text{ dBuV} + 18.7 \text{ dB/m} + 0.6 \text{ dB} - 26.9 \text{ dB} = 28.9 \text{ dBuV/m}$$

### 4.3. MEASUREMENT UNCERTAINTY

Where relevant, the following measurement uncertainty levels have been estimated for tests performed on the apparatus:

PARAMETER	UNCERTAINTY
Conducted Disturbance, 0.15 to 30 MHz	3.52 dB
Radiated Disturbance, 30 to 18000 MHz	4.94 dB

Uncertainty figures are valid to a confidence level of 95%.

## 5. EQUIPMENT UNDER TEST

### 5.1. DESCRIPTION OF EUT

The EUT is a BLE Smart Measure Pro.

### 5.2. MAXIMUM OUTPUT POWER

The transmitter has a maximum peak conducted output power as follows:

Frequency Range (MHz)	Mode	Output Power (dBm)	Output Power (mW)
2402-2480	BLE	-10.91	0.08

### 5.3. DESCRIPTION OF AVAILABLE ANTENNAS

The radio utilizes an FPCB antenna, with a maximum gain of -5.9dBi.

## **5.4. WORST-CASE CONFIGURATION AND MODE**

Radiated emission and power line conducted emission were performed with the EUT set to transmit at the channel with highest output power as worst-case scenario.

The fundamental of the EUT was investigated in three orthogonal orientations X,Y,Z, it was determined that Y orientation was worst-case orientation; therefore, all final radiated testing was performed with the EUT in Y orientation.



## 5.5. DESCRIPTION OF TEST SETUP

### SUPPORT EQUIPMENT

Support Equipment List				
Description	Manufacturer	Model	Serial Number	FCC ID
LAPTOP	Lenovo	T430	N/A	N/A
LAPTOP CHARGER	Lenovo	N/A	N/A	N/A

### I/O CABLES

I/O Cable List						
Cable No	Port	# of identical ports	Connector Type	Cable Type	Cable Length (m)	Remarks
1	USB	1	USB Cable	Shielded	1m	N/A
2	Ethernet	1	RJ-45	Unshielded	1m	N/A

### TEST SETUP

EUT was set in the BLE mode to enable BLE communications.

**SETUP DIAGRAM FOR TESTS**

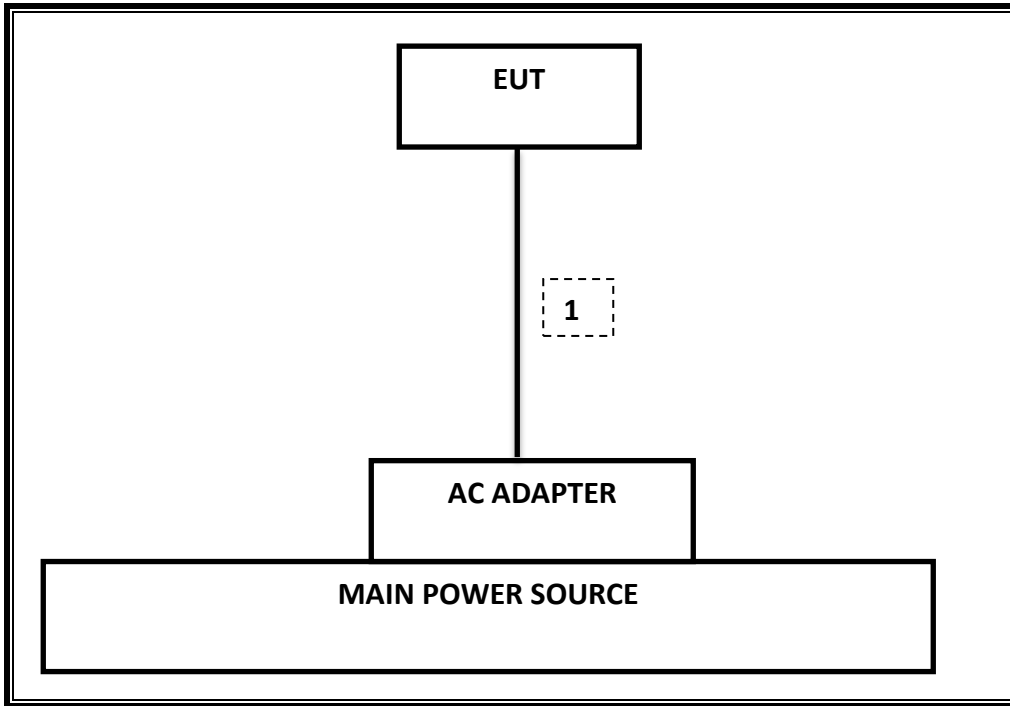

**SETUP DIAGRAM FOR AC LINE TESTS**

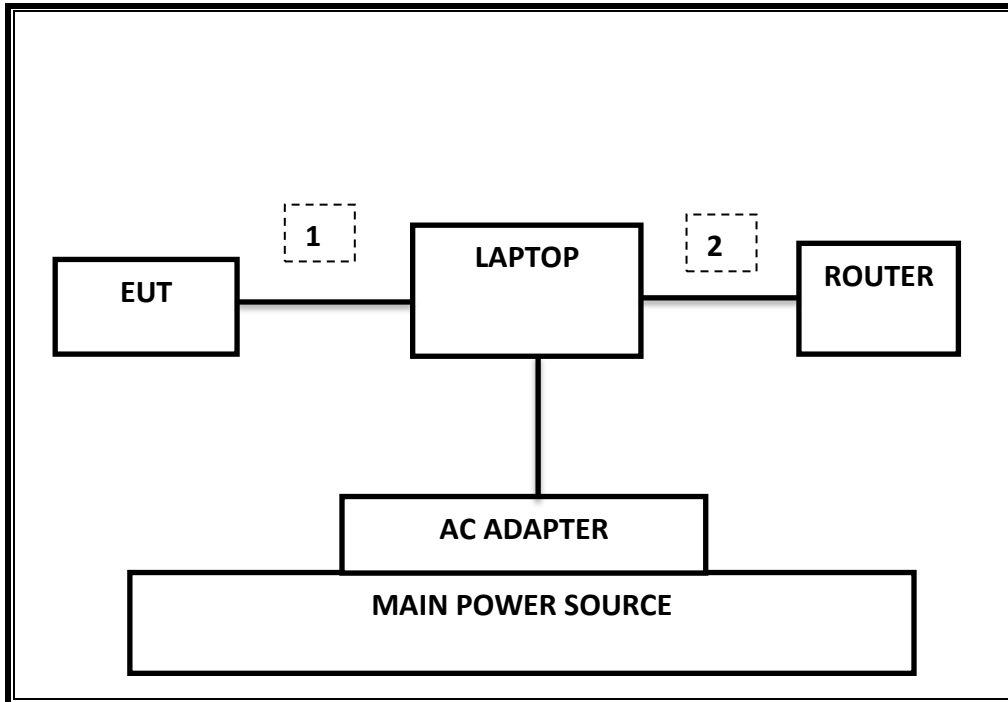

## 6. TEST AND MEASUREMENT EQUIPMENT

The following test and measurement equipment was utilized for the tests documented in this report:

Test Equipment List				
Description	Manufacturer	Model	Asset	Cal Due
Spectrum Analyzer, 44 GHz	Agilent / HP	E4446A	C01069	12/20/15
Spectrum Analyzer,9KHz-40GHz	HP	8564E	C00986	04/01/16
EMI Test Receiver, 9 kHz-7 GHz	R & S	ESCI 7	1000741	08/13/15
EMI Test Receiver, 30 MHz	R & S	ESHS 20	N02396	08/18/15
Peak Power Meter	Agilent / HP	E4416A	C00963	12/13/15
Peak / Average Power Sensor	Agilent / HP	E9327A	C00964	12/13/15
Antenna, Horn, 1-18 GHz	ETS	3117	C01022	02/21/16
Antenna, Horn,18- 26 GHz	ARA	MWH-1826/B	C00946	11/12/15
Antenna, Horn, 26-40 GHz	ARA	MWH-2640	C00891	06/28/16
Antenna, Bilog, 30MHz-1 GHz	Sunol Sciences	JB1	T243	03/06/16
RF Preamplifier, 1GHz - 18GHz	Miteq	NSP4000-SP2	924343	03/23/16
RF Preamplifier, 1GHz - 26.5GHz	HP	8449B	T404	06/29/16
AC Power Supply, 2,500VA 45-500Hz	Elgar-Ametek	CW2501M	F00013	CNR
RF Preamplifier, 1GHz - 40GHz	Miteq	NSP4000-SP2	C00990	08/20/15
Attenuator / Switch driver	HP	11713A	F00204	CNR
Low Pass Filter 5GHz	Micro-Tronics	LPS17541	F00219	05/23/16
High Pass Filter 6GHz	Micro-Tronics	HPS17542	F00222	05/22/16
High Pass Filter 3GHz	Micro-Tronics	HPM17543	F00224	05/22/16

Test Software List			
Description	Manufacturer	Model	Version
Radiated Software	UL	UL EMC	Version 9.5, 07/22/14
Conducted Software	UL	UL EMC	Version 9.5, 05/17/14
CLT Software	UL	UL RF	Version 1.0, 02/02/15
Antenna Port Software	UL	UL RF	Version 2.1.1.1, 1/20/15

## 7. SUMMARY

FCC Part Section	RSS Section(s)	Test Description	Test Limit	Test Condition	Test Result	Worst Case
15.247 (a)(2)	RSS-247 5.2 (1)	Occupied Band width (6dB)	>500KHz	Conducted	Pass	0.680 MHz
2.1051, 15.247 (d)	RSS-247 5.5	Band Edge / Conducted Spurious Emission	-20dBc		Pass	-31.102 dBm
15.247	RSS-247 5.4 (4)	TX conducted output power	<30dBm		Pass	-10.91dBm
15.247	RSS-247 5.2 (2)	PSD	<8dBm		Pass	-23.46dBm
15.207 (a)	RSS-GEN 8.8	AC Power Line conducted emissions	Section 10	Radiated	Pass	49.7dBuV(QP)
15.205, 15.209	RSS-GEN 8.9	Radiated Spurious Emission	< 54dBuV/m		Pass	51.08dBuV/m

## ANTENNA PORT TEST RESULTS

### 8.1. 6 dB BANDWIDTH

#### LIMITS

FCC §15.247 (a) (2)

IC RSS-247 5.2.1

The minimum 6 dB bandwidth shall be at least 500 kHz.

#### TEST PROCEDURE

The transmitter output is connected to a spectrum analyzer. The RBW is set to 100 kHz and the VBW is set to 300 kHz. The sweep time is coupled.

#### RESULTS

Channel	Frequency (MHz)	6 dB Bandwidth (MHz)	Minimum Limit (MHz)
Low	2402	0.681	0.5
Middle	2440	0.681	0.5
High	2480	0.680	0.5

**6 dB BANDWIDTH PLOTS**

**LOW CHANNEL**

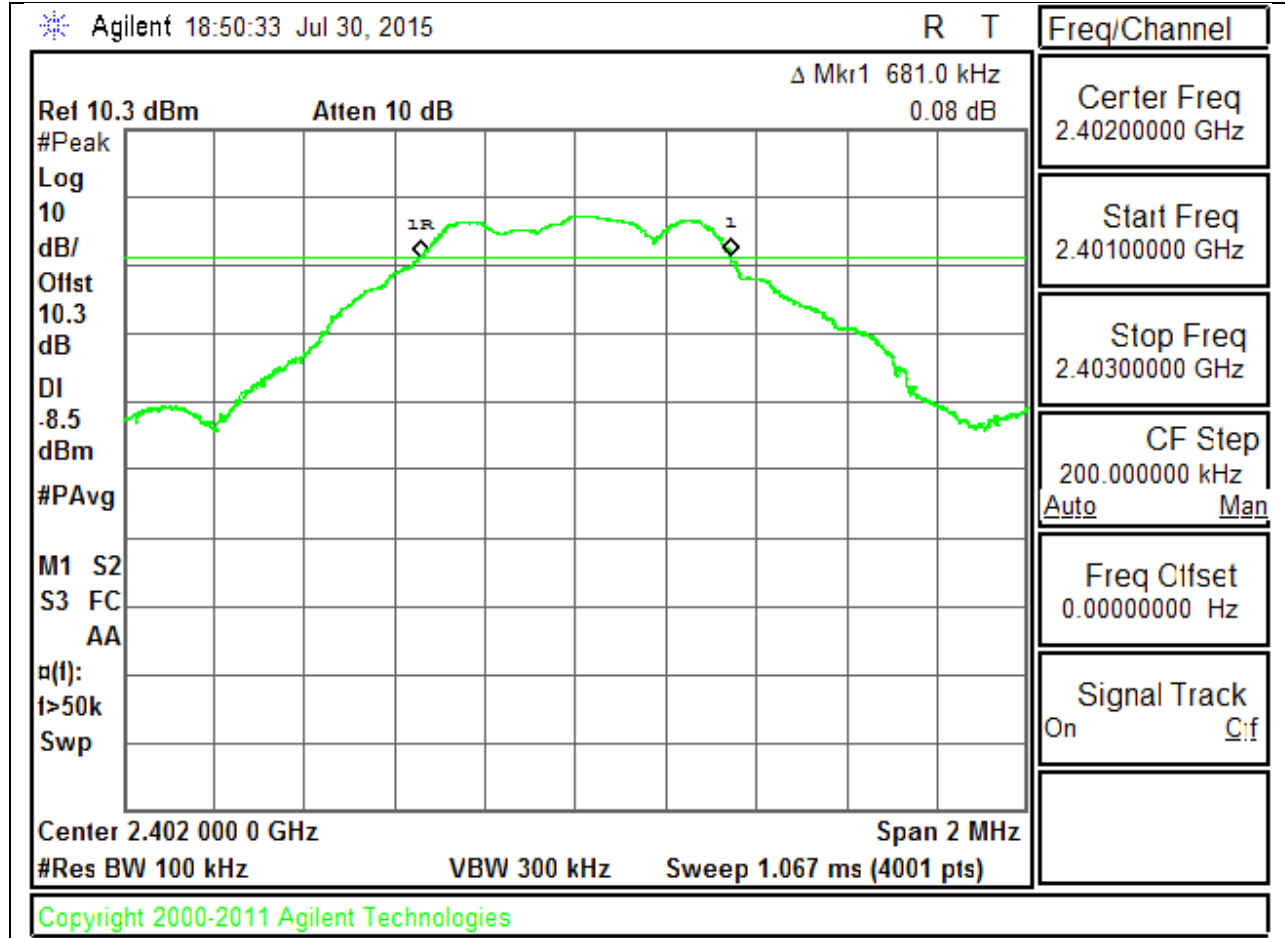

**MID CHANNEL**

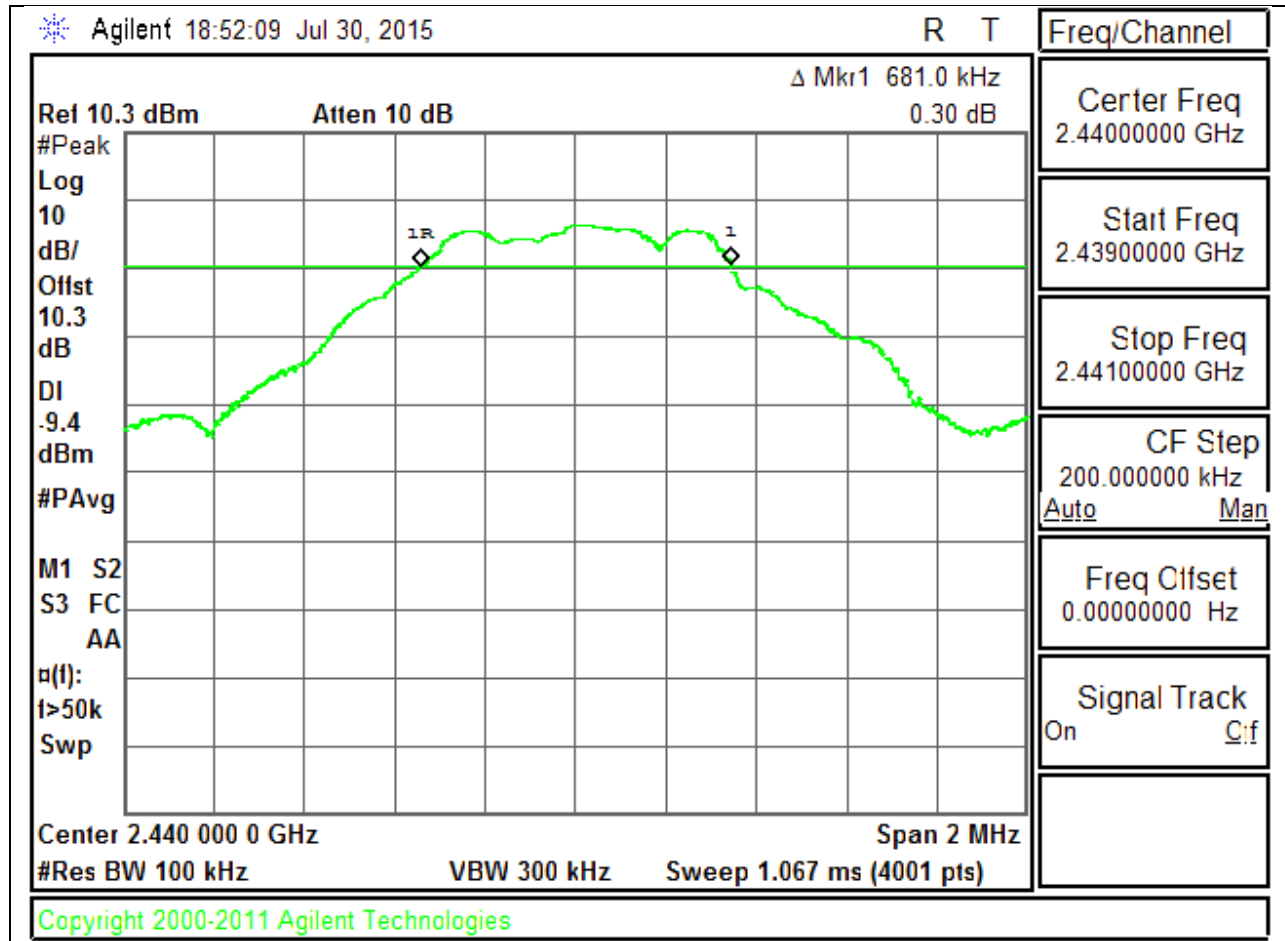



### HIGH CHANNEL

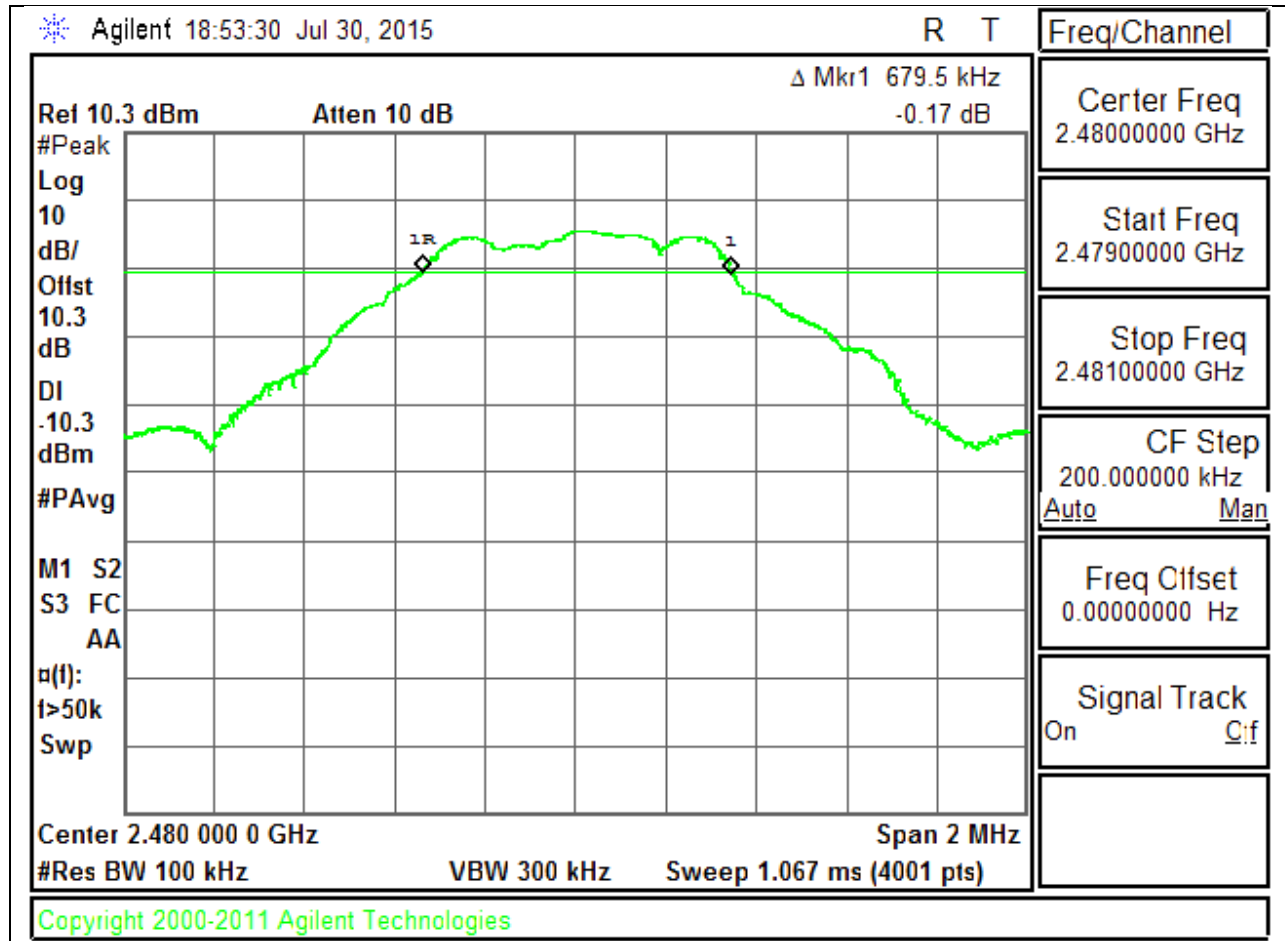

## 8.2. 99% BANDWIDTH

### LIMITS

None; for reporting purposes only.

### TEST PROCEDURE

Reference to KDB558074 D01 DTS Meas Guidance v03r03: The transmitter output is connected to the spectrum analyzer. The RBW is set to 1% to 3% of the 99 % bandwidth and to 1% of the span. The VBW is set to 3 times the RBW. The sweep time is coupled. The spectrum analyzer internal 99% bandwidth function is utilized.

### RESULTS

Channel	Frequency (MHz)	99% Bandwidth (MHz)
Low	2402	1.0088
Middle	2440	1.0150
High	2480	1.0076

**99% BANDWIDTH PLOTS**

**LOW CHANNEL**

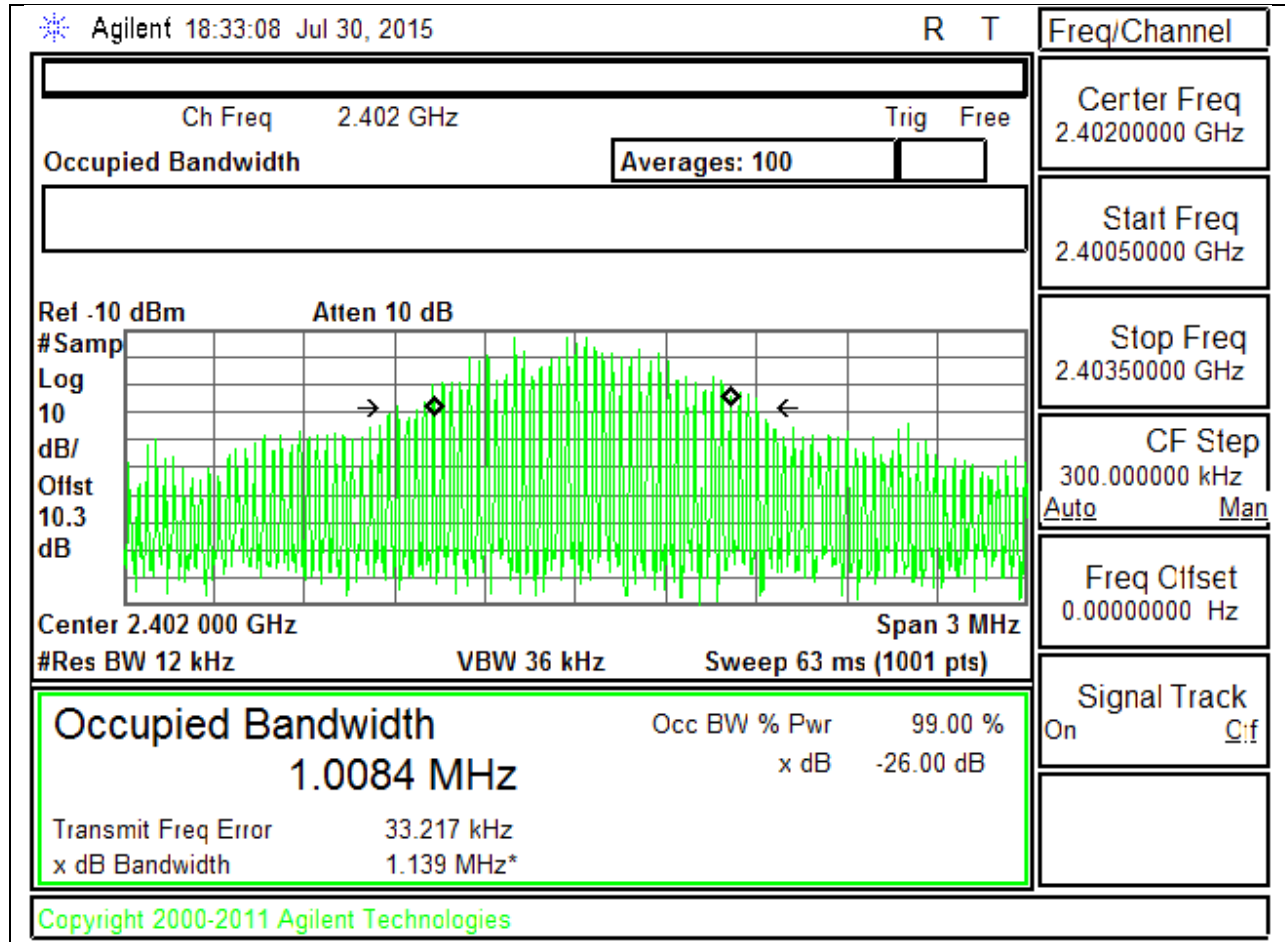

**MID CHANNEL**

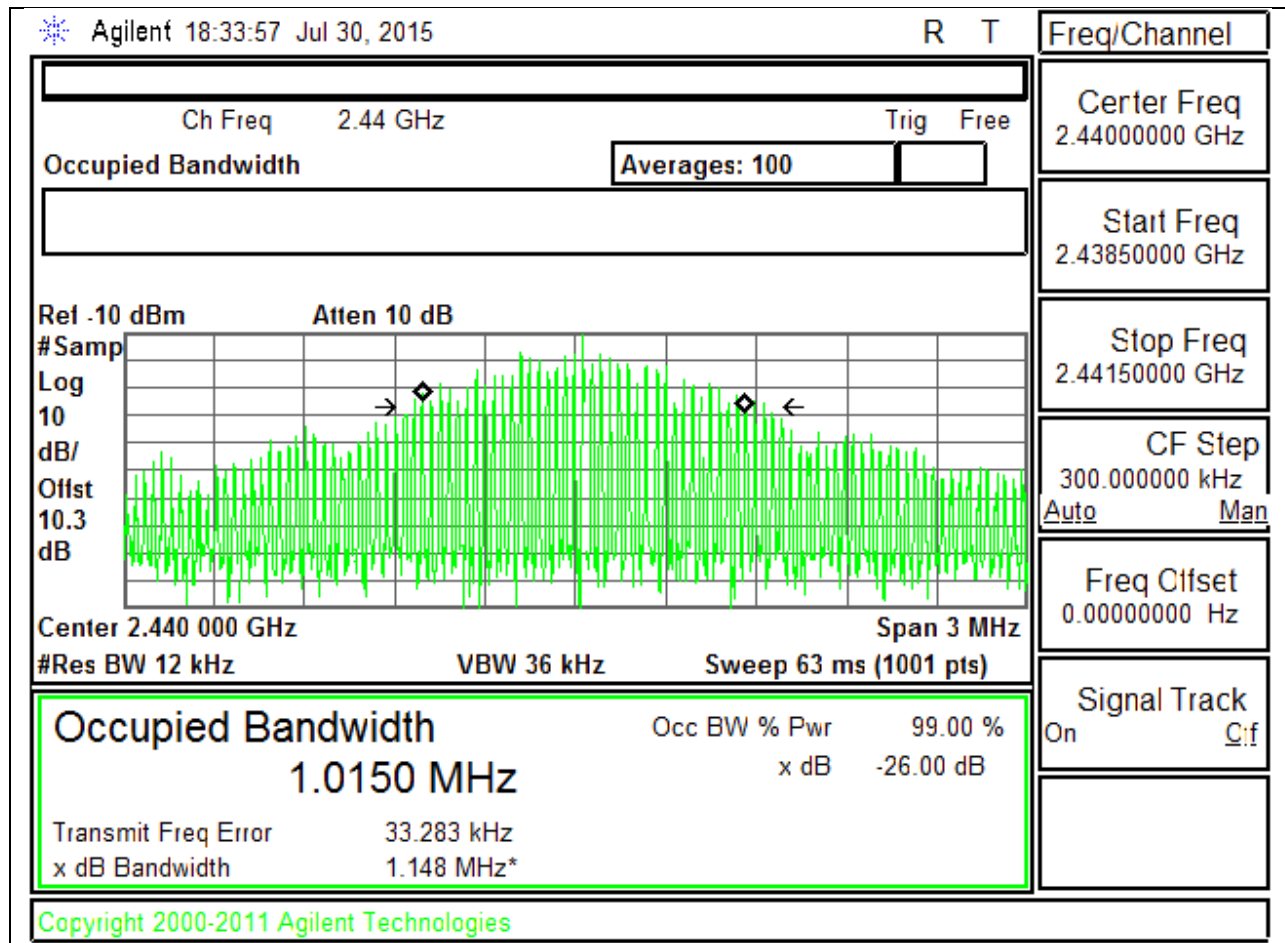

### HIGH CHANNEL

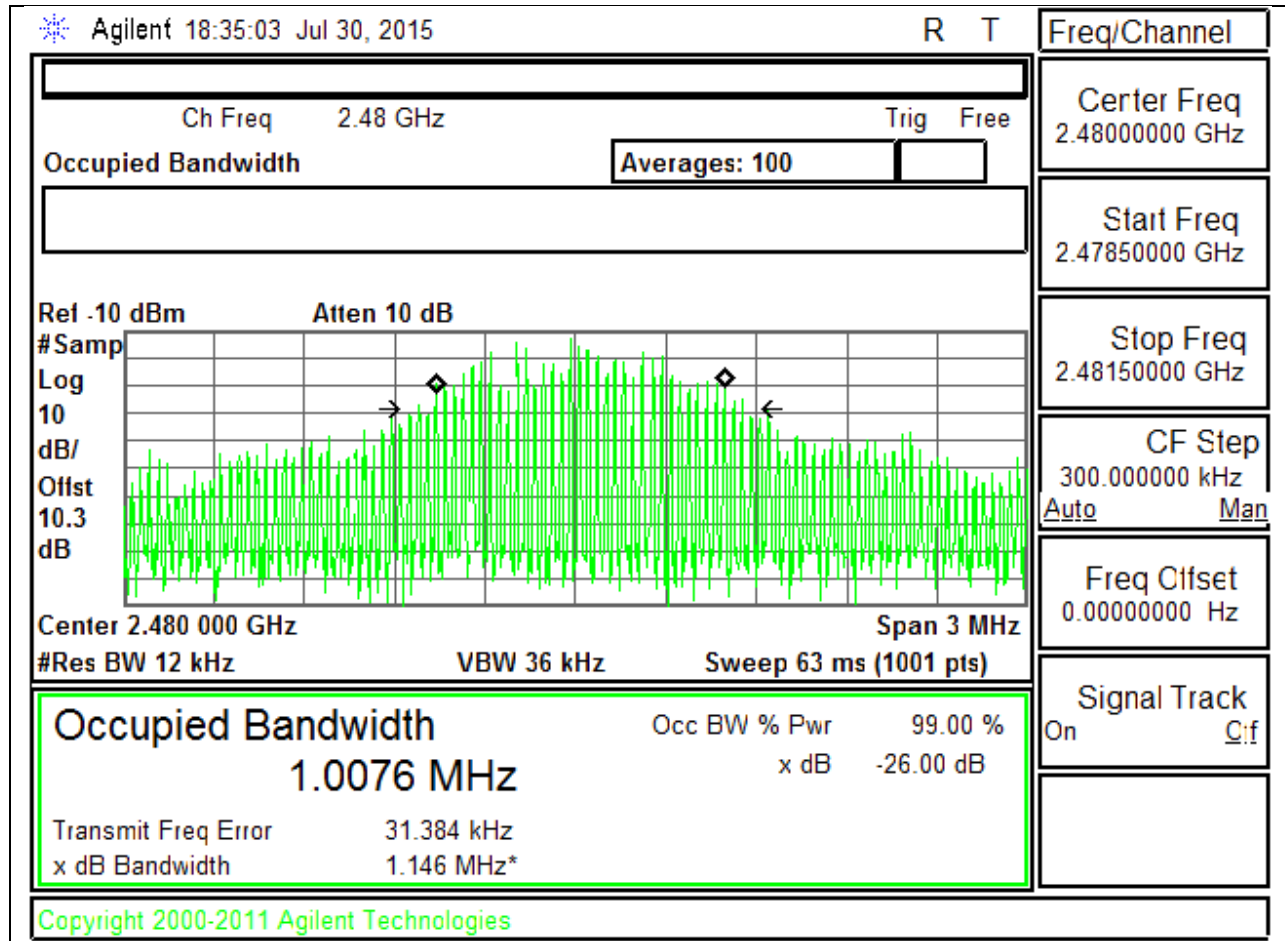

### 8.3. OUTPUT POWER

#### LIMITS

FCC §15.247 (b)

IC RSS-247 5.4.4

The maximum antenna gain is less than or equal to 6 dBi, therefore the limit is 30 dBm.

#### TEST PROCEDURE

Peak power is measured using KDB558074 D01 DTS Meas Guidance v03r03 utilizing spectrum analyzer.

#### RESULTS

Channel	Frequency (MHz)	Peak Power Reading (dBm)	Limit (dBm)	Margin (dB)
Low	2402	-10.91	30	-40.909
Middle	2440	-11.61	30	-41.614
High	2480	-12.50	30	-42.496



MID CHANNEL

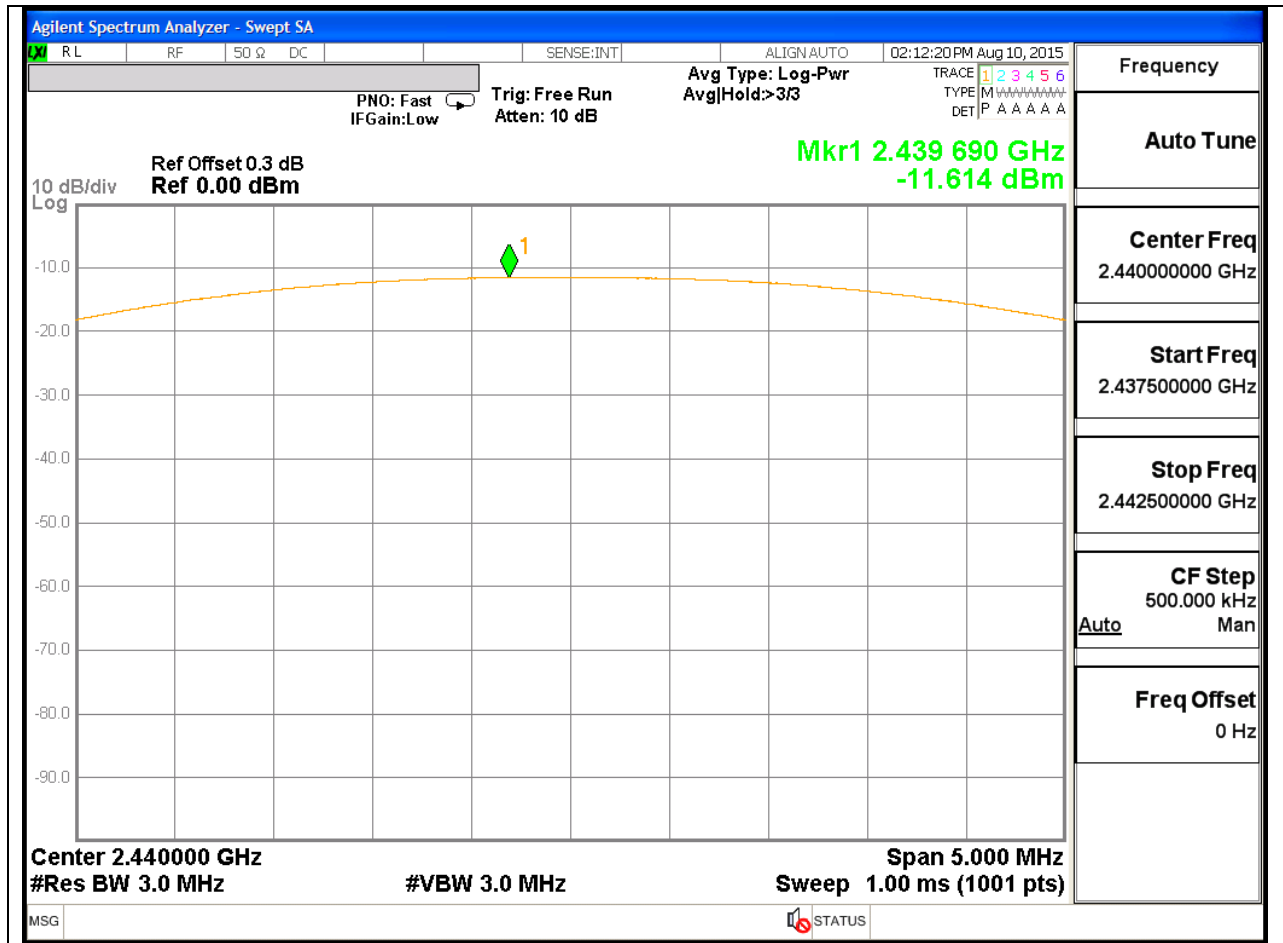



### HIGH CHANNEL

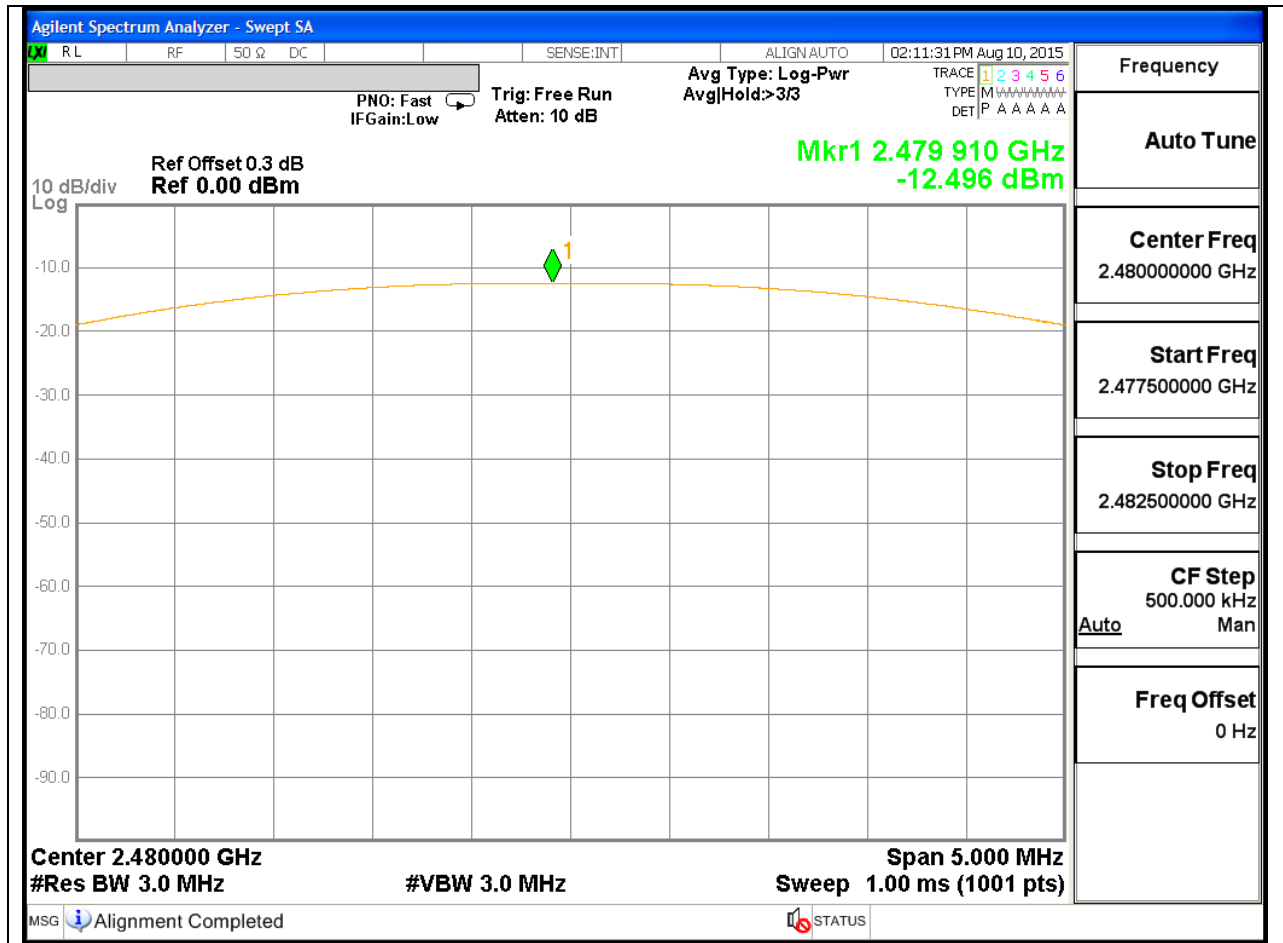

## 8.4. AVERAGE POWER

### LIMITS

None; for reporting purposes only.

### TEST PROCEDURE

The transmitter output is connected to a power meter.

### RESULTS

The cable assembly insertion loss of 0.3 dB (including 0.3dB cable) was entered as an offset in the power meter to allow for direct reading of power.

Channel	Frequency (MHz)	AV power (dBm)
Low	2402	-10.95
Middle	2440	-11.81
High	2480	-12.72

## 8.5. POWER SPECTRAL DENSITY

### LIMITS

FCC §15.247 (e)

IC RSS-247 5.2.2

The power spectral density conducted from the transmitter to the antenna shall not be greater than 8 dBm in any 3 kHz band during any time interval of continuous transmission.

### TEST PROCEDURE

Power Spectral Density was performed utilizing the "Method PKPSD (Peak PSD)" under KDB558074 D01 DTS Meas Guidance v03r03.

### RESULTS

Channel	Frequency (MHz)	PSD (dBm)	Limit (dBm)	Margin (dB)
Low	2402	-23.46	8	-31.46
Middle	2440	-24.61	8	-32.61
High	2480	-24.65	8	-32.65

**POWER SPECTRAL DENSITY PLOTS**

**LOW CHANNEL**

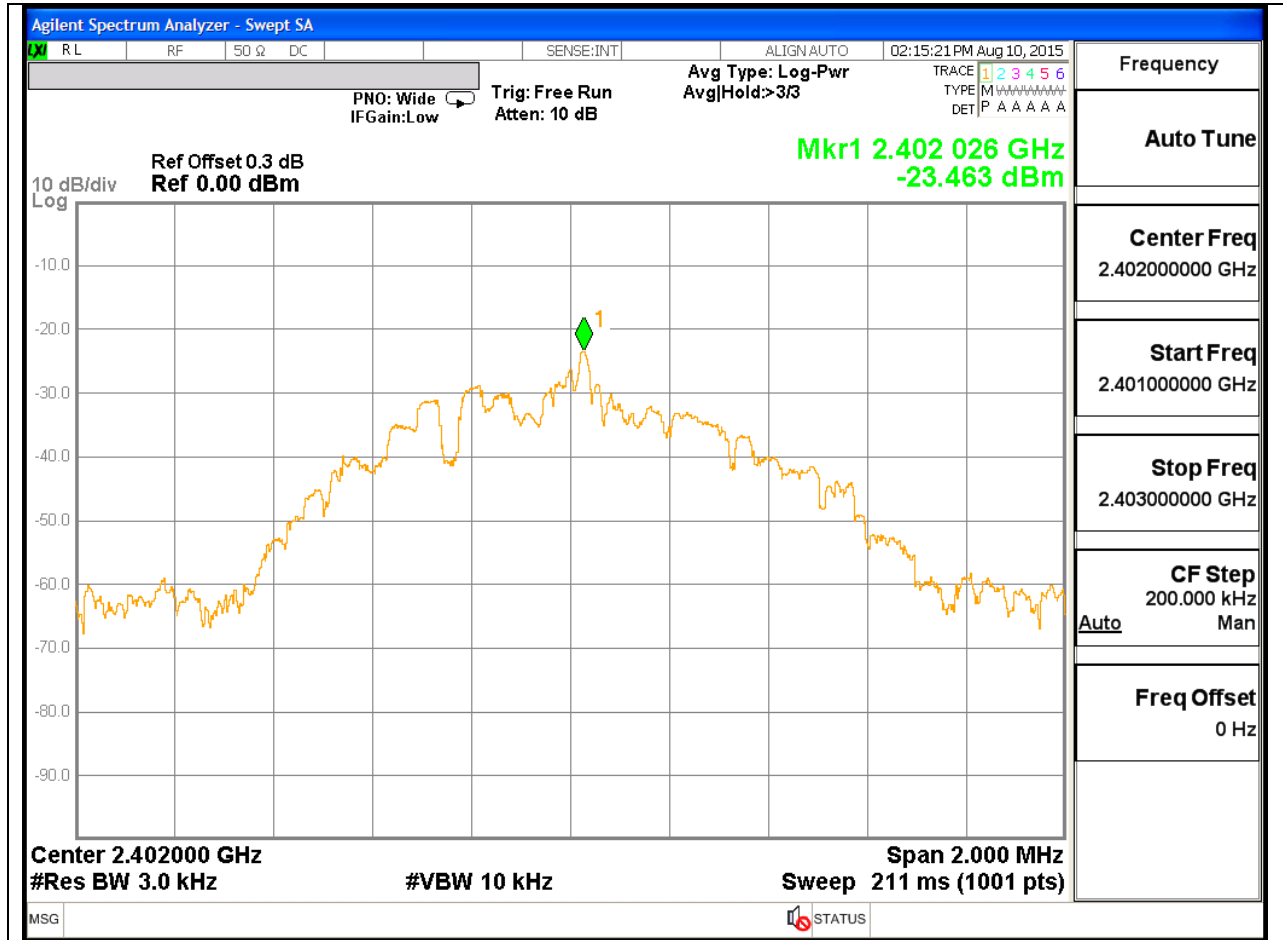

MID CHANNEL



### HIGH CHANNEL

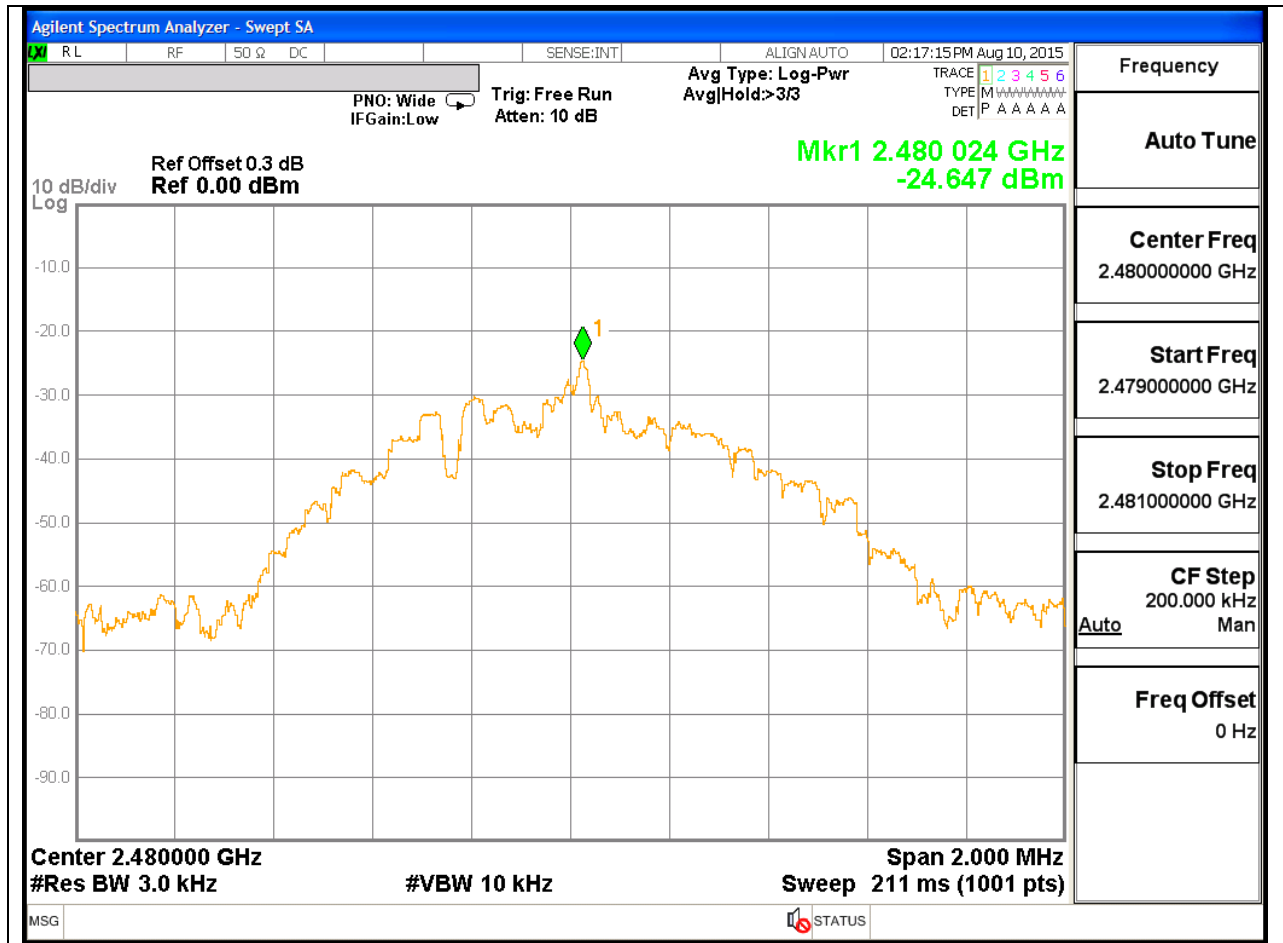

## **8.6. CONDUCTED SPURIOUS EMISSIONS**

### **LIMITS**

FCC §15.247 (d)

IC RSS-247 5.5

Output power was measured based on the use of a peak measurement, therefore the required attenuation is 20 dB.

### **TEST PROCEDURE**

The transmitter output is connected to a spectrum analyzer. The resolution bandwidth is set to 100 kHz. The video bandwidth is set to 300 kHz.

The spectrum from 30 MHz to 26 GHz is investigated with the transmitter set to the lowest, middle, and highest channels.

**RESULTS**

**SPURIOUS EMISSIONS, LOW CHANNEL**

**LOW CHANNEL BANDEDGE**

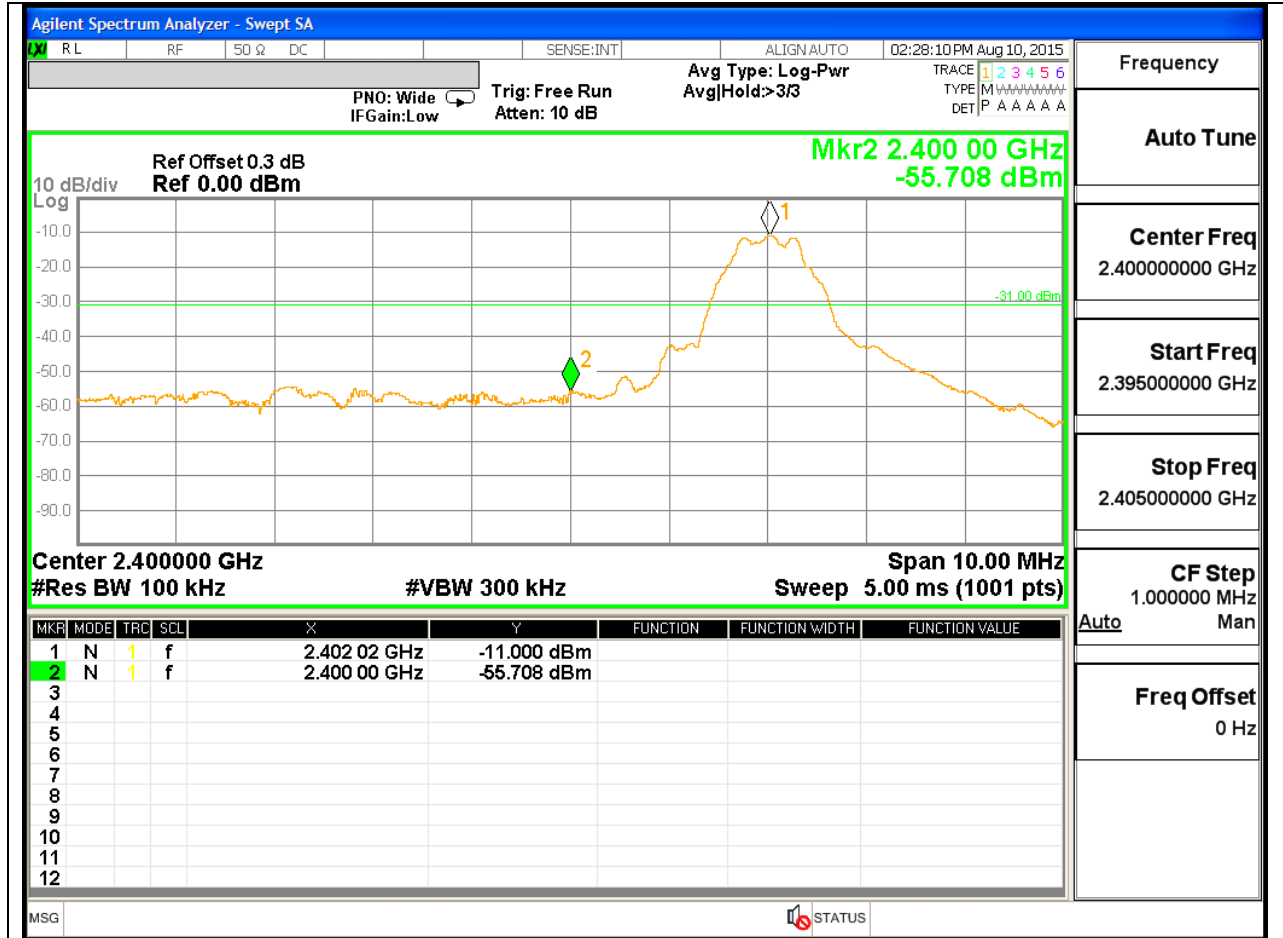



### LOW CHANNEL SPURIOUS

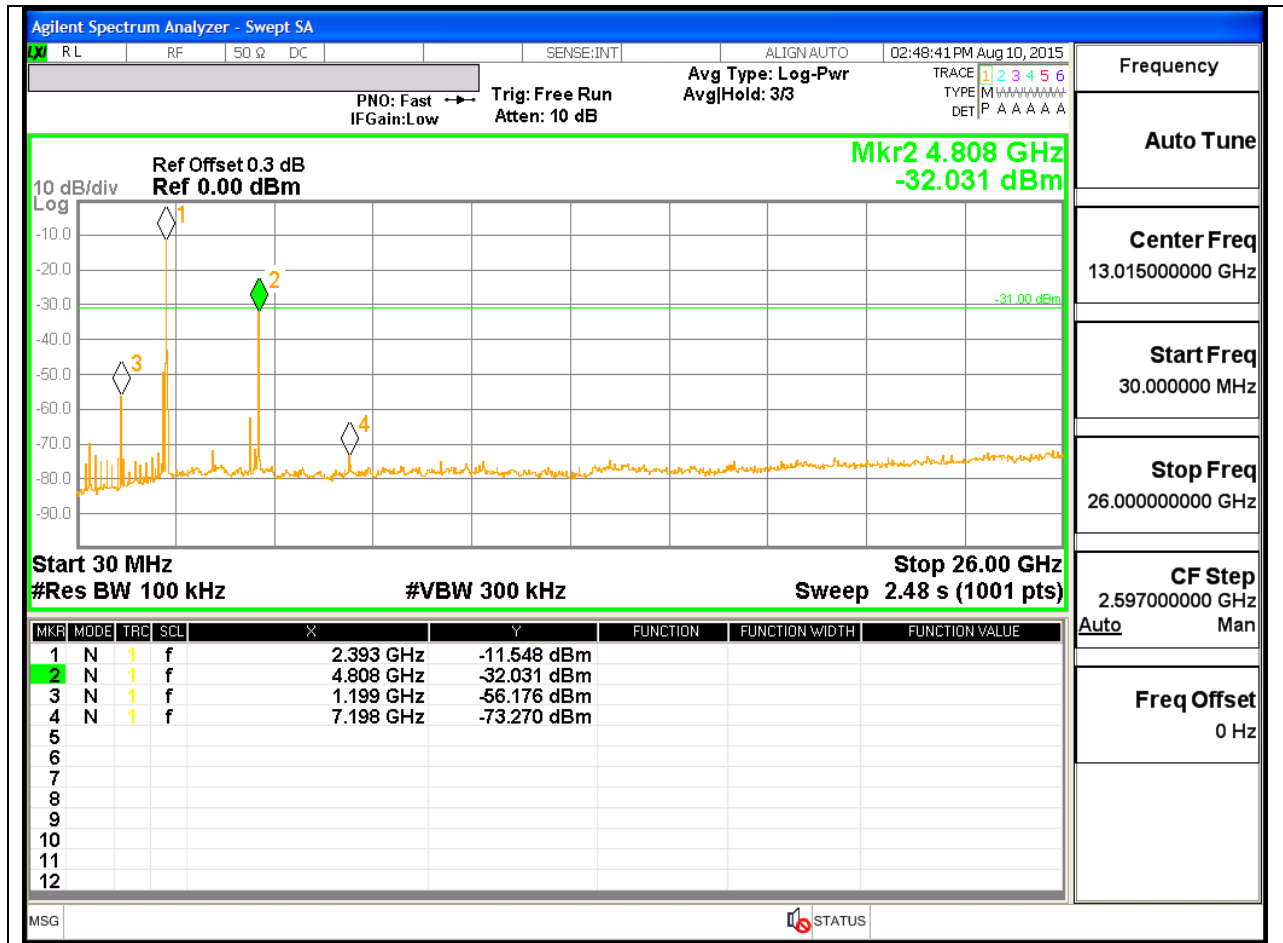

Frequency
Auto Tune
Center Freq 13.01500000 GHz
Start Freq 30.000000 MHz
Stop Freq 26.00000000 GHz
CF Step 2.597000000 GHz
Auto Man
Freq Offset 0 Hz

**SPURIOUS EMISSIONS, MID CHANNEL**

**LOW CHANNEL REFERENCE**

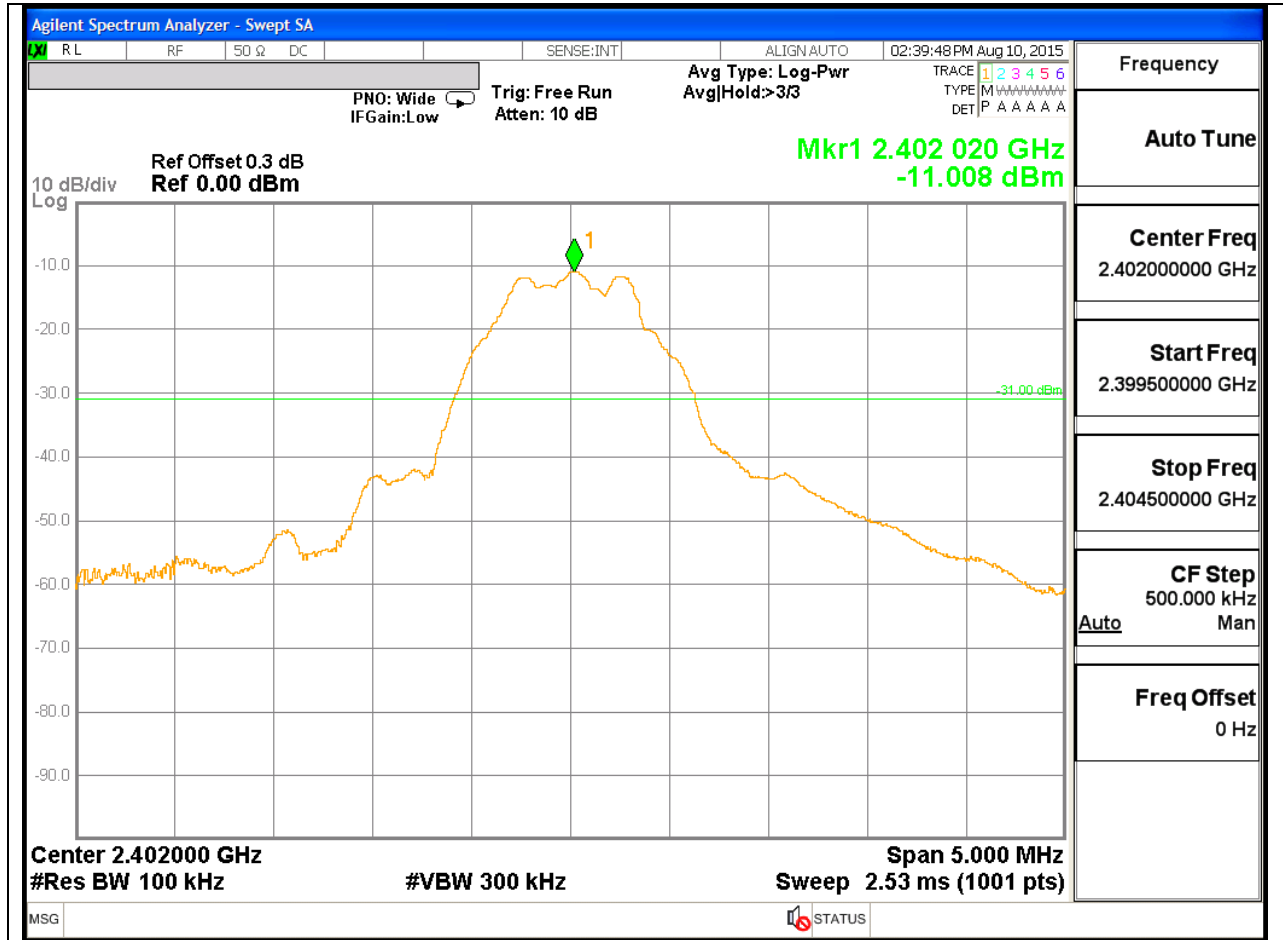

### MID CHANNEL SPURIOUS

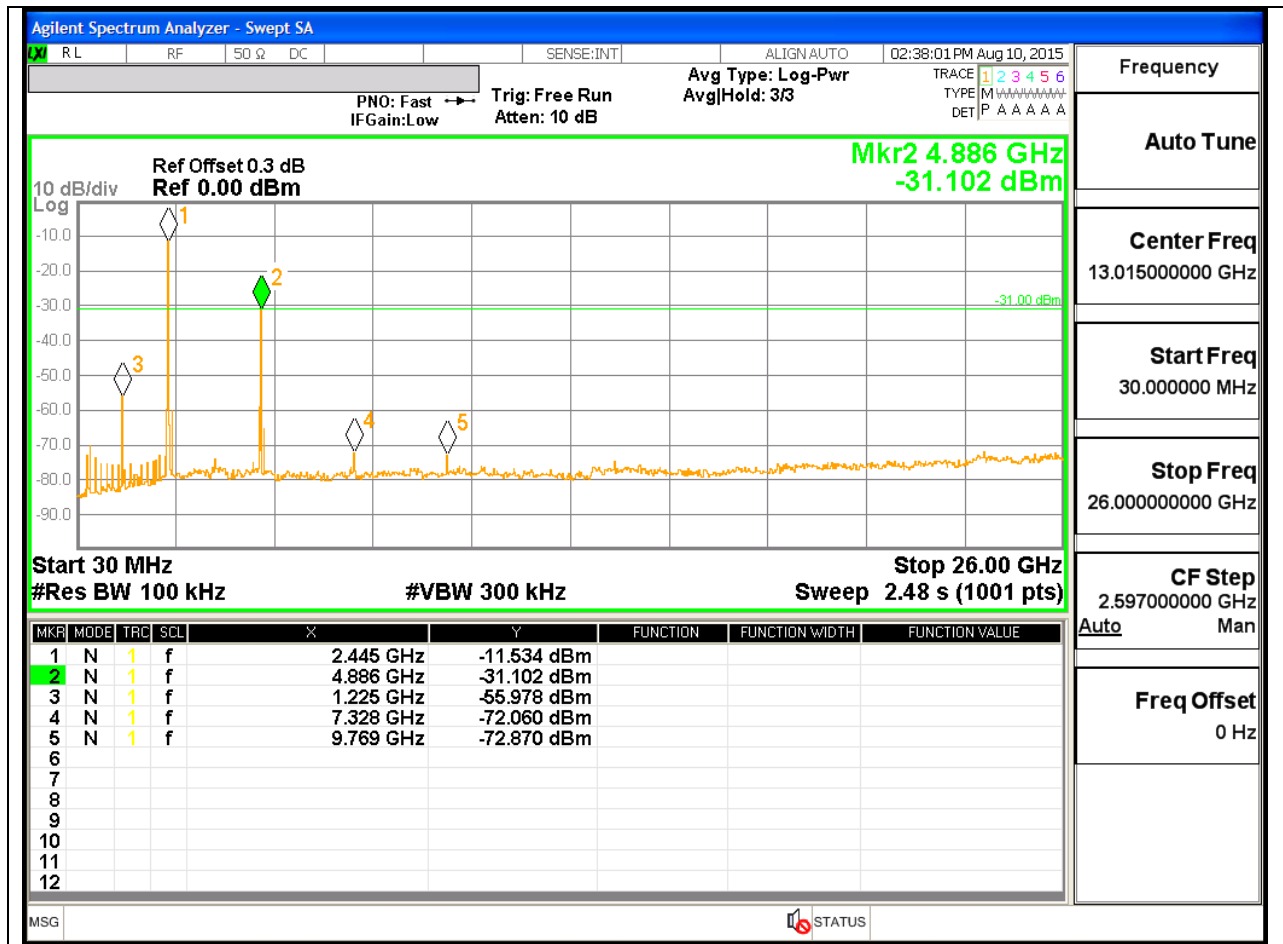

Frequency	
Auto Tune	
Center Freq	13.015000000 GHz
Start Freq	30.0000000 MHz
Stop Freq	26.000000000 GHz
CF Step	2.597000000 GHz
Auto	Man
Freq Offset	0 Hz

**SPURIOUS EMISSIONS, HIGH CHANNEL**

**HIGH CHANNEL BANDEDGE**

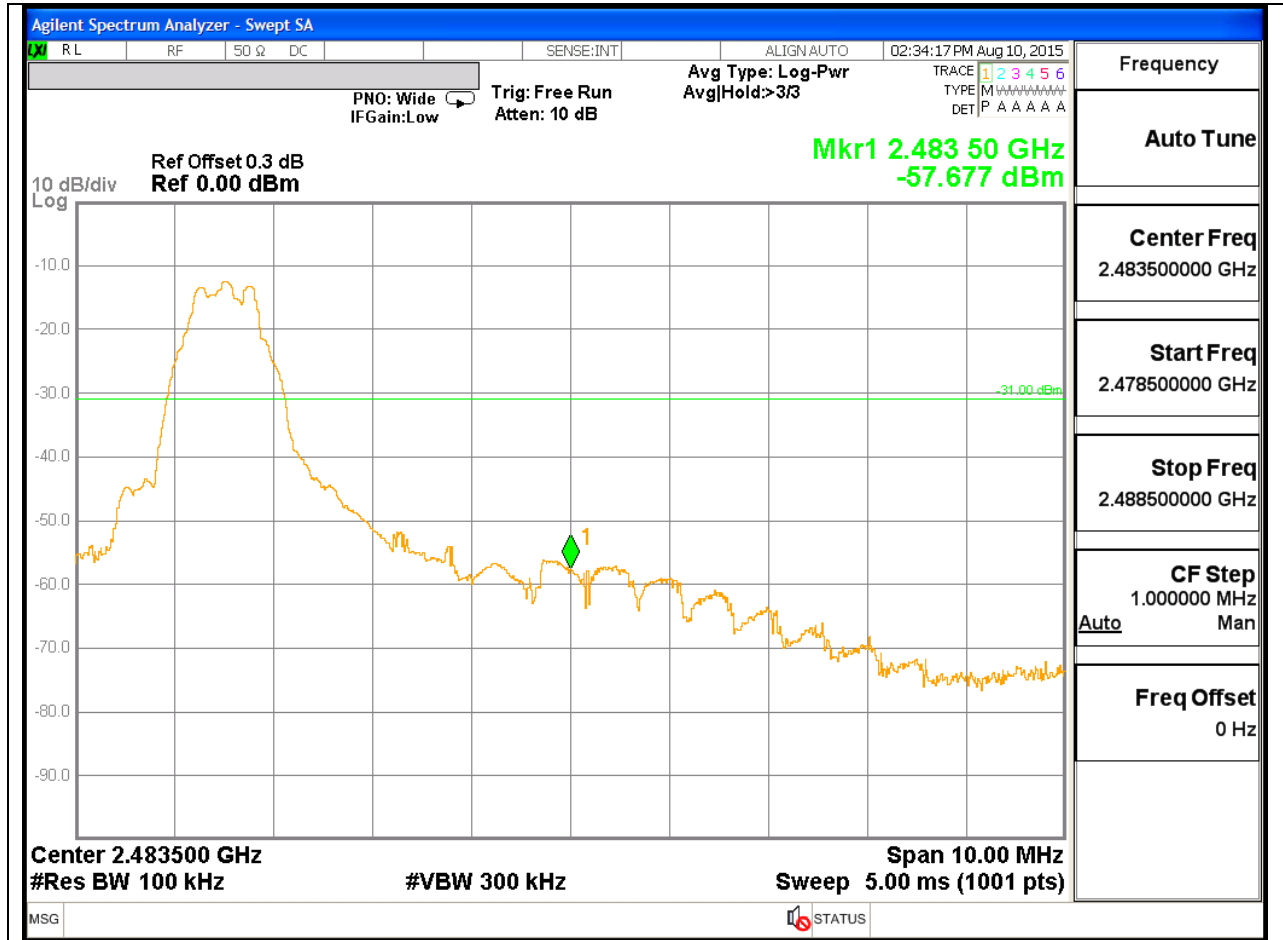



## 9. RADIATED TEST RESULTS

### 9.1. LIMITS AND PROCEDURE LIMITS

FCC §15.205 and §15.209

IC RSS-GEN Clause 8.9 (Transmitter)

IC RSS-GEN Clause 7 (Receiver)

Frequency Range (MHz)	Field Strength Limit (uV/m) at 3 m	Field Strength Limit (dBuV/m) at 3 m
30 - 88	100	40
88 - 216	150	43.5
216 - 960	200	46
Above 960	500	54

### TEST PROCEDURE

The EUT is placed on a non-conducting table 80 cm above the ground plane for below 1GHz and 150cm for above 1GHz. The antenna to EUT distance is 3 meters. The EUT is configured in accordance with ANSI C63.10. The EUT is set to transmit in a continuous mode.

For measurements below 1 GHz the resolution bandwidth is set to 100 kHz for peak detection measurements or 120 kHz for quasi-peak detection measurements. Peak detection is used unless otherwise noted as quasi-peak.

For measurements above 1 GHz the resolution bandwidth is set to 1 MHz, then the video bandwidth is set to 1 MHz for peak measurements and add duty cycle factor for average measurements. Duty cycle factor =  $10 \log (1/x)$ . For this sample: DCCF =  $10 \log (1/0.222)=6.54$  dB

The spectrum from 30 MHz to 26 GHz is investigated with the transmitter set to the lowest, middle, and highest channels in the 2.4 GHz band.

The spectrum from 30 MHz to 40 GHz is investigated with the transmitter set to the lowest, middle, and highest channels in each applicable band.

The frequency range of interest is monitored at a fixed antenna height and EUT azimuth. The EUT is rotated through 360 degrees to maximize emissions received. The antenna is scanned from 1 to 4 meters above the ground plane to further maximize the emission. Measurements are made with the antenna polarized in both the vertical and the horizontal positions.

## 9.2. TRANSMITTER ABOVE 1 GHz RESTRICTED BANDEDGE (LOW CHANNEL)

### HORIZONTAL PEAK AND AVERAGE PLOT

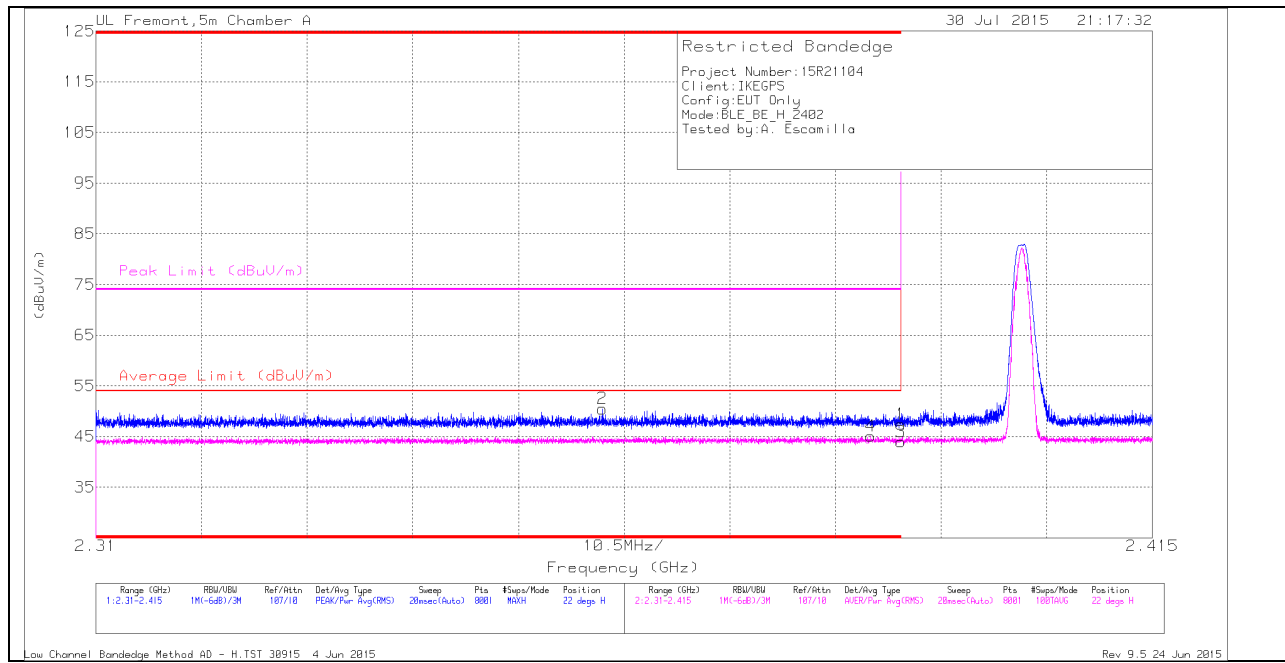

### HORIZONTAL DATA

Marker	Frequency (GHz)	Meter Reading (dBuV)	Det	AF T136 (dB/m)	Amp/Cbl/Filter/Pad (dB)	DC Corr (dB)	Corrected Reading (dBuV/m)	Average Limit (dBuV/m)	Margin (dB)	Peak Limit (dBuV/m)	PK Margin (dB)	Azimuth (Degs)	Height (cm)	Polarity
2	* 2.36	43.28	Pk	31.9	-24.7	0	50.48	-	-	74	-23.52	22	360	H
4	* 2.387	31.08	RMS	32	-24.6	6.54	45.02	54	-8.98	-	-	22	360	H
1	* 2.39	40.05	PK	32	-24.6	0	47.45	-	-	74	-26.55	22	360	H
3	* 2.39	30	RMS	32	-24.6	6.54	43.94	54	-10.06	-	-	22	360	H

\* - indicates frequency in CFR15.205/IC7.2.2 Restricted Band

Pk - Peak detector

RMS - RMS detection

**VERTICAL PEAK AND AVERAGE PLOT**

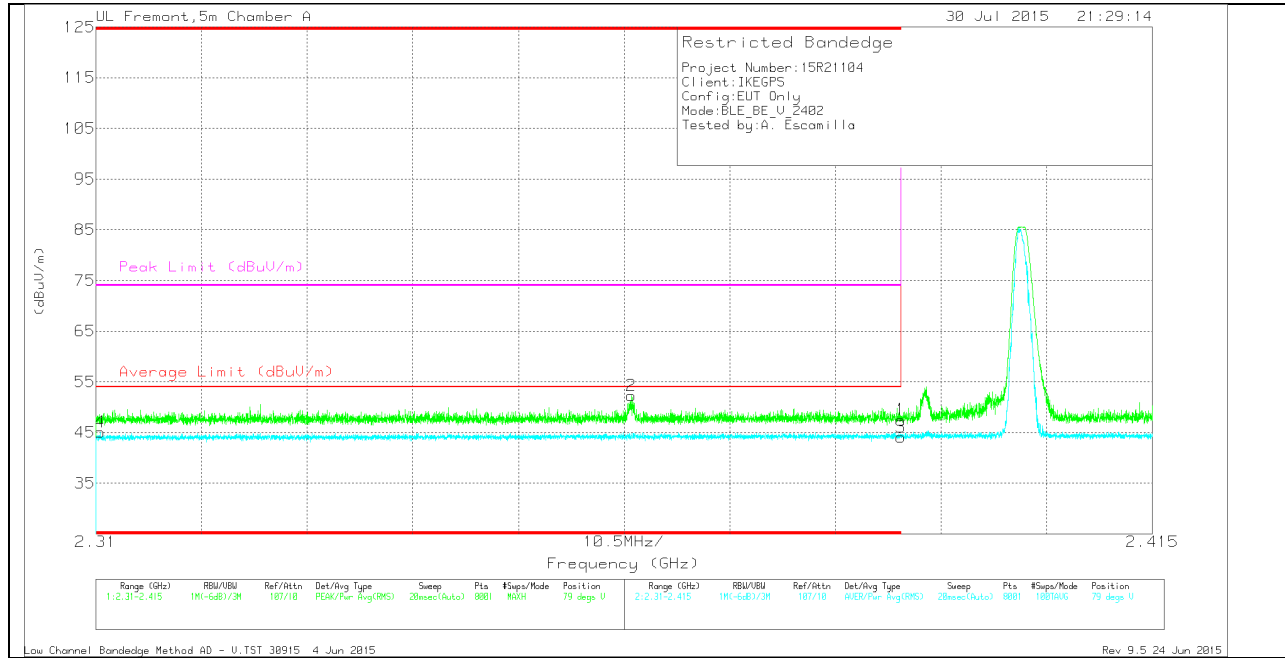

**VERTICAL DATA**

Marker	Frequency (GHz)	Meter Reading (dBuV)	Det	AF T136 (dB/m)	Amp/Cbl/Fitter/Pad (dB)	DC Corr (dB)	Corrected Reading (dBuV/m)	Average Limit (dBuV/m)	Margin (dB)	Peak Limit (dBuV/m)	PK Margin (dB)	Azimuth (Degs)	Height (cm)	Polarity
4	* 2.31	31.31	RMS	31.9	-24.7	6.54	45.05	54	-8.95	-	-	79	200	V
2	* 2.363	45.06	Pk	31.9	-24.7	0	52.26	-	-	74	-21.74	79	200	V
1	* 2.39	40.1	Pk	32	-24.6	0	47.5	-	-	74	-26.5	79	200	V
3	* 2.39	30.2	RMS	32	-24.6	6.54	44.14	54	-9.86	-	-	79	200	V

\* - indicates frequency in CFR15.205/IC7.2.2 Restricted Band

Pk - Peak detector

RMS - RMS detection



**AUTHORIZED BANDEDGE (HIGH CHANNEL)**

**HORIZONTAL PEAK AND AVERAGE PLOT**

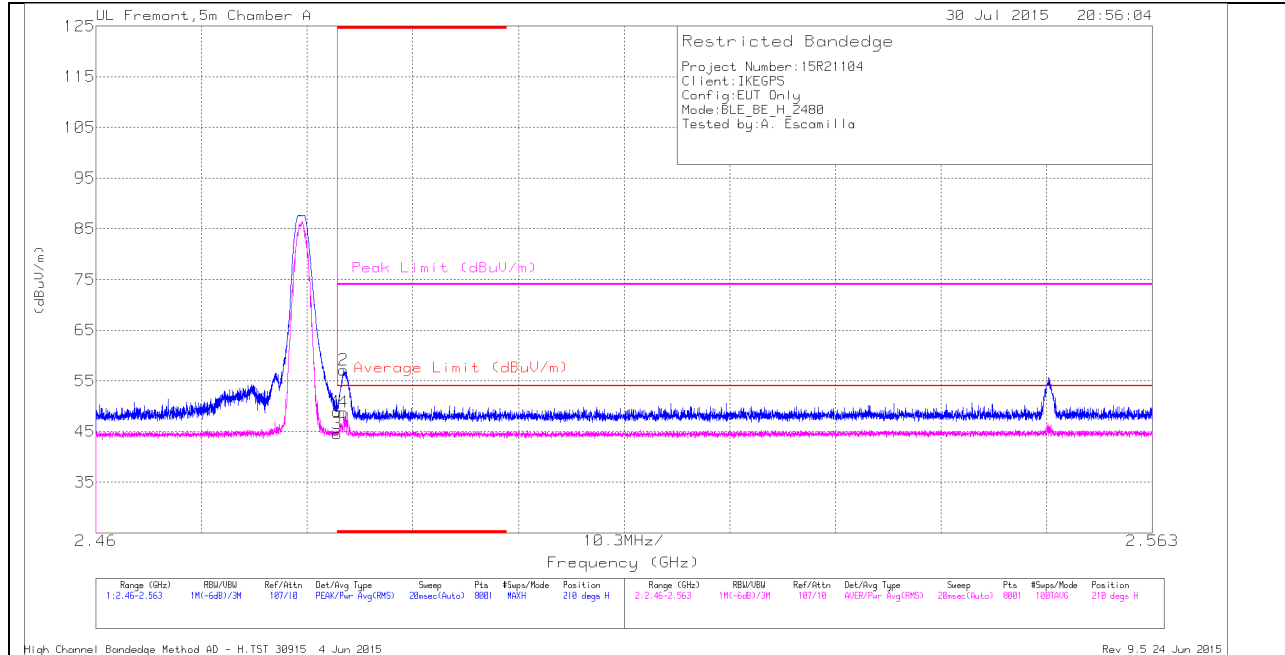

**HORIZONTAL DATA**

Marker	Frequency (GHz)	Meter Reading (dBuV)	Det	AF T136 (dB/m)	Amp/Cbl/Fit r/Pad (dB)	DC Corr (dB)	Corrected Reading (dBuV/m)	Average Limit (dBuV/m)	Margin (dB)	Peak Limit (dBuV/m)	PK Margin (dB)	Azimuth (Degs)	Height (cm)	Polarity
1	* 2.484	41.37	Pk	32.1	-24.5	0	48.97	-	-	74	-25.03	210	245	H
2	* 2.484	49.52	Pk	32.1	-24.5	0	57.12	-	-	74	-16.88	210	245	H
3	* 2.484	30.39	RMS	32.1	-24.5	6.54	44.53	54	-9.47	-	-	210	245	H
4	* 2.484	34.61	RMS	32.1	-24.5	6.54	48.75	54	-5.25	-	-	210	245	H

\* - indicates frequency in CFR15.205/IC7.2.2 Restricted Band

Pk - Peak detector

RMS - RMS detection

**VERTICAL PEAK AND AVERAGE PLOT**

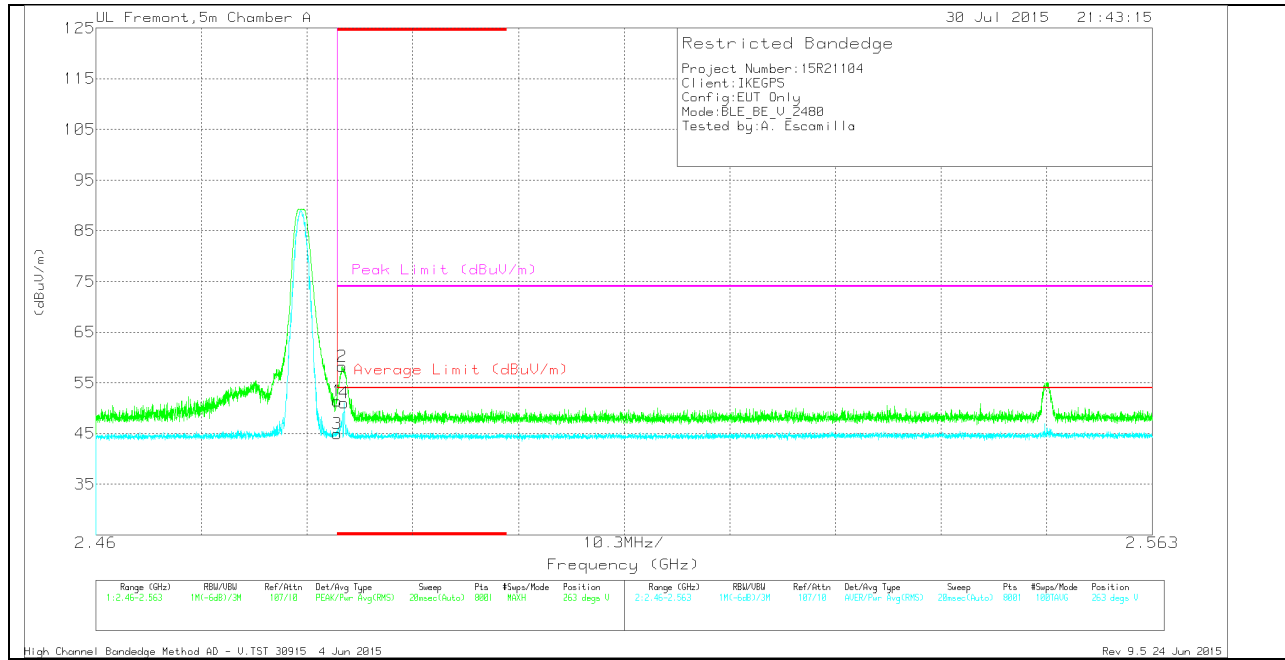

**VERTICAL DATA**

Marker	Frequency (GHz)	Meter Reading (dBuV)	Det	AF T136 (dB/m)	Amp/Cb/Filter/Pad (dB)	DC Corr (dB)	Corrected Reading (dBuV/m)	Average Limit (dBuV/m)	Margin (dB)	Peak Limit (dBuV/m)	PK Margin (dB)	Azimuth (Degs)	Height (cm)	Polarity
1	* 2.484	43.77	Pk	32.1	-24.5	0	51.37	-	-	74	-22.63	263	313	V
2	* 2.484	50.59	Pk	32.1	-24.5	0	58.19	-	-	74	-15.81	263	313	V
3	* 2.484	30.84	RMS	32.1	-24.5	6.54	44.98	54	-9.02	-	-	263	313	V
4	* 2.484	36.94	RMS	32.1	-24.5	6.54	51.08	54	-2.92	-	-	263	313	V

\* - indicates frequency in CFR15.205/IC7.2.2 Restricted Band

Pk - Peak detector

RMS - RMS detection

**HARMONICS AND SPURIOUS EMISSIONS**

**LOW CHANNEL HORIZONTAL**

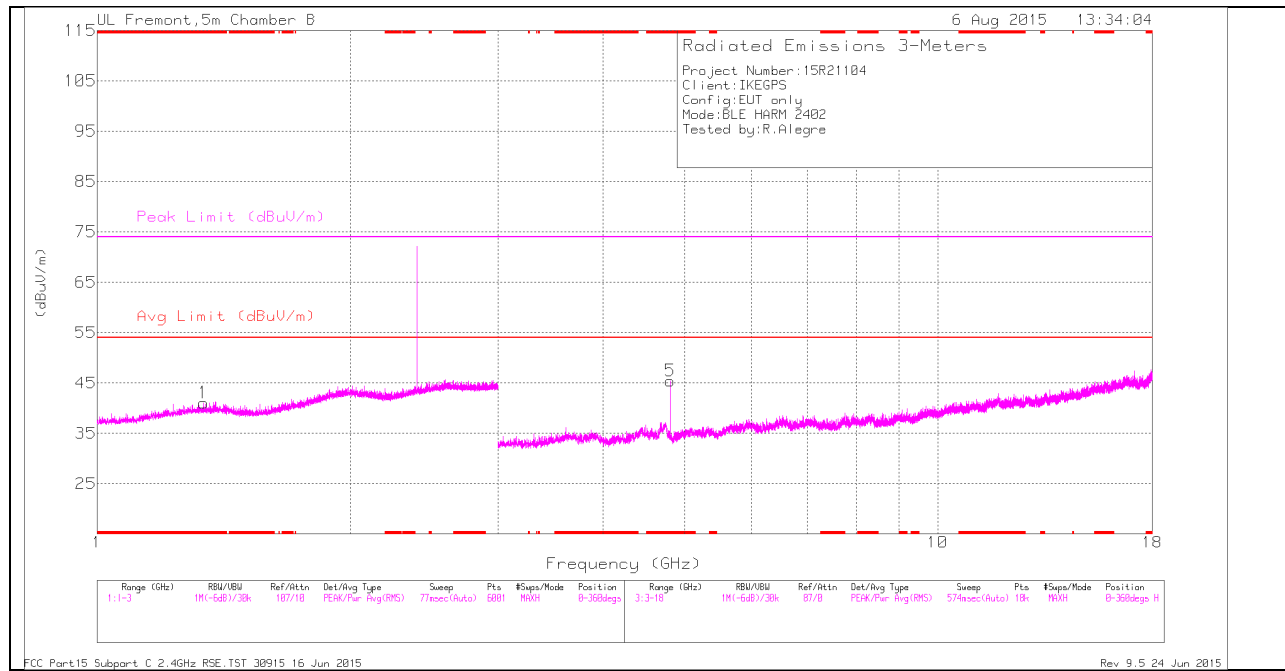

Note: Emission was scanned up to 26GHz; No emissions were detected above the noise floor which was at least 20dB below the specification limit.

### LOW CHANNEL VERTICAL

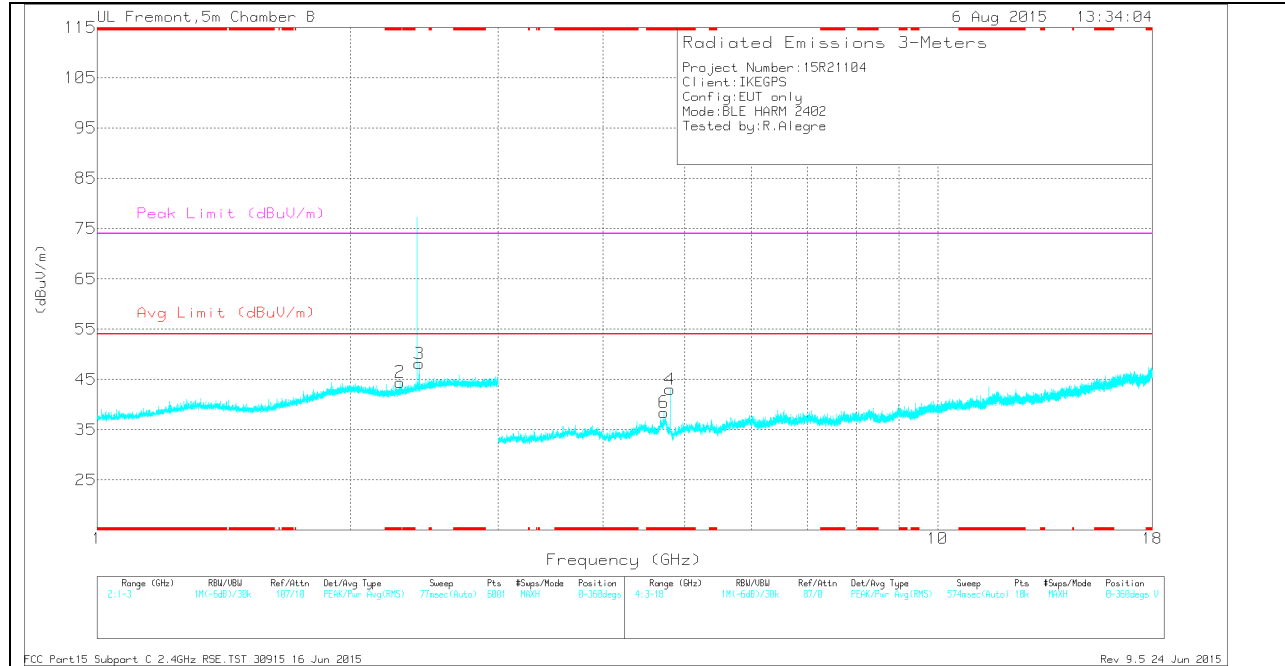

Note: Emission was scanned up to 26GHz; No emissions were detected above the noise floor which was at least 20dB below the specification limit.

**LOW CHANNEL DATA**

*TRACE MARKERS*

Marker	Frequency (GHz)	Meter Reading (dBuV)	Det	AF T345 (dB/m)	Amp/Cbl/Filtr /Pad (dB)	DC Corr (dB)	Corrected Reading (dBuV/m)	Avg Limit (dBuV/m)	Margin (dB)	Peak Limit (dBuV/m)	PK Margin (dB)	Azimuth (Degs)	Height (cm)	Polarity
1	* 1.339	37.08	Pk	29.4	-25.4	0	41.08	-	-	74	-32.92	0-360	101	H
2	* 2.292	37.15	Pk	31.5	-24.2	0	44.45	-	-	74	-29.55	0-360	101	V
5	* 4.804	42.14	Pk	34.3	-31	0	45.44	-	-	74	-28.56	0-360	199	H
4	* 4.803	39.73	Pk	34.3	-31	0	43.03	-	-	74	-30.97	0-360	101	V
6	* 4.726	34.93	Pk	34.3	-30.8	0	38.43	-	-	74	-35.57	0-360	199	V
3	2.417	40.13	Pk	32.1	-24.1	0	48.13	-	-	-	-	0-360	199	V

\* - indicates frequency in CFR15.205/IC7.2.2 Restricted Band

Pk - Peak detector

**Radiated Emissions**

Frequency (GHz)	Meter Reading (dBuV)	Det	AF T345 (dB/m)	Amp/Cbl/Filtr /Pad (dB)	DC Corr (dB)	Corrected Reading (dBuV/m)	Avg Limit (dBuV/m)	Margin (dB)	Peak Limit (dBuV/m)	PK Margin (dB)	Azimuth (Degs)	Height (cm)	Polarity
* 1.338	36.66	PK2	29.4	-25.4	0	40.66	-	-	74	-33.34	360	200	H
* 1.338	32.84	MAv1	29.4	-25.4	6.54	43.38	54	-10.62	-	-	360	200	H
* 2.292	36.2	PK2	31.5	-24.2	0	43.5	-	-	74	-30.5	360	200	V
* 2.291	32.25	MAv1	31.5	-24.3	6.54	45.99	54	-8.01	-	-	360	200	V
* 4.804	39.42	PK2	34.3	-31	0	42.72	-	-	74	-31.28	319	113	H
* 4.804	39.53	MAv1	34.3	-31	6.54	49.37	54	-4.63	-	-	319	113	H
* 4.803	37.61	PK2	34.3	-31	0	40.91	-	-	74	-33.09	208	117	V
* 4.804	36.82	MAv1	34.3	-31	6.54	46.66	54	-7.34	-	-	208	117	V
* 4.727	34.36	PK2	34.3	-30.8	0	37.86	-	-	74	-36.14	208	192	V
* 4.725	30.81	MAv1	34.3	-30.8	6.54	40.85	54	-13.15	-	-	208	192	V
2.417	38.63	PK2	32.1	-24.1	0	46.63	-	-	74	-27.37	30	207	V
2.417	32.48	MAv1	32.1	-24.1	6.54	47.02	54	-6.98	-	-	30	207	V

\* - indicates frequency in CFR15.205/IC7.2.2 Restricted Band

PK2 - KDB558074 Method: Maximum Peak

MAv1 - KDB558074 Option 1 Maximum RMS Average

### MID CHANNEL HORIZONTAL

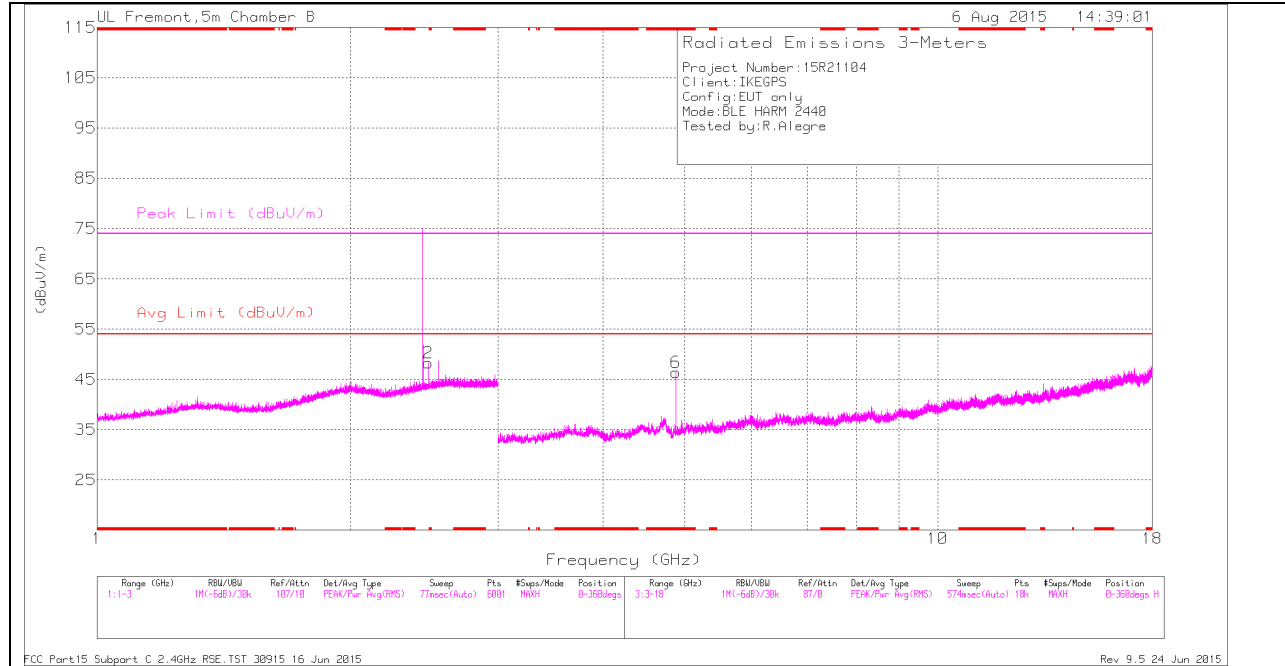

Note: Emission was scanned up to 26GHz; No emissions were detected above the noise floor which was at least 20dB below the specification limit.

### MID CHANNEL VERTICAL

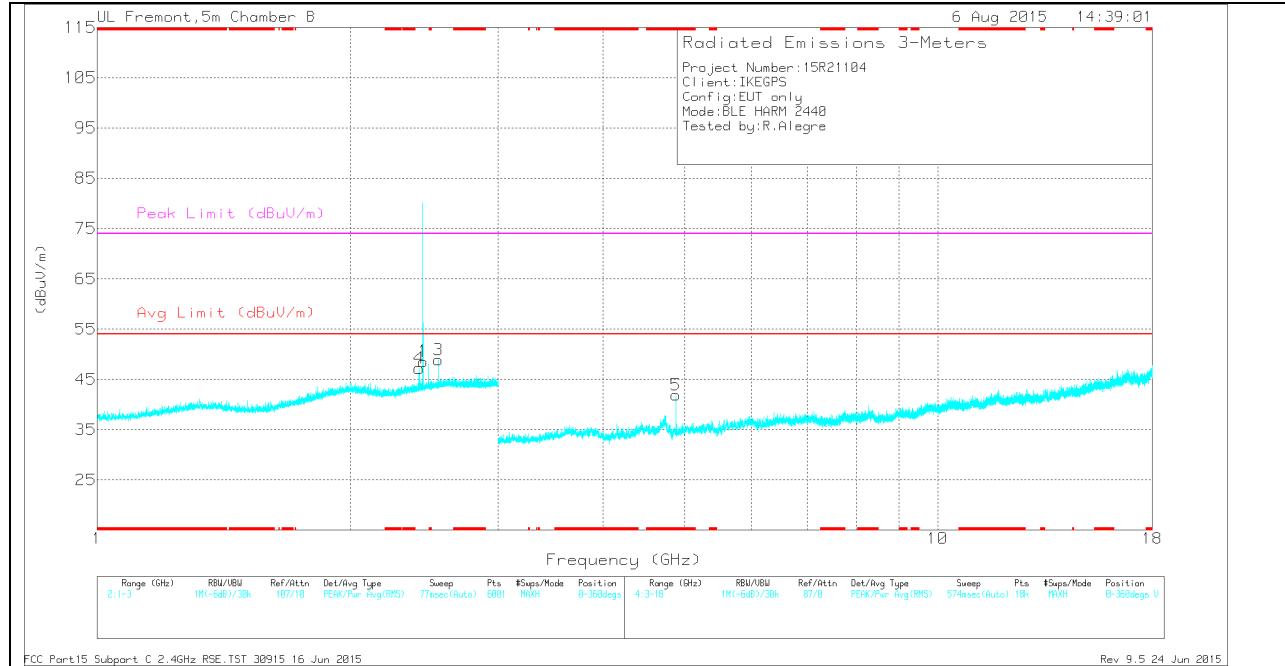

Note: Emission was scanned up to 26GHz; No emissions were detected above the noise floor which was at least 20dB below the specification limit.

**MID CHANNEL DATA**

*TRACE MARKERS*

Marker	Frequency (GHz)	Meter Reading (dBuV)	Det	AF T345 (dB/m)	Amp/Cbl/Filtr /Pad (dB)	DC Corr (dB)	Corrected Reading (dBuV/m)	Avg Limit (dBuV/m)	Margin (dB)	Peak Limit (dBuV/m)	PK Margin (dB)	Azimuth (Degs)	Height (cm)	Polarity
6	* 4.88	44.7	Pk	34.2	-32.5	0	46.4	-	-	74	-27.6	0-360	101	H
5	* 4.88	40.18	Pk	34.2	-32.5	0	41.88	-	-	74	-32.12	0-360	101	V
4	2.417	39.22	Pk	32.1	-24.1	0	47.22	-	-	-	-	0-360	200	V
1	2.445	40.25	Pk	32.3	-24	0	48.55	-	-	-	-	0-360	200	V
2	2.478	39.84	Pk	32.4	-24	0	48.24	-	-	-	-	0-360	200	H
3	2.546	40.17	Pk	32.6	-23.9	0	48.87	-	-	-	-	0-360	200	V

\* - indicates frequency in CFR15.205/IC7.2.2 Restricted Band

Pk - Peak detector

**Radiated Emissions**

Frequency (GHz)	Meter Reading (dBuV)	Det	AF T345 (dB/m)	Amp/Cbl/Filtr /Pad (dB)	DC Corr (dB)	Corrected Reading (dBuV/m)	Avg Limit (dBuV/m)	Margin (dB)	Peak Limit (dBuV/m)	PK Margin (dB)	Azimuth (Degs)	Height (cm)	Polarity
* 4.88	39.27	PK2	34.2	-32.5	0	40.97	-	-	74	-33.03	321	101	H
* 4.88	38.16	MAV1	34.2	-32.5	6.54	46.40	54	-7.6	-	-	321	101	H
* 4.88	37.54	PK2	34.2	-32.5	0	39.24	-	-	74	-34.76	200	113	V
* 4.88	33	MAV1	34.2	-32.5	6.54	41.24	54	-12.76	-	-	200	113	V
2.417	38.56	PK2	32.1	-24.1	0	46.56	-	-	74	-27.44	80	350	V
2.417	32.79	MAV1	32.1	-24.1	6.54	47.33	-	-	-	-	80	350	V
2.445	36.43	PK2	32.3	-24	0	44.73	-	-	74	-29.27	8	270	V
2.445	32.95	MAV1	32.3	-24	6.54	47.79	-	-	-	-	8	270	V
2.477	38.94	PK2	32.4	-24	0	47.34	-	-	74	-26.66	8	290	H
2.478	32.13	MAV1	32.4	-24	6.54	47.07	-	-	-	-	8	290	H
2.546	36.1	PK2	32.6	-23.9	0	44.8	-	-	74	-29.2	10	201	V
2.546	32.41	MAV1	32.6	-23.9	6.54	47.65	-	-	-	-	10	201	V

\* - indicates frequency in CFR15.205/IC7.2.2 Restricted Band

PK2 - KDB558074 Method: Maximum Peak

MAV1 - KDB558074 Option 1 Maximum RMS Average



### HIGH CHANNEL HORIZONTAL

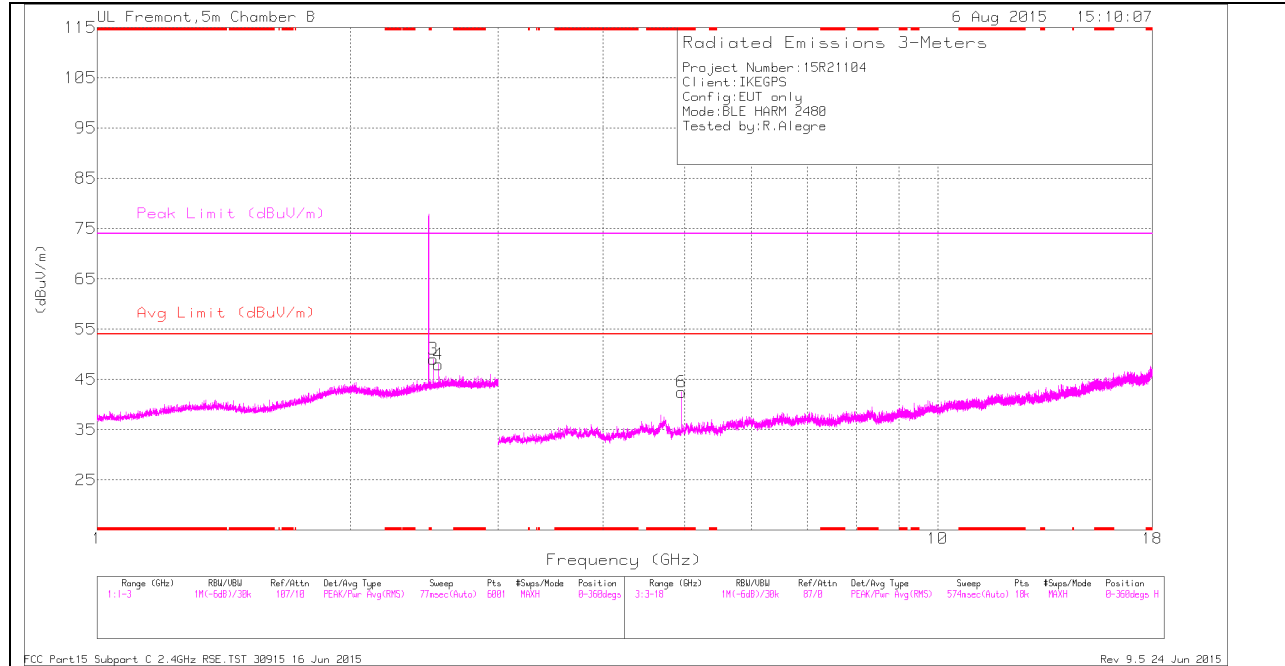

Note: Emission was scanned up to 26GHz; No emissions were detected above the noise floor which was at least 20dB below the specification limit.

### HIGH CHANNEL VERTICAL

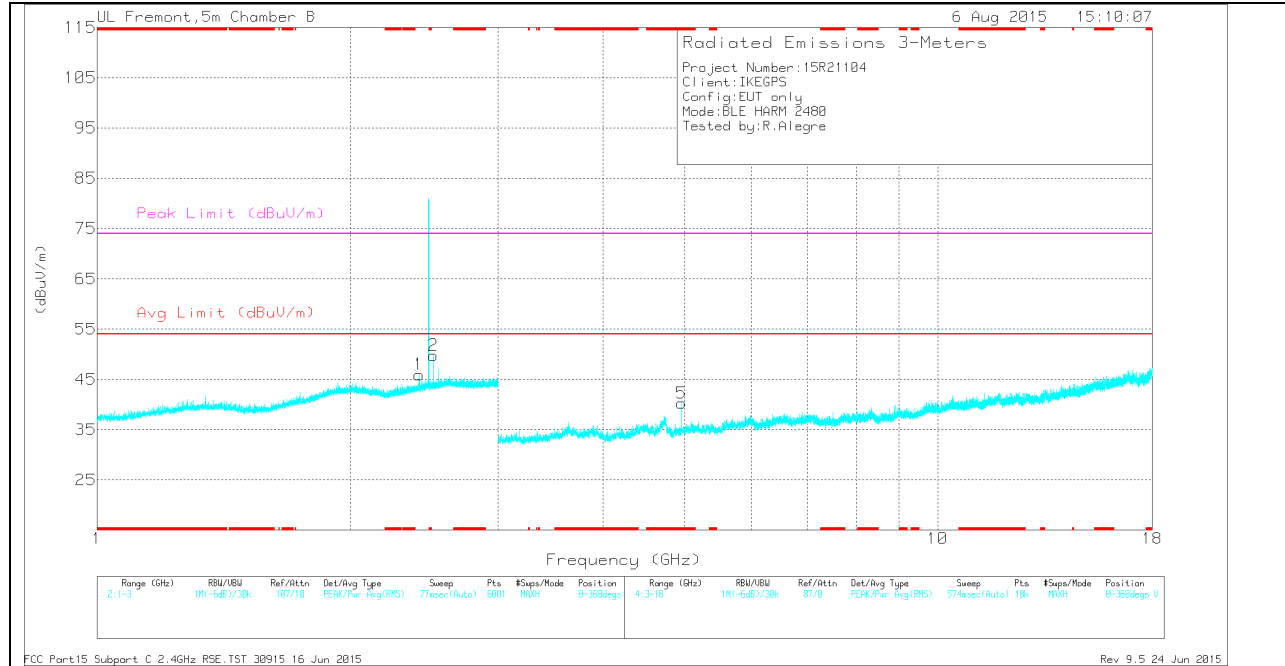

Note: Emission was scanned up to 26GHz; No emissions were detected above the noise floor which was at least 20dB below the specification limit.

**HIGH CHANNEL DATA**

*TRACE MARKERS*

Marker	Frequency (GHz)	Meter Reading (dBuV)	Det	AF T345 (dB/m)	Amp/Cbl/Filtr /Pad (dB)	DC Corr (dB)	Corrected Reading (dBuV/m)	Avg Limit (dBuV/m)	Margin (dB)	Peak Limit (dBuV/m)	PK Margin (dB)	Azimuth (Degs)	Height (cm)	Polarity
6	* 4.96	40.28	Pk	34.1	-31.9	0	42.48	-	-	74	-31.52	0-360	200	H
5	* 4.96	38.06	Pk	34.1	-31.9	0	40.26	-	-	74	-33.74	0-360	101	V
1	2.417	37.96	Pk	32.1	-24.1	0	45.96	-	-	-	-	0-360	101	V
3	2.511	40.45	Pk	32.6	-24	0	49.05	-	-	-	-	0-360	199	H
2	2.511	41.19	Pk	32.6	-24	0	49.79	-	-	-	-	0-360	101	V
4	2.546	39.28	Pk	32.6	-23.9	0	47.98	-	-	-	-	0-360	199	H

\* - indicates frequency in CFR15.205/IC7.2.2 Restricted Band

Pk - Peak detector

**Radiated Emissions**

Frequency (GHz)	Meter Reading (dBuV)	Det	AF T345 (dB/m)	Amp/Cbl/Filtr /Pad (dB)	DC Corr (dB)	Corrected Reading (dBuV/m)	Avg Limit (dBuV/m)	Margin (dB)	Peak Limit (dBuV/m)	PK Margin (dB)	Azimuth (Degs)	Height (cm)	Polarity
* 4.96	38.88	PK2	34.1	-31.9	0	41.08	-	-	74	-32.92	324	128	H
* 4.96	35.56	MAv1	34.1	-31.9	6.54	44.3	54	-9.7	-	-	324	128	H
* 4.96	37.91	PK2	34.1	-31.9	0	40.11	-	-	74	-33.89	215	105	V
* 4.96	32.52	MAv1	34.1	-31.9	6.54	41.26	54	-12.74	-	-	215	105	V
2.417	36.22	PK2	32.1	-24.1	0	44.22	-	-	74	-29.78	33	206	V
2.417	32.74	MAv1	32.1	-24.1	6.54	47.28	-	-	-	-	33	206	V
2.511	38.83	PK2	32.6	-24	0	47.43	-	-	74	-26.57	6	255	H
2.511	32.56	MAv1	32.6	-24	6.54	47.7	-	-	-	-	6	255	H
2.511	36.32	PK2	32.6	-24	0	44.92	-	-	74	-29.08	33	200	V
2.511	33.24	MAv1	32.6	-24	6.54	48.38	-	-	-	-	33	200	V
2.545	36.21	PK2	32.6	-23.9	0	44.91	-	-	74	-29.09	9	200	H
2.546	32.86	MAv1	32.6	-23.9	6.54	48.10	-	-	-	-	9	200	H
2.546	32.44	MAv1	32.6	-23.9	6.54	47.68	-	-	-	-	9	200	H
2.546	31.91	MAv1	32.6	-23.9	6.54	47.15	-	-	-	-	11	139	H
2.547	36.22	PK2	32.6	-23.9	0	44.92	-	-	74	-29.08	9	200	H
2.547	38.41	PK2	32.6	-23.9	0	47.11	-	-	74	-26.89	11	139	H

\* - indicates frequency in CFR15.205/IC7.2.2 Restricted Band

PK2 - KDB558074 Method: Maximum Peak

MAv1 - KDB558074 Option 1 Maximum RMS Average

### 9.3. WORST-CASE BELOW 1 GHz

#### SPURIOUS EMISSIONS 30 TO 1000 MHz (WORST-CASE CONFIGURATION) HORIZONTAL PLOT

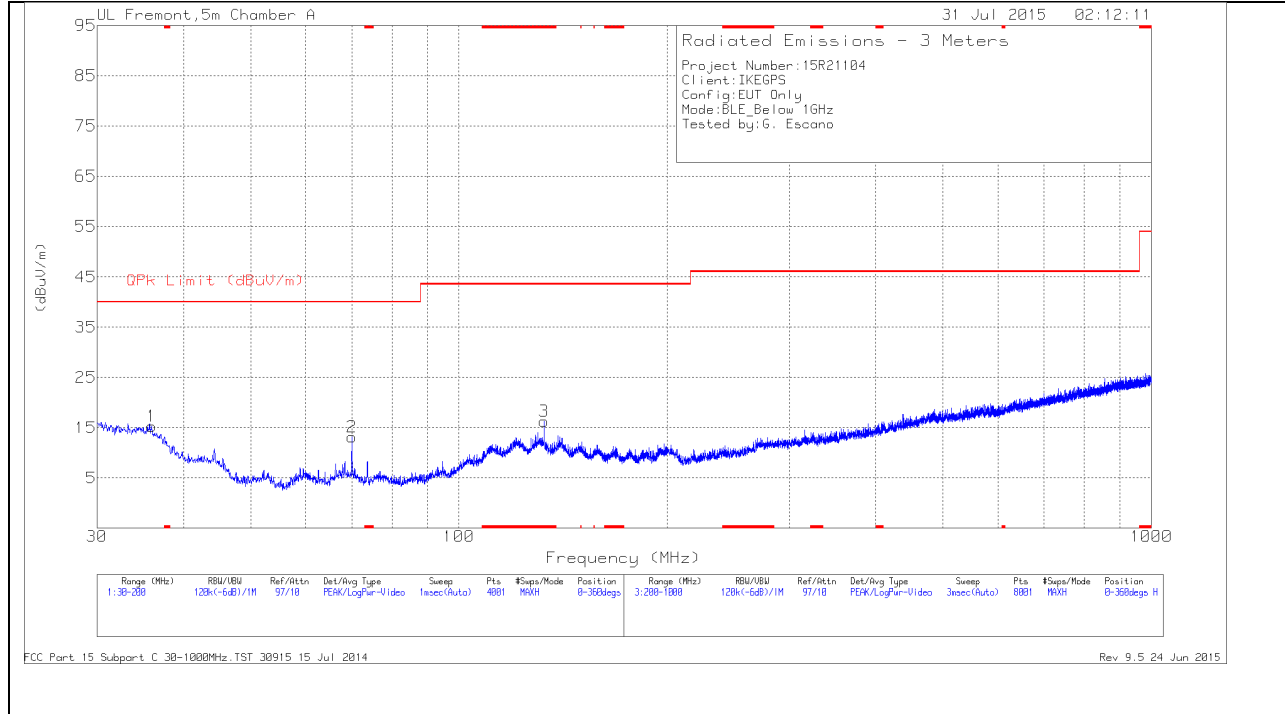

### VERTICAL PLOT

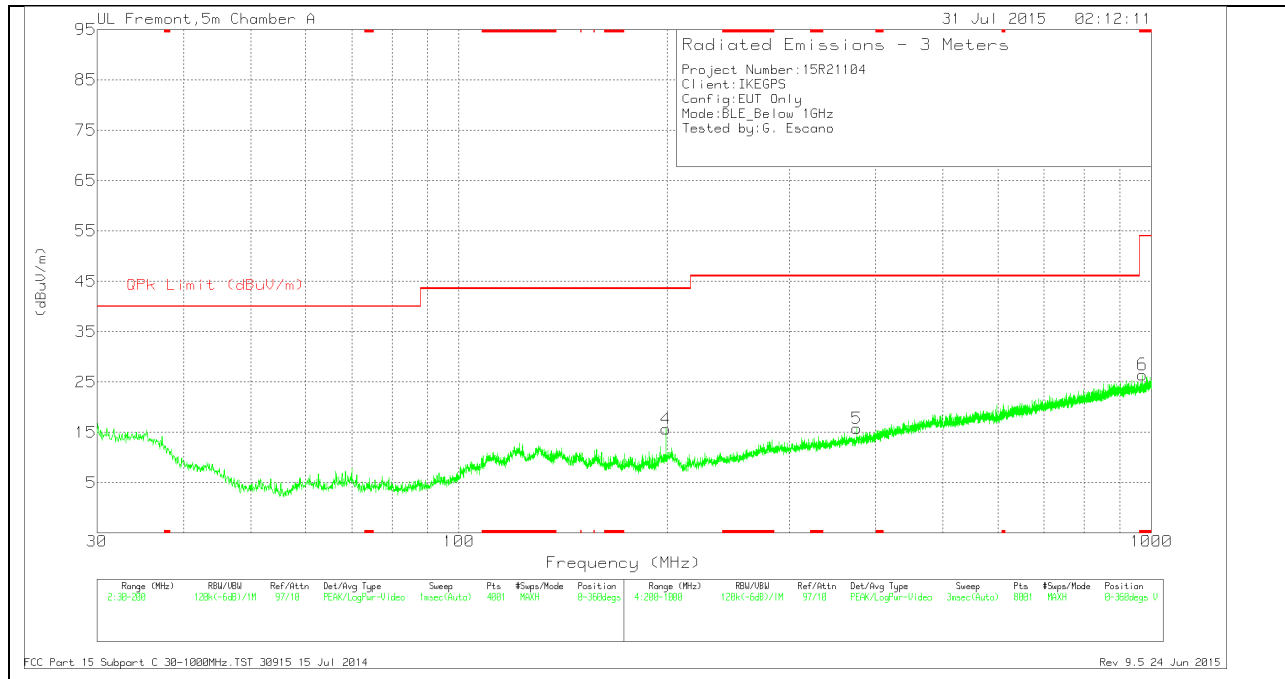

**BELOW 1 GHZ TABLE**

Marker	Frequency (MHz)	Meter Reading (dBuV)	Det	AF T130 (dB/m)	Amp/Cbl (dB/m)	Corrected Reading (dBuV/m)	QPk Limit (dBuV/m)	Margin (dB)	Azimuth (Degs)	Height (cm)	Polarity
3	* 132.7225	32.46	Pk	14.1	-30.3	16.26	43.52	-27.26	0-360	101	H
6	* 970.2	30.44	Pk	22.7	-26.7	26.44	53.97	-27.53	0-360	101	V
1	35.9925	29.45	Pk	17	-31.2	15.25	40	-24.75	0-360	101	H
2	70.035	35.83	Pk	8.1	-30.8	13.13	40	-26.87	0-360	199	H
4	199.0225	33.04	Pk	12.5	-29.9	15.64	43.52	-27.88	0-360	101	V
5	375.6	30.05	Pk	14.8	-29.1	15.75	46.02	-30.27	0-360	199	V

\* - indicates frequency in CFR15.205/IC7.2.2 Restricted Band

Pk - Peak detector

## 10. AC POWER LINE CONDUCTED EMISSIONS

### LIMITS

FCC §15.207 (a)

RSS-Gen 8.8

Frequency of Emission (MHz)	Conducted Limit (dBuV)	
	Quasi-peak	Average
0.15-0.5	66 to 56	56 to 46
0.5-5	56	46
5-30	60	50

\*Decreases with the logarithm of the frequency.

### TEST PROCEDURE

ANSI C63.10

### RESULTS

#### 6 WORST EMISSIONS

LINE 1 PLOT

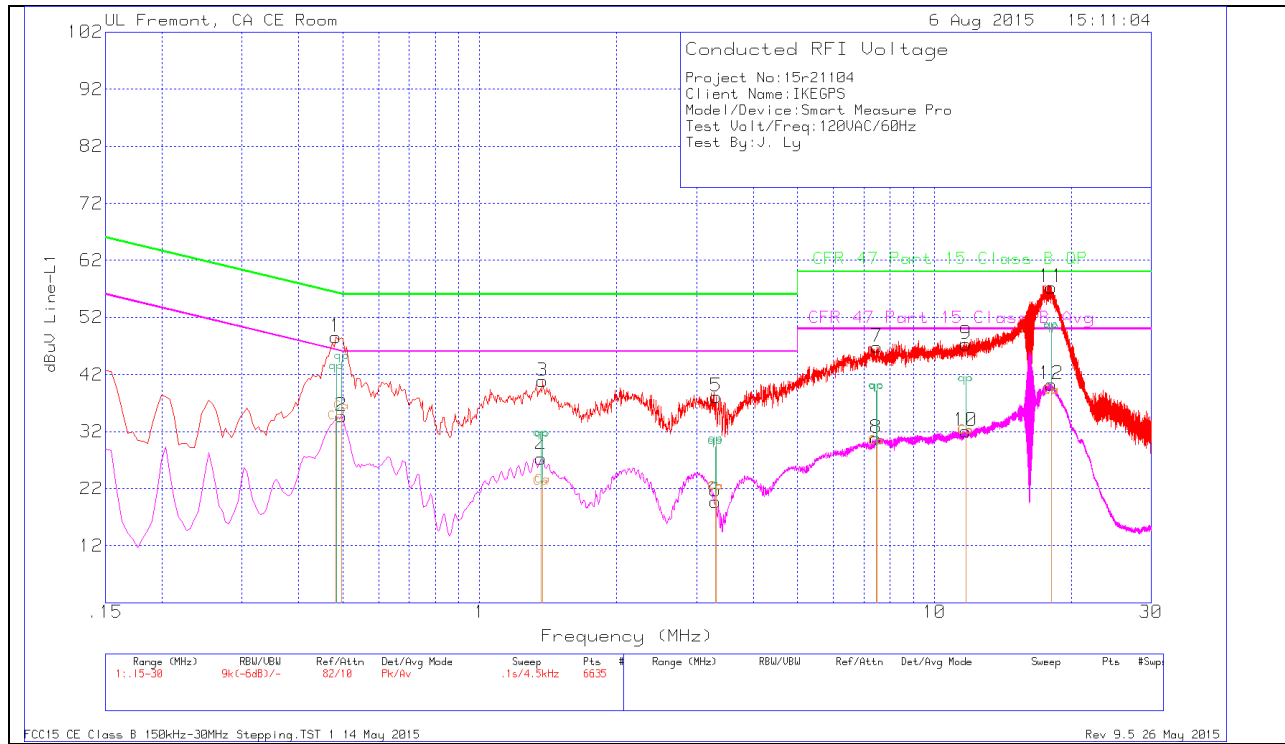



**LINE 1 RESULTS**

Range 1: Line-L1 .15 - 30MHz

Frequency (MHz)	Meter Reading (dBuV)	Det	T24 IL L1	LC Cables 1&3	Corrected Reading dBuV	CFR 47 Part 15 Class B QP	Margin (dB)	CFR 47 Part 15 Class B Avg	Margin (dB)
.48413	33.24	Ca	.4	0	33.64	-	-	46.27	-12.63
.49763	35.14	Ca	.3	0	35.44	-	-	46.04	-10.6
1.37378	22.24	Ca	.2	.1	22.54	-	-	46	-23.46
1.36568	21.89	Ca	.2	.1	22.19	-	-	46	-23.81
3.30788	21.05	Ca	.2	.1	21.35	-	-	46	-24.65
3.30518	20.93	Ca	.2	.1	21.23	-	-	46	-24.77
7.47128	28.91	Ca	.2	.1	29.21	-	-	50	-20.79
7.45463	29.09	Ca	.2	.1	29.39	-	-	50	-20.61
11.7292	30.83	Ca	.2	.2	31.23	-	-	50	-18.77
11.7202	30.69	Ca	.2	.2	31.09	-	-	50	-18.91
18.0949	37.78	Ca	.3	.2	38.28	-	-	50	-11.72
18.0742	37.58	Ca	.3	.2	38.08	-	-	50	-11.92

Ca - CISPR average detection

Range 1: Line-L1 .15 - 30MHz

Frequency (MHz)	Meter Reading (dBuV)	Det	T24 IL L1	LC Cables 1&3	Corrected Reading dBuV	CFR 47 Part 15 Class B QP	Margin (dB)	CFR 47 Part 15 Class B Avg	Margin (dB)
.48413	42	Qp	.4	0	42.4	56.27	-13.87	-	-
.49763	43.9	Qp	.3	0	44.2	56.04	-11.84	-	-
1.37378	30.34	Qp	.2	.1	30.64	56	-25.36	-	-
1.36568	30.39	Qp	.2	.1	30.69	56	-25.31	-	-
3.30788	29.37	Qp	.2	.1	29.67	56	-26.33	-	-
3.30518	29.04	Qp	.2	.1	29.34	56	-26.66	-	-
7.47128	38.64	Qp	.2	.1	38.94	60	-21.06	-	-
7.45463	38.78	Qp	.2	.1	39.08	60	-20.92	-	-
11.7292	39.87	Qp	.2	.2	40.27	60	-19.73	-	-
11.7202	39.87	Qp	.2	.2	40.27	60	-19.73	-	-
18.0949	48.97	Qp	.3	.2	49.47	60	-10.53	-	-
18.0742	49.2	Qp	.3	.2	49.7	60	-10.3	-	-

Qp - Quasi-Peak detector

LINE 2 PLOT

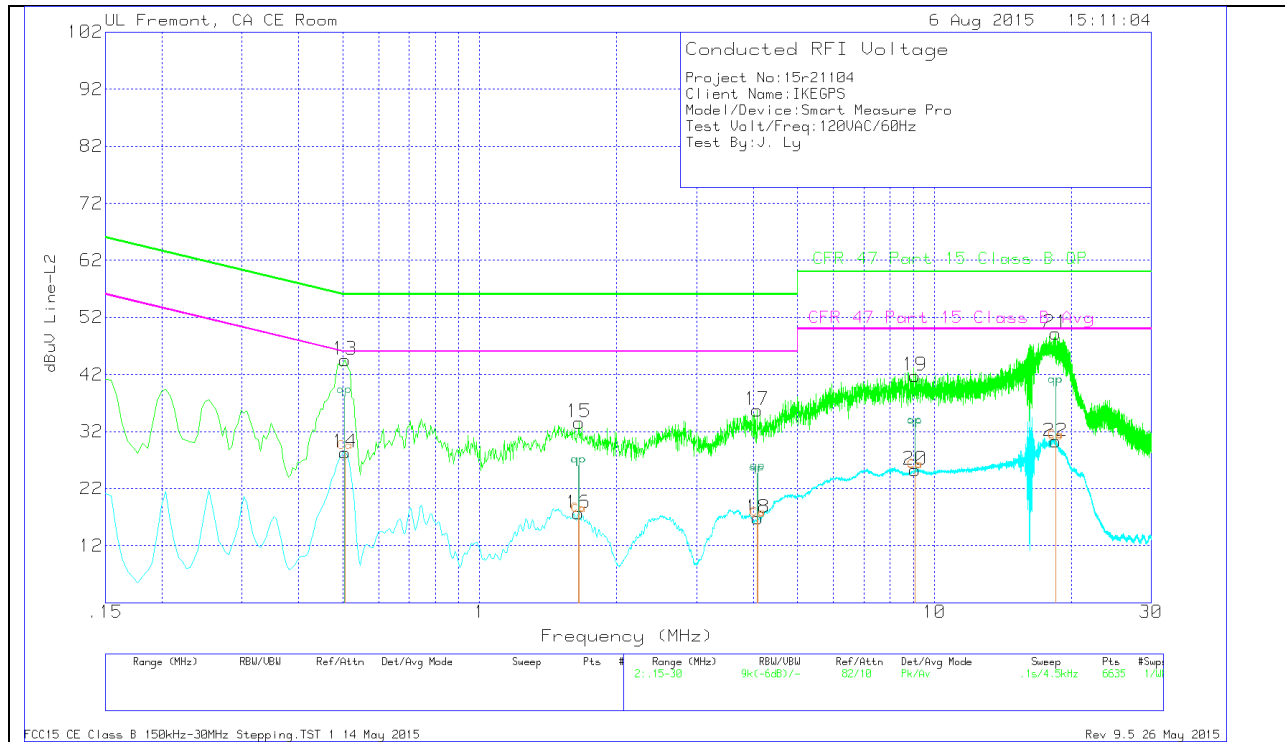

**LINE 2 RESULTS**

Range 2: Line-L2 .15 - 30MHz

Frequency (MHz)	Meter Reading (dBuV)	Det	T24 IL L2	LC Cables 2&3	Corrected Reading dBuV	CFR 47 Part 15 Class B QP	Margin (dB)	CFR 47 Part 15 Class B Avg	Margin (dB)
.50438	28.05	Ca	.4	0	28.45	-	-	46	-17.55
1.65368	17.03	Ca	.2	.1	17.33	-	-	46	-28.67
1.64963	17.24	Ca	.2	.1	17.54	-	-	46	-28.46
4.07963	16.24	Ca	.2	.1	16.54	-	-	46	-29.46
4.09538	16.5	Ca	.2	.1	16.8	-	-	46	-29.2
9.06113	24.75	Ca	.2	.1	25.05	-	-	50	-24.95
9.08228	24.87	Ca	.2	.1	25.17	-	-	50	-24.83
18.4751	29.62	Ca	.3	.2	30.12	-	-	50	-19.88
18.4976	29.89	Ca	.3	.2	30.39	-	-	50	-19.61

Ca - CISPR average detection

Range 2: Line-L2 .15 - 30MHz

Frequency (MHz)	Meter Reading (dBuV)	Det	T24 IL L2	LC Cables 2&3	Corrected Reading dBuV	CFR 47 Part 15 Class B QP	Margin (dB)	CFR 47 Part 15 Class B Avg	Margin (dB)
.50438	37.84	Qp	.4	0	38.24	56	-17.76	-	-
1.65368	25.77	Qp	.2	.1	26.07	56	-29.93	-	-
1.64963	25.73	Qp	.2	.1	26.03	56	-29.97	-	-
4.07963	24.31	Qp	.2	.1	24.61	56	-31.39	-	-
4.09538	24.66	Qp	.2	.1	24.96	56	-31.04	-	-
9.06113	32.64	Qp	.2	.1	32.94	60	-27.06	-	-
9.08228	32.52	Qp	.2	.1	32.82	60	-27.18	-	-
18.4751	39.53	Qp	.3	.2	40.03	60	-19.97	-	-
18.4976	39.52	Qp	.3	.2	40.02	60	-19.98	-	-

Qp - Quasi-Peak detector