

Shanghai Sunnyway Communication Technology Limited Company

Temporary antenna specification

Customer: GUANGYI		The project: FG18WIFI version		
Operating frequency band: 2.4G+5GWIFI+6E				
Motherboard version:				
Shangyuan material specifications				
Specifications and models	Shangyuan material number	Customer part number		
ANT0 antenna	SH23227IB98-1			
ANT1 antenna	SH23227IB98-2			
ANT2 antenna	SH23227IB98-3			
ANT3 antenna	SH23227IB98-4			
ANT7 antenna	SH23227IB98-5			
ANT8 antenna	SH23227IB98-6			
WIFI1 antenna	SH23227IB65-1			
WIFI2 antenna	SH23227IB65-2			
The record of project changes				
Date of preparation/change	Changes	Change of person	version	
Sunnyway counter-signature bar				
Research and development	ME:	Auditor:	QE:	Approver:
	RF:	Auditor:		
Client Counter-signature bar				
EE	PM	RF	QE	

Tel: +86-021-60835368 (Shanghai) ; +86-0755-82504258 (Shenzhen)

Shanghai R&D Center Address: 1st Floor, Building 4, No. 99, Lane 215, Gaoguang Road,
Qingpu District, Shanghai

Shenzhen R & D Center Address: Shenzhen Guangming District South Taiyun Chuanggu Center 5
Building 6 floor

Chongqing R&D Center Address: C08-1 Building-1, No. 19 Xiantao Data Valley East Road,
Yubei District, Chongqing

目录

1. Project picture.....	3
2. Test fixtures.....	4
3. Matching circuits.....	4
4. S11 test.....	5
4.1 S11 Test Method Description.....	5
4.2 S11 parameter.....	5
5 . DARKROOM TEST DATA.....	7
5.1 Passive test data.	8
5.2 Active test data.....	24
6. Mass production antenna indicators.....	25
7. Drawing.....	26

1. Project information

Machine information



Antenna information

	version
2.4g/5gwifi white 1	
2.4g/5g WiFi white 2	
2.4g/5g WiFi black short	
2.4g/5g WiFi black long	
WiFi 6E black	
WiFi 6E white	

Note: The customer finally verified that the antenna performance prototype was retained in our company for at least one year, which is convenient for analysis and solution to abnormal situations in antenna mass production.
Ensure antenna shipment quality.

2. Test fixtures

Purpose: To test the passive parameters of the antenna as accurately as possible.

How to make: The prototyping mechanism is made of a 50 ohm coaxial cable, one end is connected to the test point at the back of the matching circuit of the prototype motherboard (the front of the RF test hole), and the other end is connected to the SMA connector. The schematic diagram is as follows:

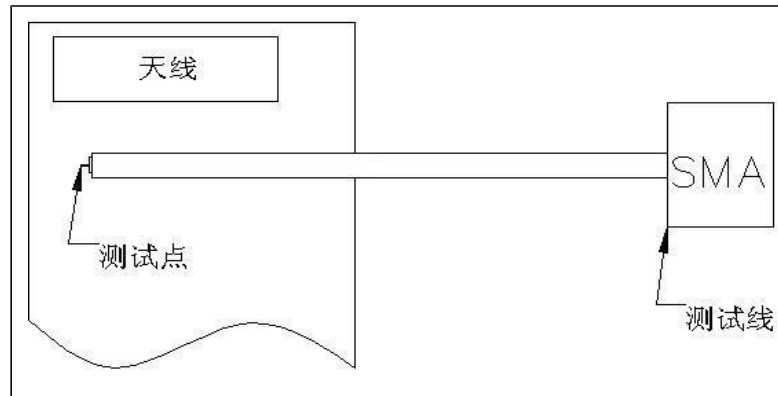

3. Matching circuits

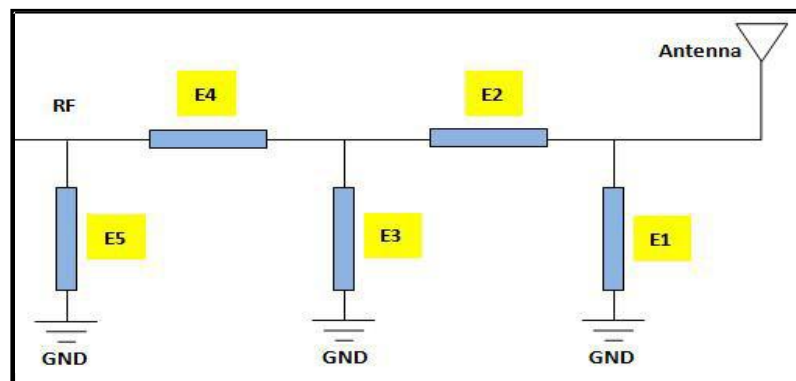

Element	Value	Specification
C160	0 Ω	
L84	NC	
R20	0 Ω	
L85	NC	

Shanghai Shangyuan Communication Technology Co., Ltd. antenna recognition

4. S11 test

1. S11 Test Method Description

Test Equipment: Network Analyzer (E5071C)

Test method: A 50 ohm CABLE cable is derived from the instrument test port, and the SMA connector of the prototype is connected after calibration using the calibrator to record the return loss and standing wave ratio corresponding to the relevant frequency point.

The test diagram is as follows:

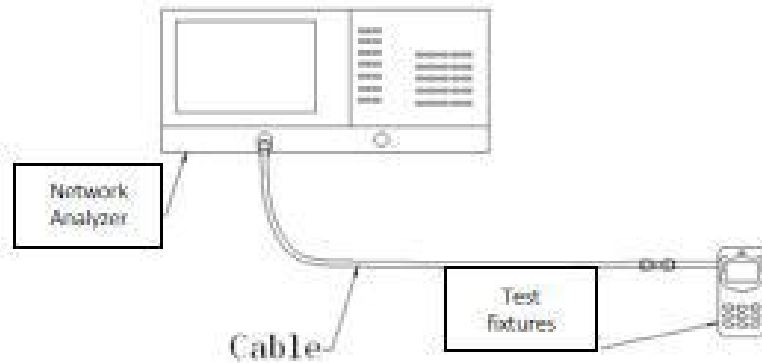

Test the schematic

4.2 S11 parameter

2.4g/5gwifi white 1 S11

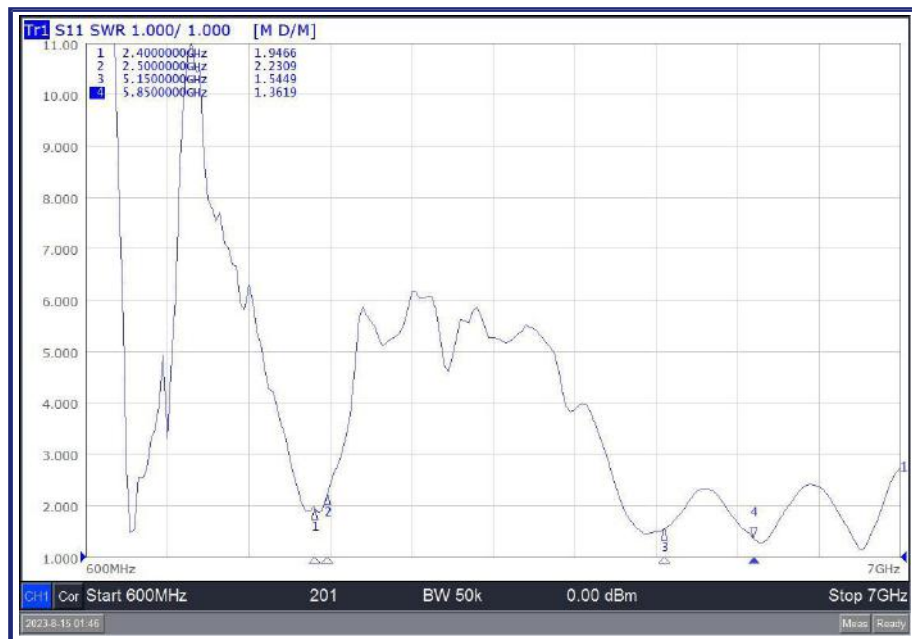

	main
frequency (MHz)	SWR
2400	1.9
2500	2.2
5150	1.5
5850	1.3

Shanghai Shangyuan Communication Technology Co., Ltd. antenna recognition

2.4g/5g WiFi white 2 S11

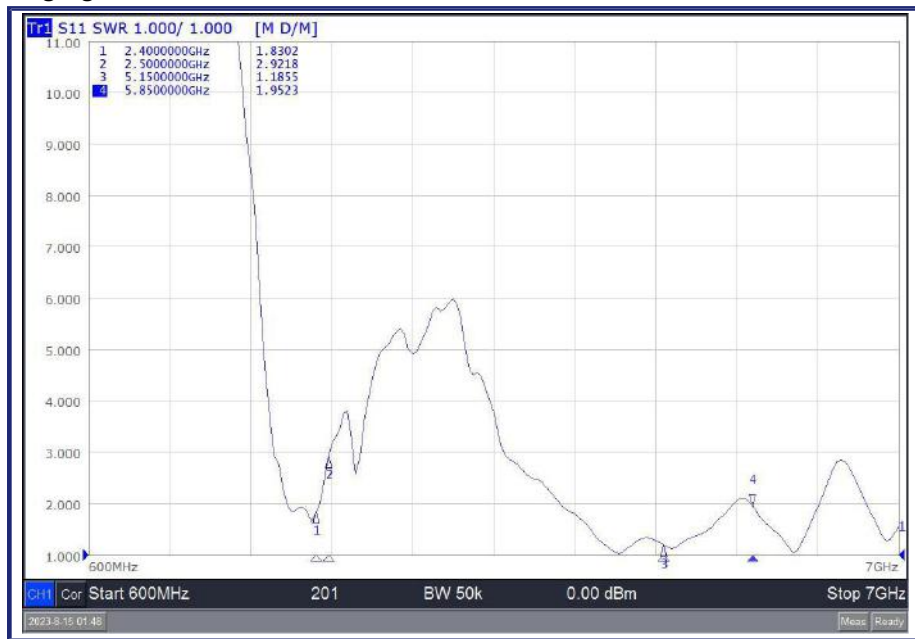

	main
frequency (MHz)	SWR
2400	1.8
2500	2.9
5150	1.1
5850	1.9

2.4g/5g WiFi black short S11

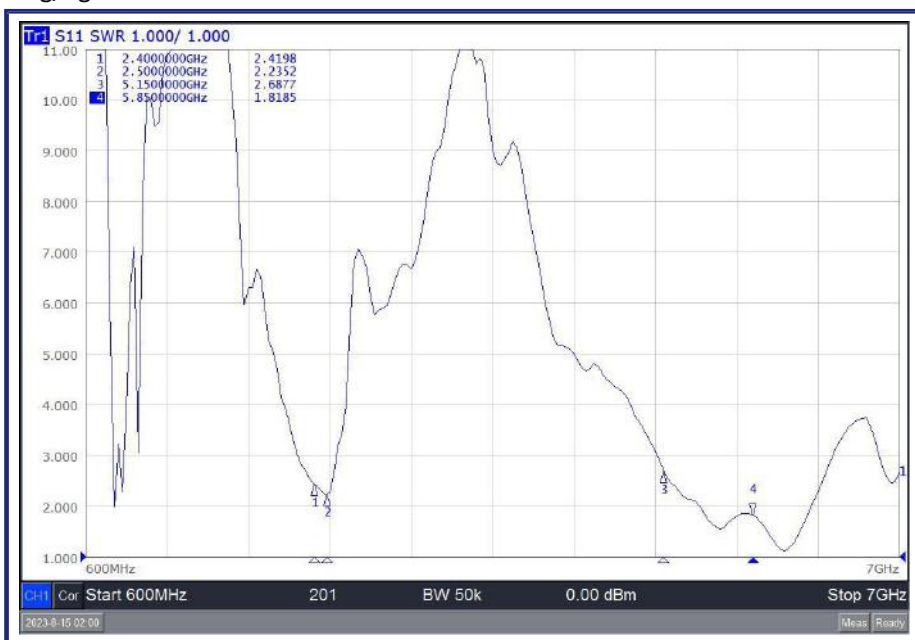

	main
frequency (MHz)	SWR
2400	2.4
2500	2.2
5150	2.6
5850	1.8

2.4g/5g WiFi black long S11

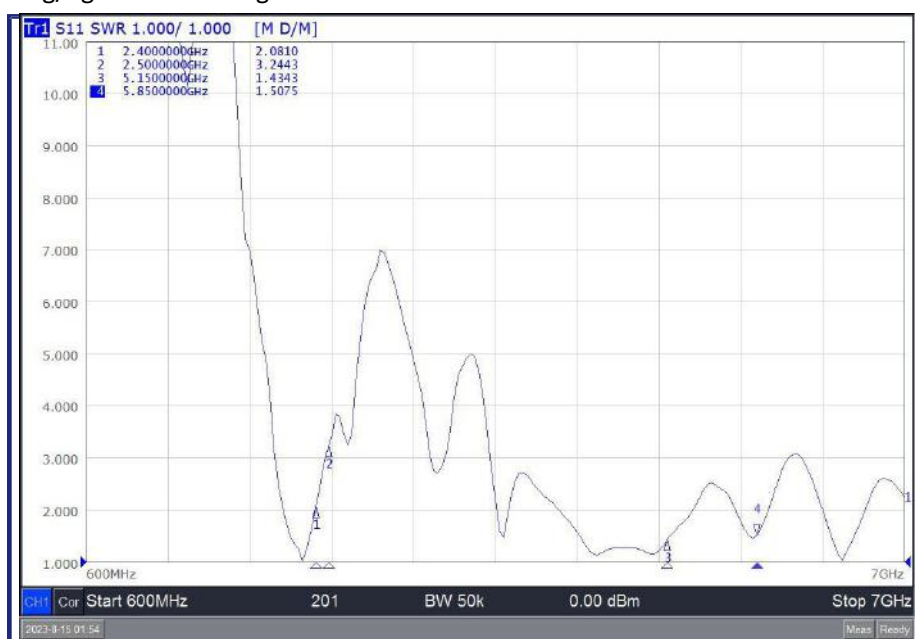

	main
frequency (MHz)	SWR
2400	2.0
2500	3.2
5150	1.4
5850	1.5

WiFi 6E black S11

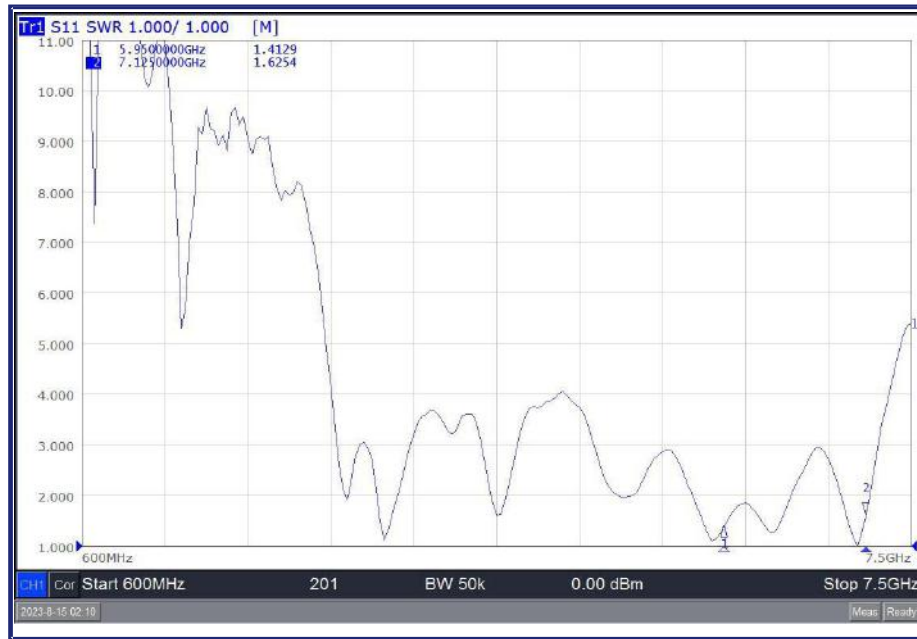

	main
frequency (MHz)	SWR
5950	1.4
7125	1.6

WiFi 6E white S11

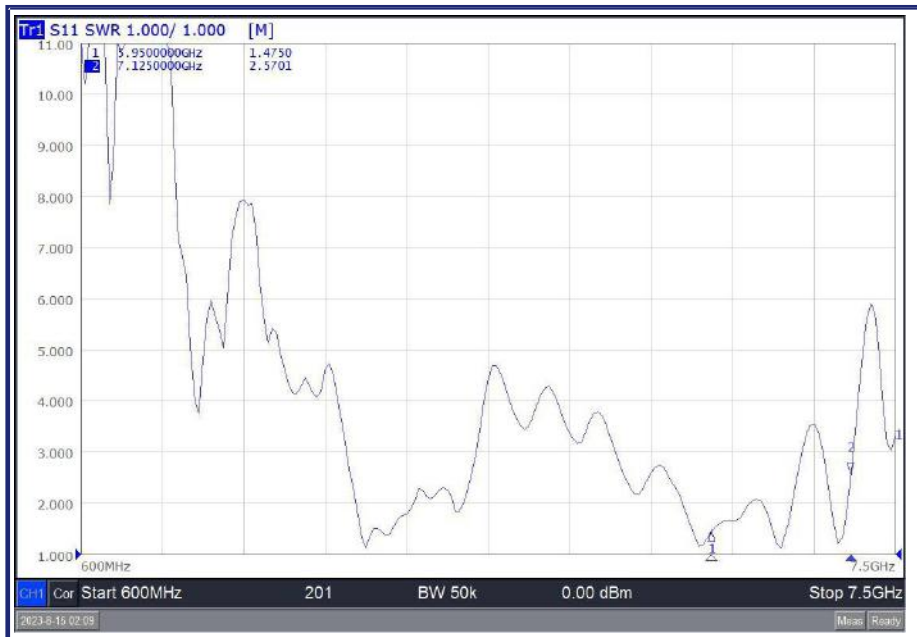

	main
frequency (MHz)	SWR
5950	1.4
7125	2.5

5 Darkroom test data

Test system: Shielded darkroom

Test environment: temperature $22^{\circ}\text{C}\pm 3^{\circ}\text{C}$, humidity $50\%\pm 15\%$

Test equipment: When testing passive data, use the Network Analyzer Agilent E5062C When testing active data, the Comprehensive Tester Agilent 8960 /CMW500/E4438C is used

5.1 Passive test data

2.4g/5gwifi white 1 antenna efficiency

Freq	Effi	Gain	Freq	Effi	Gain	Freq	Effi	Gain
(MHz)	(%)	(dBi)	(MHz)	(%)	(dBi)	(MHz)	(%)	(dBi)
2400	52.12	1.53	5150	43.55	3.81	5510	41.82	2.58
2410	52.97	0.73	5160	43.55	3.26	5520	41.82	2.33
2420	53.95	1.03	5170	42.81	3.34	5530	42.72	2.2
2430	52.12	1.43	5180	43.55	3.31	5540	41.99	1.82
2440	50.93	0.09	5190	43.83	3.43	5550	41.99	1.52
2450	50.7	0.28	5200	44.78	3.66	5560	41.9	1.25
2460	48.19	0.41	5210	44.88	3.27	5570	42.99	1.47
2470	49.32	0.04	5220	45.76	2.97	5580	43.64	1.5
2480	48.98	0.88	5230	45.85	2.74	5590	43.83	1.65
2490	49.32	1.03	5240	45.95	2.75	5600	44.78	1.66
2500	52	0.69	5250	45.85	2.58	5610	44.21	1.34
			5260	44.88	2.62	5620	43.64	1.46
			5270	44.02	2.31	5630	43.46	1.22
			5280	42.63	2.08	5640	43.55	1.31
			5290	41.19	1.79	5650	44.11	1.49
			5300	41.11	1.8	5660	44.21	1.26
			5310	40.76	1.47	5670	44.3	1.32
			5320	41.11	1.42	5680	44.69	1.13
			5330	40.5	1.71	5690	44.98	0.92
			5340	41.55	1.96	5700	43.55	0.57
			5350	40.93	1.61	5710	44.21	0.66
			5360	42.45	2.1	5720	44.4	1.05
			5370	43.46	2.35	5730	45.07	1.29
			5380	43.46	2.63	5740	44.59	1.03
			5390	43.83	2.73	5750	46.15	1.22
			5400	44.5	2.56	5760	45.66	1.37
			5410	43.18	2.59	5770	46.05	1.51
			5420	43.36	2.26	5780	45.95	1.37
			5430	44.21	2.35	5790	45.07	1.73
			5440	41.99	2.27	5800	45.87	1.96
			5450	43.36	2.3	5810	45.76	2.21
			5460	42.26	2.29	5820	44.86	2.11
			5470	41.37	2.21	5830	44.67	2.43
			5480	42.81	1.94	5840	45.08	2.53
			5490	41.9	2.27	5850	46.87	2.18
			5500	42.72	2.04			

Shanghai Shangyuan Communication Technology Co., Ltd. antenna recognition
2.4g/5gwifi white 1 antenna pattern

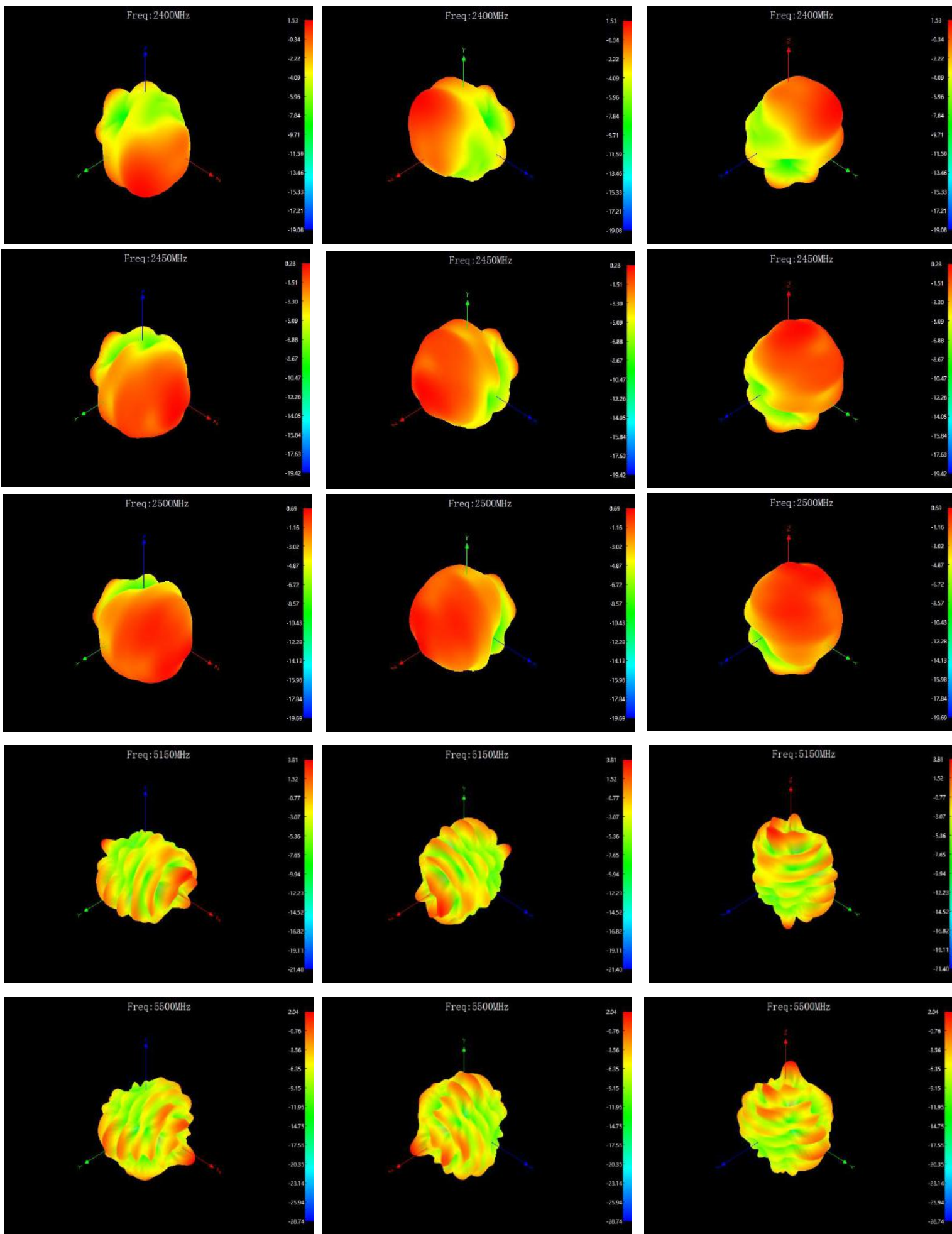

Shanghai Shangyuan Communication Technology Co., Ltd. antenna recognition
2.4g/5gwifi white 1 antenna patter

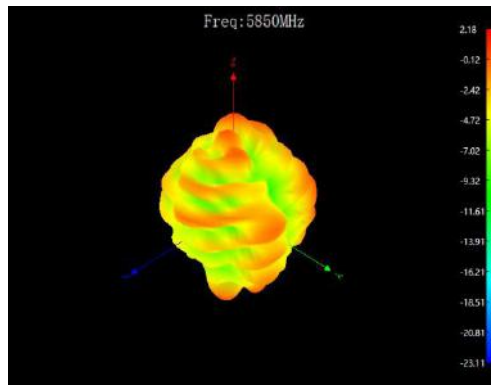
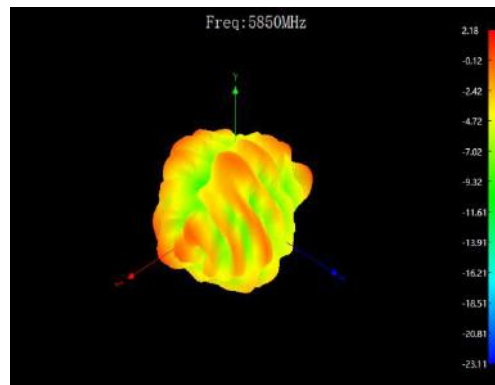
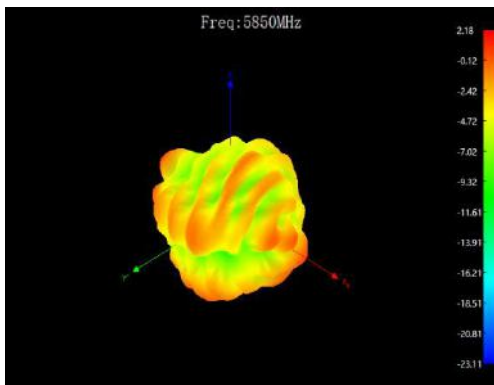

Shanghai Shangyuan Communication Technology Co., Ltd. antenna recognition

2.4g/5gwifi white 2 antenna efficiency

Freq	Effi	Gain	Freq	Effi	Gain	Freq	Effi	Gain
(MHz)	(%)	(dBi)	(MHz)	(%)	(dBi)	(MHz)	(%)	(dBi)
2400	55.21	1.63	5150	48.53	4.6	5510	42.07	1.96
2410	55.46	0.48	5160	48.87	4.26	5520	42.07	1.71
2420	56.1	0.84	5170	47.53	4.74	5530	42.66	1.69
2430	53.95	0.9	5180	48.08	4.53	5540	42.56	1.49
2440	53.46	-0.61	5190	47.53	4.55	5550	43.05	1.61
2450	54.08	0.46	5200	47.53	4.83	5560	43.15	1.47
2460	50.82	0.02	5210	47.75	4.61	5570	44.57	1.63
2470	50.35	-0.29	5220	48.31	4.25	5580	45.29	1.55
2480	48.19	0.18	5230	48.08	4.2	5590	44.67	1.34
2490	46.24	-0.15	5240	48.75	4.04	5600	45.5	1.26
2500	47.97	0.02	5250	49.55	4.14	5610	44.67	1.16
			5260	49.43	4.41	5620	42.27	0.94
			5270	49.43	4.49	5630	41.69	0.76
			5280	48.98	4.57	5640	40.83	0.84
			5290	47.64	4.31	5650	40.18	0.93
			5300	47.21	4.12	5660	40.09	0.9
			5310	46.34	3.6	5670	39.99	0.98
			5320	45.39	3.2	5680	40.18	0.97
			5330	44.57	3.4	5690	41.11	0.83
			5340	44.77	3.35	5700	39.81	0.65
			5350	42.66	3.03	5710	41.5	0.66
			5360	44.36	3.22	5720	42.46	1.01
			5370	45.08	3.34	5730	43.25	1.29
			5380	44.67	3.34	5740	42.76	1.13
			5390	45.6	3.53	5750	43.95	1.16
			5400	47.1	3.25	5760	43.45	1.42
			5410	46.56	3.76	5770	42.76	1.32
			5420	48.08	3.58	5780	41.98	1.04
			5430	48.87	3.46	5790	40.74	1.19
			5440	46.88	3.29	5800	42.07	1.2
			5450	48.19	3.22	5810	40.18	1.47
			5460	46.67	2.74	5820	41.3	1.57
			5470	44.67	2.72	5830	41.78	1.96
			5480	45.29	2.28	5840	42.36	2.21
			5490	43.35	2.21	5850	45.6	2.16
			5500	43.25	1.74			

Shanghai Shangyuan Communication Technology Co., Ltd. antenna recognition
2.4g/5gwifi white 2 antenna pattern

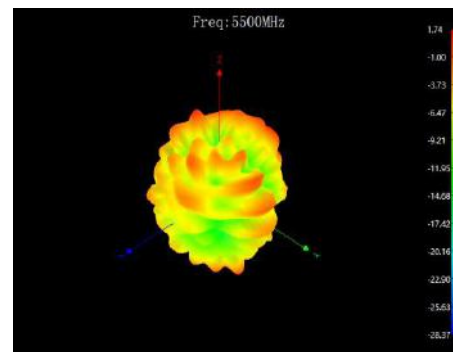
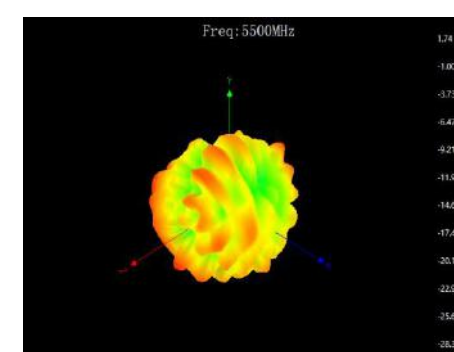
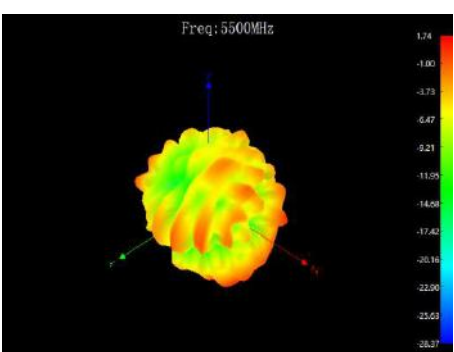
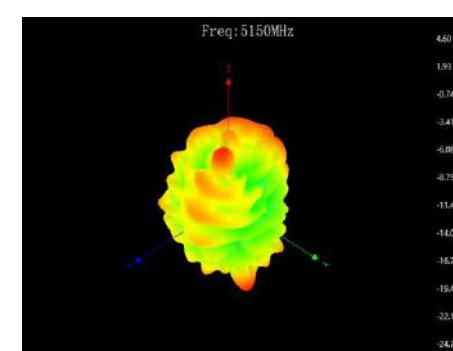
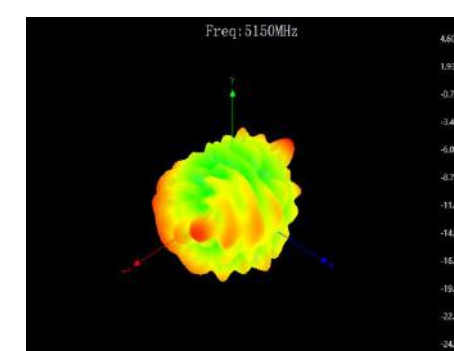
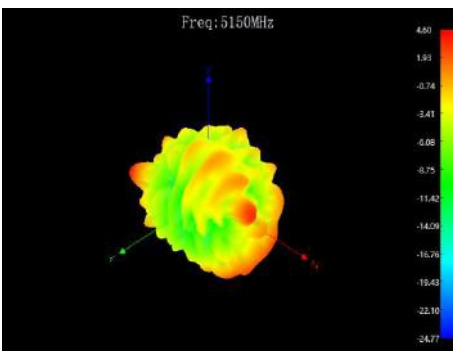
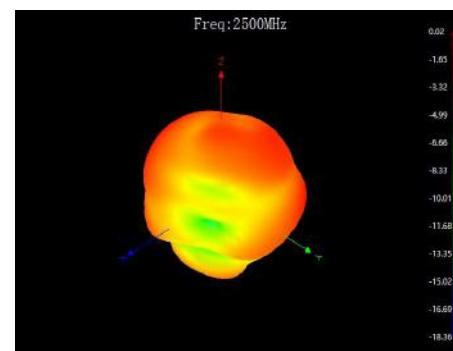
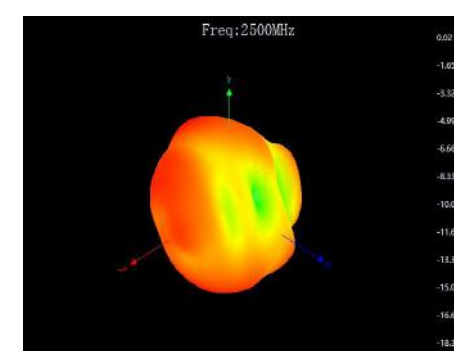
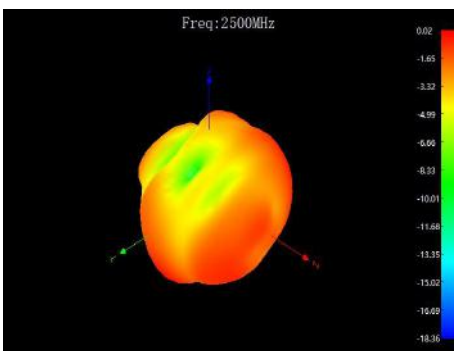
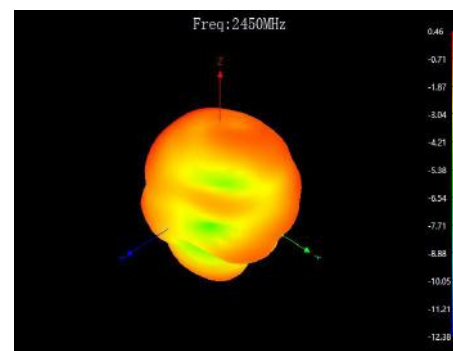
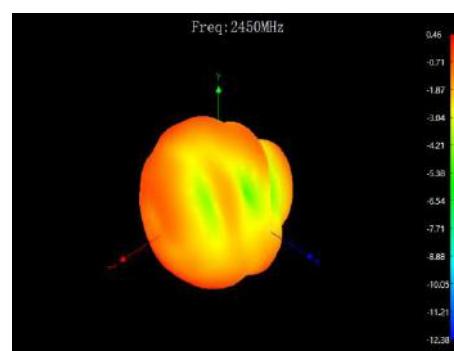
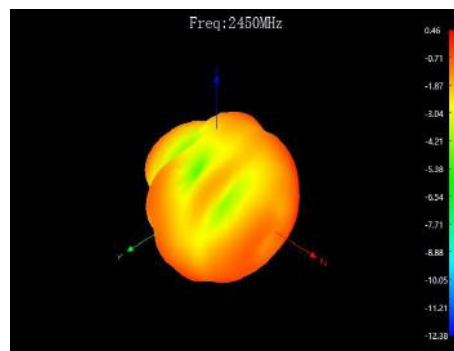
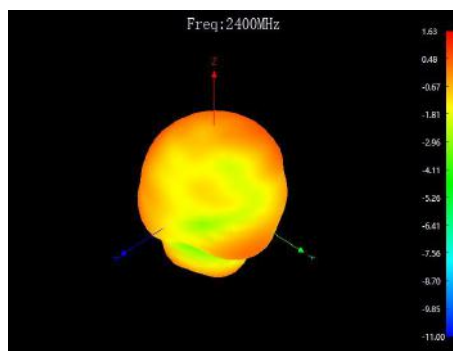
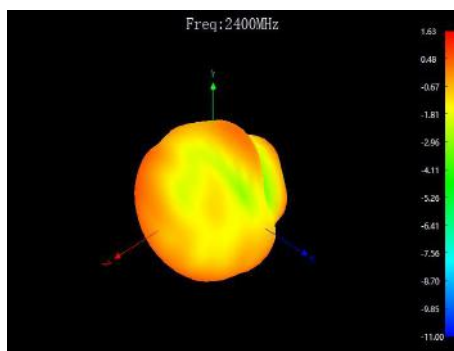
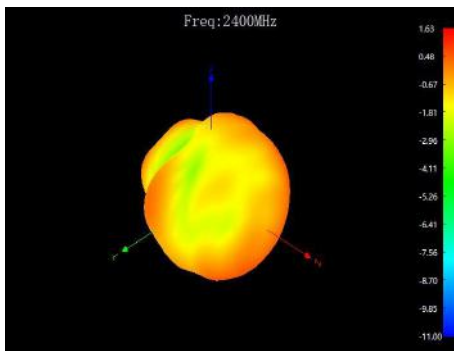

Shanghai Shangyuan Communication Technology Co., Ltd. antenna recognition
2.4g/5gwifi white 2 antenna pattern

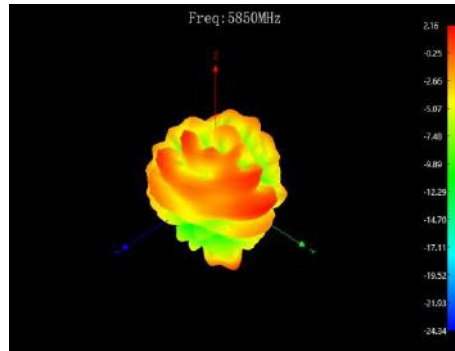
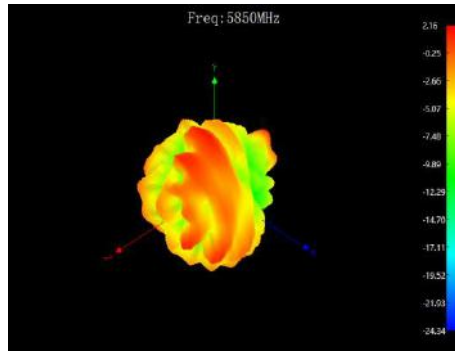
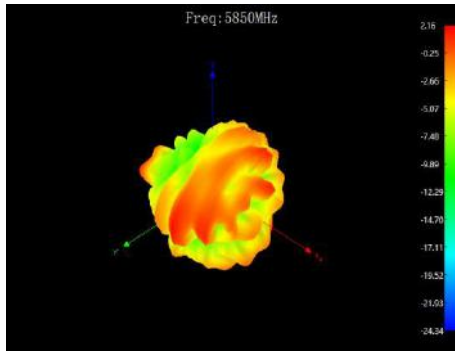

Shanghai Shangyuan Communication Technology Co., Ltd. antenna recognition

2. 4g/5gwifi black short antenna efficiency

Freq	Effi	Gain	Freq	Effi	Gain	Freq	Effi	Gain
(MHz)	(%)	(dBi)	(MHz)	(%)	(dBi)	(MHz)	(%)	(dBi)
2400	52.12	1.18	5150	42.98	4.73	5510	48.87	3.24
2410	53.83	0.53	5160	43.75	5.34	5520	48.19	2.71
2420	56.49	1.52	5170	43.95	5.09	5530	48.98	2.72
2430	54.33	1.58	5180	44.57	5.28	5540	48.19	2.38
2440	53.83	0.58	5190	44.36	5.38	5550	48.42	2.09
2450	56.1	1.57	5200	44.36	5.24	5560	48.53	2.14
2460	53.58	1.24	5210	44.16	5.07	5570	50.23	2.21
2470	55.08	1.04	5220	44.98	5.12	5580	50.58	2.17
2480	55.34	2.25	5230	44.46	4.88	5590	50.23	2.22
2490	53.7	1.74	5240	44.46	4.84	5600	51.64	2.21
2500	56.36	2.24	5250	44.87	4.84	5610	51.17	2.08
			5260	44.57	4.75	5620	50.47	2.35
			5270	44.87	4.63	5630	50.47	2.22
			5280	44.67	4.39	5640	50.47	2.16
			5290	44.67	4.46	5650	50.47	2.32
			5300	45.5	4.23	5660	50.47	2.38
			5310	45.92	4.25	5670	50.12	2.61
			5320	46.24	4.3	5680	49.89	2.53
			5330	46.13	4.06	5690	50.47	2.71
			5340	47.21	4.47	5700	48.31	2.19
			5350	45.71	3.93	5710	48.98	2.14
			5360	47.64	4.1	5720	49.55	2.38
			5370	48.64	4.52	5730	50	2.44
			5380	47.97	4.17	5740	49.2	2.11
			5390	47.53	3.74	5750	50.58	2.16
			5400	48.98	4.21	5760	50.23	2.29
			5410	47.42	3.73	5770	50.12	2.36
			5420	48.53	3.42	5780	49.66	2.21
			5430	49.89	3.93	5790	48.31	2.03
			5440	47.97	3.26	5800	50.35	2.12
			5450	49.89	3.57	5810	48.31	2.59
			5460	49.66	3.56	5820	49.32	2.41
			5470	48.42	3.2	5830	49.43	2.83
			5480	50.58	3.22	5840	49.66	2.75
			5490	49.43	3	5850	52.48	2.05
			5500	49.77	2.79			

Shanghai Shangyuan Communication Technology Co., Ltd. antenna recognition
2.4g/5gwifi black short antenna pattern

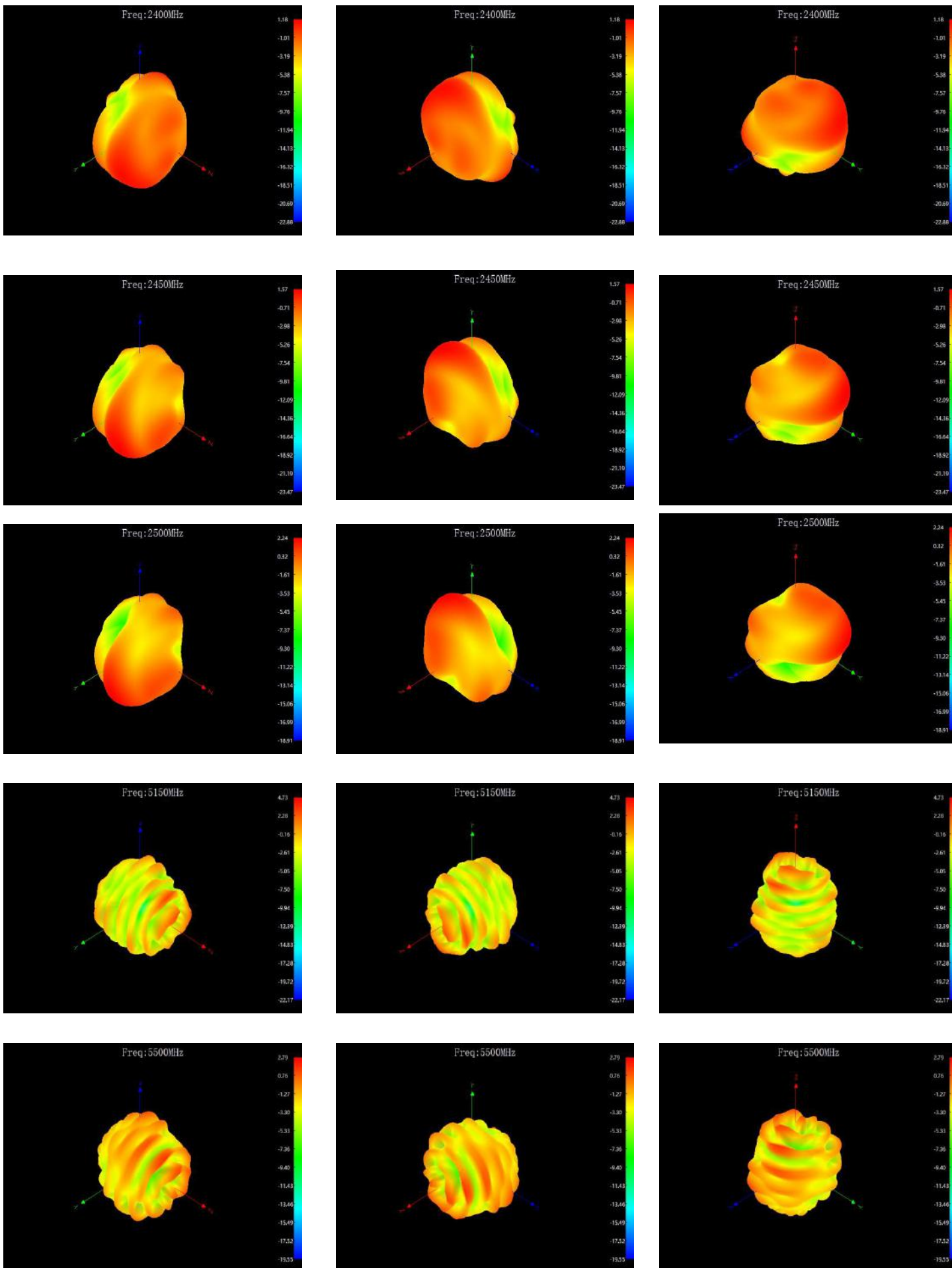

Shanghai Shangyuan Communication Technology Co., Ltd. antenna recognition
2.4g/5gwifi black short antenna pattern

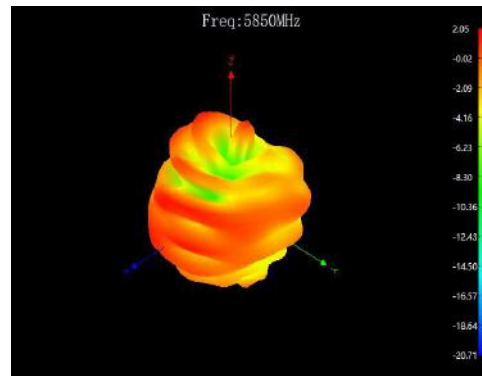
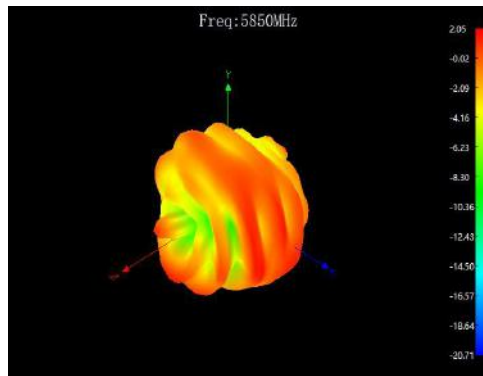
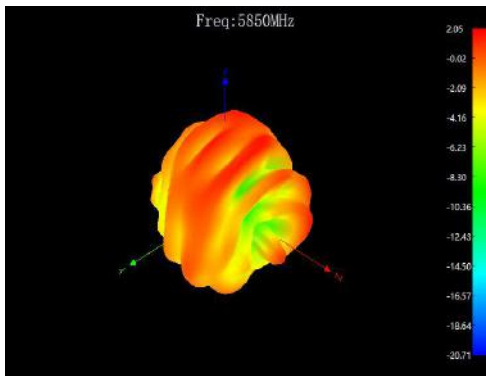

Shanghai Shangyuan Communication Technology Co., Ltd. antenna recognition

2. 4g/5gwifi black long antenna efficiency

Freq	Effi	Gain	Freq	Effi	Gain	Freq	Effi	Gain
(MHz)	(%)	(dBi)	(MHz)	(%)	(dBi)	(MHz)	(%)	(dBi)
2400	59.98	1.65	5150	46.99	4.06	5510	42.46	3
2410	60.67	1.08	5160	47.32	3.74	5520	42.56	2.67
2420	61.8	1.23	5170	45.6	3.73	5530	43.45	2.54
2430	58.75	2.02	5180	46.45	3.68	5540	42.76	2.31
2440	56.75	0.4	5190	46.34	3.48	5550	42.76	2.29
2450	55.85	0.31	5200	46.88	3.29	5560	42.27	2.38
2460	52.24	1.04	5210	47.32	3.33	5570	43.25	2.56
2470	51.52	-0.28	5220	48.31	3.02	5580	43.55	2.65
2480	49.77	0.02	5230	47.86	2.88	5590	43.05	2.57
2490	48.31	-0.02	5240	47.97	2.89	5600	43.95	2.65
2500	48.75	-0.51	5250	47.75	2.81	5610	43.45	2.38
			5260	46.45	2.87	5620	42.46	2.42
			5270	45.5	2.72	5630	42.85	2.47
			5280	44.26	2.87	5640	43.15	2.61
			5290	45.46	2.59	5650	43.35	2.88
			5300	45.17	2.51	5660	43.85	3.08
			5310	44.69	2.44	5670	43.75	3.23
			5320	44.4	2.29	5680	43.75	3.36
			5330	43.93	2.53	5690	44.26	3.31
			5340	44.88	2.63	5700	42.17	2.99
			5350	43.83	2.39	5710	42.36	2.83
			5360	42.85	2.74	5720	42.66	3.22
			5370	43.65	3.05	5730	42.95	3.2
			5380	43.55	3.29	5740	42.07	3.02
			5390	43.75	3.33	5750	43.25	3.01
			5400	44.57	3.13	5760	43.55	3.3
			5410	43.15	3.17	5770	44.06	3.28
			5420	44.26	2.86	5780	44.67	3.15
			5430	44.87	2.88	5790	44.06	3.27
			5440	43.05	3	5800	46.13	2.98
			5450	44.16	3.04	5810	44.87	3.45
			5460	43.25	2.92	5820	45.81	3.23
			5470	41.98	2.92	5830	45.39	3.55
			5480	43.45	2.6	5840	45.08	3.42
			5490	42.46	2.79	5850	46.56	2.75
			5500	42.85	2.52			

Shanghai Shangyuan Communication Technology Co., Ltd. antenna recognition
2.4g/5gwifi black long antenna pattern

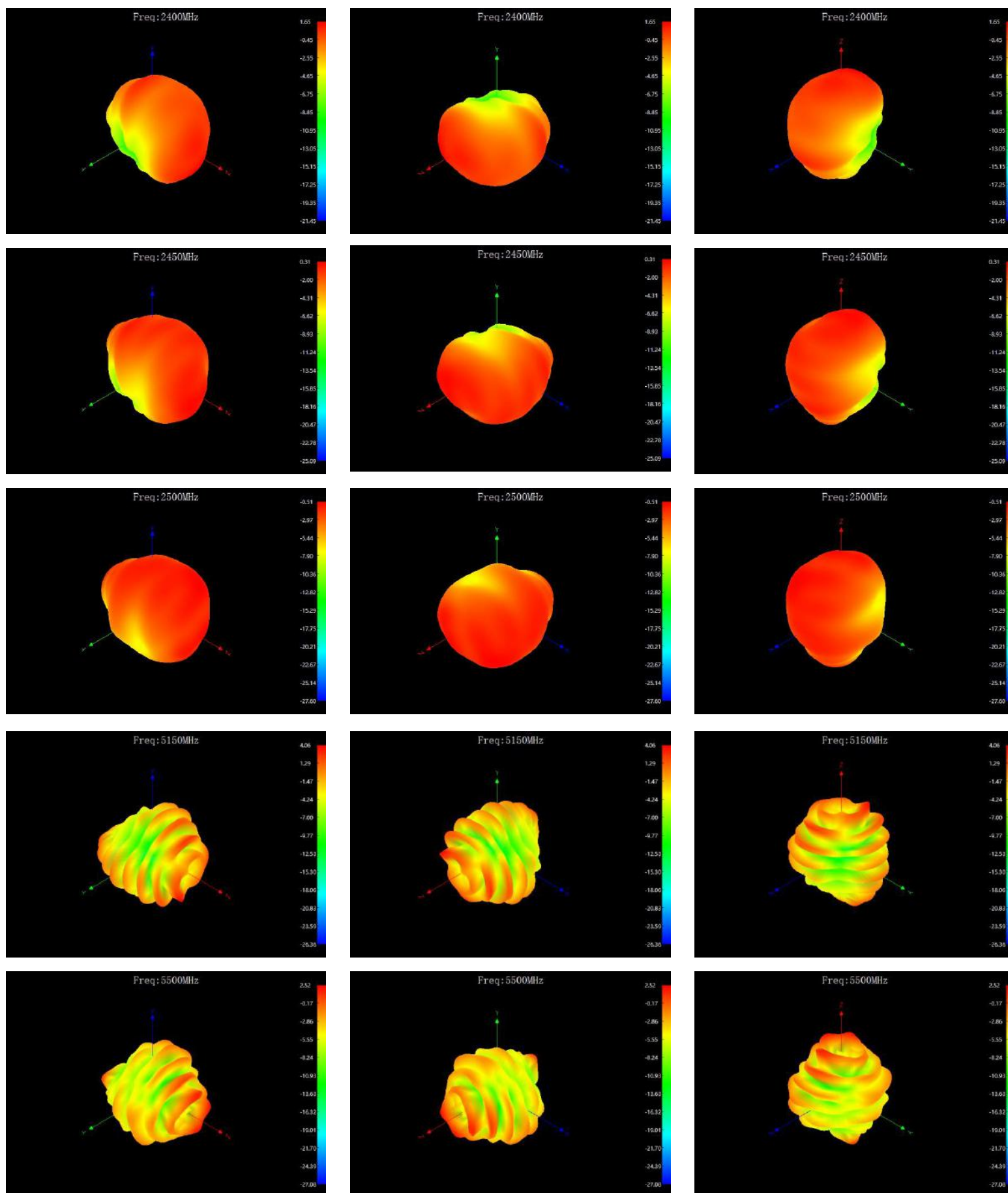

Shanghai Shangyuan Communication Technology Co., Ltd. antenna recognition
2.4g/5gwifi black long antenna pattern

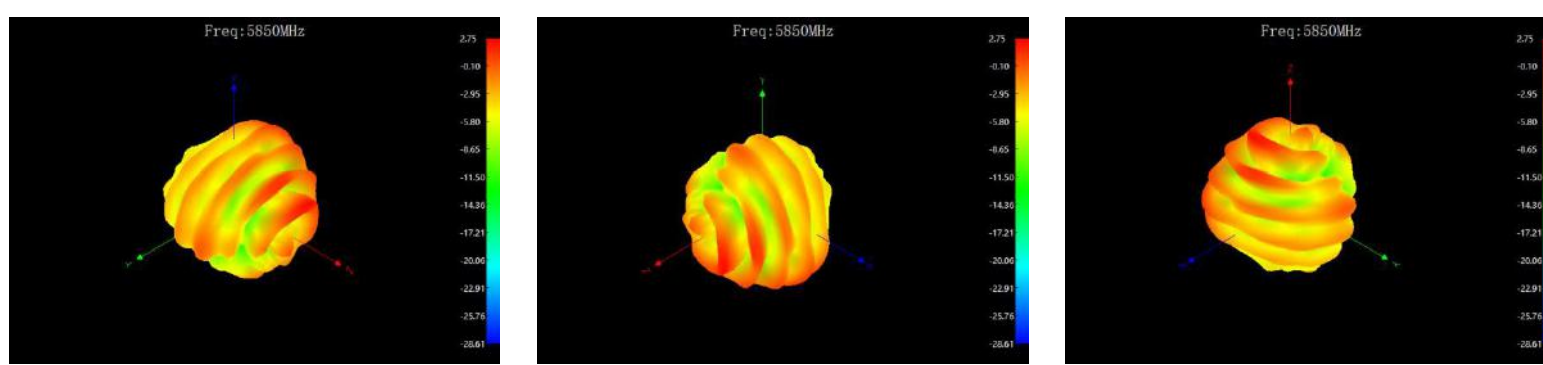

Shanghai Shangyuan Communication Technology Co., Ltd. antenna recognition

WiFi 6E black antenna efficiency

Freq	Effi	Gain	Freq	Effi	Gain	Freq	Effi	Gain	Freq	Effi	Gain
(MHz)	(%)	(dBi)	(MHz)	(%)	(dBi)	(MHz)	(%)	(dBi)	(MHz)	(%)	(dBi)
5950	44.77	2.31	6300	41.21	2.27	6660	46.34	2.66	7020	41.72	0.46
5960	45.08	2.89	6310	41.02	2.29	6670	48.08	3.07	7030	41.44	0.18
5970	45.08	2.44	6320	40.83	2.15	6680	46.77	2.77	7040	41.31	0.34
5980	43.85	2.62	6330	39.99	1.76	6690	45.65	2.03	7050	42.06	0.63
5990	43.55	2.45	6340	39.17	1.46	6700	45.78	1.59	7060	42.81	0.81
6000	43.35	1.59	6350	40.93	1.71	6710	46.36	1.98	7070	43.27	1.14
6010	42.85	1.56	6360	40.74	1.36	6720	47.67	2.29	7080	44.28	1.38
6020	42.36	1.84	6370	40.64	1.38	6730	46.73	2.45	7090	44.59	1.4
6030	42.17	1.83	6380	41.5	1.14	6740	45.73	2.58	7100	45.97	1.56
6040	43.25	1.92	6390	41.98	1.34	6750	45.16	2.73	7110	43.04	1.57
6050	43.35	1.68	6400	42.36	1.59	6760	44.75	2.97	7120	42.06	1.73
6060	43.05	1.96	6410	42.95	1.41	6770	44.67	2.55			
6070	42.17	2.14	6420	42.95	1.31	6780	45.56	2.83			
6080	43.75	2.16	6430	42.95	1.75	6790	47.5	3.23			
6090	43.85	2.32	6440	42.66	1.82	6800	46.81	2.34			
6100	43.05	2.82	6450	40.83	2.16	6810	46.9	2.29			
6110	44.46	2.22	6460	42.27	2.43	6820	46.31	2.67			
6120	45.39	2.27	6470	42.36	2.45	6830	45.73	2.75			
6130	45.29	2.17	6480	42.85	2.39	6840	43.04	2.4			
6140	43.25	2.12	6490	43.15	1.8	6850	41.84	2.81			
6150	44.26	1.85	6500	46.34	2	6860	40.06	2.48			
6160	40.93	1.81	6510	45.81	1.89	6870	39.31	2.22			
6170	42.36	1.88	6520	48.64	2.12	6880	37.04	1.73			
6180	39.54	1.9	6530	45.6	2.24	6890	38.31	2.18			
6190	41.11	1.76	6540	48.31	1.76	6900	38.12	1.64			
6200	43.25	1.67	6550	46.99	1.71	6910	39.44	1.53			
6210	42.27	1.57	6560	48.31	1.98	6920	39.44	1.07			
6220	40.18	1.47	6570	46.34	1.67	6930	41.62	1.55			
6230	41.88	1.65	6580	45.81	2.32	6940	42.66	1.41			
6240	40.83	1.66	6590	42.95	2.63	6950	43.19	1.16			
6250	42.27	1.98	6600	43.25	2.78	6960	42.51	1.08			
6260	41.5	1.9	6610	41.5	2.51	6970	43.42	1.42			
6270	43.85	1.94	6620	42.76	2.4	6980	42.66	1.01			
6280	42.76	2.4	6630	42.66	2.19	6990	40.97	0.55			
6290	43.05	2.42	6640	44.26	2.48	7000	41.99	0.58			
6300	41.21	2.27	6650	45.08	2.28	7010	41.38	0.49			

Shanghai Shangyuan Communication Technology Co., Ltd. antenna recognition
WiFi 6E black antenna pattern

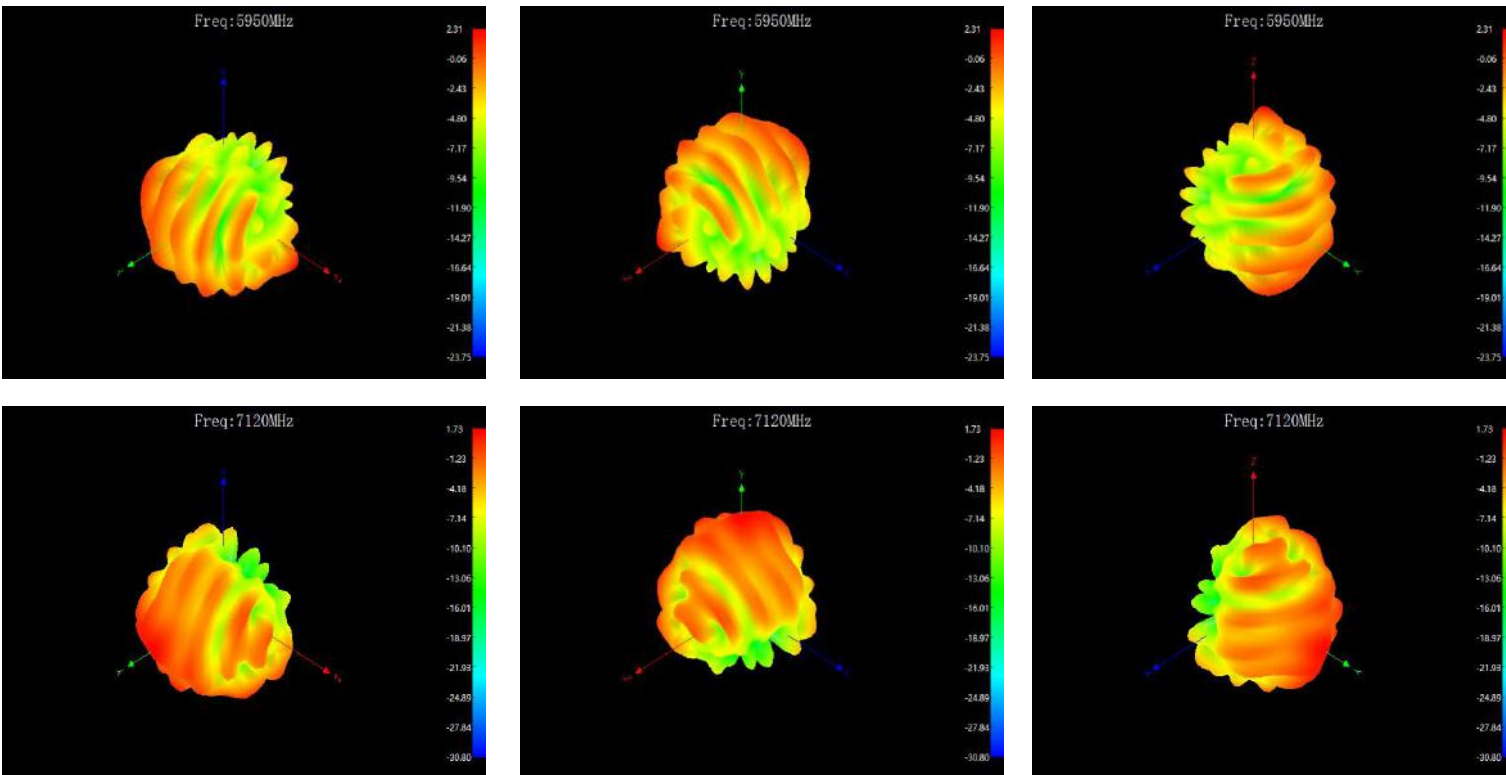

Shanghai Shangyuan Communication Technology Co., Ltd. antenna recognition

WiFi 6E white antenna efficiency

Freq	Effi	Gain	Freq	Effi	Gain	Freq	Effi	Gain	Freq	Effi	Gain
(MHz)	(%)	(dBi)	(MHz)	(%)	(dBi)	(MHz)	(%)	(dBi)	(MHz)	(%)	(dBi)
5950	44.99	2.14	6300	42.5	2.28	6660	51.99	3.17	7020	44.26	0.26
5960	45.09	2.67	6310	43.11	2.28	6670	53.08	3.61	7030	43.46	-0.27
5970	45.18	2.27	6320	42.67	2.42	6680	50.71	3.28	7040	43.28	0.16
5980	44.08	2.59	6330	42.07	2.08	6690	47.07	2.63	7050	43.99	0.43
5990	43.46	2.78	6340	43.99	1.37	6700	45.55	2.2	7060	46.59	0.87
6000	42.93	1.81	6350	43.64	1.88	6710	44.36	2.37	7070	47.27	0.93
6010	42.58	1.71	6360	43.28	1.51	6720	44.45	2.3	7080	48.35	1.24
6020	42.07	2.11	6370	43.37	1.47	6730	45.09	2.36	7090	48.85	1.22
6030	41.81	1.85	6380	43.28	1.37	6740	45.18	2.18	7100	50.71	1.52
6040	42.76	1.75	6390	43.46	1.57	6750	45.93	2.19	7110	48.55	1.22
6050	42.76	1.45	6400	44.17	1.99	6760	46.4	2.49	7120	48.35	1.66
6060	42.58	1.85	6410	44.36	1.84	6770	46.11	2.06			
6070	41.48	2.04	6420	45.18	1.76	6780	47.56	2.27			
6080	42.93	1.89	6430	45.93	2.05	6790	49.16	2.95			
6090	43.19	2.1	6440	45.83	2.1	6800	47.95	2			
6100	42.41	2.67	6450	48.35	2.39	6810	47.85	2.24			
6110	43.64	2.23	6460	49.06	2.63	6820	46.88	2.59			
6120	44.36	2.5	6470	49.36	2.63	6830	46.69	2.35			
6130	43.64	2.61	6480	49.06	2.55	6840	44.81	2.02			
6140	41.73	2.27	6490	50.29	2.02	6850	44.17	2			
6150	42.24	2.24	6500	48.35	2.57	6860	42.67	1.75			
6160	41.67	2.39	6510	49.46	2.63	6870	41.98	1.39			
6170	42.48	2.32	6520	45.18	3.07	6880	39.51	0.94			
6180	40.42	2.52	6530	46.69	3.44	6890	41.48	1.3			
6190	41.67	2.3	6540	45.36	3.06	6900	41.22	0.84			
6200	42.97	1.88	6550	47.07	3.06	6910	42.5	0.78			
6210	41.91	2.13	6560	46.21	3.38	6920	42.24	0.64			
6220	40.73	2.01	6570	47.36	2.76	6930	44.72	1.32			
6230	42.08	2.23	6580	46.69	3.36	6940	46.21	0.93			
6240	41.43	2.24	6590	48.85	3.43	6950	46.3	0.93			
6250	42.65	2.27	6600	48.95	3.27	6960	45.46	0.76			
6260	42.24	2.44	6610	51.03	2.82	6970	47.46	0.84			
6270	42.33	2.08	6620	50.5	2.63	6980	47.17	0.73			
6280	42.15	2.41	6630	51.56	2.5	6990	45.18	0.33			
6290	42.93	2.72	6640	51.77	2.68	7000	44.54	-0.03			
6300	42.24	2.28	6650	51.82	2.7	7010	44.26	-0.02			

Shanghai Shangyuan Communication Technology Co., Ltd. antenna recognition
WiFi 6E white antenna pattern

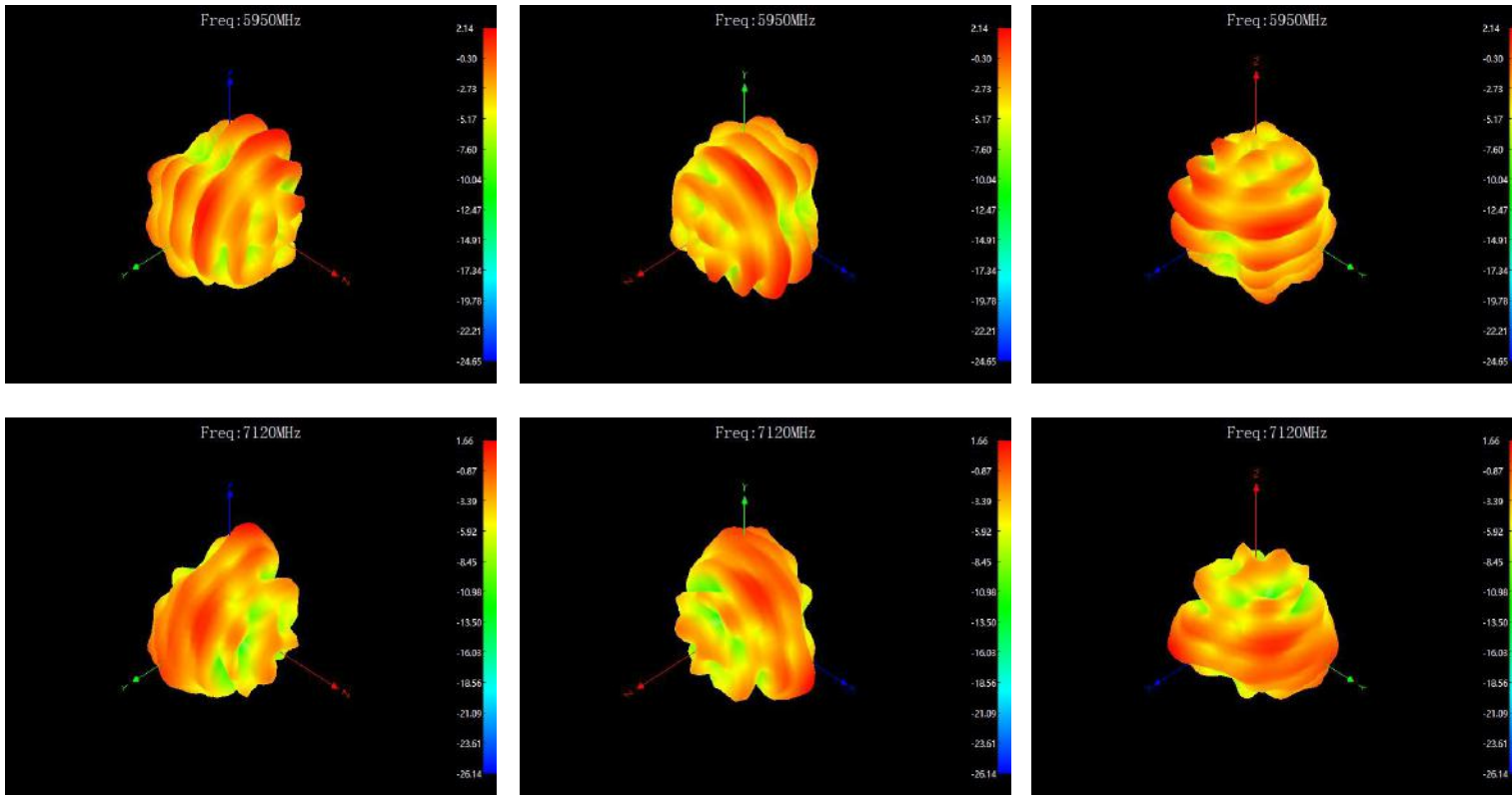

6. Mass production antenna indicators

When the antenna is mass-produced, the standing wave ratio is used as the mass production test standard. According to the differences in the project itself, the following criteria are given:

frequency (MHz)	量产标准
2400MHz-2500MHz 5150MHz-5850MHz	VSWR (Mass production performance) <VSWR(Acknowledge performance)+1
5950MHz-7120MHz	VSWR (Mass production performance) <VSWR(Acknowledge performance)+1

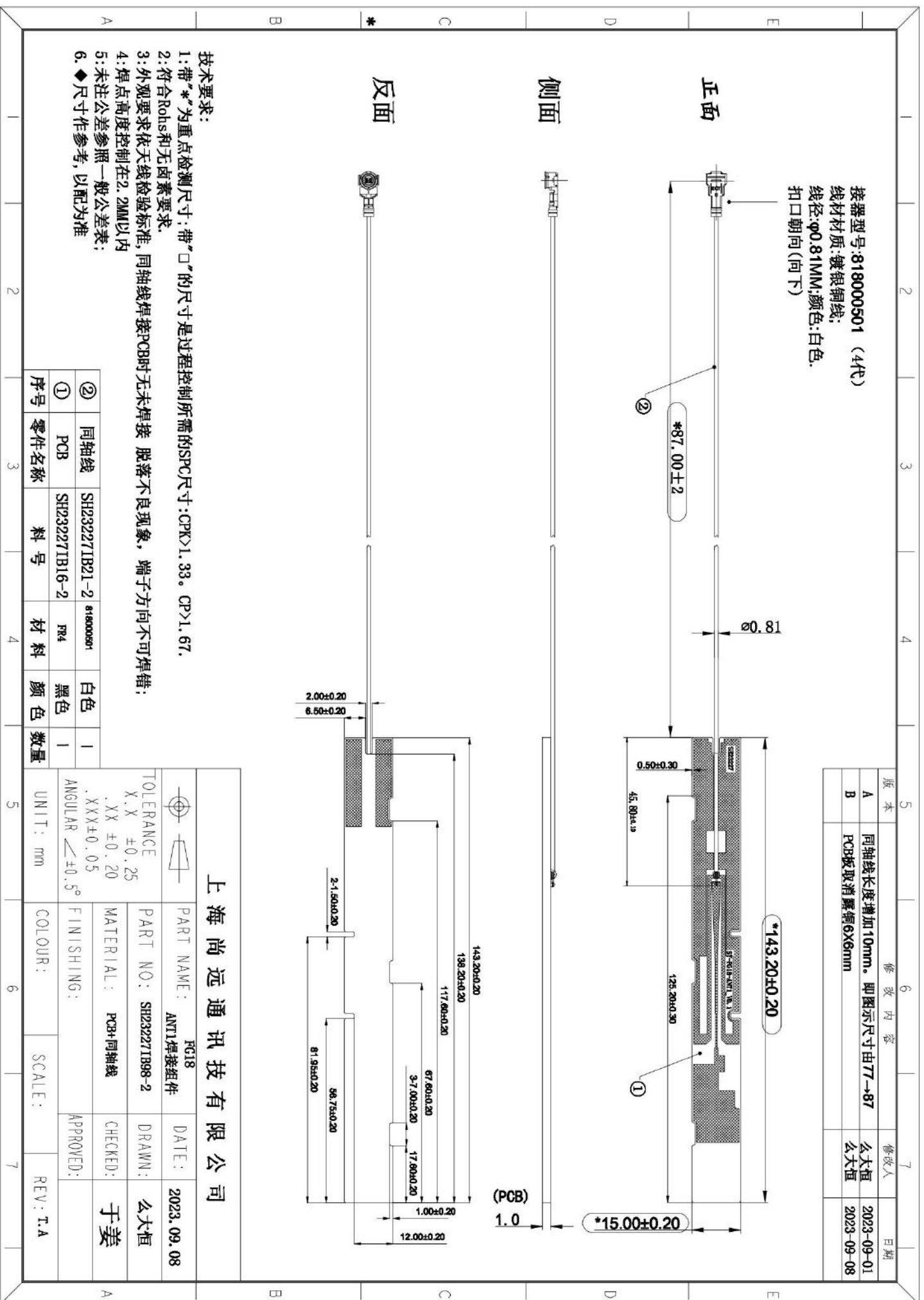

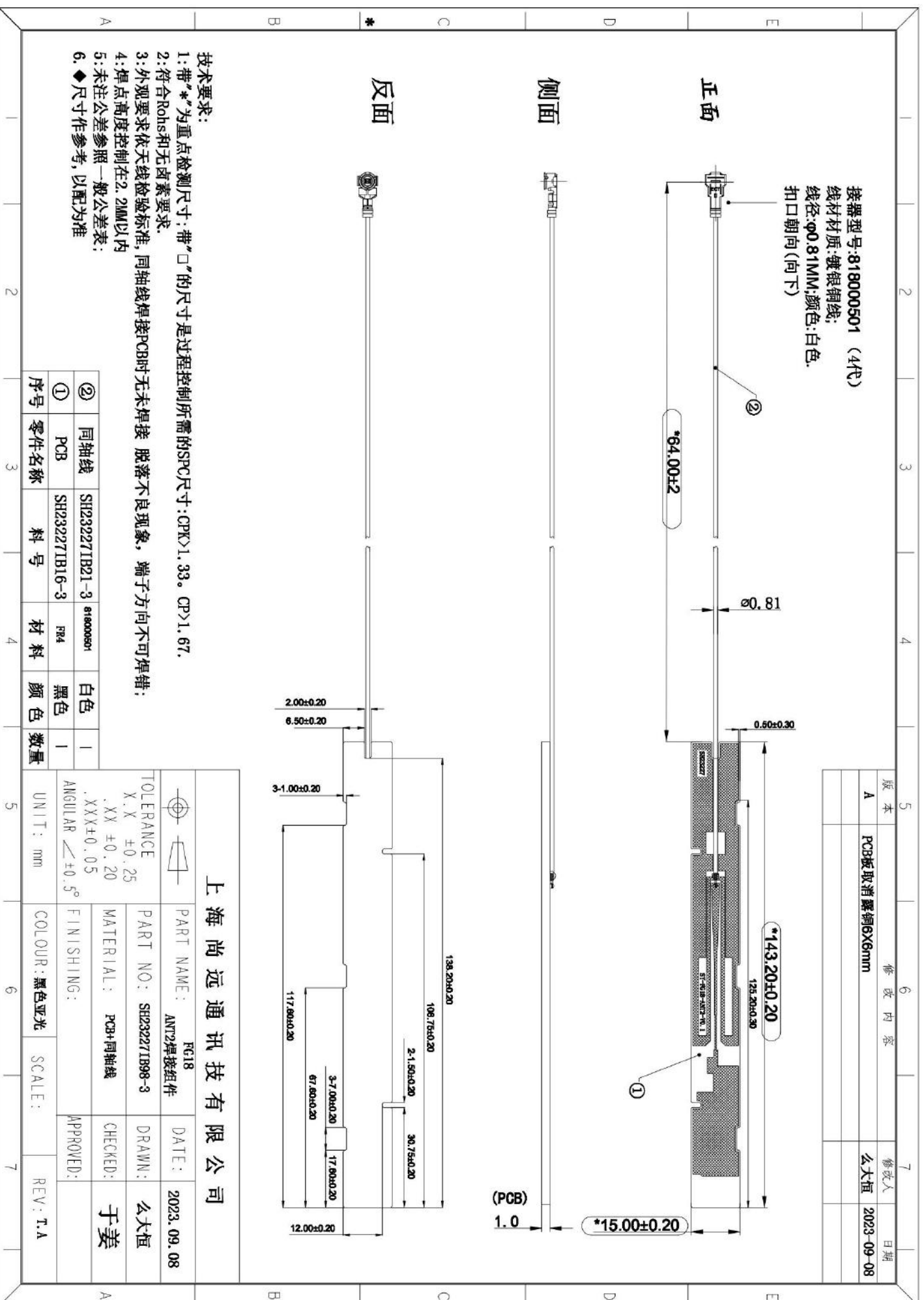

版本	修改内容	修改人	日期
C	同轴线长度减短8mm。即图示尺寸由71→63	么大恒	2023-10-11

接器型号:818000501 (4代)
 线材材质:镀银铜线;
 线径:φ0.81MM;颜色:黑色.
 扣口朝向(向下)

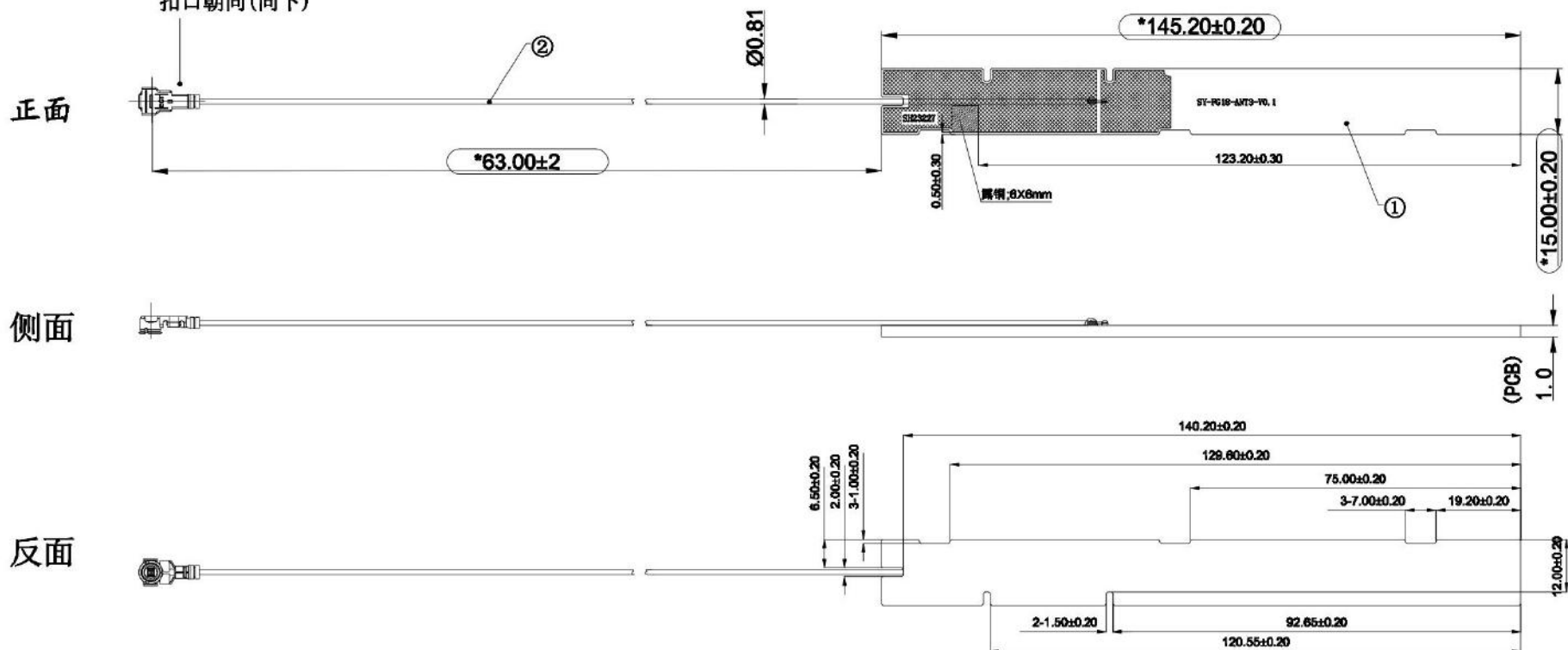

技术要求:

- 1: 带"*"为重点检测尺寸; 带"□"的尺寸是过程控制所需的SPC尺寸: CPK>1.33. CP>1.67.
- 2: 符合RoHS和无卤素要求.
- 3: 外观要求依天线检验标准, 同轴线焊接PCB时无未焊接 脱落不良现象, 端子方向不可焊错;
- 4: 焊点高度控制在2.2MM以内
- 5: 未注公差参照一般公差表;
- 6: ◆尺寸作参考, 以配为准

②	同轴线	SH23227IB21-4	818000501	黑色	1
①	PCB	SH23227IB16-4	FR4	黑色	1
序号	零件名称	料号	材料	颜色	数量

上海尚远通讯技术有限公司

	PART NAME: FG18 ANT3焊接组件	DATE: 2023. 10. 11
	TOLERANCE X.X ±0.25 .XX ±0.20 .XXX±0.05 ANGULAR <±0.5°	PART NO: SH23227IB98-4
	MATERIAL: PCB+同轴线	CHECKED: 于姜
	FINISHING:	APPROVED:
UNIT: mm	COLOUR: 黑色亚光	SCALE: REV: T.A

版本	修改内容	修改人	日期
A	显示丝印增加至另一面	么大恒	2023-09-01

双面黑色油墨

正面

接器型号:818000189 (1代)

线材材质:镀银铜线;

线径:φ1.37MM;颜色:白色.

扣口朝向(向下)

反面

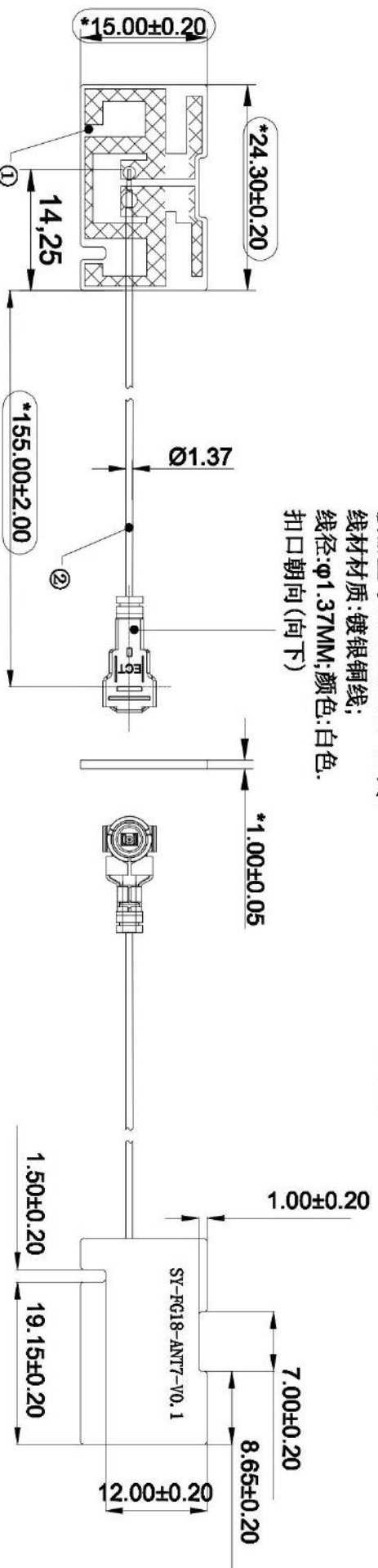

上海尚远通讯技术有限公司

 TOLERANCE X.X ±0.25 .XX ±0.20 .XXX ±0.05 ANGULAR $\leq \pm 0.5^\circ$ UNIT: mm		PART NAME: FG18 ANT7焊接组件		DATE: 2023.09.01	
PART NO.: SH232271B98-5		DRAWN: 么大恒		CHECKED: 于姜	
MATERIAL: PCB+同轴线		FINISHING:		APPROVED:	
COLOUR: 黑色亚光		SCALE:		REV: T.A	

技术要求:

- 1:带"*"为重点检测尺寸;带"□"的尺寸是过程控制所需的SPC尺寸:CPK>1.33。CP>1.67.
- 2:符合RoHS和无卤素要求.
- 3:外观要求依天线检验标准,同轴线焊接PCB时无未焊接,脱落不良现象,端子方向不可焊接;
- 4:焊点高度控制在2.2MM以内
- 5:未注公差参照一般公差表;
- 6:◆尺寸作参考,以配为准

序号	零件名称	料号	材料	颜色	数量
②	同轴线	SH232271B21-5	818000189	白色	1
①	PCB	SH232271B16-5	FR4	黑色	1

版本	修改内容	修改人	日期
A	图示丝印请增加至另一面	么大恒	2023-09-01

双面黑色油墨

正面

接器型号:818000189 (1代)
 线材材质:镀银铜线;
 线径:φ1.37MM;颜色:黑色.
 扣口朝向(向下)

反面

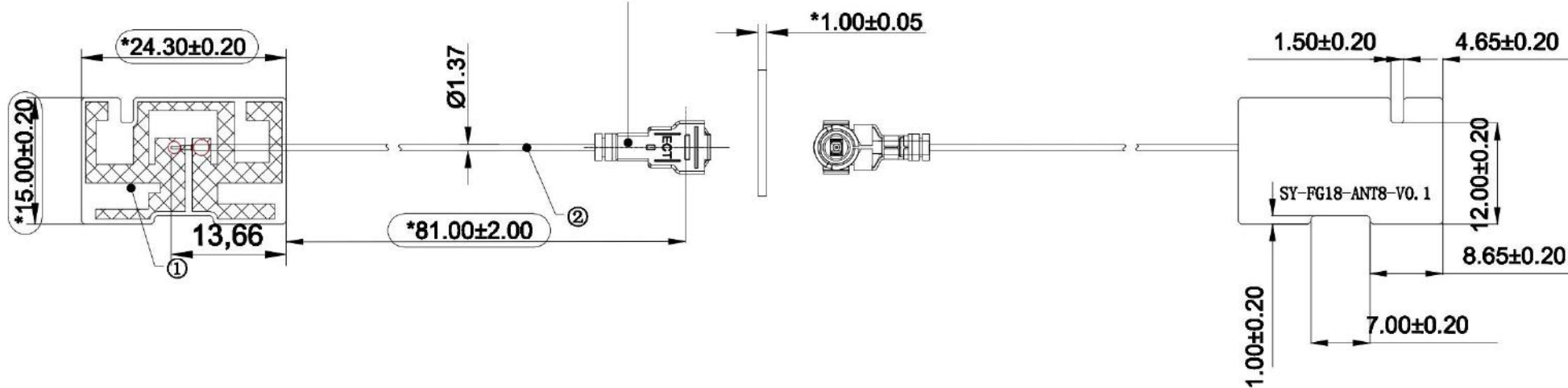

技术要求:

- 1:带"*"为重点检测尺寸;
- 2:辅料不可贴偏;
- 3:外观要求依天线检验标准,同轴线焊接PCB时无未焊接 脱落不良现象,端子方向不可焊错;
- 4:焊点高度控制在2.2MM以内
- 5:未注公差参照一般公差表;
- 6:◆尺寸作参考,以配为准

序号	零件名称	料号	材料	颜色	数量
②	同轴线	SH23227IB21-6	818000189	黑色	1
①	PCB	SH23227IB16-6	FR4	黑色	1

上海尚远通讯技术有限公司

	PART NAME: FG18 ANT8焊接组件	DATE: 2023.09.01
TOLERANCE X.X ±0.25 .XX ±0.20 .XXX±0.05 ANGULAR <±0.5°	PART NO: SH23227IB98-6	DRAWN: 么大恒
UNIT: mm	MATERIAL: PCB+同轴线	CHECKED: 于姜
	FINISHING:	APPROVED:
	COLOUR: 黑色亚光	SCALE:
		REV: T.A

5	6	7
版本	修改内容	修改人 日期

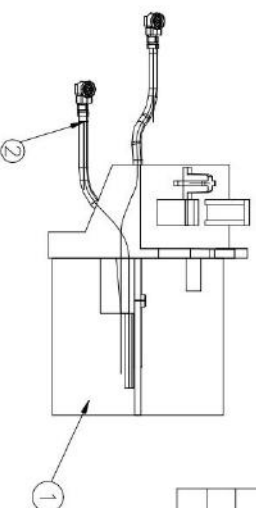

1代RF端子
线材颜色为蓝色,
出线长 98.10±2.00

1代RF端子
线材颜色为蓝色,
出线长 34.75±2.00

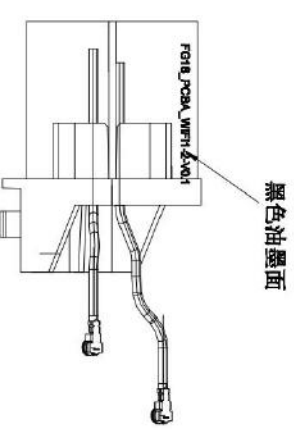
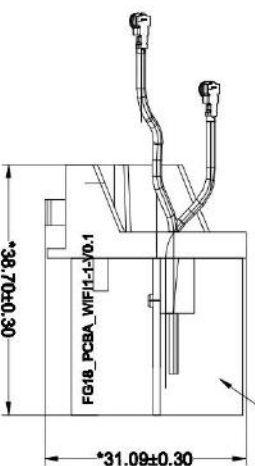
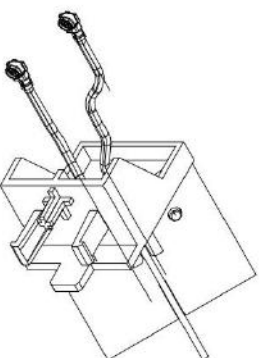
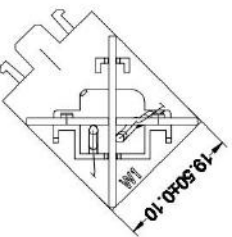
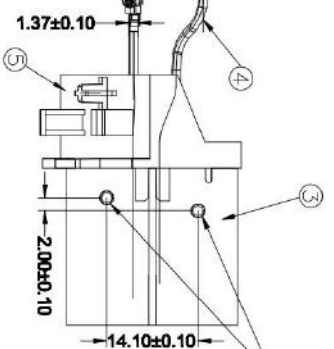

上海尚远通讯技术有限公司

TOLERANCE			
X.X	±0.25	PART NAME: WIFII天线组件 R618	
.XX	±0.20	PART NO: SH232271B65-1	
.XXX	±0.05	Customer NO:	
ANGULAR	∠ ±0.5°	FINISHING:	
UNIT: mm		COLOUR: 黑色	SCALE: 1:1
		DATE: 2023.07.19	REV: T-A
		DRAWN: 么大恒	
		CHECKED: 于姜	
		APPROVED:	

- 技术要求:
- 1:带"*"为重点检测尺寸;
 - 2:辅料不可贴偏;
 - 3:外观要求依天线检验标准,同轴线焊接PCB时无未焊接 脱落不良现象,端子方向不可焊错;
 - 4:焊点饱满;
 - 5:未注公差参照一般公差表;
 - 6:◆尺寸作参考,以配为准
 - 7.SVCBZ-52托盘包装,用9号纸箱

序号	零件名称	料号	材料	颜色	数量
⑤	WIFII 支架	SH214591B02-1	ABS	黑色	1
④	WIFII-2	SH232271L21-8	同轴线	线为蓝色	1
③	WIFII-2	SH232271B16-8	PCB	黑油	
②	WIFII-1	SH232271L21-7	同轴线	线为蓝色	1
①	WIFII-1	SH232271B16-7	PCB	黑油	1

5	6	7
版本	修改内容	修改人 日期

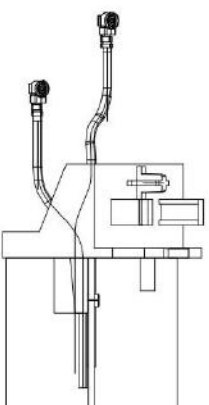

1代RF端子
线材颜色为蓝色,
出线长73.10±2.00

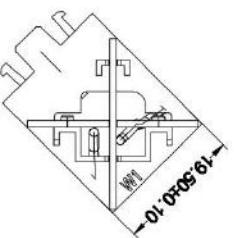

1代RF端子
线材颜色为灰色,
出线长71.10±2.00

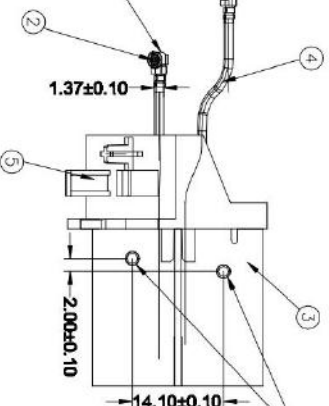

PCB热焊到支架

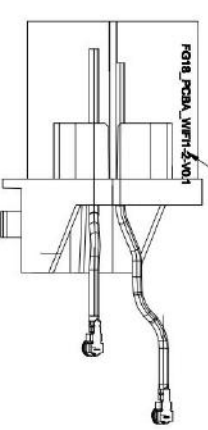

黑色油墨面

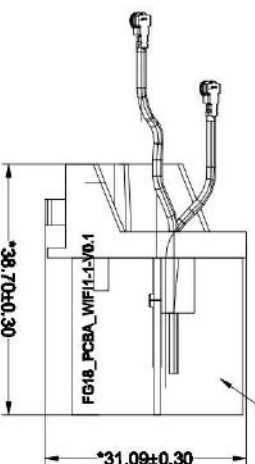
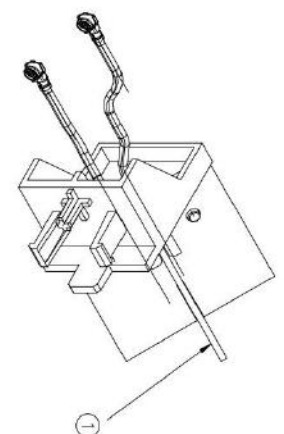

黑色油墨面

- 技术要求:
- 1:带"*"为重点检测尺寸;
 - 2:辅料不可贴偏;
 - 3:外观要求依天线检验标准,同轴线焊接PCB时无未焊接 脱落不良现象,端子方向不可焊错;
 - 4:焊点饱满;
 - 5:未注公差参照一般公差表;
 - 6:◆尺寸作参考,以配为准
 - 7.SYCBZ-52托盘包装,用9号纸箱

序号	零件名称	料号	材料	颜色	数量
⑤	WiFi1 支架	SH21459IB02-2	ABS	黑色	1
④	WiFi2-2	SH232271G21-10	同轴线	线为灰色	1
③	WiFi2-2	SH232271B16-10	PCB	黑油	1
②	WiFi2-1	SH232271G21-9	同轴线	线为灰色	1
①	WiFi2-1	SH232271B16-9	PCB	黑油	1

上海尚远通讯技术有限公司

TOLERANCE			
X.X	±0.25	PART NAME:	FG18
.XX	±0.20	PART NO.:	SH232271B65-2
.XXX	±0.05	Customer NO.:	
ANGULAR	∠±0.5°	FINISHING:	APPROVED:
UNIT: mm		COLOUR: 黑色	SCALE:
			REV: T.A

DATE: 2023.07.19

DRAWN: 么大恒

CHECKED: 于姜

APPROVED:

SCALE:

REV: T.A