

FCC REPORT

(GSM & WCDMA)

Applicant: Sky Phone LLC
Address of Applicant: 1348 Washington Av.Suite 350, Miami Beach, Florida, United States

Equipment Under Test (EUT)

Product Name: Smart phone
Model No.: SKY PRO III
Trade mark: SKY DEVICES

FCC ID: 2ABOSSKYPROIII

Applicable standards: FCC CFR Title 47 Part 2
FCC CFR Title 47 Part 22 Subpart H
FCC CFR Title 47 Part 24 Subpart E
FCC CFR Title 47 Part 27 Subpart L

Date of sample receipt: 02 Fed., 2018

Date of Test: 02 Fed., to 09 Fed., 2018

Date of report issued: 23 Fed., 2018

Test Result: PASS*

* In the configuration tested, the EUT complied with the standards specified above.

Authorized Signature:



Bruce Zhang
Laboratory Manager

This report details the results of the testing carried out on one sample. The results contained in this test report do not relate to other samples of the same product and does not permit the use of the CCIS product certification mark. The manufacturer should ensure that all products in series production are in conformity with the product sample detailed in this report.

This report may only be reproduced and distributed in full. If the product in this report is used in any configuration other than that detailed in the report, the manufacturer must ensure the new system complies with all relevant standards.

This document cannot be reproduced except in full, without prior written approval of the Company. Any unauthorized alteration, forgery or falsification of the content or appearance of this document is unlawful and offenders may be prosecuted to the fullest extent of the law. Unless otherwise stated the results shown in this test report refer only to the sample(s) tested and such sample(s) are retained for 90 days only.

2. Version

Version No.	Date	Description
00	23 Feb., 2018	Original

Tested by: Zora Lee **Date:** 23 Feb., 2018
Test Engineer

Reviewed by: Wimer Zhang **Date:** 23 Feb., 2018
Project Engineer

3. Contents

	Page
1. COVER	1
2. VERSION.....	2
3. CONTENTS.....	3
4. TEST SUMMARY.....	4
5. GENERAL INFORMATION.....	5
5.1 CLIENT INFORMATION.....	5
5.2 GENERAL DESCRIPTION OF E.U.T.....	5
5.3 TEST MODES.....	7
5.4 DESCRIPTION OF SUPPORT UNITS.....	7
5.5 MEASUREMENT UNCERTAINTY.....	7
5.6 LABORATORY FACILITY.....	7
5.7 LABORATORY LOCATION	8
5.8 TEST INSTRUMENTS LIST.....	8
6. TEST RESULTS.....	9
6.1 CONDUCTED OUTPUT POWER	9
6.2 OCCUPY BANDWIDTH	12
6.3 PEAK-TO-AVERAGE POWER RATIO	19
6.4 MODULATION CHARACTERISTIC.....	22
6.5 OUT OF BAND EMISSION AT ANTENNA TERMINALS	22
6.6 ERP, EIRP MEASUREMENT	31
6.7 FIELD STRENGTH OF SPURIOUS RADIATION MEASUREMENT.....	33
6.8 FREQUENCY STABILITY V.S. TEMPERATURE MEASUREMENT.....	39
6.9 FREQUENCY STABILITY V.S. VOLTAGE MEASUREMENT	42
7 TEST SETUP PHOTO.....	44
8 EUT CONSTRUCTIONAL DETAILS.....	45

4. Test Summary

Test Item	Section	Result
RF Exposure (SAR)	Part 1.1307 Part 2.1093	Pass (Please refer to SAR Report)
RF Output Power	Part 2.1046 Part 22.913 (a)(2) Part 24.232 (c) Part 27.50 (d)(4)	Pass
Peak-to-Average Power Ratio	Part 24.232 (d) Part 27.50 (d)(5)	Pass
Modulation Characteristics	Part 2.1047	Pass
99% & -26 dB Occupied Bandwidth	Part 2.1049 Part 22.917(b) Part 24.238(b) Part 27.53 (h)	Pass
Spurious Emissions at Antenna Terminal	Part 2.1051 Part 22.917 (a) Part 24.238 (a) Part 27.53 (h)	Pass
Field Strength of Spurious Radiation	Part 2.1053 Part 22.917 (a) Part 24.238 (a) Part 27.53 (h)	Pass
Out of band emission, Band Edge	Part 22.917 (a) Part 24.238 (a) Part 27.53 (h)	Pass
Frequency stability vs. temperature	Part 22.355 Part 24.235 Part 27.54 Part 2.1055(a)(1)(b)	Pass
Frequency stability vs. voltage	Part 22.355 Part 24.235 Part 27.54 Part 2.1055(d)(2)	Pass

Pass: The EUT complies with the essential requirements in the standard.

5. General Information

5.1 Client Information

Applicant:	Sky Phone LLC
Address:	1348 Washington Av.Suite 350, Miami Beach, Florida, United States
Manufacturer:	Sky Phone LLC
Address:	1348 Washington Av.Suite 350, Miami Beach, Florida, United States
factory:	SHENZHEN GREAT TECHNOLOGY CO., LTD.
Address:	Room 1, Floor 16th, Chuangyetouzi Building, Keyuan Road #1001, Nanshan District, Shenzhen, Guangdong, China

5.2 General Description of E.U.T.

Product Name:	Smart phone
Model No.:	SKY PRO III
Operation Frequency range:	GSM 850: 824.20MHz-848.80MHz PCS1900: 1850.20MHz-1909.80MHz WCDMA Band V: 826.4MHz-846.6MHz WCDMA Band II: 1852.4 MHz-1907.6 MHz WCDMA Band IV: 1712.4 MHz-1752.6 MHz
Modulation type:	GSM/GPRS: GMSK, UMTS: QPSK
Antenna type:	Internal Antenna
Antenna gain:	GSM 850: -0.1 dBi PCS 1900: 1.3 dBi WCDMA Band V: -0.2 dBi WCDMA Band II: 1.3 dBi WCDMA Band IV: 1.2 dBi
Power supply:	Rechargeable Li-ion Battery DC3.7V-2000mAh
AC adapter:	Model: D31-05050100 Input: AC100-240V, 50/60Hz, 0.3A Output: DC 5.0V, 1.0A

Operation Frequency List:

GSM 850		PCS1900	
Channel	Frequency (MHz)	Channel	Frequency (MHz)
128	824.20	512	1850.20
129	824.40	513	1850.40
....
189	836.40	660	1879.80
190	836.60	661	1880.00
191	836.80	662	1880.20
...
250	848.60	809	1909.60
251	848.80	810	1909.80
WCDMA Band V		WCDMA Band II	
Channel	Frequency (MHz)	Channel	Frequency (MHz)
4132	826.40	9262	1852.40
4133	826.60	9263	1852.60
....
4182	836.40	9399	1879.80
4183	836.60	9400	1880.00
4184	836.80	9401	1880.20
...
4232	846.40	9537	1907.40
4233	846.60	9538	1907.60
WCDMA Band IV			
Channel	Frequency (MHz)		
1312	1712.40		
1313	1712.60		
....		
1412	1732.40		
1413	1732.60		
1414	1732.80		
...	...		
1512	1752.40		
1513	1752.60		

Regards to the operating frequency range over 10 MHz, the Lowest frequency, the middle frequency, and the highest frequency of channel were selected to perform the test, and the selected channel see below:

GSM850			PCS1900		
Channel	Frequency(MHz)		Channel	Frequency(MHz)	
Lowest channel	128	824.20	Lowest channel	512	1850.20
Middle channel	190	836.60	Middle channel	661	1880.00
Highest channel	251	848.80	Highest channel	810	1909.80
WCDMA Band V			WCDMA Band II		
Channel	Frequency(MHz)		Channel	Frequency(MHz)	
Lowest channel	4132	826.40	Lowest channel	9262	1852.40
Middle channel	4183	836.60	Middle channel	9400	1880.00
Highest channel	4233	846.60	Highest channel	9538	1907.60
WCDMA Band IV					
Channel	Frequency(MHz)				
Lowest channel	1312	1712.40			
Middle channel	1413	1732.60			
Highest channel	1513	1752.60			

5.3 Test modes

Operating Environment:	
Temperature:	Normal: 15°C ~ 35°C, Extreme: -30°C ~ +50°C
Humidity:	20 % ~ 75 % RH
Atmospheric Pressure:	1008 mbar
Voltage:	Nominal: 3.7Vdc, Extreme: Low 3.5Vdc, High 4.2Vdc
Test mode:	
GSM mode	Keep the EUT communication with simulated station in GSM mode
GPRS mode	Keep the EUT communication with simulated station in GPRS mode
RMC mode	Keep the EUT communication with simulated station in RMC mode
HSDPA	Keep the EUT communication with simulated station in HSDPA mode
HSUPA	Keep the EUT communication with simulated station in HSUPA mode
Remark: The EUT has been tested under continuous transmitting mode. Channel Low, Mid and High for each type band with rated data rate were chosen for full testing. The field strength of spurious radiation emission was measured as EUT stand-up position (H mode) and lie down position (E1, E2 mode) for these modes with power adaptor, earphone and Data cable. Just the worst case position (H mode) shown in report.	

5.4 Description of Support Units

Test Equipment	Manufacturer	Model No.	Serial No.
Simulated Station	Anritsu	MT8820C	6201026545

5.5 Measurement Uncertainty

Parameters	Expanded Uncertainty
Radiated Emission (9kHz ~ 30MHz)	4.24 dB (k=2)
Radiated Emission (30MHz ~ 1000MHz)	4.35 dB (k=2)
Radiated Emission (1GHz ~ 18GHz)	4.44 dB (k=2)
Radiated Emission (18GHz ~ 26.5GHz)	4.56 dB (k=2)
Radiated Emission (18GHz ~ 26.5GHz)	4.56 dB (k=2)

5.6 Laboratory Facility

The test facility is recognized, certified, or accredited by the following organizations:

- **FCC - Registration No.: 727551**

Shenzhen Zhongjian Nanfang Testing Co., Ltd. has been accredited as a testing laboratory by FCC (Federal Communications Commission). The Registration No. is 727551.

- **IC - Registration No.: 10106A-1**

The 3m Semi-anechoic chamber of Shenzhen Zhongjian Nanfang Testing Co., Ltd. has been Registered by Certification and Engineering Bureau of Industry Canada for radio equipment testing with Registration No.: 10106A-1.

- **CNAS - Registration No.: CNAS L6048**

Shenzhen Zhongjian Nanfang Testing Co., Ltd. is accredited to ISO/IEC 17025:2005 General Requirements for the Competence of Testing and Calibration laboratories for the competence of testing. The Registration No. is CNAS L6048.

- **A2LA - Registration No.: 4346.01**

This laboratory is accredited in accordance with the recognized International Standard ISO/IEC 17025:2005 General requirements for the competence of testing and calibration laboratories. The test scope can be found as below link: <https://portal.a2la.org/scopepdf/4346-01.pdf>

5.7 Laboratory Location

Shenzhen Zhongjian Nanfang Testing Co., Ltd.
 Address: No. B-C, 1/F., Building 2, Laodong No.2 Industrial Park, Xixiang Road,
 Bao'an District, Shenzhen, Guangdong, China
 Tel: +86-755-23118282, Fax: +86-755-23116366
 Email: info@ccis-cb.com, Website: http://www.ccis-cb.com

5.8 Test Instruments list

Test Equipment	Manufacturer	Model No.	Serial No.	Cal. Date (mm-dd-yy)	Cal. Due date (mm-dd-yy)
3m SAC	SAEMC	9m*6m*6m	966	07-22-2017	07-21-2020
BiConiLog Antenna	SCHWARZBECK	VULB9163	497	02-25-2017	02-24-2018
Biconical Antenna	SCHWARZBECK	VUBA9117	359	06-22-2017	06-21-2018
Horn Antenna	SCHWARZBECK	BBHA9120D	916	02-25-2017	02-24-2018
Horn Antenna	SCHWARZBECK	BBHA9120D	1805	02-25-2017	02-24-2018
EMI Test Software	AUDIX	E3	6.110919b	N/A	N/A
Pre-amplifier	HP	8447D	2944A09358	02-25-2017	02-24-2018
Pre-amplifier	CD	PAP-1G18	11804	02-25-2017	02-24-2018
Spectrum analyzer	Rohde & Schwarz	FSP30	101454	02-25-2017	02-24-2018
EMI Test Receiver	Rohde & Schwarz	ESRP7	101070	02-25-2017	02-24-2018
Spectrum Analyzer	Agilent	N9020A	MY50510123	10-29-2017	10-28-2018
Signal Generator	Rohde & Schwarz	SMX	835454/016	02-25-2017	02-24-2018
Signal Generator	R&S	SMR20	1008100050	02-25-2017	02-24-2018
RF Switch Unit	MWRFTTEST	MW200	N/A	N/A	N/A
Cable	ZDECL	Z108-NJ-NJ-81	1608458	02-25-2017	02-24-2018
Cable	MICRO-COAX	MFR64639	K10742-5	02-25-2017	02-24-2018
Cable	SUHNER	SUCOFLEX100	58193/4PE	02-25-2017	02-24-2018
DC Power Supply	XinNuoEr	WYK-10020K	1409050110020	10-31-2017	10-30-2018
Temperature Humidity Chamber	HengPu	HPGDS-500	20140828008	09-24-2017	09-23-2018
Simulated Station	Rohde & Schwarz	CMW500	140493	06-24-2017	06-23-2018

6. Test results

6.1 Conducted Output Power

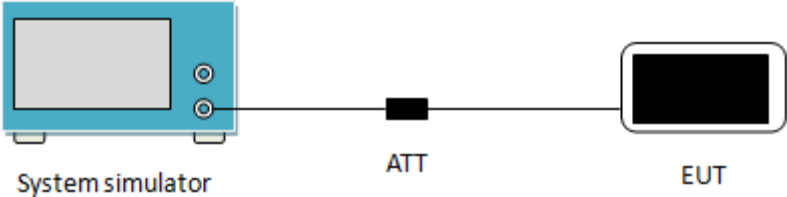
Test Requirement:	FCC part 22.913(a)(2), FCC part 24.232(c), FCC part 27.50(d)(4)
Test Method:	ANSI/TIA-603-D 2010
Limit:	GSM 850: 7W, PCS 1900: 2W WCDMA Band V: 7W, WCDMA Band II: 2W, WCDMA Band IV: 1W
Test setup:	 <p>The diagram illustrates the test setup. On the left is a blue 'System simulator' with a screen and two ports. A line connects it to a black 'ATT' (attenuator) block. Another line connects the 'ATT' to a black 'EUT' (Equipment Under Test) device.</p>
Test Procedure:	The transmitter output was connected to a calibrated attenuator, the other end of which was connected to the simulated station. Transmitter output power was read off in dBm.
Test Instruments:	Refer to section 5.8 for details
Test mode:	Refer to section 5.3 for details
Test results:	Passed

Measurement Data:

EUT Mode	Burst Average power (dBm)			Limit(dBm)
	128	190	251	
	824.20MHz	836.60MHz	848.80MHz	
GSM 850	32.28	32.18	32.11	38.45
GPRS 850 (1 Uplink slot)	32.27	32.20	32.14	
GPRS 850 (2 Uplink slot)	31.41	31.38	31.34	
GPRS 850 (3 Uplink slot)	29.66	29.40	29.17	
GPRS 850 (4 Uplink slot)	28.43	28.09	28.02	
EUT Mode	Burst Average power (dBm)			Limit(dBm)
	512	661	810	
	1850.20MHz	1880.00MHz	1909.80MHz	
PCS 1900	28.94	28.95	29.03	33.00
GPRS 1900 (1 Uplink slot)	28.98	29.02	29.01	
GPRS 1900 (2 Uplink slot)	28.17	28.34	28.51	
GPRS 1900 (3 Uplink slot)	26.20	26.53	26.85	
GPRS 1900 (4 Uplink slot)	24.98	25.37	25.79	

EUT Mode		Burst Average power (dBm)			Limit(dBm)
		4132	4183	4233	
		826.40MHz	836.60MHz	846.60MHz	
UMTS 850 HSDPA	Subtest 1	21.50	21.27	21.07	38.45
	Subtest 2	21.13	20.92	20.81	
	Subtest 3	19.52	19.38	19.29	
	Subtest 4	19.50	19.44	19.21	
UMTS 850 HSUPA	Subtest 1	21.43	21.17	20.96	
	Subtest 2	21.40	21.21	21.01	
	Subtest 3	19.59	19.23	19.19	
	Subtest 4	21.49	21.31	20.99	
	Subtest 5	20.62	20.33	20.16	
UMTS 850 RMC	12.2kbps	22.48	22.25	22.18	
UMTS 850 AMR	12.2kbps	22.33	22.20	21.99	
EUT Mode		Burst Average power (dBm)			
		9262	9400	9538	
		1852.40MHz	1880.00MHz	1907.60MHz	
UMTS 1900 HSDPA	Subtest 1	20.79	20.69	20.67	33.00
	Subtest 2	20.42	20.38	20.26	
	Subtest 3	18.90	18.93	18.76	
	Subtest 4	18.84	18.87	18.84	
UMTS 1900 HSUPA	Subtest 1	20.68	20.61	20.49	
	Subtest 2	20.77	20.66	20.54	
	Subtest 3	18.83	18.96	18.85	
	Subtest 4	20.75	20.67	20.56	
	Subtest 5	19.85	19.86	19.86	
UMTS 1900 RMC	12.2kbps	21.71	21.38	21.54	
UMTS 1900 AMR	12.2kbps	21.70	21.70	21.64	
EUT Mode		Burst Average power (dBm)			
		1312	1412	1513	
		1712.40MHz	1732.40MHz	1752.60MHz	
UMTS 1700 HSDPA	Subtest 1	20.90	21.02	20.85	30.00
	Subtest 2	20.60	20.76	20.47	
	Subtest 3	19.11	19.19	18.98	
	Subtest 4	19.06	19.27	18.99	
UMTS 1700 HSUPA	Subtest 1	20.86	21.04	20.81	
	Subtest 2	20.78	21.06	20.81	
	Subtest 3	19.14	19.17	18.93	
	Subtest 4	20.83	21.03	20.82	
	Subtest 5	19.98	20.21	19.93	
UMTS 1700 RMC	12.2kbps	21.88	22.03	21.82	
UMTS 1700 AMR	12.2kbps	21.89	21.92	21.74	

6.2 Occupy Bandwidth

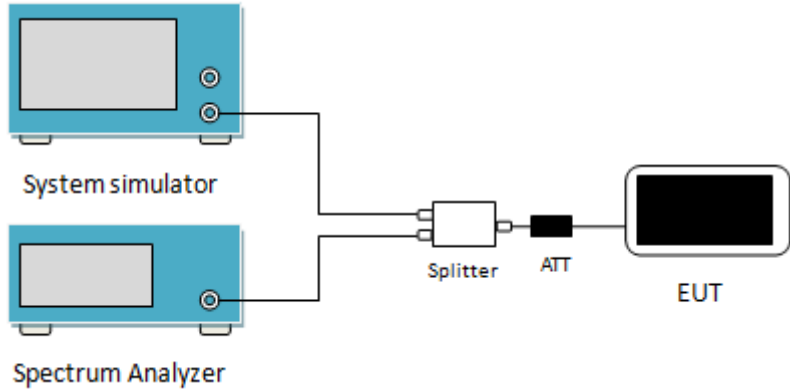
Test Requirement:	FCC part 22.917(b), FCC part 24.238(b), FCC Part 27.53(h)
Test Method:	ANSI/TIA-603-D 2010
Test setup:	 <p>The diagram illustrates the test setup. On the left, there are two blue rectangular units: the top one is labeled 'System simulator' and the bottom one is labeled 'Spectrum Analyzer'. Both have a screen and two knobs on the right side. A single line from the System simulator and another from the Spectrum Analyzer connect to a central 'Splitter' box. From the Splitter, one line goes to an 'ATT' (attenuator) box, and another goes to an 'EUT' (Equipment Under Test) box, which is depicted as a black rectangular device with a screen.</p>
Test Procedure:	<ol style="list-style-type: none"> 1. The EUT's output RF connector was connected with a short cable to the spectrum analyzer 2. RBW was set to about 1% of emission BW, VBW= 3 times RBW. 3. -26dBc display line was placed on the screen (or 99% bandwidth), the occupied bandwidth is the delta frequency between the two points where the display line intersects the signal trace.
Test Instruments:	Refer to section 5.8 for details
Test mode:	Refer to section 5.3 for details
Test results:	Passed

Measurement Data:

EUT Mode	Channel	Frequency (MHz)	99% Occupy bandwidth (kHz)	-26dB bandwidth (kHz)
GSM 850	128	824.2	244	322
	190	836.6	246	318
	251	848.8	246	314
PCS 1900	512	1850.2	252	320
	661	1880.0	246	318
	810	1909.8	244	320
UMTS 850 12.2k RMC	4132	826.4	4140	4700
	4183	836.6	4180	4720
	4233	846.6	4160	4700
UMTS 1900 12.2k RMC	9262	1852.4	4180	4720
	9400	1880.0	4180	4700
	9538	1907.6	4160	4680
UMTS 1700 12.2k RMC	1312	1712.4	4160	4700
	1413	1732.6	4180	4680
	1513	1752.6	4180	4680

Note: GSM & GPRS use the same modulation technical (GMSK), and with the same channels, so the 99% OBW and the -26dB of GPRS not performed.

Test plot as follows:

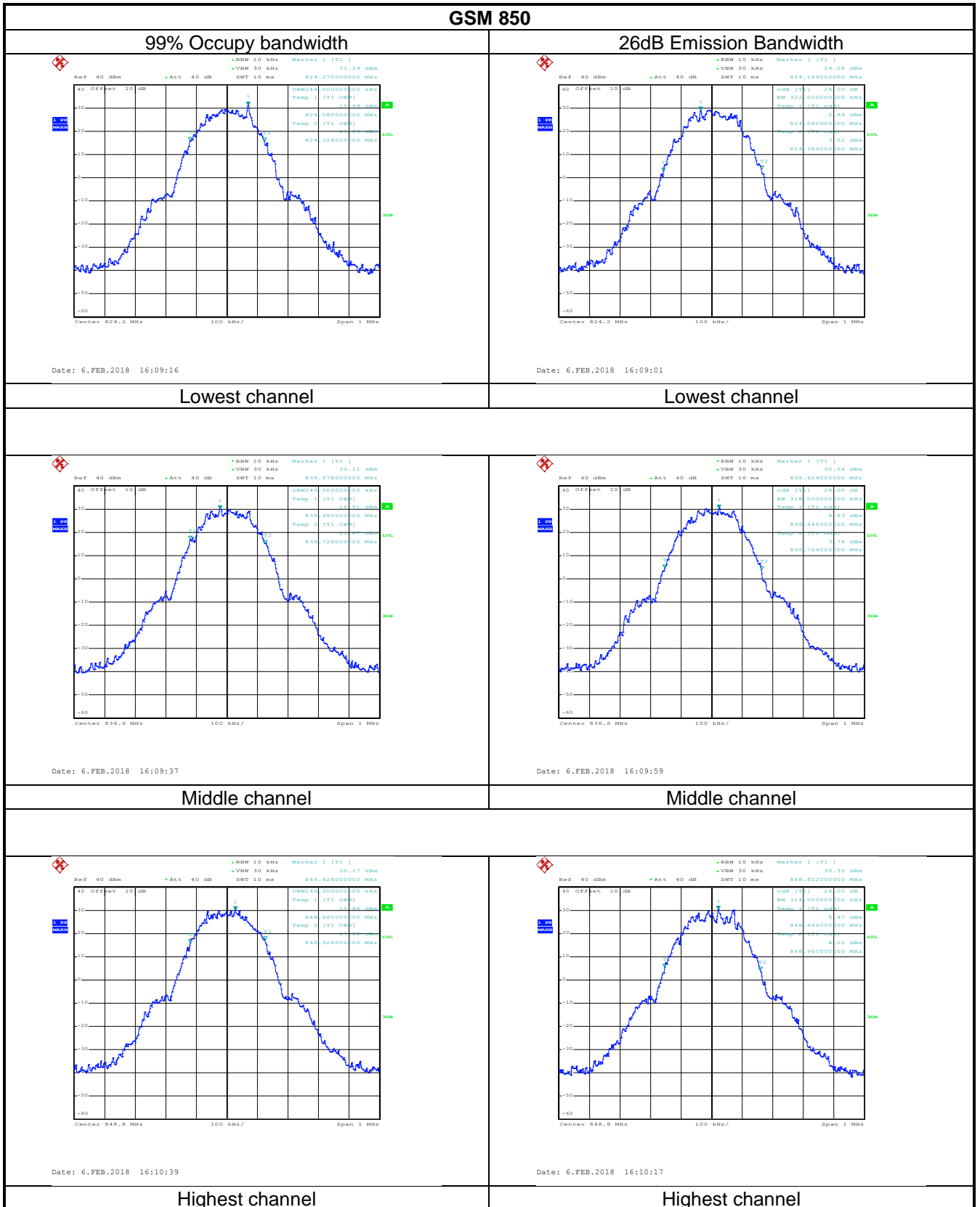

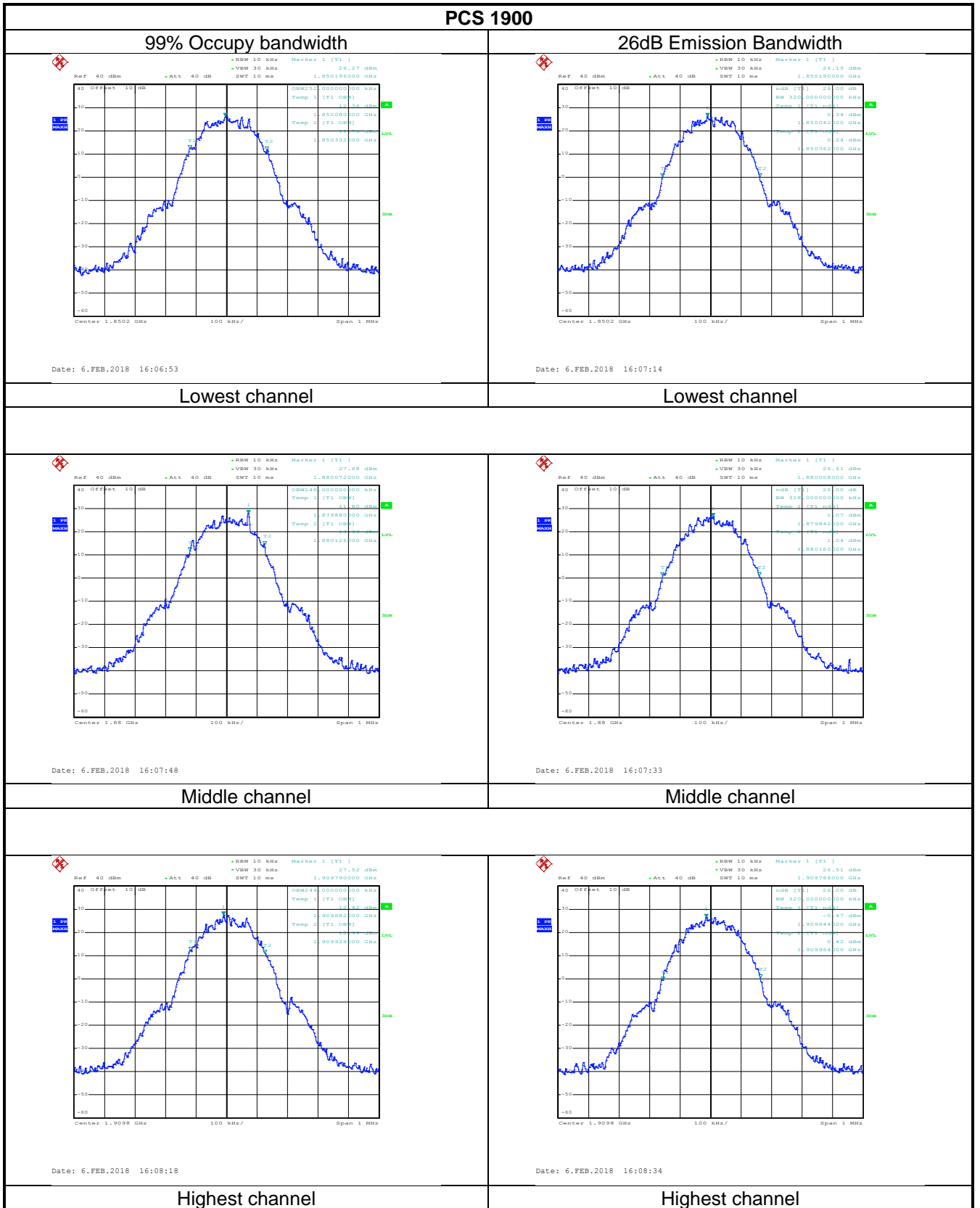

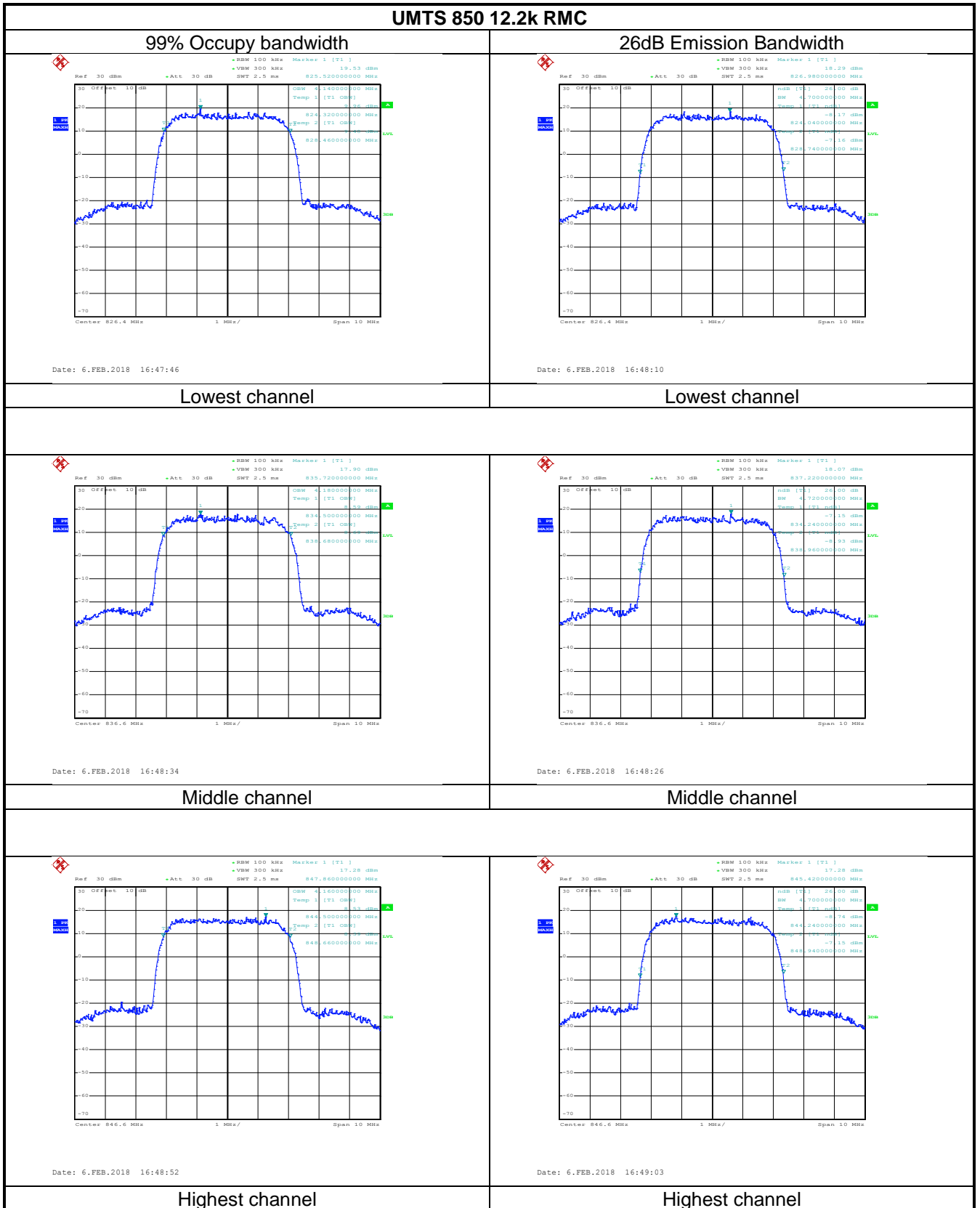

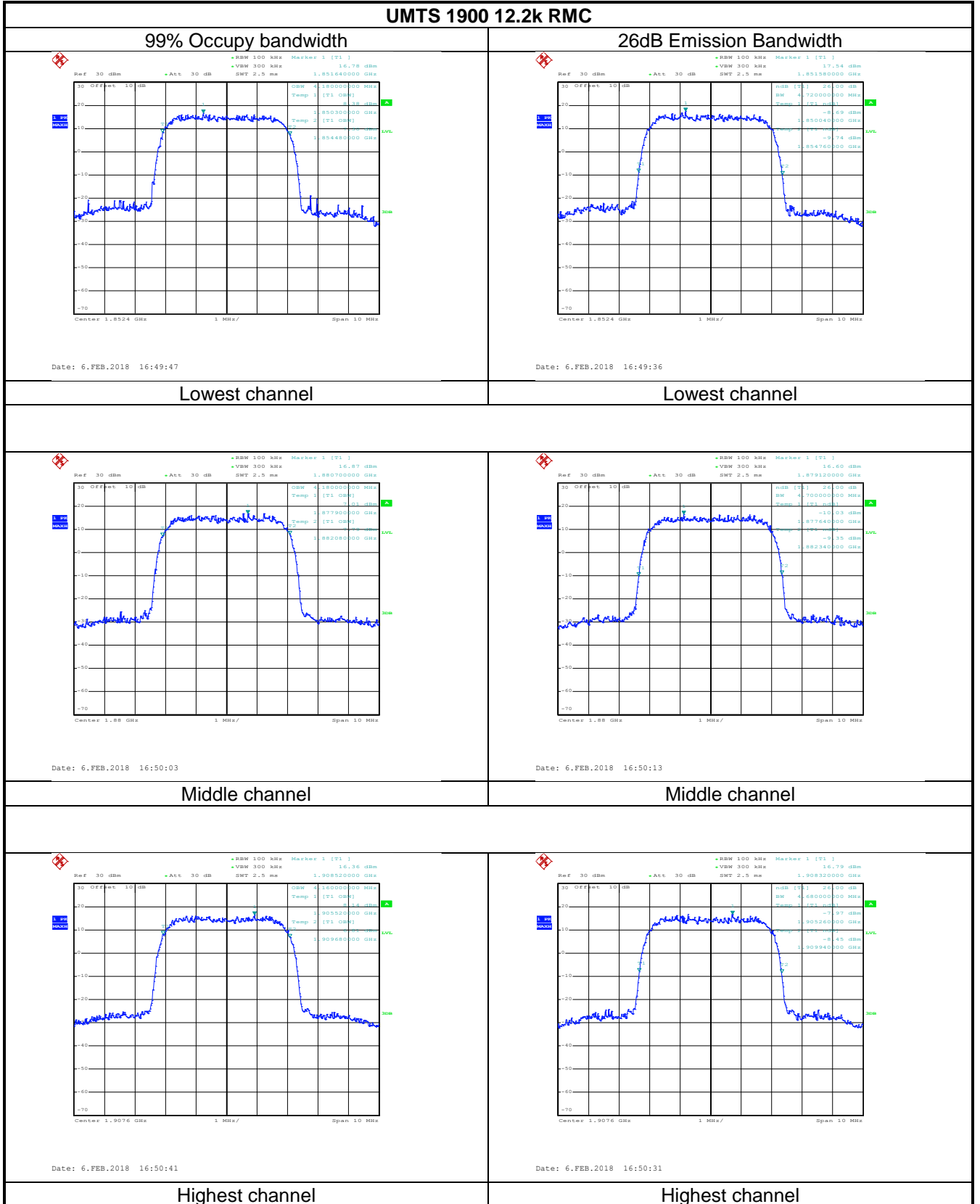

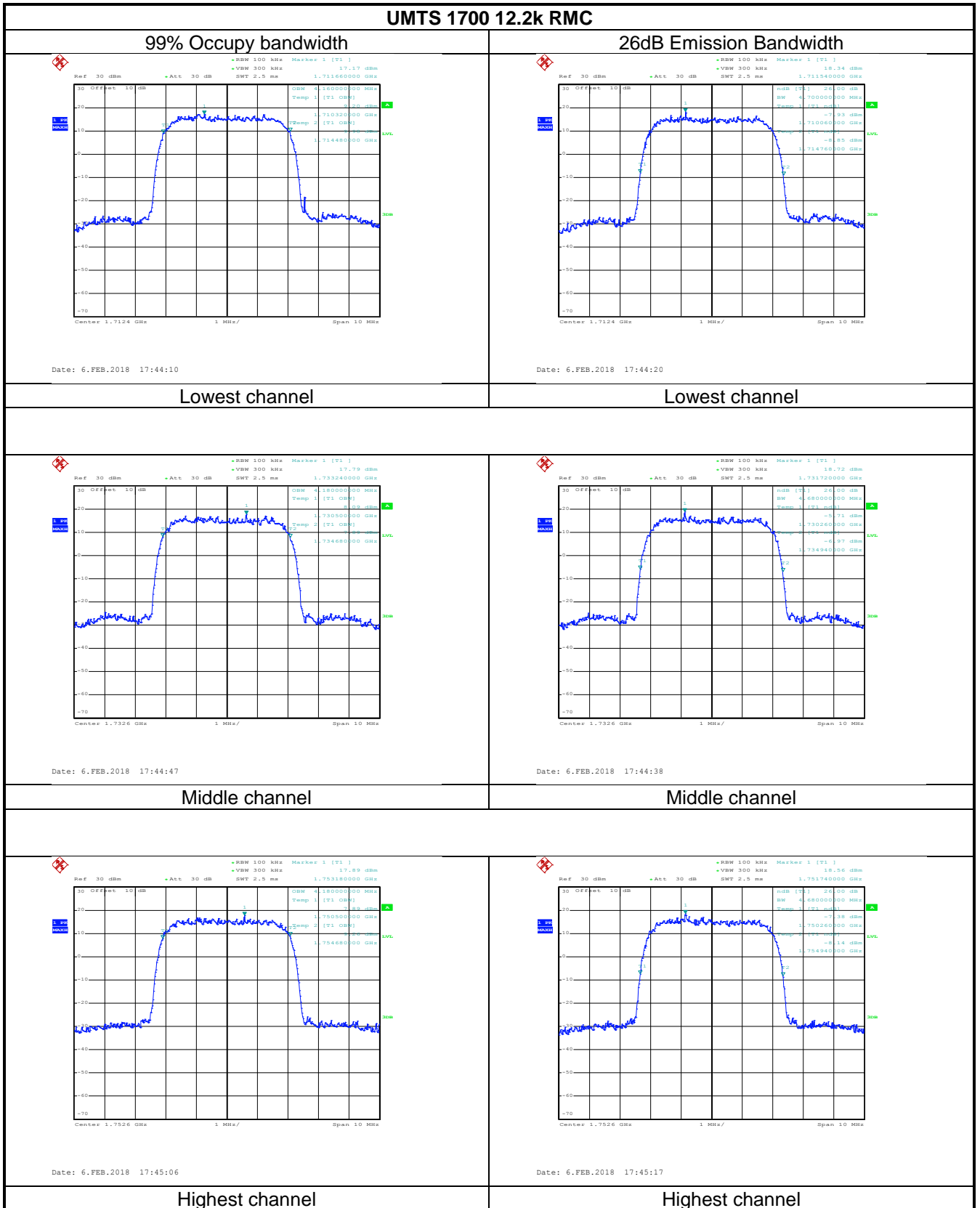

6.3 Peak-to-Average Power Ratio

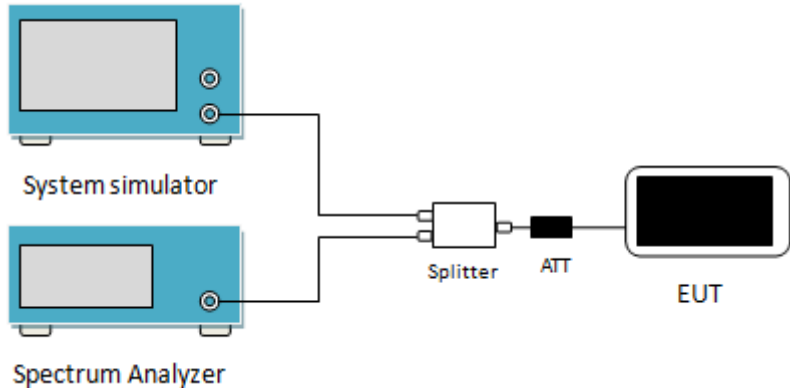
Test Requirement:	FCC part 24.232(d), FCC part 27.50(d)(5)
Test Method	ANSI/TIA-603-D 2010
Limit:	The peak-to-average ratio (PAR) of the transmission may not exceed 13 dB.
Test setup:	
Test Procedure:	<ol style="list-style-type: none"> 1 The RF output of the transceiver was connected to a spectrum analyzer through appropriate attenuation. 2 Set the CCDF option in spectrum analyzer, $RBW \geq OBW$, 3 Set the EUT working in highest power level, measured and recorded the 0.1% as PAPR level. 4 Repeat step 1~3 at other frequency and modulations.
Test Instruments:	Refer to section 5.8 for details
Test mode:	Refer to section 5.3 for details
Test results:	Passed

Measurement Data:

Modulation	Test channel	PAPR
GSM 850	190	0.08
PCS 1900	661	0.08
UMTS 850 RMC	4183	3.00
UMTS 1900 RMC	9400	3.04
UMTS1700 RMC	1413	2.96

Test plots as below:

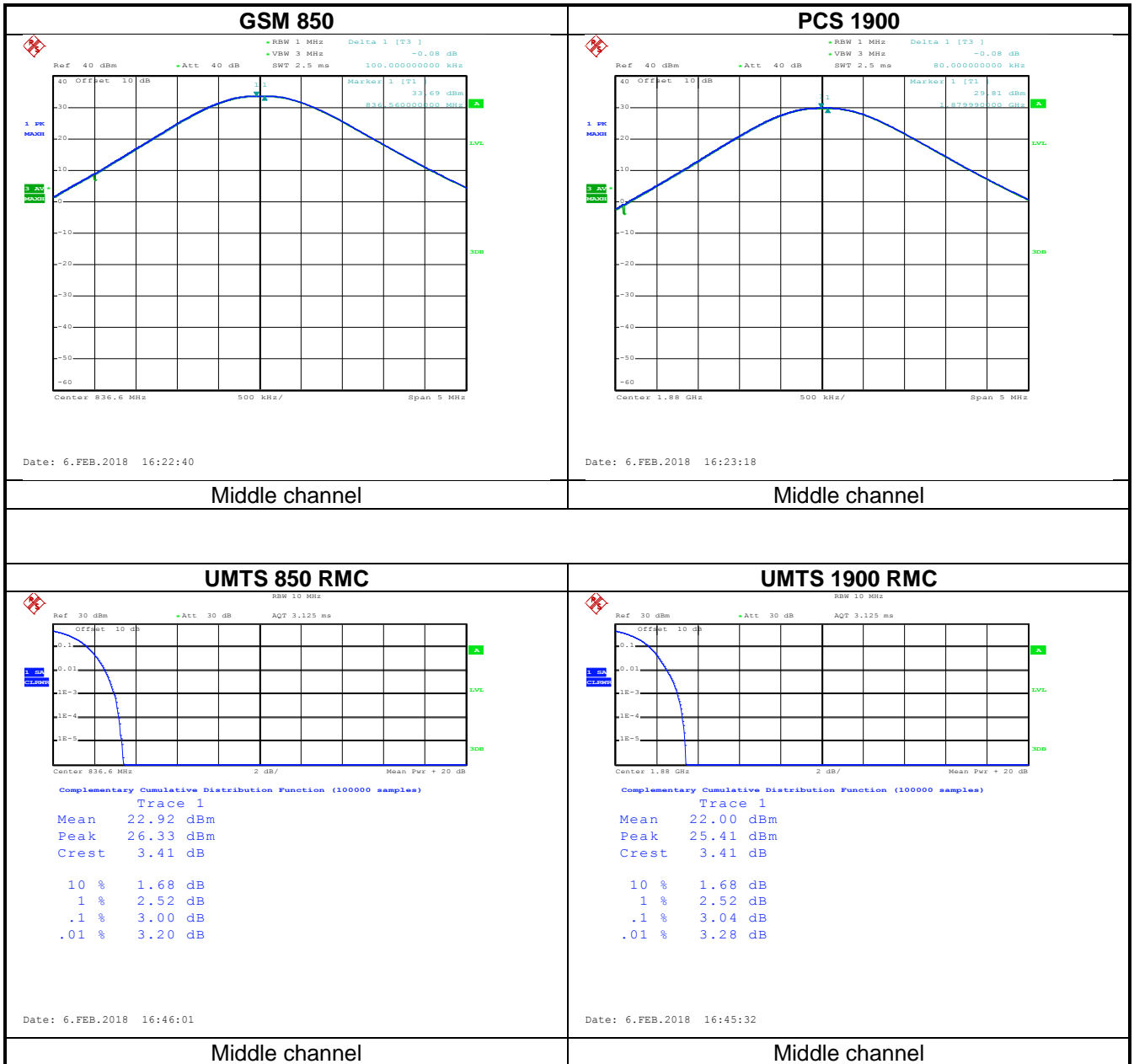

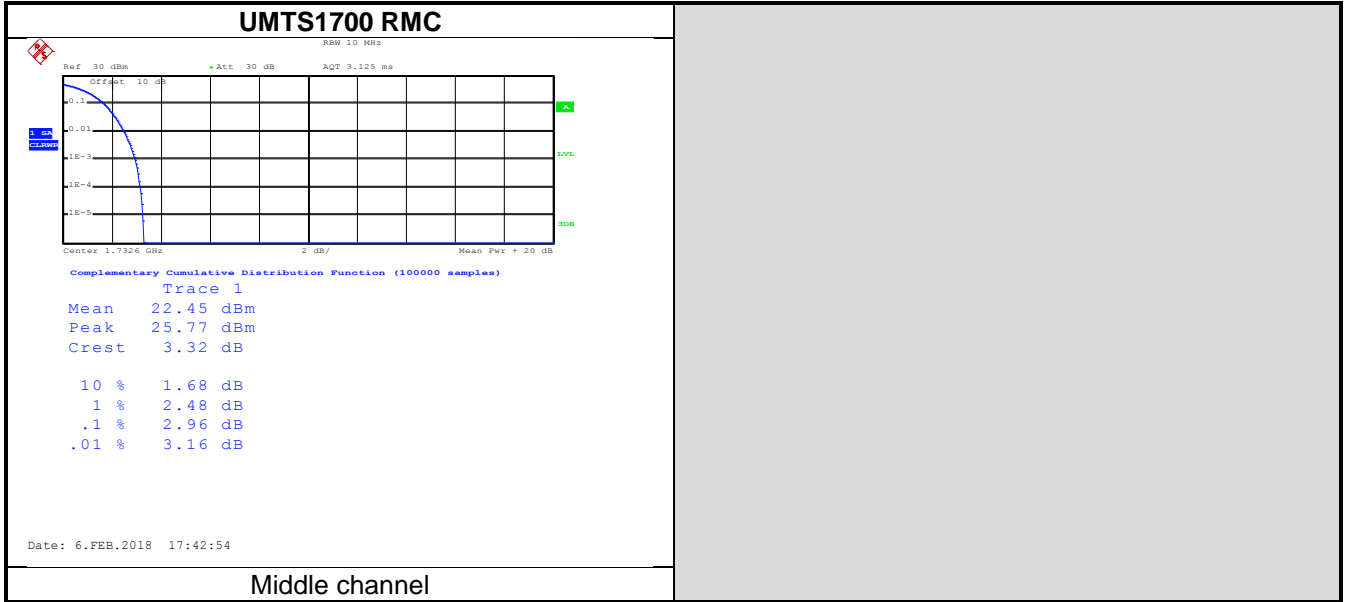

6.4 Modulation Characteristic

According to FCC § 2.1047(d), Part 22H & 24E & 27L there is no specific requirement for digital modulation, therefore modulation characteristic is not presented.

6.5 Out of band emission at antenna terminals

Test Requirement:	FCC part 22.917(a), FCC part 24.238(a), FCC Part 27.53 (h)
Test Method:	ANSI/TIA-603-D 2010
Limit:	-13dBm
Test setup:	
Test Procedure:	<ol style="list-style-type: none"> 1 The RF output of the transceiver was connected to a spectrum analyzer through appropriate attenuation. 2 The resolution bandwidth of the spectrum analyzer was set at 100 kHz when below 1GHz, 1MHz when above 1 GHz; sufficient scans were taken to show the out of band Emissions if any up to 10th harmonic. 3 For the out of band: Set the RBW=100 kHz, VBW=300 kHz when below 1 GHz, RBW =1 MHz, VBW=3 MHz when above 1 GHz, Start=30MHz, Stop= 10th harmonic. 4 Band Edge Requirements: In the 1 MHz bands immediately outside and adjacent to the frequency block, a resolution bandwidth of at least 1 percent of the emission bandwidth of the fundamental emission of the transmitter may be employed to measure the out of band Emissions.
Test Instruments:	Refer to section 5.8 for details
Test mode:	Refer to section 5.3 for details
Test results:	Passed

Test plots as follows (Spurious emission):

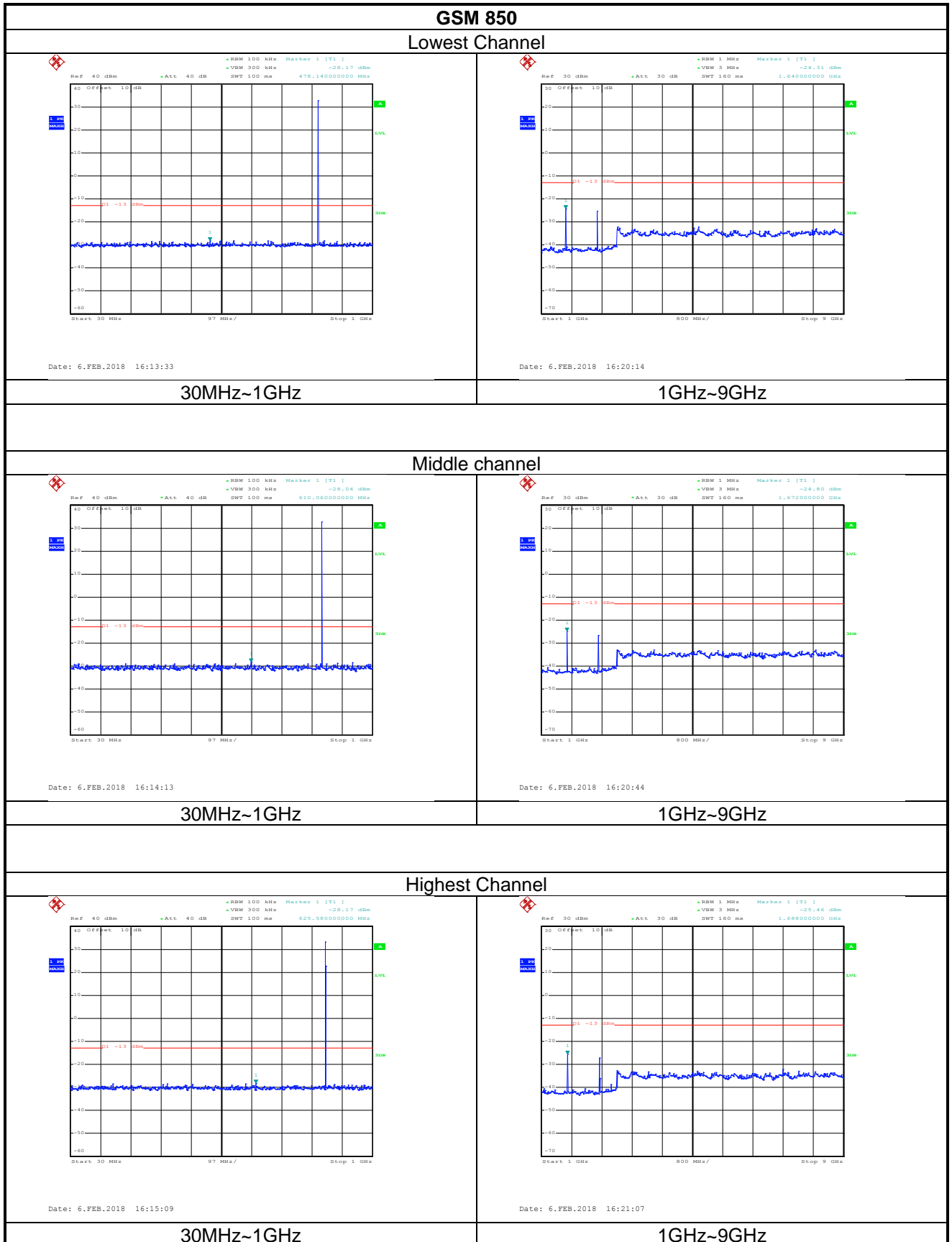

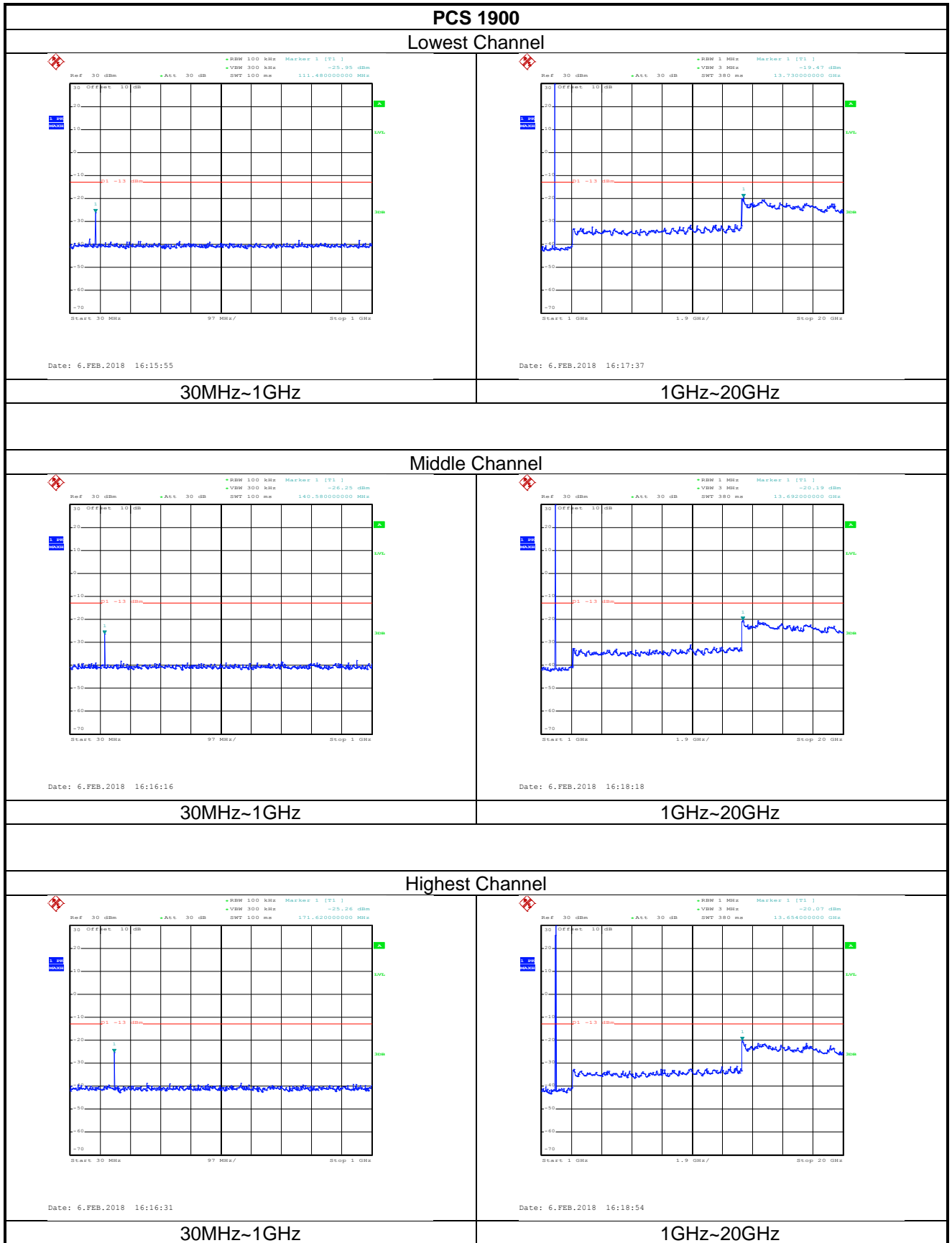

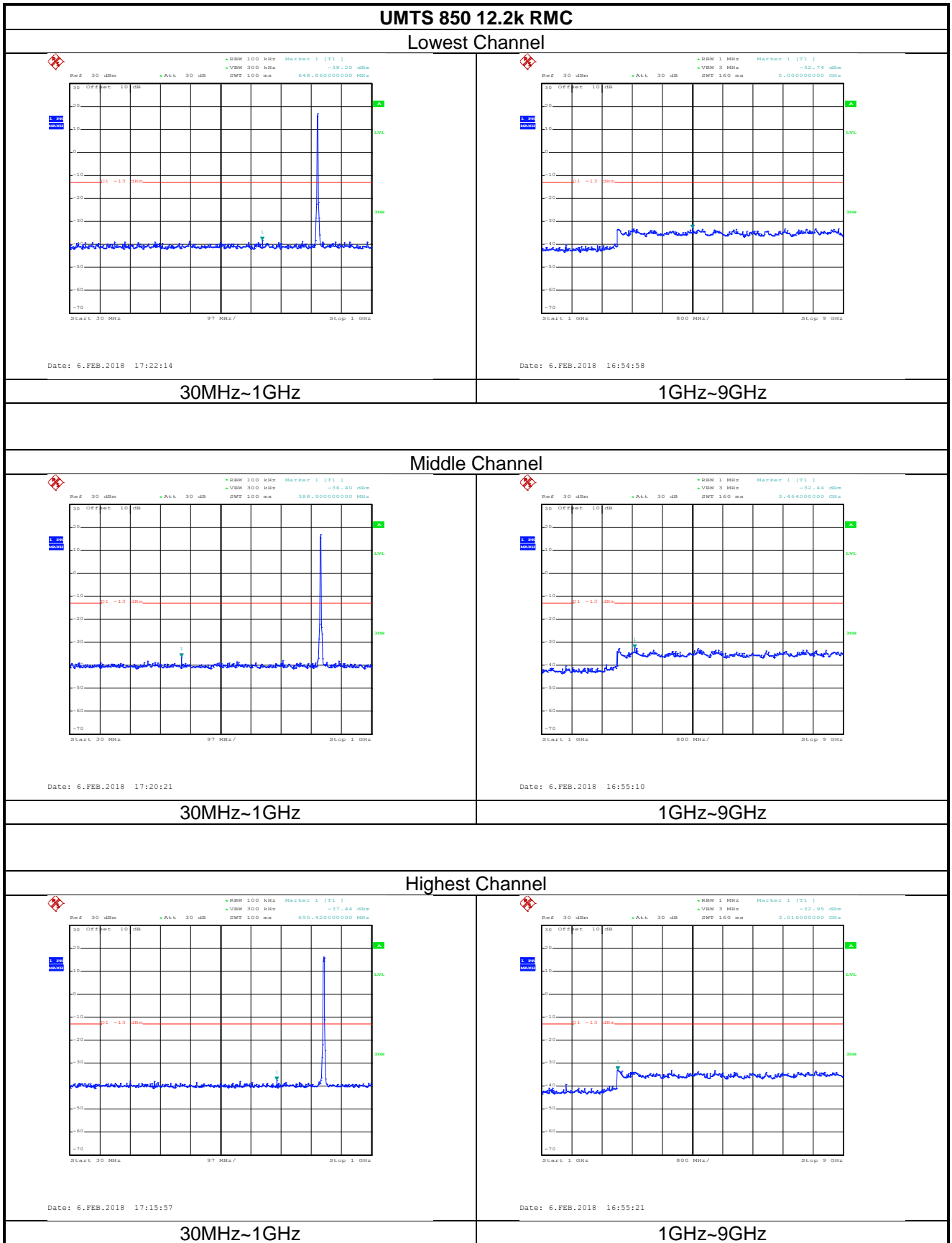

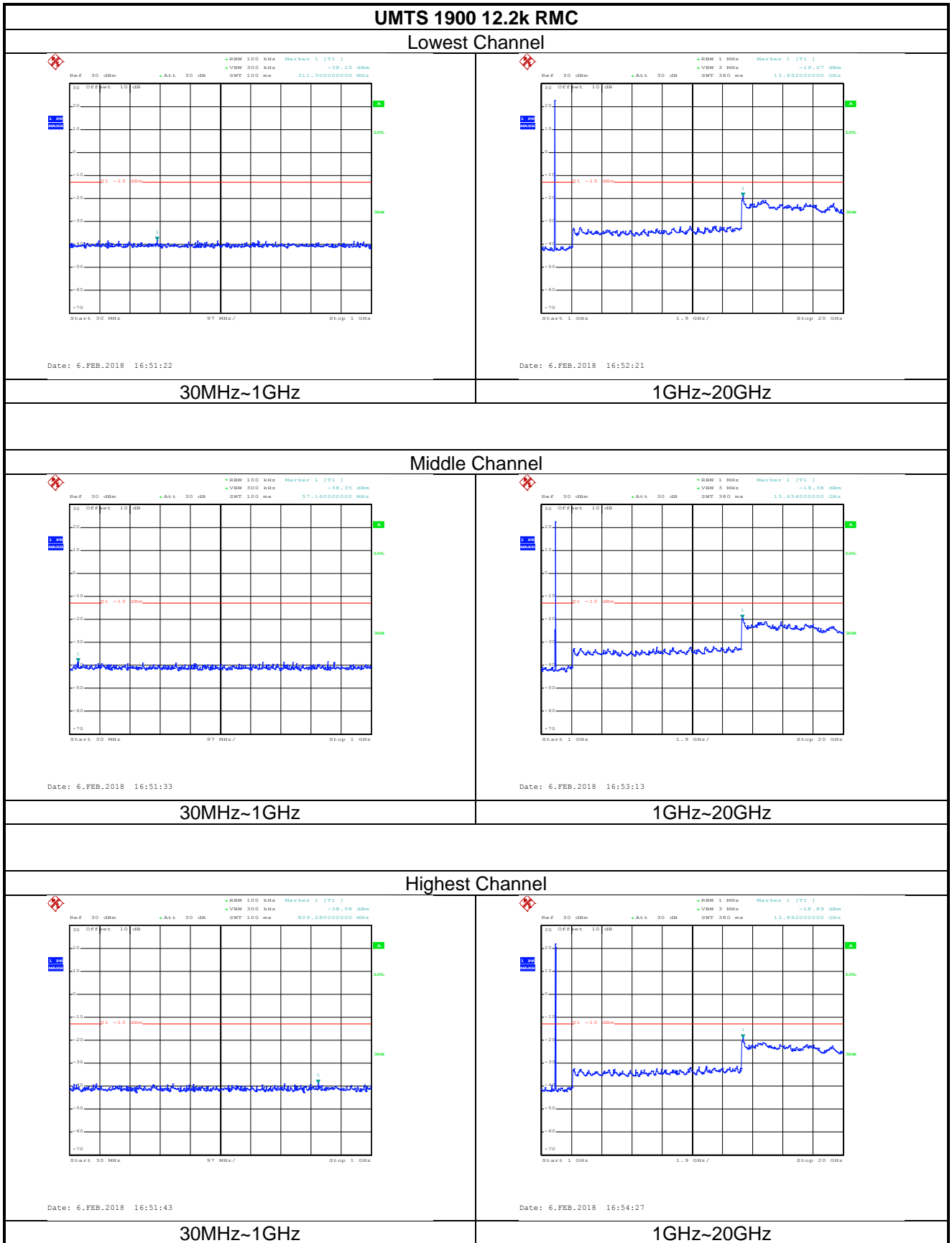

UMTS 1700 12.2k RMC

Lowest Channel

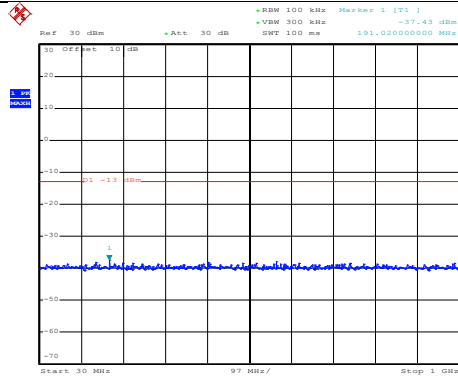

Date: 6.FEB.2018 17:39:11

30MHz~1GHz

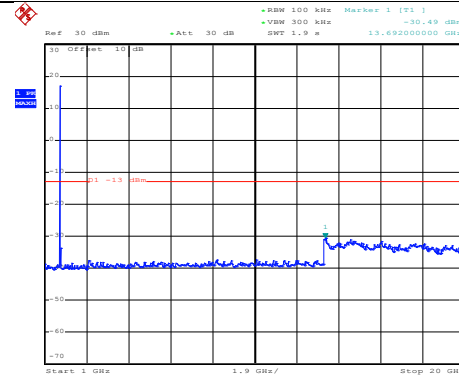

Date: 6.FEB.2018 17:41:05

1GHz~20GHz

Middle Channel

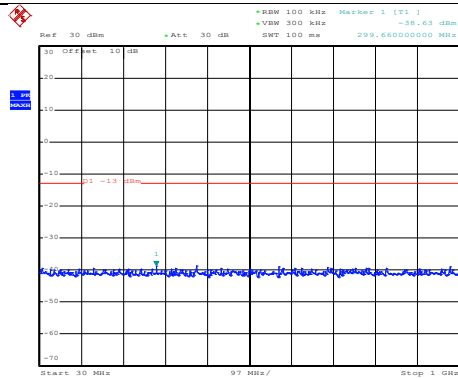

Date: 6.FEB.2018 17:39:24

30MHz~1GHz

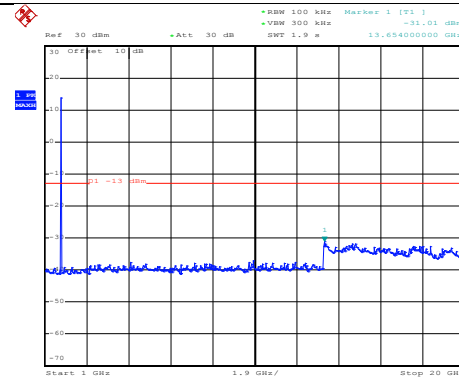

Date: 6.FEB.2018 17:41:33

1GHz~20GHz

Highest Channel

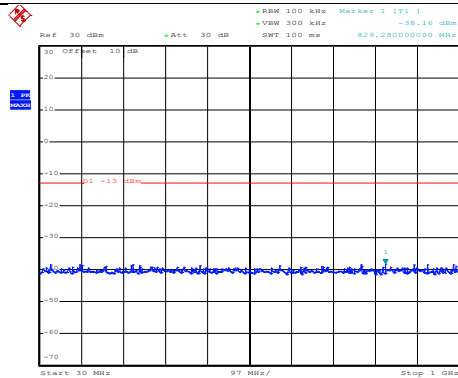

Date: 6.FEB.2018 17:39:53

30MHz~1GHz

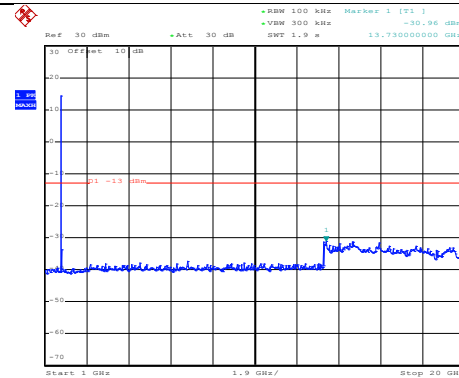

Date: 6.FEB.2018 17:41:58

1GHz~20GHz

Band edge emission:

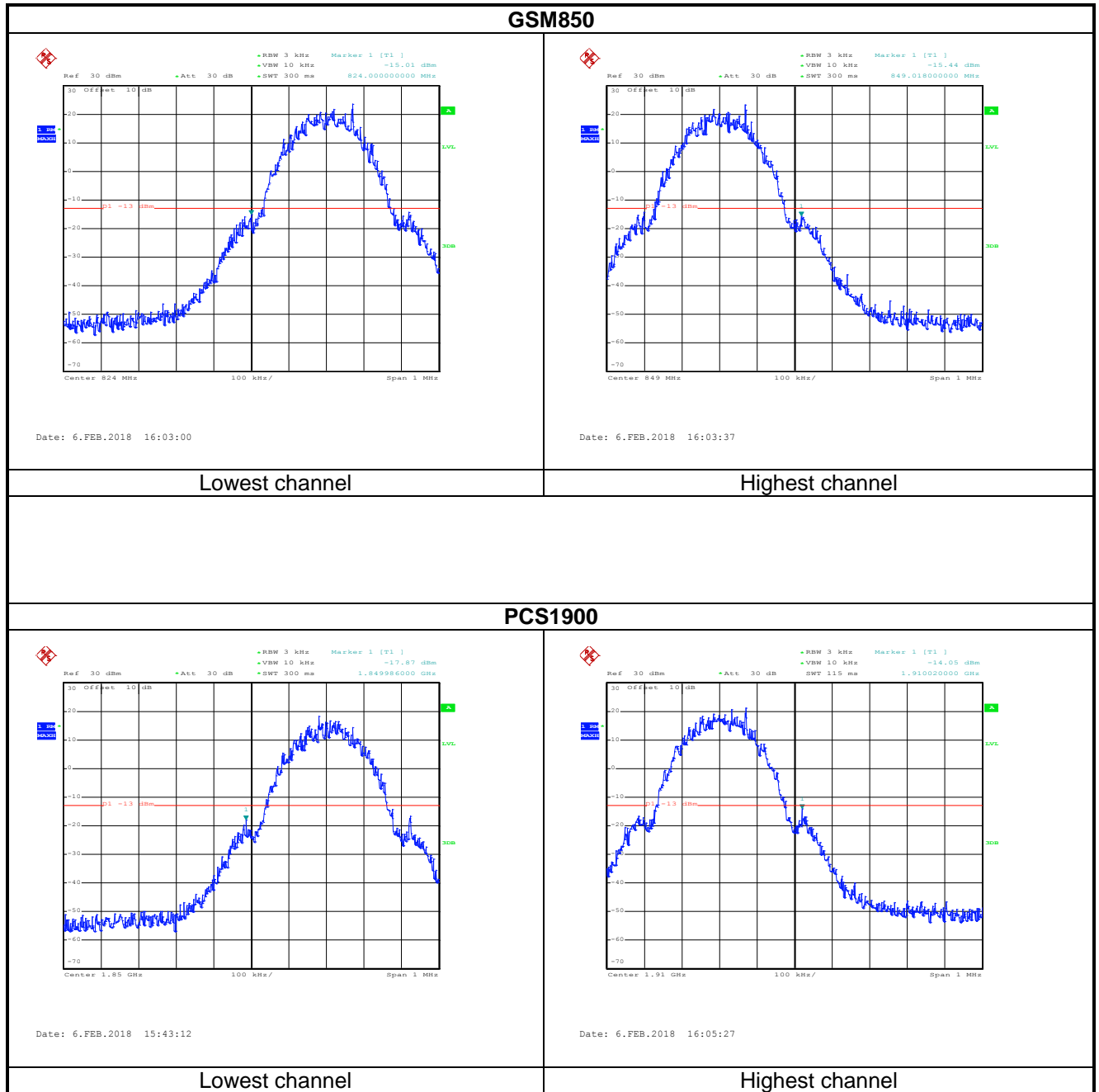

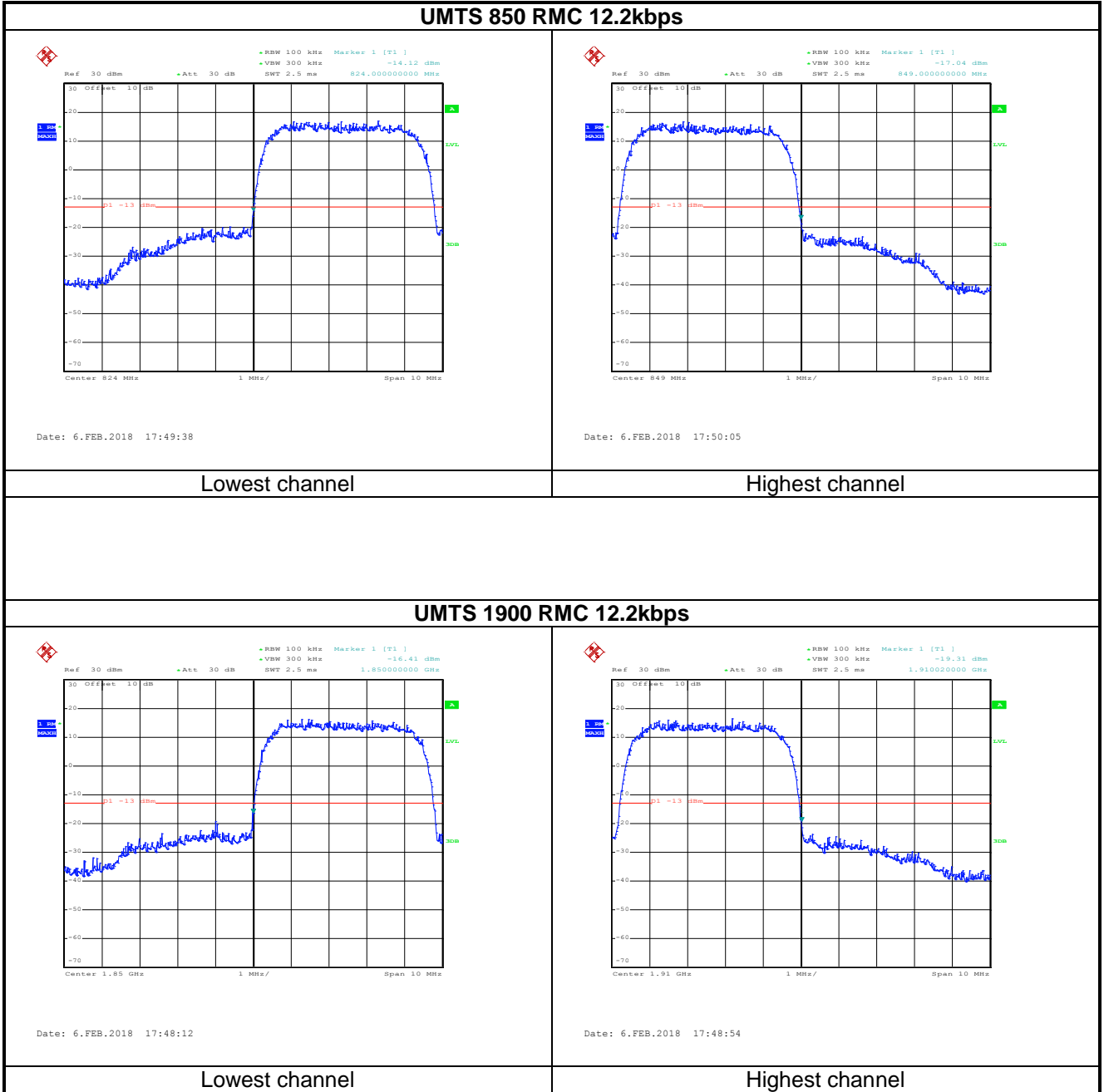

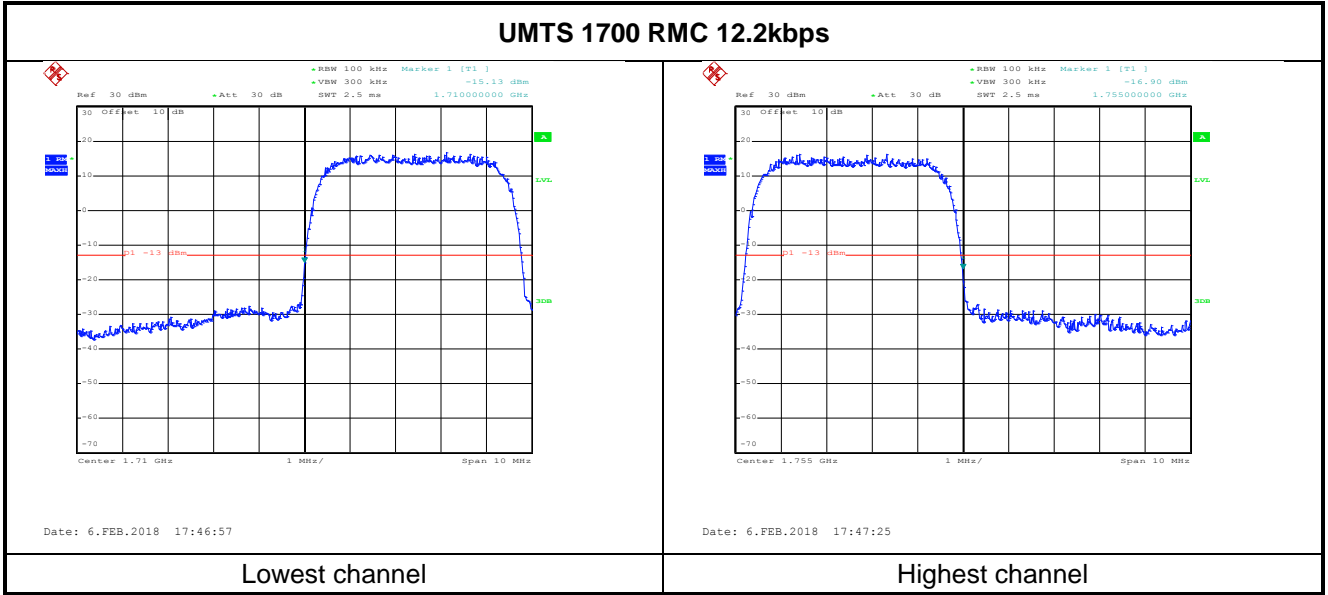

6.6 ERP, EIRP Measurement

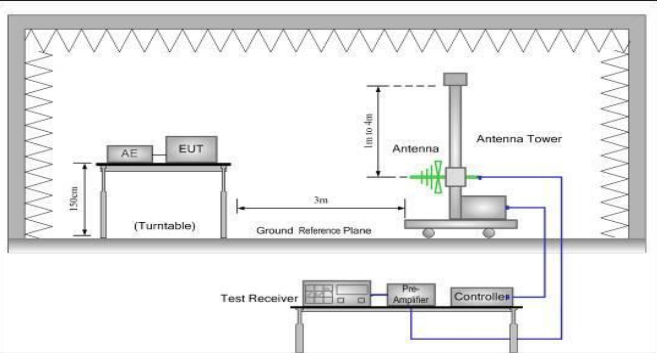
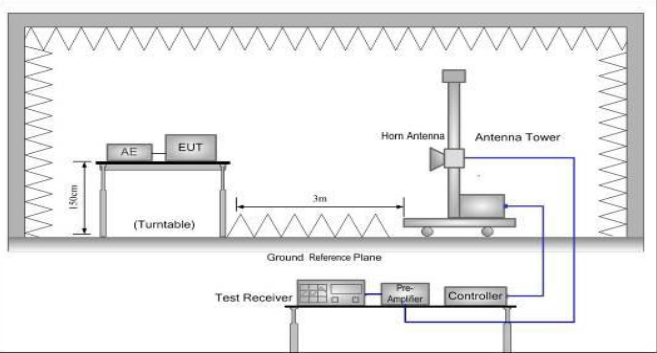
Test Requirement:	FCC part 22.913(a)(2), FCC part 24.232(c), FCC part 27.50(d)(4)
Test Method:	ANSI/TIA-603-D 2010
Limit:	GSM850 7W: ERP, PCS1900 2W: EIRP UMTS 850: 7W ERP, UMTS1900: 2W EIRP, UMTS1700: 1W EIRP
Test setup:	<p>Below 1GHz</p>  <p>Above 1GHz</p> 
Test Procedure:	<ol style="list-style-type: none"> The EUT was placed on an non-conductive turntable using a non-conductive support. The radiated emission at the fundamental frequency was measured at 3 m with a test antenna and EMI spectrum analyzer. During the measurement, the EUT was communication with the station. The highest emission was recorded with the rotation of the turntable and the lowering of the test antenna from 4m to 1m. The reading was recorded and the field strength (E in dBuV/m) was calculated. ERP in frequency band 824.2 –848.80.8MHz were measured using a substitution method. The EUT was replaced by dipole antenna connected, the S.G. output was recorded and ERP was calculated as follows: $ERP = S.G. \text{ output (dBm)} + \text{Antenna Gain (dBd)} - \text{Cable Loss (dB)}$ EIRP in frequency band 1850.2 –1909.8MHz were measured using a substitution method. The EUT was replaced by or horn antenna connected, the S.G. output was recorded and EIRP was calculated as follows: $EIRP = S.G. \text{ output (dBm)} + \text{Antenna Gain (dBi)} - \text{Cable Loss (dB)}$ The worst case was relating to the conducted output power.
Test Instruments:	Refer to section 5.8 for details
Test mode:	Refer to section 5.3 for details
Test results:	Passed

Measurement Data (worst case):

EUT mode	Channel	EUT Pol.	Antenna Pol.	ERP(dBm)	Limit (dBm)	Result
GSM850	128	H	V	27.98	38.45	Pass
			H	26.14		
UMTS 850 12.2k RMC	4183	H	V	19.11		
			H	24.73		
EUT mode	Channel	EUT Pol.	Antenna Pol.	EIRP(dBm)	Limit (dBm)	Result
PCS1900	810	H	V	26.18	33	Pass
			H	26.88		
UMTS 1900 12.2k RMC	9262	H	V	24.57		
			H	22.40		
EUT mode	Channel	EUT Pol.	Antenna Pol.	EIRP(dBm)	Limit (dBm)	Result
UMTS 1700 12.2k RMC	1513	H	V	22.31	30.00	Pass
			H	24.57		

6.7 Field strength of spurious radiation measurement

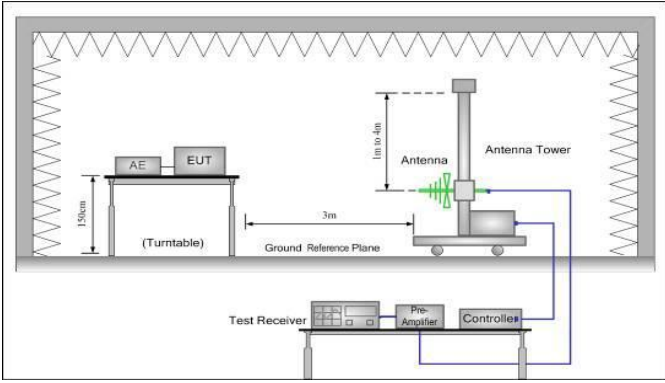
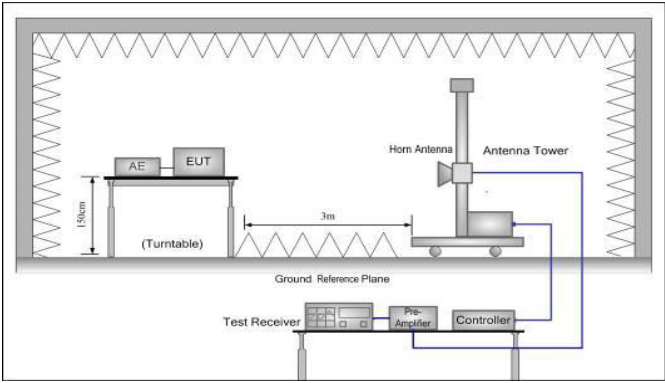
Test Requirement:	FCC part 22.917(a), FCC part 24.238(a), FCC part 27.53(h)
Test Method:	ANSI/TIA-603-D 2010
Limit:	-13dBm
Test setup:	<p>Below 1GHz</p>  <p>Above 1GHz</p> 
Test Procedure:	<ol style="list-style-type: none"> 1. The EUT was placed on an non-conductive turntable using a non-conductive support. The radiated emission at the fundamental frequency was measured at 3 m with a test antenna and EMI spectrum analyzer. 2. During the tests, the antenna height and the EUT azimuth were varied in order to identify the maximum level of emissions from the EUT. This maximization process was repeated with the EUT positioned in each of its three orthogonal orientations. 3. The frequency range up to tenth harmonic was investigated for each of three fundamental frequency (low, middle and high channels). Once spurious emission was identified, the power of the emission was determined using the substitution method. 4. The spurious emissions attenuation was calculated as the difference between radiated power at the fundamental frequency and the spurious emissions frequency. <ul style="list-style-type: none"> ERP / EIRP = S.G. output (dBm) + Antenna Gain(dB/dBi) – Cable Loss (dB)
Test Instruments:	Refer to section 5.8 for details
Test mode:	Refer to section 5.3 for details.
Test results:	Passed

Measurement Data (worst case):

GSM850				
Lowest channel				
Frequency (MHz)	Spurious Emission		Limit (dBm)	Result
	Polarization	Level (dBm)		
1648.40	Vertical	-27.49	-13.00	Pass
2472.60	V	-37.72		
3296.80	V	-36.12		
4121.00	V	-42.92		
1648.40	Horizontal	-24.04	-13.00	Pass
2472.60	H	-42.05		
3296.80	H	-39.03		
4121.00	H	-46.39		
Middle channel				
Frequency (MHz)	Spurious Emission		Limit (dBm)	Result
	Polarization	Level (dBm)		
1673.20	Vertical	-22.57	-13.00	Pass
2509.80	V	-37.38		
3346.40	V	-36.67		
4183.00	V	-43.20		
1673.20	Horizontal	-24.79	-13.00	Pass
2509.80	H	-38.58		
3346.40	H	-39.66		
4183.00	H	-43.05		
Highest channel				
Frequency (MHz)	Spurious Emission		Limit (dBm)	Result
	Polarization	Level (dBm)		
1697.60	Vertical	-22.89	-13.00	Pass
2546.40	V	-36.46		
3395.20	V	-36.17		
4244.00	V	-43.00		
1697.60	Horizontal	-25.17	-13.00	Pass
2546.40	H	-36.94		
3395.20	H	-36.51		
4244.00	H	-43.10		
<i>Remark:</i>				
1. The emission levels of below 1 GHz are very lower than the limit and not show in test report.				

PCS1900				
Lowest channel				
Frequency (MHz)	Spurious Emission		Limit (dBm)	Result
	Polarization	Level (dBm)		
3700.40	Vertical	-41.11	-13.00	Pass
5550.60	V	-38.89		
3700.40	Horizontal	-40.62	-13.00	Pass
5550.60	H	-39.83		
Middle channel				
Frequency (MHz)	Spurious Emission		Limit (dBm)	Result
	Polarization	Level (dBm)		
3760.00	Vertical	-39.27	-13.00	Pass
5640.00	V	-38.78		
3760.00	Horizontal	-40.98	-13.00	Pass
5640.00	H	-38.97		
Highest channel				
Frequency (MHz)	Spurious Emission		Limit (dBm)	Result
	Polarization	Level (dBm)		
3819.60	Vertical	-39.20	-13.00	Pass
5729.40	V	-38.65		
3819.60	Horizontal	-43.91	-13.00	Pass
5729.40	H	-38.32		
<i>Remark:</i>				
1. The emission levels of below 1 GHz are very lower than the limit and not show in test report.				

WCDMA BAND V 12.2k RMC				
Lowest channel				
Frequency (MHz)	Spurious Emission		Limit (dBm)	Result
	Polarization	Level (dBm)		
1652.80	Vertical	-44.79	-13.00	Pass
2479.20	V	-44.87		
3305.60	V	-43.97		
1652.80	Horizontal	-44.75	-13.00	Pass
2479.20	H	-54.49		
3305.60	H	-46.55		
Middle channel				
Frequency (MHz)	Spurious Emission		Limit (dBm)	Result
	Polarization	Level (dBm)		
1673.20	Vertical	-36.12	-13.00	Pass
2509.80	V	-44.76		
3346.40	V	-44.90		
1673.20	Horizontal	-38.49	-13.00	Pass
2509.80	H	-48.68		
3346.40	H	-43.46		
Highest channel				
Frequency (MHz)	Spurious Emission		Limit (dBm)	Result
	Polarization	Level (dBm)		
1693.20	Vertical	-37.62	-13.00	Pass
2539.80	V	-46.55		
3386.40	V	-46.75		
1693.20	Horizontal	-40.50	-13.00	Pass
2539.80	H	-47.67		
3386.40	H	-46.01		
<i>Remark:</i>				
1. The emission levels of below 1 GHz are very lower than the limit and not show in test report.				

WCDMA Band II 12.2k RMC				
Lowest channel				
Frequency (MHz)	Spurious Emission		Limit (dBm)	Result
	Polarization	Level (dBm)		
3704.80	Vertical	-39.19	-13.00	Pass
5557.20	V	-40.84		
3704.80	Horizontal	-46.12	-13.00	Pass
5557.20	H	-40.35		
Middle channel				
Frequency (MHz)	Spurious Emission		Limit (dBm)	Result
	Polarization	Level (dBm)		
3760.00	Vertical	-38.66	-13.00	Pass
5640.00	V	-40.59		
3760.00	Horizontal	-44.90	-13.00	Pass
5640.00	H	-39.15		
Highest channel				
Frequency (MHz)	Spurious Emission		Limit (dBm)	Result
	Polarization	Level (dBm)		
3815.20	Vertical	-39.53	-13.00	Pass
5722.80	V	-39.17		
3815.20	Horizontal	-44.33	-13.00	Pass
5722.80	H	-37.40		
<i>Remark:</i>				
1. The emission levels of below 1 GHz are very lower than the limit and not show in test report.				

WCDMA Band IV 12.2k RMC				
Lowest channel				
Frequency (MHz)	Spurious Emission		Limit (dBm)	Result
	Polarization	Level (dBm)		
3424.40	Vertical	-34.21	-13.00	Pass
5136.60	V	-40.60		
6848.80	V	-37.75		
3424.40	Horizontal	-36.10	-13.00	Pass
5136.60	H	-40.65		
6848.80	H	-38.01		
Middle channel				
Frequency (MHz)	Spurious Emission		Limit (dBm)	Result
	Polarization	Level (dBm)		
3464.80	Vertical	-37.43	-13.00	Pass
5197.20	V	-42.67		
6929.60	V	-38.30		
3464.80	Horizontal	-39.78	-13.00	Pass
5197.20	H	-42.45		
6929.60	H	-37.98		
Highest channel				
Frequency (MHz)	Spurious Emission		Limit (dBm)	Result
	Polarization	Level (dBm)		
3505.20	Vertical	-32.27	-13.00	Pass
5257.80	V	-38.55		
7010.40	V	-38.52		
3505.20	Horizontal	-37.22	-13.00	Pass
5257.80	H	-38.02		
7010.40	H	-38.15		
Remark: 1. The emission levels of below 1 GHz are very lower than the limit and not show in test report.				

6.8 Frequency stability V.S. Temperature measurement

Test Requirement:	FCC Part 22.355, Part 24.235, Part 27.54, Part 2.1055(a)(1)(b)
Test Method:	ANSI/TIA-603-D 2010
Limit:	±2.5 ppm
Test setup:	
Test procedure:	<ol style="list-style-type: none"> 1. The equipment under test was connected to an external DC power supply and input rated voltage. 2. RF output was connected to a frequency counter or spectrum analyzer via feed through attenuators. 3. The EUT was placed inside the temperature chamber. 4. Set the spectrum analyzer RBW low enough to obtain the desired frequency resolution and measure EUT 25°C operating frequency as reference frequency. 5. Turn EUT off and set the chamber temperature to -30°C. After the temperature stabilized for approximately 30 minutes recorded the frequency. 6. Repeat step measure with 10°C increased per stage until the highest temperature of +50°C reached
Test Instruments:	Refer to section 5.8 for details
Test mode:	Refer to section 5.3 for details
Test results:	Passed

Measurement Data (the worst channel):

Reference Frequency: GSM850 Middle channel=190 channel=836.6MHz					
Power supplied (Vdc)	Temperature (°C)	Frequency error		Limit (ppm)	Result
		Hz	ppm		
3.70	-30	176	0.210375	±2.5	Pass
	-20	157	0.187664		
	-10	138	0.164953		
	0	127	0.151805		
	10	116	0.138656		
	20	144	0.172125		
	30	141	0.168539		
	40	130	0.155391		
	50	119	0.142242		
Reference Frequency: PCS1900 Middle channel=661 channel=1880MHz					
Power supplied (Vdc)	Temperature (°C)	Frequency error		Limit (ppm)	Result
		Hz	ppm		
3.70	-30	178	0.094681	±2.5	Pass
	-20	155	0.082447		
	-10	141	0.075000		
	0	129	0.068617		
	10	125	0.066489		
	20	116	0.061702		
	30	107	0.056915		
	40	138	0.073404		
	50	146	0.077660		

Note: Only the worst case shown in the report.

Reference Frequency: WCDMA BAND V 12.2k RMC Middle channel=4183 channel=836.6MHz					
Power supplied (Vdc)	Temperature (°C)	Frequency error		Limit (ppm)	Result
		Hz	ppm		
3.70	-30	171	0.204399	±2.5	Pass
	-20	144	0.172125		
	-10	137	0.163758		
	0	124	0.148219		
	10	110	0.131485		
	20	162	0.193641		
	30	164	0.196032		
	40	140	0.167344		
	50	147	0.175711		
Reference Frequency: WCDMA BAND II 12.2k RMC Middle channel=9400 channel=1880MHz					
Power supplied (Vdc)	Temperature (°C)	Frequency error		Limit (ppm)	Result
		Hz	ppm		
3.70	-30	189	0.100532	±2.5	Pass
	-20	151	0.080319		
	-10	142	0.075532		
	0	165	0.087766		
	10	144	0.076596		
	20	126	0.067021		
	30	147	0.078191		
	40	135	0.071809		
	50	151	0.080319		
Reference Frequency: UMTS1700 12.2k RMC Middle channel=1413 channel=1732.6MHz					
Power supplied (Vdc)	Temperature (°C)	Frequency error		Limit (ppm)	Result
		Hz	ppm		
3.70	-30	173	0.099850	±2.5	Pass
	-20	143	0.082535		
	-10	144	0.083112		
	0	127	0.073300		
	10	109	0.062911		
	20	145	0.083689		
	30	169	0.097541		
	40	159	0.091770		
	50	130	0.075032		
<i>Note: Only the worst case shown in the report.</i>					

6.9 Frequency stability V.S. Voltage measurement

Test Requirement:	FCC Part 22.355, Part 24.235, Part 27.54, Part 2.1055(d)(2)
Test Method:	ANSI/TIA-603-D 2010
Limit:	±2.5ppm
Test setup:	<p>The diagram illustrates the test setup. On the left, there are two blue boxes labeled 'SS' (Signal Source) and 'SA' (Spectrum Analyzer). They are connected to a central grey box labeled 'Divider'. The 'Divider' is connected to a black box labeled 'EUT' (Equipment Under Test) which is located inside a larger blue-bordered box labeled 'Temperature & Humidity Chamber'. Below the chamber, there is a grey box labeled 'Power Source' with two terminals (green and red) connected to the EUT.</p>
Test procedure:	<ol style="list-style-type: none"> 1. Set chamber temperature to 25°C. Use a variable DC power source to power the EUT and set the voltage to rated voltage. 2. Set the spectrum analyzer RBW low enough to obtain the desired frequency resolution and recorded the frequency. 3. Reduce the input voltage to specify extreme voltage variation (+/- 15%) and endpoint, record the maximum frequency change.
Test Instruments:	Refer to section 5.8 for details
Test mode:	Refer to section 5.3 for details
Test results:	Passed

Measurement Data (the worst channel):

Reference Frequency: GSM850 Middle channel=190 channel=836.6MHz					
Temperature (°C)	Power supplied (Vdc)	Frequency error		Limit (ppm)	Result
		Hz	ppm		
25	4.20	87	0.103992	±2.5	Pass
	3.70	80	0.095625		
	3.50	70	0.083672		
Reference Frequency: PCS1900 Middle channel=661 channel=1880MHz					
Temperature (°C)	Power supplied (Vdc)	Frequency error		Limit (ppm)	Result
		Hz	ppm		
25	4.20	89	0.047340	±2.5	Pass
	3.70	73	0.038830		
	3.50	79	0.042021		

Note: Only the worst case shown in the report.

Reference Frequency: UMTS 850 12.2k RMC Middle channel=4183 channel=836.6MHz					
Temperature (°C)	Power supplied (Vdc)	Frequency error		Limit (ppm)	Result
		Hz	ppm		
25	4.20	86	0.102797	±2.5	Pass
	3.70	92	0.109969		
	3.50	65	0.077695		
Reference Frequency: UMTS 1900 12.2k RMC Middle channel=9400 channel=1880MHz					
Temperature (°C)	Power supplied (Vdc)	Frequency error		Limit (ppm)	Result
		Hz	ppm		
25	4.20	77	0.040957	±2.5	Pass
	3.70	80	0.042553		
	3.50	68	0.036170		
Reference Frequency: UMTS1700 12.2k RMC Middle channel=1413 channel=1732.6MHz					
Temperature (°C)	Power supplied (Vdc)	Frequency error		Limit (ppm)	Result
		Hz	ppm		
25	4.20	91	0.052522	±2.5	Pass
	3.70	85	0.049059		
	3.50	58	0.033476		

Note: Only the worst case shown in the report.